

HAVING FUN WITH TRAINS

NOVEMBER 2017 | FREE

MRH

MODEL RAILROAD HOBBYIST

Lance Mindheim on Smartphone model photography

» **READ NOW**

ALSO:

- Narrow Gauge Convention report
- Layout make-over example
- Build a locomotive cradle
- Large brick structure modeling tips
- "Adaptive compression" track plan
... and lots more inside!

EMBEDDED EDITION | LANDSCAPE



DOWNLOAD



SUBSCRIBE
(free)

• INDEX

• TABLE OF CONTENTS



AVAILABLE FOR PRE-ORDER IN NOVEMBER 2017!



PHOTO CREDIT: DAVE CASDORPH

NEW MODEL

ATLAS MASTER® N 53' REBUILT WELL CARS & CONTAINERS



ST. MARYS RAILWAY WEST



TTX



FLORIDA EAST COAST

CLICK HERE!



HUB (NORFOLK SOUTHERN)

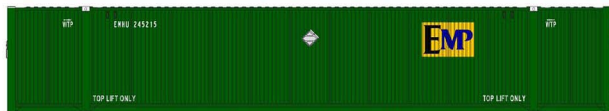

EMP (UNION PACIFIC)



UMAX (UMXU)

FOR MORE INFORMATION OR TO LOCATE A DEALER, PLEASE VISIT WWW.ATLASRR.COM.
ATLAS MODEL RAILROAD CO., INC. • 378 Florence Ave., Hillside, NJ 07205



Model Railroad Hobbyist | November 2017 | #93

STAFF CREDITS

(Updated 10/27/17)

Front cover: Lance Mindheim demonstrates how to take great low-angle model photos with a smartphone this month.



ISSN 2152-7423

Editorial Staff

Joe D. Fugate, Publisher and Editor
Don Hanley, Assistant Editor

Production

Patty Fugate, Pasteup and Layout
Joe Brugger, Copy Editing
Mike Dodd, Copy Editing

Technical Assistant

Jeff Shultz

Advertising

Les Halmos, Account Manager
Daniel Nava, Advertising Assistant
Jean-François Delisle, Marketing Assistant

News and Events

Richard Bale, News and events
Jeff Shultz, News and events

Columnists

Les Halmos, Modular railroading
Larry Smith, Narrow Gauge/Shortlines
Bruce Petrarca, DCC
Ken Patterson, Reporter at large

Rotating Columnists

Jack Burgess, Getting Real column
Nick Muff, Getting Real column
Mike Rose, Getting Real column
Tony Thompson, Getting Real column

Rob Clark, Imagineering
Dave Meek, Imagineering
Ray Dunakin, Imagineering

Issue password: Nov2017

Published for the glory of God. [What's this?](#)

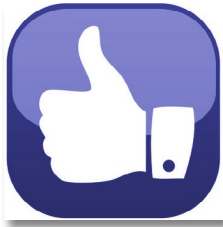

MRH SPONSORS

A - E



acculites.com



americanlimitedmodels.com



railroadhobbyshow.com



archertransfers.com



athearn.com



www.atlasrr.com



bachmanntrains.com



bachrus.com



backdropjunction.com

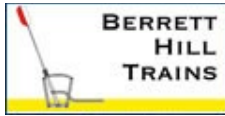

berretthill.com/trains



blairline.com



bowser-trains.com



mycaboose.com



coffmaneng.com



con-cor.com



www.digitrax.com



trackplanning.com



esu.eu/en

F - R



handlaidtrack.com



modelrailroadexpo.com



iascaled.com



kadee.com



lights4models.com



litchfieldstation.com



micro-trains.com



store.mrhmag.com



modeltechstudios.com



mtalbert.com



ncedcc.com



www.pwrs.ca/main.php



rapidotrains.com



ringengineering.com

[Vendors: Get your clickable logo here ...](#)

[Vendors: Get your clickable logo here ...](#)

MRH SPONSORS | 3

S - Z



sanjuancarco.com



scaletrains.com



soundtraxx.com



sodigi.com



sbs4dcc.com



tamvalleydepot.com



tcsdcc.com



trainfest.com



tonystrains.com



traintekllc.com



tsgmultimedia.com



walthers.com

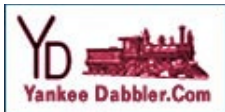

yankeedabblers.com

[Vendors: Get your clickable logo here ...](#)

Looking for something? Check the MRH Marketplace!

Take me there!

BACK FROM THE DEAD
 CLICK HERE TO ORDER
 DEADLINE: NOVEMBER 20TH





TABLE OF CONTENTS

FEATURES

Low angle smartphone photography

LANCE MINDHEIM

Realistic railfan view photos with your phone



St. Thomas on the Canada Southern

RON PARE

Tips and tricks for larger brick structure projects



18" gauge timber cars

DICK WITNEY

Modeling backwoods mining cars with simple techniques



The Southern North Shore Railroad

ROBERT M. PETRICK

Using "adaptive compression" to get more



ScaleTrains.com SD40-2

JEFF SHULTZ

Comparing the "Rivet Counter" and "Operators" models



ALSO: MRH Marketplace | Subscriber extras

TABLE OF CONTENTS | 2

COLUMNS

MRH Q-A-T: Wheel dots, consolidated stencils, ACI labels, ...

compiled by JOE BRUGGER

DCC Impulses: Novice view of the Narrow Gauge Convention

BRUCE PETRARCA

Getting Real: Modeling Skinner's Eddy

MIKE ROSE

What's Neat: Building a loco cradle, ...

KEN PATTERSON

Photo feature: Yes, it's a model

compiled by DON HANLEY

Deraillments: Bizarre facts & humor

compiled by the MRH STAFF

NEWS and EDITORIAL

Publisher's Musings: What about the 3 weeks between issues?

JOE FUGATE

News & Events: November 2017

RICHARD BALE & JEFF SHULTZ

Reverse Running: Is scenery overrated?

DON HANLEY

AVAILABLE IN NOVEMBER

H0 Gunderson 5188cf Covered Hopper

AOK



CMO



(ACTUAL MODEL SHOWN)



Preorder Now



© 2017 ScaleTrains.com, Inc. ScaleTrains.com, Operator, Rivet Counter, and respective logos are trademarks of ScaleTrains.com, Inc. ScaleTrains.com, Inc. 7598 Highway 411 Benton, TN 37307 844-9TRAINS 844-987-2467 International 423-299-3689



Scene and photography by Ken J Johnson First test model shown



Model Railroad Hobbyist | November 2017 | #93

PUBLISHER'S MUSINGS

editorial

JOE FUGATE



Click here to rate or comment on this article

WHAT ABOUT THE THREE WEEKS BETWEEN MRH ISSUES?

DO YOU GET EXCITED WHEN A NEW ISSUE OF MRH is released, only to find a week later you've worked your way through the issue and now you're hungry for more?

Well, there is more, and like MRH, it's free!

If you subscribe to MRH, we send you an email every week with tips and links to other interesting things, including some of the best posts on the MRH website.

Every time I give a clinic somewhere and ask the audience what they think of MRH magazine, I get a few raising their hand and thanking me for the weekly emails. They often say they get some of the best tips from those emails!

But you need to be a subscriber to get those weekly emails. You can subscribe here: mrhmag.com/user/register. It's free.

PUBLISHER'S MUSINGS | 2

Getting more out of the MRH forums

If you subscribe, you can also get more out of the MRH forums and blogs. (See the sidebar: [What's a blog?](#))

For example, if you have a question, you can start a forum thread with that question and within a few hours, you will start getting answers. We do have a staff joke, however: "the MRH forums are great – within a few hours you will get an answer – and within a day or two you will get the right answer!" But I digress ...

Seriously, as long as you are willing to filter the answers a little with some common sense, many seasoned modelers will chip in and give insightful answers to any question you may post.

Let me relay one recent example. A question was posted asking what people use to clean their turnout points. (See the thread: mrhmag.com/node/31348).

MAKING RAILROAD HISTORY
WALTHERSPROTO
EMD GP35 Phase II HO SCALE

SoundTraxx® Tsunami® Sound & DCC \$299.98 ea (unless noted) • Standard DC \$199.98 ea (unless noted)



SECOND SERIES - AVAILABLE NOW

- New second series roadnames
- Limited Edition - one time run of these engine numbers
- Based on Phase II units in service from 1965 to present
- Road-specific details - see more at waltthers.com
- Available with SoundTraxx Tsunami Sound for DCC & DC layouts
- Correct frame, inertial filter hatch & other Phase II details

ADVERTISEMENT

<p>Santa Fe[†]</p> 	<p>Gulf, Mobile & Ohio</p> 
<p>Chessie System**</p> 	<p>Rock Island</p> 
<p>Conrail</p> 	<p>Southern Pacific[†] GRIP Rebuild</p> 

CLICK HERE TO LEARN MORE!

WALTHERS Support your local hobby shop • visit waltthers.com • call 1-800-4-TRAINS

©2017 Wm. K. Walther, Inc. Delivery dates, prices and specifications were accurate at press time, for updates visit waltthers.com. Photos show early preproduction models, colors and details may vary. [†]The ATSF and BN marks are licensed marks owned by BNSF Railway Company. ^{**}CSX proprietary marks used by permission of CSX Transportation Inc. [†]Union Pacific licensed product.

ADVERTISEMENT

Kadee
 June Pre-Order



#4531 MNS 1157..... \$39.95

2018 Kadee® Patriotic Car



#6923 KDC 023 \$42.95

Kadee HO SCALE

For More Pre-Order Cars Click Here

ADVERTISEMENT

WAY TO GO, TRAINTEK!
 Already great prices and NOW ...

FREE SHIPPING ON ORDERS OF \$79 or more*



Start saving now

*some exclusions apply

Because HO is *not* the only scale...



Order your track building tools and supplies from Zn3 to O scale online at:
www.handlaidtrack.com



PUBLISHER'S MUSINGS | 3

One comment that piqued my interest was this one:

"White spirits + thin cloth wrapped onto a small balsa block works well to clean the rails. Other solvents such as isopropyl alcohol also work, but non-polar hydrocarbon-based solvents are more effective (advice from a chemist :-)"

Ah hah! I had heard from the La Mesa club folks that they have stopped using ISO alcohol to clean track because the track gets dirty faster. Apparently, the "polar" solvents leave a residue that encourages micro-arcing, which is what creates "black gunk," the metal oxides that build up on the track and wheels.

It appears non-polar solvents, on the other hand, inhibit micro-arcing. I find it interesting that Wahl's Clipper Oil, which started a discussion a few decades ago as a way to inhibit black gunk buildup, refers to a non-polar substance.



©Matt Gentry Photo

THE NEXT STEP IN THE EVOLUTION NEW MODEL ES44DC ARRIVING FOR WINTER 2017

The ES44DC and ES44AC, commonly called GEVOs for General Electric Evolution series, were designed to meet the strict diesel locomotive emissions standards imposed by the EPA Tier II regulations. The ES44DC and ES44AC external details have changed with almost every year's new orders. These models are of the early version produced in 2005 and 2006. Athearn® brings the ES44DC to life in Genesis®, "As close to real as it gets" with Tsunami2 sound by SoundTraxx.

- Era: 2005 to present day
- New and Updated tooling
- Separately installed wire handrails and wire grab irons
- Fully assembled
- Etched metal fan grille
- Razor-sharp printing and painting
- McHenry® scale knuckle spring couplers
- Machined metal wheels
- Minimum radius: 18" recommended: 22"



DC style dynamic brake grilles spaced apart.

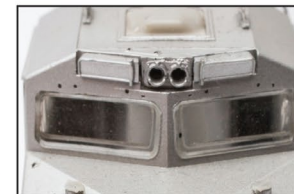

High headlight variant with optional PTC antenna array or antenna dome.



Separately-applied plumbing and traction motor cables.

VISIT ATHEARN.COM FOR COMPLETE LISTING
 OF ROADNAMES AND PRICING

HORIZON
H O B B Y

VISIT
Your Local Retailer

CLICK
Athearn.com

CALL
1.800.338.4639

SERIOUS FUN™

©2016 Horizon Hobby, LLC. Athearn, Genesis and McHenry are registered trademarks of Horizon Hobby, LLC. All other trademarks, service marks and logos are property of their respective owners. Final models may vary slightly from photos shown. 54364

N SCALE SW1500 LOCOMOTIVE SINGLES

COMING OCTOBER 2017



Available in 3 RD#s: 2621, 2632, 2658

**MORE SCHEMES
TO FOLLOW...**

**MICRO-
TRAINS®
LINE** **micro-trains.com**
SHOP NOW!

ADVERTISEMENT

CABOOSE™

Sharing Our Passion for Trains Since 1938

**Click Here for the
Serious Modeler's
Resource!**

More than 170,000 items,
over 490 manufacturers,
most at a discount from
full retail – all at a fair price.
**As always, in-stock orders of
\$100.00 or more ship free
within the Continental U.S.!***
*surcharges may apply for oversized items.

10800 West Alameda Ave.
Lakewood, CO 80226
(303) 777-6766

MRHMAG.COM



PUBLISHER'S MUSINGS | 4

Mineral spirits is similar to clipper oil and is non-polar. Mineral spirits make a great track and wheel cleaner.

For a list of common solvents and which are polar vs. non-polar, see this post on the thread: [\[mrhmag.com/node/31348?page=3#comment-305058\]](http://mrhmag.com/node/31348?page=3#comment-305058)

Wow, you learn something every day! I knew anecdotally that some substances worked better than others for track cleaning – now I have a true scientific explanation as to why! And I got it from a discussion on the MRH forum.

The point is, check out the MRH forum if you're looking for more model railroading insights between magazine releases.

New WHAT'S NEAT THIS WEEK video podcast

Ken Patterson and Chris Palomarez (Athearn's brand manager) are now doing a weekly video podcast on YouTube on the three weeks around the release of Ken's



HO
SCALE

DCC
SOUND VALUE
ON BOARD

SANTA FE #1218
Item No. 67604 **NEW**

THE GP30 "HUMP" TAKES A JUMP INTO DCC SOUND!

There's no missing a GP30's characteristic "hump," which was developed at the GM Automotive Styling Center. As well as creating a more modern appearance, the design was a practical way to house air intakes for the central air system and dynamic brakes. Bachmann carries on the prototype's innovative history by offering a new DCC sound-equipped model. Our exclusive Sound Value SoundTraxx® diesel sound package includes prototypical prime mover, 3 air horns, and bell—all in polyphonic 16-bit sound. This model also features all-wheel drive, operating headlight, and E-Z Mate® Mark II couplers. Jump into DCC sound with the new GP30 today!



B&O® #6944 • Item No. 67601



PRR #2200 • Item No. 67602

Click to
learn more



SOUTHERN PACIFIC #5016
(Bloody Nose) • Item No. 67603



UNION PACIFIC® #839 • Item No. 67605

SHIPPING SOON! MSRP \$239.00 each



Bachmann Industries, Inc. • 1400 East Erie Avenue • Philadelphia, PA 19124 USA • www.bachmanntrains.com

Click for more information.

• INDEX

• TABLE OF CONTENTS

PUBLISHER'S MUSINGS | 5

monthly "What's Neat" column in *Model Railroad Hobbyist* magazine.

So if you're looking for a weekly fix in the other three weeks, check out the new weekly ***What's Neat this Week*** video podcast.

This video podcast runs between 20 and 30 minutes each week and covers a wide variety of topics. They talk about different modeling tips and tricks, they answer viewer questions and they have guests who talk about what modeling projects they're working on.

One of the regular guests is a teenager who is actively building a layout. He's one sharp kid and passionate about the hobby – who says the hobby is dying?

Ken and company also mention interesting new product releases or products they've heard will be coming soon.

You should check out this weekly video podcast at [\[mrhmag.com/vidcast/whats-neat-this-week\]](http://mrhmag.com/vidcast/whats-neat-this-week)

What's a blog?

Blog is short for **weblog** – a personal journal someone posts publicly on the web.

The MRH Internet website has both discussion forums and blogs. Blogs and forums look virtually the same on the MRH website, but they're quite different in concept and we do moderate them a bit differently.

A forum thread is a public round table discussion and nobody "owns" the thread. A blog, on the other hand, is a "special presentation" with someone who has the floor – the blog owner. If a blog thread goes some direction the blog owner doesn't like, we will step in and help the blog owner align it back with their wishes.

So check out the blogs on the MRH website here at this link [\[mrhmag.com/blog\]](http://mrhmag.com/blog).

If you are doing some interesting stuff in the hobby, consider *starting* a blog on the MRH website! ■

NORTH AMERICAN RAILCAR CORPORATION МОЛНІ АМЕРИКАН РАЙЛКАР КОРПОРАШН



National Steel Car 5092 cf Combo Door Box Car 1971 - present



BCOL - light green, built 1972

12 Rd #s for each paint scheme



PGE - light green, built 1971



Accuracy and
Detail... in Scale



PGE - dark green, light green door, built 1971



BCIT - dark green, built 1972



BCOL - with underline, re-paint 1987



BCOL - large italic lettering, re-paint 1986



BCOL - 80,000 series, re-built w/team door 1990s



BCOL - brown, CN noodle & url, vents, shopped 2003



BCOL - 100,000 series, re-built 1990s w/vents, w/team door

CLICK HERE FOR
HO - 5092 Boxcar

**COMING
SOON!!**

CLICK HERE FOR
N - 5092 Boxcar

NARC Cars are sold
exclusively through

Pacific Western Rail Systems

FINAL KIT!



FINE SCALE MINIATURES

FSM is closing its doors after 50 years of business!



I.M. Dunn Co. \$280 + S&H



Destined to become an instant collector's item

BUY NOW >>

Brought to you by the MRH Store: store.mrhmag.com

PUBLISHER'S MUSINGS | 6

– Ken does a great job producing it, and you will find it's more interesting to watch than your typical "talking heads webcam" video podcasts. And of course, it's free!



[Click here to rate or comment on this article](#)

ADVERTISEMENT

"HO" & "N" Scale Con-Cor 2017 Christmas Cars - Pre-Order Now!



"HO" mP-54's Now In-stock See more on our website!



Pennsylvania" with "PRR Futura" Lettering



Long Island "Tichy" Grey-White Paint Scheme

D&RGW "OY" SNOW PLOW - Due 2018 with sound!



Museum Quality Models Available in Both "HO" and "HO_{N3}" Scale
(Many other railroads had similar plow's We will be offering other roadnames also.)

Reserve yours now
Final price will depend on
Number of advanced reservations



Special Closeout on lots of items at Con-Cor.com including Some "N" Rivarossi Parts!

and RT 66 Semi Trucks

Click Here for Con-Cor Website www.con-cor.com



MRH "TOMA WITH A TWIST" CONTEST

ENTRY DEADLINE: January 31, 2018

Goal: Design the "starting position" for a sectional home layout design using TOMA.*

GRAND PRIZE: \$1000, plus get published as an MRH cover story

First Prize: \$750; Second Prize: \$500; Third Prize: \$350;
First, Second, and Third prize also get published.

Honorable mentions: \$100 each, publishing at editors' discretion.

Hypothetical room is 14' x 20'. Space under the stairs not available, and a 4' clearance must be maintained along the utility wall.

Note: This is a sectional home layout design, no modular standard required.

Room 14' x 20'

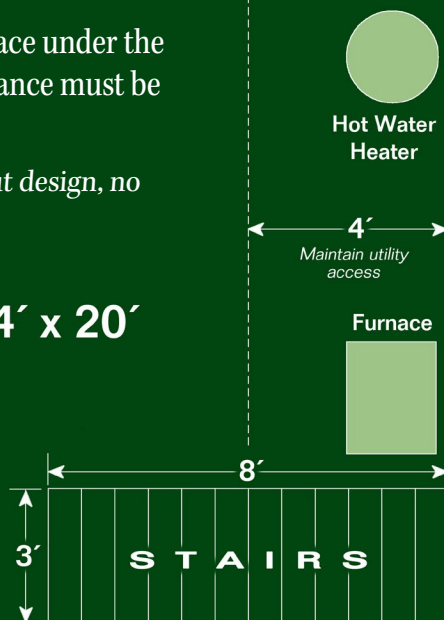

*For reference, see the July 2017 MRH Editorial, "TOMA with a twist".

CONTEST RULES

- Modules can be any size or shape but must fit up the stairs and through the door at the top of the stairs (80" tall and 30" wide) without damage or pinching your fingers.
- Scale: From Z to O, using any track gauge.
- Design the "starting position" for layout construction phase 1 – we want to see one or two TOMA module sections that can be completely finished and configured for an operating session. Show and tell how staging would work. Tell a brief backstory of the line and how it operates.
- Your TOMA modules need to have some form of temporary staging, either singled-ended staging off one/both ends, or double ended staging connected to both ends of the modules, which would also allow continuous running if desired.
- Don't waste your time drawing and describing a detailed room-filling layout. Rough in outlines of the other modules, that is, the "ending position." Just sketch simple boxes and lines to show how the modules will fit in the room. Bonus points awarded for explaining – in words, sketches or both – a phased module construction progress plan.
- Modules can follow a standard or not. Custom sections okay.
- Module support method / height up to you, but please describe.
- Innovative or creative approaches get extra points: please describe and illustrate if possible.
- Include a cost estimate for the starting position. There is no need to actually build anything, this is a design contest only.
- This contest is *all about getting started*. People who can get that far will be able to fill in the rest with their own imagination.
- All submissions must be publishable. If the submission is not formatted to be ready for publication, it will be disqualified. Take the time to be complete, provide captions, and to describe things completely in your text. See the [MRH submission guidelines for more information](#).

SUBMIT ENTRY (Choose "Contest Entry")

★ LAST ISSUE'S RATINGS

The five top-rated articles in the [October 2017 issue](#) of *Model Railroad Hobbyist* are:

- 4.8 DCC Impulses: RailPro makes things easy
- 4.8 Upgrading an Athearn 57' reefer
- 4.7 Allagash roster photo album
- 4.7 Reverse Running: Are we making the hobby too complicated?
- 4.7 Minimalist weathering, part 2

Issue overall: 4.8

Please rate the articles! Click the reader comments button on each article and select the star rating you think each article deserves. Thanks! ■

*TrainMasters TV is part of
the MRH product family.*

*TMTV members not only get great network TV level
videos, they help pay for MRH and keep it free ...*



**Litchfield Station
Carries A Full Line Of
Digitrax Products**



**-CLICK HERE to visit our website-
www.LitchfieldStation.com
623-298-7355**



\$4.15 (weekly)
Caffe Mocha Grande

30 minutes of sipping pleasure per week

\$0.91* (weekly)

TrainMasters TV membership

Investment in a lifetime of hobby insight



**Holiday special pricing of \$49.99 for a 1 year membership (52 weeks + 3 free bonus weeks)*



Check it out!

Holiday special pricing in effect

www.trainmasters.tv



MRH Q-A-T

column

compiled by
JOE BRUGGER



[Click here to rate or comment on this article](#)

? QUESTIONS AND ANSWERS

Wheel dots, consolidated stencils, and ACI labels

Q. I'm trying to do a better job of modeling freight cars in the late 1970s era and am getting confused trying to get COTS stencils, ACI labels, and wheel dots in the right places. Can you help?

—Robby S.

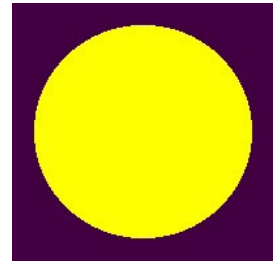

A. COTS panels appeared as small black boxes on the side of freight cars in 1966. The idea was to pull maintenance data into a single place. COTS is an acronym for “Clean, Oil, Test, Stencil.”

From 1972 to 1974, they appeared as a black box with a white border.

From 1974 to 1982, there were two bordered boxes, either stacked or side by side.

1. Wheel dots were part of the U-1 inspection and replacement program that began in March 1978.

► **MRH QUESTIONS, ANSWERS, AND TIPS**

MRH Q-A-T | 2

In 1982, a three-box design became standard and is still in use today. In all cases, the stencils go on the lower right-hand side of the car.

Wheel dots were in use from March 31, 1978 as part of the intensive U-1 inspection campaign to identify and replace a series of 33” wheels, manufactured by the Southern Wheel Company, suspected of failing in service and causing several serious derailments.

The dots (a 6” dot on a 12” black square) are placed on the lower right-hand area of the car side. A white dot indicates a wheelset in need of replacement and banned from trains carrying hazardous materials. A yellow dot indicates a safe wheelset.

Beginning December 31, 1978, the white-dot wheels had to be removed and replaced with wheels of an approved type. New cars built in 1978 between the end of March and the end of December

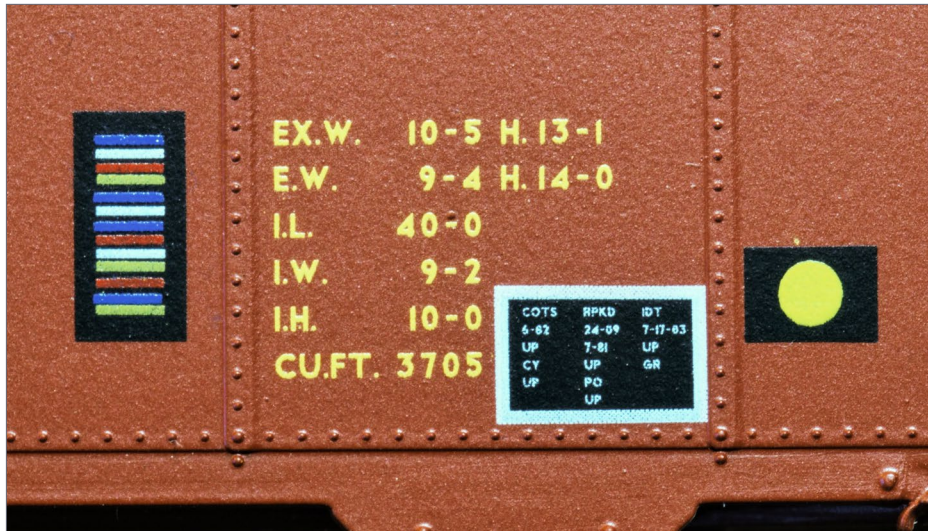

2. All three elements line up on a Union Pacific B-50-24 boxcar used in maintenance of way service as a tool/material car in the early 1980s. *32nd Ave. Shops photo*

MRH Q-A-T | 3

had yellow dots applied at the factory. There was no date given for removal of these markings so they remained on cars for several years.

ACI labels were in active use from 1967 to 1977. They are part of a car identification system developed by General Telephone and Electronics, using color bar codes that could be deciphered by a reader placed along the tracks. By 1975 90% of all railcars were labeled.

Even in the early years of the program there were problems reading the panels after dirt and grime accumulated in service. After several years, a test made under ideal conditions still showed a 10% mis-read rate, and the industry pulled the plug on the program.

Those are the simple answers. Here are some modeler-friendly details:

ACI labels were positioned high enough to be visible to track-side scanners and were placed so they could not be obscured by an open door. The preferred location was above the inner axle of

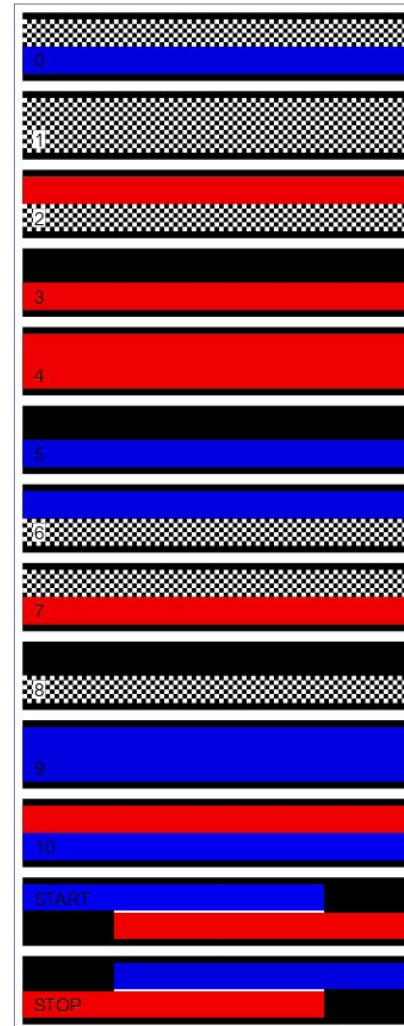

3. KarTrak ACI labels were part of an ultimately unsuccessful 1960s program to track freight cars automatically.

MRH Q-A-T | 4

the right-hand truck approximately seven feet above the rail. The highest permitted location was 9'-6" above the rail and the lowest permitted location was 1'-4" above the rail. The allowed placement runs from just at the back of the outer axle of the right-hand truck to 5' from the inner axle of the left-hand truck. All other areas of the car are "forbidden." (This dimension was originally 4'-8" from the left truck. Sometime between 1968 and 1972 the minimum distance from the left truck changed).

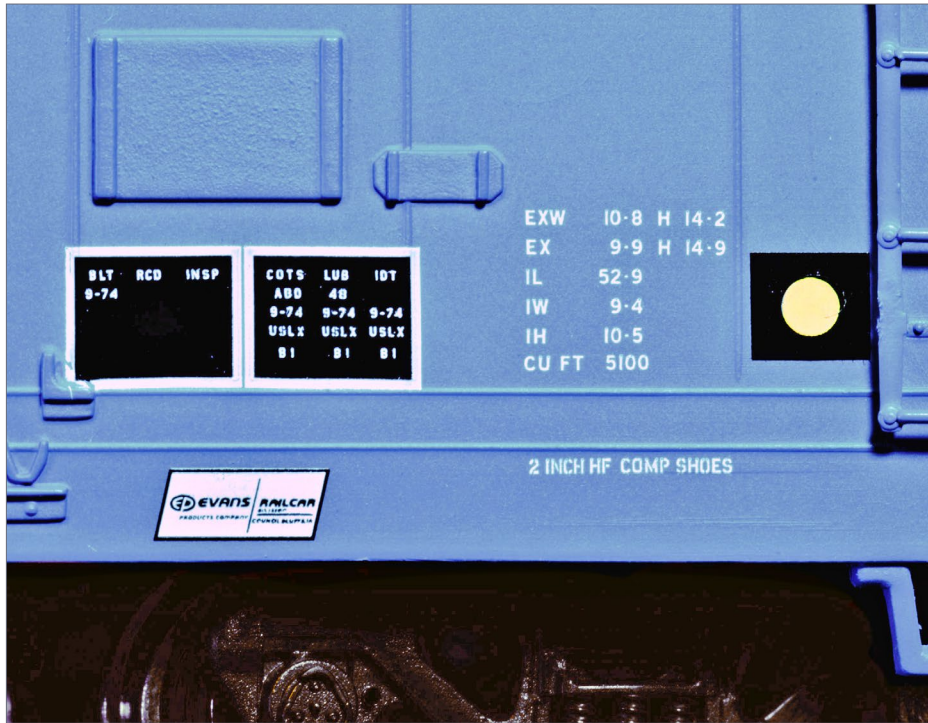

4. A USLX boxcar built by Evans in September 1974 shows the wheel dot and updated COTS format, but not an ACI plate. 'ABD' is the brake type, 'LUB' or 'RPKD' the most recent bearing service date. 'IDT' is for in-date testing and shows the location and company performing the test. 32nd Ave. Shops photo

ADVERTISEMENT



Archer

FINE TRANSFERS
PROUDLY SERVING MODEL BUILDERS SINCE 1989

THE ORIGINAL
SURFACE DETAILS™

WE NOW HAVE MORE THAN 130 SHEETS OF RIVETS, LOUVERS, TREADPLATE, WELD SEAMS AND MORE CAST ONTO MICROSCALE CLEAR DECAL FILM

LOW SHIPPING:
DOMESTIC USA ORDERS **\$2.80**
INTERNATIONAL ORDERS **\$9.95**

CLICK HERE TO VISIT OUR WEBSITE!

Archer Fine Transfers • PO Box 1277 • Youngsville, NC 27596 • USA (919) 570-1026 • info@archertransfers.com • archertransfers.com

Joe Fugate, Publisher/Editor Model Railroad Hobbyist

MADE IN THE USA

ADVERTISEMENT

SANTA FE TK-N & TK-O
LATE 2018



PREPRODUCTION ARTWORK

American Limited

6 numbers per version! Please contact your dealer!
www.americanlimitedmodels.com

ADVERTISEMENT

www.SBS4DCC.com





SOUNDTRAXX



DCC Specialties
INNOVATION FOR DCC

ACCUTRACK II SPEEDOMETER

TAM VALLEY DEPOT
Great Electronics for Great Model Railroads

MRC
Model Rectifier Corporation

SPROG DCC
the DCC Programmer and Control Family

TEAM DIGITAL, LLC
Improving the world of DCC

Digital plus
by Lenz

N - HO - HO_{N3} Scale Trains

ADVERTISEMENT

Checked us out lately?

- ✓ HO/N and now O scale products too!
- ✓ Laser-cut Structures & Bridges.
- ✓ Advertising & Storefront Signs.
- ✓ Highway Signs, vintage & modern.
- ✓ New Detail Items.
- ✓ Laser-cut Grade Crossings.
- ✓ Billboards, roadside & rooftop.
- ✓ Laser-cut Graffiti Decals
- ✓ 1000's of satisfied customers.

WHAT'S NEW?



Established 1993...

Blair Line

MRH Q-A-T | 5

Unless specific dates are given, these three programs were phased in. It took several years to get the ACI labels on all cars in interchange service, and labels could be seen on cars for many years after the ACI program ended.

There was considerable overlap of the different styles of COTS. For example, even after the two- and three-box versions were introduced, shops would continue to stencil updated information into the existing boxes rather than replacing them. Learn more at hosam.com/mod/rsdet.html#cots.

It was not unheard of to see yellow dots on cars with 36" wheels, and the dots persisted on cars long after the suspect wheelsets had been rounded up and replaced. On the other hand, you will probably not see a wheel dot on a car built in 1980 or later. You will probably not see an ACI label on a car built in 1978 or later.

1930s sawmill production

Q. Before WWII, my father worked as a timber cruiser in a lumber operation where South Carolina, North Carolina, and Georgia come together. He said they shipped a million board feet of lumber by rail, presumably from a mill in West Union, SC. A million feet a year? A million feet a month? Dad isn't around to ask. Assuming 36- and 40-foot boxcars, flats and gondolas, how many pre-war cars would it take to ship a million board feet of lumber?

—Marshall Keys

A. Dave Husman: A board foot is a board one inch thick and one foot square.

- 12 board feet = 1 cubic foot
- 1,000,000 bd. ft. = 83,333 cu. ft.
- A 40-foot boxcar is nominally 3500 cu. ft.

Combo Right Clamp™

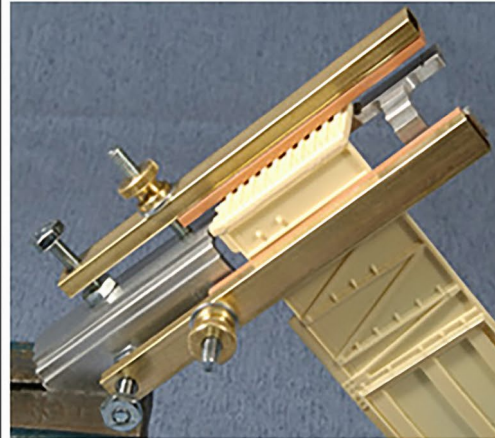

Combo Right Clamp™
with cast resin boxcar

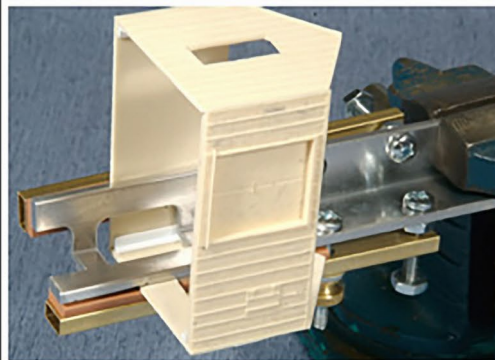

Combo Right Clamp™
with Wolf Design Pump House

**Click here for
all our products ...**

Tools for Modelers

Coffman Graphic Solutions Co.
1500 River Circle, Richmond,
KY 40475-7907

Backdrop Junction Your Stop for Railroad Backdrops

Click Here →

**For the Finest in Custom
Designed backdrop**



www.backdropjunction.com

Do You DETAIL?
OUR SELECTION
WILL BLOW YOU
AWAY.....

OVER 1000 DESIGNS

WWW.MODELTECHSTUDIOS.COM
N HO S O SCALE

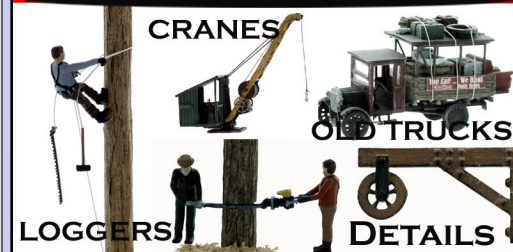

■ 83,333 cu. ft./3500 cu. ft. = 24 boxcars

Allowing for voids and such, about 30 cars or so.

Note: The new Accurail 36-foot boxcars are stenciled as 2568 cu. ft., requiring 32 cars or more to haul the same volume of wood. Bear in mind that lumber in box cars was not necessarily loaded all the way to the roof – there had to be maneuvering room to get the boards in and out. Planed finish lumber generally rode in boxcars; rough-cut lumber could travel exposed to the weather in a gondola or flat car. Some types of wood are heavier than others, and freshly cut wood has a higher water content than wood that has been decked or kilned.

Neil: I would work on the premise that a functional mill working in those days (if it is light out, then we cut lumber) would load about a car a day. Assuming the mill would shut down on Sunday, I think if you provided enough track capacity for three



5. How much wood would a 1930s Southern mill ship in a month? *National Park Service photo*

cars then you could swap one car per day and that would allow the stackers to always have one car to work and a second for overflow.

Dave B: A 40-foot car eight feet wide inside could hold about 320 board feet per layer. If they could stack the layers 6 1/2 feet (78 inches) high they have 24,960 bd. ft. per car. Rounded off to 25,000 bd. ft. per car it would take 40 carloads to ship a million bd. ft.

Read more stories of loading and unloading box cars at mrhmag.com/node/5605.

Code 55 rail in N scale



6. N-scale “high-rail” wheels.



7. N-scale wheels for Code 55 rail. *Prof. Klyzlr photos*

Q. I am planning to use Code 55 track on my new N-scale layout. I understand that on some rolling stock the wheel flanges are too deep for Code 55 track, but will run on Code 80.

When looking at purchasing rolling stock, how do I tell that the cars or motive power I buy will have flanges that fit Code 55 track? Are they labeled in a special way?

—Nman

A. Bremner: If the rolling stock was made in the last 20 years, it will most likely be Code 55 compatible.

Dave B: When Atlas Code 55 came out, Micro-Trains included extra-low-profile wheels for a while, and eventually came out with a wheel that works on Code 55. The good news is it's simple to put Code 55-compatible wheels in any cars you like. If you have old engines with large flanges, they can be sold on eBay and newer engines bought, which will likely result in a more-detailed better-running engine. I used code 55 Atlas and Micro Engineering track for my N scale layout. I really like its looks and working qualities, so I'd recommend it over larger rail.

Prof. Klyzlr: Visually, the older-style wheels which need minimum Code 80 tend to look like [6] and the "low-profile" wheels which work fine with Code 55 look like [7]. I strongly recommend checking out spookshow.net, a fantastic source for all things N scale.

 TIPS

Parts drawers with easy-change labels



Labeling on plastic parts cabinets drawers with "permanent" labels like a black Industrial Sharpie, regular Sharpie, or general type marker can usually be wiped off with isopropyl (rubbing alcohol) and the drawer relabeled. The same trick works well on pill bottles.

—Nick Santo

 GET PAID FOR YOUR TIP

We pay \$25 per tip we publish, or \$40 each if the tip also includes a photo or finished drawing. [Click here and select article type TIP.](#)

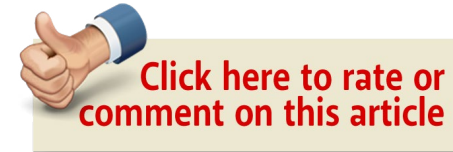

ADVERTISEMENT



YD
Yankee Dabblers

www.yankeedabblers.com (856) 312-8084
101 West King, Bellmawr, NJ 08031
In Philly? YD store is 1 mile from NJ end of Walt Whitman Bridge
Visit OUR NEW WEBSITE! SAME GREAT SERVICES & PRICES!

SEARCH button

Brands
YD Products
View all brands

Categories
DCC PRODUCTS
View All Categories

New Audubon, Iowa Store

Featuring New ESU Cab Control Wifi Digital System & Wifi Mobile Control



11/11 - 11/17
Milwaukee, WI

01/27 - 01/28/18
Westspring Field, MA

Specializing in DCC! ~ The Best for Less! ~ Sales-Services-Installation!

Free Technical Coordination (727) 457-9227 9AM to 9PM EST

CLICK AND SAVE TODAY!

Use coupon code "MRH" for FREE SHIPPING
YD installs DCC or RailPro in your engines

Stop by and meet us at the following hobby shows:

Click on Show Schedule for info links



From first train set to railroad empire...

*Our complete line of DCC products
grows with you. Discover the fun!*

- Designed and manufactured in the U.S.A.
- Preferred for ease of use and ergonomic design
- Unlimited scalability for any size model railroad
- Plug-and-play means more time running trains
- Great customer service and excellent support



Visit our new and improved web site for all your DCC needs!

- Get the latest new product announcements
- Watch our detailed how-to videos
- Browse the all-new Information Station
- Enjoy secure online sales, day or night!



See your dealer

Visit **ncedcc.com**



Great control in a tiny package



**Original
Touch Toggles**

- Touch Toggle™ plug in controls
- Bright clear indication
- Easy setup
- Flexible system

Stall Motors, Twin-coils,
Power, and Servos

Now for Tam Valley Depot
and MRservo too!

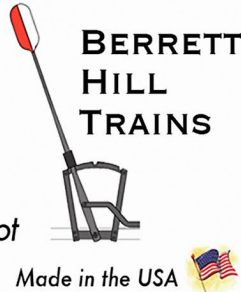

What will they think of next?

www.berrethillshop.com

DCC IMPULSES

column



BRUCE PETRARCA MMR



[Click here to rate or comment on this article](#)

A NOVICE'S VIEW OF THE NARROW GAUGE CONVENTION

WE THOUGHT YOU MIGHT LIKE TO SEE THE Narrow Gauge Convention from my eyes. I attended for the first time in my many years of modeling this summer. So, instead of a DCC-focused column, this month's is a view of part of the modeling world from my perspective. It was the 37th annual version (37nngc.com). About 10 folks who were there had been to all 37.

I am moving more and more in the direction of narrow gauge for my modeling interests, so it was time to get my feet wet. Also, it was held in Denver, close to where I now live in Arizona. I was born in Denver and spent many years living along the Front Range from Cheyenne to Colorado Springs. That said, things have changed a bit in the 31 years since I've been in this part of Colorado.

Here is an armchair tour of the convention as I experienced it.

► DCC TIPS, TRICKS, AND TECHNIQUES



Servo Switch Machines

- Easy to use
- Low-profile
- Accessory contacts

LEARN MORE



Infrared Detectors

- Simple installation
- No adjustments

They just work!

LEARN MORE



Electronics for Operation

- Fast clocks
- Time locks
- Signal controllers

LEARN MORE

WWW.IASCALED.COM

TamValleyDepot.com



Frog Juicers

Automatic DCC polarity reversers for frogs on turnouts and crossings.

Servo Switch Machines

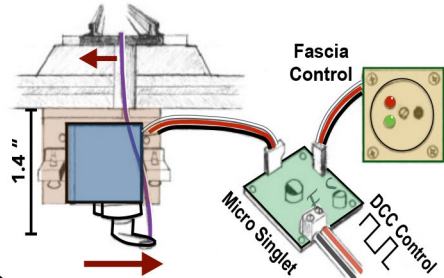

The trip

We had hoped to spend several days driving to and from the convention and to see some of our beloved Colorado in the process. Linda, my wife, was born in Denver, too. However, personal issues kept us to a very tight time frame for the trip, driving about 800 miles in two days each way. Albuquerque was just about the middle of the trip time-wise, so we booked a room there. We jumped in the car and headed out on Monday, August 28.



1. Raton, New Mexico, may be a shadow of its former self, but I love the art-deco fire department. *Bruce Petrarca photo*

We got to Albuquerque just about sundown, checked into our room, and went for some Mexican food at Garcia's Kitchen. After a comfortable night's sleep, we headed north on I-25 toward the convention.

It's been about 50 years since I've been in Raton, NM. I suggested we have a bite of lunch there. Wow, what a surprise. The town is shrinking at an alarming rate. We found a mediocre restaurant and drove around where Amtrak has taken over the former Santa Fe depot. I do love the art-deco fire department [1], even if it seems deserted.

After lunch, we continued on I-25 over Raton Pass and along the Front Range to the convention hotel, the Marriott Denver Tech Center. The population explosion along I-25 blew our minds as we drove in. When we moved from Colorado Springs in the mid '80s, the population was about 90,000. Now it approaches a half-million.

We would have loved to spend some time in the mountains after the convention, but we retraced our steps, almost, coming back. We left I-25 at Walsenberg and came over La Veta Pass and through Taos and Santa Fe. We batted 1000 on lunches this trip, stopping this direction at Fort Garland. Our meal was memorable only in its slothfulness. This route was a few minutes longer but more scenic than the I-25 route.

A bit about narrow gauge

In the US, there are a few popular scales and gauges for narrow gauge modeling. While there are lots of offshoots and variants, the major ones are shown on the next page.

The first letter or two in the identifier (capitalized) refers to an implied scale (HO, for example). The lower case n says that it is

Understanding narrow gauge modeling terms

Identifier	Scale 1:	Model gauge	Prototype gauge
Nn3	160	6.5 mm	3 ft
HOn3	87.1	10.5 mm	3 ft
Sn3	64	14.3 mm	3 ft
On3	48	0.75 in	3 ft
On30	48	16.5 mm	2 ft 6 in
Fn3	20.3	45 mm	3 ft

narrow gauge and the numbers on the end refer to the gauge being modeled. These numbers can be a bit confusing, as some refer to feet and some to inches. On3 refers to three-foot gauge, while On30 refers to 30-inch gauge.

Why attend the convention?

There are two major reasons for attending a convention: meeting the people and learning modeling concepts to inspire your own plans to attend.

But the people are the conduit for all the information. Coming to a convention and sitting in your hotel room is a waste of resources.

However, it takes energy and enthusiasm to rub elbows with folks all the time. I'll admit to sitting in the room for a few hours a couple of times, just because I was too tired. The organizers pack a lot into four days.

Some folks who I have talked with over the years came to this convention. Had I not come, I may never have had face-to-face time with them.

For example, a fellow who was a member of the Flagstaff AZ club over a decade ago turned up as part of the HOn3 New Mexico NG Model Club. Their modular layout took first place in the contest room. Anyway, I hadn't seen Ryan for years, and it was good to get back together.

One of the attendees that I wanted to spend some time with was Laurie McLean [3], a Master Model Railroader (MMR) from Australia. I have gotten to know Laurie through emails and his YouTube channel, [youtube.com/channel/UCLNfr5kmK6WiD-LaKPbajKg](https://www.youtube.com/channel/UCLNfr5kmK6WiD-LaKPbajKg), where he has posted literally hundreds of how-to videos relating to DCC and animation and LED lighting. About a

ADVERTISEMENT

Make LocoNet wiring extremely simple!

ACCU-LITES, inc
Your DCC Center!

Suitcases belong in your baggage cars,
not under you layout!

Introducing the DCC Vampire II ...
this guy does the job of two suitcase
connectors!
And really holds the connection good
too!

CLICK NOW TO DISCOVER THE AMAZING VALUE!



Dealer Inquiries Accepted



2. I've seen Laurie McLean's animations in his YouTube videos. Seeing them in person was as big a treat as getting to spend time with the man himself. *Bruce Petrarca photo*

year ago, when I learned that Laurie was planning to attend this convention, I started making my own plans to attend.

Our time together was not a disappointment. What fun we had. Seemed as if we had spent time together weekly for years, as opposed to setting eyes on each other for the first time when we happened into the same elevator on the first day of the convention.

While Laurie's animations [2] have whetted my imagination over the years, holding one in my hands and being able to look into its mechanism was amazing.

ADVERTISEMENT

New Tsunami² Sounds for Legendary Locomotives!



Bring more of your locomotives to life with our new Tsunami2 sounds! Cummins QSK19C x3 GenSet sounds and Gas Turbine Electric (GTTEL) features are now available in all Tsunami2 Baldwin & Other Diesels Digital Sound Decoders.

[Listen Now ▶](#)

SOUNDTRAXX™

DCC IMPULSES | 8

There were folks in attendance who I knew, and a lot who I hadn't met before the convention. I came away with a lot more friends. Time spent together enhanced old bonds and established new ones.

The clinics

Early in the convention, I wasn't really prepared for what was to come. The clinics and layout tours were about to start. Inspiration material breaks down into discussing techniques and seeing what others have done on their layouts or modules.



3. Laurie McLean's clinic on DCC and animation was well attended and received. *Bruce Petrarca photo*

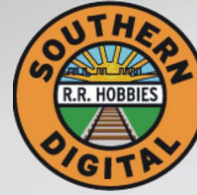

Southern Digital

WWW.SODIGI.COM

Celebrating 25 Years of serving you !



**Soundtraxx Tsunami
Motor/Sound Decoder**
50% Off while they last

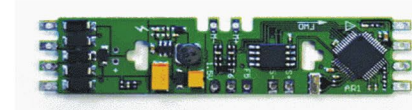

Super Sale

DiGiTrax
Complete Train Control

Simplex Radio
Throttle clearance
while they last



Close Out

DT402R
\$165

UT4R
\$99

DCC Conversions, Service & Support
E-mail: sales@sodigi.com (770) 929-1888



The clinics began on Wednesday evening. Having been to many NMRA national and regional conventions and, having given many clinics along the way, I thought I knew what to expect. Every clinic exceeded my expectations. They were thorough, detailed, specific, and well presented.

For example, there were a pair of clinics about Gilpin County, CO, covering Central City and Blackhawk. This three-mile square bit of geology is the location of over 500 mining claims and had 200 active mines about 1900. Some of the ore was over 20% gold by weight, with another 10% silver, and 10% copper.

Monte Pearson (a Ph.D. in geology) discussed the geologic forces that concentrated ore in such a small area. Keith Pashina, a long-time modeler of the district, discussed “Mines and Mining along the Gilpin Tram” in another clinic. The Gilpin Tram was a 2-foot gauge railroad that serviced the mines using as many as five Shay locos. These two clinics complemented each other nicely.

These clinics worked hand-in-glove with another clinic: “Prototypically Modeling a Mine Site,” by Ed Freeman. A long-time student of mining technology, Ed explained what needs to be in a mine diorama, and what sort of equipment is era-appropriate.

The Thursday afternoon meeting of the On30 folks was amazing. Having about 60 enthusiastic On30 modelers together was good. Add in a representative from Bachmann Trains, Ray Buteux, and Chris Lane, the founder and editor of the *On30 Annual* as host and cheerleader. Presentations by Kevin Spady (On30 modules) and Pete Steinmetz (Dead Rail Installations), rounded out the two hours spent.

“Making Photorealistic Buildings Out of Cardstock Using a Computer” was a clinic by Joe Crea that excelled. I was expecting to see some quick buildings that would make-do until real



4. “Model Builder” software can be used to build credible structures using printed paper glued to cardboard, with weathering and signs included. I believe there was one piece of wood, for the cornice above the false front. *Bruce Petrarca photo*

buildings could be built. What Joe shared, along with some witty humor, are buildings built out of paper and cereal boxes [4] that are almost indistinguishable from craftsman kits.

If the clinics were interesting, the layouts were over the top.

The layouts

You didn’t even have to leave the hotel to see some amazing modular layouts. The atrium [5] of the hotel was turned into a

mini train show with several groups showing their handiwork. There were layouts in the hallways around the meeting and vendor rooms.

In the spirit of ecology and sharing, I started off on the first round of layout visits riding along with a collection of friends from San Diego (Pete Steinmetz, Bob Treat, and Steve Seidensticker).

Our first venture was to Colorado Springs to visit Rick Huntrod and his scenery spectacle, the HOn3 San Juan Silverton [6]. A picture is worth a thousand words – check it out.

Rick's layout proves that good things can come in small packages. He has shoehorned what looks like miles of scenery into a 12 x 15 foot area. This is a DCC column, so I will say that the layout was DCC-controlled with some fine sound-equipped locomotives.

Our next stop was Kevin Strong's Fn3 Tuscarora Railroad. This is an outdoor railroad running on battery power, with AirWire DCC radio control. Designed for continuous running on a



5. The atrium of the hotel was home to several modular layouts. Here they are in the process of being set up. *Bruce Petrarca panoramic photo*



6. Home layouts provide lots of “eye candy,” perhaps none better than Rick Huntrod's HOn3 San Juan Silverton, featuring a photo backdrop and hand-built trees in fall colors. *Bruce Petrarca photo*

point-to-point layout, it features a teardrop turnaround on each end, each accessed through a spring switch. This layout runs around a grassy backyard about 30 x 65 feet in size.

From Kevin's we headed to Ken Schei's home to take in an amazing amount of bridges [8], trestles and tunnels on his Calumet and Hecla RR in On3. At 12 x 33 feet, this layout doesn't win any size contests, but pleases the eyes with fine modeling and innovative use of mirrors. Ken uses DCC Lenz, as I remember. But don't take that to the bank - I'm not sure what I had for breakfast yesterday.

The next time we ventured out to look at layouts, we added another southern Californian to the motley crew, Dave Balsler. We headed for an indoor Fn3 layout, Bill White's San Juan Southern. This 20 x 30 foot layout was touted as being “well worth seeing.”



7. Kevin Strong's Tuscarora RR Fn3 outdoor layout brings modeling to the garden. *Bruce Petrarca photo*



8. Ken Schei's Calumet and Hecla RR On3 layout has an amazing collection of bridges and rock work. *Bruce Petrarca photo*

I realized we were in for something special when we entered the room to see a model Ford Tri-Motor airplane directly in front of the entry door. The attention to detail and small vignettes were mind boggling. I'm including two of the many photos I shot at Bill's house in this column.

The Baby Bee Mine [9] is humorous and full of things to suck you right into the scene: animation, lights, and sound.

One of the other guests pointed out the realism of the auto repair scene [10], where the modeling even includes the part being installed and its shipping carton. Elsewhere on Bill's layout is a functional stamp mill with all the belts and pulleys.

I'd like to say that Bill runs NCE DCC, but there were no trains running when we were there. Seems a guest had turned off a block and, with the rush of folks, there was no way to troubleshoot the



situation. I can say that NCE DCC was installed.

9. Bill White's San Juan Southern Fn3 is a study in details. This "Baby Bee Mine" is fully illuminated and automated with sound to boot. *Bruce Petrarca photo*

DCC IMPULSES | 15

From Fn3, we moved to a startup On3 layout with lovely details and the use of a photo backdrop. Don Vancil's D&RGW layout is starting with the loco service area of Ouray, CO [11]. His plans include filling the rest of the basement with more of the same. The layout is powered by Tam Valley Depot's DRS over-the-air DCC system and batteries.

The next morning, I spent some time talking with the folks from the Casper, South Fork, and Eastern modular layout. This Nn3 module set features innovative LED lighting [12] to simulate early morning.

The photo backdrop was created by photographing the actual trees on the module and using a photo editing software to create layers of trees with slightly differing tonal values. Very effective.

The musketeers were at it again the next afternoon, out to home layouts. We visited Gerald Style's innovative On30 layout [13]



10. Amazing detail on Bill White's San Juan Southern Fn3. Note the part in the shipping box being installed on the auto under repair. *Bruce Petrarca photo*

Want to SNEAK PEEK what you've been missing?

Take a peek



Holiday special pricing in effect



www.trainmasters.tv



TRAINMASTERS.TV



11. Ouray engine house and photo backdrop on Don Vancil's D&RGW On3 layout. *Bruce Petrarca photo*



12. The Nn3 Casper, South Fork and Eastern lumber camp module has innovative lighting duplicating sunrise and a bright blue sky. *Bruce Petrarca photo*



LED's, Signs, and Sounds for
N, HO, S, O Scales

Miller Signs | Evan Designs
Iron Penguin | Ring Engineering
EZ Line | Tomar | ITT Sound Boards

find us on facebook

Shop Now

Want it on Blu-ray?

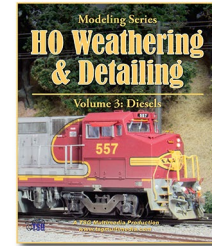

Selected titles are
now available on
Blu-ray disc in
spectacular HD!

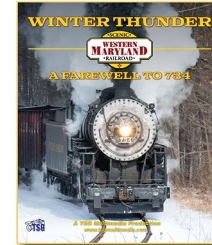
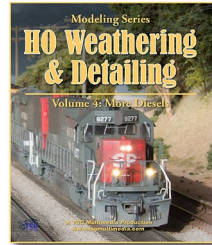

CLICK FOR
BLU-RAY

TSG TSG Multimedia

RailPro™

NEW TECHNOLOGY



Click Here to
Learn More

For more information visit our Internet site: www.RingEngineering.com

RE RING™
ENGINEERING

NEW Starter Kit
\$399.99 MSRP

- Includes Wireless Color Touch Screen Handheld Controller and 56 Watt Power Supply
- Expandable to Virtually any Size Layout

NEW Locomotive Module
LM-3 & LM-3S



- Direct Radio RF
- Sound and Non-Sound
- New Tiny Size
- 6 Light Outputs

DCC IMPULSES | 17

featuring fun animation: a flying eagle, and groundhogs. Digitrax DCC is the control method. The Termite-N-Tarantula occupies 22 x 25 feet in the basement.

Another layout that our crew visited was Ron Keiser's D&RGW. In the 1:20.3 scale of Fn3, Ron packs a lot into 24x36 feet. Since it is designed as a one-man layout, it uses DC control.

Between the dramatic lighting and the details on the layout, a guest could spend a long time looking and still not see it all. I especially enjoyed the body that was working to open the casket before it was interred, while the coroner looked on from the fender of the hearse.

On Saturday, Linda and I took off to Castle Rock to visit Don Meeker's Rocky Mountain Line. This amazing layout occupies the entire 2800 square feet his home's basement.



13. Gerald Styles' Termite-N-Tarantula On30 yard. *Bruce Petrarca photo*

DCC IMPULSES | 18



14. Ron Keiser's D&RGW shows the detail that is attainable in an indoor Fn3 layout. Notice the blue light giving depth to the backdrop. *Bruce Petrarca photo*

While it is standard gauge (HO), it is Digitrax DCC-equipped and designed for operations. Don's operating sessions require 25 or more participants with CTC track control.

Around every corner there was something new to see and revel in. I found the Gilpin County section interesting, given that I had studied it in the clinics earlier in the week.

This layout models an "alternative universe" version of Colorado in the 1950s (Centennial is the capital city). Some of the highlights are the operational version of the Moffat Tunnel with its approach grades, and Union Station in the capital city.

Lots of small scenes make for great detail enjoyment and photos to be taken.

Vendor rooms

Competing for time during the four days of the convention were two rooms full of vendors, 114 in total. It was fun to wander and chat. There was even time enough for socializing, not just business. I must admit that Linda made the only purchase for us: a tool – a pair of cutters for her beadwork.

Contest room

The modeling skills of the attendees are amazing. The contest room took several hours to hurry through. Studying it would've taken days, if they had been available. Check out the winners at 37nngc.com/contests.html. Again, a photo is worth a thousand words. A full webpage equals a hardback novel.

The end

I was pleased to see that there was no expensive chicken dinner on Saturday night. Instead, they set up one of the vendor rooms as an auditorium. There was no charge for the awards ceremony, except for what was spent at the cash bar.

The committee was recognized. They deserved all the accolades.

Contest winners were announced.

Future convention cities gave an update on what they would be offering.

The attendance was announced: 1960 folks total.

The evening ended with an auction to benefit the Narrow Gauge Preservation Foundation. We did part with a few bucks here, but it's for a good cause, eh? The convention also contributed \$5000. The NGPF is providing funding for projects around the country,

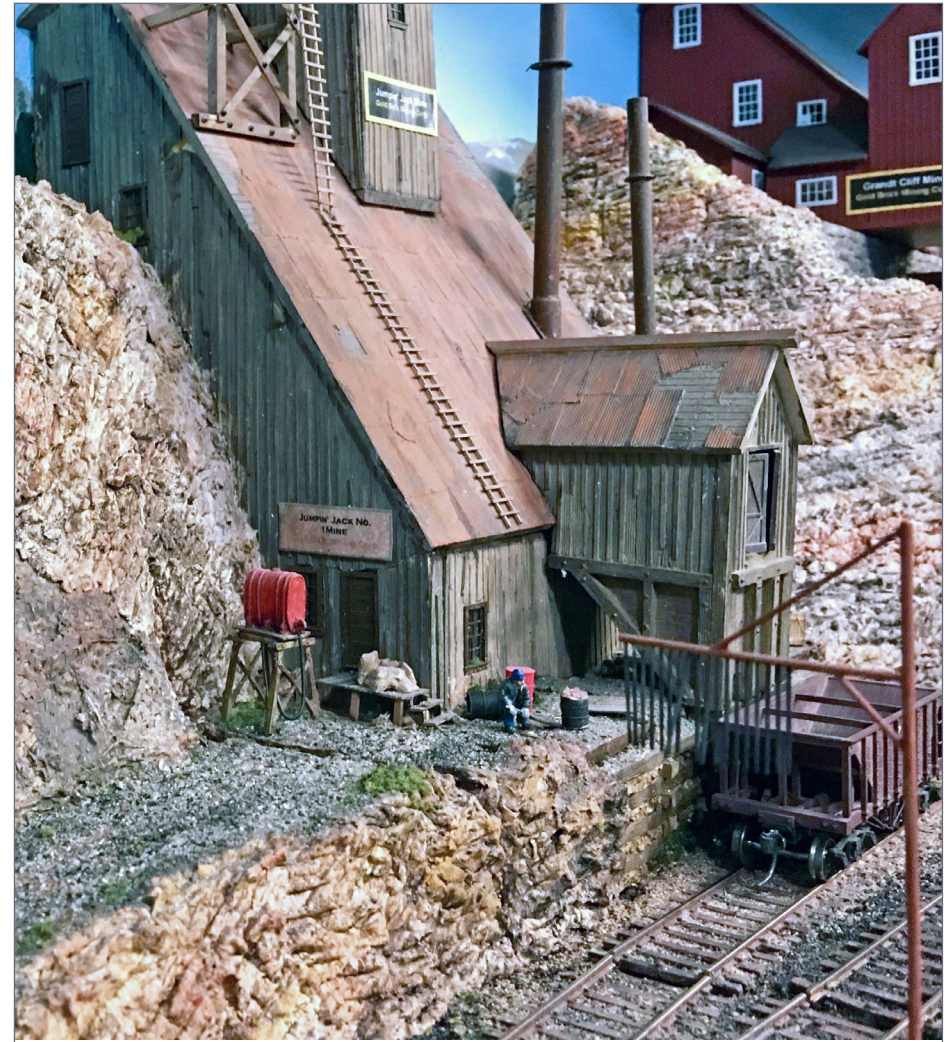

15. Don Meeker's Rocky Mountain Line in HO is the only standard gauge layout we visited. However, there is a very large representation of the Gilpin County mining district, which was serviced by the 24-inch gauge Gilpin Tram. Don took lots of liberties with his layout. This area was mostly accurate, except for the 4-foot-8-½ inch track gauge.

Bruce Petrarca photo

DCC IMPULSES | 21

such as the Silverton Northern trackage project and the Carson and Colorado Railway Slim Princess #18 restoration.

It was a successful convention. I scored some decor for my train room, got a lot of ideas for my Fn3 Rocky Mountain Pacific (mrdccu.com/layouts/RMP), got a road trip with my wife, checked out some Taos and Santa Fe architecture and enjoyed a bunch of friends. I may be moving closer to an HO vs. On30 decision for my indoor layout. But that's for another column.

Please share your ideas with us all. Just click on the Reader Feedback icon at the beginning or the end of the column. While you are there, I encourage you to rate the column. "Awesome" is always appreciated. Thanks.

Until next month, I wish you green boards in all your endeavors.



[Click here to rate or comment on this article](#)

**Want to help keep
MRH free?
Then *click on ads!***

TONY'S TRAIN XCHANGE

Committed to your DCC support!

Atheam Genesis HO ES40DC & ES44DC



First Time in BNSF Heritage II Paint!
Roads: CSX (YN3 & Primer Gray),
BNSF (Heritage II, HIII & Wedge)
NS (Thoroughbred & Primer Gray)

Genesis Level Details and
Performance, Available in DC
or Tsunami2 Sound & DCC

Starting at \$169.98

Order Yours

Intermountain HO GE C44-9W



*Expected March 2018

Pre-Order Yours Now!
Smooth New Heavy-Duty Drive,
Improved LED Lighting, Spinning
Roller Bearing Caps on Wheels,
8 Different Road Names!

Starting at \$149.95

Order Yours

NCE Power Cab

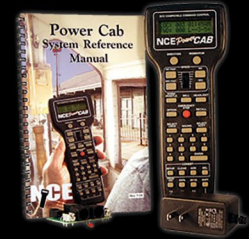

Supperb DCC Starter System

See our website
for Tony's Low Price

Order Yours

**Do you need a Sound or
DCC Installation done?**

Get a quote!



Providing unmatched person to person
DCC support for more than 25 years, the
kind of service that has made us #1 in DCC.
DCC questions? CALL US! 1-800-978-3472

We'll get you on the right track!

Nov 2017





Complete Train Control

Introducing the LNWI Wifi Interface

- **Wi-Fi interface to a Digitrax LocoNet for up to four compatible mobile Wi-Fi devices and Apps.**
- **Compatible with most Android and Apple devices running supported throttle apps**
- **Easy Setup and Configuration. A single LNWI works 'out of the box', with no additional configuration required.**



LNWI Loconet Wifi Interface | \$79 MSRP
The LNWI allows you to connect compatible WiFi devices to LocoNet and run trains using compatible throttle apps

Find out how easy it is @ www.digitrax.com/throttleapps/



Bowser

HO Baldwin DS 4-4-1000 Locomotives

Ready to Run and Detailed. Features: air hoses, windshield wipers, grab irons, coupler lift bars, operating headlight, window glass, can motor, flywheels, nickel silver wheels with RP25 flanges and knuckle couplers. Available with sound and DCC (LokSound Select decoder) or just DC. Analog (DC) version features 21 pin socket for DCC module.

Road Names: B&LE, CNJ, Copper Range, CP, LV, Milwaukee Road, NPR, PRR, SMS, Southern, SP, & UP



Click here to check out the details for these and other great Bowser Products



MIKE ROSE
.....

Model Railroad Hobbyist | November 2017 | #93

GETTING REAL

column



Click here to rate or comment on this article

MODELING SKINNER'S EDDY, PA | (PART 1)

IN MY JANUARY 2017 "GETTING REAL" COLUMN (mrhpub.com/2017-01-jan/online/html5), I covered the big re-do of the former Athens area of my layout. The reason I mention it here is that part of it blends right into the area I'm covering this time: Skinner's Eddy.

This is a real town in Pennsylvania on the Lehigh Line, right next to Laceyville. Although it existed in one form prior to this peninsula before the do-over, it was going to change radically and evolve into something that really captured the feel of that entire area.

There were a number of problems to solve here: a coal mine that was never on my line, a double-track main line up above the lower main, a double-track through truss bridge, and a mountain with tunnel. They all had to go!

This was not a trivial project. It seems like the best course of action was to get right down to benchwork and start fresh. I did manage to keep the lower main and some scenery adjacent to it (it was just fine already). About 95% of this area is now new and built from scratch. Let's follow the process in photos.

► MODELING REAL RAILROADS AND WHAT THEY DO

GETTING REAL | 2



1. An old photo shows the awkward scenery separating the two track levels. This unfortunate juxtaposition always bothered me. This photo was clearly before I backdated the layout, as the wide-nose locos and quality Bethgons from the nineties attest.



2. This bridge had already been removed in a previous rehab effort, but the very dated mountain and tunnel behind it were also things that now needed to be removed.

GETTING REAL | 3



3. Here is the peninsula at the beginning of destruction. The aforementioned through truss bridge is in the lower right, and the mountain and tunnel (originally designed to disguise the 36" - radius turn-back curve) is at the far upper left. In this view the connecting scenery between the upper and lower tracks has been removed.

The white building with two freight cars spotted there is Whipple's Lumber, a warehouse and distribution center for a chain of building materials locations in the area. That consigne is pretty much all I intended to retain.



[Click here to rate or comment on this article](#)



4. (Above) This shot shows the rest of the through truss bridge and everything to the right of it was re-done in my previous column. This photo and the previous one [3] might be interesting reference points to look back on as the article progresses!

5. (Top right) A trip to the local big-box store supplied the necessary 1" pink foam, which was applied to the benchwork after most of the demolition was done. This view is from the peninsula end, opposite the previous photos, and shows the now daylighted 36"-radius curve the mountain had previously covered up.

One important design goal here was to not have this obvious curve scream "model railroad curve" when I was done. Note that I'm already drawing in the beginnings of a stream and the roads including an eventual Route 6 that would extend the length of the peninsula, something

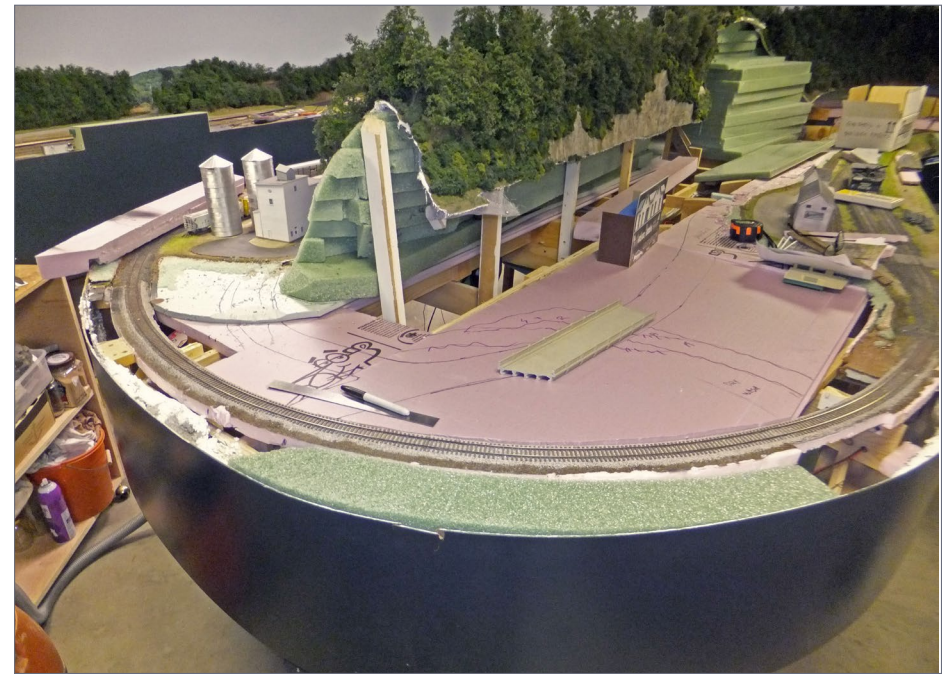

I'd never done before. The concrete road bridge is an old Pikestuff model built by my friend Jim Lincoln and donated to the cause many years ago.

To the extreme left you can see the silos and elevator for the Agway in Laceyville, still under construction. Laceyville and Skinner's Eddy are literally this close together on the prototype too! You can also see a photo mock-up of the infamous Table Rock Hotel, a landmark in Skinner's Eddy, which was being constructed by well-known structure builder Rich Cobb at this time.



[Click here to rate or comment on this article](#)

GETTING REAL | 6



6. With final demolition accomplished, this view reveals the construction used on the opposite (Laceyville) side of the peninsula, and I intended to basically do the same thing on this side. I'd been stockpiling 2" florist foam with this in mind for several weeks. The trick here was to design a steep, wooded hillside that still allowed proper room for the road and a few houses without it looking crowded.

Fortunately the prototype had the same problem with the railroad – Route 6 and those houses all crammed in between the mountain and the Susquehanna River, which was part of the appeal for me of modeling this area in the first place.



[Click here to rate or comment on this article](#)

GETTING REAL | 7



7. Construction of the hillside began with laying out the bottom layer of 2" foam and determining the initial cut-back, which is why it was so important to have some idea of the road's size and location before doing that. The stream bed plywood for Tuscarora Creek has been installed at this time too (my orange-handled pliers are sitting on it).

It soon became apparent that turning the corner and blending the hillside into the existing one at the end of the peninsula would need a very careful touch.



[Click here to rate or comment on this article](#)

GETTING REAL | 8



8. With the base layer cut out and in place, I had my starting point to proceed up the mountain face rapidly. One of the things I love about this type of construction is how easy it is to cut the foam using the pictured tools (that's a fish file knife that I sharpen often during this process).

The clean serpentine vertical cuts were achieved using my band saw out in the workshop, which helped to minimize dust in the layout room.



[Click here to rate or comment on this article](#)



Mike Confalone's ALLAGASH STORY

4 volume eBook series



[Order Allagash Story](#)

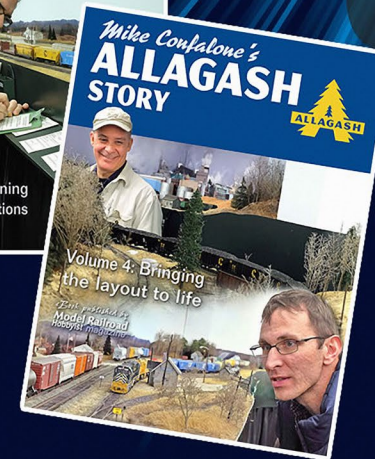
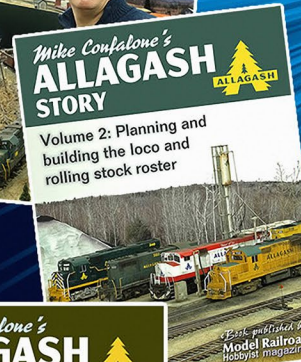
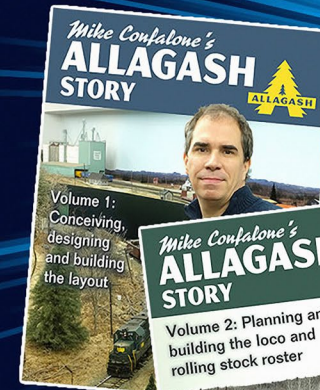

Vol 1: Building the layout
100+ pages - \$8.99

Vol 2: Building the roster
100+ pages - \$8.99

Vol 3: Planning prototype ops
90 pg + forms - \$8.99

Vol 4: Bringing the layout to life
100+ pages - \$8.99

4 volume set: ~~\$35.96~~

Special: \$29.99

from the
**Model Railroad
Hobbyist Store**

Formats: PDF - ePub - Kindle



9. The knife is used to cut the angle of the layers back so I can begin to shape the slope of the mountain and get a feel for the overall look as it goes up. By the way, the markings on the green foam mean nothing; they merely show that I can re-cycle a lot of this material from changed locations.



[Click here to rate or comment on this article](#)



10. For each successive layer it was just a matter of placing pieces, tracing from below with a Sharpie pen, cutting them out on the band saw, and angling each one back by eye.



11. At this stage small weights were used to keep the whole structure stable, but later would be used during the hot-glue process to bond it all together. This stairstep approach on the long areas enabled me to get three and sometimes four strips out of a single piece of foam, which saved a lot of money without compromising structural integrity. Once it was all glued together and connected at the top, the hillside proved to be very strong.

GETTING REAL | 11



12. I employed my great industrial Pam Tite glue gun (with the temp on a much lower setting for regular glue sticks) to bond the hillside in place very quickly. To give you an idea how fast this all goes, the entire hillside was constructed in a couple of four-hour work windows.



13. I ended up being satisfied with the blunted hillside end, judging it sufficiently broad to look "right" once covered with trees. I still had that glaring 36"-radius turnback curve to contend with, but first things first.

GETTING REAL | 12



14. The prototype had a couple of distinctive shale rock formations looming over everything, so I used the excellent Cripplebush rubber rocks to represent these as shown. These apply very easily with more of the same hot glue.

ADVERTISEMENT

Get the latest Model Railroading News, Tips, Reviews & Opinions



Our iTunes feed has changed search for
"Mike And Scotty Live" to receive the latest episodes!

www.themodelrailroadpodcast.com

Hosts:

Scott Mason: www.scottymason.com

Mike Rose: www.mrhobby.com

Don't Miss our Monthly Interviews
& Product Announcements

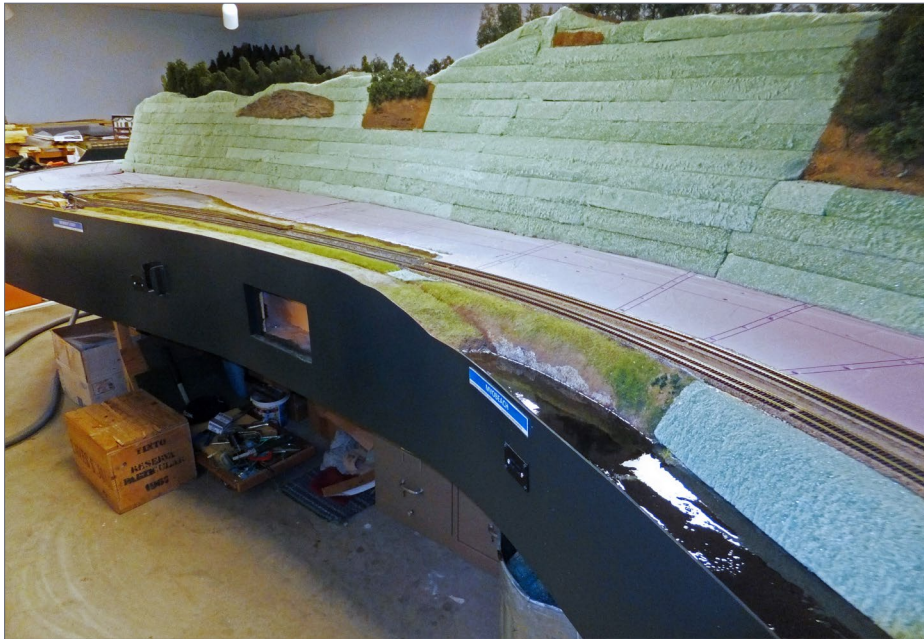

15. Here's the completed scene, all cleaned up and ready for the next step: dirt!



16. Talk about a dramatic difference! It goes from obviously under construction to the beginning of scenery in about half an hour. Mike Confalone turned me onto the "secret" of painting open cell foam such as this: paint brush full of paint in one hand, squirt bottle of water in the other, and just have at it. I think a video of this would be truly hilarious!

While everything is wet I liberally sprinkle dried, screened yard dirt over all, and this becomes my base layer of mountain. You can definitely see all the foam joints at this stage, but soon it won't matter one bit. And needless to say, I cover all of the tracks and anything else I don't want messed up while doing this, as there's no truly neat way to get it done.

Want to help keep
MRH free?

Then *click on ads!*



Click here to rate or
comment on this article



17. Even the flat areas received similar treatment, as I wanted the ability to easily plant trees and small shrubs there too. And there's no question that the less pink I saw, the happier I got.



18. In my modeling area trees are the key – lots of them! Having developed the methodology for mass-producing Super Trees, I just got into high gear and began cranking them out about 125 at a time. At this point I'm already halfway up the peninsula. I estimate conservatively that this new project involved over a thousand trees, for a total of well over three thousand installed on the layout so far.

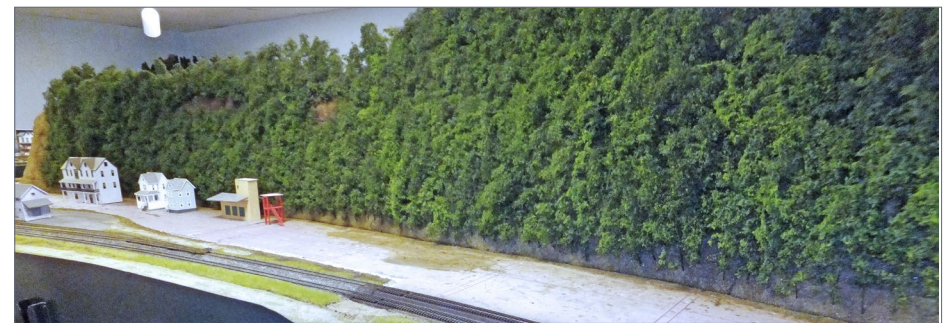

19. With most of the trees in place, I couldn't resist trying some structures. Note the Table Rock Hotel, left, has now been delivered. Rich Cobb built all of the wooden structures shown here.



[Click here to rate or comment on this article](#)



20. I must admit I was pleased with completing the majority of the tree work on this peninsula! Note how the blunted mountain end looks pretty normal with trees on it now. The cork roadbed is being used to outline where the road paving will commence and serve as the screed and forms for it.



[Click here to rate or comment on this article](#)



21. Did I make a lot of trees for this segment? You're looking at four empty Super Value Cases of Super Trees and empty ground foam containers used to make them.



22. I realized that I could not do much with the roads until I had the road bridge's location and height firmly established. Here I'm trying the cut-down old Pikestuff bridge in place, and using the abutments to position it at the correct height to match the road's thickness, which was based on the cork's thickness.



[Click here to rate or comment on this article](#)



23. While I'd paved many roads on the layout prior to this, believe it or not I'd never done one with lines, and this was to be a major road so it absolutely required them. I consulted heavily with Mike Confalone and Neil Schofield on this, since they'd both built some really nice roads, and decided to follow their lead and use decal striping. I did a mock-up, shown here, just to test the methods. I used light-weight spackle, colored with poster paint pigments mixed in, for the paving.



24. (Above) After determining the bridge location and gluing the abutments at the correct height, I made a blank out of wood to act as a place-holder for the bridge itself. This would allow me to “pave” right up to the blank, let the road material cure, remove the blank, and then simply drop the Pikestuff bridge into place, and have everything line up. I wanted the bridge removable so that I could do the stream bed and water pour without it being in the way.

25. (Right) A great deal of care was taken in the positioning of the road, as you really need to get this right and you’ve got one shot at it! Not only was the road’s location fine-tuned, but I took Mike C.’s suggestion to gently taper the road at the far end, lending the illusion of distance to it. The road was designed to eventually duck out of site behind a treed “lump.” The other thing I was beginning to realize at this stage is that having Route 6 cross the tracks at the end of the peninsula (a departure from the prototype), really helped to break up that curve in a pleasing way.



[Click here to rate or comment on this article](#)



26. (Above) This close-up shows how the blank enabled me to pave right up to where the bridge would be without messing up anything.

27. (Right) I needed a nice glossy road surface to apply the decals, but testing showed that I'd have to use a TON of gloss spray and multiple coats to achieve that. I decided to try a gloss acrylic Minwax product that simply brushed on; it worked like a charm. Here the cork has been removed very carefully using an X-Acto blade to free it up from the paving the next day, and the gloss has been applied.



[Click here to rate or comment on this article](#)





28. (Above) Microscale yellow decal stripes were used to do the center lines (a LOT of decal stripes that is!). While at first I was a little intimidated by doing that much decal work on the layout, it proved to be pretty easy for someone experienced with decals. The usual two-bottle Microscale technique was employed and, although I occasionally measured, the final decal locations were determined strictly by eye. For things like this it's often better to have it look right than anything else.

29. (Right) The white side lines really finished off the road and gave it that "important" look I was seeking, as compared to the side roads. Once all decals were in place, I sealed them with several coats of spray-can Dullcote.



[Click here to rate or comment on this article](#)



30. This view shows the restored, currently dirt-only area where the through truss bridge was removed and track restored, along with the beginnings of the road-end-hiding lump being created out of scrap foam.

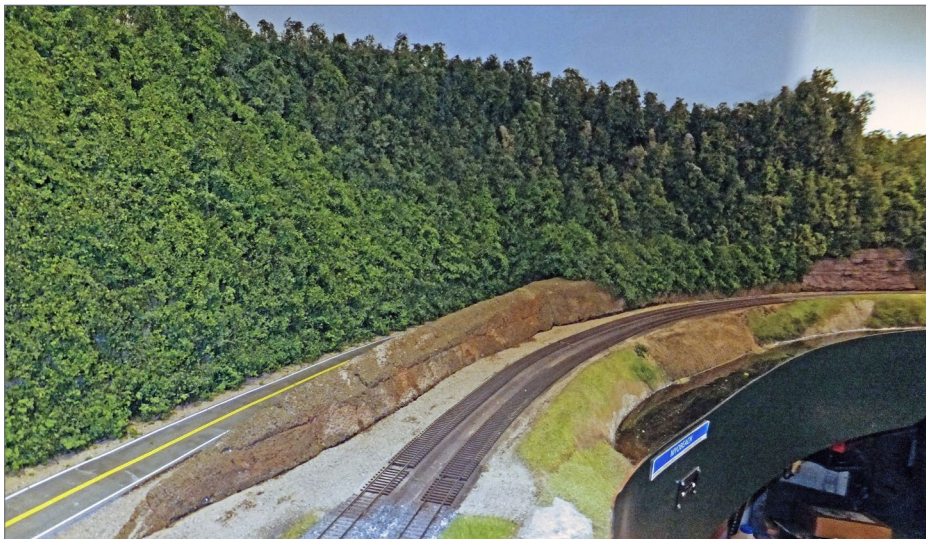

31. The trees applied to the lump are already hiding the end of the "road to nowhere!"

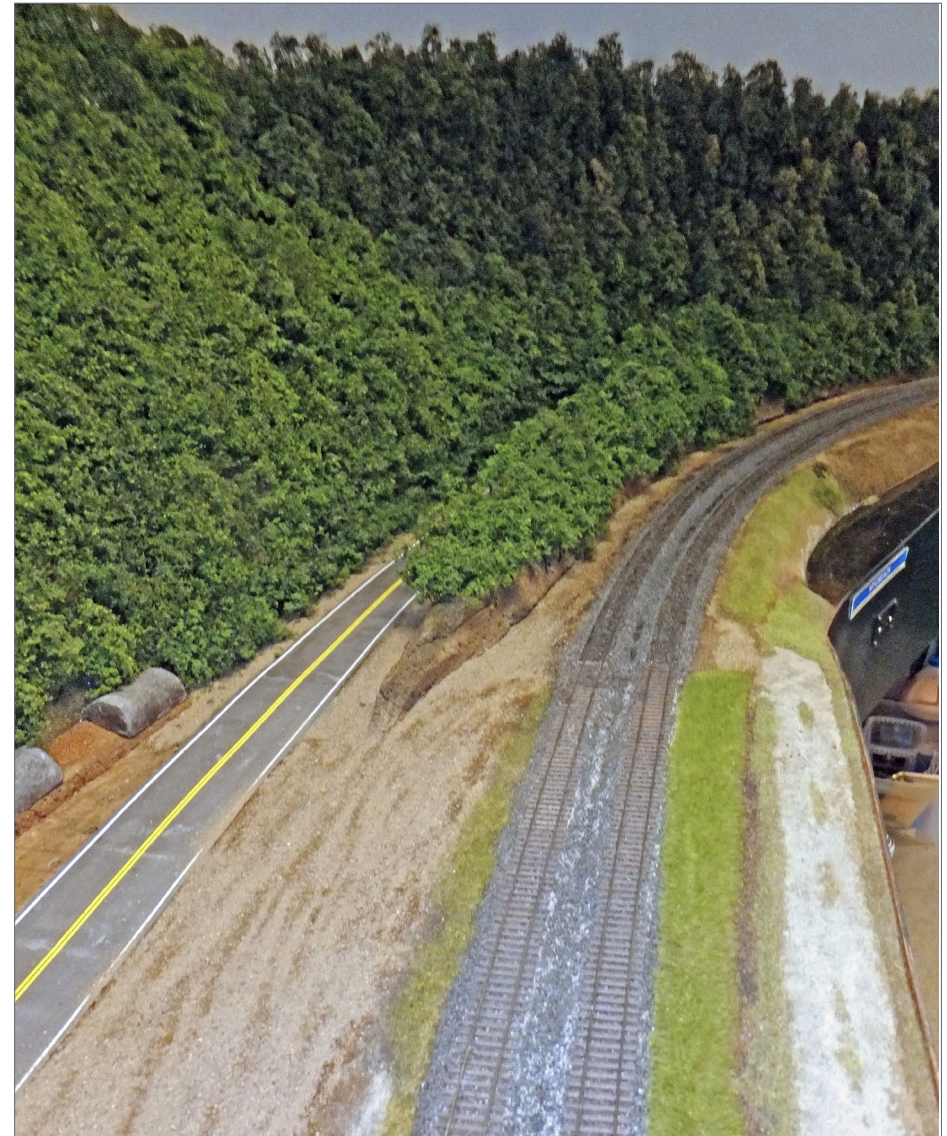

32. It was critical that the road disappear around a tree bend without looking suspicious, no matter what the viewing angle, so a lot of care went into making sure that was the case. Ground cover is also being used, which moves the scene toward a more finished appearance.



33. Some additional connecting pavement joined the new Route 6 with smaller side roads. This one exists on the prototype, and allows access to the river for fishing and other recreational purposes, along with connecting to the entrance to Whipple's property.



34. Before I could install the bridge I needed to do the work on Tuscarora Creek's stream bed. More foam scraps were employed to make the banks and fill in around the road bridge abutments. The area behind the bridge was particularly tricky, as I had to somehow create the illusion that the creek kept going beyond the bridge instead of just running right into the mountain side.

Please tell your buddies about MRH!

 [Click here to rate or comment on this article](#)



35. Paint and dirt were used as done previously to blend the new foam into the existing scenery.



36. It always makes sense to work from back to front, so I chose this time to install a couple of homes visible in this area, including their lawns and driveways. Those are the ubiquitous Fresh Cherries vehicles, and a Mr. Plaster casting of a stone wall dating back to my teenage years. These are houses that had previously been intended for Athens but ended up being just right for this spot.



[Click here to rate or comment on this article](#)



37. The proof of the pudding for me is always the ground-level shot, which I compared favorably with various shots of the prototype. In the distance is a fuel and propane dealer

which was literally that close to the homes. Right now it's mocked-up with a cut-down Walthers propane tank and some re-purposed chain link fencing.

GETTING REAL | 35

Next time, we'll finish Tuscarora Creek, the railroad bridge over it, install the remaining structures, and complete the scene, where it will finally Get Real! ✓



Click here to rate or comment on this article

When talking to hobby vendors, please remember to mention MRH.

Did you see this MRH video?



The ultimate "Yes, it's a model" video as James McNab switches NW 86th

Watch the video now



THE LATEST FROM MT. ALBERT SCALE LUMBER...

MT. ALBERT LUMBER YARD



10" x 10" footprint as shown
\$125.00 free shipping

No. 11 in a Series of Limited Edition Craftsman Kits – HO Scale

Three Complete Structures 3D Printed Cut Off Saw
Sylvan 2 Ton Chevy Flat Bed Truck Kit
Stoney Creek Corrugated Aluminum and Tar Paper Roofing
Detail Parts from Faller, Grandt Line, & Tichy Train Group
Laser Cut Plywood, LaserBoard & Real Wood Shingles
Laser Cut Jigs for Pallets & Fencing
Step-by-Step Instructions DVD of Construction Photos

Mt. Albert Scale Models
320 St. Patrick St, Port Dover, ON, N0A 1N0 CANADA
service@fast-tracks.net www.handlaidtrack.com

ORDER YOURS TODAY FROM...

shop online 24/7

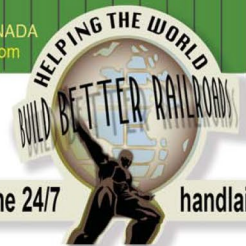

handlaidtrack.com



WHAT'S NEW on TMTV!

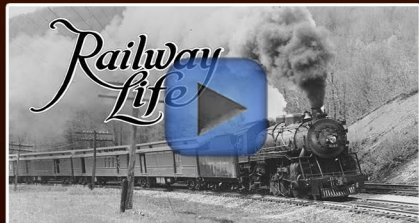

Railway Life documentary



Homemade grass tufts

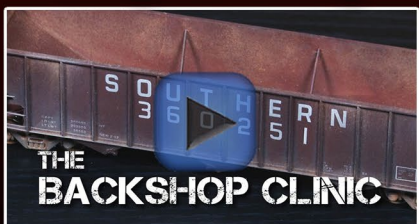

Minimalist weathering



Making structures with a computer

 **Become a member** >>
 Holiday special pricing in effect

www.trainmasters.tv



MRH Subscriber? Get your 10% off coupon code here:

Get Subscriber
10% off code



KEN PATTERSON

Model Railroad Hobbyist | November 2017 | #93

WHAT'S NEAT WITH KEN PATTERSON

column



Click here to rate or comment on this article

INTERMOUNTAIN TIER 4s, ATHEARN MOON SHOT, AND A 3-HOUR BUILDING ...

THIS MONTH RON PARE BUILDS A NEW ITLA SCALE Models laser kit in HO scale, we look at InterMountain's Tier 4 HO scale locomotives, and I walk you through the process of building a locomotive cradle. We interview George Bogatiuk as he describes his modeling through the years, and I share a night-time Athearn photo shoot with F-units and the full moon.



Also see the new "What's neat this week" weekly video podcast!



▶ PHOTOS AND VIDEO OF SUPERB MODELS

WHAT'S NEAT | 2

George Bogatiuk interview



1. We all know George Bogatiuk from the many Soundtraxx segments he has presented on "What's Neat." Well, this month George doesn't describe one CV. No, instead we get to know George. He walks us through his beginnings in the hobby at around age 13, with Atlas sectional track on the carpet. He describes his experience working in a hobby shop through his high school years. Through college and on to a professional career, he enjoyed modeling the Missouri Pacific on this home layout.

The biggest thing I picked up in his story was the day he decided to look for a job where he could share his passion for the hobby he loves, and totally enjoy going to work every day. That's the time he met Nancy at Soundtraxx. She identified George's qualifications right away and suggested that he get the real estate section of the newspaper and start looking for a house in Colorado.



Also see the new "What's neat this week" weekly video podcast!



WHAT'S NEAT | 3



2. George models the Missouri Pacific in the southern Missouri-northern Arkansas area. He has a good eye for building structures and has become an expert at DCC and all types of DCC systems, decoders, and model railroading electronics.



Playback problems? [Click here ...](#)

Athearn moon shot



3-4. (Left top and bottom) This month, Chris Palomarez at Athearn asked that I shoot a full moon photograph using one of his new Southern Pacific F-units. The F unit was a dummy model that needed its headlights lit for the shot. I did this by adding a set of mini incandescent bulbs to the unit's front and powered them with an AA size 1.5 volt battery. I waited for the day when the moon would rise full in the east and set up the trestle diorama that we made for a past "What's Neat" video. I also added a row of desert hills beyond, as seen in the set-up photo. With the camera set for "Bulb" at 100 ISO and the lens aperture at f/22, I shot the scene in 1 to 2-minute exposures as the moon moved into position.



[Click here to rate or comment on this article](#)

Want to help keep
MRH free?

Then *click* on ads!



Also see the new "What's neat this week" weekly video podcast!



Build a Locomotive cradle



5. A locomotive cradle is an essential tool to hold models safely when doing repairs, decoder installations, or simple coupler replacement. I have three examples in this photograph. The large-scale cradle is lined with a bath towel. An N scale cradle is made from a piece of foam carved out and lined with felt, and the HO scale cradle we will build for this article.



[Click here to rate or comment on this article](#)



Also see the new "What's neat this week" weekly video podcast!

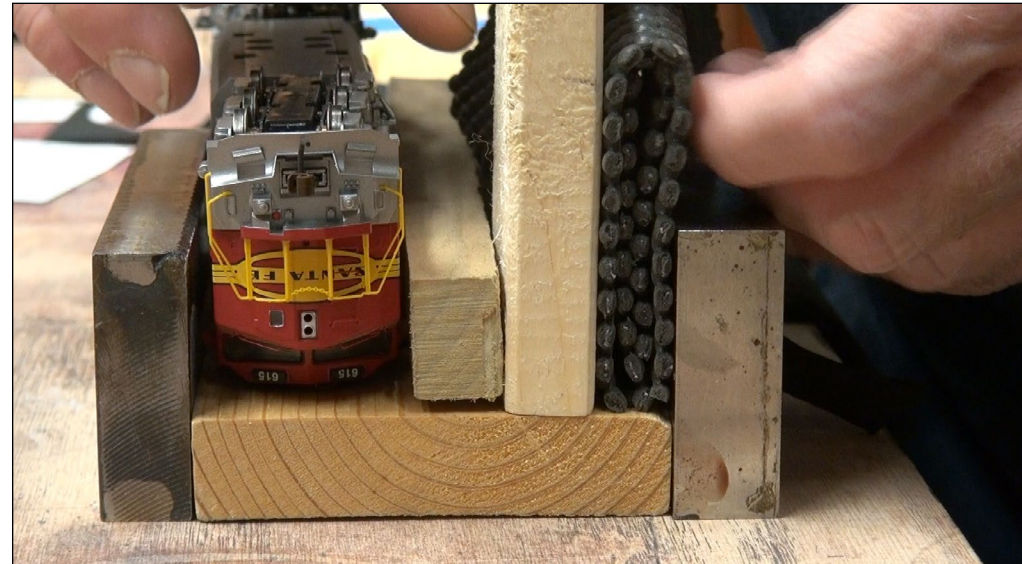

6. Using a scrap 1x4 for the base, I measured the width of a locomotive with sunshades. Then I figured the dimensions for the cradle's walls along with the thickness of the drawer liner made from synthetic rubber. In HO scale the clearance side to side needed to be 1¾ inch to clear the locomotive sunshades.



7. Once I had all the side dimensions, I measured the longest model I had on hand to figure the length of the cradle at about 15 inches.

WHAT'S NEAT | 8



8. I made the side walls about 1½ inches high, then proceeded to cut the base on a radial arm cutoff saw. The sidewalls were run through the band saw. After test-fitting the pieces together to form our cradle, I used wood screws to assemble the new locomotive cradle.



9. I stained our new tool with my favorite red oak stain, then applied a few coats of polyurethane for a nice shiny finish.

Have you seen this?



CHECK IT
OUT!

kenpatterson.com

click here to ...

Visit Ken's website

**Ken Patterson
reveals his modeling
secrets on video!**

WHAT'S NEAT | 9



10. I used a box knife and a straight edge to cut strips of drawer liner material to fit in the cradle, providing a soft cushioned surface to the wood. I spread clear silicone adhesive to the inside walls of the cradle using a Ross painters knife. Then I pressed the black drawer liner into the silicone glue, wrapping the black material around the top sides of the cradle as seen in this photo.



11. After the silicone glue dried I applied soft self-stick felt pads to the bottom of the cradle as feet. And with that, we have a new tool for gently holding models in place during repairs or while painting trucks, wheels, or underbody details.

Got Steam?

**Full Throttle Steam
Available Now!!!**

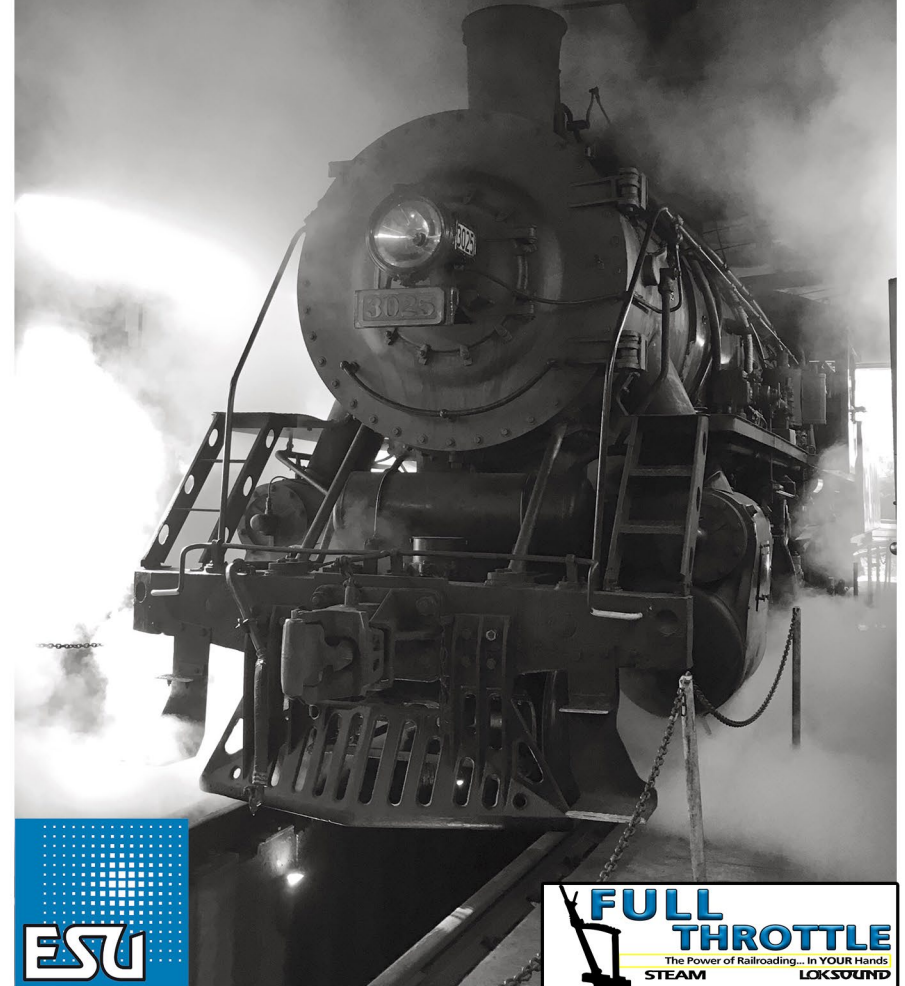

ESU

FULL THROTTLE
The Power of Railroading... In YOUR Hands
STEAM LOKSOUND

www.LokSound.com

WHAT'S NEAT | 10

InterMountains Tier 4 locomotives



WHAT'S NEAT | 11



12-15. This month we look at three models Dirk Reynolds brought over to photograph one sunny afternoon. They are InterMountain's HO scale Tier 4 locomotives made by GE to conform to the USA's EPA pollution standards effective in 2015.

The models have full sound from ESU LokSound along with details that include wheel bearings that turn, chain details above the trucks, radiators, screens, and vents that give the model a spaceship-like appearance. The road names we had on hand included CSX, NS, and UP. The paintwork was clean and bright on all three models. The models ran smoothly on the indoor layout with ditchlights and headlights that effectively light the way ahead of the locomotive just like a small flash light. In this month's video you can hear the sound system, see the headlights and watch the locomotives run. Since that photo shoot day, I have been running the CSX model on my layout every day five or six hours for about 10 days and it has been working perfectly with no derailments or overheating. Check them out at your favorite hobby shop. They are worth a look.



Also see the new "What's neat this week" weekly video podcast!



Ron Pare Builds A ITLA Scale Models laser kit

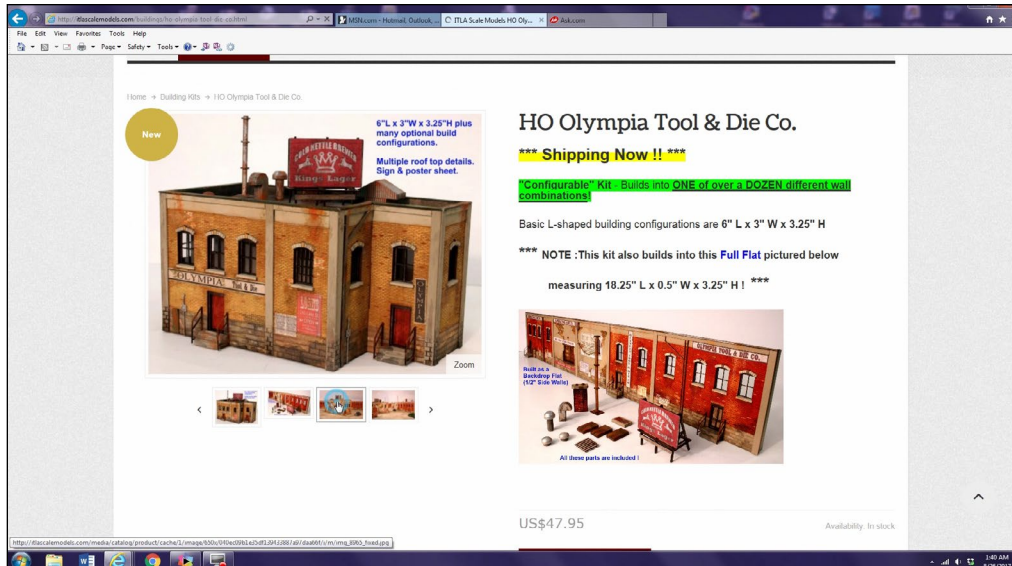

16. (Above) Our friend of the show, Ron Pare, came all the way from Canada to build an ITLA Scale Models Olympia Tool and Die Co. kit. This laser model is built from thick plywood that will not warp when painted. The smartly-designed kit can be painted and built in about three hours.

17. (Top right) The one thing Ron did over and over while building this structure was to mix acrylic paint colors on a tile before applying them to the building's walls. I was very impressed with this technique, as it allowed him to make any color fast.

18. (Bottom right) After painting all the walls with small paint brushes, Ron applied a clear coat to the brick finish, leaving a yellow brick effect. Ron painted the window frames and the trim with a brush before applying these parts to the flat walls.



 [Click here to rate or comment on this article](#)



Also see the new "What's neat this week" weekly video podcast!



WHAT'S NEAT | 14



19. The assembly of the walls went quickly using Elmer's white glue for the entire gluing process.



20. Ron painted the roof and built all the separate detail parts that include a sign for the top of the building.

WHAT'S NEAT | 15



21. Ron also applied the signs supplied for all the building's outside signage, installed steps below every door entrance, and added smokestacks and vents to finish the structure.

**Did you know
there's an
MRH index
available?**

[CLICK TO FIND OUT MORE](#)



Also see the new "What's neat
this week" weekly video podcast!



WHAT'S NEAT | 16



WHAT'S NEAT | 17



22-24. We then took the building outside and photographed it in an urban set-up with cars and people to finish the shot. It looks pretty good and was built in less than three hours. ☑



TrainMasters TV is part of the MRH product family.

TMTV members not only get great network TV level videos, they help pay for MRH and keep it free ...



Also see the new "What's neat this week" weekly video podcast!





MRH MARKETPLACE

Add incredible depth to your layout in less than an inch of space

FREE SAMPLE DOWNLOADS **CLICK HERE for more ideas** **N Scale HO Scale O Scale**

TRACKSIDEFLATS.COM
Backdrops, Background Buildings, Downloads

CROW RIVER PRODUCTS

NEW O SCALE KIT 335 A – LATHE
FIRST IN A SERIES OF VINTAGE MACHINE TOOLS

HO & O Scale Machinery, Derricks, Engines, Hardware & Waterfront Models
Pawtucket, RI 02861 Tel 401-723-0065
www.crowriverproducts.com
We Accept Visa, Master Card, Discover or PayPal
For the Layout or the Display Shelf

LOOK at what's new at **Black Cat** this month **Click here for our website**

CNR post'61 box cars
40 foot 10' & 10' 6" IH
with wheat sheaf In N scale

Black Cat Publishing
(204)489-5005
ajfergus@mymts.net
blackcatdecals.com

WESTERFIELD GOLDEN AGE LINE
MODELS, LLC

NOW Available S-40-2/3
Pressed Stl U/F Stock Car
SP/UP and Subsidiaries

westerfieldmodels.com

THE DCC SHOP
YOUR COMMAND CONTROL SPECIALISTS
www.DCCSHOP.com

PECO 83 LINE Quantity Pricing for the Layout Builder

NCE The Power of DCC

DiGiTrax Complete Train Control

TCS WOWSound

HO Brass

Start your model railroad empire on the right track with **THE DCC SHOP**

The Little Train Store that is **BIG** on Customer Service!

www.DCCSHOP.com
ph. 208-889-9111

Kadee

Coupler Conversions

Newer models with factory knuckle couplers are easily converted using the Kadee® #148 Whisker® Couplers.

Kadee HO SCALE

Conversion Info Click Here

TAM Industries
"Preserving the Romance"

The highest quality in Display Cases for sharing your excitement of Model Railroading. We manufacture Display Cases for all gauges of Model Railroading, from "G" to "N". Custom Sizes are available for some styles.

Visit us today at:
www.TAM-IndustriesOnline.com

CANYON GREEN SCENES

GREAT LOOKING TREES MAKE ALL THE DIFFERENCE

Come visit our booth at Trainfest in Milwaukee, Nov 11&12.
We'll have a show special discount!

LOGIC RAIL TECHNOLOGIES "Sophisticated Model Railroad Electronics"

21175 Tomball Pkwy Suite 287 Houston, TX 77070
Phone: (281)251-5813
http://www.logicrailtech.com
info@logicrailtech.com

Fall Orange csp

Trees

PRE-SIZE MODEL SPECIALTIES

P.O. Box 6 Paonia, CO 81428
Ph. 970 527 4586
Made in The USA

Cast resin items for All Scales.
Tunnel portals, bridge piers, abutments, culverts, and retaining walls.
Trackside details and sage brush tree armatures.

"FREE SHIPPING see website for details"

Where the Rail Meets the Sea...



CRAFTSMAN KITS & BUILT-UPS
HO - O - N Scale



NEW! H148-HO Police Boat "Lannan" Tug Exeter
www.seaportmodelworks.com
Click here for our website:

BenchWork.com
To build your dreams, You need a plan!
Affordable track planning
Starting at only \$250
CLICK ME to get started!



Yarmouth Model Works
HO scale resin kits and detail parts

U.S.A. MAILING ADDRESS
2014 Holland Ave Unit 617
Port Huron, MI 48060
Tel. 519-633-7574
pierre.oliver@elgincarsshops.com
www.yarmouthmodelworks.com

CANADIAN MAILING ADDRESS
263 Sunset Dr.
St. Thomas, ON N5R 3C4

BenchWork.com
Your #1 source for **TOMA** Benchwork
250+ shapes & sizes!
Built to order benchwork also available! (224)201-9868

Your ad could be in
this space for as low
as **\$58 a month.**
Click to learn more ...

**MAIN STREET AMERICA
HISTORIC ARCHITECTURE**

MAIN STREET HERITAGE
www.mainstreet-heritage.com
CLICK HERE for all our HO & O kits

Great Decals!TM
FEC, Interstate, Virginian
Railway, & L&N Titles
After Hours Graphics Line
Coupler Gages and More
In O, S, HO, and N Scales

MOUNTAIN SUBDIVISION HOBBIES
www.modelrrsupply.com
FREE USA SHIPPING OVER \$39.00

NCE - SOUNDTRAXX - DIGITRAX - ESU LOKSOUND
SPROG - DCC SPECIALTIES - INTERMOUNTAIN - CMX
BAR MILLS - BOWSER - ATLAS - CIRCUITRON - PECO
RIX - PIKESTUFF - CENTRAL VALLEY AND MORE!!!

Model Railroad Control Systems
Geoff Bunza Project Boards
DCC Occupancy Detectors
CMRInet Compatible Nodes
Layout Telephone Systems
RFID Switchlist Generator
Switch Machines and Drivers

Click Here

RULERS-of-the-WORLD
Scale Rulers \$4 each
Over 200+ scales!
Metric or Imperial
www.rulers-of-the-world.com

2018 Trolley Calendar
Full color cover and 13 B & W photos
East Penn Traction Club
c/o Charles Long
227 Locust Road
Fort Washington, PA 19034-1425
[click HERE to learn more](#)

PRECISION DESIGN CO.
LASERCUT KITS - CUSTOM DECALS
PDC.CA
Authorized **RailPro** Dealer
FREE SHIPPING in the US and CANADA

Imagine that!
Laser Art Products
ITLA Scale Models
York Industries
HO Scale Laser
Cut Wood Kit

CLICK HERE FOR MORE INFORMATION
www.itlascalemodels.com

GOODDEALSDCC
WWW.GOODDEALSDCC.COM

HOME OF THE
PROGRAMMER TEST TRACK SYSTEMS
GARY COHN GARY@GOODDEALSDCC.COM

Low Angle Smartphone Photography

*Tips and techniques for
creating realistic layout
photos, in three steps ...*

1. The low lens position of a smartphone, its ability to produce high-quality photos, and inexpensive software allow creating ultra low angle photos that give the illusion of extreme mass. In this shot on the author's switching layout, Los Angeles Junction CF7 2619 idles just shy of the Corona Avenue grade crossing.

BY LANCE MINDHEIM



[Click here to rate or comment on this article](#)

ONE OF THE ATTRACTIONS OF RAILROADING IS the sheer mass and power of the equipment. No matter how many times we watch a train pass at a grade crossing, the thrill of seeing something that big roll by never wears off. As modelers, we put a lot of effort into trying to replicate that sense of size and weight. The challenge we face is creating the illusion of mass, making something look like it weighs tons, not ounces, when our subjects are in reality just small chunks of lightweight plastic a few inches long.

The beauty of our hobby is that it lends itself well to creatively interpreting, capturing, and presenting our work through the lens of a camera. Our imagination is the only limit in terms of how to frame and “see” our hard work. The camera offers us ways to look

**Use our custom
Google search on the
MRH website to find
topics of interest**

[CLICK TO FIND OUT MORE](#)



2. Even when placed flat on a layout, the center of the lens on a typical SLR camera is a full inch and a half above track level. That works out to almost 11 scale feet in HO.

at our models that are not possible with the naked eye. Within that photographic bag of artistic tricks at our disposal is the illusion that, related to the fact that the lower we drop the camera angle, the larger our subject appears. If we can position the lens close to a scale viewing height above track level (three quarters of an inch in HO) the images become more and more realistic. If you can get the lens even lower, the illusion of apparent mass increases even further.

Low point of view

The physical dimensions of the typical SLR camera are an obstacle. Even when placed flat on the rail without a tripod, the lens is still too high. When placed on a flat surface, the lens on my Canon Rebel sits about an inch and a half up. This is almost a scale 11 feet in HO. Unless the shot can be taken from the aisle with the camera dropped to a scale viewing level, the shot will seem a little “off”. Subconsciously we register that the image viewing angle is higher than what we see when we’re out in the field.

LOW ANGLE SMARTPHONE PHOTOGRAPHY | 5

Enter the smartphone camera. It has two features that work to our advantage. First, its lens position is low enough to position at a scale viewing height, or even lower. On my iPhone 6s Plus, the lens is only 3/8" from the edge of the phone, a scale three feet in HO. Second, the quality of the images is as good as many SLR cameras. The small physical dimensions of the phone allow it to be placed where a larger SLR won't fit.

When we combine the low lens position of a smartphone, its photographic quality capabilities, and a simple software program, an entirely new world opens up and allows us to produce ultra low angle photographs that instill a sense of mass in our models. Three steps are involved in composing and producing a low angle smartphone image:

1. Securely anchor the camera in position.
2. Take a handful of images, each with a different focal point.
3. Use software to combine, or stack, our images into one photo with continuous depth of field.

Secure the camera

As with traditional model photography shutter speeds are such that, if the camera is not secured when the shutter is tripped, we get motion blur in the image. Because we are taking a number of photos at different focal points, it is crucial that each shot be taken from exactly the same position for the stacking to work. Clearly, for what we're doing, a tripod does not work so we need to find another way to secure the phone. I experimented with a number of commercial phone holders and found that a simple jury-rigged arrangement of a spring clamp and scrap weight worked best. A small "Quick Grip" clamp and weight also works.

LOW ANGLE SMARTPHONE PHOTOGRAPHY | 6



3. The first step is to securely position the camera. Don't laugh. Sometimes low tech trumps expensive equipment! After several experiments, I found a simple spring clamp and scrap of steel work better than more expensive holders, and you can't beat the cost.

Take several photos, at different focus points

When you look through the lens of a camera, portions of the image will be in sharp focus and others will be soft. The length of those areas in focus is called depth of field. By changing the focus point of a typical SLR camera we can control which areas will be in sharpest focus, but for most compositions and particularly with model close-up photography, it's generally a case of whack-a-mole. As we bring one area into focus, another becomes blurry. Focus on the horizon, and closer elements are blurry. Focus up close, and objects in the distance are blurred.

LOW ANGLE SMARTPHONE PHOTOGRAPHY | 7

We want to have our cake, and eat it too. We want everything to be in focus, from a few inches in front of the lens to the horizon. How do we defy the laws of optics and do that? Fortunately, there is now inexpensive, simple to use software on the market which allows us to take several images, each at a different focal point, and then combine or stack them into one image with continuous depth of field. I'll discuss the software in a minute but the first step is to take the photos. Depending on what I'm shooting I'll generally take four to seven pictures, each focusing progressively farther out from the camera. If I'm taking more images, I generally front-load them with more photos focused at close distances and just a few focused farther away.

The iPhone allows you to control the focal point by gently tapping the camera screen. When you tap, a yellow square will appear showing the area you have chosen to be in focus. We want four to seven images. To start, I place the phone six inches or so from the front of the locomotive. Tap the phone screen to set the focus point for the first shot. I generally start with closest focal point first (roughly two inches with my iPhone) but the order you take the pictures doesn't matter.

What does matter is that you end up with a series of images, from up close to the horizon, to capture the full depth of field. For example, the first picture has areas in focus from two inches to three inches, the next captures areas from two inches to three inches out, and so on. Make sure at least one shot has the locomotive cab in crisp focus. There is some trial and error but the process goes quickly. If you find out you missed a focal point in your series, it only takes a second to do a re-shoot.

For this process to work, the camera must be totally still and stay in the exact same position for all the shots. Initially, I used the timer feature to minimize camera movement but found the

LOW ANGLE SMARTPHONE PHOTOGRAPHY | 8

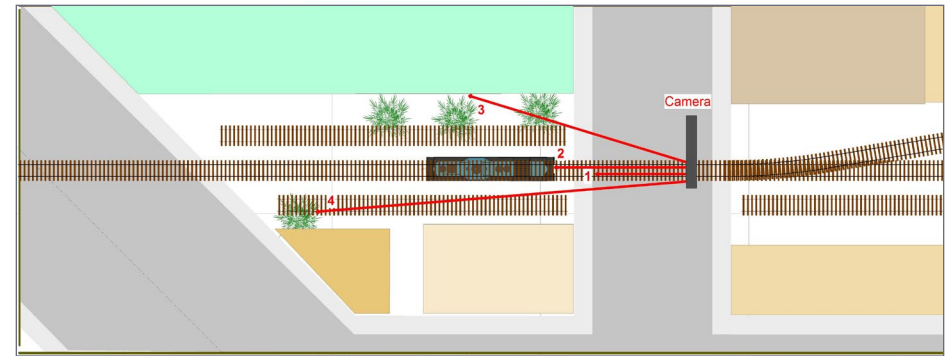

4. The above diagram shows the four focal points I used for the lead photo [1] in this article. Some trial and error is involved and you may find you need a few more shots to capture the full depth of field.

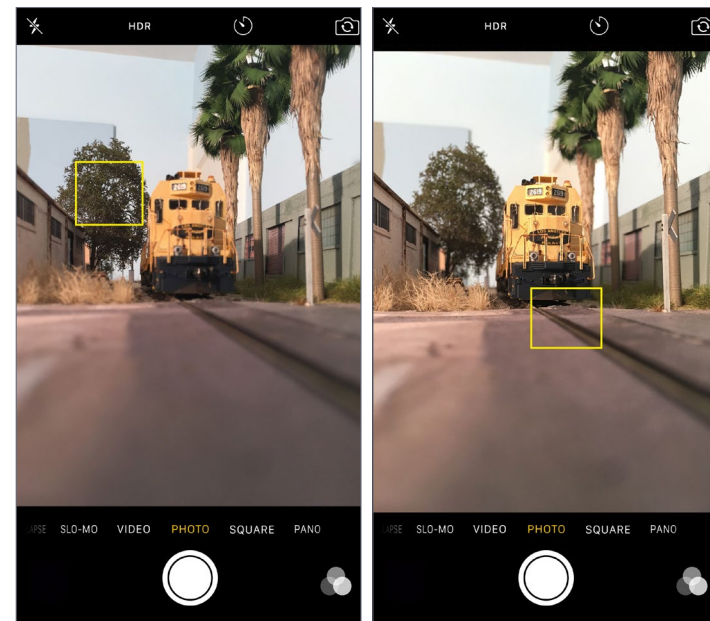

5. Here you can see two of the images in the sequence as seen through the iPhone lens. The shot on the right was focused as closely in as possible – in this case about two inches. In the left shot I focused on

the tree in the distance. Tapping the camera screen sets the focal point, which will be highlighted with a yellow square.

LOW ANGLE SMARTPHONE PHOTOGRAPHY | 9

mounting method was secure enough if I used a soft touch to tap the shutter release. If you use the timer function on an iPhone, it has the maddening habit of switching into burst mode and taking ten clips of each image. You can override burst mode by turning the HDR button on. Doing so will reduce the number of clips from 10 to two – one HDR, one standard.

Merge the images

At this point, we have a series of images, each taken with the camera securely anchored in the same position. The last step is to use software to combine, or stack them, into one picture with continuous depth of field. Although traditional photo editing software will allow you to do this, it requires jumping through substantially more hoops. Dedicated software is dirt cheap and much simpler. I use Helicon Focus which costs \$30 for a one year usage license. Find it at heliconsoft.com/heliconsoft-products/helicon-focus. When many of us hear “you’ll need special software,” it’s only human nature to immediately shut down and run as quickly as possible in the opposite direction. Keep an open mind with this one -- once you have it on your desktop, you’ll find Helicon Focus to be one of the simplest, most-user-friendly programs you’ve come across. It just takes a couple strokes on the keyboard to use.

We are going to drag the images we just took onto the work screen of the program, hit a “Go” button, and we’ll be done. Not too hard. Open Helicon Focus on your machine. Click “file,” and then “open.” Go to where you have your images stored, and open the first shot. It will appear on the Helicon Focus work screen. Drag it into the upper right pane labeled “source images.” Repeat until every shot you took is in the source images pane. Next, hit the “Render” button and watch the program work its magic. In a few seconds you’ll see the final “stacked” image appear on your screen. Save it. That’s

LOW ANGLE SMARTPHONE PHOTOGRAPHY | 10

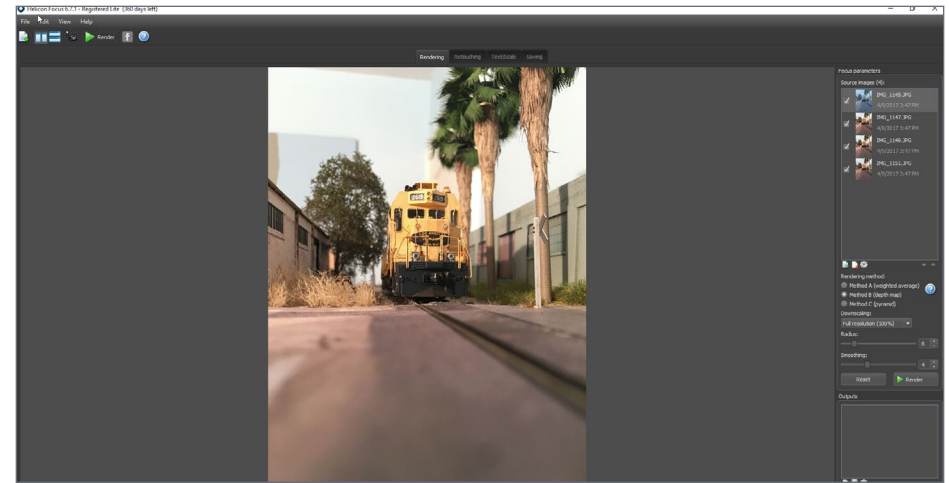

6. This is the work screen of the Helicon Focus program. It’s very simple to use. Open a shot, drag it to the right source panel box, repeat for each image, and then hit “Render.” Make sure to save your work.

it. All done! It doesn’t get much easier ... 1) open file, 2) drag to right panel, 3) hit “Render,” and 4) save the image.

When starting out with Helicon Focus and other stacking software, when the final stacked image appears on your screen it’s common to find that you missed a focal point. It will show up as a fuzzy, unfocused area somewhere in the image. If this happens, re-shoot the series and take care to not miss any focal points.

Final editing notes

Any digital photo will benefit from additional editing. The first step is cropping the image to cut away extreme foreground areas that aren’t in focus. Tighter cropping also makes the central subject more prominent and increases the sense of mass. Next, make any necessary edits needed for color correction or brightness. I’ll



7. CSX 2771 crosses 14th Avenue on the author's Downtown Spur (Miami) layout. The shot was created using seven images shot with an iPhone 6S plus and then stacked with Helicon Focus photo editing software.

LOW ANGLE SMARTPHONE PHOTOGRAPHY | 13

generally do a light overall brightness adjustment first, then go back to highlight specific areas with the editing selection tool, and make further brightness refinements. I find that the appearance of model photos can be improved dramatically by cropping away the real world background which often includes room windows, doors, etc., and replacing them with a generic sapphire blue cloudless sky. I use a dedicated background removal plug-in but you can use the tools that already come with a decent photo editing program.

I've spent more time on this technique since initially writing this article. I now use a remote-Bluetooth-shutter release to take the shots. See the last two photos using this technique. ✓



[Click here to rate or comment on this article](#)



8. Remote shutter releases, such as the one above, are inexpensive and allow you to take shots without touching the camera. They are set up through the phone's Bluetooth settings.

LOW ANGLE SMARTPHONE PHOTOGRAPHY | 14



9, 10. Two photos taken with the remote shutter release.

WHAT ABOUT ANDROID DEVICES?



The iPhone has been the popular choice among smartphone users for more professional “on the road” still photos and videos using personal mobile devices. For this reason, companies have been eager to develop apps and accessories that are iPhone-compatible.

Android phones occupy a larger share of the market these days, but there are such a plethora of models out there that there is a lot less incentive to make photo accessories for Android phones. On the apps front in recent years, the Android app *Camera FV-5* (\$4) gives you complete access to your phone’s camera settings in a way that feels very DSLR-like.

Using the pro version of the Camera FV-5 app on a newer Android phone should allow you to take photos with the focus set to different points in the field of view as Lance describes, as well as adjust other settings on your phone camera such as ISO, exposure, and white balance.

Once you have your photos on your Android device, you can either move the photos to a PC or Mac to do photo stacking as Lance

describes, or there is even a focus-stacking app for Android devices called Stacking Photo (free). With the photo-stacking app, you can even create the stacked photo with increased depth-of-field directly on your Android device. •

Joe Fugate, MRH Staff.

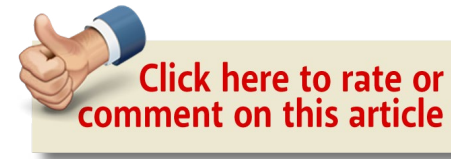

LANCE MINDHEIM



Lance Mindheim is a frequent contributor to *Model Railroad Hobbyist* and *Model Railroader*. He’s also the owner of The Shelf Layouts Company, Inc. a custom layout building and design firm, and blogs on design, construction and other model railroading topics at shelflayouts.com. Lance lives in Silver Spring, MD and has one grown son, Zachary, who often accompanies him to model railroading events.

MRH Subscribers ...

SAVE 10%!

On everything we sell.

Click here

MRH subscribers, get your
10% off coupon code

You must be an MRH subscriber to access



**Model Railroad
Hobbyist Store**



Model Railroad Hobbyist | November 2017 | #93

YES, IT'S A MODEL

compiled by
DON HANLEY
.....



**Click here to rate or
comment on this article**



1. Remnants of a nearby branch line are now used to hold cars while the crew switches the industries. To the right of the covered hopper, the line abruptly ends. Eugene Griffin needed a believable O scale scene

for the end of his line, so he was inspired by a prototype example: revenue from the line on the other side of the river was not sufficient to maintain the bridge so that part of the line was abandoned.

► **MRH'S MONTHLY PHOTO ALBUM**



2. It's a hot summer day in Lakeside Valley. MILW train #110 emerges from the last tunnel and applies the brakes as it approaches its final destination. The photo was taken by Jure Sporn on his freelance HO Wausau & Wester layout representing a Milwaukee Road subsidiary. The locomotive is an Athearn RTR F7 A+B model that has had details added and was weathered with oil paints, an airbrush, and dry pigments. Jure weathered the loco set following a prototype picture.



Click here to rate or comment on this article



.....
\$ GET PAID FOR YOUR PHOTO

We pay \$40 per photo we publish. If you'd like to get your modeling in our photo feature, just start posting your photos on the MRH website, especially in the Weekly Photo Fun thread created each week.

See mrhmag.com/help for more on how to post an image. You need to be an MRH subscriber to post photos to our website, and becoming a subscriber is free, [just fill out this form here.](#) ■



St. Thomas on the Canada Southern

BY RON PARE

Painting and construction tips make a big project easier to finish ...

ANYONE EVER DROP A KIT INTO YOUR HANDS that you just had to build? This Canada Southern station came from my friend Dave, who thought it was too much kit and he was in over his head. This was going to be the focal point of Dave's layout. He asked me to take on the project and build it for him. He and I both lived close to the station as kids – my parents' horse farm was right along the railway line – and the building was a landmark in our part of Ontario.

I offered to mentor the build and saw it as a big opportunity to teach some easy tricks to build this sort of sprawling model. Dave had other plans ... “Ron, I got an idea. How about you build it?”

Model Railroad Hobbyist | November 2017 | #93

1. Canada Southern's big station at St. Thomas, Ontario housed division offices, local railroad offices, a passenger station, a restaurant, and living space for food servers.



[Click here to rate or comment on this article](#)

It's times like this when life can go one of two ways. Either you tell him how much a job like this would cost – or you donate your help to get this model done the best it can be.

Only seven of these kits were made, by my friend and custom kit designer Mark Williams. St. Thomas, Ontario, Canada was a “railway city” and the North American Railway Hall of Fame – now housed in this very building – commissioned the project to show the impressive station as it looked in 1904 in its prime. When completed in HO, the station is four and a half feet long.

I've made several wood kits and was advised to not paint the models, but to let the natural tones show through. The natural burn marks from laser cutting colored the wood with a realistic yellow brick look, which worked for these structures. But this one was going to be different.

This story is not a brick-by-brick guide to building the station kit, but instead shows some of the techniques I use to keep such a big project moving along, and to keep it from busting the budget. Going into the project, I wasn't planning to do an article, so some of the step-by-step photos were done later and may not match details on the finished building.

Paint the walls

This model is spray-painted burnt orange with rattle cans. The paint I had on hand was semi-gloss. I would have preferred a flat finish, but in a later step we'll add matte medium so gloss paint was not a deal-breaker.

As an experiment I painted half of one brick panel flat burnt sienna and sprayed the other half with burnt orange semi-gloss to demonstrate the difference. Once covered with matte medium, the gloss will disappear.

Applying mortar

After allowing the paint to dry for 24 hours, I used an accidental discovery to make mortar for the bricks.



2. A spray can provides the primary brick color and craft acrylics are used for detailing.

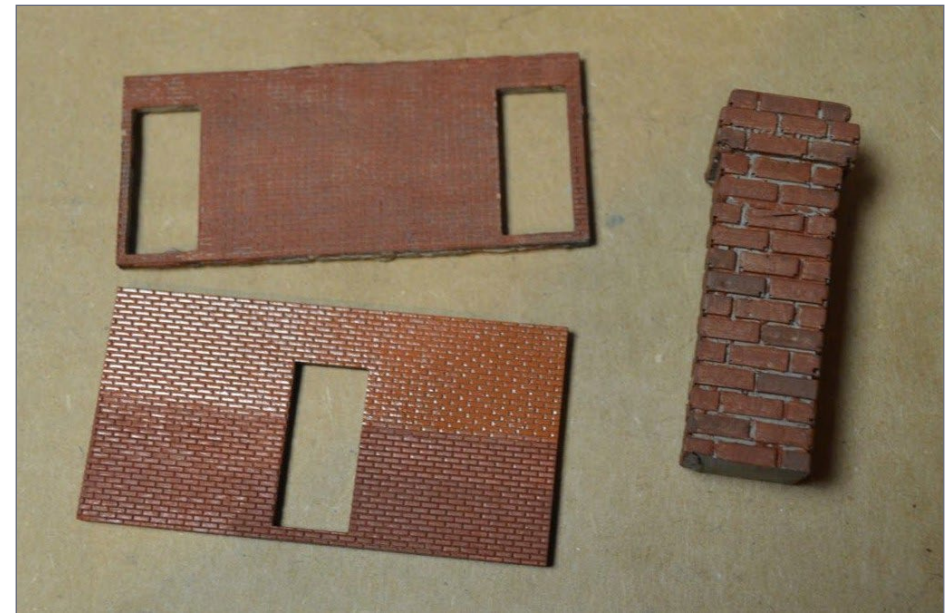

3. Getting mortar to look right is a challenge – there can't be too much or too little, and the lines can't be too dark or too bright.

Earlier this year I purchased some Ultra Matte Medium by Liquitex, and then stumbled on a wet water trick that I ended up using on this project. I was applying static grass into some matte medium and sprayed it with a water and dish soap solution. When it dried, the plastic sheet the grass was affixed to was stained white!

The wet water apparently affects the matting agent in the medium, causing the matte part to separate. The dish soap seems to act as a binder to the matte agent in the medium, but when mixed with water, it separates the two substances. Perfect for mortar, I thought.

I prepare the “mortar” by filling a small glass jar halfway, with four parts warm water and a few drops of dish soap. Then I follow by adding two parts of Liquitex Ultra Matte Medium to the mix.

ST. THOMAS ON THE CANADA SOUTHERN | 5

With a nice wedge brush, spread the full-strength solution matte medium over the work, then wash off the full-strength ultra matte medium using my mortar mix. This thins the solution, cleans matte medium from the face of the brick, and starts its magic on the mortar lines below.

Let it dry. It may not look like much yet, but just wait. Let it dry completely. Patience!

Wait for the first coat to dry. Once it's dry, if you check your mortar solution, you might notice white powder sediment settling out. Stir

it up now, add a second coat to your wall, and let it dry. Repeat this process until you have the amount of mortar you want.



4. Thinned "wet" matte medium is the solvent in my mortar technique.

ST. THOMAS ON THE CANADA SOUTHERN | 6

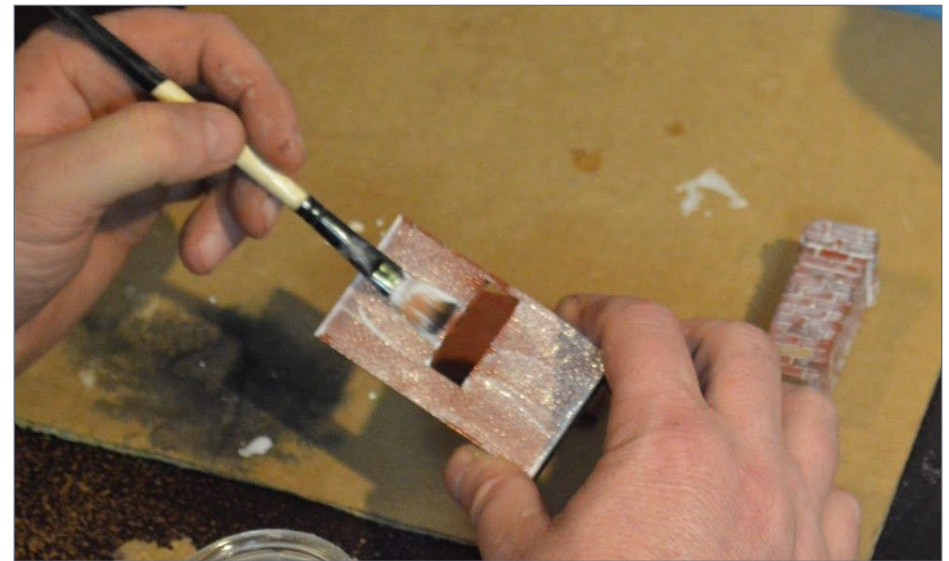

5. Brush on full-strength matte medium, and then wash over the surface with the prepared solution of water, soap, and matte medium.

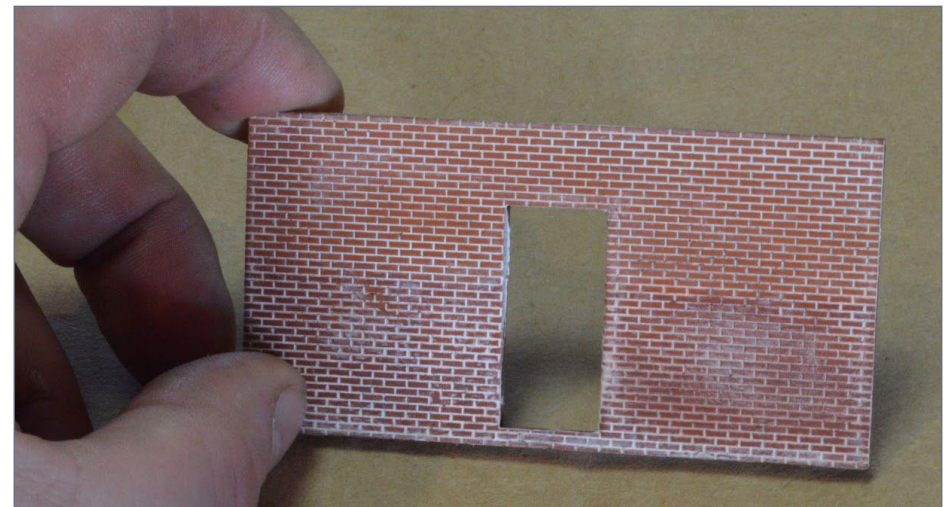

6. Ultra matte medium mortar looks crisp and well-defined without being overpowering.

Once you are happy with the mortar lines on the model, seal it with a clear coat. Normally a clear coat will “knock down” the mortar look quite a bit but this mortar seems to hold up quite well to the sealer coat.

The yellow brick challenge

Some of the decorative brickwork on the station is done in yellow, and I had a sneaky feeling that my red-brick techniques might not work as well in that color. The chimneys are really prominent [see the lead photo] and I really wanted to get them right. To meet the challenge of rendering yellow brick, I experimented and came up with this technique.

I started with an earth-tan painted chimney casting from scale-artparts.com.

Using acrylic burnt umber and burnt sienna, I wet-brushed the majority of the bricks with a half-loaded brush. Not enough paint

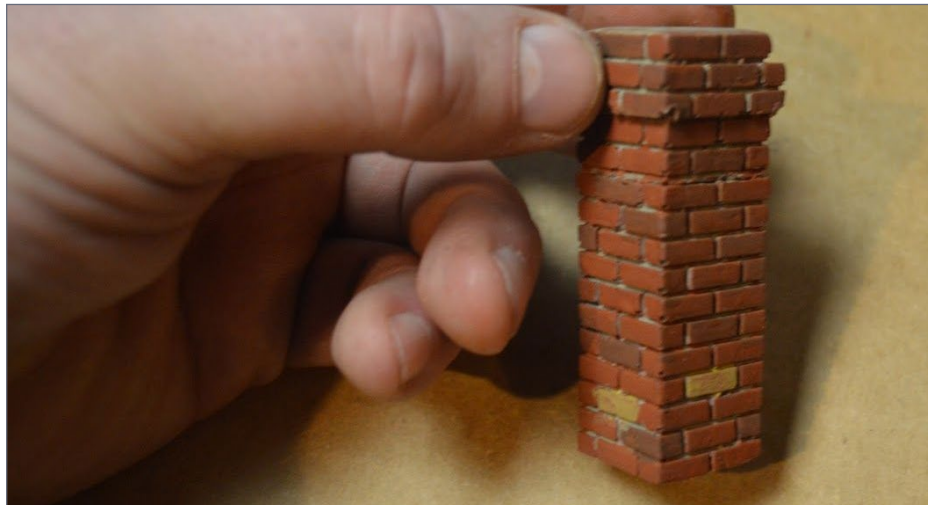

7. Wet-brushing individual bricks makes them stand out and adds texture.



8. Full strength ultra matte medium fills the mortar lines and blends the surface a little.

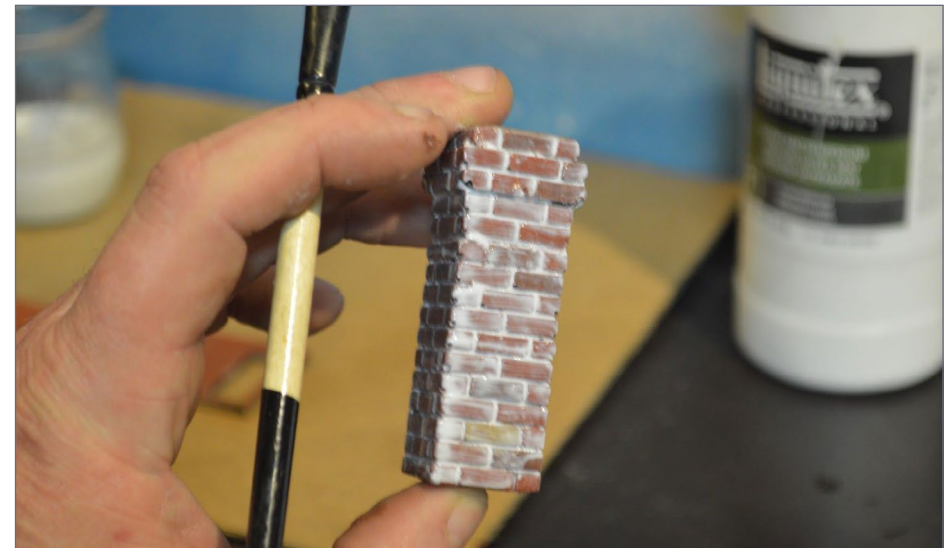

9. Apply the water/matte medium to wash the full strength layer from the brick faces, and let it dry. Check to see if you are happy with the finish. If not, add a second coat of medium and wash. I got this final finish with two coats.

ST. THOMAS ON THE CANADA SOUTHERN | 9

to cause runs, but wetter than for dry-brushing. After this had dried, I applied full-strength ultra matte medium to the casting.

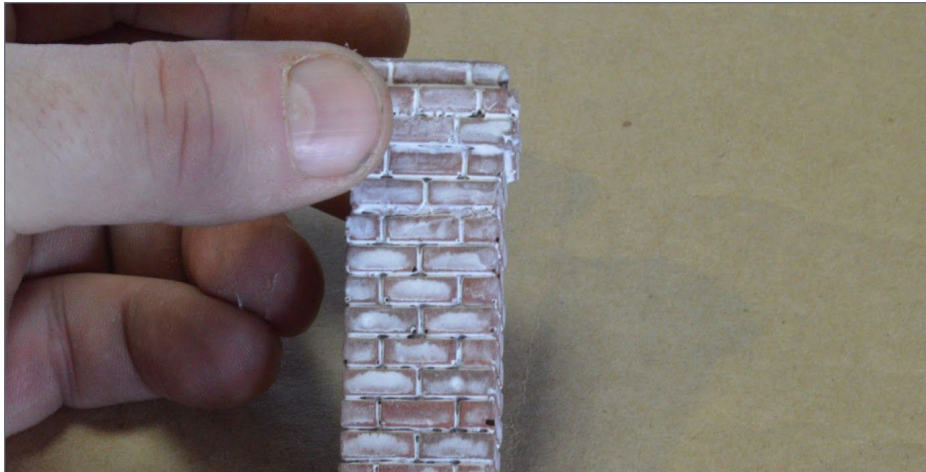

10. At this time I decided to repaint the bricks in red and yellow. I elected to dry-brush the bricks, slowly and lightly covering the bricks with burnt umber and burnt sienna, then allowed it to dry completely.



11. Here's what I ended up with: matte white still staining some bricks.

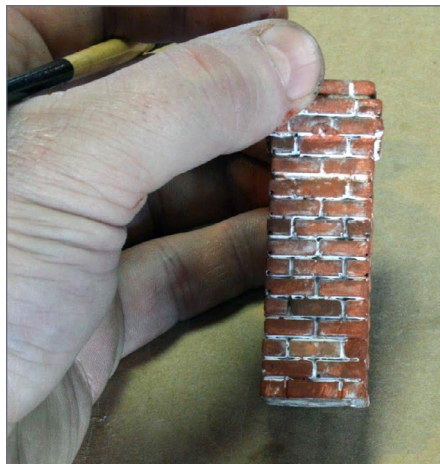

ST. THOMAS ON THE CANADA SOUTHERN | 10

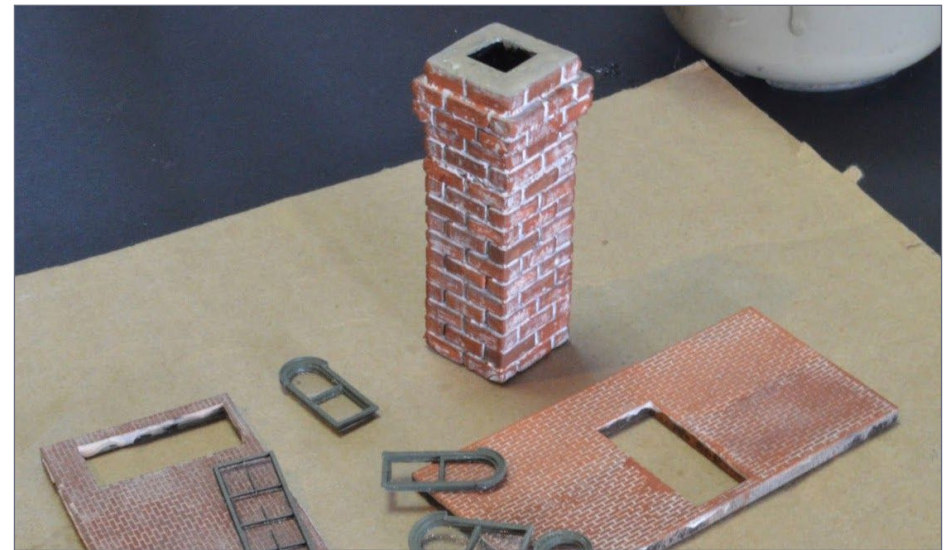

12. Using some Dr. Ben's Depot Buff Stain, I subtly touch up each brick on the chimney, going over the entire casting two or three times. This photo shows two application of the earthy yellow Depot Buff. You can stop here or keep building up the color.



13. The weathering stain builds up in thin layers and can be controlled pretty precisely.

Windows in a minute

The main windows on our CASO model are a combination of acetate windows taped to the backside of the walls, and window frames fixed in the openings. This was requested by the friend I was building the station for, and it's easily done. But that isn't how I like to do it.

I no longer use CA glue for anything near windows. It will fog them up or craze them, sometimes drastically. It isn't attractive and the effect cannot be controlled. However, CA glue works well for small details that need to stick quickly, like a roof line cornice.

The windows around the back of the St. Thomas station use a different method. I simply apply gloss medium to acetate and apply the window frames directly to the window "glass." I prefer



14. Paint a strip of acetate with a layer of gloss medium. Make the coating thin. It will not be enough, but don't fret.

this approach for its ease of use, and for the effect. You can still see through the window but the windows are not perfectly clear, which can mask the lack of a detailed interior.



15. After preparing the acetate-window frame with additional gloss medium, trim away extra acetate with a pair of sharp scissors.



16. The finished window looks transparent, but isn't exactly see-through.

In this window step-by-step, I use Liquitex gloss medium. Cut the acetate close to the width of your windows but make it a little bigger for easier handling. Make it a long strip, and trim the acetate with scissors later.

Take a brush that fits in between the window mullions (the strips that divide the individual panes). Dip it into the gloss medium and dab it into the window opening. Push the gloss to the edges but keep the total layer thin.

Flip the window so the back side is facing you and cut the excess acetate off with scissors. The scissors will easily cut along the window sides, giving a nice clean edge. The resulting windows are ever so slightly diffused but glossy at the same time – like looking at a clean window from a distance. I think they look great and it does not take long to prepare hundreds of windows for a kit like this. If your structure interior is black, they're perfect.

Final assembly

To wrap it up: Once the walls are painted and the various details and windows are installed while the walls can be handled flat on the workbench, I assemble the structure with Weldbond glue. Weldbond is my only white glue product. It's easy to find, tacks quickly, is crystal clear, and more importantly, is water-resistant when cured. These features are all critical to my modeling style. It is also inexpensive and comes in large bottles that last quite a while.

A little secret my friend Mark shared recently: Moderate heat and Weldbond will give up its grip . . . a good thing, too, as my gutter pipes looked huge after I photographed the model. I removed the dowels installed initially and replaced them with 14 gauge wire. All was fine.



17. Test-fitting the walls on the platform base, with interior dividers to help keep things square.



18. The back side of the station shows the improved drain pipes and some blanked-out window and door openings. Photos made at this stage are a good way to spot flaws to correct before final assembly. I really like the look of the station all boarded up.

ST. THOMAS ON THE CANADA SOUTHERN | 15

A serendipitous thought crossed my mind, that I had in storage a photographic prop yard that looks a lot like the St. Thomas

ST. THOMAS ON THE CANADA SOUTHERN | 16

yard of days past. I was lucky to remember it, as I hadn't really planned to do this article.



19. The C&O Alco switcher worked on those very tracks, and 20 years earlier, New York Central Hudsons ran on the line.

HISTORY

This station was the largest of 31 Canada Southern Railways (CSR) stations in Ontario. St. Thomas is the midway point for a traveler on the Chicago to New York route. It was considered a short-cut around crowded rail lines in Ohio.

It was outfitted with a restaurant and all passengers departed their trains for dinner before continuing to their destinations. The numerous young women who served the meals had their living quarters upstairs in the building.

A passenger station, traffic control, and other railway services were on the main floor. The second level was the headquarters of the CSR. Traffic control, signalling, and other railroad services were housed in the station. This was not a Canadian railway – many US railroads used the shortcut. New York Central and Chesapeake & Ohio were the main users.

The station was built with a platform roof around the perimeter to protect passengers from weather and the coal smoke of the yard. This made the structure very large and distinctive.

The station was constructed between June 1871 and April 1873. It was remarkably large for a town the size of St. Thomas, a community which didn't become a city until 1881.

In 1874, the Canada Southern Railway Company declared bankruptcy and two years later its railway line came under the control of American railroad magnate Cornelius Vanderbilt and his dynasty, owners of the New York Central Railway.

In 1883 the Canada Southern was leased to the Michigan Central Railroad, which the Vanderbilts also owned. Canada Southern

was subleased back to NYC in 1930 and amalgamated into Penn Central, along with NYC and all its subsidiaries, in 1968. When Penn Central declared bankruptcy in 1976, Conrail bought the controlling interest in the company. Passenger traffic ended on January 31, 1979.

In 1983, the railway was purchased by both the Canadian Pacific Railway and Canadian National Railway. Freight traffic through the station ended in the 1980s and the station building was gradually shut down.

RON PARE



Ron is a structure builder who specializes in wood. He builds kits and scratch built models on Youtube under the name JustanotherScaleModeler. He is also the host of the ModelersGuild website and Facebook group.



[Click here to rate or comment on this article](#)



[Click here to rate or comment on this article](#)

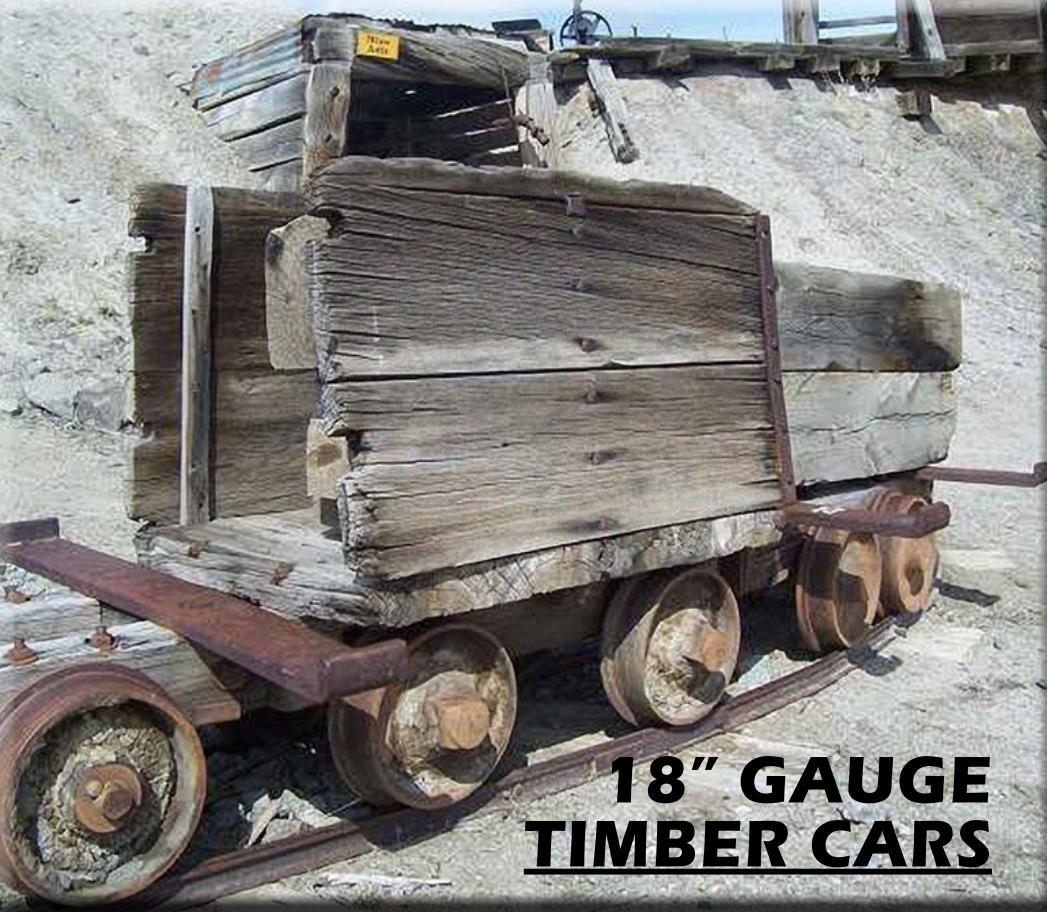

18" GAUGE TIMBER CARS

BY DICK WITNEY

1. Timber cars were used in mines to haul wood timbers as well as tools and mining supplies.

Flanged wheeled cars running on steel rail in yesteryear mining operations ...

ON OUR WAY THROUGH BUTTE, MONTANA A

I while ago we pulled into the mining museum for a quick stop. My thought was to try and find a piece of equipment that was not too complicated to measure, and quick to photograph.

The cars shown [1, 2 3] were not my first choice, but because of their simple design I finally went with them. The museum said they were used to cart wooden timbers into the mines and were called “timber cars.”

Notice they have no means of coupling together, so they must have been pushed individually. A variation on the car design had the sides, and this car was also used to haul in tools, drills, and miscellaneous mining supplies, along with timbers.

Although I built my model in F scale at 1:20.3, you should be able to build one of these models in your chosen scale.



2. Another view of these cars hauling mining timbers.

TIMBER CARS | 3

Early-on, a lot of mines used 18" gauge for the tracks into the mine, and were powered by man, so it was my desire to have some mine cars like these in the mine on my layout. In my files, I have many mining cars that could be made using these details.

I describe the various assemblies in this article along with sketches and drawings.

Axle housing

I used a 3/16" styrene tube for the housing body that I cut to a scale 15" long, which accommodates a 1/8" rod for the axle.

I made a simple jig to assemble the part as shown. I cut the 3"-wide bolting brackets from a styrene channel and shaped



3. A view of the metal straps on these cars.

TIMBER CARS | 4

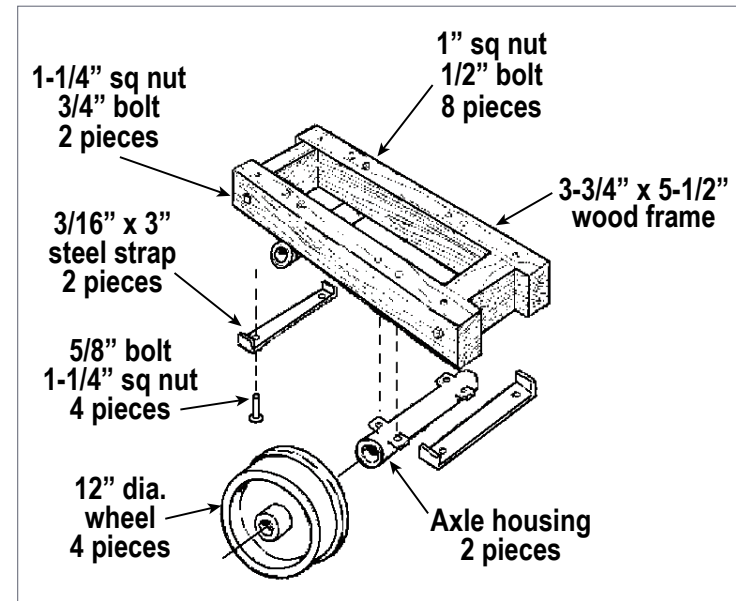

4. This perspective shows the major parts.

Please tell your buddies about MRH!

WE RELY ON WORD-OF-MOUTH TO GROW AND A BIGGER CIRCULATION MEANS MRH IS MORE LIKELY TO STICK AROUND FOR A LONG TIME TO COME!

TIMBER CARS | 5

them to be glued to the housing tube using a jig. After the first two had dried, I turned the tube around and glued on the remaining two.

I made up a 1" square nut and 1/2" bolt from styrene and glued them onto the bracket as attaching hardware. I modeled the

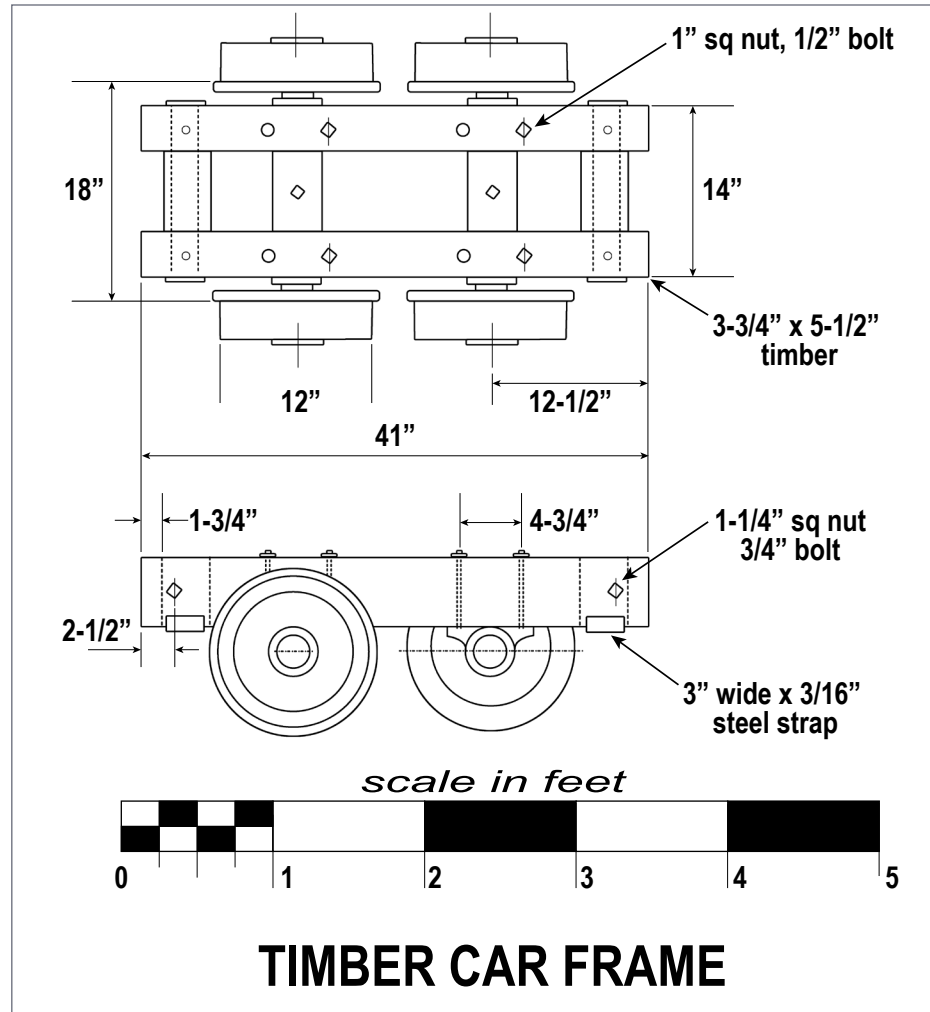

5. Plan drawing of the timber car.

TIMBER CARS | 6

grease fitting as a 0.030" square nut and a short piece of rod for the grease boss fitting.

The plastic (metal) parts should be painted before attaching to the wood frame. I will cover more about how I weathered this model later.

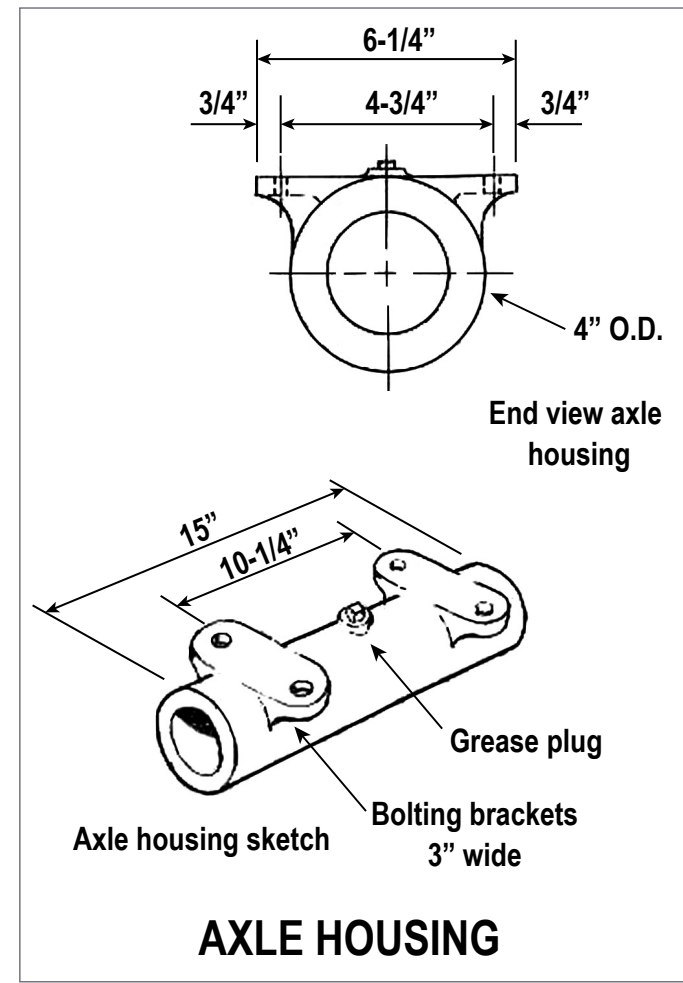

6. Axle housing dimension details.

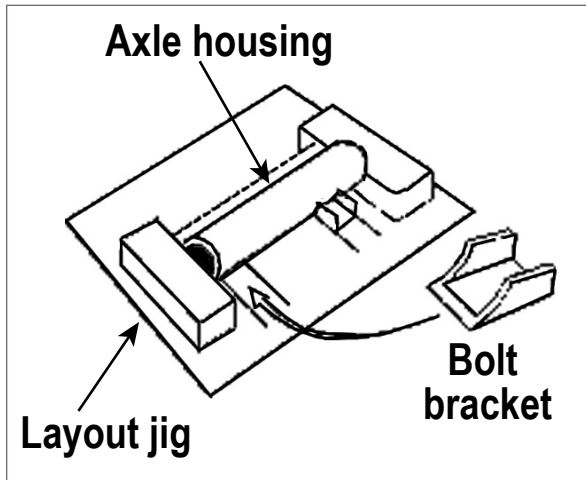

7. Jig used to add the bolting brackets to the axle housing.

I use a Superior 1/8" to 1-1/8" mini-tubing cutter to make clean and accurate cuts on plastic tubing. It cuts styrene tubing very



8. Placement of the nuts on the axle housing brackets.

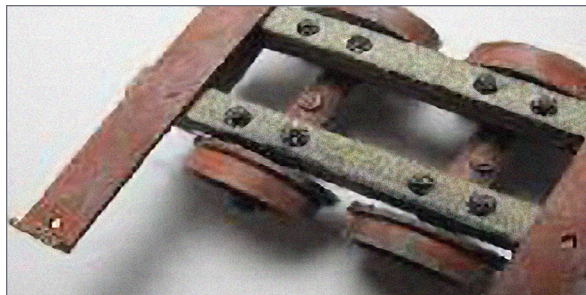

9. Note the grease boss in the middle of the axle housing.



10. I recommend a tubing cutter for cutting plastic tubing cleanly and accurately.

well. I usually try to cut small tubing by pointing the knob to the left and turning the tubing clockwise. I find cutting the other direction (counter-clockwise) sometimes causes the cutter to walk down the tube. Amazon link [a.co/amxhKTX](https://www.amazon.com/dp/B000048888), price \$12.95 (Prime).

Large scale has a shortage of bolt-nut castings, so I make my own to scale from styrene [11]. I use styrene rod for the bolt [11-A],

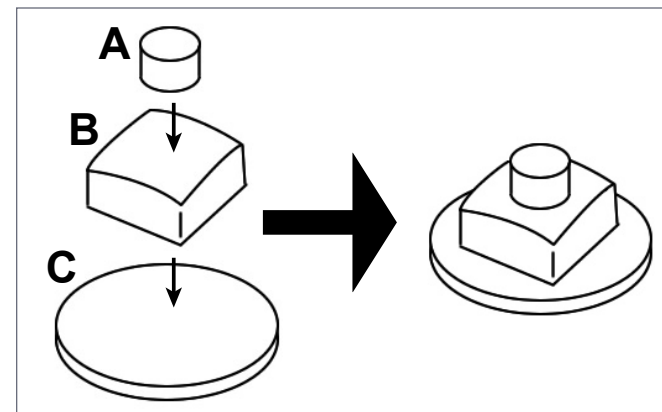

11. Making nut-and-bolts from pieces of styrene.

square styrene for the nut [11-B] and a thin slice of larger rod for the washer [11-C].

Cross bunk

Timbers and supplies were hauled on car with a steel bunk. The bunk used a flat steel bar 5" wide by 1" thick [12] with the ends turned up 1-1/2". These bunks are fastened by two 5/8"-dia. carriage bolts centered over the short cross timber on the front and rear of the car.

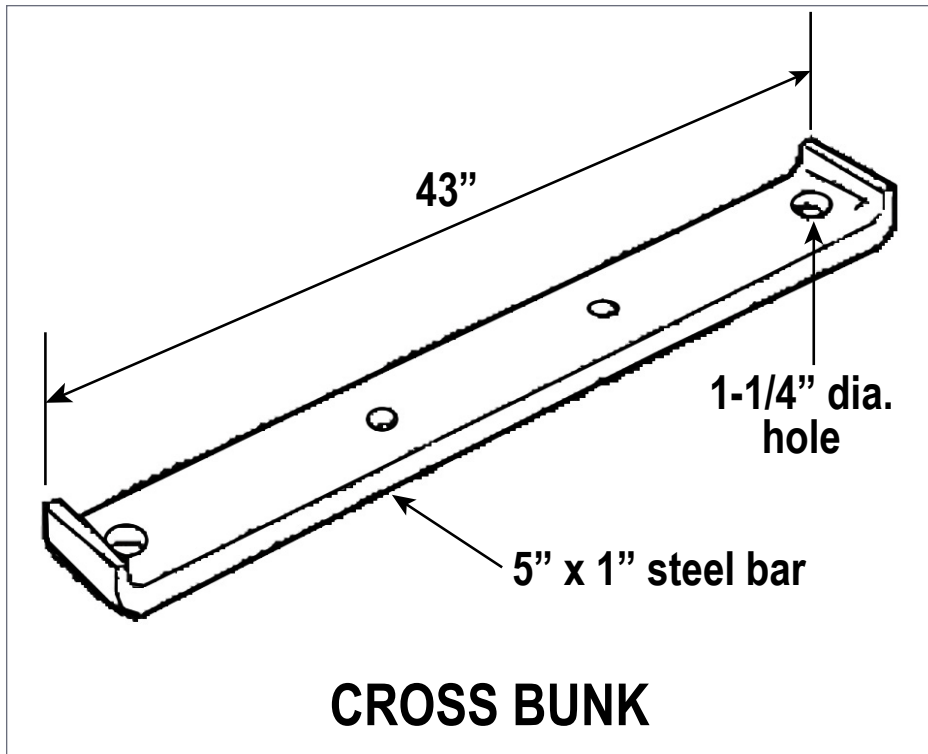

12. Steel bar cross bunk dimensions.

Wheel assembly

I used a 5/8" outside-diameter PVC tube for the tread ring on the wheel. I cut four rings for each car a little wider than the scale 3" width, and sanded each tread ring to the same width.

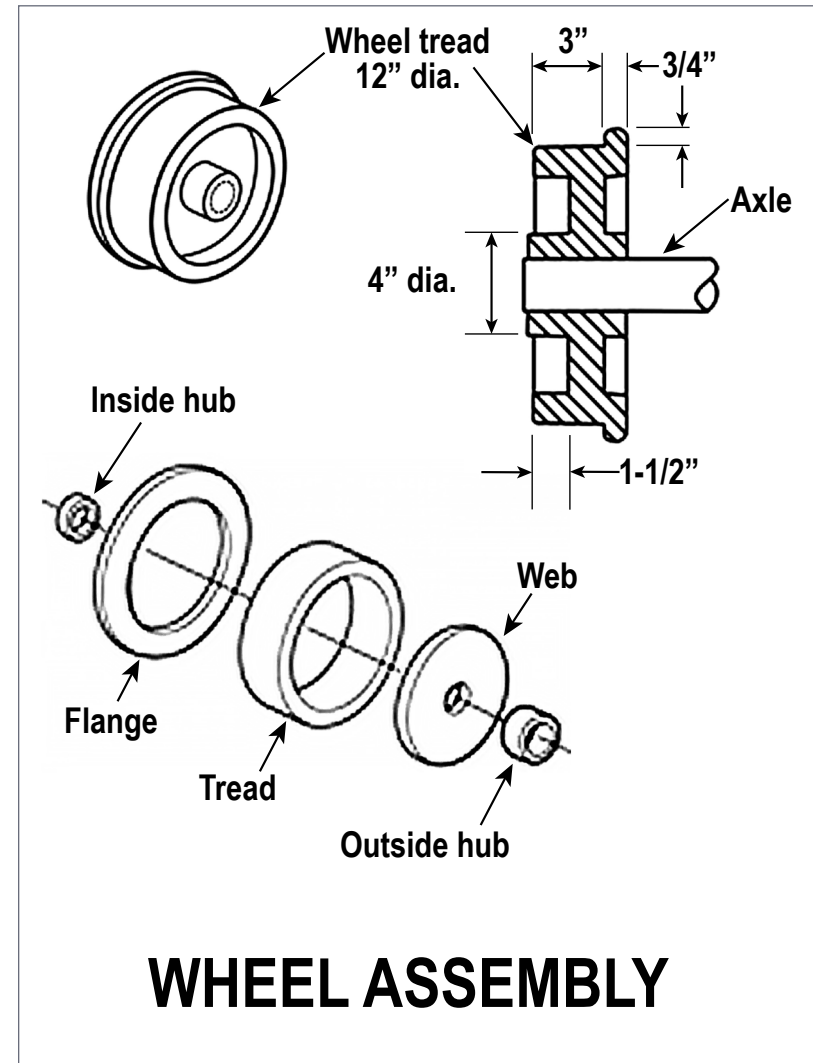

13. Wheel assembly details.

I rough-cut the flanges from 0.030" styrene sheet a scale 14" in diameter. I cut the inside of the flange ring a little less than the inside diameter of the tread ring. I glued the flange centered on the tread and let it dry. By the way, styrene will not easily glue to PVC, so I used JB Weld "Marine weld" epoxy with success.

To sand the flange to a consistent size, I made a simple tool [14]. The 1/8" x 0.040" spacer rides on the wheel tread as the flange is sanded to size. I sanded off the inside of the flange even with the inside of the tread tube. I cut the wheel web from 0.030" styrene and sanded until it was a press fit inside the tread ring.

I used a 0.070" shim to hold it back from the face of the wheel and glued it from the back. After the web dried, I drilled a 1/8"-dia. hole in it and slipped a 1/8" rod through it.

I cut two hubs from a 3/16" tube (the inside flush with the back side and the outside hub a little over the depth from the face) – see the drawing [13]. First slide the outside hub down and glue it to the web, then glue the rear hub to the web.

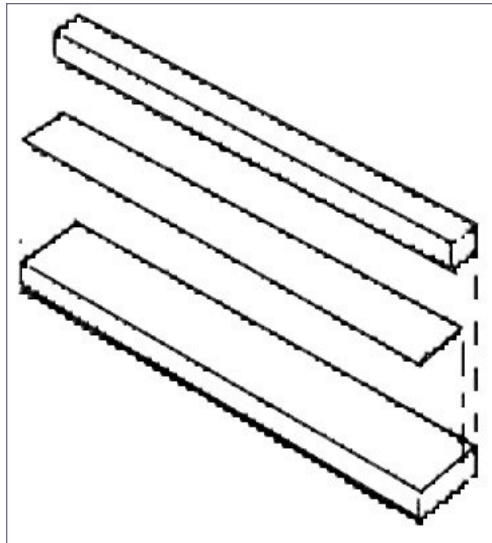

14. Wheel flange sanding tool.

Wagon box

The wagon box serves to transport tools, parts, and even explosives, but it was rather crudely built [15]. On one end the sides are held together with a 2" x 2" steel angle on the inside and bolted through to a 1-1/2" steel strap on the outside. Toward the center, the bolts run through to a 1-1/2" steel strap on the inside. At the other end, a 1" board is nailed on the inside.

Toward the center, the bolts run through to a 1-1/2" steel strap on the inside. At the other end, a 1" board is nailed on the inside.

It was not clear how the sides were attached to the floor boards. I assume the floor boards are lag-bolted to the car side sill timbers.

Painting and weathering

On the wood, I used acrylic craft paints in a thin wash. I first washed Dolphin Gray over the wood parts as a base coat. After this dried, I mixed four parts Dolphin Gray to one part True Ochre and one part white. I tested the mix on a scrap of wood to make sure I had the desired color.

For the metal, I applied a base or primer coat on all styrene parts using Testors enamel color Flat Rubber. After this had dried overnight, I used a series of washes to get the rusted and weathered look.

I made these washes by diluting acrylic craft paints with water until the wash just barely covered the parts. I practiced on some styrene to make sure the color scheme would work.

To age and rust the metal parts, I first washed over the parts with a gray, followed by a wash of Tangelo Orange. I followed with a wash of a mix of Tangerine Tango and Red Iron.

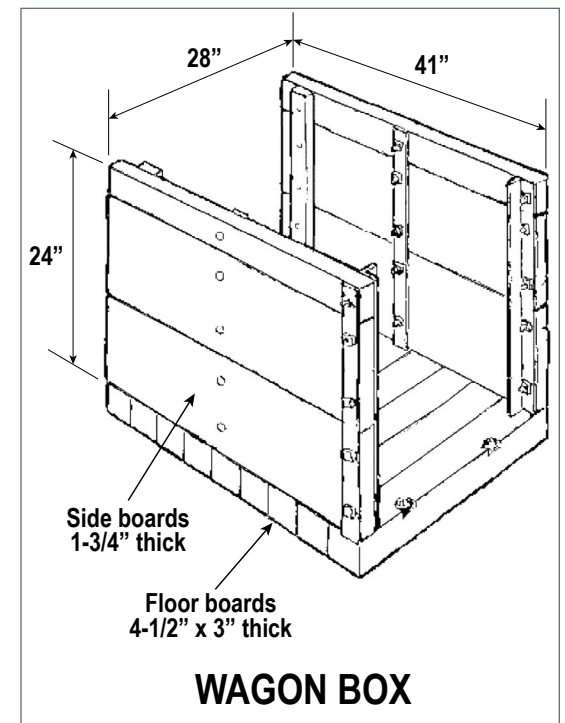

15. Wagon box details.

TIMBER CARS | 13

Note: Trying to find the exact match of colors with these names in cheap craft paints may be difficult, as they change periodically. As long as the paints are in the ballpark and are applied in diluted washes, any mistakes can be washed over. In fact, accidents frequently result in something closer to the real thing!



16. Finished cross bunk cars on my layout.



17, 18. Finished wagon box cars stationed at the mine entrance on my layout.

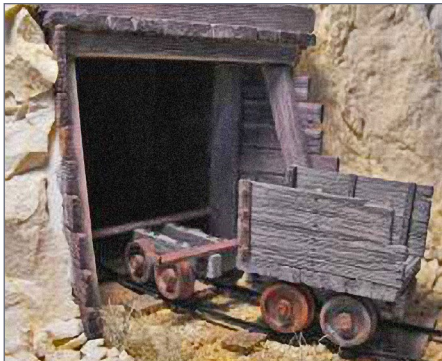

 [Click here to rate or comment on this article](#)

NOTE: Sadly, we learned that Dick Witney passed away on October 11th as we were finalizing his article.

TRAINMASTERS.TV 

Layout tours

volume 3









12 layout video segments in all!

VOLUME 3 





NEW: VOLUME 3



Our best layout video yet!

TRAINMASTERS.TV 

Layout tours

volume 1

16 Layouts in all!

INSTANT DOWNLOAD!

DVD
\$29.99
~~\$36.99~~

 DVD
 2 disks

Download 
\$16.49
~~\$21.99~~ 16 files

TRAINMASTERS.TV 

Layout tours

volume 2









12 Layouts in all!



DVD
\$29.99
~~\$36.99~~

 DVD
 2 disks

Download 
\$16.49
~~\$21.99~~ 12 files



Get the videos 

LAYOUT TOUR VIDEOS!

DVD	Download	
Now shipping!	Avail. Now!	
\$27.99	\$14.99	
\$39.99	\$21.99	12 files
	SPECIAL INTRODUCTORY PRICING!	
DVD	3 disks	

THE SOUTHERN NORTH SHORE RAILROAD

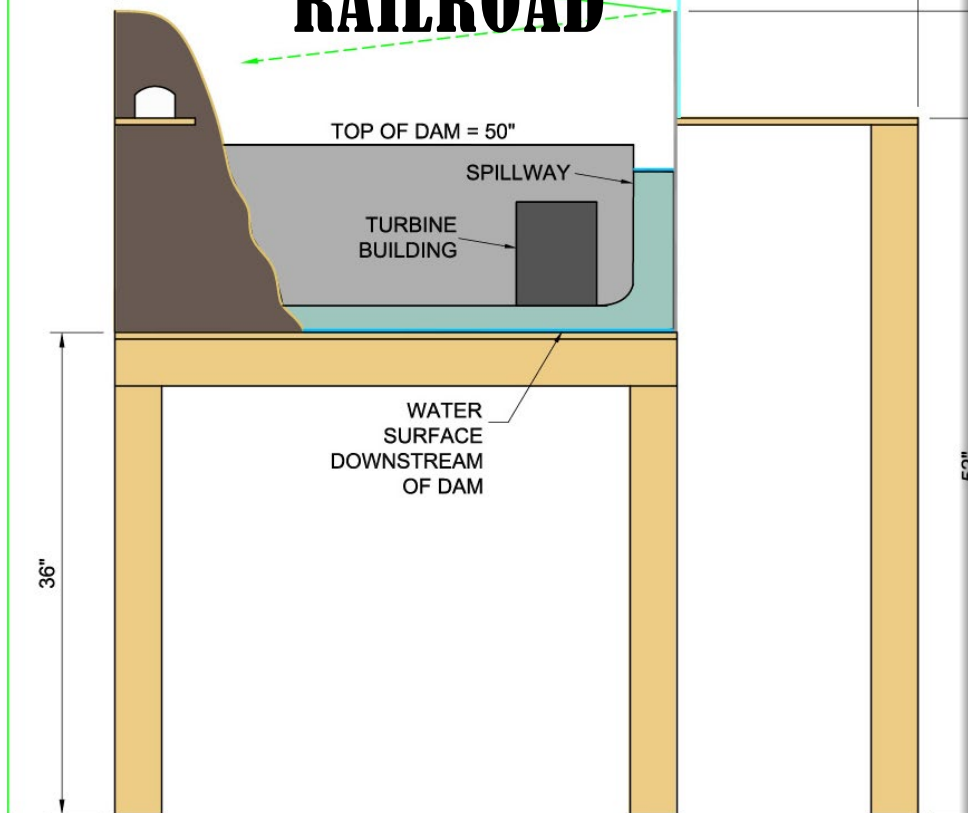

BY ROBERT M. PETRICK

Instead of selective compression layout design, how about "adaptive compression" instead?

Model Railroad Hobbyist | November 2017 | #93



[Click here to rate or comment on this article](#)

SELECTIVE COMPRESSION IS A CONCEPT KNOWN to most model railroaders, but layout designs can suffer because of it.

You supposedly get more from less by cutting out and eliminating "needless" details here and there: removing a bank of windows or loading doors from a warehouse, ignoring two or three stories of height, shortening a yard, decreasing the distance between towns, scaling back a city block, or lowering a bridge.

Snip-snip, chop-chop, done – don't look back.

But there are other ways to go about compression: multi-purpose; multi-use; and multi-tasking. You can compress scenes yet expand vistas, all without taxing the imagination and without all that painful surgery.

It's simple, really – and dare I say, ingenious? Let's call it "adaptive compression."

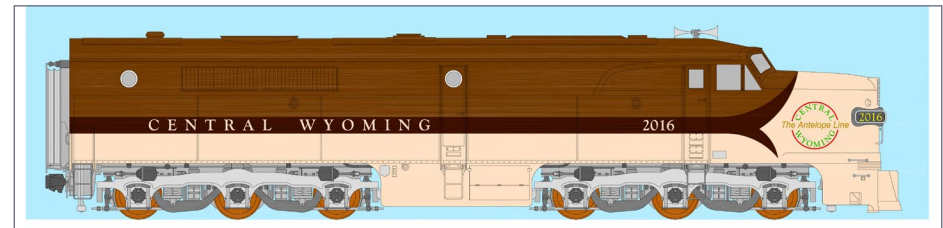

1. The Southern North Shore Railroad could easily be a western shortline and have its own paint scheme, such as the one I designed here for the "Central Wyoming" line.

SOUTHERN NORTH SHORE RAILROAD | 3

Take, for example, an ordinary commercial building with two different signs on opposite walls. When approached from one direction it is a furniture store; from the other, a bakery. It's the same structure but with different uses: different load-ins, different load-outs.

A chemical plant has a tall chimney; a paper mill has a tall chimney; a power plant has a tall chimney and a brick kiln has a tall chimney. Why not place one tall chimney in between to be shared by all?

Call it "borrowed scenery" if you like. The rear of one background industrial building or structure looks, more or less, like the rear of any other and can give breadth and scope to the foreground structures without taking up valuable real estate on the benchwork.

A coal mine produces (interestingly enough) coal; an iron mine produces iron; but to casual observers (and to discerning ones as well), they both look alike. So, why not give the mine a nondescript name and let it produce whatever mineral is of interest?

On any given day, a string of coal porters can arrive and take on a load of black diamonds; the next, crushed limestone in open gondolas; the next, hematite in shorty ore cars; the next, kaolin in three-bay hoppers; then coal again.

With empties coming and going all the while at discrete intervals: load, run, empty, run, repeat.

The Southern Northern Shore Railroad (SNSR), an N scale layout design, employs this "adaptive compression" philosophy throughout.

The layout design elements

The world-famous **Acme Chemical Company** was founded in the 1930s by Marvin Acme, the richest man in Toon Town. Acme

SOUTHERN NORTH SHORE RAILROAD | 4

Chemicals produces everything from a smoother, creamier peanut butter to yellowcake uranium and plutonium pellets encased in porcelain.

Wet products such as paints, dyes, pigments, solvents, alcohols (including government-subsidized ethanol), glycerols, aromatics, aliphatics, stearates, oleates, esters, vinyls, acids, bases, caustics, food-grade syrups and liquors, petroleum distillates and fractions, and slurries of all kinds can be delivered in bottles, cans, barrels, and tank cars of every imaginable description.

Dry products can be delivered in bulk in Airslide and Pressure-Aide hoppers or in 500-pound bags loaded onto flats or center-beam cars, or into boxcars.

For non-railroad customers, most of these products can travel over the road in 18-wheel tractor-trailers, or containers, or in ordinary trucks and vans. Wile E. Coyote seems to get his stuff wrapped in plain brown paper and delivered via land mail or FedEx.

Want to help keep
MRH free?

Then *click* on ads!

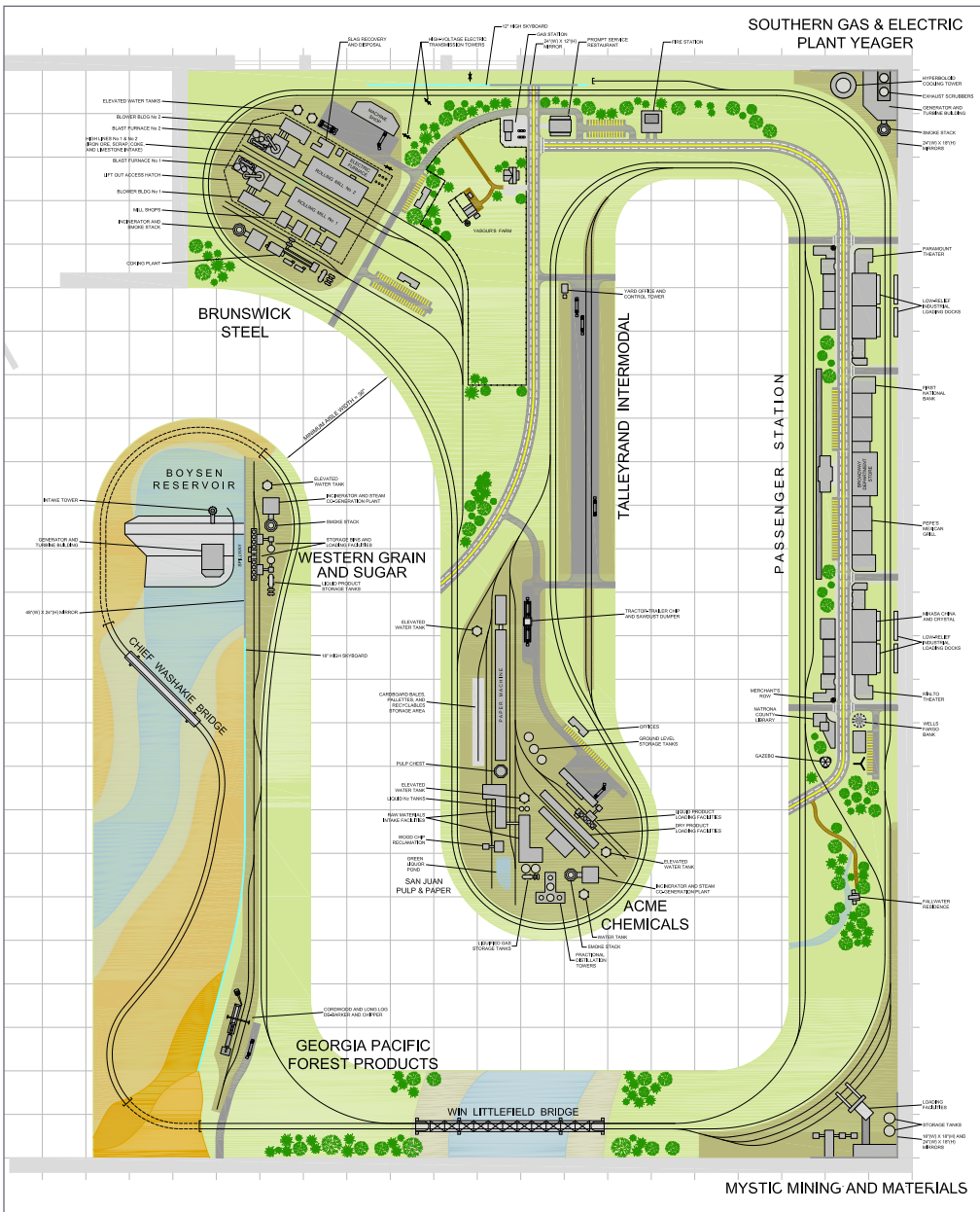

2. Upper deck track plan of the Southern North Shore Railroad. Zoom in to study the details.

Acme Chemicals shares space and facilities (using “adaptive compression”) on the middle peninsula with the **San Juan Pulp & Paper mill**. Most pulp mills produce only one kind of paper (kraft, bond, tissue, rag, coated, uncoated, glossy, corrugated, etc), but the SJP&P mill delivers whatever is needed or wanted.

The paper mill takes in whatever raw materials are necessary to produce the goods. The goods produced include:

- Light brown kraft paper or newsprint made from slash pines and delivered in 4000-pound rolls
- Glossy, high-clay magazine stock shipped to India for finishing
- Gossamer tissue sent to a Kleenex factory in Tennessee to be perfumed, cut, folded, and boxed
- Sturdy corrugated board made mostly from recycled corrugated boxes and hardwood stumps
- Cambric linen stationery made from old blue jeans.

If it’s paper, it’s SJP&P.

At the opposite end of the peninsula from SJP&P, **Brunswick Steel** fills the entire northwest corner loop with its massive iron and steel works.

Steel mills are very interesting places and are the subject of many model railroads. At this point it might be necessary to interject a comment about model railroads in general and about this layout in particular.

Four-hundred-and-fifty square feet sounds like a lot of square feet, but it isn’t; not really. A modern steel mill modeled in N scale can easily fill 450 square feet (benchwork, aisles, access portals, and all), leaving no room for the humans or for anything else. Because this mill takes up so much space, it’s tempting to think of the SNSR as a model of a steel mill, but it’s not. It is a model of a railroad that serves a steel mill, among other things.

SOUTHERN NORTH SHORE RAILROAD | 7

The arrangement of buildings and structures, as well as the inclusion or omission of certain buildings and structures, was done to give the impression of a steel mill and was not intended to be a faithful copy of any actual working steel mill.

Brunswick Steel is sorta like, kinda like, and functions a little bit like a real-world steel mill, but aesthetics and operational interest were the primary considerations. Basically, raw materials come in and finished products go out. Add the grit and grime to taste..

Southern Gas & Electric's Plant Yeager is an electric generating plant that burns coal, a lot of coal – 30,000 tons a day, day in and day out, twenty-four hours a day, seven days a week, three-hundred-and-sixty-five days a year. That's three, one-mile-long, one-hundred-car coal drags each and every day, rain or shine.

That's a lot of coal! It is also impossible to model in N scale. I put the plant in the far left corner of the layout and strategically placed mirrors to double it and increase the apparent size and complexity of the facility.

Even with all this, I can manage to model only an impression of a power plant; basically something to give coal cars a reason to venture to that end of the layout. I include, of course, high-voltage transmission towers.

Also in that area of the layout is a coking facility (part of Brunswick Steel) that uses coal porters to bring in coal to be converted to coke.

Mystic Mining and Materials is fairly well described when I earlier described "adaptive compression" as applied to a mine. It is placed in the far right corner of the layout, opposite Plant Yeager.

Double-ended sidings provide adequate space for storage and switching of loaded cars and empties. It's a mine that produces commercially viable quantities of every known mineral . . . what else is there to say?

SOUTHERN NORTH SHORE RAILROAD | 8

The **North Shore Yard** is front and center on the layout, occupying the entire lower level and depicts the typical operations of a deep-water port.

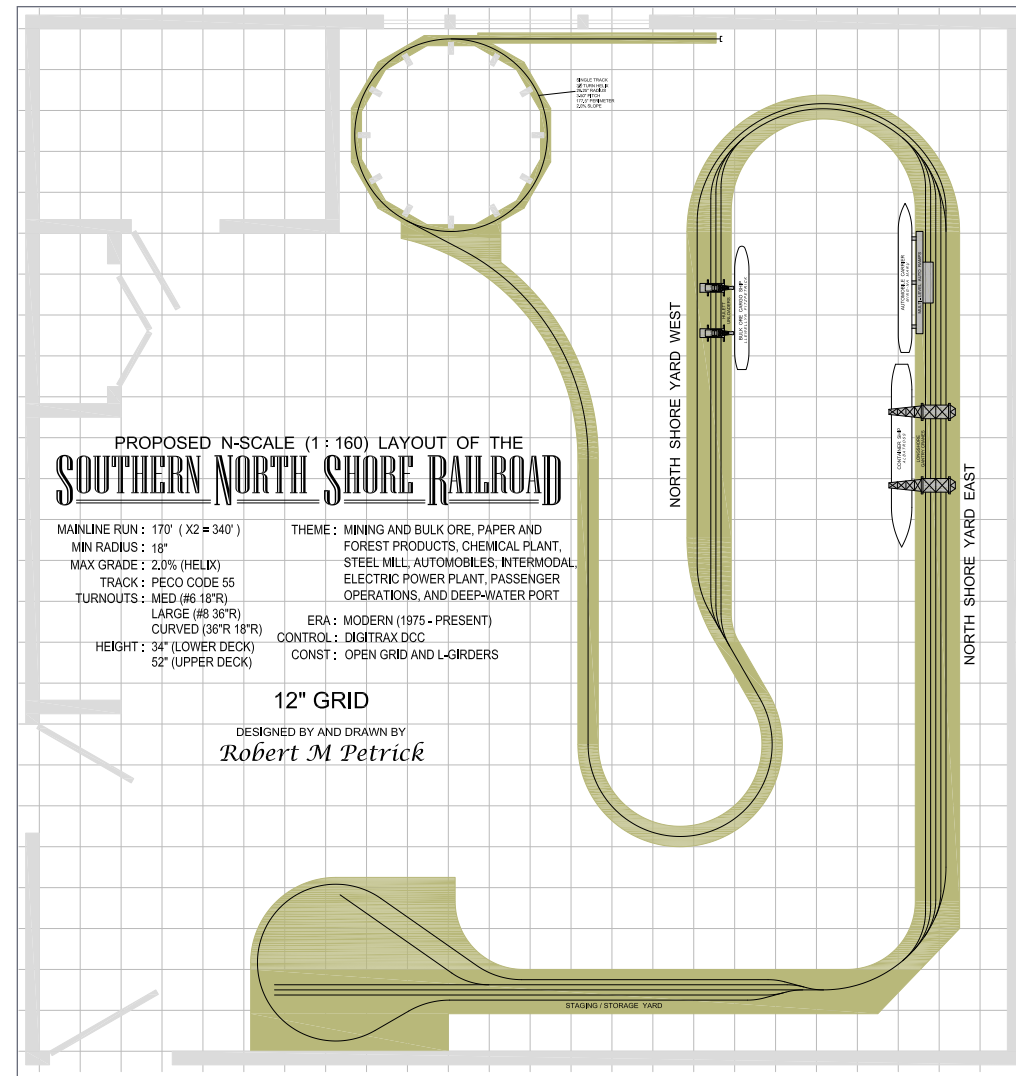

3. Lower deck track plan of the Southern North Shore Railroad. Zoom in to study the details.

The important consideration here is that tracks be long enough to move cars in and out, and order trains in a realistic, prototypical manner. From end to end (after straightening the folded dogbone), the yard is over 35 feet long and can store 275 cars on eight sidings, or store 240 cars on seven sidings without blocking the lead or any turnout and without encroaching on the mainline.

Although situated in a port or harbor, the yard can be used for more general operations as well.

Many modelers might consider it a sin to dedicate an entire peninsula to a single layout element. The **Wind River Canyon** is an officially designated wild and wonderful scenic route through central Wyoming.

The area of interest for this project is a typical section of the canyon gorge in the vicinity of **Boysen Dam**, just south of the

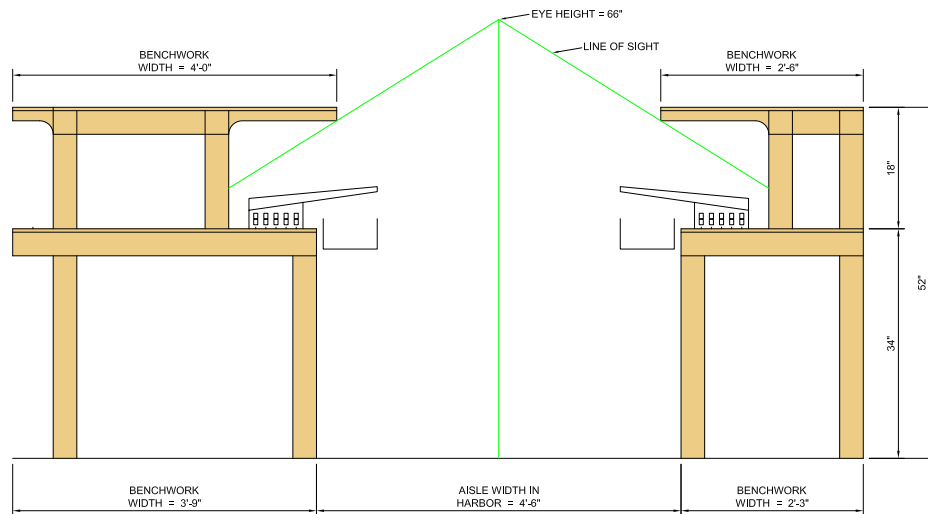

4. Typical section through the upper and lower decks.

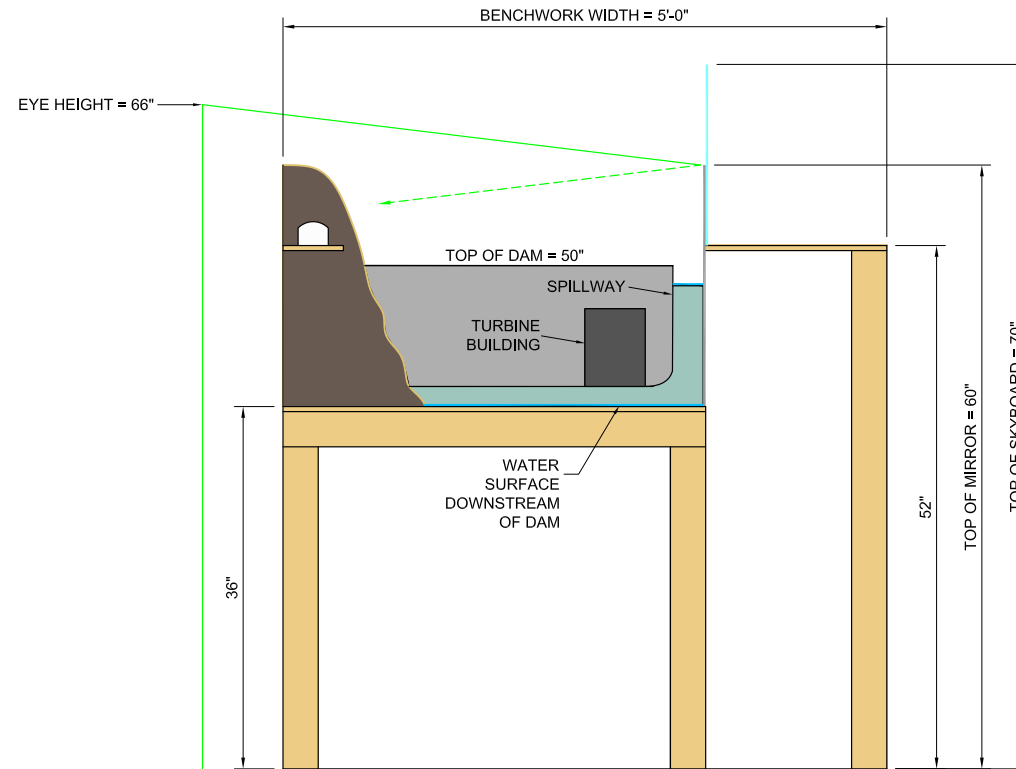

5. Typical section through the canyon at the downstream face of the dam.

picturesque resort town of Thermopolis, so named because of the hot springs and mineral baths.

The model depicts high desert scenery, sheer rock walls, a world-class trout stream and whitewater river, as well as the dam, the reservoir, the intake towers, the spillways, the generator and turbine building, and high-voltage electric lines.

There is also the **Chief Washakie Bridge** carrying the double track mainline across the river just downstream. As in other areas of the layout, a large mirror is used to give the scene a more apparent scope.

A modern grain depot is depicted at **Western Grain and Sugar**. Following intelligent compression's multi-use principles, the facility is based on the Coors barley operation at Ralston, WY with a few structures thrown in from the sugar beet processing plants at Lovell and Worland.

Typical rail traffic would include airslide and/or pressure-aide covered hoppers loading or delivering corn, wheat, barley, soybeans, oats, rye, canola, and the like. Sugar beets are delivered in open gondolas or in re-purposed relict coal porters.

Processed granulated sugar goes out in bulk hoppers or in 50-pound bags to Hershey's or Brach's Candy to the delight of dentists everywhere.

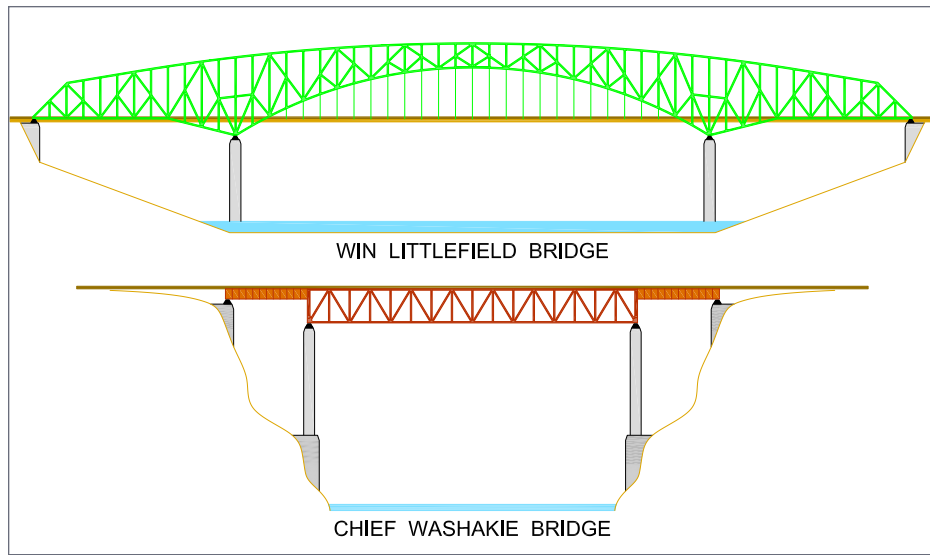

6. Scenic bridges on the SNSR.

Liquid product facilities are included for tank car operations for such commodities as high-fructose corn syrup, sunflower oil, or even ethanol or bio-diesel.

My favorite thing on the layout, the **Win Littlefield Bridge**, is a high-level long-span structure. It is a double-track cantilevered tied-arch bridge. It is 52" (695 scale feet) in length with a main span of 28" (375 scale feet) and two side spans of 12" each (160 scale feet). The deck is 9" above the water (120 scale feet).

This layout includes a town (or maybe it's even a small city). I am an engineer, but like George Costanza, I always wanted to pretend to be an architect – and of course cities and towns need a lot of buildings.

I have a pretty expansive definition of the freelance part of prototypical freelancing, and the buildings and structures are a mixed bag of small town shops and big city buildings from all over the country.

There is also a generous array of buildings from Casper that should be fairly recognizable to my fellow Wyoming modelers. And I included one small little tiny architectural gem: my version of Frank Lloyd Wright's *Fallingwater*. I couldn't resist.

And what layout would be complete without the bucolic serenity of **Yasgur's Farm**? Set in the rolling hills of upstate New York, the green fields and pastures evoke faded memories of the place that caused an entire generation to become interested in . . . um . . . gardening.

So there are the sights, the sounds, the community, and the pungent herbal aromas.

Layout Elements

- 450 square feet
- N scale (1:160) prototypical freelanced
- Folded dogbone along the wall walk-in design
- Two levels connected via three-and-a-half turn helix (28" radius, 2% grade)
- Double mainline throughout for long, continuous runs that allow trains to stretch their legs
- High-level long-span bridge
- Working classification yard with minimum 16' arrival/departure/storage tracks (40 cars) and dedicated 18' lead so that trains up to 30' long (75 cars) can be prototypically handled
- Industrial areas designed and arranged to have separate tracks and spurs for raw material intake and for finished product loading, each with suitable leads if possible (or at least run-arounds), so that switching takes place offline and does not foul the main
- Passenger station and downtown commercial area (with cars, people, mail boxes, kiosks, parking lots)
- Mountain and high desert scenery as depicted in the Wind River Canyon
- Peco Code 55 Streamline flextrack and turnouts
- No. 8 turnouts (main), No. 6 turnouts (yards and cross-overs), and large curved turnouts (36"R/18"R)
- Nominal 52" high benchwork upper level, 34" on the lower level
- Minimum 3" clearance from front of benchwork to track
- Comfortable aisles made as wide as practicable to accommodate several operators and spectators
- Mirrors placed in layout with carefully considered strategic reflected views
- Industries and structures:

1. Steel Mill – Two blast furnaces, electric furnace, two rolling mills, two blower buildings, machine shop, electric substation, coking plant (shares coal-handling spurs with nearby electric power plant), mill shops and offices, slag recovery and disposal, high line (for load-in of iron ore, scrap, specialty metals, coke, and limestone), low line (for load-out of rolled structural shapes, wire, pipe, plate, forgings/castings/stampings, and sheet metal coils).
2. Chemical Plant (adjacent to and contiguous with Pulp and Paper Mill) – Raw materials intake facilities, wet product and dry product loading facilities, ground-level and elevated storage tanks, cryogenic tanks, fractional distillation towers (cracking towers), smokestacks, incinerator, co-generating steam plant.
3. Pulp and Paper Mill (adjacent to and contiguous with Chemical Plant) – Raw materials intake facilities; pulp chest; long paper machine; chemical tanks and ponds; cordwood, pulpwood, and long log de-barking and chipping facilities.
4. Coal-fired Electric Generating Plant – Turbine building, smokestacks, exhaust scrubbers, high-voltage transmission towers, and ubiquitous hyperboloid cooling towers (OMG! these things look like nuclear power plant stacks, but they are only harmless large cascading fountains of water and steam; they actually rain inside).
5. Mystic Mine – Produces all manner of valuable raw materials that can be simply dug out of the ground: coal, iron (hematite and/or taconite), specialty and transition metals (chromium, nickel, vanadium, titanium, cobalt, manganese, molybdenum, tungsten, uranium, aluminum, zinc, tin, copper, etc), limestone, phosphate, potash, gypsum, bentonite clay, kaolin, and various commercial non-ferrous ores (sulfur, mica, boron, silicon). This is a magical mystical mine.



SOUTHERN NORTH SHORE RAILROAD | 15

6. Deep Water Port and Harbor – Loading and unloading facilities for automobiles and intermodal shipping containers (presumably from Asia), and loading and unloading facilities for bulk ore transports (presumably from Florida, Georgia, Alabama, or one of the Great Lakes states).

Final thoughts

Included in this design package are scaled drawings showing critical dimensions and clearances for the benchwork and trackage as well as overall illustrative, pictorial views of the layout. I hope the essential features, details, and descriptions contained herein are clearly conveyed to the reader. ✓



[Click here to rate or comment on this article](#)

ROBERT M PETRICK



Robert is a civil engineer who is fairly new to the hobby. He was born in Florida and grew up near the ocean. He wanted a change of scenery, and migrated north to Atlanta, and worked on some high-profile engineering projects.

Itching for a change of scenery again, He left the east and moved to a small town in the west.

He now lives and works in the heart of the intermountain west in Wyoming.

Now-a-days, Robert designs and builds very small stuff, such as in 1:160 scale.

CHECK IT OUT!

How will you plan your layout?

3rd Plant 3D CAD El Dorado SOFTWARE
The ultimate track planning software

[Click Here!](#)

144,000 have seen this MRH video ... have you?



[Watch the video now](#)



N SCALE
8600 COACHES
CLICK HERE TO ORDER
DEADLINE NOVEMBER 20



Model Railroad Hobbyist | November 2017 | #93

LOOK
 column



Click here to rate or
 comment on this article

JEFF SHULTZ

SCALETRAINS.COM RIVET COUNTER AND OPERATOR SD40-2 MODELS

SCALETRAINS.COM HAS PUT SMILES ON THE faces of many modelers with the release of their EMD SD40-2 in HO scale. Available in both the Rivet Counter brand, with prototype locomotive-specific features, and the Operator brand, with simpler details and a lower price, ScaleTrains.com's SD40-2 offerings are certain to please many modelers.



1. Rivet Counter Southern Railway #3327K engineer-side view.

▶ **NEW PRODUCT FIRST LOOK**

FIRST LOOK | 2

Model Railroad Hobbyist received two ScaleTrains.com SD40-2 models, the Rivet Counter Southern Railway #3327K and the Operator Norfolk Southern #3544.

Southern Rwy. #3327K represents an 81-inch high short hood Phase IId1 unit built in mid-1979 at the EMD plant in La Grange, Illinois. It features operating tricolor class lights, Southern Rwy.-style “staggered” fuel gauges on a 4,000-gallon tank, extended-range dynamic brakes without a batten strip, late-style jacking pads, an MU stand with battery-charging receptacle, and a flush-style EFCO. The details on this locomotive, such as the MU hoses and sand lines, are very fine. The model comes equipped with ScaleTrains.com’s metal semi-scale E Type couplers.

Working with ESU LLC, the creators of the LokSound and LokPilot lines of DCC decoders, ScaleTrains.com has implemented new lighting features in the Rivet Counter locomotives, including additional hardware on the locomotive motherboard to accommodate ESU decoders that don’t have the 10 separate outputs required for the variations on the SD40-2 model.

#3327K is equipped with a LokSound 4.0 sound decoder, which has been programmed with the correct sound and lighting functions for the specific locomotive being modeled. Out of the box it is set to the DCC default address of 3, but a quick trip to JMRI/Decoder Pro changed that to my preferred use of the road



2. Rivet Counter Southern Railway #3327K top view.

FIRST LOOK | 3



3. Closeup of HT-C truck and builders plate detail.

number for the decoder address. The default settings for the LokSound decoder include a lot of momentum – while not a bad thing, it is something to be prepared for when first running the locomotive. Function F5 controls the class lights, which cycle through off, white, green, and red. The locomotive is also set up as long hood forward, matching Southern’s standard practice.

Norfolk Southern #3544 represents a relatively recent acquisition by Norfolk Southern. #3544 began life in September 1979 as Burlington Northern #7178, one of a series of Phase IId2 BN SD40-2s built at the GMD plant in Canada, due to a lack of capacity at EMD’s LaGrange plant. Built to BN specifications, the locomotive was sold to Helm Leasing (HLCX) in June of 1999, and purchased by Norfolk Southern in January of 2014.

While the model does use the same mechanism as the Rivet Counter line, as part of the Operator brand the model does not include prototype-specific features, and instead represents a

FIRST LOOK | 4

fairly generic SD40-2 produced prior to mid-1978, due to the batten strip detail on the dynamic brakes. The Operator SD40-2 includes directional LED headlights and lighted number boards, dimensionally accurate truck centers, a front anticlimber, 88-inch low short hood with brake wheel, standard-range dynamic brake intakes with see-through grills, treadplate detail, and a 3,000-gallon fuel tank. Lights are LEDs with rubber gaskets to isolate the light to the intended fixture. The model comes with ScaleTrains.com's plastic semi-scale E Type couplers.

A kit that includes items such as MU hoses, cut levers, grab irons, windshield wipers, and other fine details will be available separately. It is available for pre-order now.

The Operator model did not come with a decoder, but is equipped with a 21-pin 21MTC interface, under a removable dynamic brake hatch. I installed a Digitrax DH166MT, a 21MTC-compatible non-sound decoder about the size of a postage stamp.

On my kitchen scale the Norfolk Southern model weighed 1 lb.-2.1 oz., and the Southern model weighed 1 lb. 2.5 oz. ✓



[Click here to rate or comment on this article](#)



4. Operator Norfolk Southern #3544.

FIRST LOOK | 5

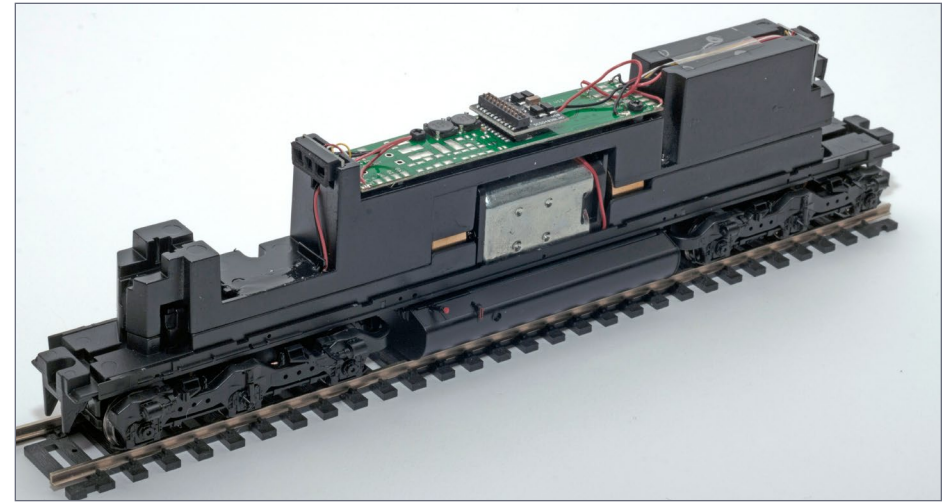

5. Operator SD40-2 chassis and motherboard with shell removed.

ADVERTISEMENT

END OF TRAIN DEVICE

NEW SAFETY GREEN

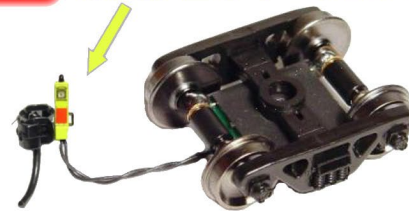

Bright Red Flashing Light!

**Installs in minutes!
No freight car
modification required!**

Patented Technology - US Patent 7,549,609

Does not affect Load!

↓ Car without Load ↓

↓ Car with Load ↓



**Click Here to
Learn More**

**RE RING
ENGINEERING**

AMERICA'S LARGEST OPERATING MODEL RAILROAD SHOW

4 FOOTBALL FIELDS OF SERIOUS TRAIN ENTHUSIAST FUN

TRAIN FUN FOR EVERY GAUGE OF RAILFAN

- 70 Detailed Operating Railroads
- 56 "How to" Clinics
- 75 Demos
- 60 Manufacturers – All the Majors & Cottage Industries too
- 50 Hobby Dealers
- 12 Train Historical Societies
- NEW "All Rail" Photo Contest

MODELER'S DELIGHT
EXPERT MODELERS HOST 56 FREE CLINICS

A wide range of clinic topics will challenge every modeler skill level. Clinics are free with admission and held daily during Trainfest. Space is limited; register today at trainfest.com.

NEW PRODUCTS UNVEILED

If a manufacturer is making a new product, they announce it at Trainfest – the nation's premiere train show. Make sure to visit all the manufacturers to see this year's new and exciting products and skills.

Online
**DISCOUNT
TICKETS**
AVAILABLE
AUG. 1 - NOV. 10, 2017
AT TRAINFEST.COM

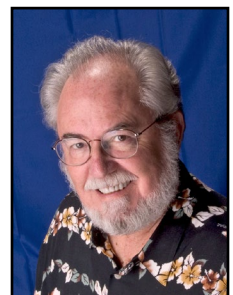

Model Railroad Hobbyist | November 2017 | #93

NOVEMBER NEWS
column

RICHARD BALE and JEFF SHULTZ

 [Click here to rate or comment on this article](#)

Trainfest

SATURDAY & SUNDAY · NOV. 11 - 12, 2017

9AM - 5PM · MILWAUKEE · WI STATE FAIR PARK

RUN THE TRAINS ON MOST LAYOUTS!



Trainfest
America's Largest Operating Model Railroad Show

GREAT FAMILY EVENT OF HUGE OPERATING RAILROADS, PLUS...

- Kid-Friendly Activities
- Kids-Only Make 'n Take
- Clinics & Demos to Get Started in Modeling
- Become a Jr. Engineer
- Ride the MLES Train on 600 ft. of track

CELEBRATE THE SOO LINE

Trainfest is partnering with the Soo Line Historical Assn. to celebrate the Soo Line. We've created a spectacular 32-panel display on the railroad. Manufacturers will have Soo Line merchandise and layouts will be running the Soo. A limited-edition Soo Rolling Stock Freight Car is offered through trainfest.com. Reserve yours today to pick up at Trainfest.



Sponsored by the WISE Div of the National Model Railroad Association

SHOW DETAILS, DISCOUNT TICKETS & LODGING DEALS AT TRAINFEST.COM

Motrak Models

Motrak Models has announced that it has sold its freight car loads division to Fred Patrick of F&N Hobbies. With the sale effective November 14, 2017, the new owner will start selling the loads at www.fnhobbystrains.com in December. Included in the sale are the rights and molds for all coal, ore, taconite, woodchip, gravel, sand, granite blocks, scrap metal, and scrap aluminum loads for N, HO, and S scales.

Motrak will continue to make loads for On30 scale as well as loads in all scales that they use the laser cutter for. The sale also did not include Motrak's current inventory, which they will continue to sell until gone ...

▶ THE LATEST MODEL RAILROAD PRODUCTS, NEWS & EVENTS

NEW CLUB CARS



The Chicago & North Western Historical Society is selling three HO scale PS-2 covered hopper cars based on prototypes built in the mid-1950s. The

three car numbers offered, 4073, 4115, and 4139, replicate long-lived prototypes that retained their as-built paint scheme until retirement after 30 or more years of service. The HO scale ready-to-run models were produced for CNWHS by Kadee Quality Products. For ordering information visit cnwhs.org.

.....

NEW PRODUCTS FOR ALL SCALES

Cascade Rail Supply is currently supplying N, HO, S, and O scale roadbed produced from Homasote. The standard selection of products includes straight and curvable sections with 30 degree shoulders in a choice of 12- or 18- scale inches thick. Compatible pads for turnouts of various sizes are also available along with ramps and transitional sections. All dimensions are based on prototype roadbed data. Custom roadbed is also available. For additional information visit cascaderailsupply.com.



ESU has announced their new CabControl wireless control system, featuring the ESU Integrated Control Unit and the ESU Mobile Control II throttle. The CabControl Control Unit

includes an integrated 7 amp booster, WiFi communications, automatic train detection using RailComPlus, an internal database that can track more than 16,000 locomotives with specific names and symbols and over 1,000 accessory decoders, an EcoSlink port for connecting to EcoS accessories, and consisting and other standard DCC functions. It also has a USB port for software updates and throttle charging. The Mobile Control II runs on the Android Operating system with a 3.2-inches touch screen display at 800x400 resolution. It includes a large dial for throttle and directional control, four buttons that the user can configure for certain functions, a Micro USB port for software updates and battery charging, and WiFi communications. The battery is good for 5 to 8 hours of use between charges. The Mobile Control II also includes a 3.5mm stereo headset (microphone and headphone) port. For more information see your dealer or esu.eu/en/products/digital-control/cabcontrol.



Model Tech Studios is selling a Tree Topper/High Climber logging figure in N, HO, S and O scales. Designed after the loggers who climbed up the trees to top them, the figure includes saw, axe, and rope. For more information go to modeltechstudios.com.



Ring Engineering has released a major update to its LM-3, LM-3S, LM-2 and LM-2S locomotive modules that includes DCC decoder compatibility. Locomotives with those modules installed can have their firmware updated to allow them to operate on standard DCC layouts. A CI-1 computer interface or HC-2 controller is needed to configure the DCC address and adjust the functions and speed control. In DCC mode the LM has 14 functions assigned by default, including Brake and Load, which uses RailPro's True Motion Technology to simulate the load on a locomotive.

In addition to DCC support, Ring Engineering has also introduced new features that can be used both in DCC mode and under RailPro radio control. The first is True Motion Technology, which uses a mathematical model to enable the engineer to simulate the loads on a model locomotive depending on the desired amount of simulated power needed to move the train. Not only does this affect the engine sounds on a sound-equipped locomotive, but also sets inertia levels for starting and stopping the train. Under radio control load can be set from 0 to 100%, and under DCC it can be set in 25% increments at the push of a function key.

Ultimate Series Sound is the name that Ring Engineering has given its new sound technology for RailPro Locomotive Modules. Involving full digital recordings, precision mixing, and

able to be combined with True Motion Technology, Ring claims that it creates the ultimate in sound experiences. Ultimate Series Sound has a technique that eliminates the looping effect that can be heard on sound decoders when the decoder is set to idle or a constant speed and the sound file repeats.

The RailPro Assistant software now includes new light effects, such as a natural fade on/off, and a light effects editor, allowing the user to create custom light effects for both locomotive and accessory projects. For more information see your dealer or ringengineering.com.

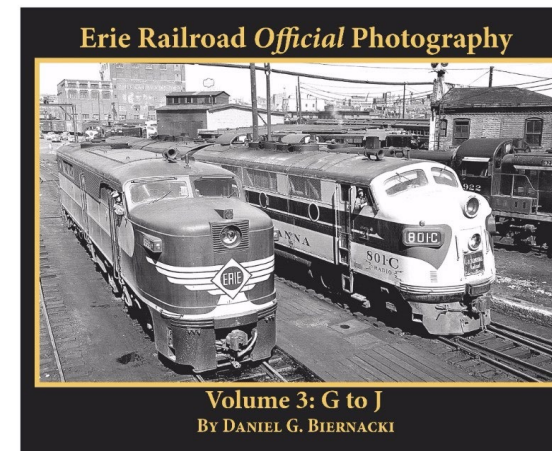

New softcover books available now from **Morning Sun** include *Erie Railroad Official Photography, Volume 3: G to J*, by Daniel Biernacki; and *GG1. The World's Greatest Electric Locomotive, Volume 2*, by Robert Yanosey. For additional information contact a dealer or visit morningsunbooks.com.

Woodland Scenics is adding to its collection of Built-&-Ready Landmark Structures with the Double Decker Trailer, available in N, HO and O scales. Building details include window AC, multiple doors and windows, cinder blocks, TV antenna, and a trailer hitch. Also included are a picnic table,



trash can, and propane tank. Compatible with Woodland Scenics Just Plug Lighting system, the HO and O scale trailers feature a flickering TV set. For more

information see a dealer or go to woodlandscenics.com.

O SCALE PRODUCT NEWS

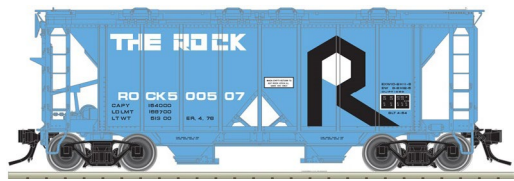

Atlas O plans to release new paint schemes on their ACF 70-ton 1958 cu.ft. covered hopper during the first quarter of 2018. The O

scale ready-to-run model is based on a prototype built by American Car & Foundry in the mid-1930s. Features include operating hatch locking mechanism, metal grab irons and stirrup steps, and either open or closed triangular side panel as appropriate to the practice of the prototype road being modeled. Road names will be Burlington Northern, Central Silica, Conrail, Delaware & Hudson, and Rock Island. An undecorated model with open sides is included in this release. The O scale model will be available with either 2-rail or 3-rail trucks.

Also due from Atlas O during the first quarter of 2018 are a group of 20-foot corrugated containers decorated in new paint schemes. Carrier names



include Hapag-Lloyd, American President Lines, COSCO, FESCO, Mediterranean Shipping Co., and OOCL. The containers will be sold in 2-packs with a total of eight numbers available for each carrier name. For additional information on all Atlas O products contact a dealer or visit atlaso.com.



Frenchman River Model Works is selling a 1:48 kit for a vertical cylinder steam winch. Although this style of winch was mostly used on ships, it can be readily adapted for use on logging or mining railroads and other heavy industry applications. The kit consists of detailed resin castings, laser-cut parts, and metal shafting. For additional information visit frenchmanriver.com.

S SCALE PRODUCT NEWS



Precision Vintage Classics is selling an S scale kit for a Denver & Rio Grande Western 6600 series narrow gauge flat

car. Between 1955 and 1957 D&RGW built 103 40-foot flat cars with a capacity of 25 tons using the steel underframes of standard gauge cars. They were equipped with Andrews trucks salvaged from retired narrow gauge stock cars. The Durango & Silverton is using some of the remaining prototypes to make open tourist

cars. The Sn3 kits consist of a resin cast flat car, wood deck, couplers and appropriate trucks. An On30 version is also available with Bachmann trucks. The load shown in the illustration is not included. For additional information visit pvc-sn3.com. If you experience difficulty accessing the website call 253-875-1684.



Yarmouth Model Works is selling a resin kit for a CNR 1937 AAR 40-foot boxcar. The S scale model is based on a prototype built by National

Steel Car with NSC-2 steel ends and a raised panel roof. The kit features a one-piece resin body casting, laser-cut running boards, custom photo etchings, Des Plaines Canadian ladders, and Black Cat decals. For additional information visit yarmouthmodel-works.com.

HO SCALE PRODUCT NEWS



Accurail's new HO scale 36-foot double-sheathed wood cars are impressive. The running board, National wood doors and

door fixtures, and end detail are all exceptionally well-defined for an economy priced model with molded-on detail. The detailed Andrews trucks are appropriate for the period of these cars. Data-only kits are available now for cars with wood or Murphy steel ends (above) in a choice of either oxide red or mineral red.



The new models, decorated for Denver & Rio Grande, are currently available in a 3-pack. The D&RGW cars have

Murphy ends and straight steel underframes.



Additional new HO scale car kits from Accurail include a USRA two-bay coal hopper decorated for the Toledo Peoria &

Western Railroad. The model is based on a prototype built in 1906 and rebuilt in 1959.

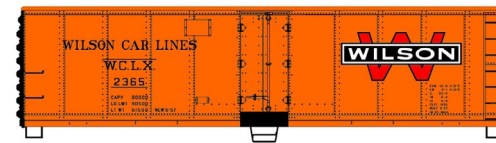

This WCLX-Wilson Car Lines 40-foot steel reefer has steel Bettendorf ends and hinged swing-doors.

Accurail's HO scale kit represents a prototype built in 1949 that was rebuilt in 1954.

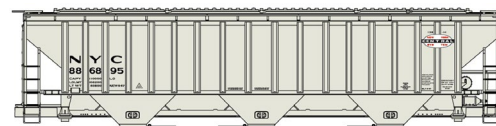

Accurail's kits for a Pullman Standard 4750 cu. ft. covered hopper car are one of their best

and most complex models. This is not to be confused with a simple shake-the-box assembly. Finely detailed parts to be applied by the modeler include roof components, brake wheel and brake step, hoppers, and discharge gates. The ends and delicate ladders are also a separate assembly. The components make into an accurate, well-detailed HO scale model at a very affordable price. The New York Central version released this month is based on a prototype built by

NOVEMBER NEWS | 10

Pullman Standard in 1967. All Accurail HO scale kits come with Accumate couplers and appropriate trucks. For more information contact a dealer or visit accurail.com.

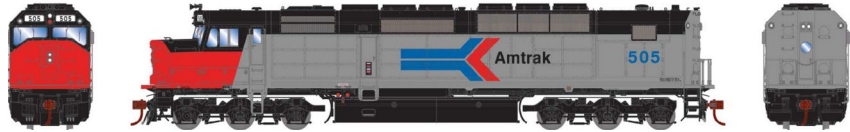

Heading **Athearn's** September 2018 production schedule is a new run of Genesis EMD SDP40F diesel locomotives. The release will include locomotives with a pointed nose painted in Amtrak's initial red-nose paint scheme.

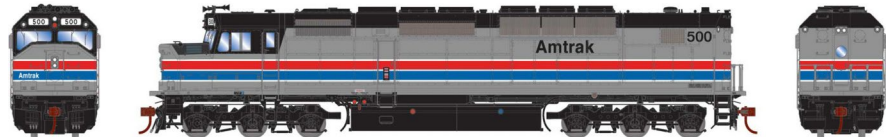

The Genesis SDP40F diesels will also be available as repainted in Amtrak's Phase II scheme.



Athearn's September 2018 schedule includes a new release of HO scale Genesis GP38-2 diesels. Models decorated for BNSF will be available in Phase I, Phase Ia, and Phase II body configurations.



Additional road names include Canadian Pacific (Phase II body in two paint schemes), and Durham & Southern (Phase Ia body in Bicentennial, and black and white scheme).

NOVEMBER NEWS | 11

All Athearn Genesis sound-equipped locomotives feature a DCC decoder with SoundTraxx Tsunami2 sound. The sound unit will operate in both DC and DCC environments. Models with DC only are DCC-ready and come with both 8- and 9- pin connectors for installation of an aftermarket decoder. Athearn's SDP40F locomotives equipped with sound will have two speakers.



Athearn Ready-to-Roll models due next September include a 50-foot FMC boxcar with a combination of a plug door and a Youngstown sliding door. Features of the car include outside posts, non-terminating ends, separately applied wire grab irons, etched metal end platforms, and machined metal wheelsets. The circa 1970s decorating schemes will be Minnesota, Dakota & Western; Burlington Northern (green, Primed for Grime scheme), Missouri Pacific, Seaboard Coast Line, Railbox (Primed for Grime), Union Pacific, and undecorated.



An FMC 4700 cu. ft. dry bulk covered hopper with triple discharge bays is also scheduled for release next September. Features of the HO scale Ready-to-Roll model include etched metal roof walk and end platforms, separately applied roof hatches, wire grab irons, and underbody details. It will ride on 100-ton trucks with 36-inch machined metal wheelsets. Road names will be Burlington Northern (green, Primed for Grime), BNSF (Primed for Grime), Union Petroleum Co., Union Pacific (ex-WP), Farnhamville (pink scheme), Kyle Railroad, and Rapid City, Pierre & Eastern.

NOVEMBER NEWS | 12



Athearn has included a 60-foot bulkhead flatcar in its September release. Details on the HO scale Ready-to-Roll model will be molded on except for the brake wheel and some separately applied items on the outside of the bulkhead. Road names will be Golden West Service, Santa Fe, Columbia & Cowlitz, Canadian Pacific (black), CSX, Ferromex, Kansas City Southern, Milwaukee Road, Pacific Great Eastern, Southern Railway, SSW-Cotton Belt, and Minnesota, Dakota & Western.

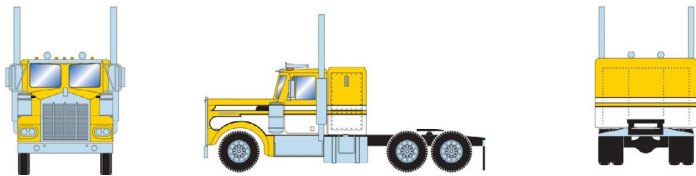

HO scale Kenworth sleeper cab trucks with dual wheels will be available from Athearn in September in twelve color combinations.

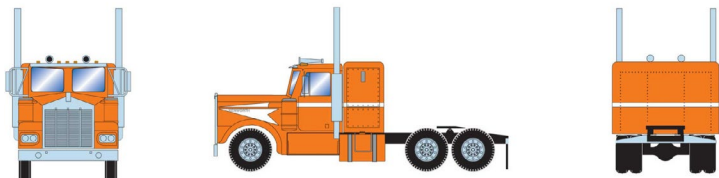

The models feature a separately applied steering wheel, clear window glazing, and rubber tires.

Roundhouse branded models scheduled for release next September include 25-foot trailers with dual wheels and landing gear. They are suitable for TOFC service. The trailers will be sold in 2-packs decorated for Rio Grand Motorway, Erie, Great Northern, New Haven, New York Central, Texas & Pacific,

NOVEMBER NEWS | 13

American President Lines, K-Line, Mitsui O.S.K., Sealand, and OOCL. The decorating schemes include detailed tires and painted rims.



Completing Athearn's September 2018 release is a Roundhouse brand 40-foot steel gondola with molded-on detail. The trucks will be fitted with machined metal wheelsets. Three road numbers each will be available for Lehigh Valley, Baltimore & Ohio, Conrail, New Haven, Pittsburgh & Lake Erie, El Paso & Southwestern, and Elgin, Joliet & Eastern. For additional information on all Athearn and Roundhouse products contact a dealer or visit athearn.com.



Atlas Model Railroad Company is quoting a 2018 second quarter availability for new paint schemes and road numbers for its HO scale NJ Transit ALP-45DP modern commuter cars and

locomotive. DC and DCC versions of the ALP-45DP dual-mode locomotive with a non-functioning pantograph (the prototype draws electric power from overhead wires or operates as a diesel). A separate package of grab irons with a drilling template is available for hobbyists who want to add more detail to their model. The Atlas Silver series DC version of the locomotive has a 21-pin socket for an aftermarket decoder and plenty of space for installation of a speaker. The Atlas Gold series DCC version comes with an ESU LokSound decoder.

NOVEMBER NEWS | 14



Multi-level commuter cars will be available configured as a cab car (left), a trailer, and a trailer with a toilet.

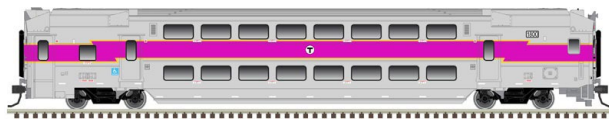

The second quarter production run will include
Bombardier multi-

level commuter cars decorated for MBTA (Massachusetts Bay Transportation Authority). Both cab cars and trailers (above) will be available in multiple numbers. The pricing on the MBTA cars is different than other road names due to the official licensing agreement with MBTA.



Atlas has scheduled another production run of ACF 4650 cu.ft. Centerflow covered hopper cars for release

during the first quarter of 2018. Features of the HO scale ready-to-run model include an etched metal roof walk, detailed brake gear, and 100-ton roller-bearing trucks with blackened metal wheelsets. Three road numbers each will be available for ACFX Carbon Black, ATEL Leasing, BNSF (large circle cross), Cargill Salt, Grand Trunk Western, Royster, and Montana Rail Link.



Atlas has completed another production run of its HO scale 1997 Ford F-150 pickup truck. Decorating schemes include Police, Atlas

Model Railroad Company, Greenlawn Landscape Experts, and

NOVEMBER NEWS | 15



Atlas also has a variety of HO scale single-axle box trailers that have a

ball hitch on the tongue allowing them to be mounted on the F-150 pickups. For additional information on all Atlas products contact a dealer or visit atlasrr.com.



Bachmann Train's HO scale version of the Southern

Pacific 4-8-4 GS4 steam locomotive is now available with factory installed sound. Identified as Bachmann's DCC Sound Value, the system was developed with SoundTraxx and includes prototypical exhaust chuff, short and long whistles, bell, air pump, steam release, and blower. The ready-to-run model is available in a choice of two SP Daylight schemes and in Bicentennial red, white, and blue.



New for October from Bachmann Trains is an HO scale 50-foot outside brace boxcar equipped with a track powered Flashing Rear End Device (FRED).

The FRED equipped car is available for Railbox, Burlington Northern, Canadian National, CSX (above), and Greenville & Northern Railway.

The End of Train Device (EOTD or-FRED) accessory is also available separately as a wired truck and coupler w/FRED. It



can be installed by replacing a truck on the following Bachmann Trains products: 50-foot plug-door boxcar, 56-foot ACF Centerflow hopper, 50-foot steel reefer, 52-foot 6-inch flat car with 35-foot piggyback trailer, Evans All-Door boxcar, 27-foot ore car, Canadian 4-bay cylindrical grain hopper, and 50-foot 6-inch ACF outside braced sliding door boxcar. For additional information contact a dealer or visit bachmanntrains.com.



Bowser is working on another release of its HO scale ready-to-run GLa twin-bay coal

hopper cars. Pre-orders are due by November 17 with availability expected in August 2018. Multiple car numbers will be available for Baltimore & Ohio (Capitol dome herald), Blue Coal (fantasy schemes for Delaware & Hudson, DL&W, and Reading), Cambria & Indiana, Green Bay & Western (red logo), Lehigh Valley (black and white diamond herald), Ontario & Western, and Waddell Coal.

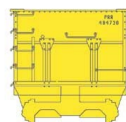
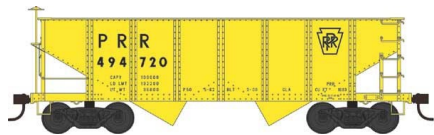

Schemes for GLa hoppers in Pennsylvania livery include an oxide body with circle

keystone monogram, oxide body with shadow keystone, PRR MOW (yellow body, no keystone), and PRR MOW (yellow body with keystone, above).



HO scale coal haulers currently available from Bowser include a 55-ton twin-bay hopper with peaked ends. The one-piece plastic body

and discharge door hardware are nicely detailed. The interior slope sheet includes rivet detail. The decorating is sharp and opaque with the smallest lettering being clearly legible. In addition to Atlantic Coast Line, road names are Toronto, Hamilton & Buffalo Railway; Norfolk Southern, and two schemes for Norfolk & Western. For additional information on all Bowser products contact a dealer or visit bowser-trains.com.



Broadway Limited is selling A, B, and matched A/B sets of Electro Motive Corporation E1 diesels.

Multiple road numbers are

available for Gulf, Mobile & Ohio, Baltimore & Ohio, Alton Railroad, and Santa Fe in the iconic warbonnet scheme. The ATSF units are available in both original and post-war versions of the warbonnet livery. The HO scale ready-to-run model consists of an ABS plastic body with a die cast metal chassis. The locomotives are available with Paragon3 Sound & Operating System that features Rolling Thunder enhanced sound.

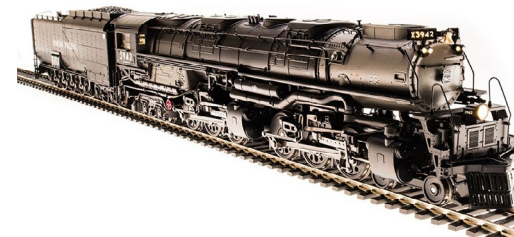

Big steam available from BLI includes this Union Pacific 4-6-6-4 Challenger. American Locomotive Company built 105 simple articulated Challenger steam locomotives for the

NOVEMBER NEWS | 18

Union Pacific between 1936 and 1943. A few highlights of BLI's HO scale version include golden white LED head and rear lights, lighted number boards, lighted front marker lights, lighted rear marker lights (red to the back and green to the sides), and a cab light that automatically turns off when the locomotive is moving. The model is equipped with an integral DCC decoder with Back EMF and Paragon3 Sound & Operation System with Rolling Thunder that creates prototype sounds in both DC and DCC environments. The UP model is available in a variety of liveries including black and graphite (above), and the contemporary excursion scheme.



BLI's UP Challenger is also available with smoke deflectors in the two-tone gray paint scheme. Tender options include both coal and oil. A Denver & Rio Grande and an unlettered

model are also available. For a complete list of details on this feature laden model visit broadway-limited.com.



year that Con-Cor has offered models specially decorated for the holiday season.

Con-Cor International has a limited quantity of 2017 Christmas cars available. This is the 52nd



Blitzen, the other is Santa's Foxy Helper.

Two different ready-to-run models are available. One is decorated for On

NOVEMBER NEWS | 19



Con-Cor has released a new run of HO scale 45-foot Euro-style corrugated containers. The corrugations and door locking fixtures on the sample we

reviewed were well-defined and cleanly molded. The multi-colored lettering was opaque, crisp, and properly registered. In addition to the DHL Transport scheme shown above, available carrier names are Yang Ming, Tropical, Wan Hai, Matson, RAILBRIDGE, Hapag-Lloyd, and Horizon Lines. The models are sold in 2-packs. For additional information on all Con-Cor products contact a dealer or visit con-cor.com.



East Coast Railroads has introduced a new limited run MC/ACF 3 window 36-foot wood caboose in HO scale. The new models feature all yellow grab irons

and are available in the following road names and schemes: Norfolk Southern #393 and #394, Seaboard Air Line #5228 VA Division, #5256 CARO Div, #5311 HAM-TERM, #5260 GA Division (1951, no slogan), #5339 and #5343 NF Division, and #5411 S. FLA Division.



Also new are Norfolk Southern 2-bay wood chip hopper kits, available in six road numbers: 9106, 9115, 9122, 9130, 9144, and 9158.

The kits feature a one-piece body with molded-on details. The models include nonmagnetic axles and knuckle couplers.



East Coast Railroads has also announced a limited run Norfolk Southern 41-foot AAR steel gondola kit. Available with road numbers 7216 and 7220,

these kits feature one-piece bodies with molded details. Like the wood chip hopper, this kit features nonmagnetic axles and knuckle couplers. For more information see a dealer or go to eastcoastrailroads.com.



ExactRail has released its Missouri Pacific 3737 cu. ft. open hopper in 13 new road numbers. The Platinum series HO model is an accurate replicate of

the more than 10,000 prototype units Bethlehem built beginning in 1973. Features of the HO scale model include formed wire grab irons, lever hanger, and uncoupling levers; and an etched metal slack adjuster guard. The narrow draft box and Wine door locks are exceptionally well detailed. The ready-to-run model comes with Kadee #158 couplers and equalized 100-ton ASF Ride Control trucks with machined metal wheelsets. For additional information visit exactrail.com.

Fos Scale Models has acquired the Ed Fulasz line of precision cast Hydrocal kits from Railroad Kits of Holden, Mass. The finely detailed cast HO scale brick and stone structure kits company was established in 2002 by Fulasz, who sold



the product line to Railroad Kits in 2011. Fos plans to freshen up the designs, add some details and reintroduce the Hydrocal structure kits over the next several months. The initial release under the new owner is the HO scale brick chimney shown here. For additional information visit fosscalemodels.com.

Imperial Hobby Productions has announced that it will stop production of HO scale resin trolley body shells at the end of 2017. Items affected include PCC bodies (single and double-ended), Canadian light rail vehicles, double-end Kawasaki LRV, AC Brilliner, and Brill Bullet body shells. Over time future models will be switched to plastic. According to Mike Bartel, IHP resin subway and transit cars will continue to be available. 3D-printed parts to support the shells will also still be available. A limited number of the discontinued resin items are still available, however they will not be replaced when sold out. For additional information visit ihphobby.tripod.com.



A new production run of cylindrical covered hoppers is scheduled for release early next year from **InterMountain Railway**. The HO scale ready-

to-run models will have trough hatches, etched metal roof walks, and four discharge hoppers. Six road numbers each will be available for CPWX Canada, CNWX Canada, ALNX Alberta, ALPX Alberta, CNWX Canadian Wheat Board, CPWX Canadian Wheat Board, Santa Fe (ex Koppel), and Ferrocarriles Nacionales de Mexico.

InterMountain has set May 2018 for the release of its Value Line Gunderson 50-foot High-Cube boxcar. The HO scale ready-to-run

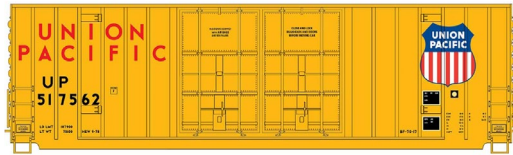

model has a flat roof, Dreadnaught ends, and a pair of Youngstown plug doors on each side. Road names will be Minnesota, Dakota & Western; Burlington Northern, BNSF, Milwaukee Road, Santa Fe (with quality Q in upper righthand corner), Santa Fe (large cross logo), CP Rail, Golden West Service, and Union Pacific.



The production run will include a similar Gunderson car with a peaked roof. It will be decorated for Denver & Rio Grande Western, Golden West, and two schemes each for Southern Pacific, and SSW-Cotton Belt. For additional information on all InterMountain products contact a dealer or visit intermountain-railway.com.

.....



New ready-to-run models coming from **Kadee Quality Products** in January include an HO scale version of this

40-foot Union Pacific PS-1 boxcar. Like the prototype, Kadee's model will have 8-foot Pullman-Standard 6-panel doors. Kadee will decorate the model based on a red oxide repaint applied to the prototype in June 1973.

Also due in January is a 50-ton AAR standard twin-bay coal hopper decorated for Gulf, Mobile & Ohio. Kadee's HO scale version is based on a prototype built in 1949. For additional information on all Kadee products contact a dealer or visit kadee.com.

.....



ITLA Scale Models has introduced York Industries, Inc. in HO scale. A laser etched and cut wood

structure, it can be arranged in multiple configurations, including “full flat,” “shallow relief,” and at least 10 different footprints from rectangles to a variety of L and Z shapes. A roof panel is included for three of the basic configurations, with others requiring the builder to supply a roof panel. The kit features tab and slot construction, Produits M.P. detail castings, rear loading dock walls, roof top details, three entry doors, surface details such as electrical conduits, meters, steps, handrails, vents, and trim; and many other detail items, including a full color sign sheet with several potential building names. For more information see itlascalemodels.com.

.....



Nick and Nora Designs is selling an HO scale kit called Carbone's Service Station. The kit includes laser-cut wood components, Tichy doors and windows, laser-cut peel and stick shingles, and

color signage. The assembled model has a footprint is 8 x 5 inches. For additional information visit nickandnoradesigns.com.

.....

Rapido Trains continues work on developing a new Gunderson 53-foot double-stack well-car. Delivery is planned for next summer. The deadline for reservations is February 9, 2018. The model



features a die-cast body with injection-molded plastic running boards, end handrails and extensive brake detail. The trucks are a new 70-ton design with separate in-line brake shoes, visible springs, and 33-inch metal wheelsets.

Well-car paint schemes will include CP Canadian Pacific, DTTX TTX (as delivered), DTTX TTX (Forward Thinking logo), and undecorated. At 74 feet in length over the strikers, the cars can carry 20- to 53-foot containers in the well with 40- to 53- cans in the top position.



Rapido is also tooling a 53-foot Hyundai high-cube container that will feature riveted sheet/post sides

and an optional heater box/fuel tank. Carrier names on the containers will be HUBU-BNSF/HUB Group, CNRU-CN Intermodal, CNRU- CN We Deliver, CNRU-CN Worldwide, CPPU Canadian Pacific, CSXU (Intermodal boxcar), JBHU- J.B.Hunt, SNLU-Schneider National, and undecorated. For additional information on all Rapido products contact a dealer or visit rapidotrains.com.

ScaleTrains.com has announced the second run of their Rivet Counter Tier 4 GEVo locomotive in HO scale for early 2018 delivery. Included in this run is GECX #2015, one of the demonstration locomotives that sported a unique paint scheme, split horns (cab roof and radiator wing), and a full length fuel tank with internal waste tank. The fuel and waste tank combo was not duplicated on

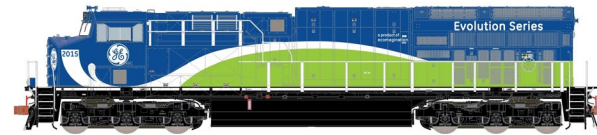

later demonstration and production units. Also announced were

BNSF 3764, 3797, and 3824 from the 3764-3838 series built in 2016; BNSF 3911 from the 3911-3915 series built in 2015; CN 3013 and 3034 from the 3000-3038 series, built in 2015; CN 3100 and 3126 from the 3039-3126 series, built in 2016; CSX 3290 and 3357 from the 3250-3374 series, built in 2015; CSX 3392 and 3405 from the 3375-3405 series, built in 2016; NS 3649, 3668, 3672, and 3675 from the 3647-3680 series, built in 2017; and UP 2570, 2599, 2634, and 2653 from the 2570-2669 series, built in 2015-2016. For more information visit your dealer or scaletrains.com/collections/rivet-counter-ho-scale-ge-tier-4-gevo.



Sunset Models is nearing completion of the Harriman passenger car project -- its first venture into the HO scale plastic market. Details include full interiors with figures

and lighting. Five car types are being produced including 60-foot coaches, a lunch car, and a business car with an observation platform. Seventy-foot cars include an RPO and a baggage car.



Road names will be Southern Pacific, Union Pacific, Santa Fe, Chicago & North Western, Erie, Lackawanna, Jersey Central,

NOVEMBER NEWS | 26

Illinois Central, Reading, Rock Island, and Chicago, Burlington & Quincy. The Harriman cars will be available separately or in a six-car set with two coaches. All sales will require an advance reservation. For additional information contact a dealer or visit goldengatedepot.com.



New HO scale motive power coming from **Walthers** early next year includes EMD

SD70Ace diesels with ESU Sound and DCC. The Mainline series locomotive has the same power drive system as Walthers more expensive Proto series. The locomotive model includes molded drill starter points to make it easier for hobbyists to install grab irons, which are sold separately. In addition to the Ferromex unit shown above, road names will be Arkansas & Missouri, CSX, Norfolk Southern, and Providence & Worcester.



A Canadian National unit repainted on an ex-EMD demo loco will also be available.



New rolling stock coming soon from Walthers includes this Mainline series 40-foot PS-1 boxcar. It features an early ver-

sion of Pullman-Standard ends and a P-S bowtie roof with flat steel panels. Additional details include a see-through steel running board and 6-foot Superior doors. The HO scale ready-to-run model is due next month. Road names include Richmond, Fredericksburg & Potomac; ACL, Reading, Monon, Western Pacific, and Alaska Railroad.

NOVEMBER NEWS | 27



Also due from Walthers in December is a new release of Mainline series 54-foot Pullman-Standard 4427 cu.ft. CD covered hopper

cars. Since their last release six years ago, the HO scale models have been updated with see-through running boards and 100-ton roller-bearing trucks with machined metal wheelsets. Road names on this latest run will be Chicago, Burlington & Quincy; Santa Fe, Cargill, Chicago & North Western, Milwaukee Road, Union Pacific, and Lehigh Valley.



New intermodal equipment coming from Walthers includes 53-foot NSC well-cars. The Mainline series models will be available as

individual cars as well as in three-unit car sets. The die cast metal models come with 36-inch machined metal wheelsets. The HO scale cars can accommodate 20- and 53-foot containers in the wells, and 40- and 53-foot containers in the top loaded position. Decorating schemes include BNSF, TTX/DTTX, and TTX/DTTX with the new red logo. The well cars are scheduled for release in December.

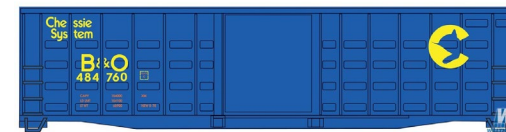

Walthers HO scale rolling stock scheduled for release early next year includes a Mainline series 50-foot

waffle side boxcar with proprietary plug doors. Superior doors will be used on cars decorated for Chicago & North Western, Santa Fe, and Chessie System/Baltimore & Ohio (above). Cars decorated for Burlington Northern, Illinois Terminal, and Delaware & Hudson will have Youngstown doors. Availability is planned for January 2018.



New intermodal equipment released by Walthers includes 20-foot corrugated containers with significantly improved door latch detail. In addition to Tropical, carrier names on the HO scale models will be Alianca, CMA-CGM, COSCO, Genstar, K-Line, P&O Nedlloyd, and UASC.



This HO scale 53-foot Singamas corrugated North American domestic container is scheduled for release next month. Carrier names will be Axsun, APL Logistics, CSX, Dart, EMP, and XPO Logistics. For additional information on all Walthers products contact a dealer or visit walthers.com.



Yarmouth Model Works currently plans to release four new HO scale resin boxcar kits at the Chicagoland RPM show in Lisle, IL in October. Included are an Atlantic Coast Line O-16-B rebuilt automobile boxcar and AC&F built 40-foot steel boxcars for ACL, DT&I, and WIF. All kits will feature one-piece resin castings, custom decals and photoetched parts, and correct trucks. The kits will be available online at yarmouthmodelworks.com.

N SCALE PRODUCT NEWS

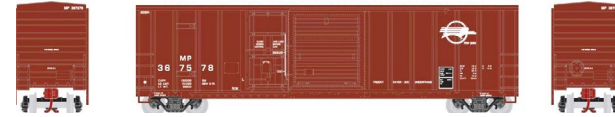

New N scale models coming from **Athearn** next September include

this FMC 50-foot combo door boxcar. Notable features on the model include a plug door and a Youngstown sliding door on each side. Additional spotting features are the distinctive outside posts, non-terminating ends, and screw mounted trucks with machined metal wheelsets. The 1970s-era decorating schemes include Minnesota, Dakota & Western; Burlington Northern, Missouri Pacific, Seaboard Coast Line, Railbox (Primed for Grime paint), Union Pacific, and undecorated.



Completing Athearn's N scale releases for September

2018 is a 53-foot GSC flat car. Depending on the practice of the prototype railroad being modeled, the car will have either 50-ton Bettendorf solid bearing or 70-ton roller-bearing trucks. Both truck styles will have 33-inch machined metal wheelsets. Road names will be Great Northern, Trailer Train, Milwaukee Road, Missouri Pacific, Pittsburgh & Lake Erie, and SSW-Cotton Belt. For additional information on all Athearn products contact a dealer or visit athearn.com.

Atlas Model Railroad Company is working toward a second quarter release of a new N scale EMD GP39-2 diesel locomotive. The new model will feature directional lighting with golden-white LEDs, blackened metal wheels, painted hand railing, and



AccuMate magnetic knuckle couplers. A DC Atlas Silver series model will be available as well as an Atlas Gold series DCC unit with an ESU LokSound decoder. In addition to the ATSF Kodachrome scheme shown here, the Master series ready-to-run model will be available decorated for Santa Fe (blue and yellow), CSX (YN2 scheme), and Guilford D&H.



A new N scale 60-foot flat car with a die cast metal frame is coming from Atlas early next year. The ready-to-run Master series model will ride on BLMA 70-ton ASF Ride Control trucks fitted with BLMA low profile 33-inch wheelsets. Multiple road numbers will be available for BNSF, Conrail, SSW-Cotton Belt, Santa Fe, Western Pacific, and Trailer Train.



Completing Atlas's first quarter release of N scale models is a Trainman series 50-foot boxcar with a 9-foot Youngstown sliding steel door. Additional features include Improved Dreadnaught ends, a diagonal panel roof, and 50-ton solid bearing trucks. Road names will include Santa Fe, Boston & Maine, Central of Georgia, Atlantic Coast Line, Ferrocarril Del Pacifico, Missouri Pacific, and Northern Pacific (red, white, and blue Share in Freedom scheme). For additional information on all Atlas products contact a dealer or visit atlasrr.com.



Bowser is working on another release of its N scale ready-to-run GLa twin-bay coal hopper cars. Pre-orders are due by November 17 with availability expected in August 2018. Multiple car numbers will be available for Baltimore & Ohio (Capitol dome herald), Blue Coal (fantasy schemes for Delaware & Hudson, DL&W, and Reading), Cambria & Indiana, Green Bay & Western (red logo), Lehigh Valley (black and white diamond herald), Ontario & Western, and Waddell Coal.

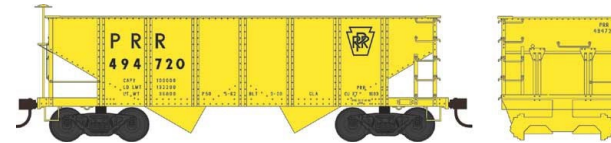

Pennsylvania Railroad GLa hoppers will be available in several schemes including an oxide body with circle keystone monogram, oxide body with shadow keystone, PRR MOW (yellow body, no keystone), and PRR MOW (yellow body with keystone, above). For additional information on all Bowser products contact at dealer or visit bowser-trains.com.



Con-Cor International has a limited quantity of 2017 Christmas cars available. This is the 52nd year that Con-Cor has offered items specially decorated for the holiday season. Two different ready-to-run models are available. One is decorated On Blitzen, the other is Santa's Foxy Helper. For additional information on all Con-Cor products contact a dealer or visit con-cor.com.

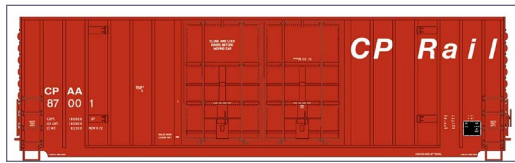

InterMountain Railway plans to release N scale Gunderson 50-foot High-Cube boxcars in March 2018. The N scale ready-to-

run model will feature a flat roof, Dreadnaught ends, and a pair of Youngstown plug-doors on each side. Road names will be Minnesota, Dakota & Western; Burlington Northern, BNSF, Milwaukee Road, Santa Fe (with quality Q in upper righthand corner), Santa Fe (large cross logo), Golden West Service, Union Pacific, and CP Rail.

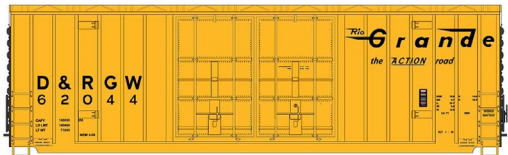

InterMountain's March production run will include the same Gunderson car except it will have a peaked roof. The N scale model will

be decorated for Denver & Rio Grande Western, Golden West, and two schemes each for Southern Pacific, and SSW-Cotton Belt. For additional information on all InterMountain products contact a dealer or visit intermountain-railway.com.



New items available this month from **Micro-Trains Line** include this 56-foot GS tank car decorated for South Dakota Soybean

Processors. The ready-to-run N scale model rides on Barber roller-bearing trucks.

Also new from Micro-Trains is a Union Pacific 50-foot boxcar with 10-foot Youngstown sliding doors. Spotting features for this N



scale model include short ladders, no running board, and an extended cushion underframe.



This Burlington Northern 50-foot Airslide covered hopper car features well-detailed outlet fixtures and underframe, and 100-ton

Barber roller-bearing trucks. The N scale ready-to-run model is based on a prototype built in 1972. For additional information on all Micro-Trains Line products contact a dealer or visit micro-trains.com.



Model Tech Studios is selling N scale bulk detail packs, including 12 packs of: Milk Cans, Old Wooden Barrels, Beer Kegs, and Oil Drums. The detail items are finished and layout ready. For more information go to



modeltechstudios.com.

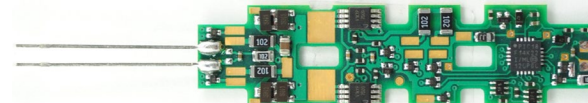

Train Control Systems has developed the K0D8-F

drop-in DCC decoder for the new N scale Kato FP7A locomotive. The eight-function decoder includes one sunny white LED mounted to the board and onboard resistors for functions

F1-F4 for use with LEDs and 1.5V bulbs. Functions F5-F6 output at 12V. The decoder is also equipped with auto-adjusting Back EMF for slow speed performance and Quiet Drive for quiet engine performance. Info at tcsdcc.com.

NEW DECALS, SIGNS AND FINISHING PRODUCTS



Dakota's Railroad and Circus Shop now has available water slide decals for modeling RBOX40188, recently repainted into a pink Cancer Awareness scheme. Complete cars are also available. Part of the proceeds go to support families of children with cancer. To order or for more information, call 815-295-5409 or facebook.com/dakotasrailroadshop.

Great Decals is now selling decals for the Louisville and Nashville (L&N) triple bay 180000 series hopper cars. Available in white or yellow, each set of the HO scale decals provides 14 road numbers and additional numbers to make up different ones. See the website at greatdecals.com for more information.

New decals from Microscale Industries include N, HO, and O scale lettering sets for Rutland Railroad diesel locomotives

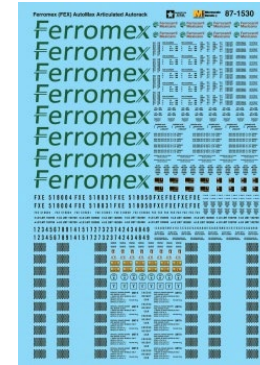

from 1956 to 1964. The set (far left) includes yellow safety striping. Also new are N and HO scale decals for Ferromex (FEX) AutoMax articulated Autorack cars (right). For additional information on all Microscale products contact a dealer or visit microscale.com.

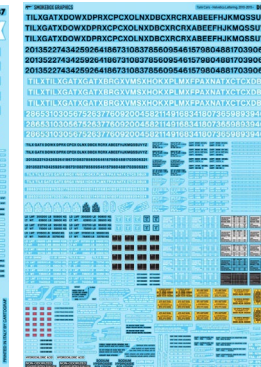

Smoke Box Graphics has released three new HO scale lettering sets. These are top quality water-slide decals silk screened in Italy by Cartograf. Item DF5487 (far left)

is for 50-foot leased boxcars with Helvetica lettering including BKTY, WRWK, EEC, and GATX (billboard style). The set includes sufficient material to decorate up to four cars.

Item DF5587 (above right) is for modern tank cars using Helvetica lettering. This large set covers cars from many different owners, five Chemtrec labels, hazmat placards, and an assortment of tank car data. Also new is item DF5687 that contains material for replicating patch stencils using 4- and 9-inch sans serif lettering in both black and white.

SBG creates the artwork for their HO decals by digitally tracing photos of actual freight cars and railroad-specific lettering diagrams. Each set contains dimensional data, spare numbers, and reweigh/repack data to accurately model a majority of cars within the number series represented. For additional information including ordering instructions visit smokeboxgraphics.com/decals.html.

i SEND US YOUR PRODUCT ANNOUNCEMENTS

If you are a hobby manufacturer with a product announcement, just [click here](#) and submit your announcement to us. Our web site and free magazine reach continues to grow, so get on board this new media train! ■

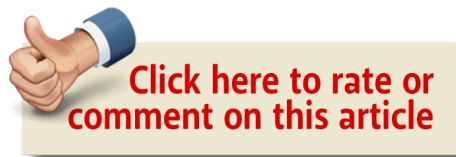

DISCLAIMER

The opinions expressed in this column are those of the writer and do not necessarily reflect the opinion of *Model Railroad Hobbyist* or its sponsors. Every effort is made to provide our readers with accurate and responsible news and information, however, neither *Model Railroad Hobbyist* or the writer of this column can be held responsible for any inaccuracies or typographical errors that may inadvertently appear in this column.

! BRIEFLY NOTED AT PRESS TIME ...

Blackstone Models is booking reservations for its second release of HOn3 Denver & Rio Grande Western 30-foot refrigerator cars. A release date has not been announced. D&RGW decorating schemes will be Flying Grande and Moffat Tunnel. The ready-to-run models will be based on a prototype rebuilt in 1926 with Murphy roofs. Info at blackstonemodels.com ...

Bowser has released eight versions of its HO scale MLW M636 diesel locomotive. Road names include Minnesota Commercial, Delaware-Lackawanna, Western New York & Pennsylvania, Cartier Railway, and two schemes each for CN and CP Rail. Both DC and DCC models are available now. Details at bowser-trains.com ...

Centralia Car Shops is accepting reservations for a new run of 6-6-4 lightweight sleepers with interior lighting. Sixteen decorating schemes will be available for the N scale smooth-side cars. Delivery is planned for May or June 2018. Info at intermountain-railway.com ...

Elgin Car Shops introduced new resin kits for AC&F post-war 50-ton 40-foot steel boxcars at the Chicagoland RPM. Created by Pierre Oliver, the prototypically accurate HO scale kits feature a one-piece resin body, AC&F proprietary ends and roof, custom decals, etched metal details, and Kato ASF A-3 trucks. More info at elgincarshops.blogspot.ca ...

Highball Graphics has released new HO scale decals for P&LE 53-foot mill gondolas, CP Rail NSC ballast cars, D&H PS 3300 twin-bay covered hoppers, B&M 75000 series PS-1 40-foot boxcars, B&LE 100-ton triple-bay open hoppers, and BC Rail bulkhead flat cars. Details at highballgraphics.com ...

.....

! BRIEFLY NOTED AT PRESS TIME CONTINUED...

InterMountain Railway plans to release both HO and N scale versions of ACF 4650 cu. ft. triple-bay covered hoppers next May. Info at intermountain-trains.com ...

Protocraft owner Norm Buckhart reports that both his home and business were impacted by the fires raging in the wine country of Northern California. Norm and his wife were forced to evacuate their home in Sonoma. Firefighters were able to control the fire in the building housing Protocraft and damage was held to a minimum. Norm expects things will be back to normal within a few weeks and asks that customers be patient.

Speedwitch Media is reprinting four of the Focus on Freight Cars series that are currently out of print. Volumes being reissued are Steel Automobile Cars, Refrigerator Cars Part 2, Rebuilt Box & Automobile Cars, and Single-Sheathed Box & Automobile Cars. More info at speedwitchmedia.com ...

.....



Click here to rate or
comment on this article



The Amherst Railway Society Railroad Hobby Show

Our 2018 Show will be

January 27 & 28, 2018

Save the dates!

Click
to learn
more ...



About The Show

Every year late in January or early in February, the Amherst Railway Society holds its Railroad Hobby Show at the Eastern States Exposition Fairgrounds (The home of The Big E) in West Springfield, Massachusetts. More than 25,000 railfans and public attended the Show each of the past three years.

The event features real life railroads and scale model railroads, historical societies, travel agencies, art shows, flea market dealers, importers, manufacturers and photographers. You have to see it to believe it!





SELECTED EVENTS

November 2017

(Please note that many events charge a fee. Check individual info website for details.)

CANADA, LAVAL, November 4-5, Expo-Train Modelisme Laval, at Polyvalente Georges-Vanier, 3995 Boulevard Levesque Est. Info at expo-train.com.

CANADA, ST JOHN NB, November 4, SJSMR 33rd Annual Model Train Show, at Island View Lions Club, 8 Market Street, Quispimisis. Info at sites.google.com/site/sjsmrclub.

CALIFORNIA, ROSEVILLE, November 11-12, International Railfair at Placer County Fairgrounds, 800 All American City Boulevard. Info at internationalrailfair.com.

CALIFORNIA, SIMI VALLEY, November 4, Swap Meet, sponsored by Santa Susana Railroad Historical Society, at 6503 Katherine Road. Info at santasusannadepot.org/Clubhome.html.

FLORIDA, BOCA RATON, November 18, Swap Meet sponsored by South Florida Railway Museum & Model Railroad Club, at St. Paul Lutheran Church, 701 West Palmetto Park Road. Info at sfrm.org.

LOUISIANA, METAIRIE, November 25, Crescent Lines Open House, at 601 North Lester Avenue, sponsored by the Crescent City Model Railroad Club. Info at ccmrc.com.

MICHIGAN, ANN ARBOR, November 26, 2017, Southeast Michigan Model Railroad Flea Market & Show, Washtenaw Farm Council Grounds, 5055 Ann Arbor Saline Rd.

MICHIGAN, EAST LANSING, November 5, Lansing Model Railroad Club Show & Sale, at Michigan State University Pavilion, 4301 Farm Lane. Info at lmrc.org.

MISSOURI, TOWN AND COUNTRY (CHESTERFIELD), November 4, NMRA Gateway Division, Model Train Show and Contest, at Trinity Lutheran Church, 14088 Clayton Road. Info at gatewaynmra.org/st-louis-train-show.

NEW JERSEY, NORTH HALEDON, November 24-26, Annual Open House sponsored by Garden State Model Railway Club at 575 High Mountain Road. Info at modelrailroadshow.com.

NEW MEXICO, LOS LUNAS, November 4-5, Fall Model Train Show & Swap Meet, sponsored by South West Model Railroad Club, at Mid Valley Air Park, 65 Elaine Drive. Info at swmrctrains.com.

NEW YORK, BATAVIA, November 12, The Great Batavia Train Show, at Quality Inns and Suites, 8250 Park Road. Info at gsme.org.

OHIO, SPRINGFIELD (DAYTON), November 4-5, 42nd Annual Dayton Train Show, at Upper Valley Mall, 1475 Upper Valley Pike. Info at daytontrainshow.com.

OREGON, ADAIR VILLAGE, November 25-26, December 2-3, Open House sponsored by Corvallis Society of Model Engineers, at 7155 NE Vandenburg Avenue. Info at csme1959.org/aboutus.html#openhouse.

PENNSYLVANIA, ALLENTOWN, November 11-12, First Frost Train Swap Meet, at Allentown Fairgrounds, Agricultural Hall, 302 North 17th Street. Info at allentowntrainmeet.com.

PENNSYLVANIA, ALTOONA, November 2-3, Fine Scale Model Railroad Expo, at Blair County Convention Center. Details at info@modelrailroadexpo.com.

SELECTED EVENTS | 3

RHODE ISLAND, NEWPORT, November 9-12, NMRA Northeastern Region Convention, at Atlantic Resort Newport. Info at newport2017.org.

SOUTH CAROLINA, NORTH CHARLESTON, November 18-19, 6th Annual Train Show, sponsored by the Charleston Area Model Railroad Club, at Danny Jones Armory Park, 5000 Lackawanna Blvd. Info at chamrc.com.

TEXAS, BULVERDE, November 11-12, The Enjoyment of Model Railroading, presented by San Antonio N-Trak Association at Bulverde Spring Branch Library, 131 Bulverde Crossing. Info at santrak.org.

UTAH, SANDY, November 11-12, Intermountain Train Expo, hosted by NMRA Northern Utah Division, at South Towne Expo Center, 9575 South State Street. Info at intermountain-trainexpo.com.

WASHINGTON, KENT, November 11, Annual Swap Meet, sponsored by Boeing Employees Model Railroad Club, at 525 4th Avenue North. Info at swapmeet@bemrrc.com.

WISCONSIN, WEST ALLIS (MILWAUKEE), November 11-12, Trainfest, at Wisconsin State Fair Park, 8200 West Greenfield Ave. Info at trainfest.com.

December 2017, by location

MASSACHUSETTS, MARLBOROUGH, December 2-3, Annual New England Model Train Expo sponsored by NMRA Northeastern Region HUB Division, at Best Western Royal Plaza Trade Center, 181 Boston Post Road West. Info at hubdiv.org.

NEW YORK, ALBANY, December 3, Annual Great Train Extravaganza, at Empire State Convention Center. Info at gteal-bany.com.

SELECTED EVENTS | 4

NEW JERSEY, EGG HARBOR TOWNSHIP, December 9-10, Train Show sponsored by Shoreline Model Railroad Club, at Atlantic Christian School, 391 Zion Road. Request info from Dennis Weiss at trains1971@comcast.net.

NEW JERSEY, NORTH HALEDON, December 2-3, and 9-10, 60th Annual Open House sponsored by Garden State Model Railway Club at 575 High Mountain Road. Info at modelrailroad-show.com.

OHIO, LIMA, December 16, Train Town Show & Swap Meet, sponsored by NMRA NCR Three Rivers Division at Allen County Fairgrounds, Merchants Building, 2750 Harding Highway. Info at div3.ncr-nmra.org.

Future 2018, and beyond by location

CANADA, BRITISH COLUMBIA, BURNABY, May 4-6, 2018, 3rd Annual 7th Division PNR Modellers Meet, at Simon Fraser University (Burnaby Campus), West Mall Centre. Info [facebook.com/RailwayModellersBritishColumbia](https://www.facebook.com/RailwayModellersBritishColumbia).

GEORGIA, ROSWELL (Metro Atlanta), January 13, 2018, O Scale South 2018, at Cross of Life Lutheran Church, 1000 Hembree Road. Sponsored by the Southern O Scalers and the Model Railroad Club of Atlanta. Info at oscalesouth.com.

MARYLAND, ROCKVILLE, August 22-26, 2018, 50th O scale National Convention, Co-sponsored by NMRA MER, Standard Gauge, Narrow Gauge, P48 and Traction modelers, at Rockville Hilton Hotel, 1750 Rockville Pike. Info at 2018oscalenational.com/newsletters/september-2017-newsletter.

MISSOURI, KANSAS CITY, August 5-12, 2018, NMRA National Convention and National Train Show. Host hotel is Westin Kansas City at Crown Center. Info at kc2018.org.

SELECTED EVENTS | 5

UTAH, SALT LAKE CITY, July 7-13, 2019, NMRA National Convention and National Train Show. Host hotel is Little America Hotel. Info at nmra2019slc.org.

MISSOURI, ST. LOUIS, July 12-18, 2020, NMRA National Convention and National Train Show. Host hotel is Hilton St. Louis at the Ballpark. Info at gateway2020.org.

CALIFORNIA, SANTA CLARA, 2021, NMRA National Convention and National Train Show. ■



Click here to rate or
comment on this article



Did you know ...

■ MRH subscribers
SAVE 10%

... on the MRH Store &
on TrainMasters TV?

Click to get 10% off coupon code
(Must be a subscriber to access)



NOVEMBER 2-4*

THE EXPO GOES TO ALTOONA, PA

HOME OF HORSESHOE CURVE!

LEARN. BUILD. CREATE. ENJOY MODELING AT ITS BEST.

MODELRAILROADEXPO.COM

Clickable advertiser index – 1

[Accu-Lites](#)
[American Ltd \(San Juan\)](#)
[Amherst Railway Society](#)
[Archer Fine Transfers](#)
[Athearn](#)
[Atlas Model Railroad Co.](#)
[All Scale Trains Magazine](#)
[Bachmann](#)
[Backdrop Junction](#)
[Berrett Hill Trains](#)
[Black Cat Publishing](#)
[Blair Line](#)
[Bowser](#)
[Coastman Scenic Products](#)
[Caboose](#)
[Canyon Creek Scenics](#)
[Coffman Graphics](#)
[Con-Cor](#)
[Crow River Products](#)
[Digitrax \(2 page spread\)](#)
[East Penn Traction Co.](#)
[El Dorado 3rd PlanIt](#)
[ESU LokSound](#)
[Fast Tracks](#)
[Fine Scale Miniatures](#)
[Fine Scale Model Railroad Expo](#)
[Good Deals DCC](#)
[Great Decals](#)
[ISE Electronics](#)
[ITLA Scale Models](#)
[Kadee \(1\)](#)
[Kadee \(2\)](#)

[Ken Patterson.com](#)
[Lights 4 Models](#)
[Litchfield Station](#)
[Logic Rail Technologies](#)
[Main Street Heritage Models](#)
[Micro-Trains Line](#)
[Modeltech Studios](#)
[Model Railroad Benchwork \(1\)](#)
[Model Railroad Benchwork \(2\)](#)
[Model Railroad Control Systems](#)
[Mountain Subdivision Hobbies](#)
[MRH Store \(1\)](#)
[MRH Store \(2\)](#)
[MRH Store \(3\)](#)
[Mt Albert Scale Lumber](#)
[NCE \(2 page spread\)](#)
[North American Railcar Co.](#)
[Pre-Size Model Specialities](#)
[Precision Design Co.](#)
[Rapido \(1\)](#)
[Rapido \(2\)](#)
[Ring Engineering \(1\)](#)
[Ring Engineering \(2\)](#)
[Rulers-of-the-World](#)
[Scale Trains](#)
[Scotty Mason Show](#)
[Sea Port Model Works](#)
[Soundtraxx \(Blackstone\)](#)
[Southern Digital](#)
[Streamlined Backshop Services](#)
[TAM Industries](#)
[TAM Valley Depot](#)

Clickable advertiser index – 2

[The DCC Shop](#)
[Tony's Train Exchange](#)
[Trackside Flats](#)
[Trainfest](#)
[Traintek](#)
[TrainMasters TV \(1\)](#)
[TrainMasters TV \(2\)](#)

[TrainMasters TV \(3\)](#)
[TSG Multimedia](#)
[Walthers](#)
[Westerfield Models](#)
[Yankee Dabbler](#)
[Yarmouth Model Works](#)

Clickable "other" index

[Other – Contents](#)
[Other – Cover](#)
[Other – Derailments](#)
[Other – Hobby Marketplace](#)
[Other – MRH Sponsors](#)
[Other – Yes it's a model](#)

DOWNLOAD ISSUE

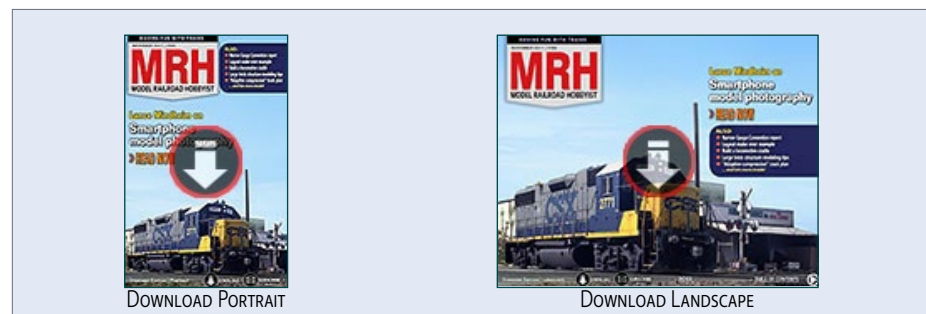



REVERSE RUNNING

commentary

DON HANLEY
.....



[Click here for reader comments](#)

IS SCENERY OVERRATED?

LET'S BE HONEST: WHEN WE SEE A WELL-SCENICKED



layout we tend to drool as we watch the trains run. But just how necessary is all that eye candy? What is the point of having a well-scenicked layout if it runs poorly?

I am building a switching layout, and operations are important to me. I am currently testing the track to make sure the locomotives and rolling stock perform perfectly on the trackwork.

All this testing is easier said than done, since I have chosen to model some poorly-maintained industrial sidings on this switching layout.

Even if the track performs well, the equipment that runs on the layout must work without any glitches too. It's amazing how rolling stock that operated flawlessly when carefully packed away a decade

▶ **STEPPING OUTSIDE THE BOX WITH A CONTRARY VIEW**

ago doesn't work when its unpacked and put on the track now. I am finding I need to go over each piece and carefully re-tune it.

I have completed some scenery and plan to eventually do more. Recently I added a new street crossing, carefully sanding, cutting and fitting using my NMRA gauge.

First trip through the new crossing the locomotive stalled! After four more cycles of sanding and testing, the locomotive finally will creep through the crossing.

Now I have to build the street!

After searching through my stash for some detail parts, I found the mold masters I had made many years ago for storm drains, manholes, and fire hydrants.

I wasn't particularly looking for these molds, but I finally found them when I was looking for something else.

When I made the streets for my 3D backdrop story in MRH, I couldn't find those molds masters, so I used rust-colored chalk and simple templates to draw storm drains and manholes on the street.

Now that I found the molds again, I *have only to make* castings and add them to the existing streets. Nothing is *more fun* than adding details on the layout instead of at the workbench when it would have been much easier. Maybe I am a glutton for punishment?

I have seven large structures planned, and having previously built a structure for a friend's layout, I know how much work is involved. A name tag on the location works just fine for operation.

I also have had the misfortune of wiping out scenic detail while operating on a layout. There are very few thing in life more humbling than taking the broken detail pieces to the owner of the layout and confessing your sin. I don't want to put any of my friends in that position!

I'm beginning wonder if a Plywood Prairie might not be such a bad idea ...



DERAILMENTS

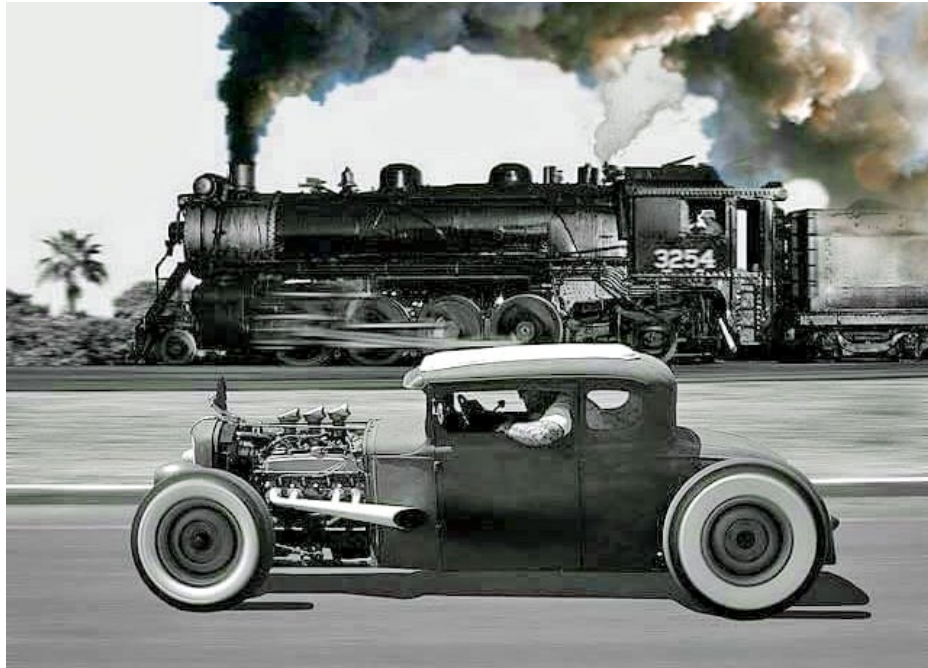

Photo courtesy of Larry Sapia

Drag race?

The 3254 is an S-1-b Mikado owned by the Canadian National. On Canadian National, the “S” meant a 2-8-2 wheel arrangement, the “1” meant it was the first design of this wheel arrangement and the “b” meant it was the second production run. It was built in 1917 to pull heavy freight trains and was retired in 1958. It is currently part of the Steamtown locomotive collection. ■

► BIZARRE FACTS AND HUMOR (SUPPOSEDLY)

OFF THE RAILS ...

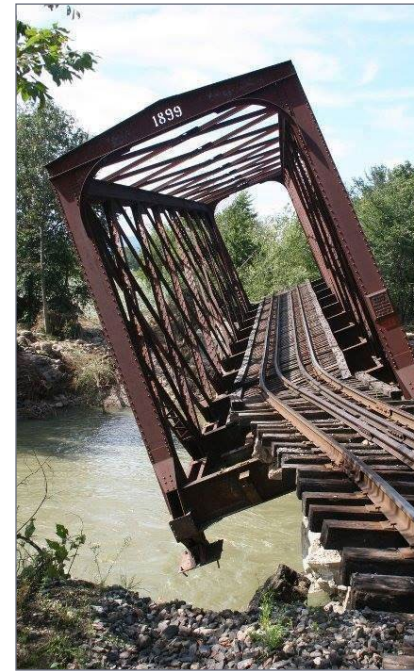

💰 GET PAID ...

If you're the first to submit a bit of good humor or bizarre facts and we use it, it's worth \$25! Just send to derailments@mrhmag.com ■

Your worst nightmare

Your train comes around the corner on the approach to the bridge and this is what you see ... let's hope those emergency brakes can stop things in time!

Coming next issue ...

- We get an update on George Sellios and his Franklin & South Manchester layout.
- Use craft paints to replace Floquil weathering colors
- Twin Ports TOMA by James Moe
- PC boards for model railroaders
- And lots, *lots* more!



Click here to rate or comment on this article

