

HAVING FUN WITH TRAINS

JULY 2017 | FREE

MRH

MODEL RAILROAD HOBBYIST

ALSO:

- Modeling a modern industrial park
- Kadee coupler install tips
- Port of Tacoma layout design
- Quick scenery with polyfiber mats
- DCC install tips in brass

... and lots more inside!

Bill Brillinger examines Potash car operations

»» **READ NOW**



STANDARD EDITION | PORTRAIT



DOWNLOAD



SUBSCRIBE

(free)

Your Next Great Layout is Only a Page Away!

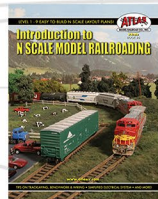
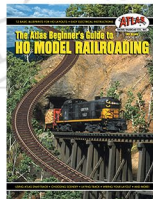
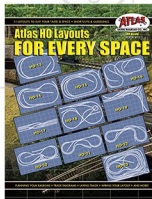
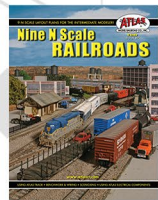
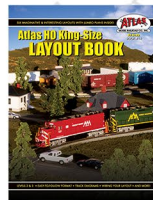
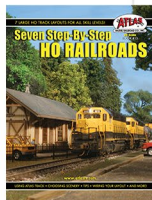
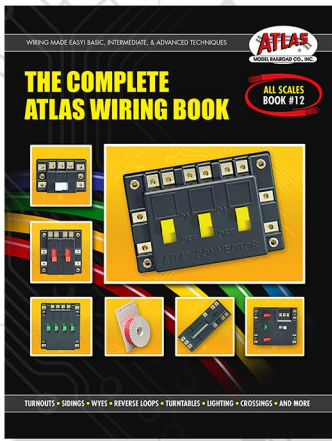

Having trouble designing your layout? Atlas has done the work for you with our comprehensive line of **N, HO & O scale layout books**. We'll put you on the right track!

CLICK HERE!

If you prefer to design your own layout, we have you covered with our free **Atlas Track Planning Software**. Download a copy today and start designing the layout of your dreams.
<http://www.atlasrr.com/software.htm>

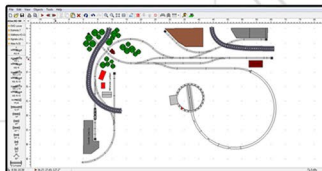



STAFF CREDITS

(Updated 7/1/2017)

Front cover: In our cover story, Bill Brillinger takes us through the entire process of preparing and operating with potash cars on his railroad.

ISSN 2152-7423

Editorial Staff

Joe D. Fugate, Publisher and Editor

Don Hanley, Assistant Editor

Production

Patty Fugate, Pasteup and Layout

Joe Brugger, Copy Editing

Mike Dodd, Copy Editing

Technical Assistant

Jeff Shultz

Advertising

Les Halmos, Account Manager

Daniel Nava, Advertising Assistant

Jean-François Delisle, Marketing Assistant

News and Events

Richard Bale, News and events

Jeff Shultz, News and events



Columnists

Les Halmos, Modular railroading

Larry Smith, Narrow Gauge/Shortlines

Bruce Petrarca, DCC

Ken Patterson, Reporter at large

Rotating Columnists

Jack Burgess, Getting Real column

Nick Muff, Getting Real column

Mike Rose, Getting Real column

Tony Thompson, Getting Real column

Rob Clark, Imagineering

Dave Meek, Imagineering

Ray Dunakin, Imagineering

Issue password: Jul2017

Published for the glory of God. [What's this?](#)





MRH SPONSORS

A - E



acculites.com



americanlimitedmodels.com



railroadhobbyshow.com



anemodel.com



archertransfers.com



athearn.com



www.atlasrr.com



bachmantrains.com



bachrus.com



backdropjunction.com

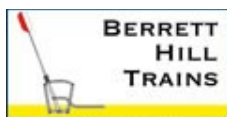

berrethill.com/trains



blairline.com



bowser-trains.com



coffmaneng.com



www.digitrax.com



esu.eu/en

[Vendors: Get your clickable logo here ...](#)

MRH SPONSORS | 2

F - R



www.handlaidtrack.com



foxvalleymodels.com



www.iascaled.com



lights4models.com



litchfieldstation.com



store.mrhmag.com



stores.ebay.com/Motrak-Models



mtalbert.com



37nngc.com



ncedcc.com



nickandnoraesigns.com



nwhs.org



www.pwrs.ca/main.php



rapidotrains.com



ringengineering.com

[Vendors: Get your clickable logo here ...](#)

• [INDEX](#)



[SUBSCRIBE](#)
(free)

• [TABLE OF CONTENTS](#)

MRH SPONSORS | 3

S - Z



sanjuancarco.com



scaletrains.com



selectmodelrailroads.com



soundtraxx.com



sodigi.com



sbs4dcc.com

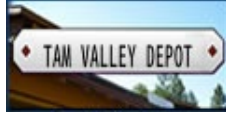

tamvalleydepot.com



tcsdcc.com



tonystrains.com



traintekllc.com



tsgmultimedia.com



walters.com



yankeedabbler.com

[Vendors: Get your clickable logo here ...](#)

Looking for something? Check the MRH Marketplace!

Take me there!

**FINAL
KIT!**



FINE SCALE MINIATURES

FSM is closing its doors after 50 years of business!



I.M. Dunn Co. \$280 + S&H



*Destined to become an
instant collector's item*

BUY NOW >>

Brought to you by the MRH Store: store.mrhmag.com

• INDEX



SUBSCRIBE
(free)

• TABLE OF CONTENTS



TABLE OF CONTENTS

FEATURES

Deploying potash cars

WILLIAM J.A. BRILLINGER

Acquiring, preping, and operating potash cars



East Pittsfield industrial park

BARRY SILVERTHORN

Modeling modern industries on our TOMA layout



Poly fiber mats

RICK WADE

Fast and easy scenery using simple materials



Kadee-style coupler installation

WILLIAM MOSTELLER

Tips / tricks for better Kadee coupler installs



One Module Challenge: Second place

SCOTT WILLIAMSON

Modeling the Port of Tacoma using TOMA



ALSO: MRH Marketplace | Subscriber extras

TABLE OF CONTENTS | 2

COLUMNS

MRH Q-A-T: Wire labeling, flextrack tips, and more

compiled by JOE BRUGGER

DCC Impulses: I'm retiring!

BRUCE PETRARCA

Getting Real: It's all in the details

NICK MUFF

What's Neat: Weathering a coal train and lots more

KEN PATTERSON

Photo feature: Yes, it's a model

compiled by DON HANLEY

Derailments: Bizarre facts & humor

compiled by the MRH STAFF

NEWS and EDITORIAL

Publisher's Musings: "TOMA with a twist" contest

JOE FUGATE

News & Events: July 2017

RICHARD BALE & JEFF SHULTZ

Reverse Running: Summertime doldrums

DON HANLEY



IN STOCK • LIMITED SUPPLY

H0 Union Pacific GTEL 8500 HP "Big Blow" Turbine
(Actual Model Shown)



Buy Now

© 2017 ScaleTrains.com, Inc. ScaleTrains.com, Museum Quality, Rivet Counter and respective logos are trademarks of ScaleTrains.com, Inc. ScaleTrains.com, Inc. 7598 Highway 411 Benton, TN 37307 - 844-9TRAINS 844-987-2467 International 423-299-3689



WWW.SCALETRAINS.COM



H0
F87 SCALE

Scene and photography by Ken Johnson

• INDEX

• TABLE OF CONTENTS



PUBLISHER'S MUSINGS

editorial

JOE FUGATE



[Click here to rate or comment on this article](#)

OUR NEW "TOMA WITH A TWIST" CONTEST

WE'RE MAKING SOME CHANGES FOR THIS year's layout design contest.

First, we're assuming a basement room that has stairs, a furnace, and a water heater that must to not be blocked. But that's not the biggest difference.

Instead of calling the contest *The "One Module" Challenge*, as we've done the last two years, we're taking a slightly different approach this time. We're hoping that this time around we can get entries that illustrate how adaptable TOMA ("The "One Module" Approach) can be. So we've named this year's contest "TOMA with a Twist."

Classic TOMA, as we've been discussing in these pages for the last few years, starts with a single 6- or 7-foot module, bookended by temporary staging tracks so you can run trains back and forth across your creation [1].



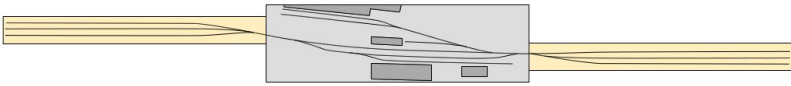

Classic TOMA

1. The classic starting TOMA configuration.

To help you think outside the box, your starting TOMA configuration can be more than this if you feel a strong desire to have continuous running early-on. In this configuration [2], you have one temporary double-ended staging yard connected with temporary loop tracks back to each end of the module, giving you continuous running right away.

But this isn't the only variation on classic TOMA. If you take on a bit larger task to build two TOMA modules instead of one to start with,

ADVERTISEMENT

MT. ALBERT LUMBER YARD

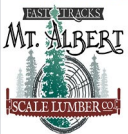

10" x 10" footprint as shown
\$125.00 free shipping

No. 11 in a Series of Limited Edition Craftsman Kits – HO Scale

- Three Complete Structures 3D Printed Cut Off Saw
- Sylvan 2 Ton Chevy Flat Bed Truck Kit
- Stoney Creek Corrugated Aluminum and Tar Paper Roofing
- Detail Parts from Faller, Grandt Line, & Tichy Train Group
- Laser Cut Plywood, LaserBoard & Real Wood Shingles
- Laser Cut Jigs for Pallets & Fencing
- Step-by-Step Instructions Flash Drive of Construction Photos

Mt. Albert Scale Models
320 St. Patrick St. Port Dover, ON, N4A 1N0 CANADA
mail@mtalbert.com www.mtalbert.com

ADVERTISEMENT

Backdrop Junction

Your Stop for Railroad Backdrops

[Click Here](#) →

For the Finest in Custom
Designed backdrop



www.backdropjunction.com



EMD 39 SERIES



DIESELS

ELECTRO MOTIVE **V 12** LA GRANGE ILLINOIS

2300hp



The D&H makes a return in an all new paint variant for the second run. The first run (pictured above) was very well received.

ALL IN THE FAMILY

ANNOUNCING THE BRAND NEW PHASE III ATHEARN® GENESIS® GP39-2

The right phase for the right road name...specifically! Building upon the GP39-2 first run, the brand new Phase III incorporates several body phases specific to the MKT and UP. This version has been offered in the market only as a brass diesel. Along with the new body variant, many separately applied details that are specific to each road name. Built upon our popular GP38-2, GP40-2, GP50 Genesis mechanism, these models achieve an entirely new level of "as close to real as it gets.™"



UPDATE! RTR SD39 DIESELS ARRIVING SEPTEMBER 2017



MNS #40 post 1982 Version

ATHG63839

Both the Athearn® RTR SD39 and the Genesis® GP39-2 share a level of detail never delivered in HO scale before. Our new RTR SD39 shares the same proven new mechanism from the popular SD38/40/45 and is available DCC and sound ready. The optional ATHG63839 Genesis motor retrofit kit makes speed matching a breeze.

DCC-Ready	DCC+Sound
ATH64368	ATH64468HO RTR SD39, SF #4002
ATH64369	ATH64469HO RTR SD39, SF #4006
ATH64370	ATH64470HO RTR SD39, SF #4009
ATH64371	ATH64471HO RTR SD39, SF #4010
ATH64372	ATH64472HO RTR SD39, Guilford/B&M #690
ATH64373	ATH64473HO RTR SD39, Guilford/B&M #691
ATH64374	ATH64474HO RTR SD39, Guilford/B&M #692
ATH64375	ATH64475HO RTR SD39, Guilford/B&M #693
ATH64380	ATH64480HO RTR SD39, ANDX/D&RGW #4027
ATH64381	ATH64481HO RTR SD39, ANDX/D&RGW #4028
ATH64382	ATH64482HO RTR SD39, PGR #40
ATH64385	ATH64485HO RTR SD39, SP #5318
ATH64386	ATH64486HO RTR SD39, SP #5319
ATH64387	ATH64487HO RTR SD39, SP #5322
ATH64388	ATH64488HO RTR SD39, SP #5325
ATH64389	ATH64489HO RTR SD39, MNS #40
ATH64390	ATH64490HO RTR SD39, MNS #41

DCC-READY: \$134.⁹⁸
DCC+ECONAMI SOUND: \$194.⁹⁸



VISIT
Your Local Retailer

CLICK
Athearn.com

CALL
1.800.338.4639

SERIOUS FUN™

©2017 Horizon Hobby, LLC. Athearn, Genesis, Ready To Roll, Trains in Miniature, Serious Fun and the Horizon Hobby logo are trademarks or registered trademarks of Horizon Hobby, LLC. The Union Pacific mark and other marks owned by Union Pacific are made under trademark license from Union Pacific Railroad Company. All other trademarks, service marks and logos are property of their respective owners. Final models may vary slightly from photos shown. 53142



Visit **OUR NEW WEBSITE!**
SAME GREAT SERVICES & PRICES!

www.yankeedabblers.com



Don't forget to use the **SEARCH** button to search info you want to find

Search

Call us on Pin: 727-457-9227

My Account

Gift Certificates

Sign In or Create an account



HOME SCALES BRANDS SHIP/RETURNS CONTACT SHOW SCHEDULE NJ STORE HOURS

Brands

YD Products

View all brands

Categories

DCC PRODUCTS

View All Categories



Specializing in DCC! ~ The Best for Less! ~ Sales-Services-Installation!

Free Technical Coordination (727) 457-9227 9AM to 9PM EST

In Philly? The store is 1 mile from NJ end of Walt Whitman Bridge
 Stop by and meet us at the following hobby shows:

CLICK AND SAVE TODAY!

Use coupon code "MRH" for FREE SHIPPING

YD installs DCC or RailPro in your engines

08/4-08/6

NMRA
 Orlando, FL

10/7-10/8

Great Scale Model
 Timonium, MD

11/11- 11/12

Trainfest
 Milwaukee, WI

PUBLISHER'S MUSINGS | 3

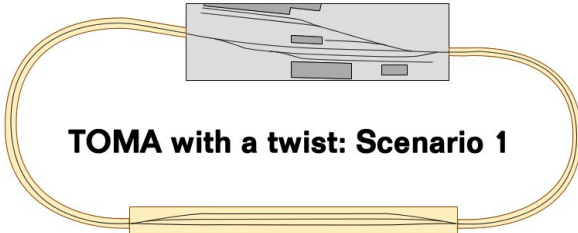

TOMA with a twist: Scenario 1

2. A starting TOMA configuration with double-ended staging and continuous running.

you can use temporary connecting track to add distance between each TOMA "town" and get a longer, much more interesting run very early on [3].

If you're getting the idea, then you may have guessed where I'm going next. If we combine Scenario 1 and Scenario 2, we get a two-

BACK FROM THE DEAD!



HO
SCALE

THE RAPIDO MID-TRAIN DOME



• INDEX



SUBSCRIBE
(free)

• TABLE OF CONTENTS

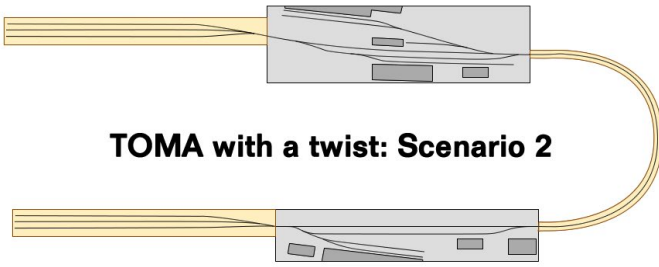

TOMA with a twist: Scenario 2

3. A starting TOMA configuration with two modules and a longer run.

module TOMA layout with distance between towns and continuous running, shown in [4].

In all cases, the idea with these “TOMA with a twist” configurations is to get you to operation early by using some temporary trackage add-ons. These TOMA sections will be part of a larger room-filling layout eventually, but with TOMA you don’t need to wait for years and spend all that time and money before you can enjoy the full spectrum of the hobby from benchwork to detailed scenery and operation through finished scenes.

Building one or two TOMA modules like this also “forces” you to think through the entire process of building your layout because you will need to get everything operational and finished on what you do build. If you’ve missed thinking through some parts of your desired layout, you’ll likely find gaps or things that may not work

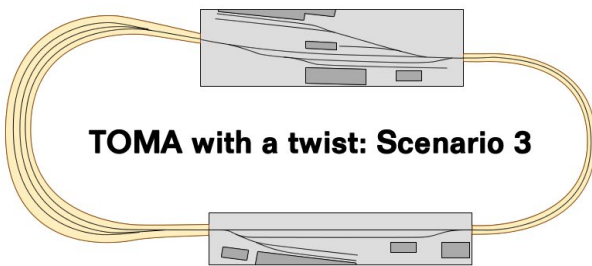

TOMA with a twist: Scenario 3

4. A starting TOMA plan with two modules, distance between modules, staging, and continuous running.



NORTH AMERICAN RAILCAR CORPORATION

Pullman Standard 5077cf 50' Single Door Boxcars



Pullman Standard

Division of Pullman Incorporated



CLICK HERE FOR
HO - 5077 Boxcar

CLICK HERE FOR
N - 5077 Boxcar

We will be announcing our next new car at the NMRA Show on August 4th

Accuracy and Detail... in Scale



NSC Potash Service 4275 cf 3-Bay Covered Hopper



*Samples have arrived.
Follow links to view!*

CLICK HERE FOR
HO - 4275 Hopper

CLICK HERE FOR
N - 4275 Hopper

NARC Cars are sold exclusively through

Pacific Western Rail Systems

• **INDEX**



SUBSCRIBE
(free)

• **TABLE OF CONTENTS**

FIRST-CLASS PASSENGER SERVICE IN HO: NEW SOUND VALUE GS4 4-8-4 and SMOOTH-SIDE CARS

In a choice of two distinctive “Daylight” color schemes plus the red, white, and blue Bicentennial model, our 4-8-4 now includes our Sound Value *SoundTraxx*® steam package with authentic prototypical chuff, short and long whistles, bell, air pump, steam release, and blower—all in 16-bit polyphonic sound. Our Smooth-Side Cars with Lighted Interior let your passengers ride in style, day or night. Visit your favorite hobby dealer to add first-class service to your HO railroad!

GS4 4-8-4 features include:

- DCC sound-equipped
- dual-mode NMRA-compliant decoder
- precision motor
- operating headlight
- separately applied metal parts
- see-through frame
- RP25 wheels
- E-Z Mat® Mark II couplers



Shipping Now!
MSRP \$399.00 each



SOUTHERN PACIFIC DAYLIGHT® #4449 -
RAILFAN VERSION
(Southern Pacific Lines)
Item No. 53101



Click to
learn more



SOUTHERN PACIFIC DAYLIGHT® #4436
(billboard lettering)
Item No. 53102



AMERICAN FREEDOM TRAIN® #4449
Item No. 53103



85' Smooth-Side Coach with Lighted Interior • MSRP \$79.00 each



PRR
Item No. 14201



B&O®
Item No. 14203



UNION PACIFIC®
Item No. 14204



RINGLING BROS. and
BARNUM & BAILEY™ - BLUE UNIT
Item No. 14206



SOUTHERN PACIFIC DAYLIGHT
Item No. 14207



PAINTED, UNLETTERED
ALUMINUM
Item No. 14208



85' Smooth-Side Observation Car with Lighted Interior • MSRP \$79.00 each



PRR
Item No. 14301



B&O®
Item No. 14303



UNION PACIFIC®
Item No. 14304



SOUTHERN PACIFIC DAYLIGHT
Item No. 14307



PAINTED, UNLETTERED ALUMINUM
Item No. 14308



Click for
more information



© Feld Entertainment. RINGLING BROS. AND BARNUM & BAILEY and THE GREATEST SHOW ON EARTH are trademarks of and are used under license from Ringling Bros.-Barnum & Bailey Combined Shows, Inc. All rights reserved. www.Ringling.com

Bachmann Industries, Inc. • 1400 East Erie Avenue
Philadelphia, PA 19124 USA • www.bachmanntrains.com

as expected so you can course-correct more easily before you've filled the room with a layout you might need to rethink.

For example, as I work through planning my TOMA version of the Siskiyou Line 2, I'm thinking about how to get the very first section completely operational. I'm finding this is truly forcing me to determine answers to design questions now that I put off on Siskiyou Line 1, much to my regret later.

So what we're looking for with this new "TOMA with a twist" layout design contest is for layout designs that show the first step using one of the "TOMA with a twist" options:

- One module section with continuous running
- Two module sections with running distance between modules and/or continuous running

Like previous TOMA contests, we also would like to see in general where you expect the ultimate layout to end up. But the focus, as always, is on that initial configuration – this time with one or two module sections and the "twist."

Contest prizes spelled out

We have also spelled out the prizes more clearly this year:

GRAND PRIZE: \$1000 and design published in MRH as a cover story.

FIRST PLACE: \$750 and design published in MRH as a feature story.

SECOND PLACE: \$500 and your design published in MRH.

THIRD PLACE: \$350 and your design published in MRH.

HONORABLE MENTIONS: \$100 prize and (optionally at staff discretion, your design might be published).

All prizes will be paid upon publication except for the honorable mentions, which will be paid the month in which the publication of the First Place entry takes place.



Submission guidelines

Because winning entries are to be published, please submit a proper, publishable article. Review our submission guidelines at:

mrhmag.com/authors/submission-guidelines

Also check out the MRH style guide at:

mrhmag.com/authors/style-guide-doc

A good way to see how we want your submission formatted is to study the previous two years of entries that have been published in MRH: [April 2016](#), [June 2016](#), [July 2016](#), [August 2016](#), [April 2017](#), [June 2017](#), and [this issue](#).

Notice how they each have a title, an author byline, and a lead teaser sentence (these often get missed in article submissions). Also notice that all photos *have captions*.

Pay close attention to how the text is organized and the TOMA concepts are spelled out in each article. Finally, we need a mug shot of you and some biographical text. Include these things!

No matter how innovative and clever your entry is, a rushed and poorly organized submission that doesn't follow our publishing guidelines cannot be in the running. So take the time to read and follow our publishing guidelines if you want a chance to win and get published!

If you have questions, just ask. Ideally, ask those questions on the MRH forum. We're always happy to help you, and by posting your questions on the forum, everyone will benefit by the answers.

Let's see those "TOMA with a twist" designs!



[Click here to rate or comment on this article](#)

Bowser

HO ALCo Century C-628, C-630, & C-630M Locomotives

Ready To Run and Fully Detailed. Features: MU Hoses, air hoses, windshield wipers, operating headlight, window glass, can motor, flywheels, blackened nickel silver wheels with RP25 flanges, knuckle couplers. Handrails installed. Available with LokSound Select Decoder (sound and DCC) or Analog (DC) versions. 21 Pin socket for easy decoder installation.

DC Version \$199.95 Sound Version \$299.95
Arriving Early 2018

Road Names: Demo, D&H, LV, CNW, DMIR, Reading, L&N, CN, & CP



Click here to check out the details for these and other great
Bowser Products

• INDEX



SUBSCRIBE
(free)

• TABLE OF CONTENTS

MRH “TOMA WITH A TWIST” CONTEST

ENTRY DEADLINE: January 31, 2018

Goal: Design the “starting position” for a sectional home layout design using TOMA.*

GRAND PRIZE: \$1000, plus get published as an MRH cover story

First Prize: \$750; Second Prize: \$500; Third Prize: \$350;
First, Second, and Third prize also get published.

Honorable mentions: \$100 each, publishing at editors’ discretion.

Hypothetical room is 14’ x 20’. Space under the stairs not available, and a 4’ clearance must be maintained along the utility wall.

Note: This is a sectional home layout design, no modular standard required.

Room 14’ x 20’

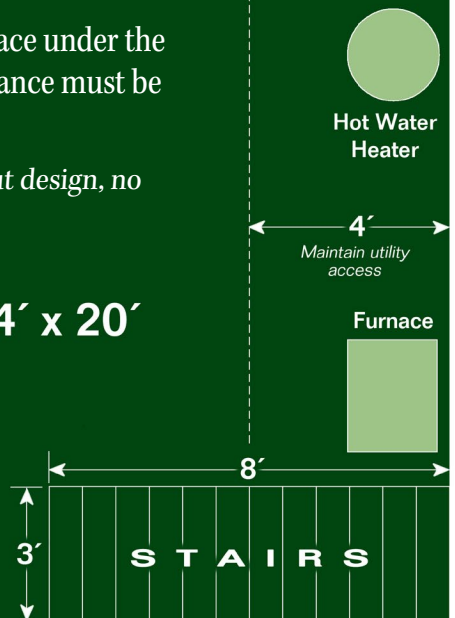

*For reference, see the July 2017 MRH Editorial, “TOMA with a twist”.

CONTEST RULES

- Modules can be any size or shape but must fit up the stairs and through the door at the top of the stairs (80" tall and 30" wide) without damage or pinching your fingers.
- Scale: From Z to O, using any track gauge.
- Design the "starting position" for layout construction phase 1 – we want to see one or two TOMA module sections that can be completely finished and configured for an operating session. Show and tell how staging would work. Tell a brief backstory of the line and how it operates.
- Your TOMA modules need to have some form of temporary staging, either singled-ended staging off one/both ends, or double ended staging connected to both ends of the modules, which would also allow continuous running if desired.
- Don't waste your time drawing and describing a detailed room-filling layout. Rough in outlines of the other modules, that is, the "ending position." Just sketch simple boxes and lines to show how the modules will fit in the room. Bonus points awarded for explaining – in words, sketches or both – a phased module construction progress plan.
- Modules can follow a standard or not. Custom sections okay.
- Module support method / height up to you, but please describe.
- Innovative or creative approaches get extra points: please describe and illustrate if possible.
- Include a cost estimate for the starting position. There is no need to actually build anything, this is a design contest only.
- This contest is *all about getting started*. People who can get that far will be able to fill in the rest with their own imagination.
- All submissions must be publishable. If the submission is not formatted to be ready for publication, it will be disqualified. Take the time to be complete, provide captions, and to describe things completely in your text. See the [MRH submission guidelines for more information](#).

SUBMIT ENTRY (Choose "Contest Entry")



MRH App 5.2 timeout fix



Much to our chagrin, with the June 2017 issue release, the MRH mobile app (available for Apple and Android devices [mrhmag.com/magazine/mrh-app]) just quit working. That was version 5.1.5.

We quickly worked with the developers to resolve the problem and roll out version 5.2.

On Android, version 5.2 works great. On Apple devices, 5.2 still had problems – the magazine issues would not load – they would get a server timeout error.

Apparently, Apple recently decided all web files being loaded into an app needed to use HTTPS instead of HTTP. That meant we had to scramble to get a new magazine server stood up and fully working with HTTPS, which took a couple of days.

As if that was not enough, the app that generates our online edition ties the issue to one and only one URL – in this case, an HTTP URL.

Moving to an HTTPS URL is a completely new URL and meant that all the magazine issues needed to be regenerated and re-uploaded to the all-new server.

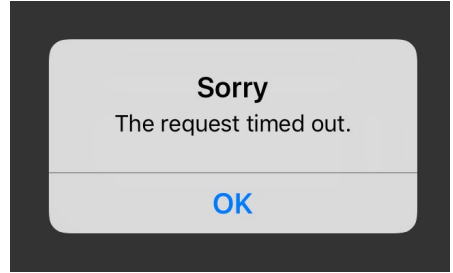

Apple users of MRH App 5.2 were getting this error. To fix it, we had to rebuild the MRH online issue website and database from scratch (Apple URL policy change was the cause), which took us a full week. Thankfully, it's fixed now and 5.2 works great on Apple devices again!

All told, the entire rebuilding process took about a week to regen four years worth of magazines and to re-upload a quarter terabyte of rebuilt magazine files.

Long story short – the 5.2 Apple app now works great again – it's faster than ever and has more back issues than ever available.

If you upgraded the MRH App on your Apple device (iPad/iPhone) only to find you got a server timeout error, ***try it again!*** We had to regenerate and re-upload all the issues again to get it working, no thanks to Apple for their policy change with no warning.



[Click here to rate or comment on this article](#)

**Did you know
there is an
MRH index
available?**

CLICK TO FIND OUT MORE





LAST ISSUE'S RATINGS

The five top-rated articles in the [June 2017 issue](#) of *Model Railroad Hobbyist* are:

4.8 Creating a 3D backdrop

4.8 Yes, it's a model

4.7 Publisher's Musings: Secret to needing less layout

4.7 Depot for the Pittsfield Branch

4.7 What's Neat: Tricked out UP challenger, ...

Issue overall: **4.4**

Please rate the articles! Click the reader comments button on each article and select the star rating you think each article deserves. Thanks! ■

*TrainMasters TV is part of
the MRH product family.*

*TMTV members not only get great network TV level
videos, they help pay for MRH and keep it free ...*

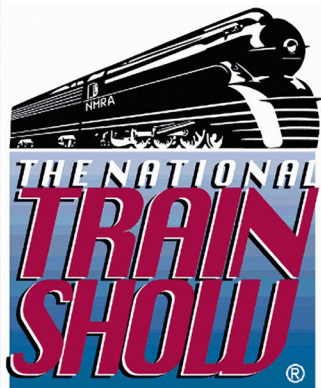

2017 National Train Show

August 4 - August 6, 2017

in **ORLANDO, FLORIDA**

Get the details >>

(click me)

Fun for the Whole Family

From your littlest engineer ...

To the most experienced Model Railroader



- The World's Best Known Manufacturers
- Over 180,000 square feet of exhibit space
- Hands-On Demonstrations
- 44,000 Sq. Feet of Modular Layouts
- Ask The Collectibles Appraiser
- The Incredible Lego® MiniLand

• INDEX



SUBSCRIBE
(free)

• TABLE OF CONTENTS

The possibilities are endless, beginning with these pages.

Built just for you to include:

- New modeling articles for ideas and inspiration
- Free sign sheet to help detail your layout
- All-new Magic of Model Railroading photos
- Coupon for 20% off a Walthers Cornerstone kit

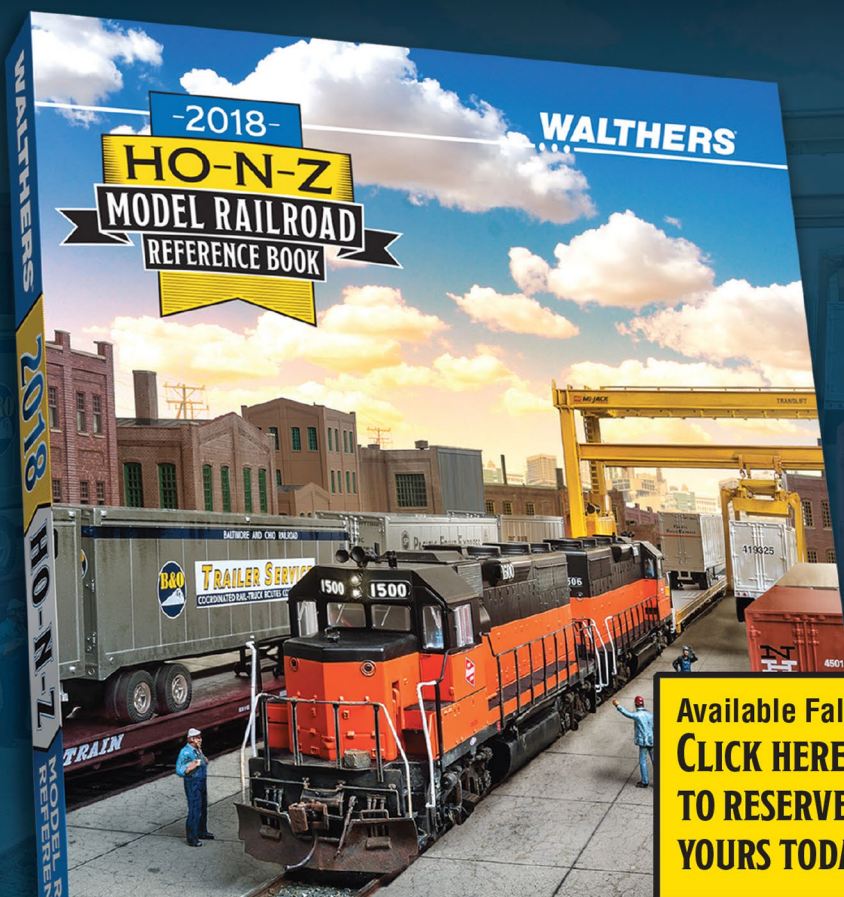

Available Fall 2017
**CLICK HERE
TO RESERVE
YOURS TODAY!**

WALTHERS

Support your local hobby shop • visit walthers.com • call 1-800-4-TRAINS

©2017 Wm. K. Walthers, Inc.

• **INDEX**

• **TABLE OF CONTENTS**



Model Railroad Hobbyist | July 2017 | #89

MRH Q-A-T

column

compiled by
JOE BRUGGER
.....



[Click here to rate or comment on this article](#)

QUESTIONS AND ANSWERS

Labeling layout wires

Q. I have started out color-coding wires as I build my layout, but it's pretty obvious this isn't going to be enough identification as the railroad grows. How do people handle wiring ID?

—Rock Island

A. Walt: I use 3M SLS Write-On Wire Marker Dispenser with good results. The more electronics one uses, the amount of wiring seems to greatly increase. You need a good system to label as you go and the 3M product works for me. See it at solutions.3m.com/wps/portal/3M/en_US/EMDCI/Home/Products/ProductCatalog/~/3M-ScotchCode-Write-On-Dispensers-and-Roll.s?N=5426800+3294248035&rt=rud.

Bob Reck: I use a combination of write-on tie-wrap markers and wire markers. I use the wire markers for things that are numbered and lettered such as blocks and switch machines, and the write-on for everything else. The wire markers are available in numbers,

► MRH QUESTIONS, ANSWERS, AND TIPS

• [INDEX](#)
.....



SUBSCRIBE
(free)

• [TABLE OF CONTENTS](#)
.....

MRH Q-A-T | 2

letters or combination packs with some symbols from various manufacturers.

Or, you can label tags by hand. I use a very fine-point black Sharpie, I have not had any fading problem on write-on wire markers. Some have been in place for over 25 years.

DBA Lindsey: Use labels from Avery and print what you want on them. There are many sizes and they come with templates for word processors. Just fold the label over the wire.

Pelsea: When I have a massive labeling project, I also print the labels, but on plain paper. I use a combination of double-stick tape and clear tape to hold them in place, then over-wrap them. It goes a lot faster than it sounds and is the cheapest, most durable method I have found. If I only need a few labels or small ones, I use this dispenser from 3M [2].

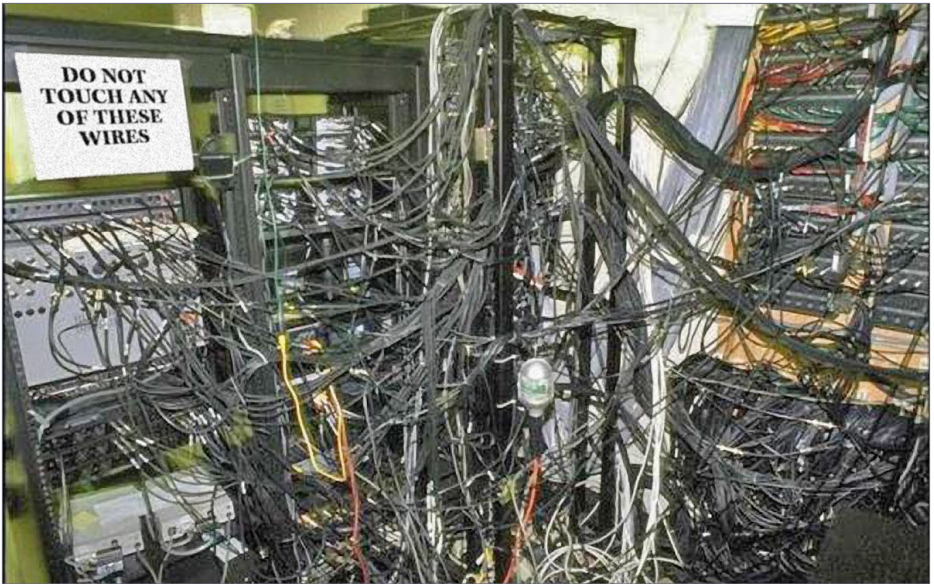

1. Boy, do I wish I used labels, as I'm having a terrible time locating one tiny short! *Photo courtesy of Peter Herron*

MRH Q-A-T | 3



2. 3M supplies a dispenser with reels of sticky numbers, and sells refills.

Each slot has a reel of numbers on sticky plastic tape. They peel off in groups of 5. It's expensive to buy the first kit, but refills are cheaper than the cards.

When I need elegant labels, I print them on a Brother P-touch. Look at brother-usa.com/labeling_solutions/modeldetail/7/pth110/overview. Expensive tape, but the labels impress paying clients.

I prefer to label wires according to what they do or where they connect, rather than some arbitrary scheme I have to look up. Pencil is good but difficult to read in the dim light available behind and under tables. Ink from that era is still legible too. It's the ballpoint pen ink that fades away.

I have had better luck with Pigma Micron pens, which draw a very nice line and use archival ink. I have some five-year-old labels that show no sign of fade. I've also been using them to add highlights to models.

Philip H: I save the hard plastic closures from bread loaves. They usually have a non-printed side and take extra-fine-point markers just fine. Write small, and clip on.

BruceNscale: In addition to labeling the wires under the layout, I keep a three-ring binder with diagrams of each section/module of my layout. That way I know what I'm looking for before I crawl under the layout.

Simon Brown: My Epson Label Works printer can make wrap-around flag labels as needed and it's small enough and easy enough to work with under the layout when I label things. You can get different thickness labels and also different colors.

This is the model I use: [epson.com/For-Home/Printers/Label/Epson-LabelWorks-LW-400-Label-Printer/p/C51CB70010](https://www.epson.com/For-Home/Printers/Label/Epson-LabelWorks-LW-400-Label-Printer/p/C51CB70010).

More about tools and techniques for wiring identification at [mrh-mag.com/node/29617](https://www.mrh-mag.com/node/29617) and at [mrhmag.com/node/4741](https://www.mrhmag.com/node/4741).

Where did rolling stock run?

Q. I model Santa Fe and the BN before their merger, and the early BNSF. Is there a searchable database telling what engines and freight cars were run over the line I am modeling? I saw some awesome coal hoppers come up for sale at the right price but was unsure if they ran on the BNSF.

—Mike Hill

A. Dave Husman: There is no database of cars that have operated over specific railroads, other than the car records of the railroad itself – and that's proprietary information.

Rail traffic can be very, very, very location- and era-specific. At Fort Worth TX on the Union Pacific, if you model the former Texas Pacific yard on the west side of town, you will rarely see a unit coal train car. If you model the former Missouri-Kansas-Texas (Katy) yard on the south side of town, you will almost never see an intermodal car. Same railroad, two spots less than five miles apart in the same city, and two very different mixes of cars.

It's also very era-specific. If you model the UP in the 2000s you could have several sets of Georgia Power coal cars. Model the UP in the 2010s and you would never see them on the UP because the contract went to the BNSF.



Archer

FINE TRANSFERS
PROUDLY SERVING MODEL BUILDERS SINCE 1989

**THE ORIGINAL
SURFACE DETAILS™**

**WE NOW HAVE MORE
THAN 130 SHEETS OF
RIVETS, LOUVERS,
TREADPLATE, WELD
SEAMS AND MORE
CAST ONTO
MICROSCALE CLEAR
DECAL FILM**

LOW SHIPPING:

**DOMESTIC USA ORDERS
\$2.80**

**INTERNATIONAL ORDERS
\$9.95**

**CLICK HERE TO
VISIT OUR WEBSITE!**

"Archer Fine Transfers 3D decals have revolutionized kitbashing and scratchbuilding. Putting rivets or other low-relief details like louvers or weld seams on your models is now as easy as applying decals."

Joe Fugate,
Publisher/Editor
Model Railroad
Hobbyist



Archer Fine Transfers • PO Box 1277 • Youngsville, NC 27596 • USA
(919) 570-1026 • info@archertransfers.com • archertransfers.com

ADVERTISEMENT

HO GP60M, GP60B AND GP60 Locos



NOW AVAILABLE !



DC OR DCC WITH SOUND!



www.foxvalleymodels.com

**TRINITY 3281
IN STORES NOW**



Norfolk Southern -- 12 #s

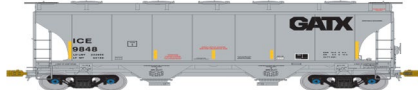

ICE-GATX -- 8 #s



Winchester & Western -- 12 #s



NRLX Ciment Quebec -- 12 #s

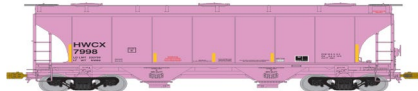

HWCX -- 7 #s

American Limited

www.americanlimitedmodels.com

ADVERTISEMENT



NICK & NORA DESIGNS

Uniquely inspired craftsman kits
Craftsman Structure Kits in HO & N

**Detail Parts,
laser cut shingles,
HO Vehicles, Tru-Color Paints,
glues, tools & more!**

www.nickandnoradesigns.com

• **INDEX**



SUBSCRIBE
(free)

• **TABLE OF CONTENTS**



3. What types of freight cars and cargoes ran on “your” railroad? Even if you are far away – in time or space – there are ways to find out. This is the Union Pacific along the Columbia River in Oregon. *Graham Line photo*

Barry Karlberg: Often, you can get pretty reliable information from railroad historical societies that cover the road you are modeling.

You can also do some fun research through Google Earth to follow the tracks you wish to model. Their images will show industry spurs containing various car types, or the site of spurs which have since been removed. Through your internet research you may also bump into “old head” railroaders like Dave and me who worked for the roads and can provide necessary, interesting, reliable information which is based on real activity and not hearsay.

Layout research can be a lot of fun because it’s like putting together a puzzle, and each piece of information helps to



New N Scale End of Train
FRED LED couplers by FireFly!

3 Sizes - Short, Medium, & Long



find us on [facebook](#)

Shop Now

Want it on Blu-ray?

Selected titles are now available on Blu-ray disc in spectacular HD!

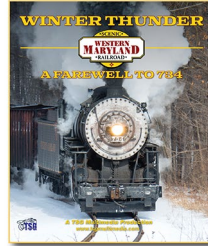
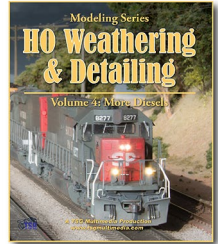
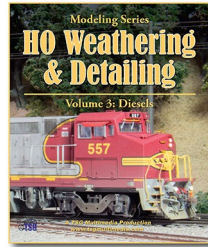

CLICK FOR
BLU-RAY



TSG Multimedia

Checked us out lately?

- ☑ HO/N and now O scale products too!
- ☑ Laser-cut Structures & Bridges.
- ☑ Advertising & Storefront Signs.
- ☑ Highway Signs, vintage & modern.
- ☑ New Detail Items.
- ☑ Laser-cut Grade Crossings.
- ☑ Billboards, roadside & rooftop.
- ☑ Laser-cut Graffiti Decals
- ☑ 1000's of satisfied customers.

WHAT'S
NEW?



Established 1993...

Blair Line

Select MODEL
RAILROADS

**Design & Build Services
For Discriminating Modelers**



WE WILL:
Complete Unfinished Railroads
Fix or Rebuild Bad Railroads
OR
Design & Build A Custom
Railroad Of Your Dreams

CLICK HERE FOR OUR WEBSITE
www.SelectModelRailroads.com

(844) 872-4670



complete it. Then, build the layout ... so that you have something to show for all your research.

Jim Fitch: I look at tons of photos to see what freight cars ran on my favorite railroad during a time period. One of the best sources online for me has been railpictures.net. I go there, and in the drop-down boxes select my railroad, such as Rio Grande. Then I select photo year and hit "Find the Photos!" I get quite a few pages of D&RGW in the 1970s. Usually you will find some photos where you can see the freight cars and make note of what was typical, and match them to models.

Metrolink: The Official Railway Equipment Register (ORER) lists every piece of rolling stock (freight only) in North America, listed by railroad or leasing company. They pop up on eBay quite frequently for \$20 to \$50 per volume. I'm modeling the mid-1990s and have ORERs for 1989, 1993, 2001, and 2016. Most were purchased for about \$20-25, plus book-rate shipping (about \$5). I got lucky, and all of my ORERs were delivered in mint condition ...

In my experience the most useful prototype references for consists have been YouTube railfan videos, and books which include photos of consists. If you're lucky enough to have some railfan posting videos of your favored road name and era, YouTube videos can be a gold mine of references. Videos of mile-long unit trains inspired the building of my most expensive consist: a 25-car FedEx spine-car unit-train.

Greg (MrBando): There have been many color books published on my railroad, the B&O, covering the late '50s to early '60s. Paging through those gives me an extremely good idea of what a typical B&O freight train looks like. Some of the books specifically cover only the area I model, Sand Patch grade, while others cover the railroad system-wide. You can see what car types and

foreign road names are prevalent, and in what paint schemes.

Michael Mainridge: When I want to know if a specific loco or car ran in the era or location I want to model, the first site I check is rrpicturearchives.net. Go directly to Search and input the loco or car name and number, or you can search by railroad and drill down to the loco or car type. Drilling down by type will turn up useful photos you might not find by looking for a specific car. Looking at several will give you a feel for the areas these cars travel.

Sources which list locos and cars by railroad, location, and dates are:

trainphotos.com

locophotos.com

railcarphotos.com

If you want to find out what types of cars were in a specific area, search by Location on the RR Picture Archive site. Drill down to a specific city and state or look up cities along your route because run-through trains will likely carry the same cars as in your modeled section.

Other sites that are less easy to search for a specific loco or car:

railpictures.net

youtube.com

flickr.com/groups/2679636@N22

For Flickr, search on topics of interest. When you view the details of the photo, look for groups at the bottom. Then join and bookmark the groups you like. The link above is an example of the Union Pacific St. Louis Service Unit group.



Other sources:

rr-fallenflags.org

westerfieldmodels.com lists CD copies of ORERs for various years between 1885 and 1965.

Read more in the original thread at mrhmag.com/node/29763.

Squaring ends of Peco flex track

Q. After bending some Peco HO code 83 flex track to see how it will fit on the layout, the ends no longer line up with each other. I tried moving one of the rails but couldn't, nor could I move the other rail. Is there a trick here I'm missing out on?

—D. Steckler

A. Avel: I hold Peco flex about one foot off the ground and let it drop on its end a couple times. It usually evens out. If you have a wood or carpeted floor you might need something harder. Washing it with soapy water will help the rails slide in the ties. Just tap the end against the floor.

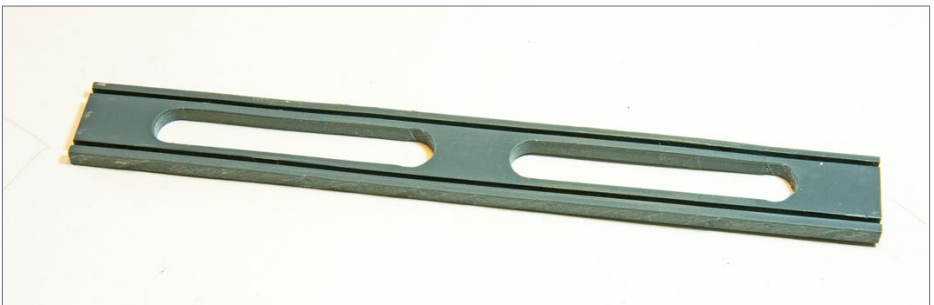

4. MLR Engineering produced this 8" resin tool for aligning flex track. It's also useful for cutting rail ends to match. Hardwood or aluminum could be used to make a similar tool. *MRH photo*

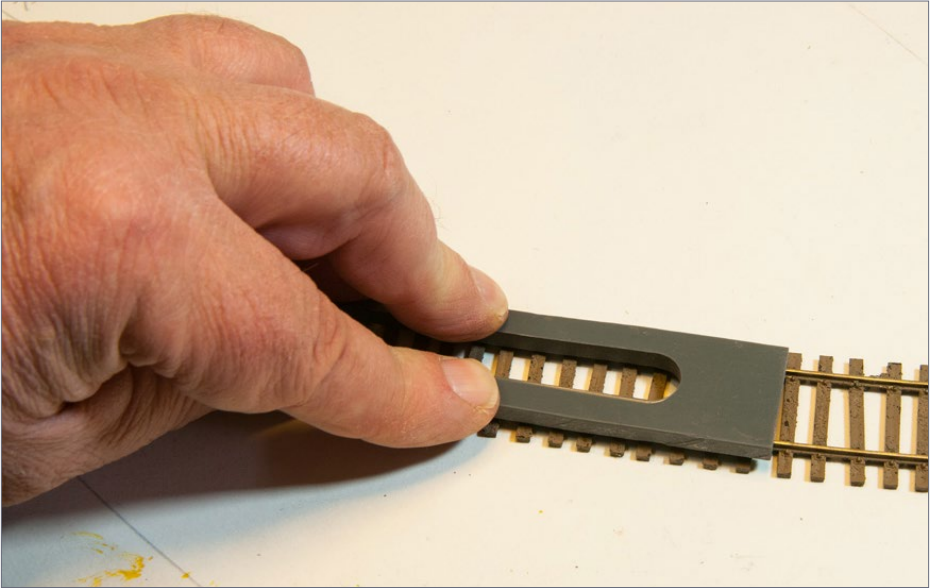

5. Align the rails with the slots, then push the tool back and forth along a stretch of flex track to straighten curves and realign the plastic tie strip. *MRH photo*

Randy Seiler: I don't have any experience with Peco flex track, but with the brands I have used you can slide at least one of the rails back and forth on the ties within the molded spikes. It's not always super-easy to get the rail to slide, but it will. Again, I've not done it with Peco. If it slid while you were bending curves, it should slide back to where it started.

Skiloff: It takes some work to straighten it out again, evenly. You kind of have to shuffle the ties along the rails a bit to get it back to even. "Practice" is all I can say.

Dave B.: I usually hold the section of track upright on my work-bench and then push down on it to apply pressure to the long rail sticking out the bottom (Don't push so hard that the rails kink). Then pull the ties down toward the bottom of the section until the

rail ends are even and the ties approximately evenly spaced along the whole section of track.

Ed.: If the piece of flex track is sort of straightened out, you can help the process by tapping the piece of track sideways, on the tie ends, on a hard table top or workbench. Hold the piece of flex at 90 degrees to the table and gently rap the edges, alternating sides, to get the ties lined up and the rails straight.

MLR Engineering made a set of track tools, and one of them [4] was excellent for straightening kinky flex track. Most suppliers are now sold out and say they do not expect new stock. Old stock in stores or at swap meets is a possibility. Micro-Mark sells a similar set, but without the 8" alignment tool.

micromark.com/Deluxe-HO-Gauge-Track-Laying-Set.

Add your own ideas on the original thread at mrhmag.com/node/29958.



TIPS

Keep baby wipes on your workbench

Keep a package of baby wipes on your workbench and you will use them for the following and more:

When the phone rings, or when you need to leave the workbench and travel to another part of the house, clean your hands first with a wipe. The cleaning solution in the wipe will help remove paint, lubricant, and grime better than a dry rag.

If you get paint or lubricant on a part you didn't intend, use a baby wipe to remove it. The cleaning solution in it won't affect paint adhesion, and the alcohol in it makes it evaporate quickly, allowing you to get back to work.

Clean tools before putting them away.

When buying wipes for this use, avoid those that contain lotions or other additives. Those that don't are often less expensive.

—Edward J. Grzetic



[Click here to rate or comment on this article](#)

Tell your friends about MRH!

**We depend on word-of-mouth to grow
... if you don't share us, we don't grow**



.....
GET PAID FOR YOUR TIP

We pay \$25 per tip we publish, or \$40 each if the tip also includes a photo or finished drawing. [Click here and select article type TIP.](#) ■
.....



From first train set to railroad empire...

*Our complete line of DCC products
grows with you. Discover the fun!*

- Designed and manufactured in the U.S.A.
- Preferred for ease of use and ergonomic design
- Unlimited scalability for any size model railroad
- Plug-and-play means more time running trains
- Great customer service and excellent support



See your dealer



Visit our new and improved web site for all your DCC needs!

- Get the latest new product announcements
- Watch our detailed how-to videos
- Browse the all-new Information Station
- Enjoy secure online sales, day or night!

Visit **ncedcc.com**



• [INDEX](#)



[SUBSCRIBE](#)
(free)

• [TABLE OF CONTENTS](#)

Got Steam?

**Full Throttle Steam
Available Now!!!**

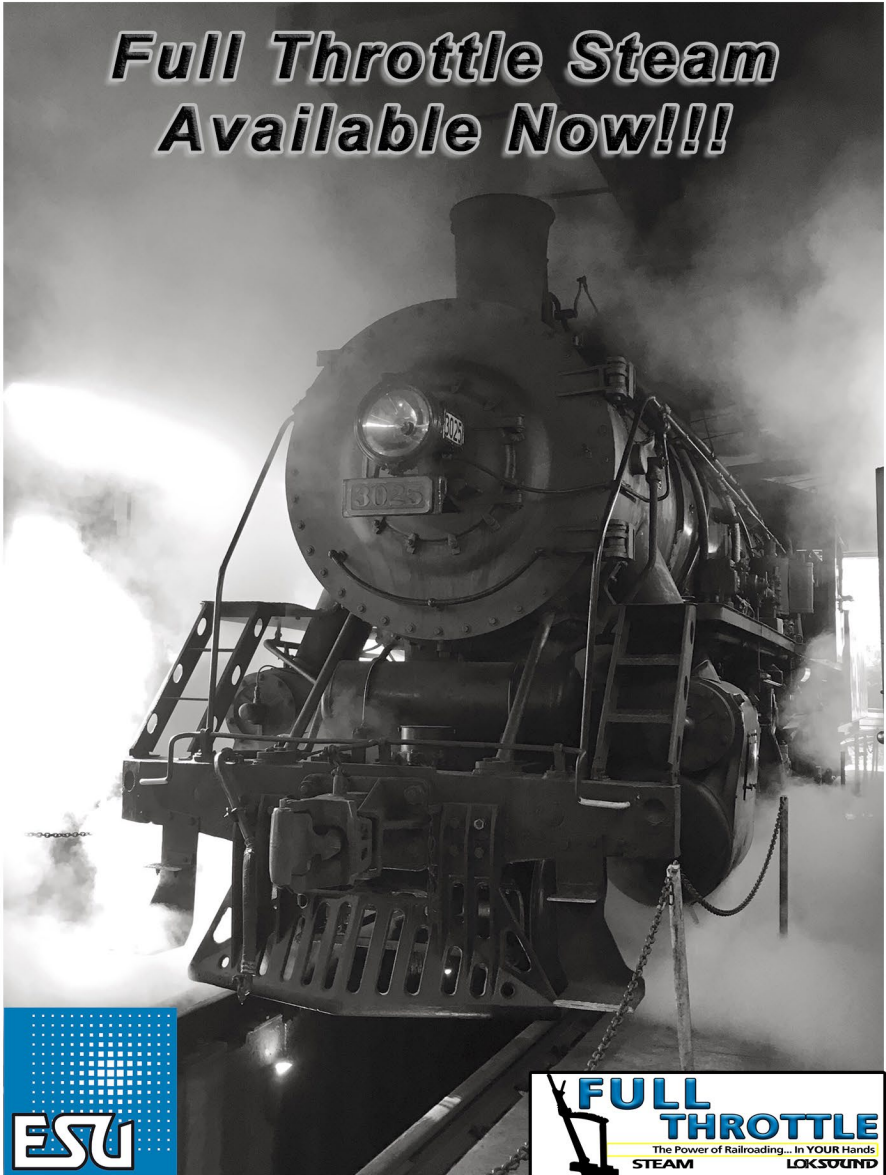

ESU

**FULL
THROTTLE**
The Power of Railroading... In YOUR Hands
STEAM **LOKSOUND**

www.LokSound.com



DCC IMPULSES

column

BRUCE PETRARCA MMR
.....



[Click here for
reader comments](#)

I'M RETIRING!

“RAINDROPS ON ROSES,
WHISKERS ON KITTENS,
BRIGHT COPPER KETTLES
AND WARM WOOLEN MITTENS.” ...

I THINK WE ALL KNOW THE SONG ABOUT
favorite things.

Well, this column is about not-so-favorite things.

When we procrastinate, there is a reason. I'm just finishing two brass HO steam locomotive installations. These have been in my workshop for way too long. Why haven't I gotten them done sooner?

I just realized that I don't really like working on brass locomotives, especially steamers. Why? Many reasons. Here are a few:

▶ DCC TIPS, TRICKS, AND TECHNIQUES



DCC IMPULSES | 2

- I don't like chasing 43 different-sized microscopic metric screws, half of which have unique flats, shafts or shanks, along with a couple of unique springs, around the workshop.
- I don't like doing major surgery on a metal shell that has what seems like a hundred tiny detail parts and a perfect paint job.
- I don't like the finesse of eye-hand coordination necessary to take them apart and put them together. I seem to need to do so many times to get things the way I really want them.

Working on them is not fun for me. It is hectic work. Similar to how NASCAR drivers talk about racing at Talladega Super Speedway: hours of tension and stress. And, at least for me, it is truly hours, requiring several days of time, to allow glues to set up, etc.

I'm not quitting my *MRH* column or my website or my consulting business. I'm just quitting doing something that I don't like: DCC installations into brass locomotives.



1. Brass HO locomotive. *Bruce Petrarca photo*

DCC IMPULSES | 3

So, I'm going out with a bang. In lieu of a **Mr. DCC's Workshop** section this month, I'm devoting the entire column to hints and tips and ideas from these last two installations for you.

You might want to look back at my June 2013 "tips" column: **17 DCC Tips** (mrhmag.com/magazine/mrh-2013-06-jun/di_17-dcc-tips), too.

So, here are photos from two different installations with their own hints and kinks. These are presented in the vein of my January 2013 column: **HO Kato NW2 Sound Installation** (mrhmag.com/magazine/mrh-2013-01-jan/di_dcc-sound). There are a lot of ideas to take away regardless of your era or scale.

ADVERTISEMENT

SoundCar Summer Special

At SoundTraxx it doesn't have to be a locomotive to get a decoder. Transform your railroad with the only full-featured Digital Sound Decoder loaded with prototypical sounds for rolling stock. Limited Edition, Tsunami SoundCar Bonus Packs include a **free speaker and baffle** while supplies last!



SOUNDTRAXXTM
www.soundtraxx.com

Watch the Install Now ▶

• INDEX



SUBSCRIBE
(free)

• TABLE OF CONTENTS

Wiring do-it-yourself connectors

I've talked about these before. I usually need several for a brass steam installation. I purchase 50-pin long strips of male and female connectors and slice off what I need. My old store, Litchfield Station, stocks them (litchfieldstation.net/product/header-50-pin-inline-male-50-pin-575-500101).

If I need three pins, I cut through the fourth pin from the end with small wire cutters. That leaves me with two things: a single loose pin (which I save for those times that I only need one pin); and a three-pin header with a slightly concave surface on one or both sides. I use an emery board to sand the sides flat.

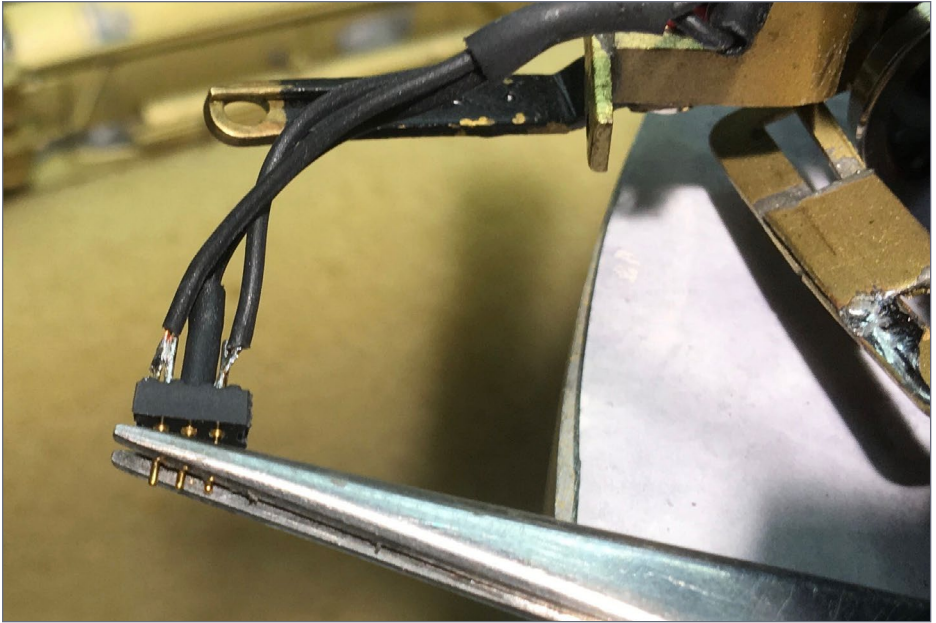

2. Three-pin male connector being wired to the loco.
Bruce Petrarca photo

DCC IMPULSES | 5

Then I wire them. Here's how.

The wiring diagram [3] shows a three-pin connector between the loco and the tender. The loco shell (red) is wired to the center pin. The outside pins have the motor. Wiring this connector this way

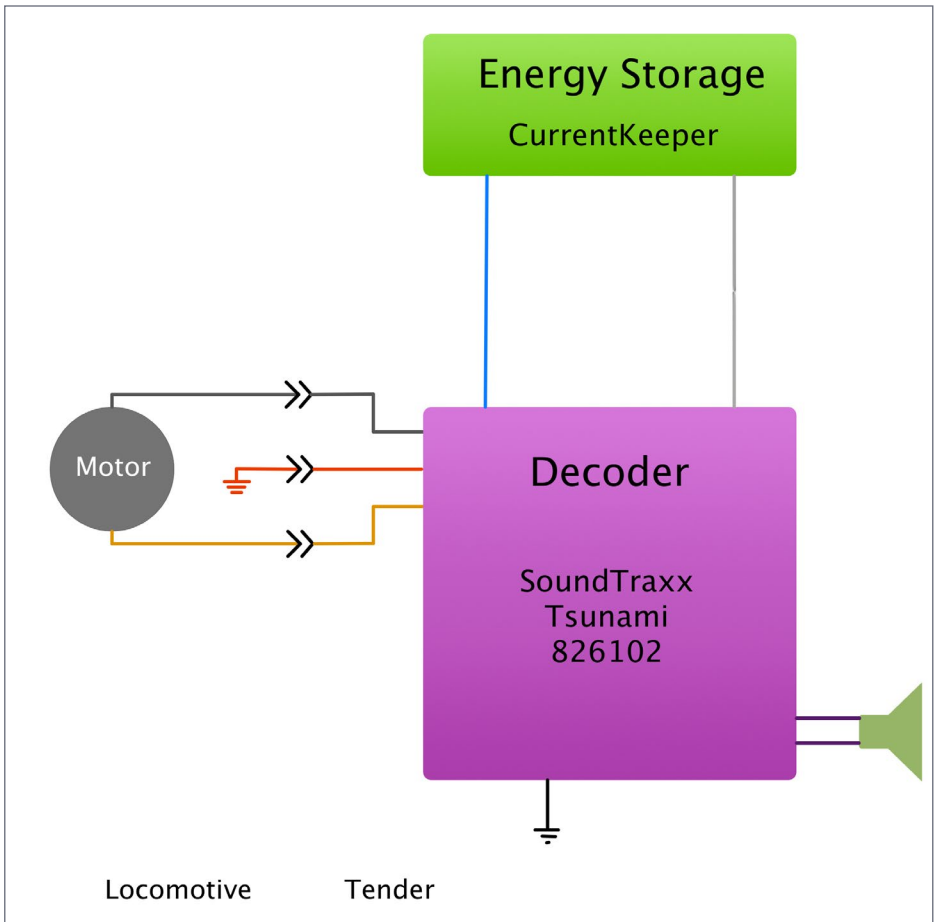

3. Wiring diagram of a simple installation. Not shown in this diagram is the connector between the decoder and the speaker which will allow the shell to be removed from the tender. *Bruce Petrarca diagram*

DCC IMPULSES | 6

means that there is no wrong way to plug it in. If the connection is reversed right to left, the loco runs backwards, that's all.

Photo [2] shows a three-pin header being wired. The wires are super-flexible rubber wire, such as NorthWest Short Line used to sell. It is still available from Litchfield Station as Wire28SF (litchfieldstation.net/product/wire-28-awg-super-flexible-black-per-ft). If you know of another source, please share it in the blog by clicking on the “comments” banner at the beginning or end of this column.

The header is held in a pair of spring-loaded tweezers in the photo [2]. The center pin is connected to the loco frame (right rail) and has a piece of 3/32 inch heat-shrink in place to insulate it from the other two pins. A piece of 3/8 inch heat-shrink will later be slipped over the pin end of the connector and shrunk in place to insulate the outside two pins and provide a respectable

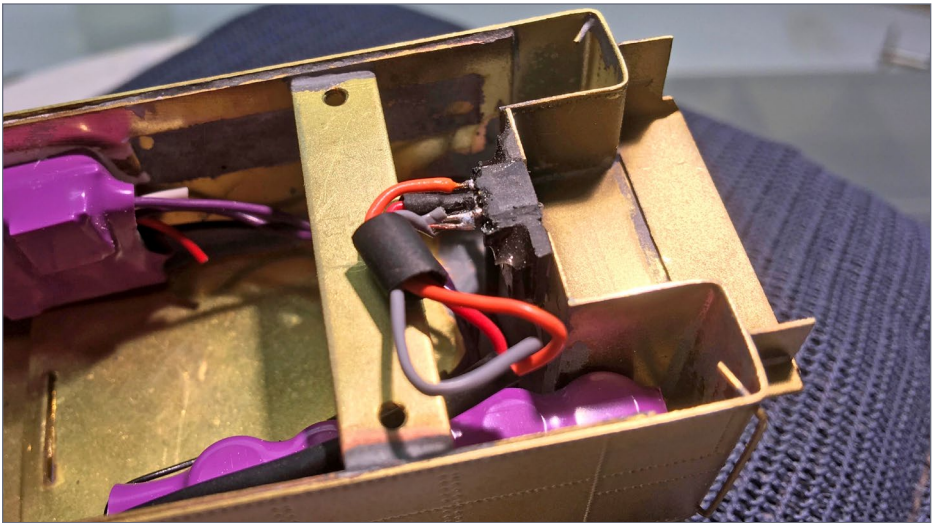

4. Three-pin female connector wired to tender side.
Bruce Petrarca photo

DCC IMPULSES | 7

looking cover. Note: At the top of the photo is a piece of ¼-inch tubing which is positioned to keep the rubber-insulated wire from chafing on the brass loco parts here and at various points throughout the installation.

The female side was wired similarly. A small opening was cut in the tender shell with my rotary tool and a cutoff wheel. Final work was done with a jewelers file and hobby knife. The header was mounted to a bit of plastic that was cut and glued [4] in such a way as to be able to mount behind the opening. I used MEK and JB Kwik Weld to get the header mounted to the plastic and JB Kwik Weld to hold the assembly to the shell.

JB Kwik Weld [8] is a black five-minute two-part epoxy that is available at hardware and home improvement stores and, of

ADVERTISEMENT

www.SBS4DCC.com

ESU TCS WOW Sound OSI Solutions ZIMO SOUNDTRAXX NCE The Power of DCC DiGraX DCC Specialties INNOVATION FOR DCC MRC Model Rectifier Corporation ACCUTRACK II SPEEDOMETER SPROG DCC the DCC Programmer and Control Family Digital plus by Lenz TAM VALLEY DEPOT Great Electronics for Great Model Railroads TEAM DIGITAL, LLC Improving the world of DCC

N - HO - HO_{N3} Scale Trains

ADVERTISEMENT

ANE MODEL

Navigator of Turnout & Digital control

LD101
Coming Soon

www.anemodel.com

• INDEX



SUBSCRIBE
(free)

• TABLE OF CONTENTS

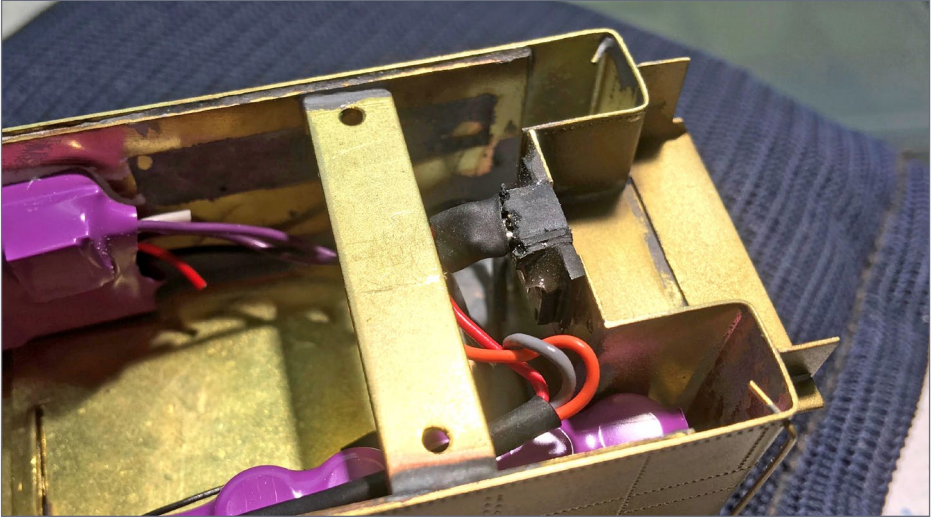

5. Three-pin female connector on the tender side after tubing has been shrunk. *Bruce Petrarca photo*

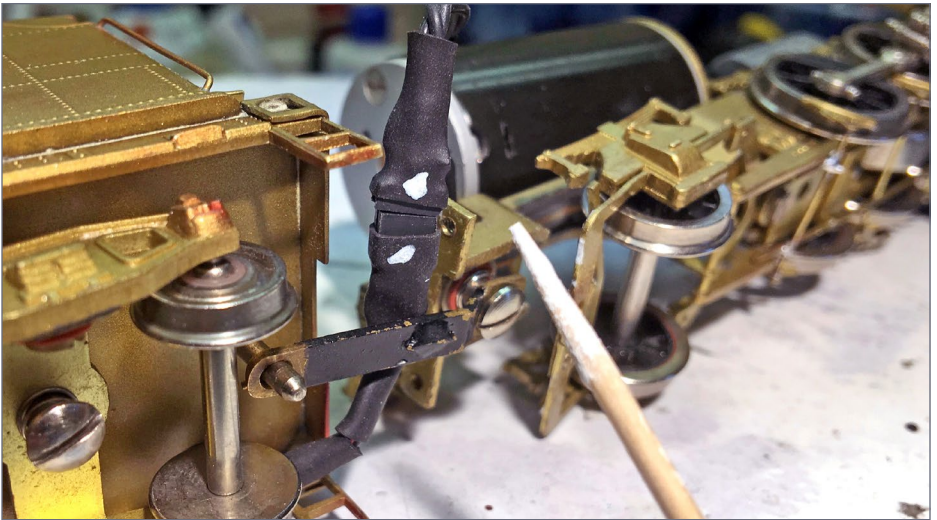

6. Marking the correct polarity on a plug and socket with a toothpick and white paint. *Bruce Petrarca photo*

TONY'S TRAIN XCHANGE

Committed to your DCC support!

Buddies and Wabbits and Hares, OH MY!

DCC Specialties products and Circuitron Tortoise Machines.
Save even more with combo packs!

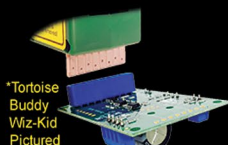

*Tortoise Buddy
Wiz-Kid
Pictured

Wire Directly To Track Power
To Power Tortoise Machines

Tortoise Buddy/
Tortoise Machine Combos
Starting at \$29.95

Order Yours

DCC
SPECIALTIES .COM

+

Circuitron



*Jack Wabbit
Pictured

Wabbit Controls 2 Tortoises, Jack
Wabbit Controls Up To 4 Tortoises

Wabbit/Jack Wabbit/
Tortoise Machine Combos
Starting at \$57.95

Order Yours



*Hare V1
Pictured

DCC Stationary Decoder,
Plugs Directly Onto Tortoise

Hare V1 & Hare V2/
Tortoise Machine Combos
Starting at \$39.95

Order Yours

Do you need a Sound or
DCC Installation done?

Get a quote!



Providing unmatched person to person
DCC support for more than 25 years, the
kind of service that has made us #1 in DCC.

DCC questions? CALL US! 1-800-978-3472

We'll get you on the right track!

July 2017



• INDEX



SUBSCRIBE
(free)

• TABLE OF CONTENTS

course, Amazon. I like to let it set up about an hour before I put any real stress on it, even though the parts are pretty well adhered in the stated five minutes.

In photo [4], the right rail (red) wire is connected to the center pin and has 3/32-inch diameter heat-shrink in position over the connection. The 3/8-inch diameter heat-shrink is ready to slide over the entire assembly and be shrunk in position. After shrinking [5], the wires are dressed so that they will not be pinched when the shell is screwed onto the frame.

Marking connectors for polarity

I hate to guess which way connectors plug into each other. In some cases [3] it won't hurt if they get put together incorrectly. The loco will run backwards from the selected direction. In other cases, they just won't mate backwards, but knowing the correct

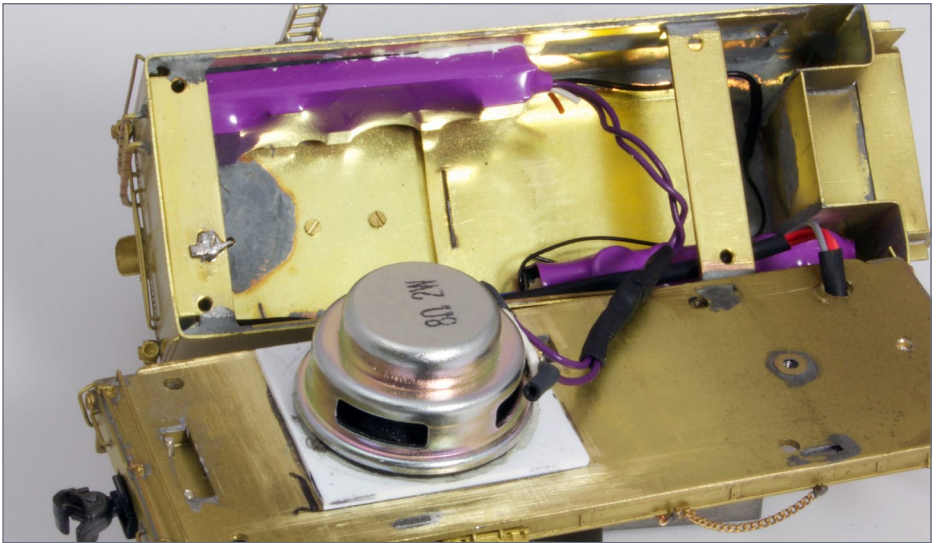

7. Tsunami decoder and CurrentKeeper mounted in tender shell. *Bruce Petrarca photo*

direction ahead of time makes assembly easier.

Here is how I designate polarity on connectors that I build.

Once I have the plug and the socket connected properly, I use some white acrylic paint (Plaid's discontinued "Paint for Plastics," in this case) and a toothpick to put a white dot on the same side of the plug and socket. If, as shown in [6], you paint the bottom side, the marks will be less obvious when the loco is running.

Getting it all in the tender

To get good sound out of this installation requires a lot of attention to detail inside the tender.

When I started sizing this loco, I wanted to put a big speaker and the Tsunami and a CurrentKeeper into the tender. It initially

ADVERTISEMENT

TCS **WOWSound**

Version 4 of WOWDiesel NOW SHIPPING!

WOWDiesel Version 4 Introducing the 645 Non-Turbo Prime Mover

All with Unmatched CD Quality Sound at
TRUE 16 bit Resolution that nobody else can
come close to!

[click here](#)

Learn why loco sound fans *prefer* WOWSound ...

Remember you "Rivet Counters", Sound has rivets too and TCS counts them better than anyone!

www.TCSDCC.com



DCC IMPULSES | 11

seemed like 4½ pounds of stuff in a 5-pound bag. But when I started parsing the task, things became clearer. The result is shown in photo [7].

The Tsunami was attached to the right side of the tender shell (upper part of the photo) with Arctic Alumina Thermal Adhesive ([amazon.com/gp/product/B0009IQ1BU](https://www.amazon.com/gp/product/B0009IQ1BU)). Sharp eyed readers will notice the slight section of white adhesive near the center of the tender. This adhesive is thermally conductive but electrically insulating, making it excellent for mounting decoders to metal sheets. They stick well; the adhesive sets up similarly to most 5-minute epoxies; if needed, the decoder can be removed from the epoxy with the twist of a screwdriver.

The CurrentKeeper was mounted partially into the protrusion at the front of the left side of the shell. This kept all of the wiring in the shell, except the feed to the speaker. Note: the left rail (black) wire soldered to the cross brace just above the left rear mounting screw boss.



8. Applying JB Kwik Weld to hold heat-shrink tubing in place on a loco tender. *Bruce Petrarca photo*

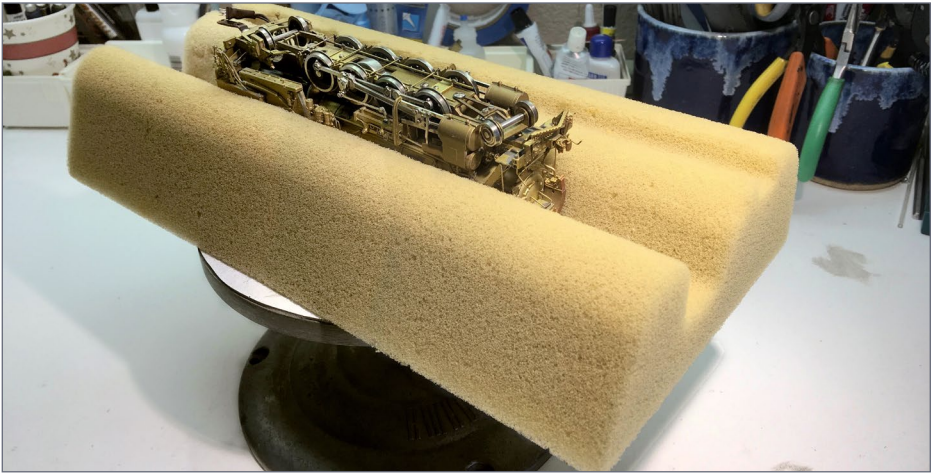

9. Decorating wheel holding up a foam cradle and a loco.
Bruce Petrarca photo

ADVERTISEMENT



NEW TECHNOLOGY



NEW Starter Kit

\$399.99 MSRP

- Includes Wireless Color Touch Screen Handheld Controller and 56 Watt Power Supply
- Expandable to Virtually any Size Layout

NEW Locomotive Module

LM-3 & LM-3S



- Direct Radio RF
- Sound and Non-Sound
- New Tiny Size
- 6 Light Outputs

Click Here to Learn More

For more information visit our Internet site: www.RingEngineering.com

DCC IMPULSES | 13

A 27mm high bass speaker (DHB27-8 from RailMaster Hobbies) was mounted offset on the floor of the tender. The reason for the offset was to allow clearance for the Tsunami decoder on the side of the speaker facing the camera.

Once the speaker location was determined, holes were drilled in the tender floor (coming from the bottom to assure that they didn't interfere with the truck mounting boss) to let the sound out.

The high bass speaker needs 0.04 inches (1mm) of space between the speaker face and the surface to which it is mounted. This allows the cone to move in front of the speaker mounting surface on loud sounds without hitting the mounting surface. To achieve this spacing, a speaker mounting board was made out of 0.04-inch



10. I use a bunch of tweezers, both regular and clamping styles. I prefer non-magnetic stainless steel whenever I can get it – most of the clamping ones are magnetic, alas. My favorite is the curved version in front. *Bruce Petrarca photo*



11. Clamping tweezers holding a multi-pin header. The tweezers are positioned on the decorating wheel by a shot bag. *Bruce Petrarca photo*

ADVERTISEMENT

**IOWA SCALED
ENGINEERING**

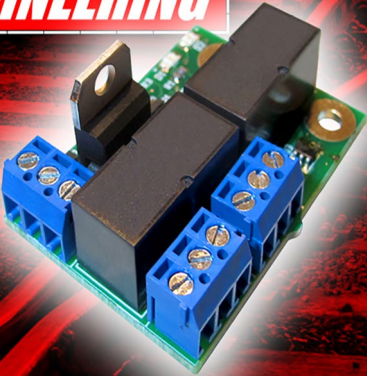

**MR servo Slow Motion
Turnout Controller**

[LEARN MORE >](#)

ADVERTISEMENT

TamValleyDepot.com



Frog Juicers

Automatic DCC polarity reversers for frogs on turnouts and crossings.

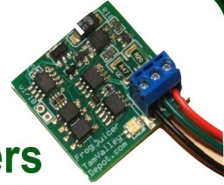

Servo Switch Machines

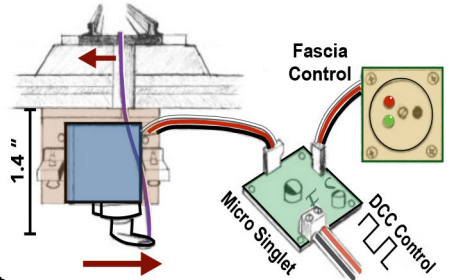

thick white styrene, with a cutout in front of the speaker about 0.9 inches (23mm) in diameter.

The speaker is held to the board with a SoundTraxx 28mm speaker gasket (part number 810054) and the board is held to the floor with JB Kwik Weld [8].

The connection between the Tsunami decoder and the speaker is made with a two-pin connector to allow the shell to be removed from the base.

Some things that make this easier

Tools help make our lives easier. Here are a few of my favorites.

While photo [8] was designed to show my way of mixing epoxy, it details many tools and ideas.

Epoxy: I use old business cards, the stiffer the better, as a mixing board. Mix with toothpicks and apply. When the job is done, the card, toothpick and left-over epoxy goes in the trash.

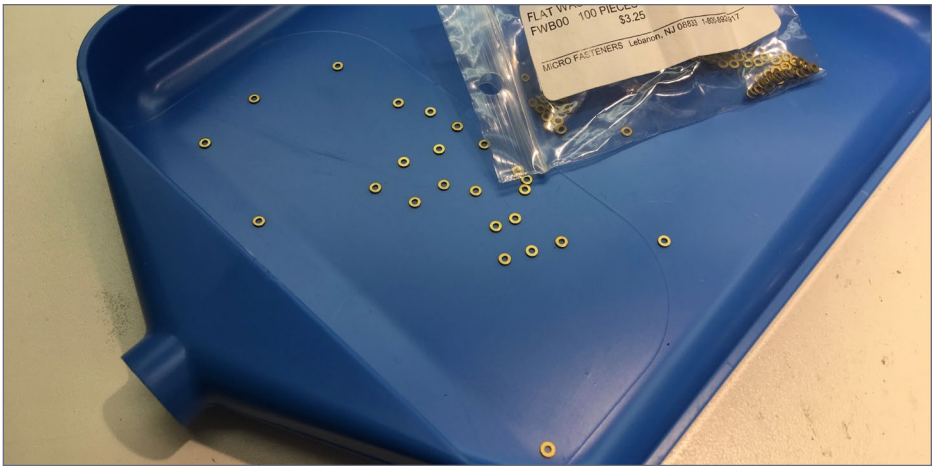

12. Small parts can be poured into a sorting tray, used and the remainder poured back into the bag. *Bruce Petrarca photo*

DCC IMPULSES | 16

Lead shot bags: I use old scuba diving weight bags (blue mesh in the photo –in 1 and 2 pound sizes) for holding things and supporting things like this tender with a doghouse, as shown in [4], [5] and [8]. They are great for holding items together while glue sets up, too.

Also in [8] are the bottom of my decorating wheel and spring tweezers. The decorating wheel is better seen in [9], the tweezers in [10].

There are several other things at work in [9].

I like foam cradles to hold rolling stock while working on them. I have them in HO and O sizes. I use the O size or shot bags for work with garden locos and cars.

The decorating wheel has been hailed as one of the best suggestions that folks have taken from my column and videos.

Officially known as an Amaco No. 5 Decorating Wheel, they are available from Dick Blick (dickblick.com/products/

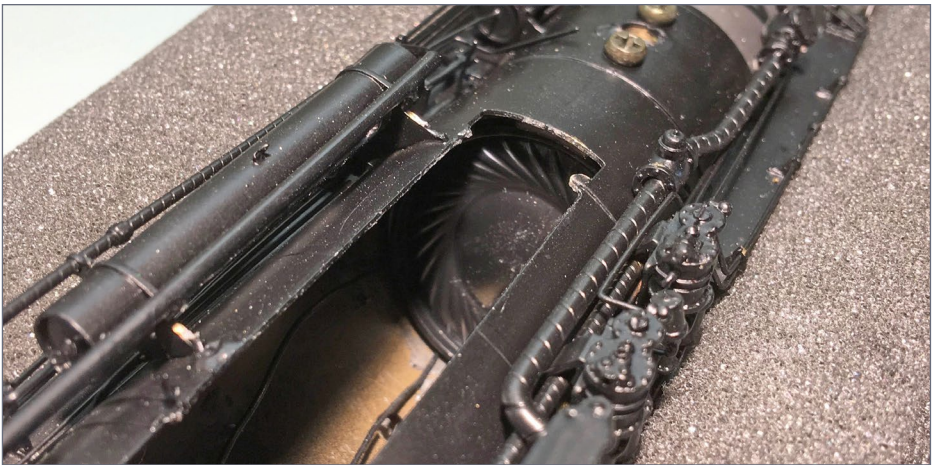

13. A 28mm speaker installed into the boiler of an HO 2-10-2. *Bruce Petrarca photo*

DCC IMPULSES | 17

[amaco-no-5-decorating-wheel](#)). They are pricey, about \$40 currently. They are designed to spin a pot and allow the decorator to apply paint or glaze at a constant level around it. They spin very freely and smoothly. The base and wheel seem to be made of aluminum, while the rounded post that the wheel spins on seems to be steel. I use a bit of 85 weight Nano-Oil on the pivot.

The white sheet that you can see in [11] is a bit of a foam place mat that I've cut to fit the top and held down with a bit of caulk. This keeps the surface cushioned and not electrically conductive. The height of the wheel makes working on things on it more comfortable for me, elevating them about 6 inches above the workbench. I've tried less expensive versions and found them seriously lacking.

With a locomotive that I'm working on positioned on this wheel, I can move it around and access every side without picking it up and damaging something. Everybody who has popped for the

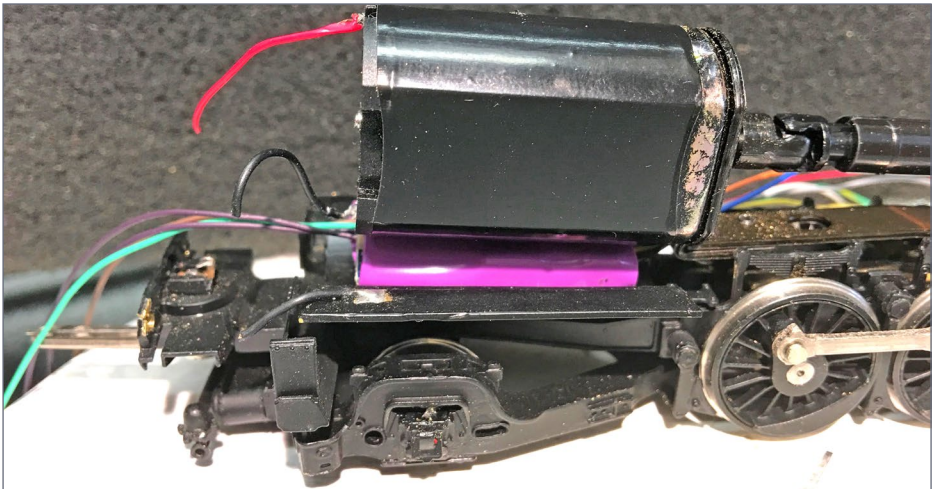

14. A Tsunami2 (TSU-1100) being installed under the motor in the 2-10-2 HO locomotive. *Bruce Petrarca photo*

bucks has told me how much they like owning a wheel.

Also in [9], you can see the lighting I use on my workbench. The background and left edge of the foam cradle is lit by a fluorescent shop light (bluish light). This fades to a brighter light with better color rendition toward the right edge of the cradle. This warmer light is provided by a 3000°K color temperature LED floodlight in a swing-arm style drafting light. I can move this around to point where I need it. A few years back, I replaced the 50W halogen bulb with the 8W LED. The reduction in heat on the bench is amazing.

Tweezers [10] are the fine fingers I need to work with small wires and connectors. As you can see, I have a bunch and use them all. Josef, my copy editor commented: “If you can find a supply of

ADVERTISEMENT

Great control in a tiny package



- Touch Toggle™ plug in controls
- Bright clear indication
- Easy setup
- Flexible system

Stall Motors, Twin-coils,
Power, and Servos

Now for Tam Valley Depot
and MRservo too!

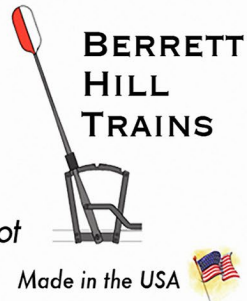

What will they think of next?

www.berretthillshop.com

• INDEX



SUBSCRIBE
(free)

• TABLE OF CONTENTS

watchmakers tools, many of them are bronze or other non-magnetic alloys. I have a few from a long-ago watchmaker neighbor.”

Corraling those small screws & other hardware parts

I use a plastic sorting tray that I bought on Amazon for about \$5 ([amazon.com/gp/product/B000CRB3V6](https://www.amazon.com/gp/product/B000CRB3V6)). I pour parts from a small bag (00 washers in the case shown in [12]) into the tray. It is easy to pick them out of the tray. Once I’m done with them, the funnel spout built into the tray makes it easy to get them back into the bag.

On the subject of small parts, most of mine come from Micro Fasteners ([microfasteners.com](https://www.microfasteners.com)). They sell many of the sizes of screws, machine screws, nuts, washers and lock washers that we need in our hobby for a very competitive price. Their (USA, at least) shipping charges are reasonable and their service unparalleled. For example, the 00 brass washers shown in [12] were \$3.25 for 100 pieces.

Getting the sound out of the boiler

Some folks feel that having the speaker in the boiler makes for a more realistic sound image. Sometimes it is possible, sometimes not. Here is a loco where it is possible [13]. I did a similar 2-10-2 for a customer several years ago. He was so impressed that he asked me to do another.

I cut about $\frac{1}{3}$ of an inch off the weight at an angle so that the top of the speaker is closer to the rear of the loco than the bottom. This minimizes the amount of weight lost for the speaker to clear the gear tower. In this case a 28mm speaker fit the internal diameter of the boiler. It did require hand-filing the nubs off several of the detail parts that were preventing the speaker from just sliding into the shell.

The magnet of the speaker was held onto the weight with double-sided tape. A small bead of caulk was applied around the edge of the speaker after it was inserted into the boiler. Note: Be careful



Southern Digital

WWW.SODIGI.COM

Celebrating 25 Years of serving you !



**Soundtraxx Tsunami
Motor/Sound Decoder**
50% Off while they last

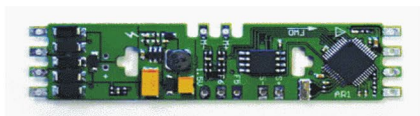

Super Sale



Simplex Radio
Throttle clearance
while they last



Close Out

DT402R
\$165

UT4R
\$99

DCC Conversions, Service & Support

E-mail: sales@sodigi.com (770) 929-1888



• INDEX



SUBSCRIBE
(free)

• TABLE OF CONTENTS

not get the caulk on the speaker cone.

In this configuration, the positive sound pressure (off the cone side of the speaker) is routed out through the rear of the loco. The negative sound pressure (magnet side of the speaker) is vented out the stack.

I installed a Tsunami2 (TSU-1100) under the motor where the lighting board had previously been. A stall current test (mrdccu.com/curriculum/stall.html) of the loco showed that the TSU-1100 would not be overtaxed by the motor.

The photo [14] was taken during the test-fit process and does not reflect the final installation.

This loco has a Vanderbilt tender. Working inside these tenders is a major pain. With the installation centered inside the loco, very little work needs to be done in the tender. In fact, only one wire needs to run between the loco and the tender: to activate the rear light.

Hopefully these tips and comments will give you some ideas on how to better install your decoders. The tools that I like are not necessarily what you would prefer. Share what works for you. Just click on the Reader Feedback icon at the beginning or the end of the column. While you are there, I encourage you to rate the column. “Awesome” is always appreciated. Thanks.

As you can see, all these “issues” will now be behind me since I’m retiring from doing any further DCC installs in brass locomotives!

Until next month, I wish you green boards in all your endeavors. ☑



**Click here for
reader comments**

ADVERTISEMENT

Make LocoNet wiring extremely simple!



Suitcases belong in your baggage cars, not under you layout!

Introducing the DCC Vampire II ... this guy does the job of two suitcase connectors! And really holds the connection good too!



CLICK NOW TO DISCOVER THE AMAZING VALUE!

Dealer Inquiries Accepted

ADVERTISEMENT

END OF TRAIN DEVICE

NEW SAFETY GREEN

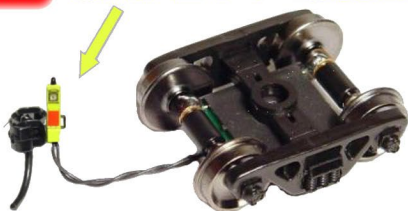

Bright Red Flashing Light!

Installs in minutes!
No freight car modification required!

Patented Technology - US Patent 7,549,609

Does not affect Load!

↓ Car without Load ↓

↓ Car with Load ↓



Click Here to Learn More

RE RING ENGINEERING™

• INDEX



SUBSCRIBE (free)

• TABLE OF CONTENTS



Introducing

Complete Train Control

The next Evolution in Complete Train Control®

- Premium Advanced 5/8 Amp Starter Sets.
- Starter sets are available as standard tethered or duplex radio.
- The system features a DCS210 Advanced Command Station, DT500 series throttle, and includes a power supply to make getting started easier than ever.
- The DT500 series throttles can be purchased separately from the new Starter Set.

Find out more @ www.digitrax.com



E
St
DT
PS

E
D
DT
PS

the **EVOLUTION**™



Evolution (shown) | **\$450 MSRP**

Standard Set Includes: DCS210 Advanced Command Station, T500 Advanced Super Throttle, UP5 Universal Panel, 6615 power supply, and a LT1 LocoNet Tester.

Evolution Duplex | **\$660 MSRP**

Duplex Set Includes: DCS210 Advanced Command Station, T500D Advanced Duplex Throttle, UR92 Universal Panel, 6615 power supply, and a LT1 LocoNet Tester.

Litchfield



"Where we make DCC fun!"

S T A T I O N



\$49.95 - \$119.96



N & HO SELECT SERIES

\$85.95



\$70.00



\$87.96 - \$143.96



- Click here to visit our website -

www.LitchfieldStation.com
623-298-7355



GETTING REAL

column

NICK MUFF
.....



[Click here to rate or comment on this article](#)

MODELING THE KANSAS CITY SOUTHERN RAILWAY | IT'S ALL IN THE DETAILS

NOW THAT THE TOWN OF GRANDVIEW IS substantially complete, let's discuss the details that bring the town to life. What follows is a potpourri of tips, techniques and methods, in no particular order.

Model Railroading as an Art Form

In addition to model railroading, I also paint watercolors. This helps me to see parallels between the two artistic mediums. The watercolor artist recreates scenes in two dimensions; the model railroader, when he begins adding scenery to the layout, is re-creating a historical or imaginary setting in three dimensions.

In painting a watercolor, the first step is to create a sketch on the paper. This determines where all the later colors and shapes will go. I liken this to the planning phase when building the layout.

In watercolor, the usual next step is to fill in large areas such as the sky. This determines initial boundaries and values. On the layout, this corresponds to benchwork, track, wiring, etc.

▶ [MODELING REAL RAILROADS AND WHAT THEY DO](#)



GETTING REAL | 2



1. Fall in New England, street scene.



2. Fall in New England, waterfront.

The next watercolor step is to fill in the trees and structures in the painting, which corresponds with adding road structures and trees to the layout.

It's those final details added to the painting that bring the scene to life.

The same is true for model railroad creations, and this final detailing is the subject of this article. I see many photos of fine model

GETTING REAL | 3



3. A sketch establishes relationships.



4. Adding sky and foreground establishes boundaries and values.

railroads without weathering and with not a single weed or piece of trash in sight! It's these final detail steps that make your artistic creation convincing.

As it is in art, so it is in model railroading, the sum tends to be greater than the total of the individual parts. As my dad used to say, "There must be a dozen ways to do this; we just have to think of one."

GETTING REAL | 4

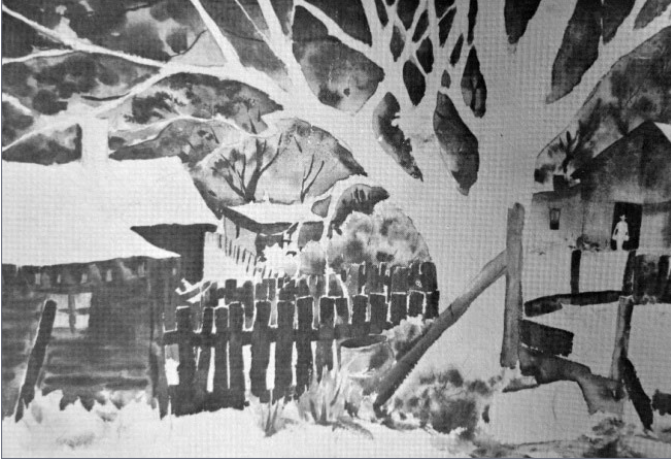

5. Adding structures and fences.



6. It's the final details that bring the scene to life.

To give credit where credit is due, many of these techniques were developed by the “master,” George Sellios. Described in this article are methods that I have used, adapted, and found to be effective and repeatable.

Painting and finishing brick buildings

Whatever era you model, brick structures are likely to end up on your layout. This is especially so when modeling the popular steam

GETTING REAL | 5

to diesel transition era. Most of the brick materials now available, such as those from N-Scale Architects, are plastic. Many of the brick structures on my layout are so large that using an airbrush would be time-consuming and many structures would not fit in the spray booth. So I have used rattle can spray paint for this purpose and for most other finish work in this article.

Brick comes in a great variety of colors. Even red brick comes in many shades from light to dark and from oxide red to purplish. Check out the spray paint section of your local store. Below are some selections that I have used.

Brick Red

Krylon: Bonfire

Rustoleum: Terra Cotta, American Tradition Colonial Red, American Tradition Claret Wine, Redwood

Valspar: Brick Red

Gray

Krylon: Dove Gray

Rustoleum: Gray Stone

Buff

Rustoleum: Clean Metal Primer, American Accents Nutmeg.



7. Rattle can spray paint brick colors.





8. Spray on an even coat and let dry.

First, spray the brick wall with an even coat of your chosen brick base color [8] and let it dry.

Next, dry-brush random dark patches onto the brick with Floquil Grimy Black or the equivalent [9]. This can represent soot or mold and adds a lot to the final appearance.

Allow the wall to sit for a few minutes, then apply a wash [10] using a mixture of India ink and alcohol (2-4 tsp. of ink in 1 pint of isopropyl alcohol). A more concentrated solution leads to a greater appearance of age. Hereafter I will refer to this by my own term “Blackahol” to save writing “mixture of India ink and alcohol” many times. You will see that I use this mixture frequently in my modeling.

When the Blackahol is dry, spray the wall dead flat [11]. I have found Model Master “Lusterless” spray to have the flattest finish. When this is dry, fill the mortar lines [12] with a dilute mixture of tan and gray acrylic paint for red brick. Dark gray can be used to fill the mortar lines in gray or buff-colored brick.

Adding signs to brick walls

Large and small signs added to brick walls enhance realism and are a great way to set the time and place. Graphics for creating signs can be found in a wide variety of places. One of my favorites is a catalog of tin signs [13]. One catalog provides a lifetime supply!

GETTING REAL | 7

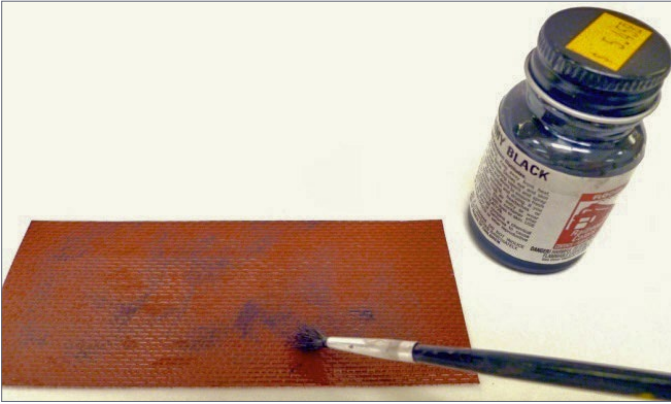

9. Dry brush on grimy black patches.

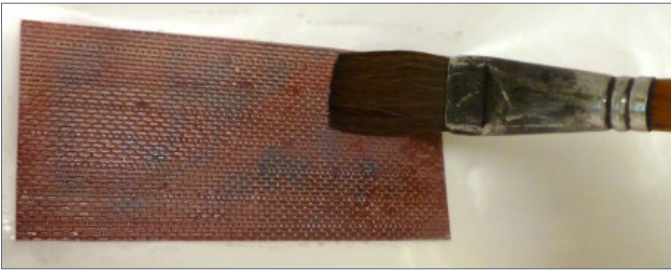

10. Wash the wall with "Blackahol."



11. Spray the wall with flat finish.

12. Fill the mortar lines with dilute acrylic paint.

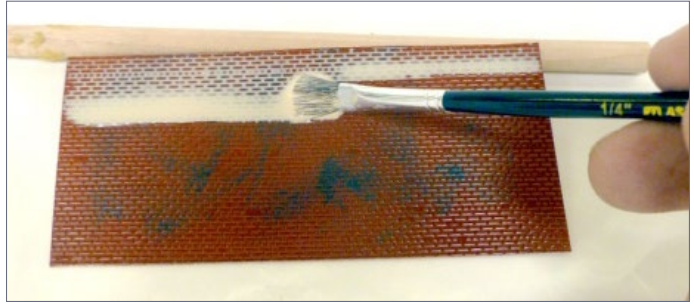

Magazines are also a great source, especially for larger images. This technique uses images that come pre-printed on coated paper.

It helps to thin the paper sign by sanding the back side with fine (600 grit) sandpaper [14].

I also often age the sign by rubbing the front side with fine steel wool [15]. Work carefully and make sure to not overdo this process!

I weather the sign by brushing vertical streaks using Blackahol. Once this is dry, I use full strength white glue to apply the sign to the wall, covering the entire area of the sign [16].

When the white glue has had some time to dry, press the sign down carefully into the brickwork by running a fingernail along the mortar lines [17].

Next, spray the wall with Testor's Lusterless flat finish. When the sign is completely dry, dry-brush full strength oxide red (or matching brick color) carefully across the surface to "pop out" the brick detail [18].

Finally, I weather the wall using Bragdon chalks. Their "Used Brick" color provides a faded appearance. "Grimy Black" will blend the scene overall, and "Dustbowl Brown" along the bottom of the wall represents mud kicked up by rain and passing traffic.

GETTING REAL | 9



13. Tin sign catalog page, a great source of signs for modeling.



14. Thin the sign by carefully sanding the back. (Make sure to use the sandpaper on the *back* of the sign, not the front.)



GETTING REAL | 10



15. After aging with steel wool.



16. Apply the sign with full-strength white glue.

GETTING REAL | 11



17. Run fingernail along the mortar lines.



18. Dry-brush brick color across the surface of the brick to simulate fading.

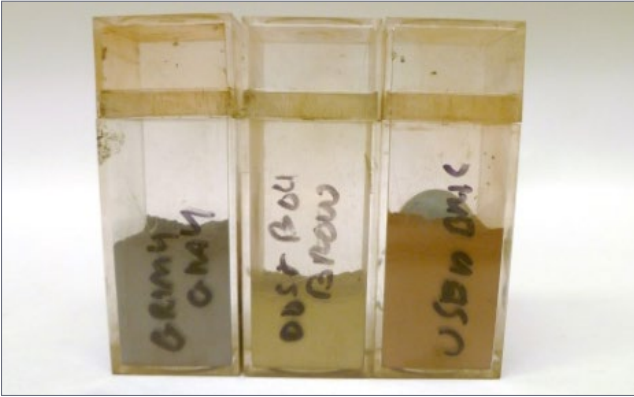

19. I weather the signs with Bragdon chalk.



20. The finished appearance looks naturally like a real painted sign on the brick.

Adding glazing, blinds, and awnings

I use microscope slides and microscope cover slips (search Amazon.com) for glazing. Nothing can equal the flatness and reflectivity of real glass.

I use a diamond scribe from Micro-Mark to scribe and cut the slide glass and glue the pane in place with dabs of Micro-Mark PSA (Pressure Sensitive Adhesive).

A shot glass is a great way to hold toothpicks for applying glue and pressing the glass into place. The bottom of a second shot glass can hold a small amount of glue.

The PSA dries clear but remains tacky so I can apply the glue [22], let it dry, then press the glazing into place onto the tacky surface. This way, I get no glue seeping onto the visible surface of the glass!

GETTING REAL | 13



21. Supplies for doing window glazing.

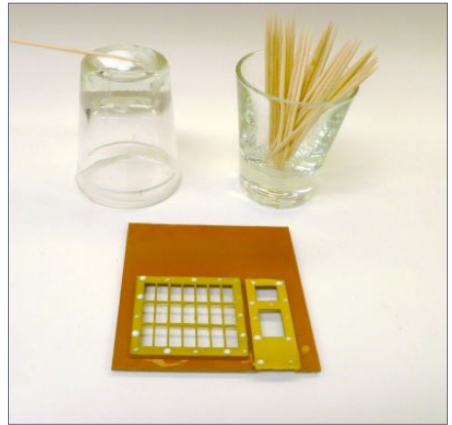

22. Apply small dabs of glue to the backside of the window frames.

Manila or gray folders provide a cheap source of stock for blinds [23, 24]. Cut to size and glue to the back of the windows at varying heights using the PSA. Curtains can also be painted on the back of the glass.

I create awnings as drawings in my CAD program [25]. I can create any size, shape and color I need using this method. I make sure

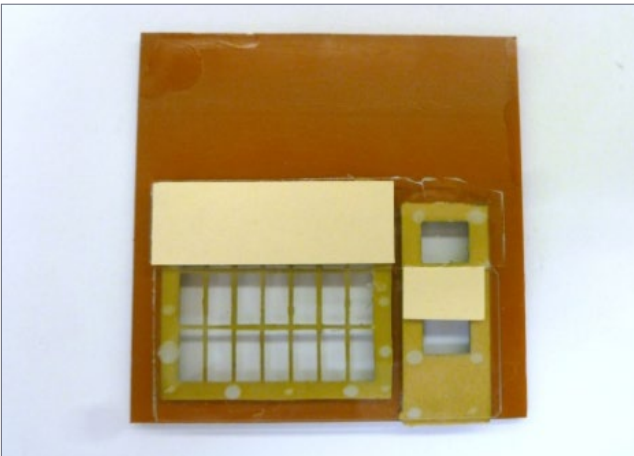

23. Manila folder stock makes great blinds.

GETTING REAL | 14



24. Installed blinds, from the outside.

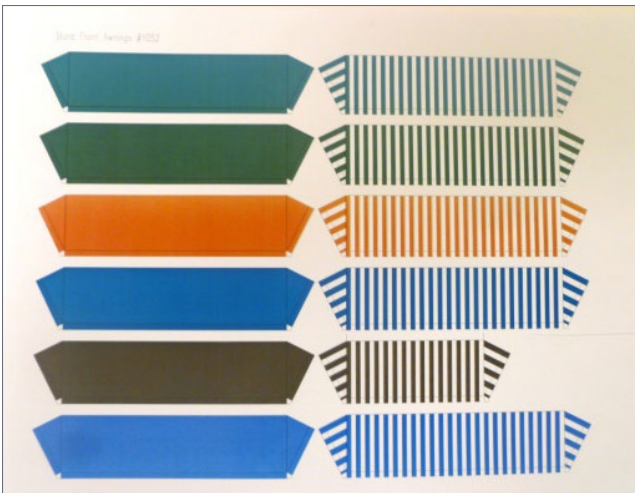

25. Awnings printed on cardstock.

and add attachment tabs [26] to the upper edge and sides of the awning. I print them on card stock, then fold them to shape and glue them over the windows with the PSA glue [27].

Fade and weather the awnings with chalk. A lot of soot and grime can collect on the top surface and wash down to the front edge.

GETTING REAL | 15

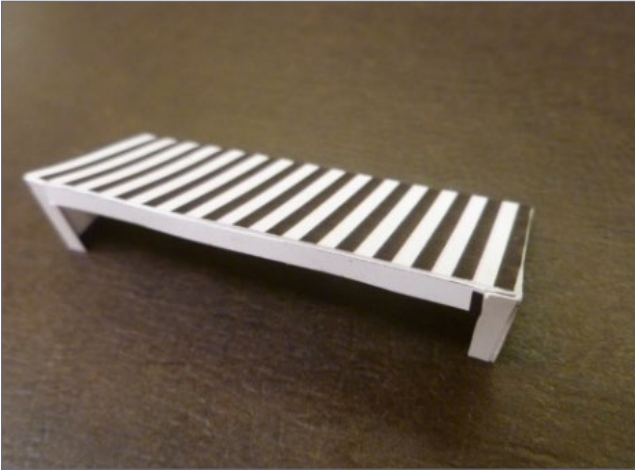

26. Attachment tabs, top and sides.



27. Here is the awning in place.

Wooden fences

Using Central Valley board fences [28], I cut out random boards [29] with a hobby knife or single-edge razor blade (four cuts). I cut out more or less depending on the degree of decrepitude I'm after! I also cut the tops off random boards to make them uneven.



GETTING REAL | 16



28. Central Valley Fence & Railing No. 1601.

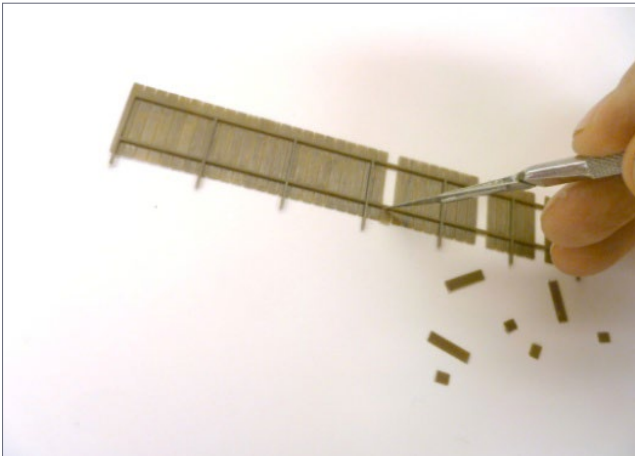

29. Cut out random boards.

Next, I spray the back with light gray primer [30]. I paint the front various colors depending on the desired fence color [31]. I weather the back of the fence using Blackahol with horizontal and then vertical strokes. I weather the front with vertical strokes [32]. Finally, I add additional weathering to random boards on the front.

I remove random pickets from the picket fence in the same way and spray the picket fence with light gray primer front and back. Once that

GETTING REAL | 17

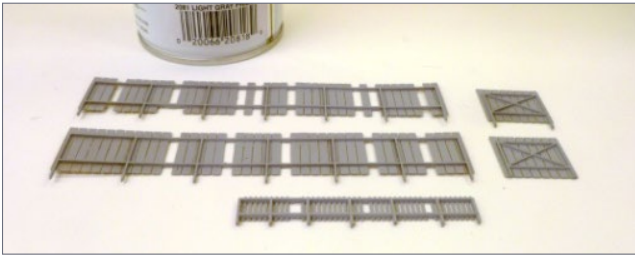

30. Spray the back side of the fence with light gray primer.



31. Spray the front of the fence red, green, or your choice of color.



32. Weather both sides of the fence with Blackahol.



33. Weathered picket fence.

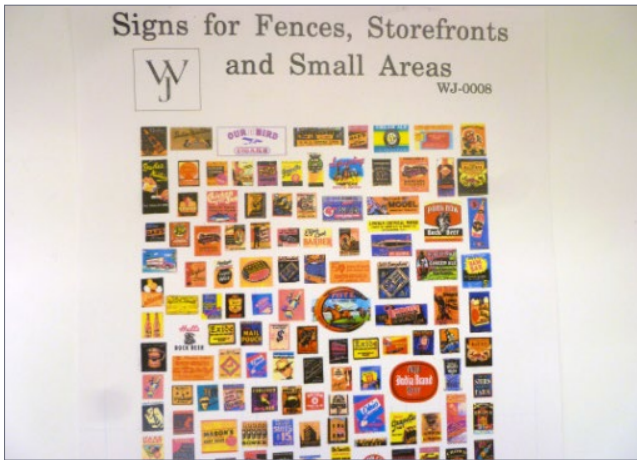

34. Small signs and posters for the fence.

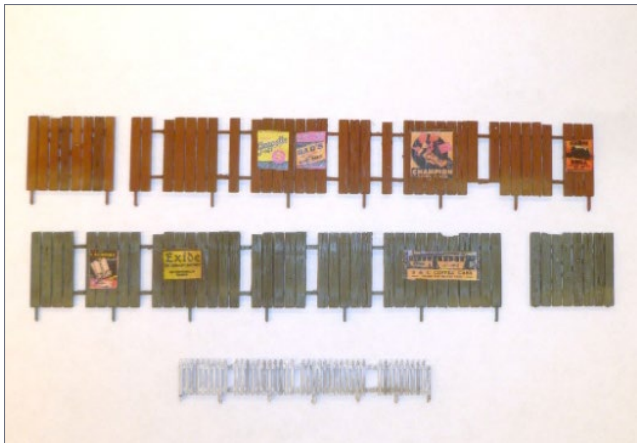

35. The finished fence with signs and posters.

is done, I dry brush on some white acrylic paint. This technique turns the plastic originals into a finished product that looks as if it might have been built board by board [33].

Optionally, I may cut out signs or posters [34] and add them to the board fence using white glue and then weather with Blackahol. As a final touch, I dirty up the front of the fence with Bragdon chalks. I like using Bragdon Grimy Black in vertical streaks and Dust Bowl Brown along the bottom edge for the look of a well-worn fence [35].

Tarpaper roofing

I use .040" styrene sheet for most structure roofs. For a tarpaper roof, I cover it with strips of 3/4' black masking tape to represent tarpaper with patches applied as desired [36]. I spray paint the roof with a flat grimy black color and seal it with Model Master Lusterless spray.

Next, I brush the roof with Blackahol, dipping the brush in Raw Sienna Acrylic paint as needed to add some rust. I work across the roof, brushing the mixture on [37]. Finish up by weathering with Bragdon Grimy Black, Rust and Dust Bowl Brown chalk.

This process can also be done with Box Car Red, Dark Green, or the color of your choice to get a roof of another color [38].

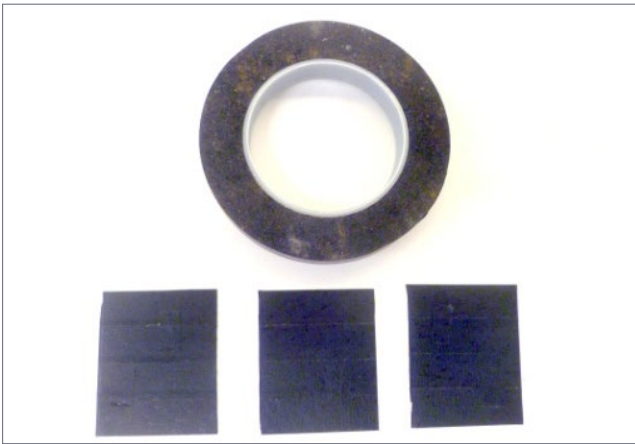

36. Black masking tape simulates tarpaper and patches.



37. Blackahol and acrylic paint for finishing the tarpaper roof.

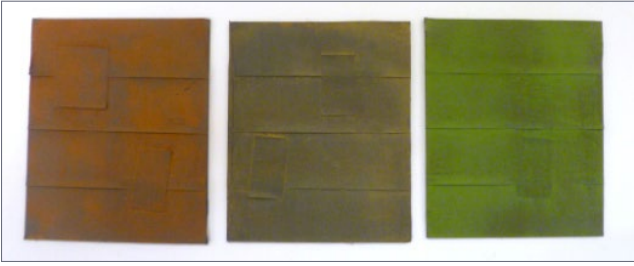

38. Different-colored tarpaper roofs weathered with chalk.



39. Spray wood siding with light primer gray to get a weathered base color.

Weathered wood siding

In the photos, I used a piece of Northeastern Scale Lumber clapboard siding, but styrene siding would work as well. First, I spray paint the siding with light gray primer [39]. Then I brush on thinned oxide red (or another color of choice) using a soft 3/8" wide brush.

I brush along the siding lines, applying color in uneven bands [40]. I add nail holes using a pounce wheel [41] at appropriate locations (16" centers are common). For an extra run-down look, I use a single edge razor blade to "lift" boards here and there [42].

After this, I wash the siding with Blackahol [43] and finally, I dry-brush the siding vertically with off-white acrylic paint [44]. This highlights the edges of the siding boards which tend to weather more.

GETTING REAL | 21



40. Brush the siding with dilute red acrylic paint along the grain of the boards.

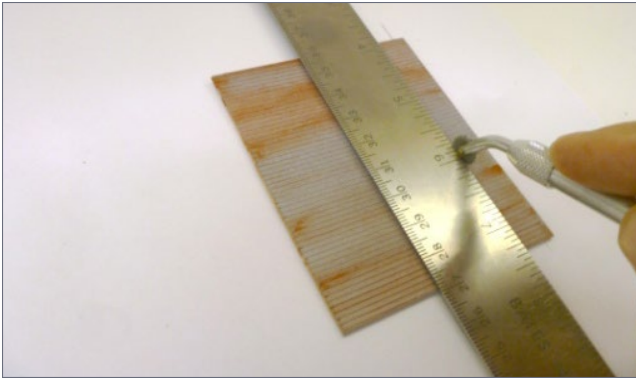

41. Add nail holes with a pounce wheel.

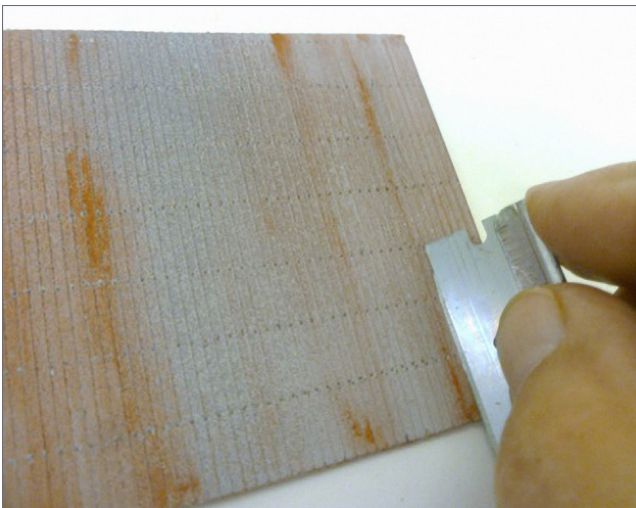

42. Lift boards here and there using a razor blade.

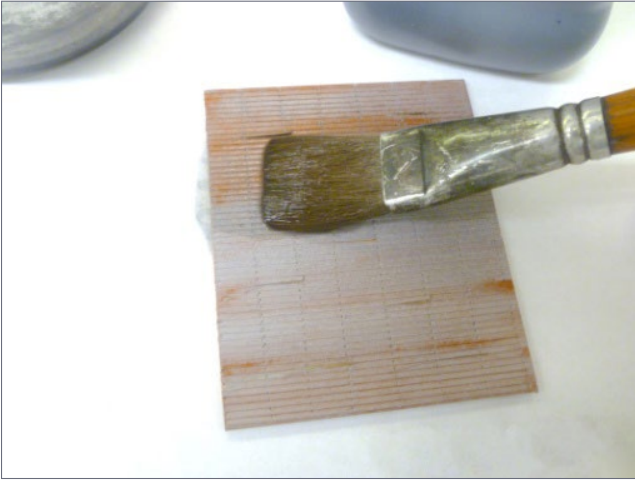

43. Brush the siding with Blackahol.



44. Dry-brush the siding vertically with off-white acrylic paint.

Corrugated Metal Siding

For metal siding, I like to use Campbell's or other corrugated metal strips. I run a pounce wheel along the bottom edge [45] to create nail holes, then I cut the strips into 5/16"-3/8" wide pieces.

I glue the metal siding pieces onto the wall with Aleene's tacky cement [46], working up and across, overlapping the pieces and

GETTING REAL | 23

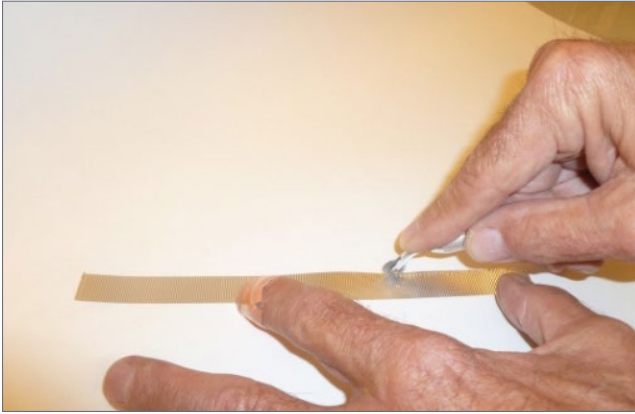

45. On metal siding, run a pounce wheel along the edge of the siding to add nail holes.

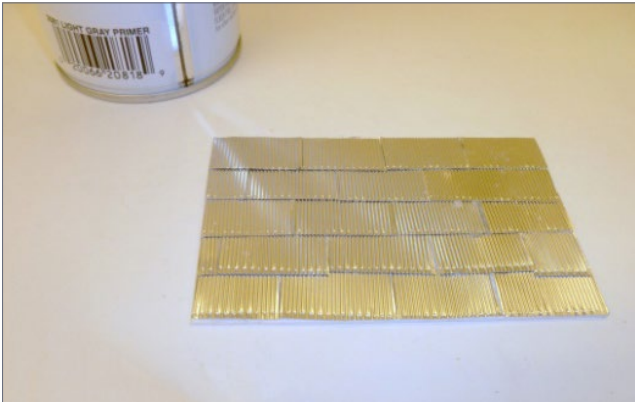

46. Glue the metal siding on with tacky cement.



47. Spray paint the metal siding light primer gray to provide a consistent base for weathering.

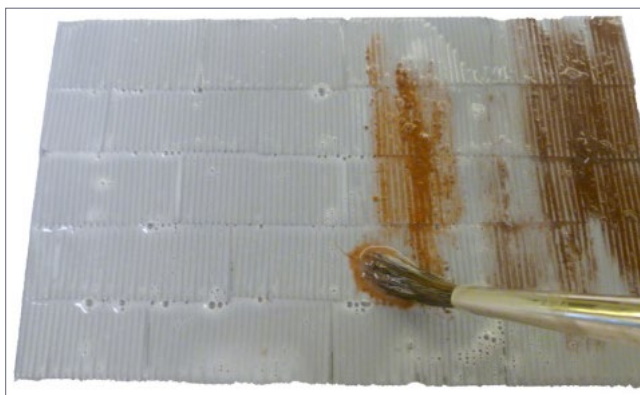

48. Brush with a mixture of white glue, water, and rust-colored chalks.



49. Completed corrugated siding.

making the line uneven but keeping the nail holes at the bottom. Once the metal siding has all been applied, I spray paint it with light gray primer [47].

I mix 5 tsp. of water with 1 tsp. of white glue and brush it on, mixing the glue with the Blackahol mixture adding in streaks of raw sienna/burnt umber chalk powder using a ½” wide soft brush [48]. Streak down, applying large areas of the chalk coloring. This gives a nice gritty, grungy appearance.

When it's dry, I apply Blackahol. Finally, I dry-brush with Bragdon chalk powders in Bright Rust, Dark Rust, Grimy Black, and Dustbowl Brown to subdue and blend the shades from the previous step.

Yard scrap detail

Yard scrap detail represents some of the “industrial scrap” you can find in and around the railroad – and especially in frequent piles near a railroad yard.

For scrap wood, dip lengths of scale wood 1x3's and 2x4's in black ink, then break them into pieces of random lengths [50]. I fix piles or individual boards on the layout in place with white glue.

For newspaper trash, I create dirty paper by painting white paper with streaked Blackahol [51]. When dry, it looks just like dirty newsprint and/or paper scraps with tiny writing. I use some yellow ochre paint wash to simulate aged newspaper. I cut this paper into HO scale-size newspaper pieces [52], fold and crumple them, and glue them in random collections around the layout.

To simulate old rusty tie plates, I paint paper rail brown/rust color on both sides [53], then cut it into scale size tie plate pieces [54]. I glue them into a stack and weather them with Blackahol.

For strapping bands, use brown-colored construction paper weathered with Blackahol [55]. I cut this paper into narrow strips [56], crinkle them slightly, and glue them down.



50. Scrap wood.

GETTING REAL | 26



51. For newspaper, paint paper with black stain and add splotches of yellow ocher.



52. Cut into newspaper scraps.



53. For tie plates paint paper a rail brown or rust color.

GETTING REAL | 27



54. Cut into HO scale size tie plates.



55. For strapping bands, weather brown paper with Blackahol.



56. Cut the paper into narrow strips to form strapping band scrap.

GETTING REAL | 28

For broken scrap glass, I spray .015" clear styrene sheet with Model Master Lusterless flat finish [57]. Using small scissors, I cut them into scale-size shards and pieces [58].

For rotted ties, I start with 3/32" square wood about in about 8" lengths. I scrape all four sides with a razor saw to roughen up the surface [59]. I treat the roughed up wood with a heavy raw sienna acrylic stain [60]. Once they're dry, I cut the wood into scale tie



57. Spray clear plastic with flat finish.



58. Cut into scale-sized shards and pieces.

GETTING REAL | 29

lengths, usually around 8½' and dip them in Blackahol [61]. I finish up by stacking and gluing on layout [62]. Also, don't forget to add a few stacks of new ties.

I show a couple closeup photos of finished scenes with this yard scrap detail [63]. Best of all, for the yard scrap details, the materials are cheap and the details are easy to make!

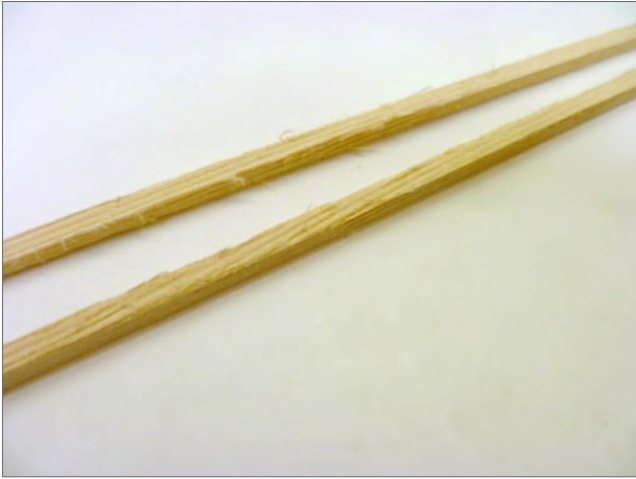

59. To create some old weathered ties, rough up some 3/32" stripwood with a razor saw.



60. Stain the ties with acrylic raw sienna.



61. Dip the ties in Blackahol.



62. The finished rotted ties.



[Click here to rate or comment on this article](#)

GETTING REAL | 31



63. Finished scenes with "yard junk" added.

HAPPY 4TH SALE!

save 17.76%

on TrainMasters TV Memberships

Use coupon code at checkout: HAPPY4TH

	was ...	now ...
Monthly	\$6.99	\$5.75
3 months	\$19.00	\$15.63
6 months	\$37.00	\$30.43
1 year	\$59.00	\$48.52
2 year	\$118.00	\$97.04



trainmasters.tv

Sale ends midnight July 4th

Become a member and save >>

Use coupon code at checkout: HAPPY4TH



WHAT'S NEAT WITH KEN PATTERSON

KEN PATTERSON

column



[Click here to rate or
comment on this article](#)

WEATHERING A COAL TRAIN, HEP SOUND, FLOOR-TO-CEILING SCENERY IN O, LASER-CUT MODELS, AND MORE ...

THIS MONTH, JASON QUINN SHOWS US THE 1980s-era C&O coal train that he weathered with a mix of cars, making for an interesting video segment. George Bogatiuk from SoundTraxx discusses HEP – Head End Power – in locomotives for providing power to trailing passenger cars. He shows how the Tsunami2 decoder can recreate this effect in our models through motion and sound.

We visit with Richard Rands and view his wonderful On30 layout where the scenery flows from the floor to the 10-foot-tall ceilings in the layout room. We look at Bachmann's new HO scale USRA 4-6-2 steam locomotive with a few tips on setting up the decoder out of the box. Mike Pyne of Wild West Scale Model Builders

▶ **PHOTOS AND VIDEO OF SUPERB MODELS**



WHAT'S NEAT | 2

shares with us his line of laser-cut model kits and a very interesting story about how and why he chose manufacturing in our industry of model railroading as a career.

Also this month, we talk about techniques and tools that aid in dusting and cleaning our models and layouts. We then build a vacuum duster head specifically for cleaning and dusting railroad models.

You can watch all of this in this July's 40-minute video that includes (as always) scale model runbys.



1. First, I want to give an update on how I use track lights to light the area around the B.T.S. sawmill diorama. 28 LED heads light up the 15-foot-long area consuming only 84 watts total. LED lights also come to the garden railroad. I have been experimenting with 3-watt lights that give a soft, even glow. They are weather-proof and easier to maintain than the half dozen tiki torches I used to light the area in the past.

WHAT'S NEAT | 3

Dusting and cleaning our models



2. For tool tips this month, we discuss all the various ways to dust and clean our models. If you leave your doors or windows open for fresh air in the layout room, the dust from dried leaves in the fall season floats in, you get windblown dirt and the pollen that comes with spring, and household dust. Just walking in the room, or having pets adds more. All of this dust settles on top of our layouts and models.



Playback problems? [Click here ...](#)

• [INDEX](#)



SUBSCRIBE
(free)

• [TABLE OF CONTENTS](#)

WHAT'S NEAT | 4



3. The best and safest way to remove dust from model locomotives and rolling stock is to use a soft artists brush to kick up and remove the dust. Hold a vacuum cleaner hose in close proximity to catch all the airborne particles before they can settle again. The fine brush will fit between hoods and stanchions without damaging fine details.



[Click here to rate or comment on this article](#)



4. Microfiber rags work great to clean my flat rivers and train display shelves, without the need for liquid cleaning agents. Microfiber attracts dust without releasing it, and one cloth can hold a lot of dirt and dust. After dusting, simply shake the cloth outdoors or run it through a washing machine to remove the dust from the clingy fibers. I have also experimented with feather dusters over the years – most of them catch on fine details when dusting locomotives but I did find a synthetic fiber feather duster that is perfect for dusting models. The fibers glide past and over the details without catching and allow me to quickly dust the models without removing them from the shelves. Again, I use a vacuum cleaner to catch airborne particles while working with this soft feather duster.





5. Here you see the two artists brushes that work best for me for dusting models. They have round tips that get into places with gentle ease, cleaning without damage to details. Now, you may consider “make-up” brushes, But I have found that the ones with a lot of hair seem to catch and push the details – there seems to be a point where too much brush can cause damage. In the video, we test the horsehair two-inch round vacuum brush and the longer Shop Vac brand five-inch brush you see in this photo. I tried them out on the layout. I spread rocky ballast on the switch yard and then proceed to test each brush. The round brush is the quickest and the shop vac brush worked well but took longer to pick up the creek rock ballast. The other larger brushes in this photo are the ones we will build in this segment specifically for dusting our layouts and models.

WHAT'S NEAT | 7



6. Have you ever noticed? After vacuuming your room, a few hours later there is a fine coat of dust on your models or flat surfaces. Using the finest and more expensive vacuum bag or filter in your shop vac or upright cleaner will aid in preventing this. These bags tend to reduce suction a little but at the same time will filter and trap the finest of dust particles. When cutting wood in my wood shop, which sits in the middle of my around-the-room layout, it became necessary to invest in a sawdust vac system that catches all the sawdust and traps it in a trash bag. Filtering the air through a two-foot-round by three-foot-tall paper filter that traps everything down to two microns makes a big difference. If you can smell sawdust while working, it's in the air and will eventually settle on the models throughout the room. The dust filtration system in the shop prevents this and saves hours of dusting and vacuuming after each wood project.





7. After dusting for years and experimenting with various dusting and vacuuming tools, it should be possible to take all the wisdom from this and build our own custom vacuum dusting brush specifically for our layouts' scenery and rolling stock and locomotives. It would require a soft brush, be a size that would be functional in all dimensions, and adapt to a standard vacuum cleaner hose. A good starting point for this could be the two shop dust pan brushes that I am holding in this photo. The hairs are 2½ inches long and may be perfect for dusting as the vacuum's suction removes the loosened airborne particles.



[Click here to rate or comment on this article](#)

Have you seen this?

**CHECK IT
OUT!**



kenpatterson.com

click here to ...

Visit Ken's website

**Ken Patterson
reveals his modeling
secrets on video!**



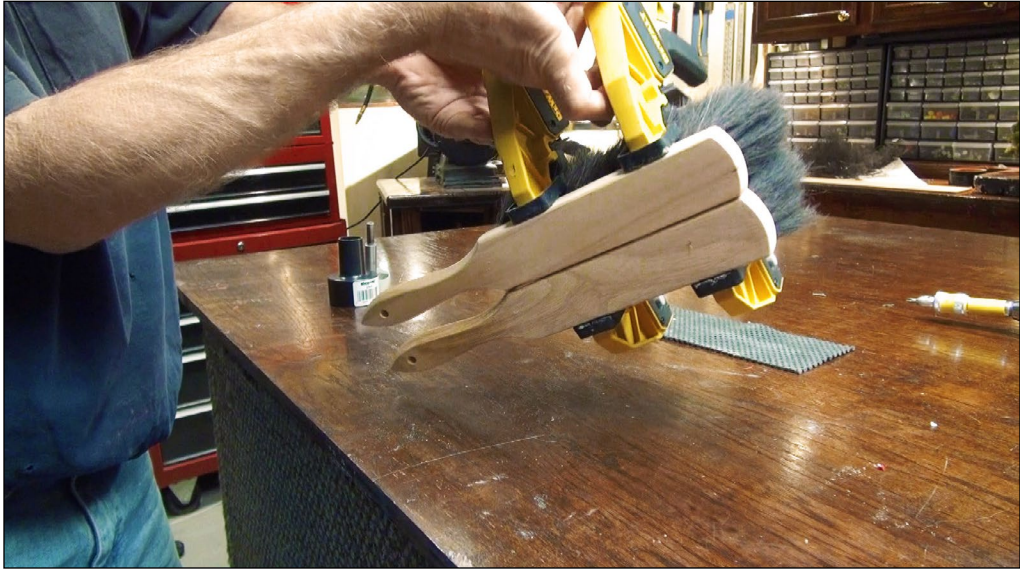

8. I sanded the clear coat off of each brush's wooden handle to ensure a good glue bond and allow me to stain the wood with red oak stain. Using carpenter's glue, I glue the handles together and clamp them tight. Let this cure overnight.



[Click here to rate or comment on this article](#)



9. Using a trowel, I divide the brush fibers into two sections and wrap this in tape to keep things divided as I run the brush through the bandsaw. Cut it in half, making two brushes each measuring about 3 ½ inches square.

Please tell your buddies about MRH!

WE RELY ON WORD-OF-MOUTH TO GROW AND A BIGGER CIRCULATION MEANS MRH IS MORE LIKELY TO STICK AROUND FOR A LONG TIME TO COME!



WHAT'S NEAT | 11



10. After cutting off the brush handles, I start making a vacuum attachment by cutting the synthetic fibers off of a two-inch round brush. Once the fibers are cut off, match the diameter of a Forstner wood hole cutting bit to match of the diameter of the vacuum cleaner attachment. Drill this hole through the fibers, wood, and nails holding the fiber hair in place in the brush. Then, test-fit the black brush attachment into the hole. Everything should fit together perfectly.

WHAT'S NEAT | 12



12. Repeat the process on the second brush, and with that we have two brushes to work with for this experiment. I cut the fiber hairs on one of the brushes with scissors but discovered later that a barber's hair clipper/trimmer works much better than scissors for cutting the fibers smooth and even. Cut the brush so the remaining fibers measure 1½ inches long. Stain and polyurethane the wood without getting any of the finish on the brush hairs.



[Click here to rate or comment on this article](#)





13. Mix some five-minute epoxy, apply this with a screwdriver around the round black edge of the attachment, and glue this into the wood for a perfect fit with both brushes. Set the part aside to cure.

**Want to help
keep MRH free?
Then click on
Ads!**

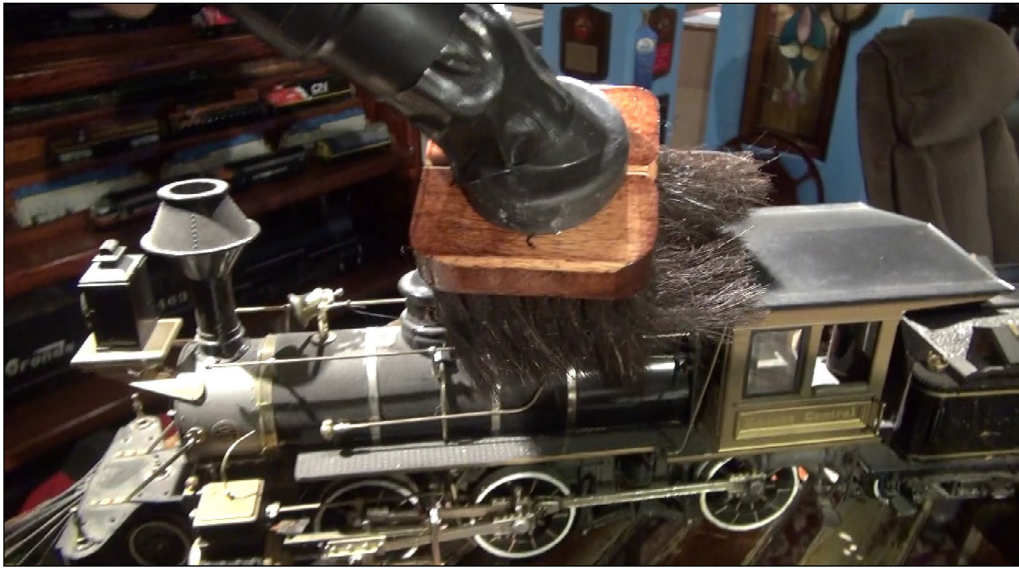

15. Once the glue has cured, put the new dusting and vacuuming tools to the test. With the rocks poured in the switch yard, the long-hair brush has problems sucking up the rocks due to the length and interference from the brush's long hairs cutting down air flow. The shorter brush did much better but also had suction problems with too many fibers being drawn in to the airstream. I solved this by cutting more fibers from the center, working outwards with scissors to thin the hairs a little. After this the brush worked great at removing the rocks from the switch yard. I tested the long-hair brush on some large-scale locomotives with dust that had been set over the years by humidity, and the brush did not remove the stuck-on dust. The short-hair brush removed all the dust the long-hair brush missed. The long-hair tool did remove dust from my shelves and flat surfaces. It also excelled at removing the dust from my window blinds, getting between every slat.



WHAT'S NEAT | 15



16. The short brush excelled at dusting my river module with the BLMA 150-foot brass bridge. It also did well dusting the tops and sides of HO scale locomotives, making this the winner of the two brushes in our test. These described tests can be viewed in real time in this month's "What's Neat" video. For general layout vacuuming and dusting, along with dusting plastic models in all scales, this 3 1/2-inch-square brush with 1 1/2 inch-long fibers is a welcome tool for gently cleaning my layout and models without damage.



[Click here to rate or comment on this article](#)

WHAT'S NEAT | 16

Wild West Models with Mike Pyne



17. At the St. Louis Sn3 convention, I met Mike Pyne, owner and designer of Wild West Scale Model Builders. He displayed 30 different laser-cut kits for sale. All had that western USA turn of the century architectural appearance that I have been seeing in all the narrow-gauge history books in my three years of study on this subject. I look forward to building some of Mike's kits and featuring their construction on the show.

WHAT'S NEAT | 17

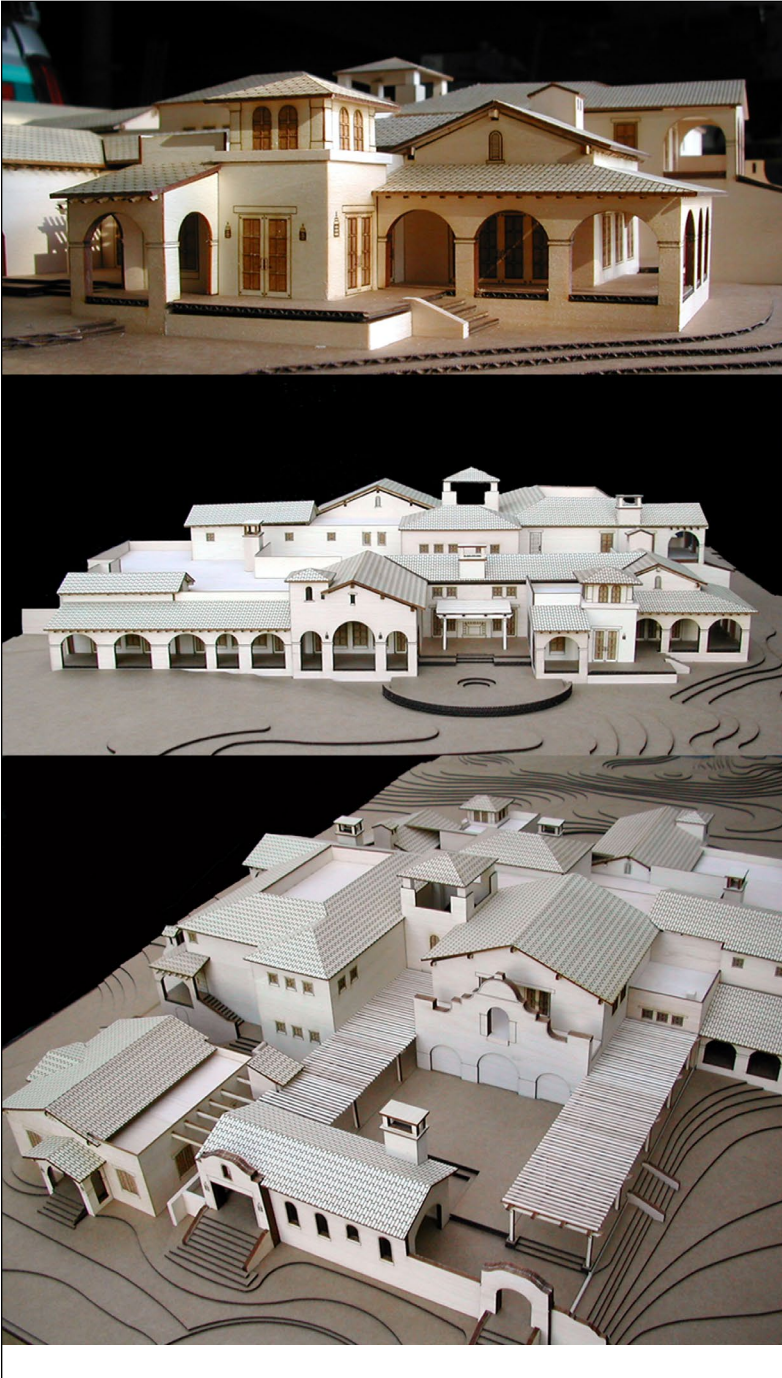

WHAT'S NEAT | 18



18. (Left) I asked Mike, "How did you get involved in the model kit business 13 years ago?" Mike said he had graduated from college with a masters degree in architecture and started building architectural scale models for various clients, all built from drawings and cut with a laser cutter, then hand-assembled over hundreds of hours.

19. (Above) During this time, his father had a business partner, a schoolteacher, whose house had burned down and who wanted to build a new home on the same lot.



[Click here to rate or comment on this article](#)



WHAT'S NEAT | 19



20. Mike designed a house for the teacher as a resume-builder project, spending days on the computer to come up with a design. The client did not understand the concept of the design by simply looking at drawings and measurements.



[Click here to rate or comment on this article](#)



21. Mike built him a model of the house as you see in this photo. It has a complete interior that can be taken apart and reassembled, allowing the client to understand the design much better. Well, Mike took this model house to Caboose Hobbies in Denver and modelers in the store suggested to Mike that he design scale structures and sell them as kits to model railroaders. Mike commented, "Toy trains, that's something you played with as a kid. And you think there is a market for small model kits in that hobby/industry?" This first house became part of his product line, named the Silverton House.



22. The rest is history. Mike now has 30 models in his company's product line, with 86 kits across the scales. It was a real pleasure to meet Mike, and I look forward to picking up some of his models at wildwestmodels.com and building them for the show.



[Click here to rate or comment on this article](#)

WHAT'S NEAT | 22

Bachmann USRA 4-6-2 set up and overview



23. This month, I was shooting Bachmann's new HO scale USRA 4-6-2 locomotive with the ash pit scene you saw me build in the September "What's Neat" video. This is the photograph from that photo shoot. It was cloudy during the shoot so I kicked up the reds and yellows in Photoshop to give the photo some color. Camera settings were ISO 100, f/stop 22 with a 22mm lens, and a half-second exposure.





24. In the video, we take the model inside and set up the sound decoder's DCC quartering of the drivers and the delay or momentum to enhance the performance of the model. To match sound to the quartering of the drive wheels, we use CV 116. Through trial and error, I eventually found that programming CV 116 to 73 synchronized the wheels perfectly with four chuffs per revolution of the main driving wheels.

Then came setting up smooth, slow starts and stops. To do this I set CV 3 and CV 4 to about 50. I like to set this momentum between 50 to 75 in all my DCC models as they perform more smoothly when starting and stopping, delaying the time it takes for the locomotive to change the speed or stop and start the model when the throttle knob is turned.



[Click here to rate or comment on this article](#)

AMERICA'S LARGEST OPERATING MODEL RAILROAD SHOW

4 FOOTBALL FIELDS OF SERIOUS TRAIN ENTHUSIAST FUN

TRAIN FUN FOR EVERY GAUGE OF RAILFAN

- 70 Detailed Operating Railroads
- 56 "How to" Clinics
- 75 Demos
- 60 Manufacturers – All the Majors & Cottage Industries too
- 50 Hobby Dealers
- 12 Train Historical Societies
- **NEW** "All Rail" Photo Contest

MODELER'S DELIGHT

EXPERT MODELERS HOST 56 **FREE** CLINICS

A wide range of clinic topics will challenge every modeler skill level. Clinics are free with admission and held daily during Trainfest. Space is limited; register today at trainfest.com.

NEW PRODUCTS UNVEILED

If a manufacturer is making a new product, they announce it at Trainfest – the nation's premiere train show. Make sure to visit all the manufacturers to see this year's new and exciting products and skills.

New!
**1/2-PRICE
TICKETS**

NOW THROUGH 7/30/17
AT TRAINFEST.COM

USE PROMO CODE

mrh2017

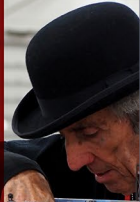

Trainfest

SATURDAY & SUNDAY • NOV. 11 - 12, 2017

9AM - 5PM • MILWAUKEE • WI STATE FAIR PARK

**RUN THE
TRAINS
ON MOST
LAYOUTS!**

Trainfest
America's Largest Operating Model Railroad Show

GREAT FAMILY EVENT OF HUGE OPERATING RAILROADS, PLUS...

- Kid-Friendly Activities
- Kids-Only Make 'n Take
- Clinics & Demos to Get Started in Modeling
- Become a Jr. Engineer
- Ride the MLES Train on 600 ft. of track

CELEBRATE THE SOO LINE

Trainfest is partnering with the Soo Line Historical Assn. to celebrate the Soo Line. We've created a spectacular 32-panel display on the railroad. Manufacturers will have Soo Line merchandise and layouts will be running the Soo. A limited-edition Soo Rolling Stock Freight Car is offered through trainfest.com. Reserve yours today to pick up at Trainfest.



Sponsored by the
WISE Div of the
National Model
Railroad Association

SHOW DETAILS, DISCOUNT TICKETS & LODGING DEALS AT TRAINFEST.COM

• INDEX



SUBSCRIBE
(free)

• TABLE OF CONTENTS

WHAT'S NEAT | 24

Jason Quinn's coal train modeling





25-27. (Left top and bottom, and above) Jason Quinn came by to share his 1980s-era C&O coal train and the philosophy behind placing various types of weathered cars into the consist. While it is well known that you can spend countless hours weathering one or two freight cars with very realistic results, Jason states that most folks simply do not have the time to dedicate to such a precise weathering process. He suggests mixing in three or four super-detailed cars at the beginning and the end of the consist. Give the other cars generic weathering with streaks and smudges using artists pastel colors tending towards the browns, yellows, and grays. Jason says Mike Confalone and his video weathering series on freight cars made him the modeler and weathering artist that he is today. He also mentions that his coal cars in this train are swap meet finds. He did not spend more than \$15 dollars on any given freight car in the consist and there is quite a rag-tag mixture of coal cars from 30-footers to 50-footers in this train, just like the prototype. This so-called “budget modeling” enhanced with great weathering saves money and inspires him in his modeling efforts.



WHAT'S NEAT | 26

Richard Rands' On30 layout



WHAT'S NEAT | 27

28-32. (Left, top and bottom, and on the following pages) In this month's video, we also look at Richard Rands' beautiful On30 layout. It is called the Mineral & South Fork Railway. Rich said that he converted his father's HOn3 layout into what has become his On30 empire. He built magnificent mountains climbing 10 feet from the floor to the ceiling in the layout room. Because the mountains take up so much space, Richard built pop-up and lift-out sections to gain access for maintenance and structure and bridge placement. The mainline snakes its way through the mountains, passing numerous towns and mines. It crosses almost a dozen scratchbuilt bridges. The longest bridge is five feet across. His trestle is a scale 250-foot long and about 150 scale feet tall, all scratchbuilt from scale boards, bent by bent. Most of the buildings in the mining towns are scratchbuilt from plans he designed on his computer. Many of his locomotives and rolling stock are from Bachmann, who have produced a large array of On30 products in the past 18 years. The models run smoothly with full sound as they travel his mainline of many scale miles. It was a real treat to lose myself in the wonderful scenery of the Mineral & South Fork Railway..

See more photos on the following page ...



**Click here to rate or
comment on this article**



WHAT'S NEAT | 28

Richard Rands' On30 layout *continued* ...





ADVERTISEMENT

Get the latest Model Railroading News, Tips, Reviews & Opinions



Our iTunes feed has changed search for "Mike And Scotty Live" to receive the latest episodes!

www.themodelrailroadpodcast.com

Hosts:

Scott Mason: www.scottymason.com

Mike Rose: www.mrhobby.com

Don't Miss our Monthly Interviews
& Product Announcements

• INDEX



SUBSCRIBE
(free)

• TABLE OF CONTENTS

Tsunami2 HEP sound feature



33. George Bogatiuk from Soundtraxx stops by this month to share the process of using the Tsunami2 diesel decoder's Head End Power (HEP) feature. To supply electricity to passenger cars, the locomotive's prime mover runs all the time, in notch 6 for the GE P42 and notch 8 in the EMD F40. With this decoder, you can enable this feature in your passenger diesel by pressing Function key 16 on your 28-function throttle.

Usually when multiple locomotives are in a consist, the engineer will activate the HEP in the locomotive closest to the passenger cars. The unit carrying the engine crew will not be set in the higher RPM range. The noise from the HEP generator can get pretty loud, especially at station stops. ✓



[Click here to rate or comment on this article](#)

WHAT'S NEW on TMTV!

Non-members: Watch episodes for \$1.49; become a member for unlimited access



TOMA project layout: structures



Run like a Dream: Rolling stock

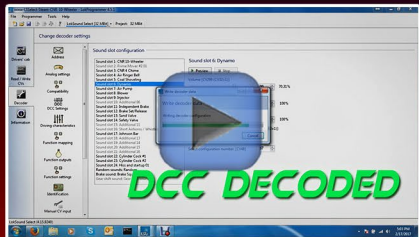

LokSound decoder function mapping



Proper freight car lettering & data



TRAINMASTERS.TV



• INDEX



SUBSCRIBE
(free)

• TABLE OF CONTENTS



MRH MARKETPLACE

MAIN STREET AMERICA HISTORIC ARCHITECTURE



MAIN STREET HERITAGE

www.mainstreet-heritage.com

CLICK
HERE
for all
our HO
& O kits

Imagine That!
Laser Art Products

ITLA Scale Models



*Olympia Tool & Die
HO Scale Laser Cut Wood Kit*

CLICK HERE FOR MORE INFORMATION
www.itlascalmodels.com

CROW RIVER PRODUCTS

HO Kits 214 Stiff Leg Derrick \$ 60.00
& Kit 215 Hoisting Shed \$ 55.00 (sold Separately)
The shed is cast resin & the derrick is wood brass and cast metal.
All Items made in USA



HO & O Scale Machinery, Derricks,
Engines, Hardware & Waterfront Models
Pawtucket, RI 02861 Tel 401-723-0065
www.crowriverproducts.com

We Accept Visa, Master Card, Discover or PayPal



TAM Industries

"Preserving the Romance"

The highest quality in Display Cases for sharing your excitement of Model Railroading. We manufacture Display Cases for all gauges of Model Railroading, from "G" to "N". Custom Sizes are available for some styles. Visit us today at:



www.TAM-IndustriesOnline.com

MRH MARKETPLACE | 2

Your ad could be in
this space for as low
as \$28 a month.

Click to learn more ...

LOOK
at what's new at
Black Cat this month

Click here for
our website

CPR Pre WW1
Box car - White
lettering



Black Cat Publishing
(204)489-5005
ajfergus@mymts.net
blackcatdecals.com



GOODDEALSDCC

WWW.GOODDEALSDCC.COM



HOME OF THE

PROGRAMMER TEST TRACK SYSTEMS

GARY COHN

GARY@GOODDEALSDCC.COM

THE DCC SHOP

YOUR COMMAND CONTROL SPECIALISTS

WWW.DCCSHOP.COM



Quantity Pricing for
the Layout Builder



HO Brass



Start your model railroad
empire on the right track
with **THE DCC SHOP**

The Little Train Store that is **BIG** on Customer Service!

WWW.DCCSHOP.COM

ph. 208-889-9111

Where the Rail Meets the Sea...



CRAFTSMAN KITS & BUILT-UPS
HO - O - N Scale



H141-HO 77' Converted Menhaden Steamer Kit
www.seaportmodelworks.com

Click here for our website:



Affordable built to order Benchwork
starting at only \$20 a Sq Ft.



GREAT LOOKING
TREES
MAKE ALL THE
DIFFERENCE

CANYON CREEK
SCENICS

• INDEX



SUBSCRIBE
(free)

• TABLE OF CONTENTS

W GOLDEN AGE LINE
WESTERFIELD
 MODELS, LLC

New One Piece Body Kits:
 USRA STEEL AUTO BOX
 #3000 Series: MC, NYC



westerfieldmodels.com

clever models LLC
 Cardstock models & materials



Try one today!

www.clevermodels.net

MODEL RAILROAD
BenchWork.com



Affordable Modular (domino)
 Benchwork in 200+ sizes
 Custom built to order benchwork also available!



Trees



coastmans.com HO

Yarmouth Model Works
 HO scale resin kits and detail parts



..... U.S.A. MAILING ADDRESS
 2014 Holland Ave Unit 617
 Port Huron, MI 48060

Tel. 519-633-7574
 pierre.oliver@elgincarshops.com

..... CANADIAN MAILING ADDRESS
 263 Sunset Dr.
 St. Thomas, ON N5R 3C4
 www.yarmouthmodelworks.com

LOGIC RAIL™
 TECHNOLOGIES

"Sophisticated
 Model Railroad
 Electronics"



Please visit our website and online store!

21175 Tomball Pkwy Phone: (281)251-5813
 Suite 287 http://www.logicrailtech.com
 Houston, TX 77070 info@logicrailtech.com

PRE-SIZE
 MODEL SPECIALTIES

P.O. Box 6 Paonia, CO 81428
 Ph. 970 527 4586
 Made in The USA

Cast resin items for All Scales.
 Tunnel portals, bridge piers, abutments,
 culverts, and retaining walls.
 Trackside details and sage brush tree
 armatures.

"FREE SHIPPING see website for details"

UNIQUE STRUCTURES **NEW**



click here to

Browse NOW >>

**banta
modelworks**

Great Decals!™

FEC, Interstate, Virginian
Railway, & L&N Titles
After Hours Graphics Line
Coupler Gages and More
In O, S, HO, and N Scales

HO DIESEL SUPPLY

CUSTOM SOUND LOCO'S-REPAIRS-UPGRADES
Weathered New and Rebuilt Locomotives
Powered Chassis-Trucks-Motors-Handrails-Electronics
Parts Inventory Always Changing
www.hodieselsupply.com
email:gerry@hodieselsupply.com

MOUNTAIN SUBDIVISION HOBBIES

www.modelrrsupply.com

FREE USA SHIPPING OVER \$29.00

NCE - SOUNDTRAXX - DIGITRAX - PECO - CIRCUITRON
DCC SPECIALTIES - INTERMOUNTAIN - CMX - ATLAS
BAR MILLS - BOWSER - KATO - MRC - TOMAR - RIX -
PIKESTUFF - LOGICRAIL - CENTRAL VALLEY AND MORE!

Model Railroad Control Systems

Geoff Bunza Project Boards
DCC Occupancy Detectors
CMRInet Compatible Nodes
Layout Telephone Systems
RFID Switchlist Generator
Switch Machines and Drivers

[Click Here](#)

RULERS-of-the-WORLD

Scale Rulers \$4 each

Over 200+ scales!

Metric or Imperial

www.rulers-of-the-world.com

**HOBBY
MARKETPLACE
ads are
economical and
effective.**

Click [HERE](#) to learn more.

PRECISION DESIGN CO.

LASERCUT KITS - CUSTOM DECALS

PDC.CA

Authorized **RailPro** Dealer

FREE SHIPPING in the US and CANADA



Deploying Potash Cars on the Letellier Sub



***Start to finish: Tuning up wheelsets,
couplers and weight for optimum
performance, and creating paperwork
for operation ...***

• [INDEX](#)

• [TABLE OF CONTENTS](#)



• [INDEX](#)



• [SUBSCRIBE](#)
(free)

• [TABLE OF CONTENTS](#)

BY WILLIAM J.A. BRILLINGER
PHOTOS BY THE AUTHOR



[Click here to rate or comment on this article](#)

POTASH CARS ARE STANDARD FARE ON THE Canadian Prairie and in the US Midwest. Along the main lines of class 1 railroads they are often seen in unending unit trains and long consists. On lesser traveled tracks it's a different story. My modeling revolves around Canadian National's Letellier Sub in southern Manitoba between 2012 and 2014.

The Letellier is an old Northern Pacific line that is still part of the Burlington Northern Manitoba Line, or BNML. It's a busy little secondary interchange between Canadian National in Winnipeg, Canada, and BNSF in Noyes, MN.

On this line, the ubiquitous monster potash train is reduced to short strings of 5, 10, or maybe 20 cars – sometimes only 2!

**Use our custom
Google search on the
MRH website to find
topics of interest**

[CLICK TO FIND OUT MORE](#)

POTASH CARS ON THE LETELLIER | 4

– mingled into mixed freights winding their way north and south across the border. Other than beat-up old cylindrical hoppers, the most common type of potash car seen around here is the NSC 3-bay potash service hopper. Fortunately for me, Pacific Western



1-2. Typical example of the NSC three-bay potash hopper, in NAHX and Agrium paint, seen in Emerson, Manitoba.



Rail Service brought HO models of the NSC hoppers to market beginning in December 2015. PWRS also offers an N scale version of these cars. Check out the whole potash car line-up from PWRS at pwrs.ca/main.php.

About the prototype

The NSC potash service 4275 cu. ft. three-bay covered hopper was introduced by National Steel Car in 1999 to address the need for greater capacity in the potash transportation market. Thanks to some internal modifications, a later version was designated as 4300 cu. ft. capacity. The NSC hopper operates at today's maximum gross limit of 286,000 pounds; however they are designed to handle up to 315,000 pounds by simply upgrading to 125 ton trucks. These cars can be found all over North America in PotashCorp, Canpotex, and Agrium colours.

Recently I stumbled across a fantastic PotashCorp video on YouTube that showcases these cars nicely while giving the viewer a quick tour of the new PotashCorp Hammond Facility ([youtube.com/watch?v=z4JnGFLe1E4](https://www.youtube.com/watch?v=z4JnGFLe1E4)).

About the models

HO scale models of the NSC potash hopper are manufactured under the North American Railcar Corporation name and are available exclusively from PWRS. There are five distinct variations of the car available in 12 different paint schemes. They are sold in six-car sets with a retail price of US \$264 per set. In addition to the sets, there are four unique cars available as singles with a retail price of just under \$45 each. The single cars are: the Canpotex 2015 NMRA Convention car, a fantasy design for the Great River Valley System RR Club, a special NSC 5000th car design, and a

POTASH CARS ON THE LETELLIER | 6

PotashCorp car tagged with “Always Makin Fast Money.” The “NSC 5000th car” model and the “Fast Money” model are only available only through the PWRS Club Lounge loyalty program.



3-4. Light pink cars sit among their deep salmon sisters in Carman, Manitoba.



POTASH CARS ON THE LETELLIER | 7

Each of the primary schemes is available in numerous subsets making an astounding total of 160 car numbers available right off the shelf. *[THIS JUST IN: PWRS has just announced four more versions of this car, making over 200 car numbers available in total!]*

Anyone who has seen these cars in service will notice that there seem to be two colors of green used on the Canpotex cars, and two colors of red (pink!) used on the PotashCorp cars. Often thought to be a fading issue with the paint, the cars were actually delivered for service in these colors. Perhaps it is related to which shop painted them. In any case, PWRS has faithfully captured this nuance in their models.

In addition to the light and dark paint schemes, these models have clean crisp printing and a high degree of fidelity including; panel spacing variations, shape differences in the hopper bottoms, and accurate brake detail placement for the different versions. Each model also features separately applied brake hoses, photo-etched walkways, Kadee #58 couplers, and narrow tread semi-scale wheels.

Detailed pages on the PWRS website explain the variations between each car and exactly when each version and scheme was put in service.

Overall these cars are beautiful renditions of a unique prototype, well executed and ready to serve right out of the box. My only disappointment with them is the lack of opening hatches on the roof.

Procurement

As stated at the beginning of this story, these cars are seen in small cuts on the Letellier sub. I only need a few of them, certainly not more than six or seven. Ideally I wanted three Canpotex, two PostashCorp, and two Agrium cars. I called the vendor... They come in six-packs. Period.

POTASH CARS ON THE LETELLIER | 8



The PWRS NSC potash car in HO scale.



POTASH CARS ON THE LETELLIER | 9

OK, so that's a dilemma.

Once I wrapped my brain around the problem I did what any sane model railroader would do and ordered 3 complete sets.

In the end, I liked these cars enough that I decided to keep five Canpotex cars and five PotashCorp cars. The Agrium cars are still in production. When they arrive, I will keep three, giving the BNML a total of 13 NSC potash cars on the roster.

The excess cars have been easy to sell through various model railroad sales groups on Facebook.

Deployment on the BNML

Even though these cars are wonderful as delivered, like any new rolling stock they must go through a number of steps before



5. Potash hoppers lined up in staging, waiting for processing.

being deployed on the railroad. Each needs to be carefully checked for standards compliance, and paperwork needs to be created to support their movements in the miniature world.

Initial inspection

When the cars arrived, I checked them over, looking for damaged details and low-hanging hoses. Seeing no issues, I couldn't resist taking them for a short test run. It only took a moment to discover that my Peco code 100 turnouts don't like semi-scale narrow tread wheels. I took the cars off the layout and placed them on at my workbench.

On the RIP track

The first order of business on the RIP track was to change out the wheelsets. Working on a few cars at a time, I removed the trucks and popped out the PWRS wheelsets. I test-fit an InterMountain 36" replacement wheelset in one truck and found that the wheels fit correctly and roll freely in the PWRS truck. If the Intermountain wheels had not fit, I have a Reboxx sample set that I would have used to find the correct axle length.

With the InterMountain wheels good to go, I selected enough wheelsets for the project and checked the gauge of each before installing them. I reamed out each journal on each truck with my Micro-Mark Truck Tuner and installed the new wheels. Later I discovered that PWRS also offers wide tread replacement wheelsets for these models.

Up next: couplers! There is nothing wrong with the couplers provided on the PWRS cars, but on my BNML I have standardized on Kadee's traditional, standard-sized couplers with the trip pins removed. With the trucks out of the way, now is a good time to change out the couplers.



POTASH CARS ON THE LETELLIER | 11

For these models I used Kadee #5 couplers. I prepare the #5s by cutting the trip pins off with a side cutter and use a Dremel cut-off wheel to clean up the remnants of the pins.

Using a small Philips screwdriver, I remove the screws that hold the coupler boxes together. Remove the Kadee #58 couplers and install the #5 couplers in their place. With the new couplers in, I reassemble the boxes and reinstall the trucks.

With the trucks back on, I re-check each wheelset for gauge. Use the slopes of the truck frame to rest the wheel gauge on to ensure the gauge is square to the wheelset. I also give each wheelset a turn while it is against the gauge to confirm that they are true. If the wheels are out of true (not square) they will bind as you turn them.



6. Reboxx sample set, Truck Tuner, and InterMountain wheelsets.

POTASH CARS ON THE LETELLIER | 12

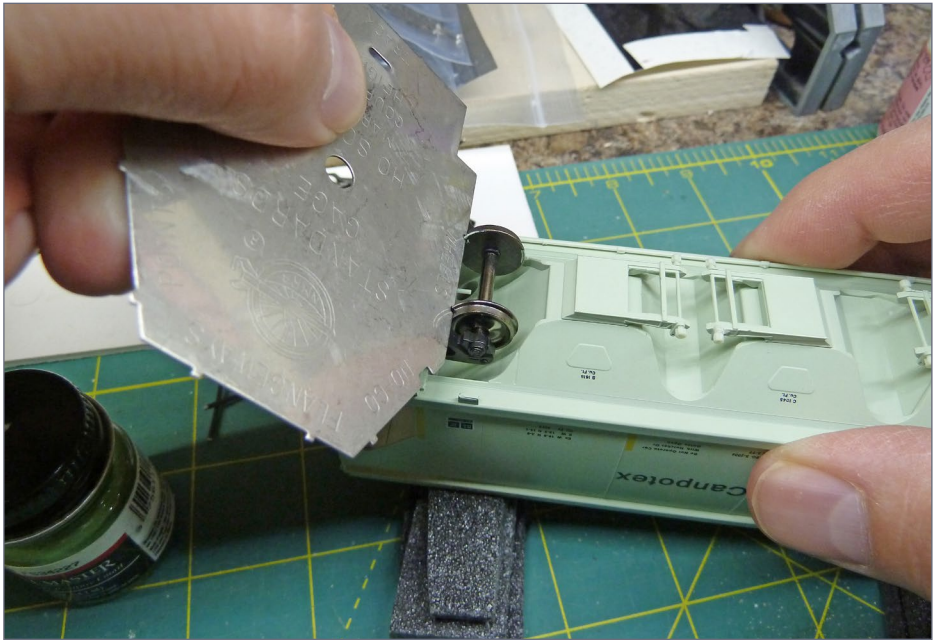

7-8. Checking the wheel gauge.

POTASH CARS ON THE LETELLIER | 13

The next step is to check the cars for coupler alignment. Using my Kadee Coupler Height Gauge (kadee.com/htmbord/height.htm), I check the couplers at each end of each car. No adjustments were needed. Yay!

Weight standards and super-weighting

I admit it. I'm a super-weighter. I always knew that HO rolling stock ran better with a little more weight than the NMRA recommends, but after listening to the Mike Confalone interviews on TMTV (trainmasters.tv/videos/allagash-story-interview-mike-confalone) and his experience with adding LOTS more weight, I was intrigued. Mike posits that not only do super-weighted cars track better; they behave more like real freight cars. The laws of physics acting upon

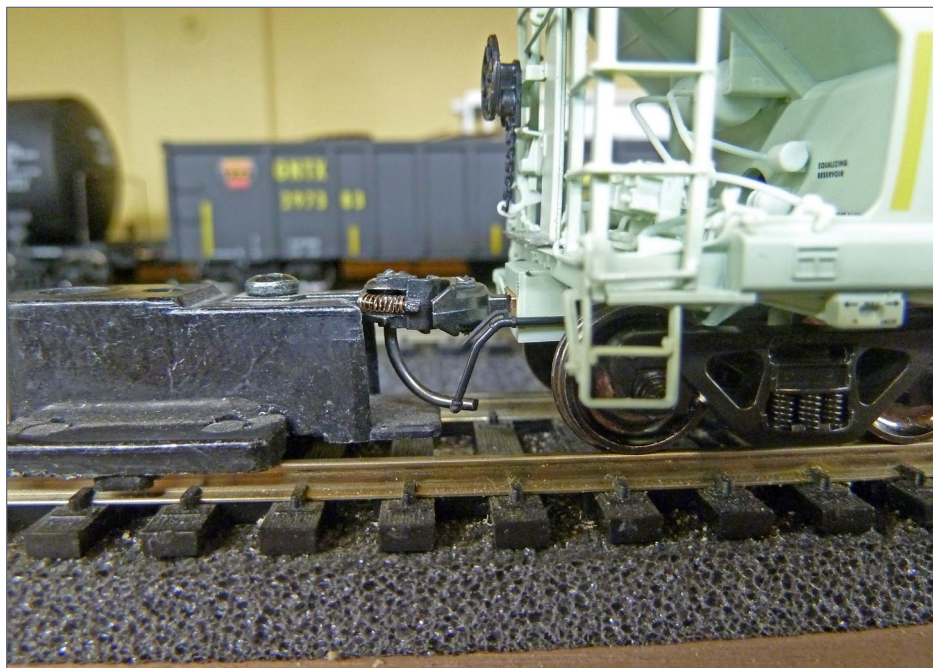

9. Checking coupler height.

POTASH CARS ON THE LETELLIER | 14

super-weighted rolling stock cause them to move, or not move, just like the real thing. Inertia becomes a barrier to be overcome. Super-weighted cars do not jitter when in motion or run away when coupling. In Mike's words: "If you want to really simulate tonnage, you have to add weight, and lots of it." (mrhmag.com/node/15331?page=4#comment-118751) And he is right!

The NMRA recommends weighting HO cars at 1 oz. plus ½ oz. per inch. I super-weight my cars to a minimum 7 oz. Or 1 oz. per inch; whichever is greater. This is less weight than Mike uses, but it is enough to experience the effects he describes.

As delivered, the PWRS potash hoppers weigh 4.8 oz. Given their length of 6 inches, these cars are already 20% over the NMRA-recommended weight of 4 oz. My goal will be to bring these cars up to 7 oz.



10. Weight as delivered: 4.8 oz.

POTASH CARS ON THE LETELLIER | 15

Some cars are easier to get into than others. These cars definitely fall into the difficult category. Why, oh why don't the hatches open on these?! Does the roof come off easily? Nope. Hmmm, there are no other openings in the car body either. With no easy access in sight, sand would be the ballast of choice.

The obvious insertion point to me was the flat spot between bays on the underside of the cars. I got out my drill and promptly discovered the metal car weight was in the way. Exploratory surgery was going to be required. I placed a styrene Band-Aid over the hole I had drilled and pondered my next move. In the absence of X-ray vision I decided to take another stab in the dark, this time with a smaller drill bit. The interior end slope looked like a good choice, so I removed the truck at that end of the car and tried again. Success!

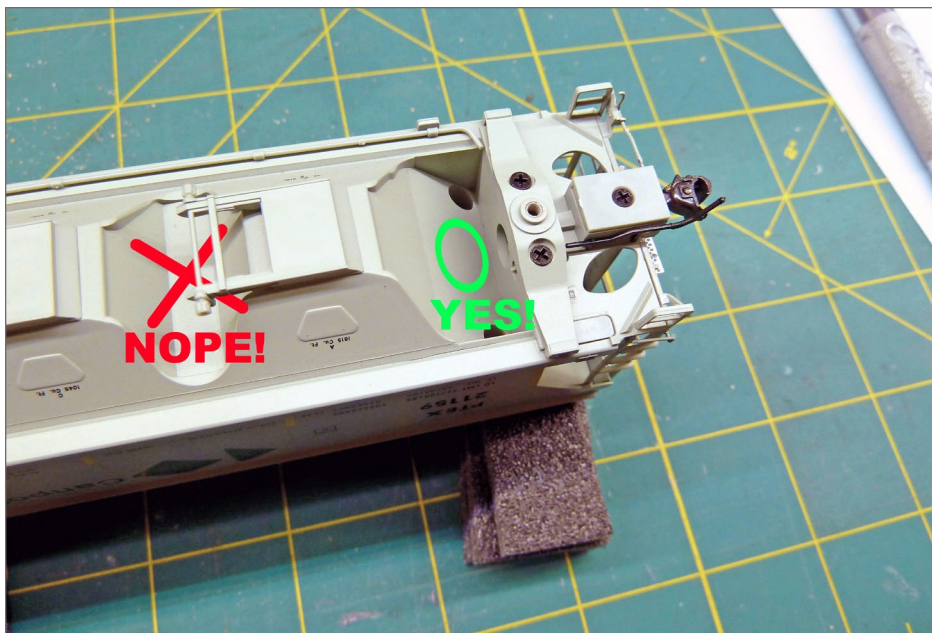

11. Possible entry points for adding weight.

POTASH CARS ON THE LETELLIER | 16

I lined up the rest of my victims and pulled the trucks off of one end of each.

The hole in the end slope would need to be large enough for me to insert the end of my small funnel. 15/64ths would do. Drilling on an angle is challenging at best, so in the interest of protecting the rest of the car from the drill bit, I decided to create a jig from a small piece of plywood.

To make the jig, I put it in place on the slope and marked the center where the hole should be. I removed the jig piece from the model and drilled a 15/64ths hole through the plywood. Once the hole was through, I picked up the piece and tilted it as the drill turned, to angle the opening.

Using the jig, and with my drill running at low speed, I was able to safely drill openings in the sloped ends of the cars.

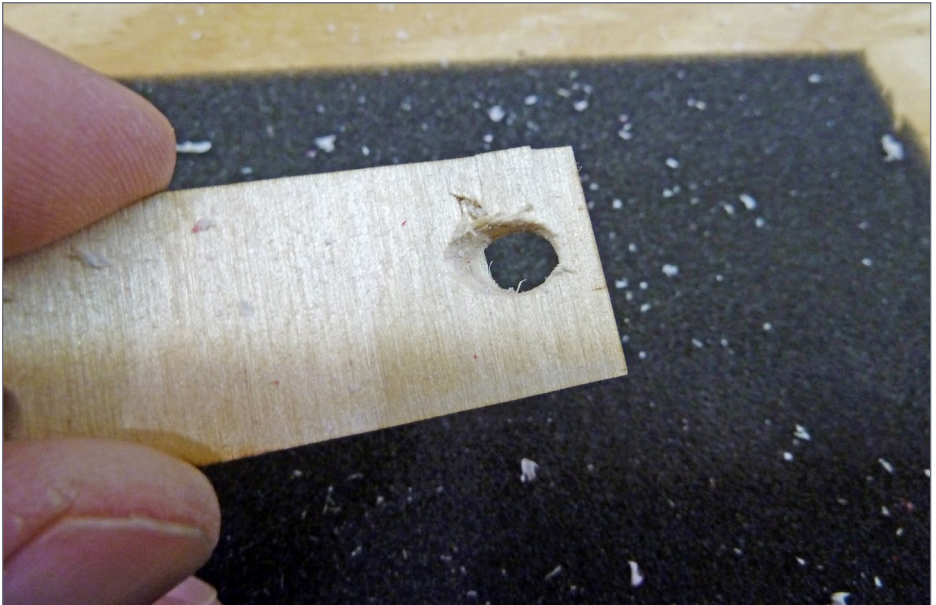

12. Sloped drilling jig made from 1/8" plywood.



13. Drilling the openings.



14. Cleaning up the openings with a chisel blade.

POTASH CARS ON THE LETELLIER | 18

I used a sharp chisel blade in my X-acto knife to clean up the openings and then prepared to add sand to the cars – 2.2 oz. of very dry sandbox sand per car. If you pour it slowly enough, you can keep the funnel from becoming clogged and save a lot of frustration. By the second car I was getting good at this.

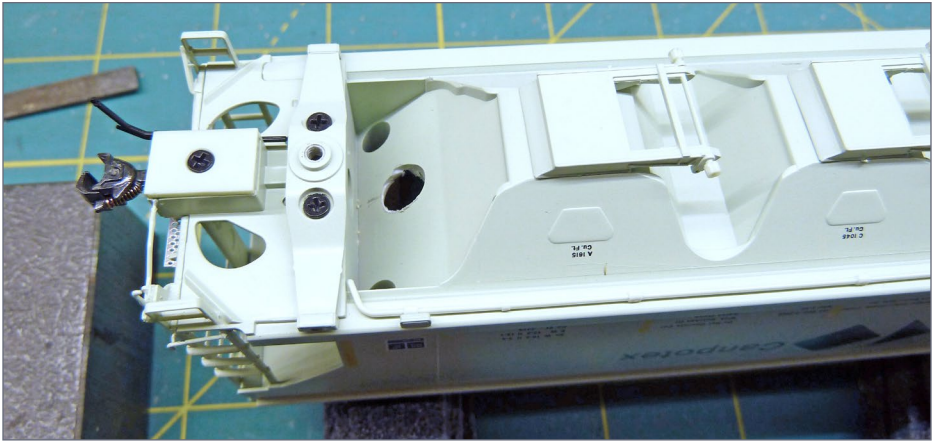

15. Ready for sand.



16. Tip: Zero the scale with the container on it and then add the sand to be weighed.



17. Pouring the sand slowly on the slope of the funnel prevents the funnel from clogging.

With the sand loaded into the cars, I was ready to close them up. I used small squares of .010" styrene to make cover plates. I glue them into place using a drop of MEK, then paint the plates with cheap craft paints. The color didn't need to match perfectly since this part of the car is in shadow all the time and usually hidden from view. I mixed two different greens together to come close to the color on the Canpotex cars. Antique Rose is a decent match for the PotashCorp cars.

After reinstalling the trucks, the cars are ready for a reweigh! They all came in at 7 oz. on the nose.

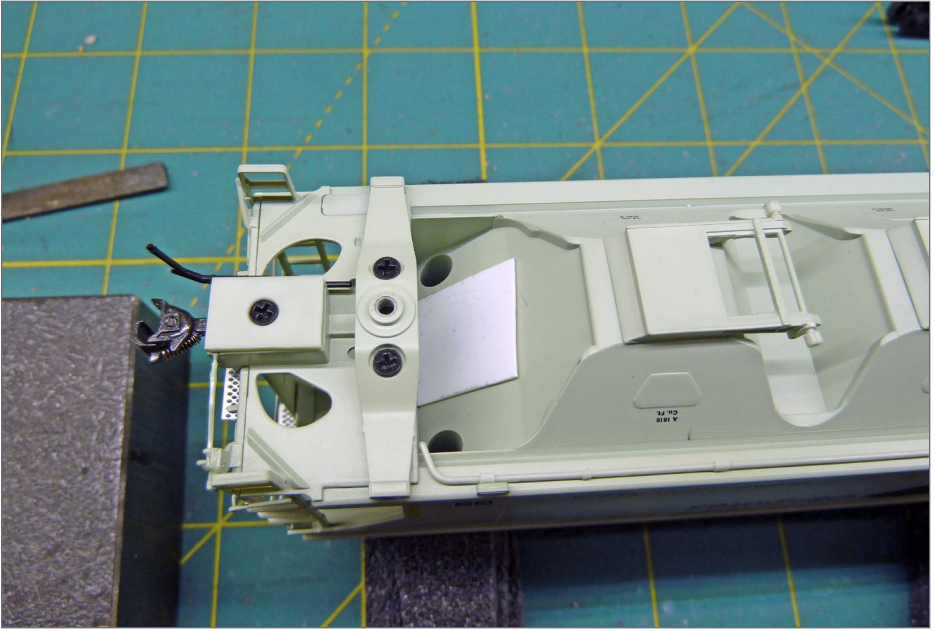

18. The holes are covered with .010" styrene patches.



19. Use craft paint to cover the patches.

POTASH CARS ON THE LETELLIER | 21

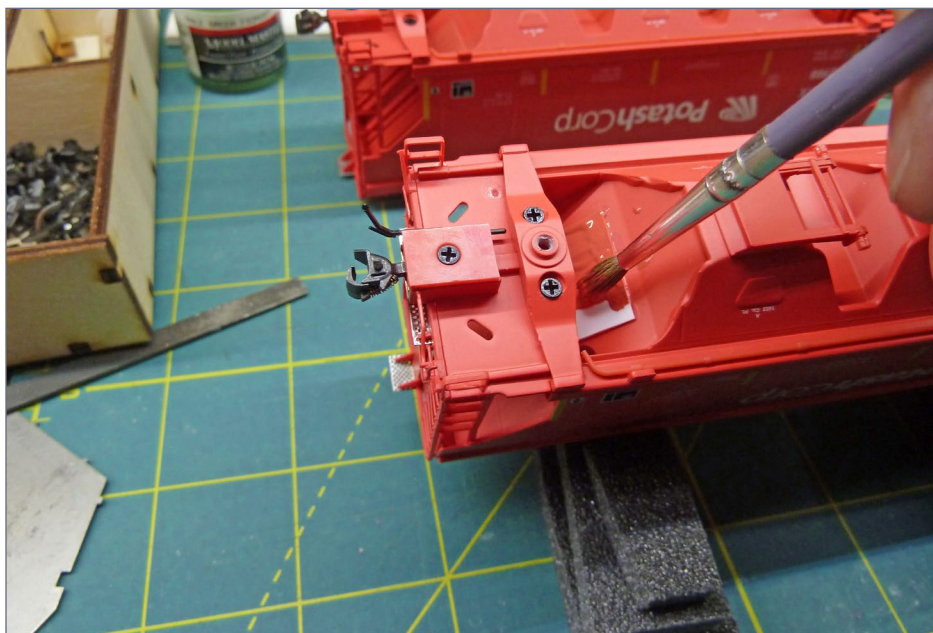

20. Antique Rose is a perfect match.

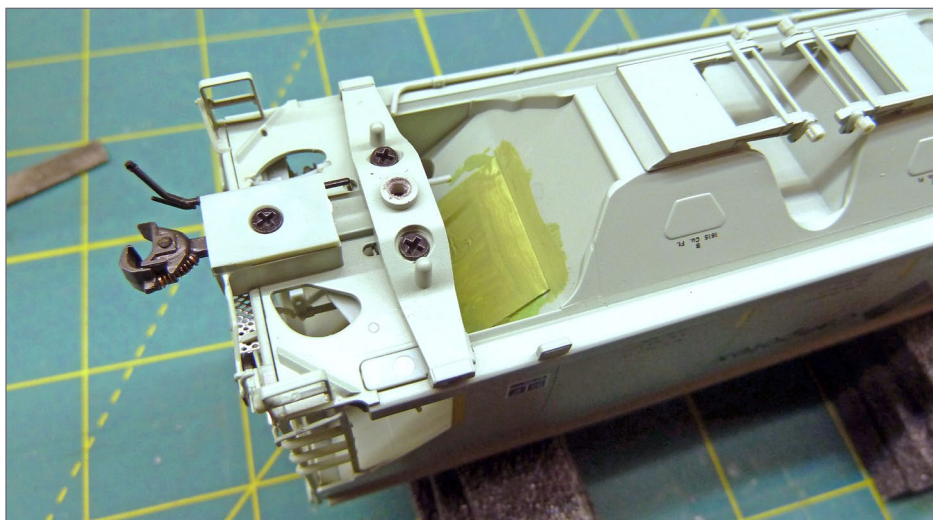

21. The Canpotex green? Not so much, but you can't see the patch when the car is upright.

POTASH CARS ON THE LETELLIER | 22



22. Putting the trucks back on.



23. Reweigh: 7 oz. on the nose.



POTASH CARS ON THE LETELLIER | 23



24. With the set-up tasks complete, the cars are ready to roll.



25. The crew has moved the cars to the office track.

With that work completed, our string of new cars sit queued up in staging, waiting for paperwork. They still need weathering but that will wait for another day.

Paperwork

The crew relocated the new cars to the office track in preparation for creating paperwork. The office track is actually “Staging in Plain Sight” at the southern end of the layout, in St Vincent, on the BNSF. This track is conveniently located right above the computer in my office. Coincidence? I think not!

BNML car cards overview

I use a home-brew car card system for traffic forwarding that includes blocking codes based on the TIBS concept as originally published in *Model Railroader* in July 1997 and February 2012. Basically, the waybill includes a special blocking code to make it easy to block your train properly.

Read about my system in these two posts on the MRH Forums: Blocking the BNML (mrhmag.com/node/17976) & Paperwork on the BNML (mrhmag.com/node/18272).

Here's what the car cards and waybills look like:



**Click here to rate or
comment on this article**



POTASH CARS ON THE LETELLIER | 25

Owner/Lessor Marks	
Reporting Marks	Colour
PotashCorp	AAR Code
POTX 2988	Red LO
48 FT 115 TONS	Covered Hopper
Length over couplers	Capacity in Tons
Car Type	
EMPTY CAR - HOME ROUTING	
TO	Saskatoon, SK — Home
VIA	CN Symington
BLOCK TO	G30 — Route VIA
Home Routing Block Code	
Applicable Load Types	
Potash	
Applicable load types	

26. BNML's TIBS based car cards.

FREIGHT WAYBILL	
TO	CHS, Grand Forks ND
FROM	Mosaic Belle Plaine Mine, Moose Jaw SK
VIA	CN Symington — Last yarded in
FILE	ITW39 — Waybill file number
Lading	Granular Potash
LO	AAR Code
Special Instructions	Loaded with
HAZMAT info	NON-HAZ
BLOCK TO	Q10

27. The waybills slip into the pouch over the lower portion of the car card.

Populating the car cards

The first order of business on the office track is to gather up the data to fill in the car cards.

Although the cars all look basically the same, they are not, and the data on the car sides supports this. I use an inexpensive magnifying glass to make it easy to read the car data on each car, entering the reporting marks and capacity (LD LMT) in the car control file as I go.

The capacity on the cars is written in pounds and the car control file is not. Since I don't like thinking too hard, I use Google's handy conversion tools to recalculate the capacity in tons. To get



28. A magnifying glass makes reading car data from my desk simple.

to the conversion tool you want, simply enter the conversion into Google's search box, for example: 227200 LBS in TONS ([google.ca/search?q=227200+LBS+in+TONS](https://www.google.ca/search?q=227200+LBS+in+TONS)) and Google instantly tells us this is 113.6 US tons. I'll round this down to 113 in the data for simplicity.

For the Length Over Couplers field, I grab my trusty scale rule and eyeball it. Next up, I do another Google search to find the address (we only need the city) of the head office of the car owner. In the case of both PotashCorp and Canpotex, it's Saskatoon, Saskatchewan.

I fill in the rest of the fields with appropriate data and assign a Matching VIA and Blocking Code from my code list for Home Routing. Once I have repeated this for all of the cars, I print and cut my car cards.

Populating the waybills

With the basic car cards finished, it's time to generate some car orders. A little research will be required to create the appropriate waybills.

Finding shippers

Our cars are labeled for Canpotex and PotashCorp. Since Canpotex manages all exports of potash from Saskatchewan, and is owned by its member companies – PotashCorp, Mosaic, and Agrium – I will create waybills that originate at PotashCorp, Mosaic, and Agrium properties only.

Using the List of Mines in Saskatchewan page on Wikipedia ([Wikipedia/wiki/List of mines in Saskatchewan](https://en.wikipedia/wiki/List_of_mines_in_Saskatchewan)) I started building waybills. Tables on Wikipedia pages can be sorted by clicking on the headers in the top row.

POTASH CARS ON THE LETELLIER | 28

I sorted the mine list table by clicking on “major commodities.” Looking at the grouping for potash, I chose the Belle Plaine, Patience Lake, Rocanville, Bienfait, and Vanscoy Mines as potential shippers.

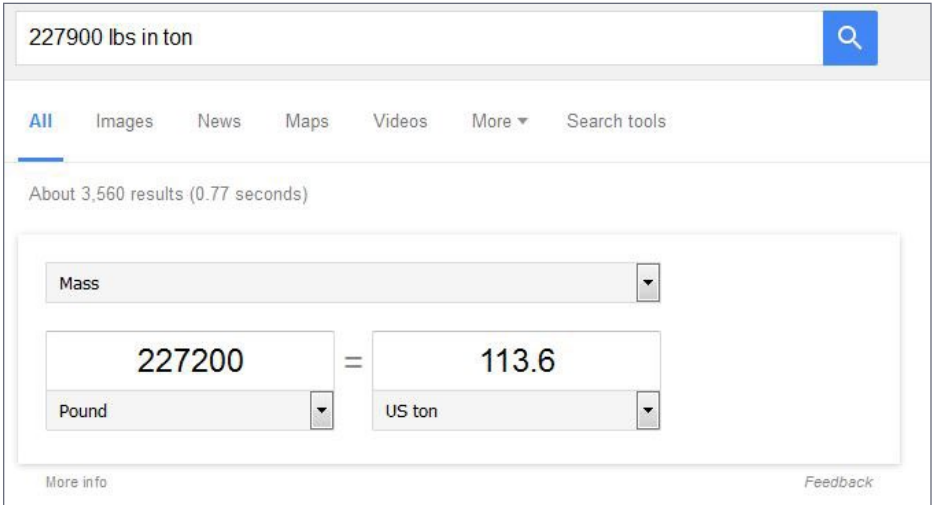

29. I use Google to convert weight data.

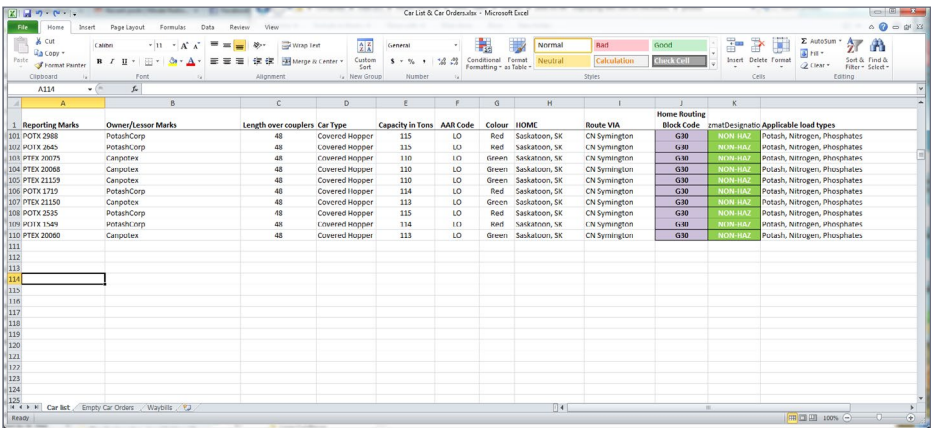

30. Car control data is managed in Microsoft Excel.



List of mines in Saskatchewan

From Wikipedia, the free encyclopedia

This list is incomplete; you can help by expanding it.

This is a **list of mines in Saskatchewan**, Canada. Operational mines are in **bold**.

Mine	Major commodities	Coordinates	Associated town	Owner
Wilcox Bentonite	Bentonite		Wilcox	Canadian Clay Products, Inc.
Old Post Kaolin	Kaolinite			Whitemud Resources Inc.
Bienfait Lignite	Lignite		Bienfait	Prairie Mines & Royalty Ltd.
Boundary Dam	Lignite		Estevan	Prairie Mines & Royalty Ltd.
Poplar River	Lignite		Coronach	Prairie Mines & Royalty Ltd.
Allan	Potash	51°55′51.9″N 106°4′18.2″W﻿ / ﻿51.931111°N 106.071722°W﻿ / 51.931111; -106.071722	Allan	PotashCorp
Belle Plaine	Potash	50°25′47.2″N 105°12′6.9″W﻿ / ﻿50.429778°N 105.202750°W﻿ / 50.429778; -105.202750	Moose Jaw	The Mosaic Company
Bienfait	Potash		Regina	The Mosaic Company
Colonsay	Potash	51°56′1.2″N 105°45′50.2″W﻿ / ﻿51.933944°N 105.764222°W﻿ / 51.933944; -105.764222	Colonsay	The Mosaic Company
Cory	Potash	52°05′26.2″N 106°51′10.4″W﻿ / ﻿52.090611°N 106.852889°W﻿ / 52.090611; -106.852889	Saskatoon	PotashCorp
Esterhazy	Potash		Esterhazy	The Mosaic Company
Lanigan	Potash	51°51′17″N 105°12′34.6″W﻿ / ﻿51.854722°N 105.209611°W﻿ / 51.854722; -105.209611	Lanigan	PotashCorp
Legacy	Potash	50°37′47.6″N 105°24′5.4″W﻿ / ﻿50.629889°N 105.401222°W﻿ / 50.629889; -105.401222	Moose Jaw	K+S Potash Canada
Patience Lake	Potash	52°5′20.3″N 106°22′38.4″W﻿ / ﻿52.089000°N 106.376000°W﻿ / 52.089000; -106.376000	Saskatoon	PotashCorp
Rocanville	Potash Salt	50°28′18.7″N 101°32′38.7″W﻿ / ﻿50.471861°N 101.543806°W﻿ / 50.471861; -101.543806	Rocanville	PotashCorp
Vanscoy	Potash Salt	52°00′26.9″N 107°05′34.5″W﻿ / ﻿52.007472°N 107.093194°W﻿ / 52.007472; -107.093194	Vanscoy	Agrium

31. The Wikipedia is full of useful information.

The “Lading” column

Up next, let’s fill in the Lading column. Looking at the Potash article (en.wikipedia.org/wiki/Potash) on Wikipedia we can see that “Potash” isn’t very specific. I have a decision to make. Will I

POTASH CARS ON THE LETELLIER | 30

get fancy and use one of the scientific names, or go generic and use “granular potash” as the lading? Let’s explore the specifics of each mine and see what we get.

Common name	Chemical name	Formula
Potash fertilizer	c.1942 potassium carbonate (K_2CO_3); c.1950 any one or more of potassium chloride (KCl), potassium sulfate (K_2SO_4) or potassium nitrate (KNO_3). ^{[9][10]} Does <i>not</i> contain potassium oxide (K_2O), which plants do not take up. ^[11] However, the amount of potassium is often reported as K_2O equivalent (that is, how much it would be if in K_2O form), to allow apples-to-apples comparison between different fertilizers using different types of potash.	
Caustic potash or potash lye	potassium hydroxide	KOH
Carbonate of potash, salts of tartar, or pearlash	potassium carbonate	K_2CO_3
Chlorate of potash	potassium chlorate	$KClO_3$
Muriate of potash	potassium chloride	KCl:NaCl (95:5 or higher) ^[11]
Nitrate of potash or saltpeter	potassium nitrate	KNO_3
Sulfate of potash	potassium sulfate	K_2SO_4
Permanganate of potash	potassium permanganate	$KMnO_4$

32. Researching potash in more detail.

The screenshot shows a Google search for "Belle Plaine Mine". The search results include a link to "Belle Plaine, Saskatchewan - Mosaic" with a URL www.mosaicco.com. The snippet below the link reads: "Mosaic operates a potash solution mine in Belle Plaine, Saskatchewan. This mine produces Muriate of Potash (MOP), including Fine, Standard, Coarse, ...". The words "This mine produces Muriate of Potash (MOP)" are highlighted in yellow.

33. Googling mine-related information.



A quick search on Google for Belle Plaine Mine ([google.ca/search?q=Belle+Plaine+Mine](https://www.google.ca/search?q=Belle+Plaine+Mine)) tells us what we need to know; *This mine produces Muriate of Potash*. Referring back to the Potash article, we see that “Muriate of Potash” is “potassium chloride.” Here’s what I found for each mine:

Belle Plaine	Muriate of potash (potassium chloride)
Patience Lake	Muriate of potash (potassium chloride)
Rocanville	Muriate of potash (potassium chloride)
Bienfait	Can’t find any info!?! Coal?
Vanscoy	Can’t find specific details

From my research, it looks like Bienfait is a coal mine, listed incorrectly on the Wikipedia page and Agrium doesn’t provide much information about its Vanscoy location. So, decision made. Strike Bienfait off the list and go with the more generic term “Granular Potash” for the Lading field.

Receivers

On the layout, I have two locations that can receive potash cars: Chales Fertilizers, and the Morris Transload Track. Both of these locations serve as small potash distribution centers. All other destinations will be off layout via Grand Forks.

For the off-layout locations, I again turn to Google. Since we are dealing with small cuts of cars and not large strings, I assume that most of the cars traversing the BNML are destined for locations near Grand Forks. Otherwise, as stated in the PotashCorp video, most of the potash traffic goes through Chicago. Given this assumption, I looked on Google maps for Fertilizer facilities in North Dakota ([google.ca/maps/search/Fertilizer+north+dakota](https://www.google.ca/maps/search/Fertilizer+north+dakota)).

From the locations shown, I chose these candidates:

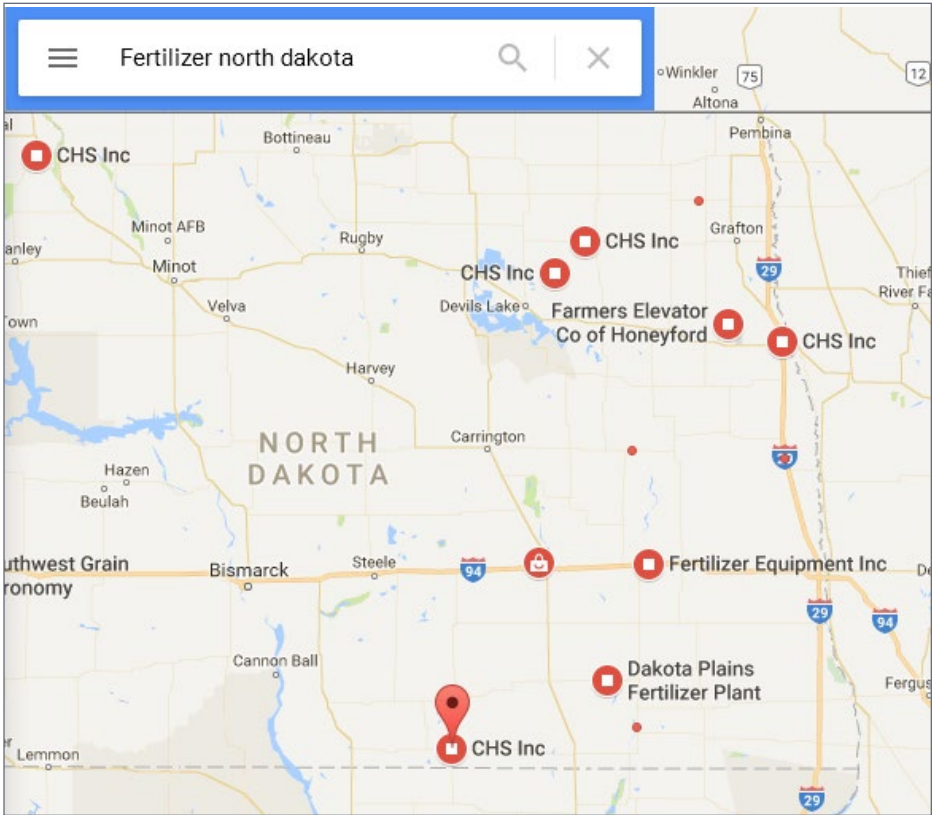

34. Fertilizer plants in North Dakota on Google Maps.

- Dakota Plains Fertilizer Plant, LaMoure ND
- Simplot, Grand Forks ND
- CHS, Grand Forks ND

For good measure, I added PotashCorp – Chicago to my list to simulate strays and misrouted traffic.

The remaining fields

The rest of the data for the waybills is fairly simple.

POTASH CARS ON THE LETELLIER | 33

VIA – This is the name of the yard the car is coming from. I use this field to group the cars in blocks in staging. Southbound trains appear on the layout in blocks representing lifts from several yards. The crew will usually re-block the train before continuing south from Morris.

Block To – Indicates the next destination for this car. This could be a yard or a customer location.

FILE – Indicates the file number to return the Waybill to after use.

Special Instructions, Hazmat Designation, and Car Type are self-explanatory.

TO	FROM	VIA	Lading	Special Instructions	Hazmat Designation	Block To	Car Type	FILE	Printed
813 Morris Potash Dist Centre	Mosaic Belle Plaine Mine, Moose Jaw SK	CN Symington	Granular Potash		NON-HAZ	L96	LO	11W99	
814 Morris Potash Dist Centre	Mosaic Belle Plaine Mine, Moose Jaw SK	CN Symington	Granular Potash		NON-HAZ	L96	LO	11W99	
813 Morris Potash Dist Centre	Mosaic Belle Plaine Mine, Moose Jaw SK	CN Symington	Granular Potash		NON-HAZ	L96	LO	11W99	
818 Morris Potash Dist Centre	Mosaic Belle Plaine Mine, Moose Jaw SK	CN Symington	Granular Potash		NON-HAZ	L96	LO	11W99	
817 Morris Potash Dist Centre	Mosaic Belle Plaine Mine, Moose Jaw SK	CN Symington	Granular Potash		NON-HAZ	L96	LO	11W99	
618 Charles Fertilizers, Noyes MN	PotashCorp Patience Lake Mine, Saskatchewan SK	CN Symington	Granular Potash		NON-HAZ	M74	LO	11W99	
615 Charles Fertilizers, Noyes MN	PotashCorp Patience Lake Mine, Saskatchewan SK	CN Symington	Granular Potash		NON-HAZ	M74	LO	11W99	
610 Charles Fertilizers, Noyes MN	PotashCorp Rocaville Mine, Rocaville SK	CN Symington	Granular Potash		NON-HAZ	M74	LO	11W99	
621 Dakota Plains Fertilizer Plant, LaMoure ND	Mosaic Belle Plaine Mine, Moose Jaw SK	CN Symington	Granular Potash		NON-HAZ	C10	LO	11W99	
622 Dakota Plains Fertilizer Plant, LaMoure ND	Mosaic Belle Plaine Mine, Moose Jaw SK	CN Symington	Granular Potash		NON-HAZ	C10	LO	11W99	
623 Dakota Plains Fertilizer Plant, LaMoure ND	PotashCorp Patience Lake Mine, Saskatchewan SK	CN Symington	Granular Potash		NON-HAZ	C10	LO	11W99	
624 Dakota Plains Fertilizer Plant, LaMoure ND	PotashCorp Patience Lake Mine, Saskatchewan SK	CN Symington	Granular Potash		NON-HAZ	C10	LO	11W99	
625 Simplot, Grand Forks ND	PotashCorp Rocaville Mine, Rocaville SK	CN Symington	Granular Potash		NON-HAZ	C10	LO	11W99	
626 Simplot, Grand Forks ND	PotashCorp Rocaville Mine, Rocaville SK	CN Symington	Granular Potash		NON-HAZ	C10	LO	11W99	
627 Simplot, Grand Forks ND	PotashCorp Patience Lake Mine, Saskatchewan SK	CN Symington	Granular Potash		NON-HAZ	C10	LO	11W99	
628 Simplot, Grand Forks ND	PotashCorp Patience Lake Mine, Saskatchewan SK	CN Symington	Granular Potash		NON-HAZ	C10	LO	11W99	
629 Simplot, Grand Forks ND	PotashCorp Rocaville Mine, Rocaville SK	CN Symington	Granular Potash		NON-HAZ	C10	LO	11W99	
630 CISL, Grand Forks ND	Agrium Vantoozy Mine, Vantoozy SK	CN Symington	Granular Potash		NON-HAZ	C10	LO	11W99	
631 CISL, Grand Forks ND	Agrium Vantoozy Mine, Vantoozy SK	CN Symington	Granular Potash		NON-HAZ	C10	LO	11W99	
632 CISL, Grand Forks ND	Mosaic Belle Plaine Mine, Moose Jaw SK	CN Symington	Granular Potash		NON-HAZ	C10	LO	11W99	
633 PotashCorp, Chicago IL	PotashCorp Patience Lake Mine, Saskatchewan SK	CN Symington	Granular Potash		NON-HAZ	C10	LO	11W99	
634 PotashCorp, Chicago IL	PotashCorp Rocaville Mine, Rocaville SK	CN Symington	Granular Potash		NON-HAZ	C10	LO	11W99	
635 PotashCorp, Chicago IL	PotashCorp Patience Lake Mine, Saskatchewan SK	CN Symington	Granular Potash		NON-HAZ	C10	LO	11W99	
636 PotashCorp, Chicago IL	PotashCorp Rocaville Mine, Rocaville SK	CN Symington	Granular Potash		NON-HAZ	C10	LO	11W99	
637 PotashCorp, Chicago IL	PotashCorp Patience Lake Mine, Saskatchewan SK	CN Symington	Granular Potash		NON-HAZ	C10	LO	11W99	
638 PotashCorp, Chicago IL	PotashCorp Rocaville Mine, Rocaville SK	CN Symington	Granular Potash		NON-HAZ	C10	LO	11W99	

35. Waybill data in the Car Control File.

After processing on the office track, the cars are ready to go into service.

Conclusion

Potash is a vital commodity that can be found riding the rails all over North America. Thanks to North American Railcar Corp,



36. Finished car cards and waybill.

you can add these distinctive cars to your fleet too. I hope you've enjoyed this behind the scenes glimpse into operations on the BNML!



[Click here to rate or comment on this article](#)



WILLIAM J.A. BRILLINGER



William (Bill) grew up in Elora, ON, Canada. He received his first HO scale model train when he was seven years old. During his teenage years he worked for a hobby shop in Kitchener, ON, where he learned to paint and scratchbuild.

With the encouragement of his friends at the hobby shop, Bill's model parts business, Precision Design Co., was born. PDC designed and produced photo-etched parts and did artwork for custom decals. In

December 1994, *Model Railroader* published Bill's drawings of the Canadian National's Point St. Charles caboose. Shortly after that, he moved to Manitoba to work with Promotex Inc.

In Manitoba, Bill met his wife, Dana, and together they have two children. After leaving Promotex in 2006, Bill focused on website development and IT work. In 2013 Bill relaunched PDC and has been working full time in model railroading again since 2014.

Bill began building his dream layout in 2014. The BNML is a 50' x 35' T-shaped layout that occupies the second floor of his home. It follows the southern segment of a secondary interchange line between CN and the BNSF, crossing the border at Emerson, MB. Bill is heavily inspired by the work of Mike Confalone and Lance Mindheim.

Bill regularly participates in discussions on the MRH Forums. He is a member of several railroad-related Facebook groups and moderates the RailPro user group. ■

YOU DON'T HAVE TO BUILD IT...

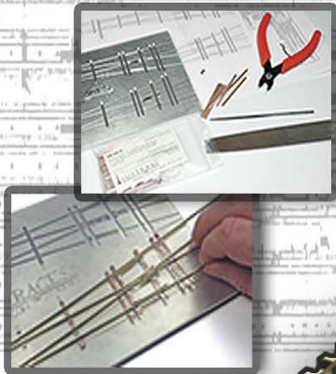

YOU GET TO BUILD IT!

With track building tools
and supplies from...

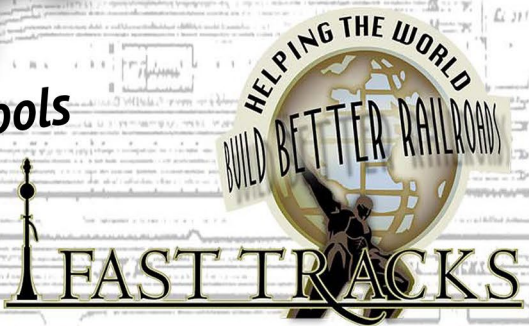

Visit HANDLAIDTRACK.COM and start today!

• [INDEX](#)



SUBSCRIBE
(free)

• [TABLE OF CONTENTS](#)

HUGE SAVINGS!

5-volume Siskiyou Line video series

Sold separately

~~\$149.95~~

Now just

\$29.99

Save 84%!

PLUS BONUS DVD:
Siskiyou Line Lessons
Learned

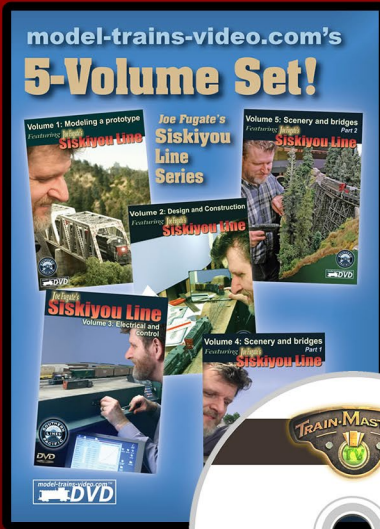

Lessons from layout 1 and sneak peek at Siskiyou Line 2!

Yes, send me my disks >>

store.mrhmag.com



YES, IT'S A MODEL

compiled by
DON HANLEY
.....



[Click here to rate or comment on this article](#)



1. S&NY #112 pounds upgrade over Pleasant Stream at Masten Loop bridge, September, 1939. Mike Hauk modeled this scene of #112 using a PFM Ma&Pa #43 rebuilt with can motor, LED lighting, and TCS WOW Steam decoder. He photographed this scene on his model representation of the Susquehanna & New York Railroad, a northern Pennsylvania shortline abandoned in 1942. Mike added steam and smoke effects to his photo with Photoshop brushes, then ran the finished image through Silver Efex Pro 2 black-and-white and sepia filters.

► **MRH'S MONTHLY PHOTO ALBUM**



YES, IT'S A MODEL | 2



2. CSX 225968, an ex-Chessee covered hopper, rolls through the EK Subdivision yard in Hazard, KY. Tony Hubbard modeled this car in cement service using an Athearn Ready to Roll car that he enhanced by adding train line air hoses and weathering it with

YES, IT'S A MODEL | 3

Pan Pastels, plus acrylic and oil paints. Tony went further by fading the finish on the sides and top, as well as modeling some "cement spillage." The spillage appeared to be mostly dust in the prototype photo Tony referenced, so he applied a neutral gray Pan Pastel to achieve the effect. Tony also added rust effects using burnt umber acrylic paint, then added transparent orange oil paint on top of the umber.

SBD 220071, a former Monon covered hopper sits in the EK Subdivision yard at Hazard, KY. The car is also in cement service. Like the CSX car, Tony started with an Athearn Ready to Roll car, added train line air hoses, and weathered it similarly, including adding "cement spillage," which he accomplished using Neutral gray and Payne gray Pan Pastels.

Did you see this MRH video?



**A full-sized F7
cab in the
layout room?**

Watch the video now





3. Here is a view down Corona Avenue in Vernon, CA on a quiet sunny day. The scene was shot on Lance Mindheim's Los Angeles Junction switching layout, a proto-freelanced representation of the LAJ Horn Lead.



[Click here to rate or comment on this article](#)



.....

\$ GET PAID FOR YOUR PHOTO

We pay \$40 per photo we publish. If you'd like to get your photo posted here, just start posting your photos on the MRH website, especially in the Weekly Photo Fun thread created each week.

See mrhmag.com/help/how-to-post-an-image for more on how to post an image. You need to be an MRH subscriber to post photos to our website, and becoming a subscriber is free, [just fill out this form here.](#) ■

.....

138,000 have seen this MRH video - *have you?*



Watch the video now 

When talking to hobby vendors, please remember to mention MRH.

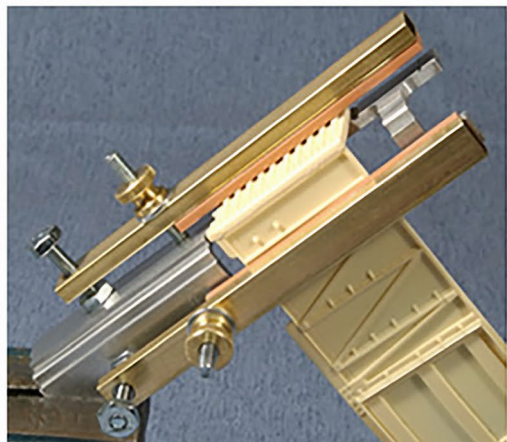
Combo Right Clamp™

Combo Right Clamp™
with cast resin boxcar

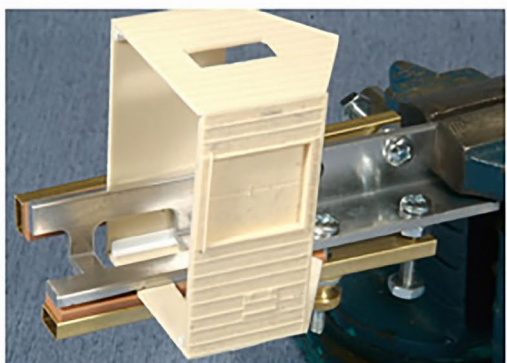

Combo Right Clamp™
with Wolf Design Pump House

**Click here for
all our products ...**

Tools for Modelers

Coffman Graphic Solutions Co.
1500 River Circle, Richmond,
KY 40475-7907

Norfolk and Western Historical Society



Available Now!
Standard Station Kit
HO Scale



Over a decade out of print!
**This Laser-cut kit is a
detailed model and fits any
era from 1895 on**
New limited run now in stock!

Item 134.32
Retail \$84.95

Click Here!





Building a modern factory scene for our TOMA layout on TrainMasters TV ...

• [INDEX](#)

• [TABLE OF CONTENTS](#)

Structures for the EAST PITTSFIELD INDUSTRIAL PARK

BY BARRY SILVERTHORN



As seen on
TrainMasters TV
click to learn more ...



IN THE JUNE 2017 ISSUE OF MRH, I DESCRIBED building the depot on Section #1 of our Pittsfield Branch. Section #3 on [our TOMA project layout](#) is a modern industrial park scene.

Most of the layouts that I have built in the past were pre-1990 models, and I haven't had the opportunity to build a modern industrial

• [INDEX](#)



SUBSCRIBE
(free)

• [TABLE OF CONTENTS](#)



[Click here to rate or comment on this article](#)

landscape. One characteristic of industrial properties built in the last 50 years is that there is a lot of open space, and space is one thing that there's never enough of when it comes to model railroads. But in this case we did manage to fit two industries into the 2' by 7' space that we have available.

The challenge was to create businesses that would be substantial enough to justify at least two cars each – either as loads coming in or going out – without overwhelming the scene. After a bit of research we settled on a chlorine transfer facility and a kitty litter processing plant.

Hudson Chemical

Hudson Chemical represents a repackaging facility where chlorine is received in tank cars and transloaded into tank trailers or cylinders for delivery to customers who would use it in smaller quantities. We have several new Atlas 17,360-gallon tank cars on hand for the layout.

These cars were primarily designed for transporting liquid chlorine, so it seemed like a good fit. Chlorine is used to make pharmaceuticals, PVC water pipe, vinyl siding, pesticides, and to treat drinking water. It's transported via railcar or tank trailer in a liquid form under pressure at ambient temperature, and delivered to end-users in yellow cylinders or large drums called “tonners.”

Chlorine is highly toxic, corrosive, and can accelerate fires under certain conditions, so it must be handled and stored carefully. To unload the railcars, the chlorine is displaced by dry air or



2. An excellent example of simple unloading rack in a small transloading facility. *Chlorine Institute photo*

nitrogen gas and flows into a receiving container or directly into a tank trailer.

Chlorine vapor from the tank goes to a “scrubber” where it produces sodium hypochlorite, or what most of us know as bleach. There are stray-gas detectors and emergency shutoff valves at both ends of the system, and the process is monitored carefully by personnel as the product is unloaded.

The Hudson Chemical transload facility started as several Walthers kits. If we had more space to work with I could have included storage tanks in the scene.

PARTS

933-2928	Walthers	Washington Salvage Yard
933-4037	Walthers	Modern Loading Racks
933-3105	Walthers	Piping Kit
933-3125	Walthers	Chain Link Fence Kit

The Washington Salvage Yard was built according to the instructions with no modifications. One thing that can be said about modern industrial buildings – they’re fairly nondescript. From the outside it’s hard to tell if a structure is a processing facility, a warehouse or fabrication shop. All it takes is a bit of signage to give us some clues. I found the “Hudson” logo in my stray decal collection and built the sign with scrap styrene..



3. Walthers’ Washington Salvage Yard is an unassuming structure that is typical of modern industrial buildings.

Wm. K. Walthers Inc. photo



4. The Pittsfield Turn lifts a pair of chlorine tanks. The sign on the wall is the only modification to the building kit.

Any facility that handles hazardous chemicals will need to be fenced for obvious reasons. Although I adore the lacy appearance of chain link fences, I find building them unpleasant, to say the least. The Walthers kit has all the parts, but there are some things you can do to make assembly easier.

I start by laying out the perimeter using .080" X .188" Evergreen styrene as a base for the fence posts. This base helps to keep everything in place while gluing the parts [5]. It can be painted grey to simulate a concrete border, and once the fence is in place the ballast and scenery can hide most of it. I spray 3M Super 77 adhesive on a piece of paper and lay the chain link mesh material on it to make it easier to cut.

I can lay the paper/mesh right onto the fence while gluing it, if I'm careful, and then peel the paper off. And yes, sometimes I'll pull the mesh with it. It's not a simple technique, but when it works it ensures the mesh is taut and level. I'm not a big fan of having to

STRUCTURES FOR EAST PITTSFIELD | 7

glue the wire to each of the posts in the manner suggested in the kit instructions. It seems to me that it creates a lot of joints that can break, even if they're just brushed by a careless hand.

Fellow modeler Bob Fallowfield has a great solution. He drills holes in each post using a #75 drill bit and threads the wire through them. It sounds tedious but not nearly as tedious as having to glue a wire back on later. Thanks for the tip, Bob.

The Modern Loading Racks kit contains four racks, but I only needed two of them. The Piping Kit is used to route the chlorine from the tank cars, and includes shut-off valves.

I dusted the building with Pan Pastels to tone it down a bit. I'm impressed with what a bit of weathering can do, especially on bare plastic. The scene was finished with track bumpers, vehicles, barrels, skids, gas cylinders, and a forklift. The parking lot lighting from Atlas is operational, so we can dim the lights in the studio and have evening operating sessions.

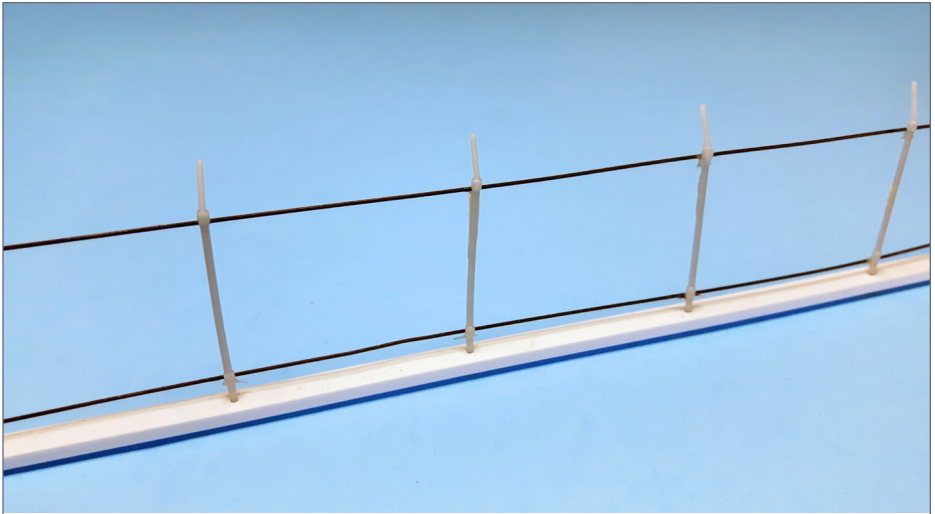

5. Styrene strip is used as a base for the fence posts.

STRUCTURES FOR EAST PITTSFIELD | 8



6. The finished scene takes up a 17" x 27" space, but still provides plausible justification for two railcars to service it. Some extra parking lot was Photoshopped into this scene at the upper left; the edge of the layout is actually just beyond the building's office.



7. Details bring the scene to life. Those yellow cylinders give a clue as to the use of the building.

Sacco Cat Litter

The inspiration for the Sacco Cat Litter processing facility was an article from the *News 4 Nevada* website. While looking for kitty litter plants online, I stumbled over this example of a recently resurrected factory in Lovelock, NV. Tolsa USA Inc. employs about two dozen people at the plant.

Bentonite, an absorbent clay, is transported from their mine at Casper, WY in covered hopper cars and unloaded by a pneumatic system into holding bins on the property. A computerized system mixes precise amounts of clay and additives to produce clumping, non-clumping and other types of cat litter. The company also has a 40,000 square-foot warehouse to store the packaged litter.

The finished product is transported by truck to retailers' warehouses across the USA. I wanted Sacco Cat Litter to have a capacity for four hoppers of arriving shipments of clay and two



9. Members of the Lovelock community tour the Tolsa facility during opening ceremonies in October of 2015.

Credit: News 4 Nevada

boxcars for loads of product going out. I chose a variety of kits to create my own version of the Tolsa facility.

PARTS

933-3192	Walthers	Bud's Trucking
933-2937	Walthers	Wet/Dry Grain Storage Bins
933-3081	Walthers	Plastic Pellet Transfer
933-3123	Walthers	Grain Storage Bin
933-3124	Walthers	Grain Conveyor
933-3510	Walthers	Wall-Mount Dust Collectors
628-304	Rix	Grain Bin

Bud's Trucking is a background building that was designed to be used against a backdrop. It's used in the same manner on our project layout, but is placed at an angle. I had to lengthen one of the sidewalls to fill the extra space [10].

Leftover scraps from some Rix kits were used, but because viewers of the layout can't see the wall behind the bins, styrene sheet would have been suitable. A plain styrene roof was also cut to fit the space. More Rix wall scraps were used to make a HVAC room for the rooftop.

Arguably it's the storage bins and piping that make this industry interesting. I chose to use a combination of bins similar to what is in the photo of the Tolsa plant. The Wet/Dry Grain Storage Bins turned out to be a lot taller than I planned and they dominated the scene. I also realized that the Grain Conveyor tower wouldn't be nearly tall enough to service them. The solution was



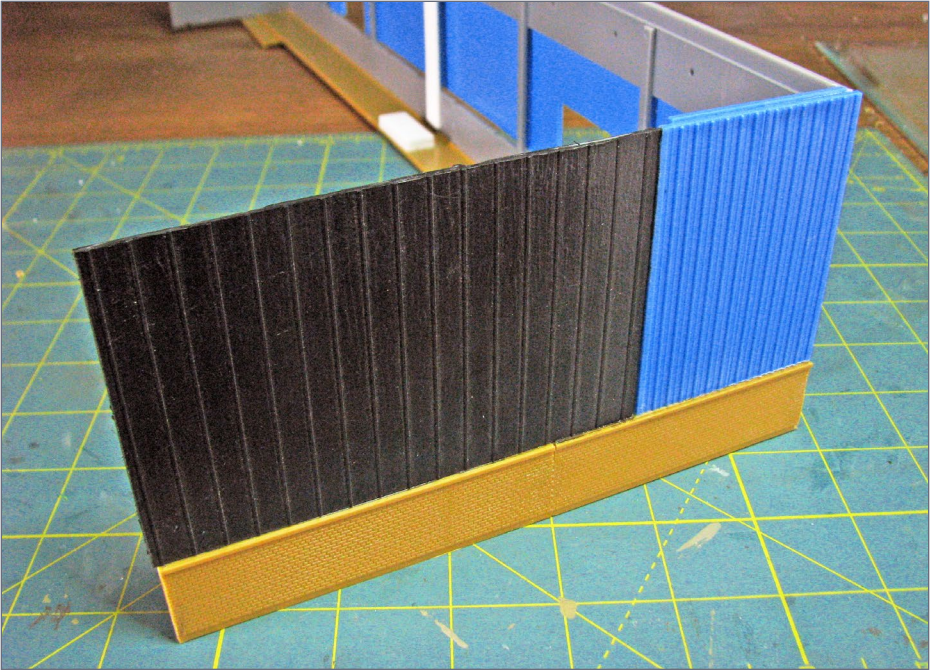

10. The left sidewall of Bud's Trucking was extended to meet the backdrop.

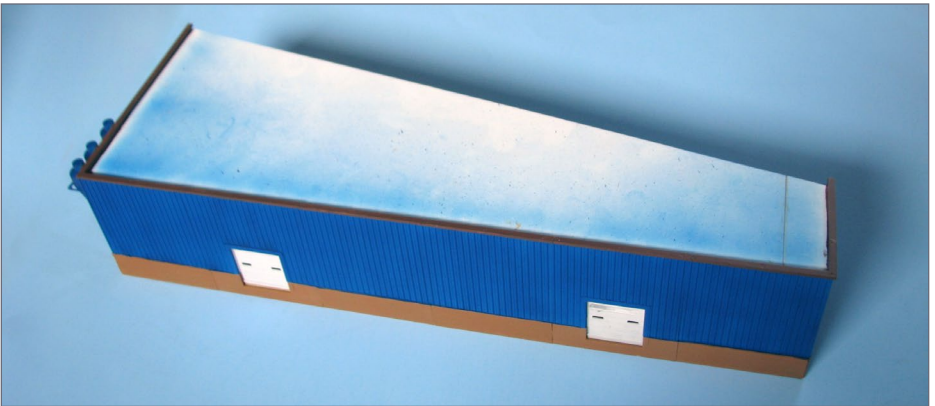

11. A new roof and wall cap was fabricated to fit the trapezoidal shape of the main building.

STRUCTURES FOR EAST PITTSFIELD | 10

to use some styrene stock to extend the conveyor tower about two inches, and cut the bins down by 20 scale feet [13].



12. The Wet/Dry Grain Storage Bins are an interesting feature of the facility, but at almost a foot tall they overwhelm the other structures. *Wm. K. Walthers Inc. photo*

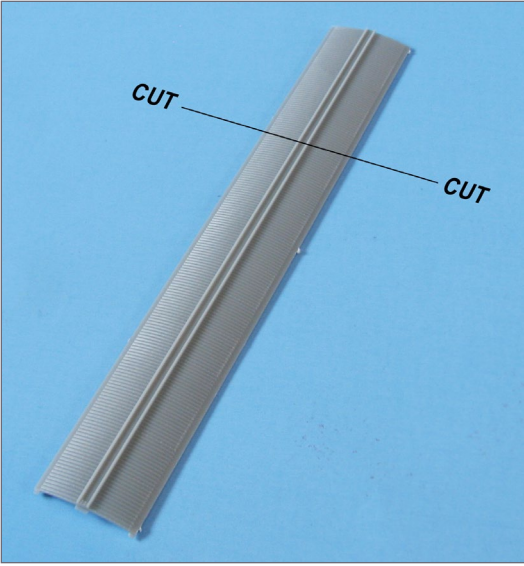

13. The corrugated wall sections were cut down by almost one third to reduce the bin height.

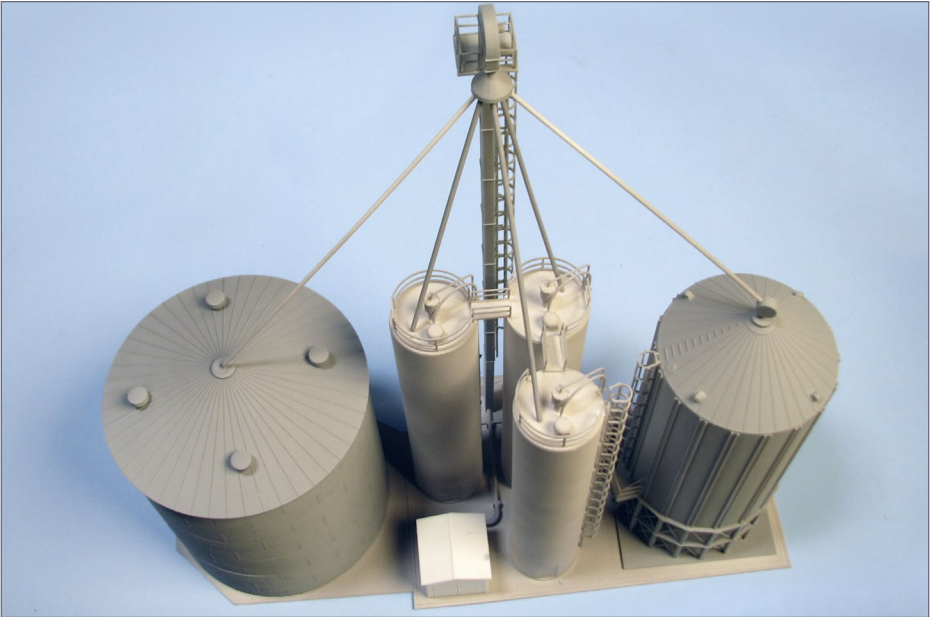

14. The bin arrangement assembled on a concrete pad, ready for painting.

STRUCTURES FOR EAST PITTSFIELD | 12

In my research I learned that the dust from Bentonite clay has a tendency to stick to the inside walls of corrugated bins, requiring them to be cleaned often, so I added three smooth-sided silos from the Plastic Pellet Transfer kit. The kit also includes the trackside pneumatic piping for unloading the hoppers.

All the bins were mounted on a styrene base, along with the conveyor tower and piping. This makes it easy to remove the entire arrangement for transport without having to worry about breaking any of the delicate parts. I built a short section of pipe that would be used to move materials from the pumphouse to the conveyor tower.

We named the facility for Jim Sacco, owner of City Classics and slave to several domesticated cats. It's a fun way to honour a friend and we think "sack o' cat litter" is a great play on words at the same time. I was tempted to add a sign to the side of the



15. A boxcar is spotted for loading with skids of packaged Sacco Cat Litter. Note the yellow natural gas piping on the roof, an industrial detail that often gets overlooked.

building but I eventually realized that it would be unlikely that the company would spend the money to advertise themselves on the back side of the property. Jim is a talented graphic designer, so maybe we can get him to make a sign for us.

Scenery and detail

Industrial parks can be interesting environments to model since they aren't natural. Lot grading is engineered to provide good drainage and much of the open space is allocated to parking. Lawns are kept trimmed and trees are often mulched. Ditches are sometimes planted with cattails because they help to remove contaminants from the water and prevent erosion.

I made parking lot curbs by carefully warming .080" X .080" styrene strip with a heat gun and bending it to shape [17].

Just as was the case with the Pittsfield Depot scene (mrhmag.com/magazine/mrh2017-06/depot-for-pittsfield), building a

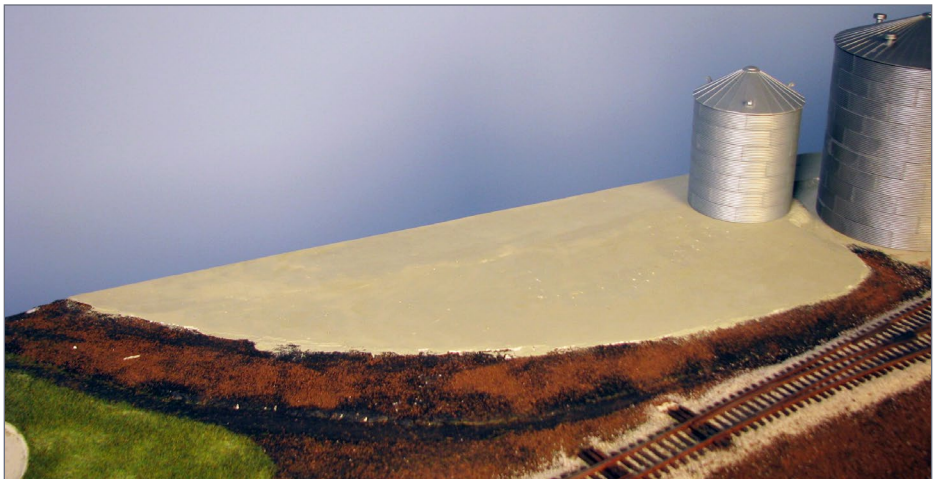

16. A piece of 3/8" plywood raises the parking lot for the Sacco plant above the surrounding scenery. Drywall compound is used for the surface.



17. With some patience a heat gun can be used to heat the styrene up just enough to make it easily bendable. Watch your fingers!



18. Groomed lawns grow right next to scrub land. With so much variety there's plenty of opportunity to try out new landscape techniques.

STRUCTURES FOR EAST PITTSFIELD | 15

credible industrial scene is simply a matter of doing a bit of research and taking note of the world around you.

If you'd like to see the Pittsfield Branch layout in person, check it out at TrainFest in Milwaukee on November 11-12, 2017.



19. The finished kitty litter plant scene.

STRUCTURES FOR EAST PITTSFIELD | 16



[Click here to rate or comment on this article](#)



• [INDEX](#)



[SUBSCRIBE](#)
(free)

• [TABLE OF CONTENTS](#)

BARRY SILVERTHORN



Barry Silverthorn is the Executive Producer of TrainMasters TV. He got his start in the hobby at age four and has built models in N, HO, S and O scales, and has operated a model train shop. His S scale structure kits received a National Association of S-Gaugers award for Manufacturer of the Year in 2010. He lives in a replica train depot on Canadian National's busy mainline between Toronto and Montréal.

ADVERTISEMENT



*Announcing
Motrak Models New Structure Kit
HO Scale "The Tool Shed"*

**CHECK
IT OUT!**



*Website: motrakmodelsusa.com
Email: info@motrakmodelsusa.com*

WISH: Shadow seasoned home layout builders and learn their best tricks ...



Design: Joe Fugate & Miles Hale



Construction: Pierre Oliver & Miles Hale



Wiring: Ed Wilson & Miles Hale



Structures: Miles Hale & Barry Silverthorn



Scenery: Fran & Miles Hale

GRANTED: In the 2017 TMTV season, we do just that.

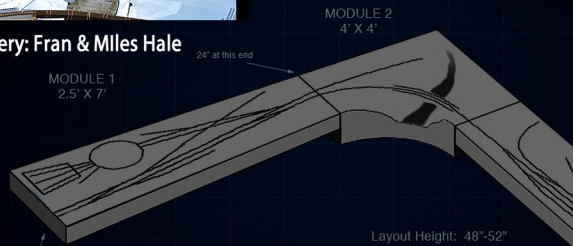

Brought to you by



TRAINMASTERS.TV

Don't miss out: Click now and join in!

Structures provided by



walthers.com

• INDEX



SUBSCRIBE
(free)

• TABLE OF CONTENTS



POLY FIBER MATS

for quick and easy landscaping

BY RICK WADE

Get rid of the “blues” on your naked foam with poly fiber mats ...

MY LAYOUT ROOM IS ALSO MY OFFICE, WHERE I work full time performing software presentations over the web. There are real advantages to combining my hobby and work space in one room; however, one of the disadvantages for me is staring at

• [INDEX](#)

• [TABLE OF CONTENTS](#)



[Click here to rate or comment on this article](#)

all the naked blue foam that makes up the surface of my Richlawn Railroad. You see, I move at a snail's pace and it could be years before all that blue gets covered by permanent scenery.

Poly fiber mats to the rescue! I used them on my previous layout to quickly cover large areas with interesting looking greenery, so I decided to use them to "get rid of the blues." I can't remember where I first saw the technique. I didn't invent it, but I'm grateful to whoever thought up the idea.

Just check out the area around my salvage yard that I landscaped using poly fiber mat [1].



1. I landscaped this area on my layout using just poly fiber mats – quick and easy!



POLY FIBER MAT LANDSCAPING | 3

The main ingredients for the mats are simple: poly fiber, ground foam of different colors and textures, and spray adhesive [2]. I prefer black poly fiber (available from MicroMark and other vendors) as it seems to give more realistic shadows as compared to green or white poly fiber.

I start by pulling and stretching the fiber to make a very thin layer – the thinner the better [3].

Spraying the adhesive is messy business, so you'll want to work outside and wear a glove on the hand that you use to hold the poly fiber while spraying. Be careful to pick a spot outside where the spray won't drift on something that you don't want sticky. I start by generously spraying the piece of poly fiber with the adhesive on both sides before applying ground foam [4].



2. Materials needed to make poly fiber mats.

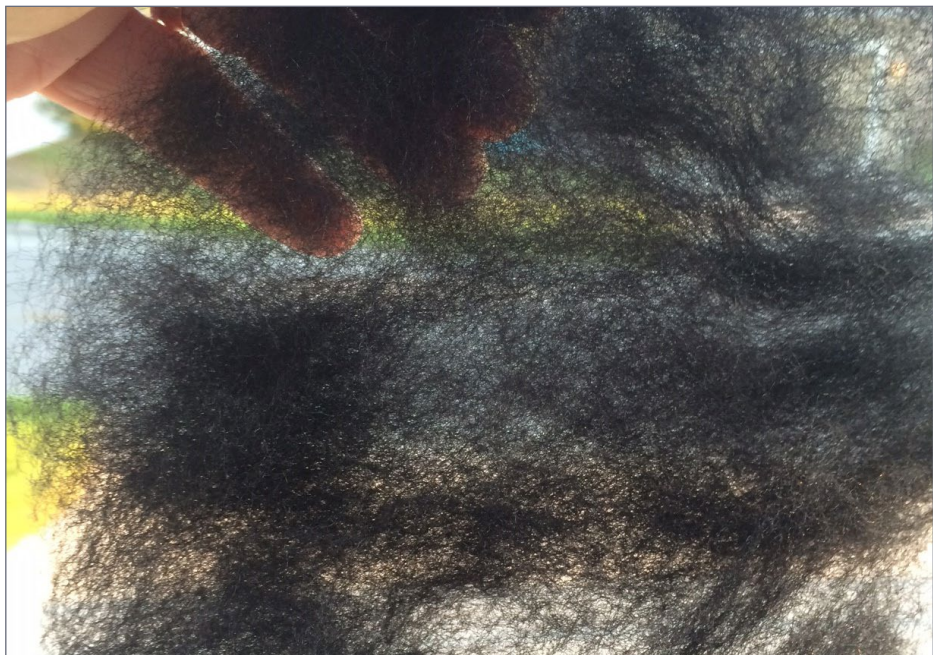

3. Stretched poly fiber mat.



4. Applying adhesive to the poly fiber.

POLY FIBER MAT LANDSCAPING | 5

Immediately after applying the spray adhesive I drop the poly fiber into my container of ground foam and use a cup to cover the entire piece with foam before pressing down on the fiber to set the foam [5]. Don't worry if you don't get complete coverage; the process can be repeated if necessary.

Here's what a pad looks like when it is ready to install on my layout [6]. If I want less texture, I can compress the poly fiber to give it a flatter look. I make up a bunch of these poly fiber mats of different sizes and shapes and head to the layout.

I paint the blue foam with dirt-colored "junk" paint. To install the poly fiber pads, I use a hot glue gun, unscented non-aerosol hair spray, and more of the same ground foam that I used to make the mats. First, I "dry fit" the pad to see how I need to trim it [7].

Using regular scissors, I trim the piece to the approximate size for the area [8]. The pad can be stretched or squeezed as



5. Applying ground foam to the poly fiber mat.

POLY FIBER MAT LANDSCAPING | 6

necessary to fit the area. If you purposely make it too big you can create hills easily!



6. Poly fiber mat, ready to install on the layout.



7. Poly fiber, needing trimmed after test fitting.

POLY FIBER MAT LANDSCAPING | 7

I use the hot glue gun to run a bead of glue along only one of the borders where the pad will be attached [9].



8. Trimming a poly fiber mat to size.



9. Applying hot glue to the area where the poly fiber mat will go.



10. Pressing the poly fiber mat down into the hot glue. After getting some nasty burns doing this, I now recommend using some gloves!

As I position the pad in the hot glue I use my fingers to push the edge of the pad into the glue [10]. NOTE: Wear a glove when doing this as it's easy to burn your fingers. Ask me how I know!

I only glue the edges of the mats. It's not necessary to glue more and it will make the mats easier to remove if I decide to replace them with more permanent landscaping. There will be uncovered parts of the poly fiber where the black shows, especially at the joints between the pads [11].

It's easy to cover the exposed black poly fiber by spraying it with the hairspray and sprinkling on the same ground foam used to make the mats [12]. After applying the ground foam, give it a spray with hairspray to set the foam.



11. Closeup of an installed poly fiber mat showing some joints that need a little extra ground foam to disguise.



12. Adding some extra ground foam to disguise the poly fiber mat joints.



13. The final result using the poly fiber mats.

All done

Here's the area which was blue foam, now covered with the poly fiber mats. The entire process took about 2-1/2 hours, including making the mats.

Using poly fiber mats covered with ground foam is a quick and easy way to cover areas on your layout. Once the mats are in place you can add trees, bushes, and other scenery items. Best of all, no more blue (or any other color) foam will be showing on my layout!

Here's a YouTube video showing my process:

youtu.be/UoJuEigRuuY. 

RICK WADE



Rick grew up in the east end of Louisville, Kentucky during the '50s and '60s. This gave him lots of opportunities to watch the Louisville & Nashville trains pass only 200 feet behind his home. His first real layout was an HO scale beauty that he and his father put together when he was 8 years old. They built it on a ¾" sheet of plywood that would roll under his bed when it wasn't in use.

In 2006, he purchased the DPM "1st National Bank" kit and assembled it after reading up on construction and weathering. He enjoyed the experience so much that he bought another kit... and then another... and he was hooked. With all the finished kits mounting up the only logical thing to do was get back into model railroading!

He built his first HO layout in his Georgia basement. The Richlawn Railroad was named after his childhood neighborhood. A move in 2012 to Florida to be near to family meant starting over. The new Richlawn Railroad is in his 10 x 12 office and is sectional should he have to move again.

His favorite part of model railroading is still structures, with scenery a close second. He loves watching the L&N trains rumbling through the landscape set in the 60's and 70's as it takes him back to those sweet childhood memories.



[Click here to rate or comment on this article](#)

HO
SCALE

?

**THREE MAJOR RAPIDO
ANNOUNCEMENTS**

?

N
SCALE

CLICK HERE TO REVEAL

N
SCALE

?

• [INDEX](#)



SUBSCRIBE
(free)

• [TABLE OF CONTENTS](#)

Four Common Mistakes in **KADEE-STYLE COUPLER INSTALLATION**

A close-up photograph of a Kadee-style coupler connecting two model train cars. The coupler is a dark, cylindrical metal piece with a hook-like end that fits into a slot on the side of a brown metal train car. The background is a soft, out-of-focus white surface.

BY WILLIAM MOSTELLER

*Check swing, height, curve, and
spring on trouble-making cases ...*

YOU STOP YOUR TRAIN WITH THE COUPLERS you want to separate over the magnet, and give the train a little slack. The couplers fly open [1]! You're having a good day on the railroad. It doesn't always happen that way. While reviewing

• [INDEX](#)

• [TABLE OF CONTENTS](#)



[Click here to rate or comment on this article](#)

equipment bought from others, “w/KDs,” I’ve identified four common mistakes in coupler installation.

No graphite

The friction between the coupler shank and the draft gear (coupler box) is often high enough to discourage free movement of the coupler head over the magnet. Squirt graphite into the draft gear and swing the coupler back and forth with your fingers to work the graphite into the mechanism [2]. If you are lucky, and the coupler box has not been glued shut, a graphite pencil will give better coverage and less mess. Test the installation over the magnet – the coupler should hop to the side.

Upside-down #5 spring

If you look closely at the Kadee #5 spring (you may need a magnifier), you’ll see that the legs of the spring differ – one is straight while the other zig-zags. The differing legs achieve *differentiated centering force*, my term for the tendency of the coupler to swing so that the “thumb” of the coupler “hand” moves toward the center of the track, ideal for delayed uncoupling. If you install the spring upside-down, you defeat this desirable property. The larger flat part of the spring, and the hole in the center of the spring, should be **above** the coupler shank [3].

“Dilberted” gladhands

As you remember, Dilbert’s tie turns up at the end, an amusing affectation. But if after adjusting the gladhand on a coupler, the end curls upward like that, you have a problem [4]. Magnetic



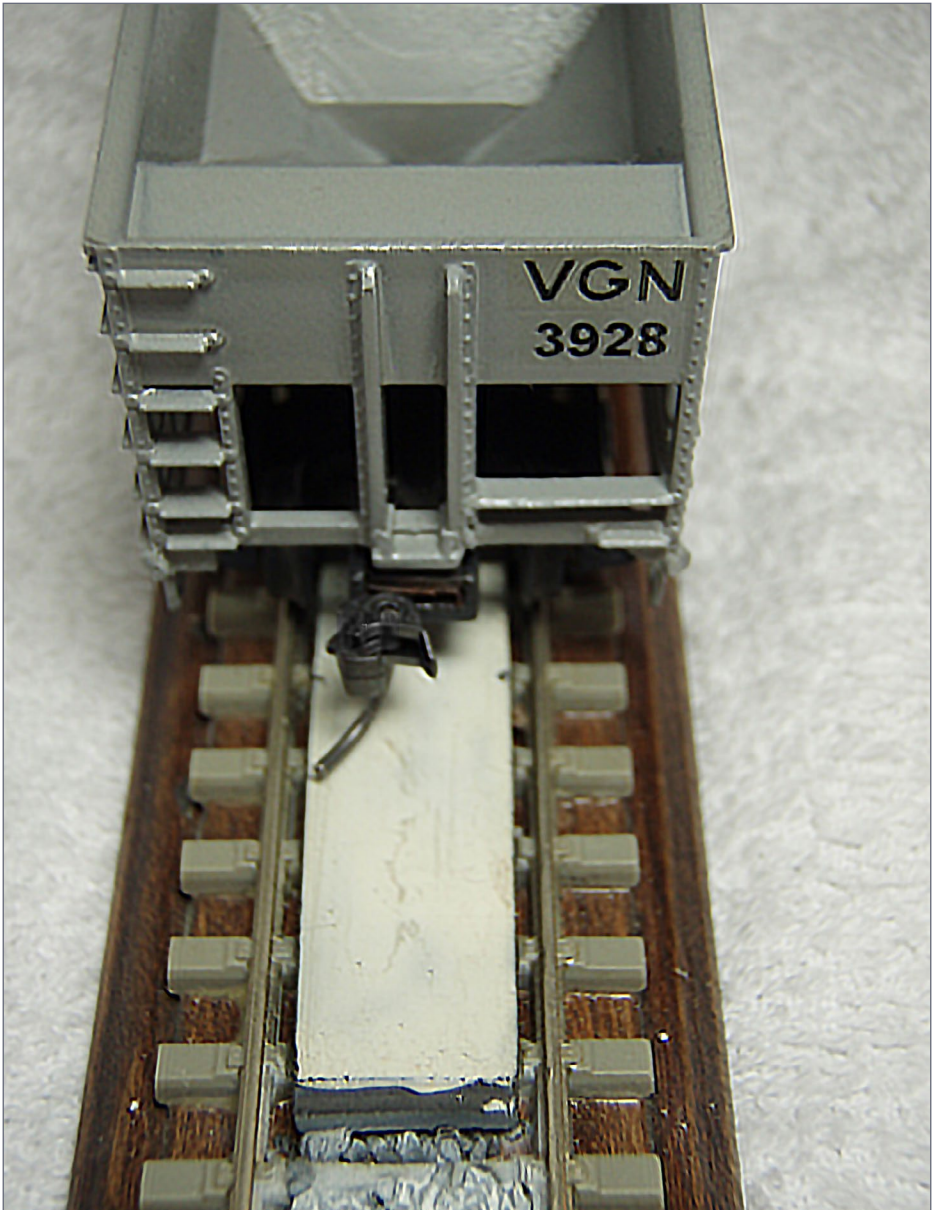

1. Successful uncoupling! Not only has the gladhand swung the coupler open, the coupler itself is swung to one side, ready for a delayed uncoupling move.

force drops off quickly with distance. The geometry of the Kadee coupler design requires that the magnet acts upon the tip of the gladhand. On a “Dilberted” gladhand, the magnet acts weakly on the bottom of the loop, with less leverage and thus less throw. Failed uncoupling, particularly delayed uncoupling, is the unfortunate result.

Athearn boxcars and gladhand adjustment

Before you “Dilbert” a gladhand, remember that this action is a last resort. Kadee manufacturing tolerances are such that gladhands are typically exactly right *if the draft gear is the right height*. And that’s the rub. Check the coupler height before adjusting the gladhand [5].

Note: The draft gear on Athearn boxcars and their brethren (e.g., stock cars) sits low. The right answer is to use a Kadee #27 (underset shank), *not to adjust the gladhand*.

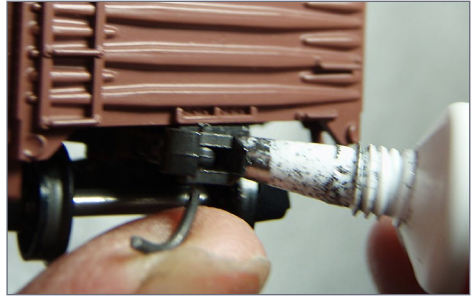

2. Graphite is as important to coupler installation as the spring.



3. Kadee #5 coupler and spring installation, done correctly. Photo courtesy Kadee, Inc.

KADEE COUPLER INSTALL | 5

Tweaking the gladhand does not place the coupler knuckle at the right height to mate correctly with its neighboring cars. .

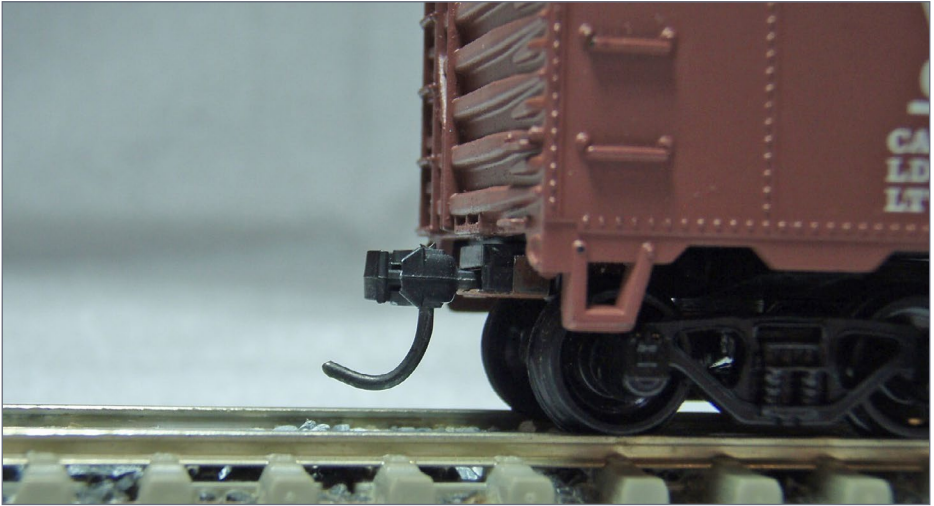

4. “Dilberted” gladhand that has been bent up too far. This coupler won’t work correctly over magnets.

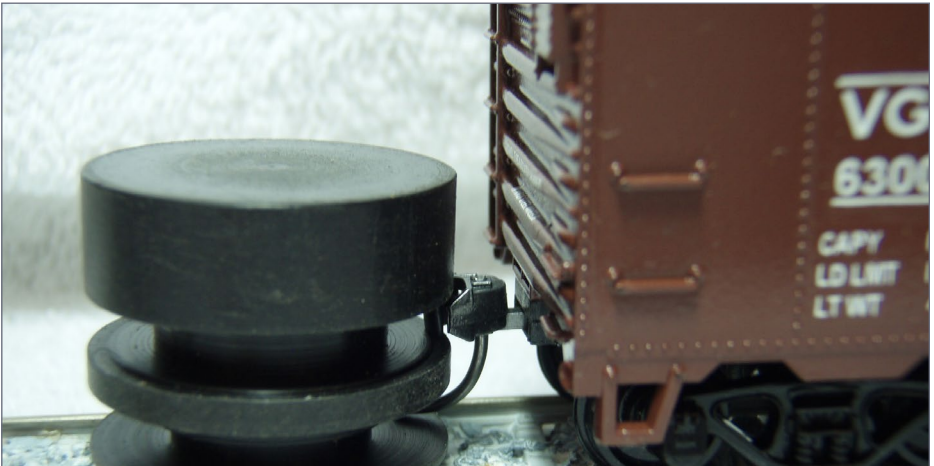

5. Athearn box car with Kadee #27 (medium shank-underset) coupler. The height and gladhand are perfectly to standards without adjustment.

WILLIAM MOSTELLER



Bill started life as a child with a Lionel train set, graduated to HO-scale, and has been modeling since.

Around the turn of the century he started a decal business which now features around 100 titles.

Bill conducts an hour-long clinic on Kadee couplers, from which this material is extracted. He also offers

what he considers the best coupler gauges in HO-, S-, and O scale. See greatdecals.com.



[Click here to rate or comment on this article](#)

When talking to hobby vendors, please remember to mention MRH.





One Module Challenge

The Port of Tacoma

BY SCOTT WILLIAMSON
PHOTOS BY MICHAEL WOLF

TOMA Design Contest second place winner in HO ...

C’MON, ADMIT IT. EVEN THOUGH RAILROADS, and model railroads in particular, form our prime focus, ships are interesting too. Where railroads and ships interact is especially interesting – and can be modeled to provide plenty of switching action and years of satisfying operation. Thus was born the Port of Tacoma – a module based on a major port that can fit in a space available to nearly everyone..

This 2- by 10-foot design offers a lot of “play value” and enjoyment in a relatively small area! Operationally, within this 20-square-foot port module there are five separate switching jobs which can take an average crew of two anywhere from 45 to 90 minutes each to complete. If all were run back-to-back, it would likely take more than four hours.



1. This layout design models the Port of Tacoma, as shown here in this proof-of-concept module. The photo backdrop really adds a big-port feel to the module.

This module doesn't require a huge expenditure to build, can be expanded in phases to fill a spare bedroom, and could eventually keep three crews and a yardmaster busy for hours.

How can I be so sure about this? Because I've already built the Port of Tacoma to these dimensions, and the proof of concept is that the Port has been in operation for more than a year. With so much operation packed into a relatively small area, it is usually one of the first jobs for which those participating in my operating sessions mark-up [2].

I already had a relatively finished 20- by 25-foot layout, but after reading about the TOMA concept in *Model Railroad Hobbyist*, I felt it offered a unique opportunity to expand the layout. I always wanted a port area, and the TOMA idea seemed to fit the bill perfectly to expand my layout along an empty wall.





[Click here to rate or comment on this article](#)

Port operations

Ports provide an abundant supply of businesses that are served by rail: grain and food, mining products, oil, gas, lumber, finished goods, chemicals – the list is nearly endless. While modern ports are primarily focused on container shipment (and car lengths would be a challenge in this small area), earlier ports used shorter cars and smaller ships to move goods.

For that reason, I've chosen 1962 for a time frame. While I used Tacoma as my inspiration and setting, this plan could easily be adapted to ports around the world. This plan does not follow specific track arrangements or actual business names except for the ADM elevator. However, it does incorporate elements of the actual Port to capture a “what if” feel of a port railroad [3].



2. Birds-eye view of the Port of Tacoma module.



3. Combining railroads and a port was the inspiration for the Port of Tacoma module. Two reefers sit outside Puget Sound Seafood waiting for this morning's catch to be loaded.

In 1962 Tacoma, cargo destined for ports near and far came in on one of the four Class 1 railroads serving the city – Great Northern, Northern Pacific, Union Pacific, and the Milwaukee Road. Those railroads handed-off cars to the Tacoma Municipal Belt Line Railway, shortened to Tacoma Belt or “the Muni” by locals. The Muni classified cars for the Class 1 railroads, and interchanged cars with the Port of Tacoma Railroad, which had its own switcher.

In my version, a Proto 2000 0-8-0 provides a neat contrast to the diesel locomotives roaming the rails elsewhere. Lettered for the Port of Tacoma and weathered for years of service, it looks and sounds good, and runs even better..

Signature elements

While the railroad on any port module will be the focus, enough of the flavor of a port needs to be included so the module doesn't simply look like any other industrial switching area. Two of the

ONE MODULE CHALLENGE | 5

most important features are water and docks. Era will dictate to a large extent what is modeled, as a modern port focusing on containers will differ greatly from ports of an earlier era, where breakbulk loading of ships was the standard. The Port of Tacoma in 1962 utilized the latter method.

There were a number of “finger piers” that jutted out into Commencement Bay and looked cool, but take a lot of room to model. Since the focus here is on the railroad, another ploy was needed. Berthing spaces were added over the years, using more modern construction methods. This module tries to show that expansion by way of old versus new.

The right side of the module features “older” piers, while the front utilizes a large modern berthing space and a smaller one for the fishing fleet. The older piers feature individual wooden pilings [4], hand-cut and stained by friend Jim Kehn, whose talent for detail



4. The older pier areas of the Port feature wooden pilings. These were hand-cut and stained by fellow modeler Jim Kehn.



5. These “dolphin” piling structures really give the area an ocean waterfront look. Also note the sheet metal behind them in this modern portion of the port.

extends to greenish barnacles at the base of the pilings, and weathered areas to show the effects of the rise and fall of tides.

The modern pier features sheet piling from Evergreen painted a red primer color and then weathered with gray Pan Pastel paints. The “high tide” line is represented by a heavier light-gray color.

Another key feature in the harbor are “dolphins” – wooden pilings bound together by metal bands or rope to keep drifting ships from going where they shouldn’t. I had a number of them formerly produced by Mr. Plaster, so into the harbor they went. When more were needed, Jim fashioned some from dowels, and they add a nice weatherbeaten touch to the harbor [5].

Industries in the port

There is a wide range of industries in the Port area [6, 7]. During this era, grain for export arrived in boxcars, so they’re what rolls through the big ADM elevator.

ONE MODULE CHALLENGE | 7

Piggyback service was in its infancy, so only a few TOFC cars arrive at the lift [8].

Near the ADM elevator is one of the older wharf areas. I've labeled this Wharf 7 (to imply there are more wharves elsewhere) and it is a tank car unloading area, with an oiler docked there. Next to that, Wharf 8 is the Weyerhaeuser dock, also built with pilings, and serves as the destination for outbound loads of lumber from flats and boxcars.

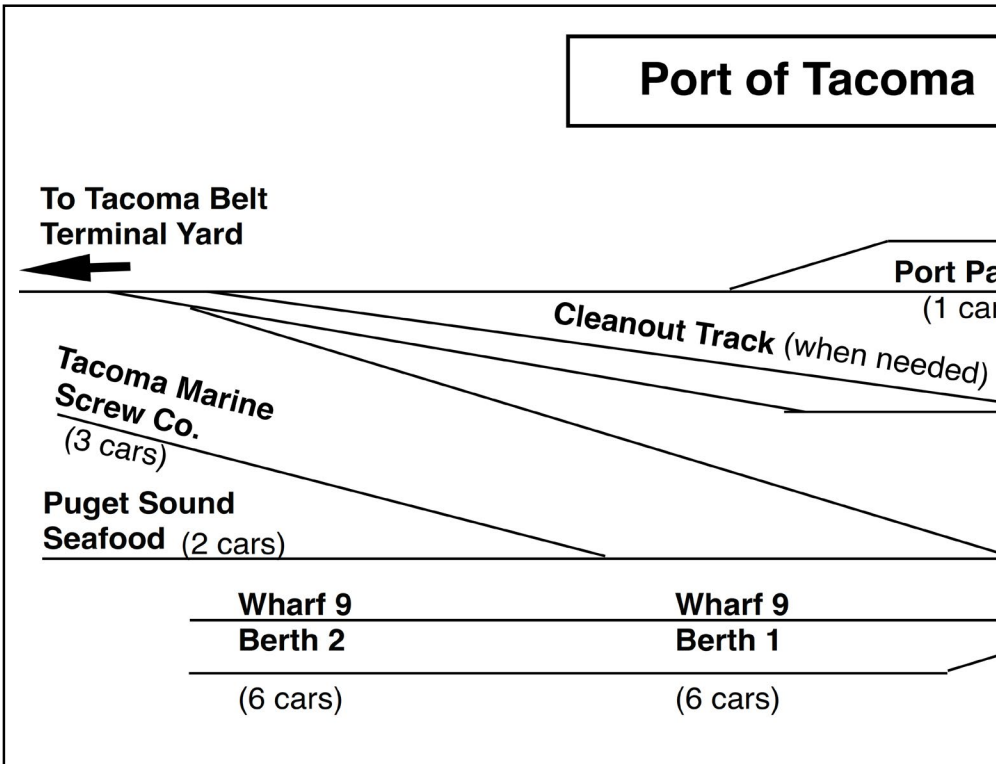

6. The Port of Tacoma packs a number of different industrial areas in just 20 square feet. With minimal extra space for parking cars, I generally work the area as four different jobs of approximately six cars each, and a “rip rap job” to remove rubble from the ADM silo demolition.

ONE MODULE CHALLENGE | 8

Located at the front of the module, for easier switching, is Wharf 9. It has two berths, each holding six cars. Nearby are two industries that don't exist but could have: Puget Sound Seafood, which handles reefers, and Tacoma Marine Screw Co. which makes large propellers for ships; these are transported by gondolas.

At the rear of the module, also near ADM, is a shed serving Port Pallets. It makes a lot of its namesake items. There is a spur for coal to fuel the steamships still in service, plus the Port switcher, which ties up there at the end of a shift [9].

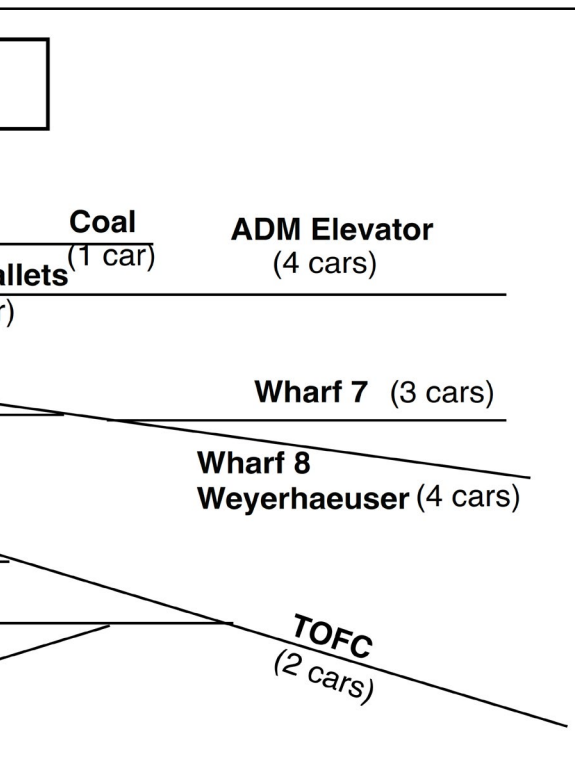

Finally, I had previously modeled a portion of the grain silos under demolition. This added an additional “industrial” spot beyond the grain elevator for a gondola hauling concrete chunks from the site [10].

To ship or not to ship...

That is the question. Actually, the question is how much are you willing

to spend to put a scale-size ship in your port. There are a number of ship models in an acceptable range of scales that can be stand-ins on an N scale layout. For example, the old Revell North Sea Fishing Trawler kit at 1/142 makes a decent coastal steamer for 1/160.

ONE MODULE CHALLENGE | 9

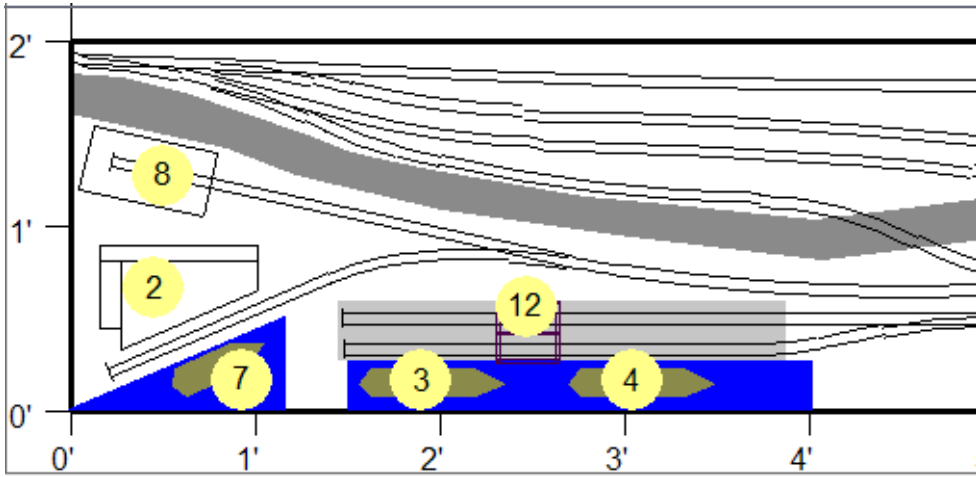

Structure and Ship List	
1	ADM Grain Elevator
2	Puget Sound Seafood
3	North Sea Fishing Trawler
4	Russian Spy Fishing Trawler
5	Russian Spy Fishing Trawler
6	Shell Welder Tanker
7	Shrimp Boat
8	Tacoma Marine Screw Co
9	Port Pallets
10	Oil Loading Platform
11	Oil Storage Tank
12	Loading Cranes (3)
13	Water Column

ONE MODULE CHALLENGE | 10

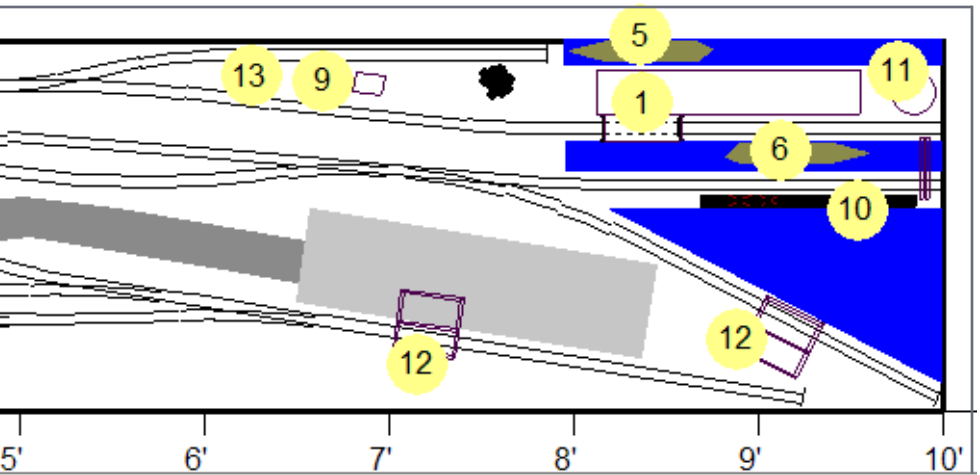

7. The Tacoma Port module. A combination of various structures, ships and wharves provide the feel of a large ocean port and lots of challenging switching in a compact area.



8. Trailers await pickup and shipping at the TOFC operation at the port. Note the guard shack associated with a busy port.



ONE MODULE CHALLENGE | 11



9. Port Pallets is represented simply by a shack. Behind it, coal is delivered for the few remaining coal-fired ships visiting the Port and for use by the Port switcher that ties up for the evening on the same track.



10. The older section of the ADM grain silos is being torn down. The debris goes in a gondola requiring switching daily – adding an interesting twist and additional switching.

ONE MODULE CHALLENGE | 12

In HO, a number of companies offer scale ships, such as ore boats from Walthers and Bearco Marine Model of Ohio. Sylvan Scale Models from Canada offers wonderfully detailed scale models of a Great Lakes freighter, a Laker class steamer, a Great Lakes lumber ship, and a West Coast Lumber ship. Prices range from \$170 to \$300, and a modeler's budget will dictate how important a static model is.

The other critical component is size. The Laker-class steamer would be perfect for a 1962-era port, but at 36 inches long and 6 inches wide, it uses up a lot of real estate. If put at the back, a viewer misses out on a lot of the neat detail. On the other hand, if put at the front of the module, the masts can be easily damaged by crews reaching over to uncouple cars.

In my case, I decided to use undersize ships to give the impression of a busy port (See Bill of Materials – Ships and Structures). One HO boxcar would probably sink or capsize any of my ships if placed aboard at the pier. But as a former-Navy friend



11. Although the ships I used are undersized for HO scale, when combined with a photo backdrop, they provide the feeling of a large port in a module only two feet deep.

ONE MODULE CHALLENGE | 13

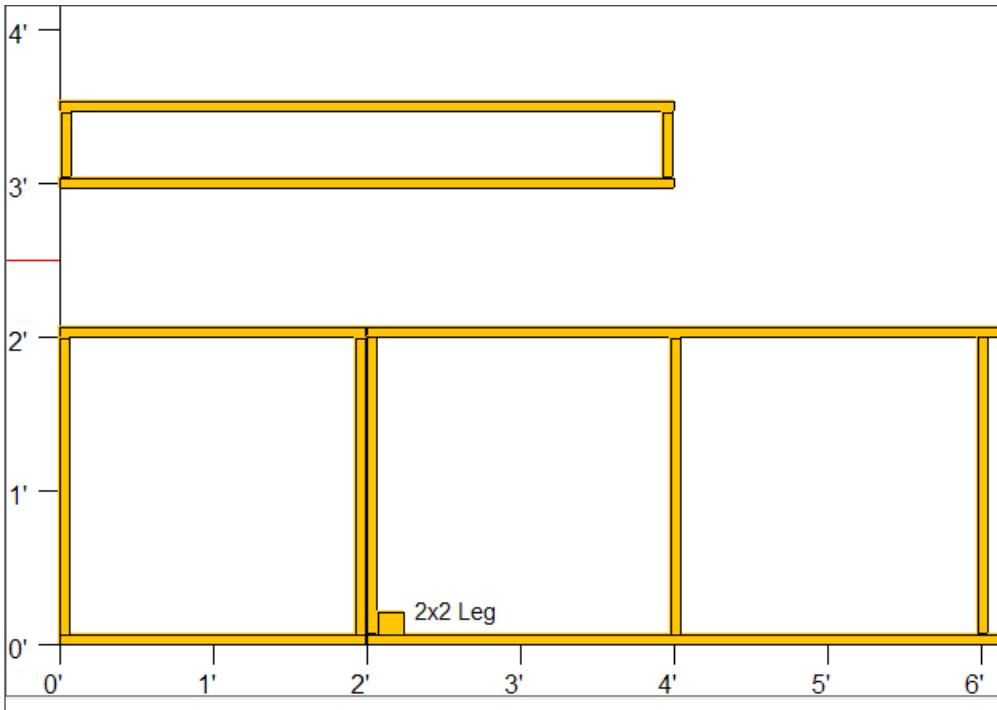

commented when operating the Port job, “Ships come in all sizes, and even though these aren’t scale, they just look right.” So that’s good enough for me [11]. Your mileage may vary.

Physical plant

The Port module uses code 100 Atlas track and Peco turnouts. Selection of these was dictated by two factors: a previously constructed staging yard that connects to Port already used similar track components, and they are cheaper than their code 83 counterparts, which are used throughout the rest of my Tacoma layout.

Additionally, I like the built-in spring of the Peco turnouts to alleviate the need for ground throws.

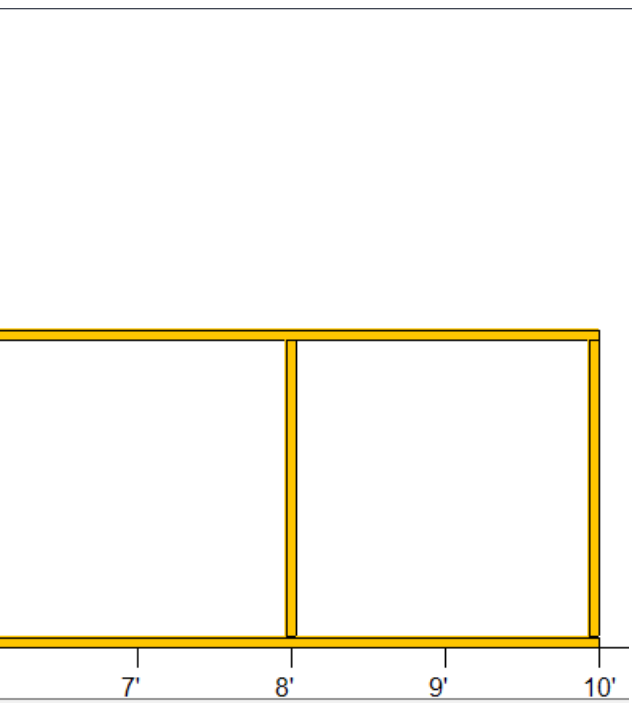

12. Open grid benchwork using 3/4" x 3" plywood "boards" for Phase 1 construction.

The module is wired for DCC, but could easily be operated under DC control. A handheld throttle on a tether would make switching the various areas in the Port easier. A DCC wireless throttle offers even more flexibility and makes it easy to concentrate on switching moves.

The backdrop adds significant depth to the module. It's from Backdrop Junction, and was almost what was needed. The stock photo backdrop had the water on the left side of the print, and land on the right. That was the exact opposite of what this port needed.

Dave at Backdrop Junction nicely reversed the print image at no extra charge. The continuous image was mounted on a piece of hardboard and installed behind the module [1].



Module construction

The port area is flat, so a basic open-grid frame could be built. Friend and fellow model railroader Mike Wolf, who also lists woodworking as a hobby, took care of the module framework.

Mike prefers strips of 3/4" plywood for the frame (vs. one-by lumber). A table saw makes quick work ripping three-inch-wide "boards" from a sheet of plywood. The diagram above [12] shows the basic 2'x8' frame with a 2'x2' box added. While the framework for the staging module used in Phase 1 is also shown, due to its narrow width, the staging track could utilize wall brackets to support a plywood/Homasote subroadbed.

Mike also likes using a plate joiner and biscuits for joinery. Biscuits, glue and a nail gun make short work of construction but "glue and screw" techniques could also be used. Plywood (3/8" or

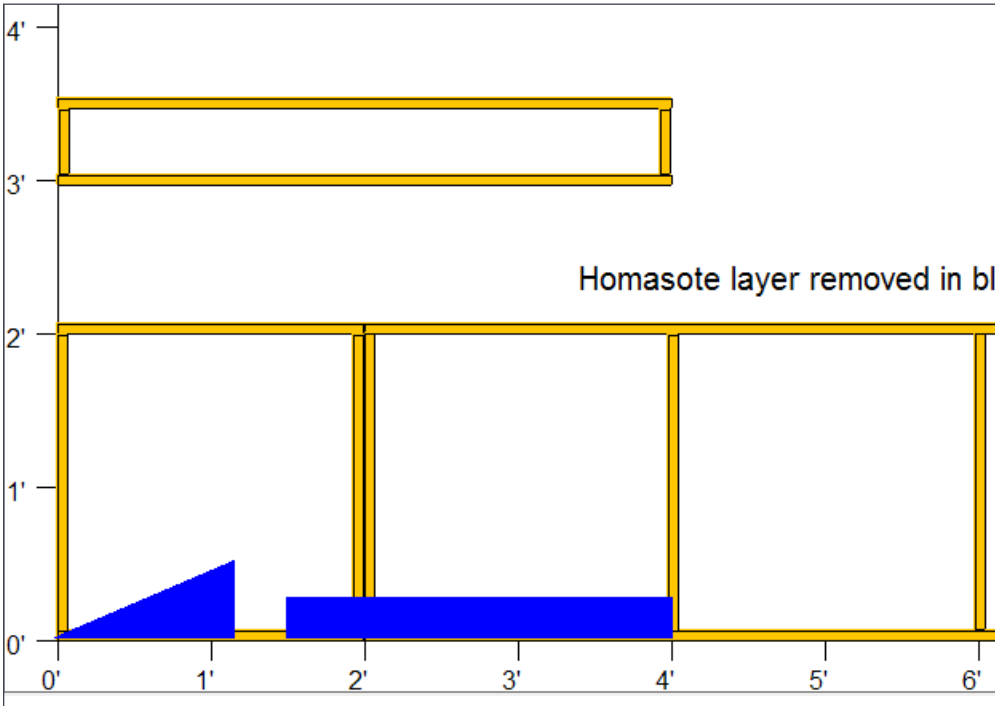

ONE MODULE CHALLENGE | 16

1/2”) or OSB can be used to cover the frame. Half-inch Homasote was used on top of the OSB with some areas removed for the water areas.

The half-inch change in height looked about right for the size ships when at high tide, but you could make the wharf level higher for larger ships. See [13] for an overview of the water area cutouts.

One advantage of a module this size is the ability to flip it on-end or upside-down when doing the wiring. Since there would only be one electrical “block” (DC or DCC), two bus wires (14- or 16-gauge wire suggested) should be run down the middle of the module, and feeder wires attached to it.

Spending an extra couple of minutes at this stage of construction making sure there is a drop to every piece of track will save you considerably more time later trying to add them when a track

joiner fails to make electrical contact.

To dress up the module, I recommend using a 6-inch wide strip of 1/8” hardboard as a fascia along the front and exposed sides. It could also be elevated near

13. Homasote was used as the sub-roadbed and to elevate the trackwork above the “water” areas. The blue areas indicate where Homasote was removed.

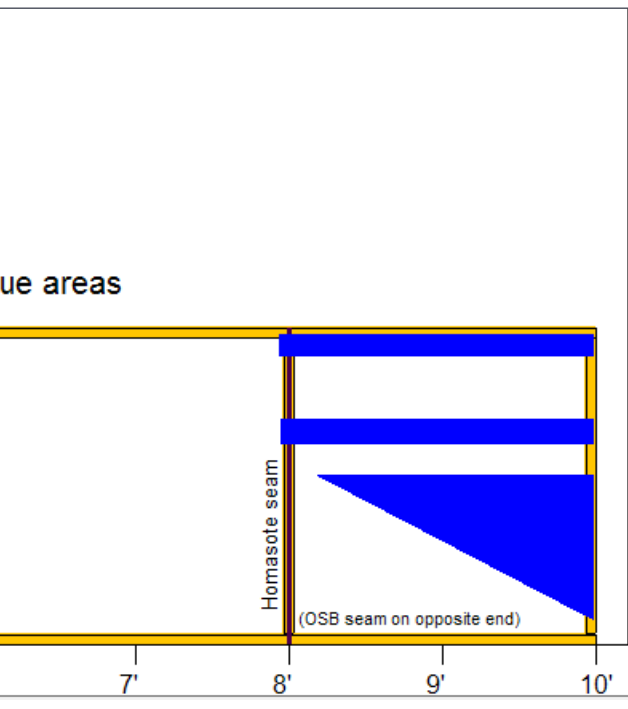

ONE MODULE CHALLENGE | 17

the end of the trackwork to prevent a car or loco from careening to the floor.

As mentioned earlier, most of the turnouts are hand-thrown using the built-in Peco over-center spring. Due to the location of the Tacoma Marine Screw Co, it would be difficult to reach

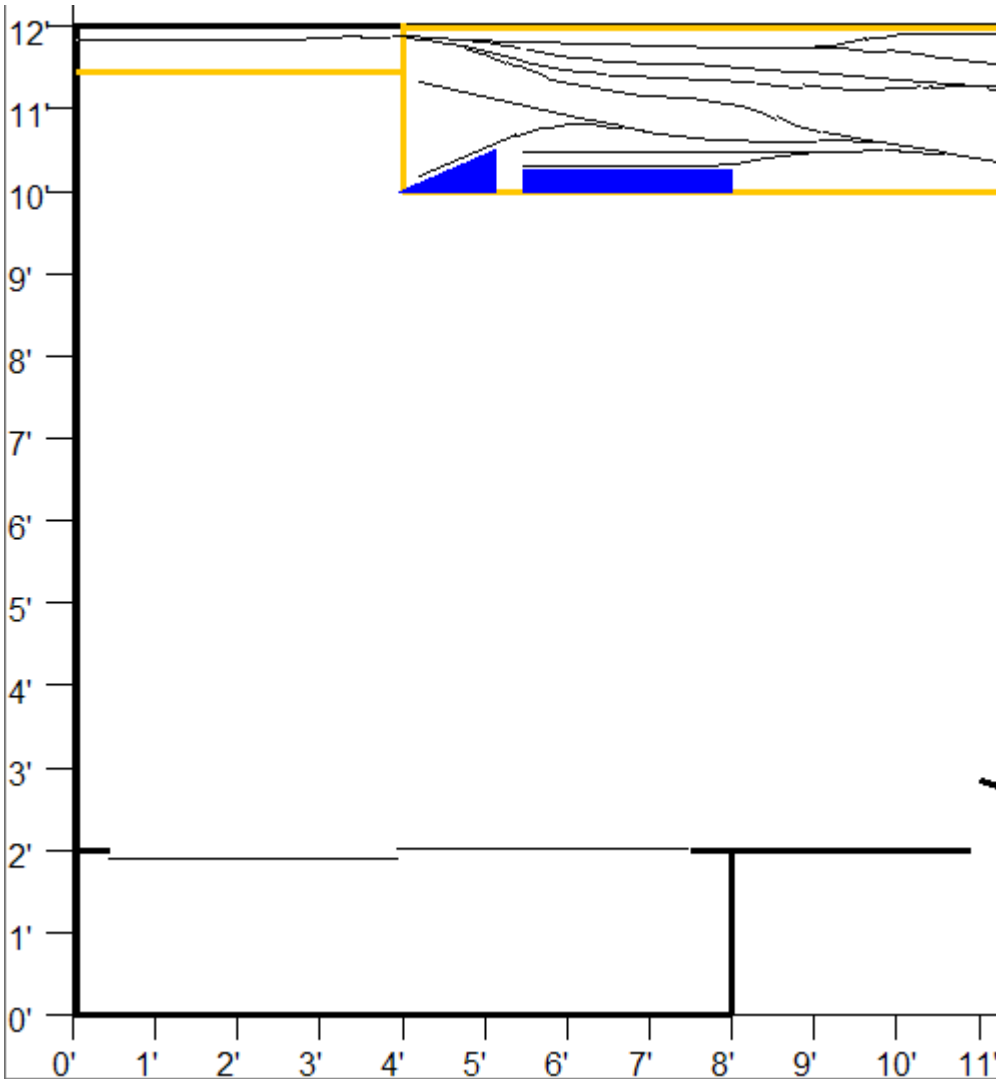

ONE MODULE CHALLENGE | 18

the turnout in the back-left corner. I installed an electric switch machine and located the controls for it on the front of the fascia.

Once the track and electrical work are completed, the module can be mounted to the wall with 3" screws into the studs on both walls. I prefer a tabletop height of 48 inches as it allows me to stand while switching, and easily reach across the module without damaging items along the front edge. Since the module is attached on two sides to the wall, only one 2" x 2" leg on the front-left corner would be needed to support the module. Due to the small size of the module and the strength of construction, the leg could be cantilevered at the 8' point to reduce the chances of hitting it with your feet.

Because my module is supported on the right side by a bookcase, I was able to put a mirror there that greatly expands the apparent size of the port [15].

Structures

With the exception of the ADM grain elevator and the oil storage tank, most of the structures on the module are kitbashed or from my scrapbox. The cranes started life as cheap Tyco overhead loading cranes, modified by trimming the platform and painting the steel structural pieces. The cranes themselves came from those ubiquitous Athearn or LifeLike wreck train boom cars with the crane removed from the flatcar and mounted on the Tyco legs.

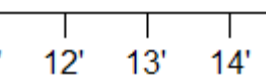
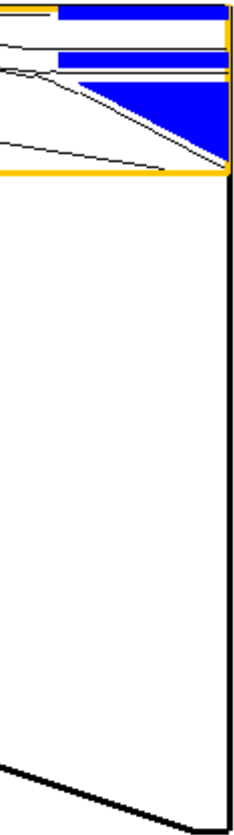

14. Phase 1 includes the initial port module and a single track staging area.



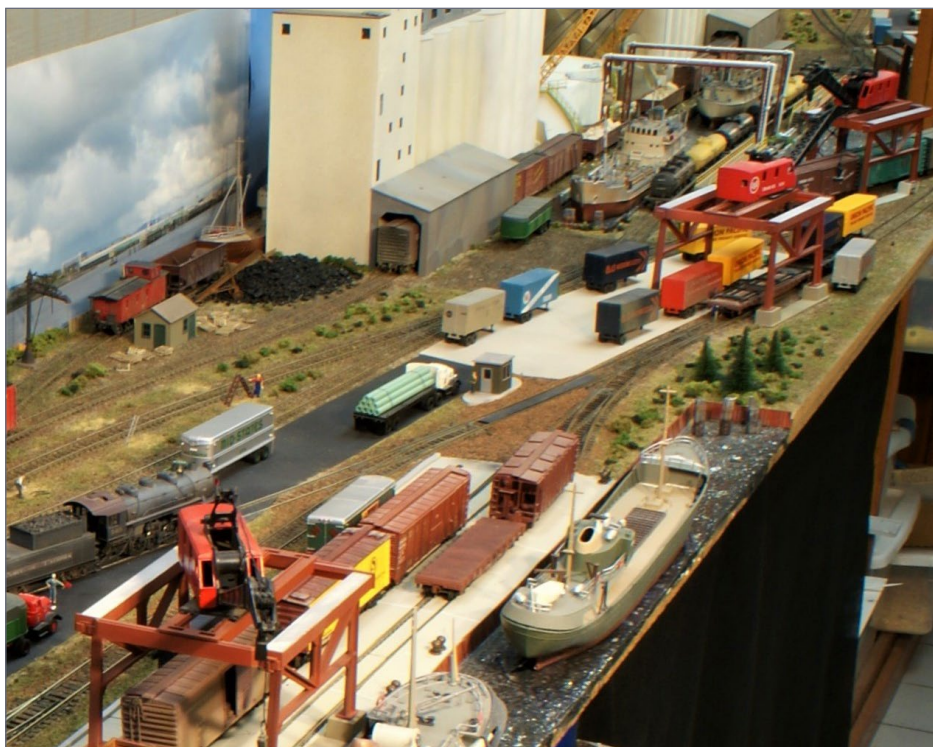

15. The use of a mirror on the right edge of the module adds depth to the port and hides the fact that the end of the module is against the wall (or a bookcase in my case).

Puget Sound Seafood is simply foam core board, cut to fit the triangular real estate it occupies. Windows and loading doors from the scrapbox are glued to the structure, which will serve until a more detailed structure is built.

I kitbashed Tacoma Marine Screw Co. from an Atlas Roundhouse kit that no longer had a place on the layout.

The bridge and pipes to carry oil over the ship canal to the storage tank are also pieces from the scrapbox, cobbled together to fit in place. The platforms serving the tank cars came from a Heljan diesel sanding platform kit, altered to fit the location.

Scenery

If majestic mountains or forested hillsides are what you want on a module, a port isn't for you. But even though the area is basically flat, a little effort is still required to get rid of the billiard table look.

I started with plain old “sandbox” sand, and spread it everywhere, letting it pile up a bit here and a little flatter there. The goal is some minor undulations. Then various ground foam colors from Woodland Scenics or Scenic Express were spread on top. Port landscaping leans towards the grungier side, so I went easy on the greens and more on the browns. After that was glued down, I ballasted the track. Again, grungy is good. I started with sand again topped lightly with cinders and some brown ballast, making sure nothing is too uniform.

The “concrete” pier surfaces and a parking area, as well as the entry road, were all made from a mystery substance I picked up



16. To add an interesting twist to switching in the port, crews are required to stop and post a flagman. The figure has a pin attached and can be inserted in the roadway or outside his guard shack.

ONE MODULE CHALLENGE | 21

years ago. It comes in white sheets about 8” by 12” and is a pliable plastic, sort of like some placemats.

I like this product because it can easily be cut with scissors, scribed to get concrete joint lines, and painted with rattle cans of gray primer and light tan. Cracks are drawn with a fine-point black pen.

Since I’m not sure what it is, thin styrene (or your favorite technique for creating paved surfaces) could be used in its place. My era featured a blacktop entry road, which is made from the same material, painted flat black, then dusted with primer gray. The contrast to the concrete pier area is appealing.

I simulated water by covering the area with drywall compound, and when nearly dry, lightly dabbing at it with a wet sponge to create the appearance of currents moving the water and producing gentle waves. When dry, I colored the “water” with cheap craft paints, starting with black-blue for deeper areas and fading a bit to a green-black near the walls. The water at berthing areas needs to be deep enough for the draft of a loaded ship, so I avoided light colors.

When thoroughly dry, I poured on Woodland Scenics Realistic Water, and brushed around to give some sheen to the water. As a final touch, I noticed my wife had some glitter in her craft supplies. As the Woodland Scenics water was drying, I lightly sprinkled a bit of glitter onto the surface. Wow! It really makes the water sparkle and reflects light like real water does.

Let’s get to work

There are five separate jobs at the Port. The five jobs worked by the Port switcher include the Grain-Fish job, which works the ADM elevator and Puget Sound Seafood, necessitating a runaround. The empty boxcars (grain was shipped in boxcars in 1962) need to go to

“I noticed my wife had some glitter in her craft supplies ... Wow! It really makes the water sparkle like real water does.”

the cleanout track area before the seafood plant is worked, giving workers time to clean out the cars to avoid a fee.

The Wharf 7 and 8 job works cars at the oil loading area and the Weyerhaeuser dock. The Wharf 9 job stays busy working two berths. The Pigs, Pallets and Screw job, handles TOFC cars and switches Port Pallets and Tacoma Machine Screw. Finally, the Rock job takes a gondola full of concrete from the old ADM silos for use as rip-rap in the bay, and spots an empty gondola.

A switchlist determines which cars are to be picked up and which are to remain on-spot to continue loading or unloading. Once all the pickups are made, the train is assembled with the locomotive at the front and a caboose bringing up the rear. The train runs to the Tacoma Belt interchange (staging).

If only a single staging track is used (as depicted in Phase 1), the operator will pull and store the outbound cars, reposition the locomotive to the head end of the train and add the inbound cars and caboose.

Once Phase 2 is added, the locomotive will uncouple, run around the train, pick up the inbound cut on the interchange track, and tack on the caboose. Cars billed to all points on the compass would go on the Tacoma Belt interchange. The Port job would return and spot cars as directed by the switchlist. It could then tie up on its service track or begin another job.

To further complicate switching I've added several additional “obstacles.” For the road crossing in the middle of the port, crews



are required to pause and deploy a flagman [16]. The engine must sound the whistle and then ring the bell while crossing the road.

During some of the jobs, a blue flag is installed on the TOFC track to indicate the cars are being loaded and cannot be moved to provide additional temporary track space [17].

Expansion

The Port module (Phase 1) is the anchor of what can become a satisfying layout set in environs of a city. Urban switching districts offer more bang for the buck per square foot of layout space and, once built, offer nearly infinite possibilities in car movement scenarios. Here is a suggestion for expansion as time, space and funds become available.

Phase 2

Phase 2 [18] expands the single staging track to a three-track fiddle yard on a simple-to-build corner module. This provides additional staging and makes the yard an operational feature of the layout.

In addition to the Belt-Port interchange track, two additional tracks represent running tracks to the Class 1 railroads. In reality, these are the fiddle tracks as described above in the Operations section but their importance as arrival and departure tracks will become even more important for the Phase 3 and 4 expansions.

Using two reailer sections per running track will ease building outbound trains. Having a nearby storage container with drawers makes it easy to add and remove freight cars.

An outbound train can be ready to go as another is inbound. And the Belt-Interchange track works just like before [19].



17. To further complicate switching in the Port, a blue flag (barely visible in front of the flatcar coupler) is installed on the TOFC track to indicate those cars are loading and cannot be moved. This reduces the amount of spare track the switching crew may use as temporary storage for cars.

Phase 3

This expansion adds a peninsula with a divider down the center and features two signature Tacoma industries in 1962 – St. Regis Paper Co. and Hooker Chemical Co. on [20]. Yep, now there’s a place for all those distinctive orange chemical cars in the fleet to start earning a living!

In addition to the peninsula, a “mainline” and a passing siding long enough for eight cars along the wall allows a runaround move. Hooker and St. Regis have their own switchers in this plan, so each switcher would make pickups in the plant and set them on an access track.

A Tacoma Belt transfer would then bring the inbound cars, exchange them with those at the plant, and return to the

ONE MODULE CHALLENGE | 25

staging area. The plant switchers would then pick up the cut and get to work spotting the inbound cars. A tail track along the front side of the yard module [21] allows the switcher to remain clear of the “main.”

Hooker was a big operation in Tacoma, but this plan pares it down to the essentials: an inside plant building where boxcars

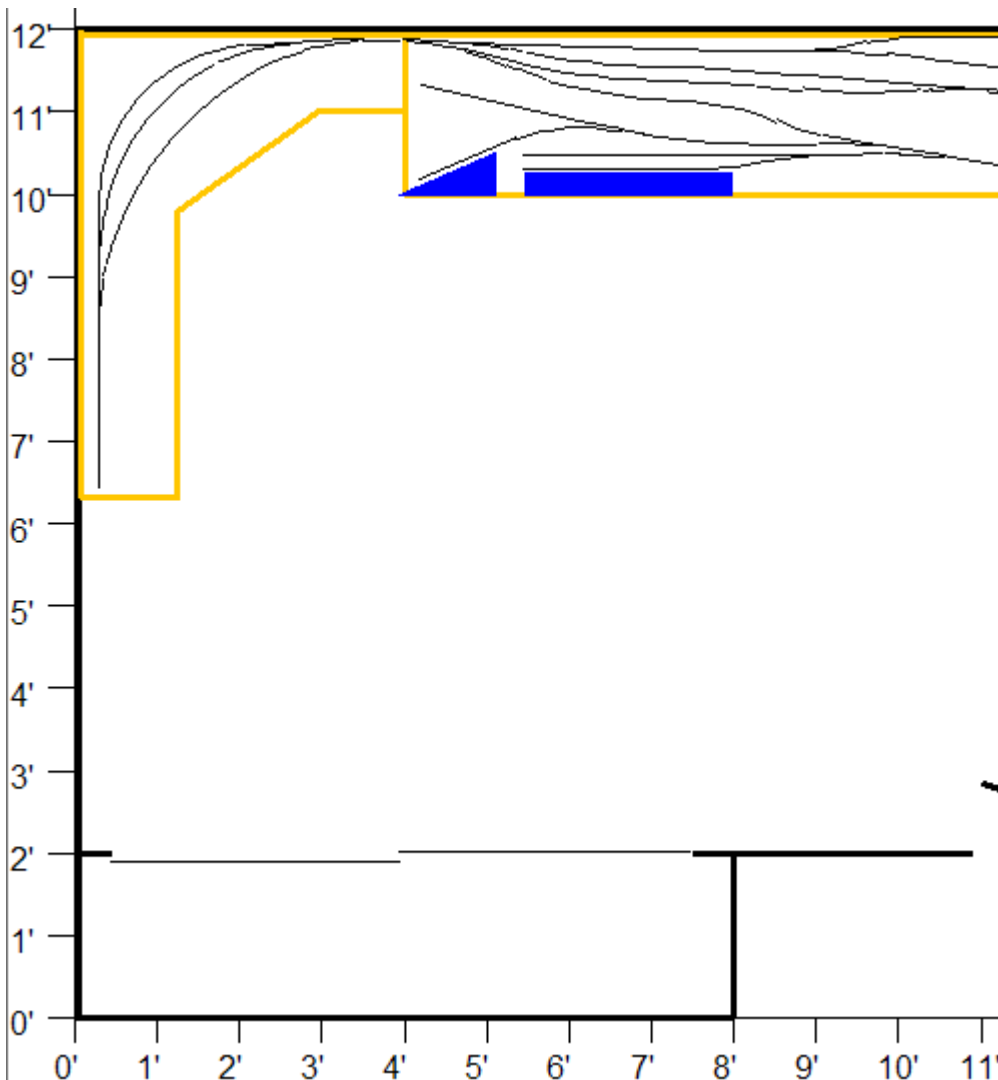

ONE MODULE CHALLENGE | 26

are loaded with product; another inside location for short “beer can” tank cars and covered hoppers; and a long loading track which can handle eight tank cars [22].

Use spots on the switch list so that certain cars need to go to certain spots to be loaded with the correct chemical, and shuffling orange Hooker cars gets real interesting [23].

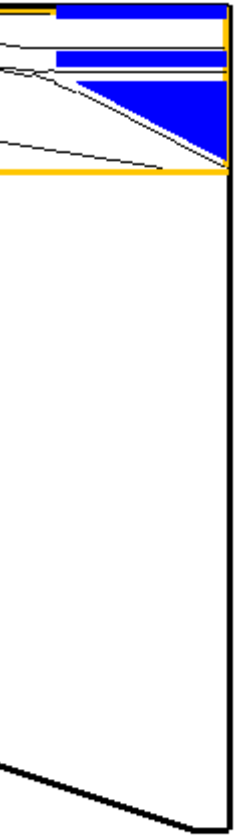

St. Regis features the tight quarters associated with a large paper mill, including a short run-around on plant trackage [26]. That’s important since the mill features both trailing and facing point spurs, and the St. Regis switcher can’t go off company property [24].

St. Regis includes two separate switching jobs. One handles coal for the power plant, as well as wood chips for the digester. The other works the remainder of the plant, which primarily made kraft paper. A nice variety of cars - 40- and 50-foot boxcars, chemical tank cars, woodchip cars, coal hoppers, and covered hoppers – all make appearances at St. Regis.

The module makes extensive use of narrow fronts and photo backdrops to maximize the appearance of a heavy industrial area in only 17 (St Regis) and 12 inches (Hooker) of space.

Phase 4

If that’s not enough switching, this addition adds even more, and makes use of the closet.

18. Phase 2 adds an enlarged staging/fiddle yard that would also allow sorting cars in the yard.

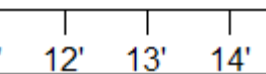



19. Staging areas don't have to be boring. Photo backdrops, a tower building, and some scenery material blends this module with the rest of the room. The Belt switcher is getting ready to head to Hooker Chemical, while in the background is the Belt-Port interchange track.

Removing the closet doors opens up aisle space and makes for a comfortable switching job [25, 27].

This switching area also adds two jobs. One job arrives and works the Heidelberg Brewery at the left, which gets boxcars and reefers. Also along the wall is Gro-Pac Produce, which offers five spots for reefers. You need to run around your train no matter how you attack the job, adding an interesting challenge.

The sidings along the front of the module utilize the concept of "industries in the aisle" so there's a lot of challenging switching without the need to model any structures! At the left side is a freight house which gets three cars. At the right are three package-forwarding businesses.



20. End view of the peninsula added in Phase 3. St. Regis Paper Plant on the right and Hooker Chemical on the left.

ONE MODULE CHALLENGE | 29

Before FedEx and UPS, freight forwarders were common, and in Tacoma many were grouped together. Coast Carloading, National Forwarding, Superior Fast Freight, and a produce distributor each get two cars, so with some needing to remain on-spot while others get pulled, it's a fun but challenging job [28].

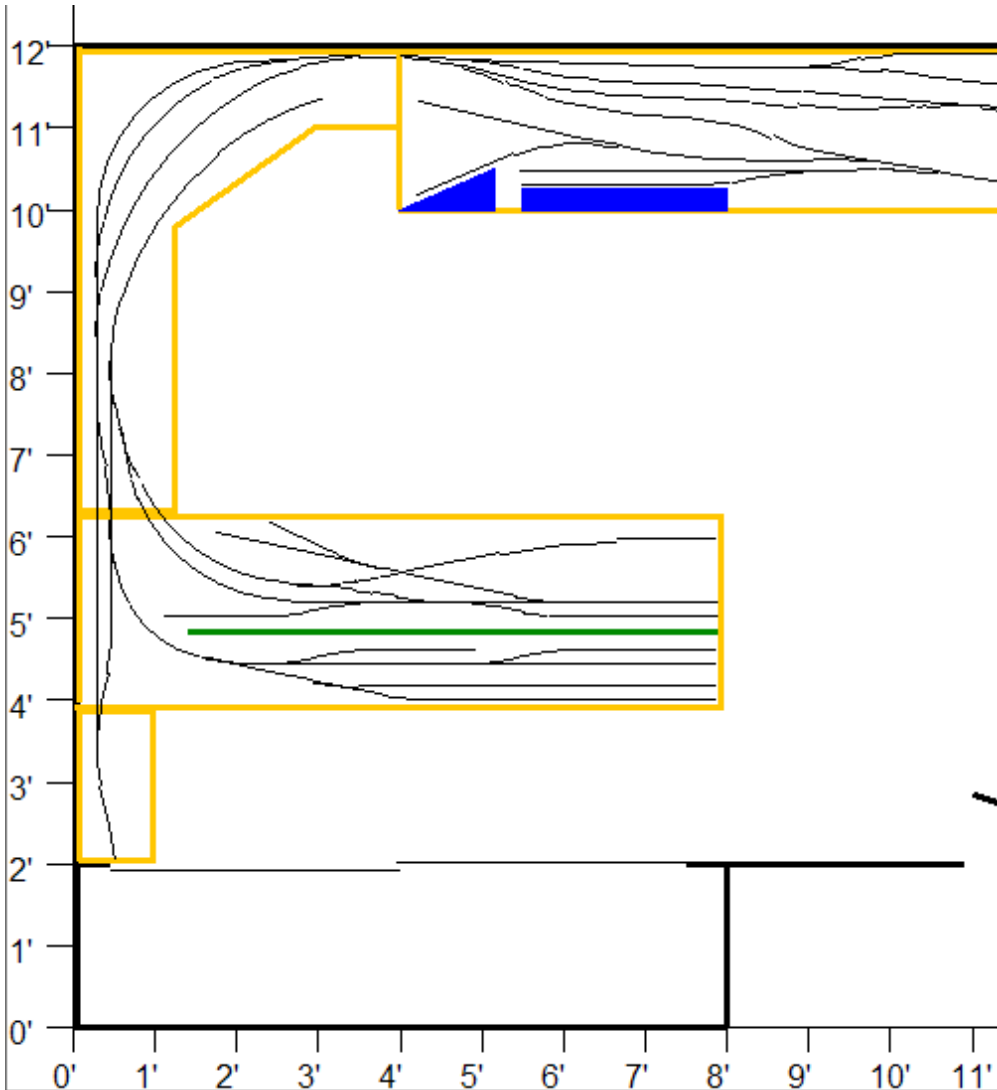

Summary

If built as planned, this railroad could easily keep four or five operators busy for hours, and with the generous aisles, they wouldn't be bumping into each other. Two-person crews of

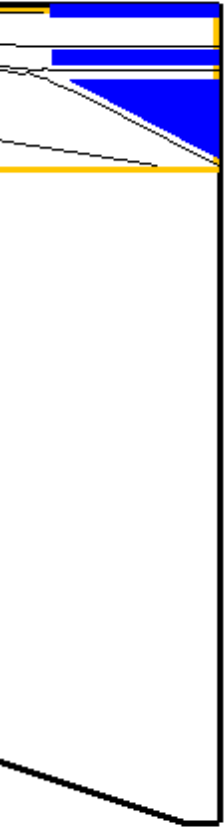

21. (Left) Phase 3 here adds a peninsula with two switching areas (the green line indicates the location of the partition dividing the peninsula). A passing siding, working tail track, and runaround would allow a crew to work either side of the peninsula without imposing on the yard area.



22. (Above) Hooker Chemical loads tank cars on the two tracks closest to the aisle and ships barrels of product via boxcars from inside the tan building and "beer can" tank cars from the brick building on the right.

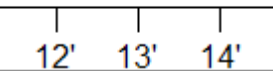

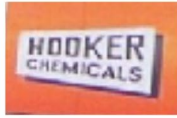

Hooker Chemical

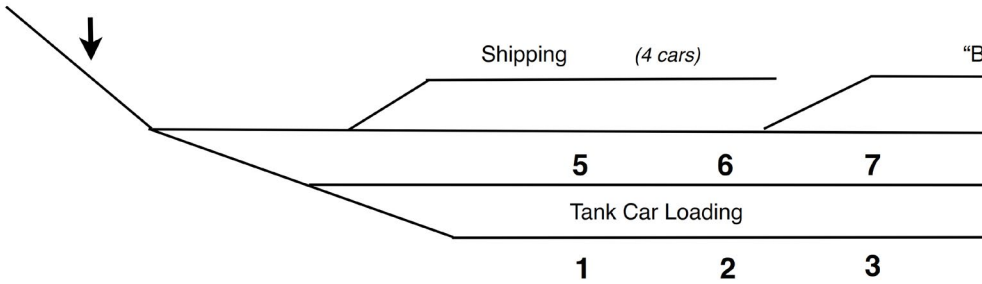

Bags Loading Dock (3 cars)

Rolls Loading (3 cars)

24. The St Regis Paper Company occupies the right half of the peninsula added in Phase 3, and has a wide variety of goods arriving and departing by rail.

als

Beer Can" track (inside) (3 cars)

8 (4 cars)

4 (4 cars)

23. This is the track configuration of Hooker Chemicals. It occupies just under half the peninsula added in Phase 3.



St. Regis Paper Co.

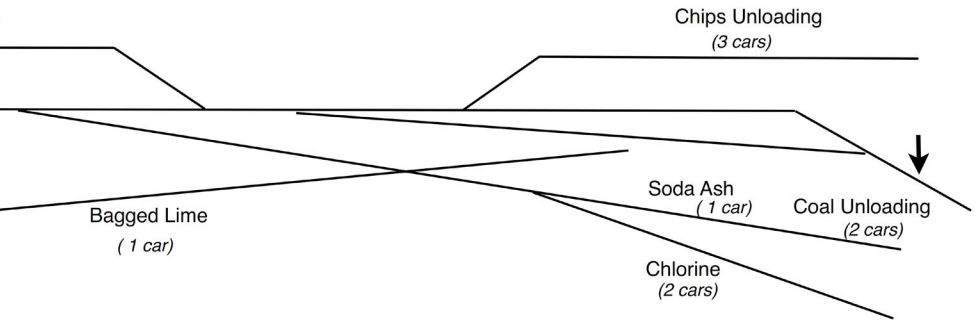

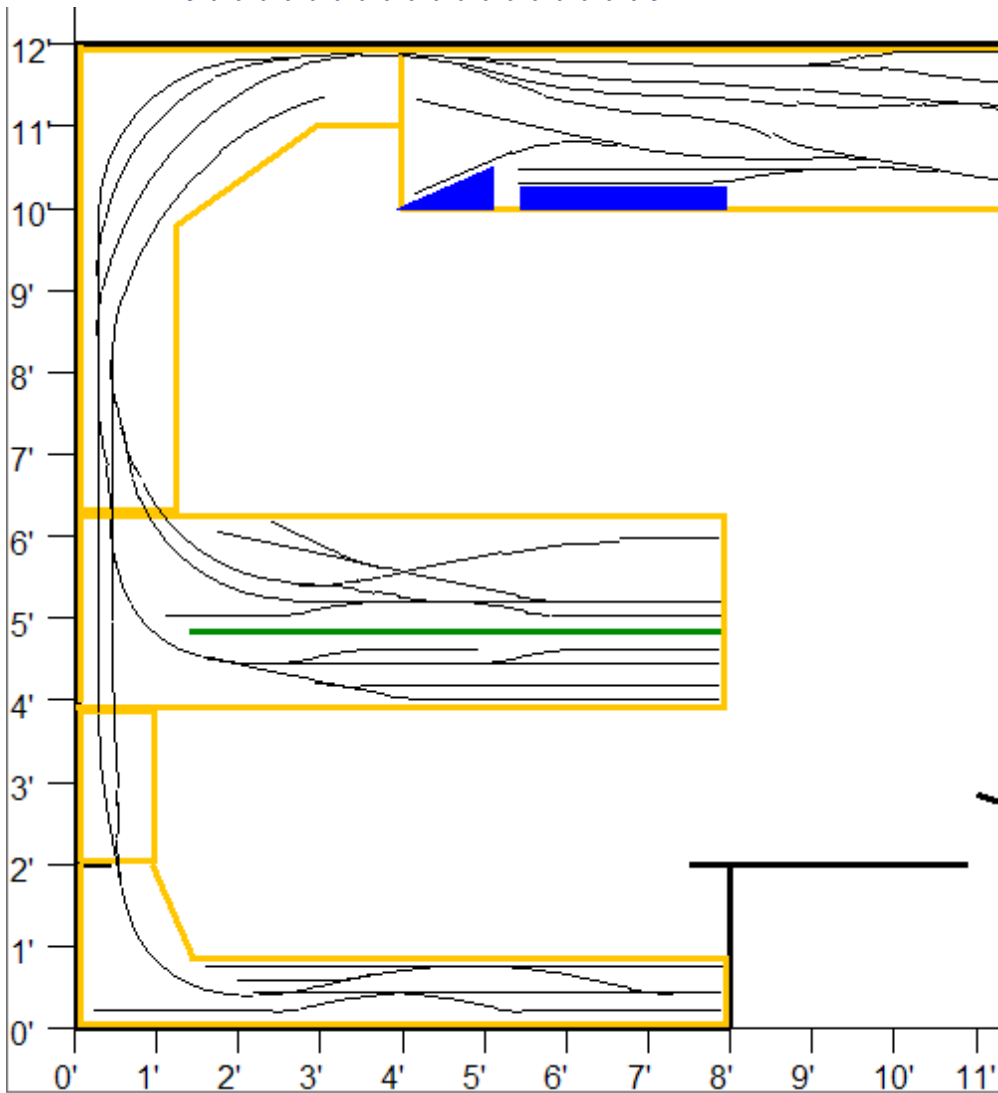

25. Phase 4 takes advantage of the closet area and adds an additional industrial area for switching. This area packs a lot of action into an seven-inch shelf.

ONE MODULE CHALLENGE | 34



conductor and engineer make working these jobs even more enjoyable, but crowding could become an issue if every job works at the same time.

The fiddle yard concept keeps things moving practically indefinitely, and staging requires only minutes instead of hours.

Whether just the port module is built, or some or all of the phases are added to the project, years of fun and enjoyment await you. Go for it!



26. (Above)The St Regis Paper Plant sends and receives cargo using five different types of cars.



ONE MODULE CHALLENGE | 35

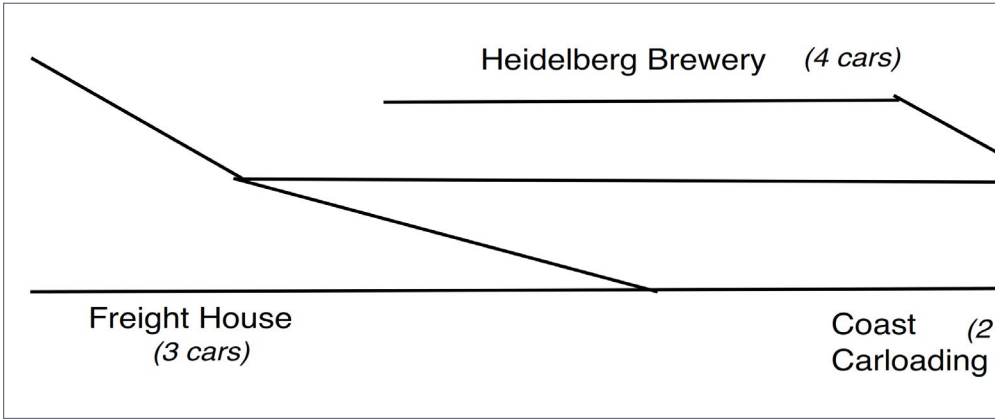

27. By “imagineering” loading docks in the aisle, seven different companies are represented on a shelf added in Phase 4 that is only seven inches wide. This module features a run-around and a number of facing- and trailing-point moves to be completed by the switching crew.



28. Lots of action on a 7-inch shelf! The Phase 4 addition located in the closet uses industry flats and unseen loading docks in the aisle to provide plenty of locations to spot cars. The numbers along the top edge of the fascia indicate those spots.

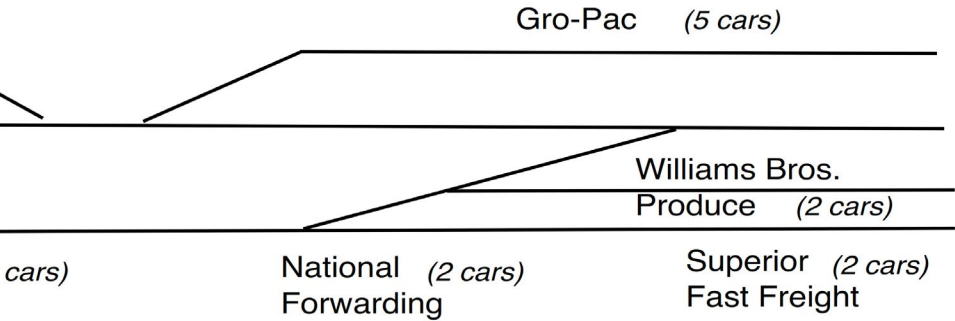

[Click here to rate or comment on this article](#)

SCOTT WILLIAMSON



Scott is a retired newspaper editor who later taught CPR classes for a hospital's education department.

The Port of Tacoma module is part of his larger model railroad focused on Tacoma, WA and the Tacoma Belt, which served four Class 1 railroads in his 1962 era. He's part of a round-robin group that

operates weekly.

Scott and his wife, Lin, live in central Ohio, and both log a lot of miles riding recumbent bicycles.



ONE MODULE CHALLENGE | 37

Benchwork Materials	Quantity	Purpose	List Price
4 x 8 ft plywood ¾ inch thick	1	Framing	\$32.00
4 x 8 ft Homasote ½ inch thick	1	Roadbed	\$24.99
4 x 8 ft OSB, ½ inch	1	Sub-roadbed	\$10.10
2 x 2 inch pine, 8 ft long	1	Leg	\$7.94
4 x 8 ft Masonite 1/8 inch thick	1	Backdrop and fascia	\$8.87
Wood glue	8 oz	Fastening	\$3.00
#10 wood biscuits	16	Fastening	\$2.22
3" Deck screws	5	Fastening (frame to wall)	\$5.97
1 ½" flathead screws	25	Fastening (OSB to frame)	\$3.39
Construction adhesive	1	Fastening (Homasote to OSB)	\$1.50
Drywall screws	25-30	Fastening (temporary – Homasote/OSB until adhesive sets)	\$1.77
Earth tone paint	1 Qt	Seal Homasote/ease covering w/scenery	\$8.78
Total			\$110.53

Structures and Ships	Make/Model	List Price
ADM Grain Elevator	Walthers #933-3022	\$54.98
Puget Sound Seafood (Scratchbuilt)	Foam core board	\$3.00
Tacoma Marine Screw Co (Kitbash)	Atlas Roundhouse #709	\$42.95
Water Column	Tichy #8006	\$4.95
Overhead Loading Cranes (Kitbash) (3)	Tyco Overhead Loader & Athearn or Like Like Wrecking Crane	\$50.00
Port Pallets Shack	Branchline Toolshed #633	\$15.95
North Sea Fishing Trawler kit	Revell #RG5204	\$21.59
Russian Spy Fishing Trawler kit (2)	Revell #H379	\$43.98
Shrimp Boat kit	Kibri #39161	\$27.99
Shell Welder tanker kit	Ark Models #40011	\$29.99
Wide Oil Storage Tank	Walthers #933-3167	\$44.98
Oil Loading Platform (Kitbash)	Heljan Diesel Sanding Platform #113	\$35.98
Total		\$376.34

ONE MODULE CHALLENGE | 38

Scenic Material	Quantity	List Price
Sandbox Sand	bag	\$3.55
Photo Backdrop	1	\$42.00
Woodland Scenics Ballast, cinder	12 oz	\$5.99
Woodland Scenics Ballast, brown	12 oz	\$5.99
Woodland Scenics turf, various shades	4	\$15.96
Craft paint, various colors	4	\$4.00
Woodland Scenics Realistic Water	1	\$23.99
Total		\$101.48

Track and Electrical	Quantity	List Price
Peco HO code 100 medium turnout, LH insulfrog	4	\$96.00
Peco HO code 100 medium turnout, RH insulfrog	4	\$96.00
Peco HO code 100 small turnout, LH insulfrog	2	\$48.00
Atlas HO code 100 Flextrack, 3 ft	16	\$100.00
Peco Switch Machine	1	\$13.00
Atlas rail joiners	3 packs	\$12.00
Atlas or Lifelike track nails	1 pack	\$6.00
No 22 feeder wire, 25 feet	1	\$6.00
No 14 bus wire, 25 feet	1	\$7.00
DC or DCC System	1	As Desired
Total		\$384.00



Click here to rate or comment on this article





**Come join us for a
Colorado Narrow
Gauge Adventure!**

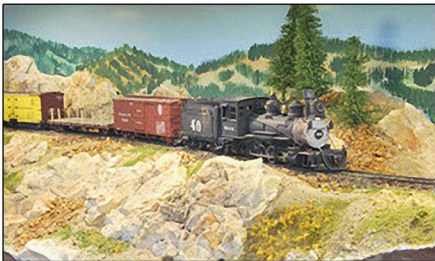

**37th National
Narrow Gauge Convention
Aug. 30th - Sept. 2nd, 2017
Denver, Colorado**

LEARN MORE >>



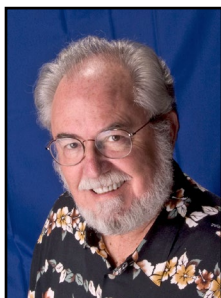

JULY NEWS

column

RICHARD BALE *and* JEFF SHULTZ



[Click here to rate or comment on this article](#)

Ralph Barger 1930-2017



Railroad historian and model railroad enthusiast Ralph Leland Barger passed away May 21, 2017. He was 87 years old. Barger was a meticulous researcher and widely recognized as an expert on passenger equipment. Books he authored include *A Century of Pullman Cars, Volumes I and II; A Century of Pullman Cars-The Palace Cars, The Business Cars of the Union Pacific Railroad, and The Baltimore*

& Ohio Dining Cars. Much of the material he amassed over the years has been donated to the California State Railroad Museum in Sacramento, where it is available for further research. Barger was active for many years in the B&O Railroad

▶ THE LATEST MODEL RAILROAD PRODUCTS, NEWS & EVENTS



Historical Society where he served as a researcher, lecturer, treasurer and vice president.

After graduation from high school Barger enlisted in the U.S. Army where he rose from private to lieutenant colonel. His 22-year military career included several tours in Germany, teaching at West Point, and five campaigns in Vietnam. He is survived by his long-time companion Peggy Compton, three children, and five grandchildren. Interment will be at Arlington National Cemetery with full military honors. Ralph's brother, J.P. Barger, is also well-known as a railroad historian and entrepreneur ...

Rocky Mountain Hobby-Expo

A new hobby industry/consumer trade show is scheduled to hold its inaugural event this fall in Denver, CO. The Rocky Mountain Hobby-Expo will be held on October 28-29, 2017 at the Denver Mart convention facility. In addition to a wide range of hobby supplier and manufacturers displays, the consumer-oriented event will feature workshops and hands-on demonstrations for both new and experienced hobbyists. The stated mission of the Rocky Mountain Hobby-Expo is to promote and educate the public about family-oriented hobbies by providing information and inspiration to new and existing hobbyists. It is meant to provide a cost-effective medium for hobby manufacturers to reach retailers and consumers through a single coordinated event. Interested exhibitors should direct their inquiries to Jim Marski, Executive Director of the Rocky Mountain Hobby-Expo, at 303-345-5031 or email at Hobby-Expo@outlook.com ...



NEW CLUB CARS



The Atlantic Coast Line & Seaboard Air Line Railroads Historical Society is celebrating the SCL's 50th anniversary with the release of

a custom decorated PS-1 boxcar with a cushion underframe. The Kadee HO scale ready-to-run model replicates one of the first prototype cars repainted for SCL - ex-ACL class O-34-A. Two road numbers are available. To order go to aclsal.org/index.htm.

.....

NEW PRODUCTS FOR ALL SCALES

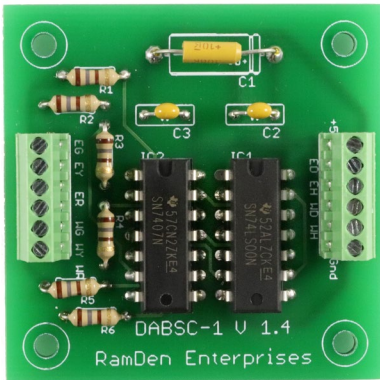

Model Railroad Control Systems has announced the availability of Dennis Drury's Dual Automatic Block Signal Controller (DABSC). The DABSC is a hardware-only solution for implementing a prototypical Automatic Block Signaling (ABS) system. The board controls two blocks of three-aspect (Green-Yellow-Red) signals and can

be used in either single track or double track applications. It is compatible with three-lead common anode signals. For complete details visit modelrailroadcontrolsystems.com.

.....

Motrak Models has introduced a series of laser-cut Masonite hard-board paint racks. Each rack is customized for the type of paint bottle





it holds, and will hold between 17 and 22 paint bottles. Racks are available for 2 oz. acrylic craft paint bottles, 2 oz. Scalecoat paint bottles, 1/2 oz. Model Master/Floquil paint bottles, and 1 oz. Floquil/Tru-Color/Polly Scale bottles. Each unassembled rack comes with five pre-drilled holes for wall mounting, and while the racks will sit on a flat surface, they are not stackable. The individual racks are 19.25 inches long, 4.4 inches wide, and

either 5.5 or 4.5 inches tall, depending on the product. For more information visit motrakmodelsusa.com.

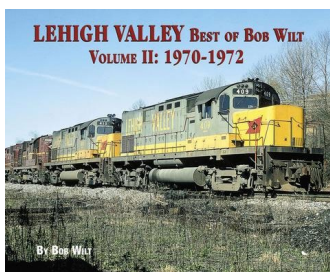
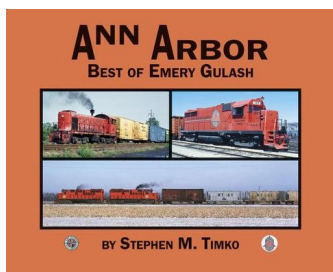

New softcover books available from **Morning Sun** include *Ann Arbor - Best of Emery Gulash, Freight Car Color Portfolio*

#1: *ACL-GN, The Work of Paul C. Winters 1960-80*; and *Lehigh Valley, Best of Bob Wilt Volume 2: 1970-1972*. Newly released eBooks include *Lehigh & Hudson River*, by Robert J. Yanosey; and *Santa Fe's Valley Division – The Last Two Decades*, by Ed Mackinson. For additional information visit morningsunbooks.com.

Speedwitch Media has announced the availability for pre-order of the last installment in the *Focus on Freight Cars* series, *Volume Eleven: Express and Head-End Cars*. For more information visit their website at speedwitchmedia.com.

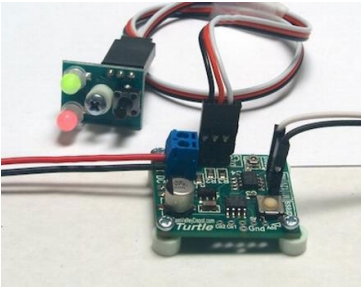

Tam Valley Depot has introduced The Turtle, a stall motor driver and DCC decoder capable of driving a Tortoise switch machine as well as other stall-motor based switch machines including Switch Masters, Cobalt, and higher current MP1 and MP5 units. For complete details and ordering instructions visit tamvalleydepot.com.

.....

O SCALE PRODUCT NEWS



3rd Rail Division of Sunset Models is selling O scale 2-rail versions of Great Northern O-7 and O-8 2-8-2 steam locomotives. The GN prototypes were among the heaviest and most powerful

Mikado-type locomotives built. Details worth noting on the handcrafted brass models are the Glacier Green livery, the huge Vanderbilt tender, the fully detailed backhead, and GN's signature dual air pumps mounted on the smoke box front. The production run included 3-rail versions which are now sold out. For additional information visit 3rdrail.com.

.....

Atlas O has scheduled the release of two new freight cars during the fourth quarter of this year. The O scale ready-to-run models include an ACF 8,000 gallon Type 27 riveted tank car. Decorating schemes will be TIDX-Tidal Refining, SHPX-Hooker



JULY NEWS | 6



Chemicals, CYCX-Peerless Oil, NATX-Rohm & Haas, and ACFX-St. Louis Independent Packing.

The second model coming from Atlas O late this year is a Trainman series PS-2 triple-bay covered hopper. The model is based on a prototype Pullman-Standard introduced in 1952 when they added a third hopper to their original twin-bay design. In addition to the ASRX-Domino Sugar scheme shown here, the ready-to-run model will be available for Gulf, Mobile & Ohio; Erie Lackawanna, Soo Line, Union Pacific, and Wabash. All Atlas O rolling stock is available for 2-rail or 3-rail operation.



Atlas O is also introducing a handcrafted O scale lighting system. Expected to arrive in the third quarter of this year, the system includes 22 different street, park, and building lights. Features include brass construction, LED light sources

with included resistors, and a quick-fit base system. For additional information contact a dealer or visit atlaso.com.

Bachmann has released two versions of an 18-foot On30 scale caboose. The model is available as a logging caboose (sans cupola, above) with data only in red, yellow and MOW gray. The same caboose with an offset cupola is available decorated for White Pass & Yukon, Durango & Silverton, and in oxide red with data only. Both versions of the ready-to-run caboose come with

JULY NEWS | 7



metal wheelsets and E-Z Mate Mark II couplers that are compatible with Kadee and other popular knuckle couplers. For additional information contact a dealer or visit bachmann-trains.com.



Woodland Scenics has introduced the Old Homestead, an O scale model that depicts a small, rustic country home. The built-&-ready model is hand-painted and weathered. Details include a printed interior, rusty

propane tank, old barrels, a hound dog, and six accessory items including an outhouse and mailbox that can be positioned as desired. The building has two interior lights and one porch light that are compatible with the Woodland Scenics Just Plug® Lighting System. For additional information contact a dealer or visit woodlandscenics.com/show/Item/BR5860/page/1.

HO SCALE PRODUCT NEWS

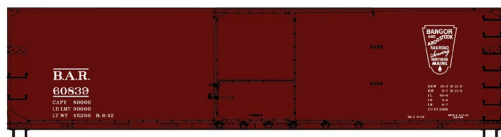

Accurail has announced new HO scale kits for several freight car models, including this Bangor & Aroostook

40-foot double-sheathed wood boxcar. The model is based on a USRA prototype built in 1918 and rebuilt during WWII.



JULY NEWS | 8



Accurail has released two new road names for its 36-foot double-sheathed wood boxcars. They are Canadian Pacific and New York, New Haven & Hartford.

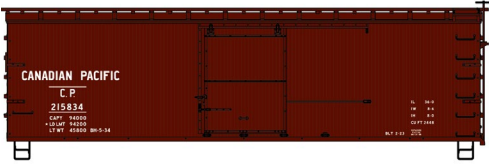

The NH car has wood ends, while the CP car received steel ends when it was rebuilt in 1934. Both cars have steel roofs and fish belly steel underframes.

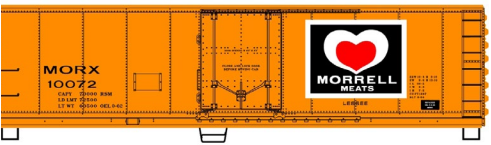

Also new from Accurail is a kit for a 40-foot steel refrigerator car with plug doors decorated for Morrell Meats.

The HO scale model is based on a prototype built in 1954 and repainted in 1962. All Accurail kits come with Accumate couplers and appropriate trucks. For more information contact a dealer or visit accurail.com.



Athearn has included a Genesis series SD70ACe/SD70M-2 in its production run scheduled for release next May. The BNSF version of the SD70ACe will be available with an early cab. A Canadian National version will have an isolated cab. Also in the release are SD70ACe units decorated for Illinois Terminal

JULY NEWS | 9

(Norfolk Southern heritage scheme), and Union Pacific. The SD70M-2 version of the modern diesel will be available decorated for Citi Rail Leasing and First Union Rail.



Also due next May are Genesis series GP7/9 locomotives decorated for Santa Fe, and ex-Northern Pacific units with 36-inch radiator fans decorated for Montana Rail Link.

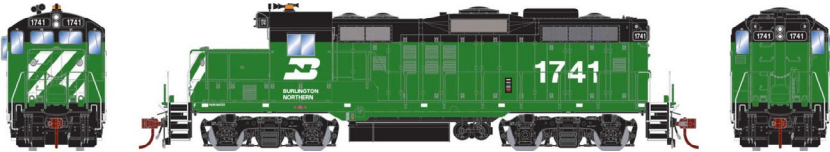

Three Burlington Northern schemes will also be offered including an ex-Northern Pacific locomotive with a chopped nose. All Genesis sound-equipped locomotive models feature an onboard DCC decoder with SoundTraxx Tsunami2 sound. The sound unit will operate on both DC and DCC layouts. DC-only models are DCC-ready with both 8- and 9- pin connectors to simplify installation of an after-market decoder.



Athearn's May schedule includes the release of a 50-foot 5277 cu. ft. boxcar fitted with a 10-foot PS waffle door. Road names will be ATSF (ex-Railbox), Railbox, Canadian National, Detroit & Mackinac, First Coast Railroad (ex- Golden Triangle), and SL-SF Frisco.



JULY NEWS | 10



A General American 65-foot 6-inch mill gondola is also set for release in May. The HO scale Ready-to-Roll model features interior details, separately applied wire grab irons, and working drop-ends. In addition to the Wabash version shown here, road names will be Baltimore & Ohio, Central of Georgia, Chicago & North Western, Chesapeake & Ohio, SSW-Cotton Belt, and Rock Island.

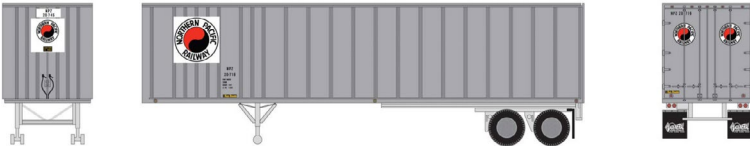

Intermodal equipment expected from Athearn next May includes this 40-foot exterior post trailer. Road names will be Northern Pacific, Santa Fe, Bangor & Aroostook, Pennsylvania, Penn Central, and Reading.



Athearn's May 2018 schedule concludes with a 1955 Ford F-100 panel truck that features a separately applied steering wheel, clear window glazing, and rubber tires.

The truck will be available in several colorful decorating schemes including Ford Motor Company (white), MOW (orange), Police (black & white), Food Market (red & white), Plumbing Service (blue), and Civil Defense (blue and white).

.....

Roundhouse Brand products scheduled for release next May include a 36-foot wood boxcar with truss rods, a horizontal

JULY NEWS | 11



brake wheel mounted on a vertical shaft, and 50-ton arch bar trucks with machined metal wheelsets. In addition to the New York Central scheme shown, road names will be Mississippi Central, Maryland & Pennsylvania, Pacific Electric, Virginia & Truckee, and three Southern Pacific schemes.



Roundhouse also plans to release a PS-2 twin-bay 2003 cu. ft. covered hopper car in May. The assembled HO scale model will have photo-etched roof walks, eight round loading hatches, and plain-bearing Bettendorf-style trucks with machined metal wheelsets.

Road names will be Boston & Maine, Conrail, Great Northern, Soo Line, Western Pacific, and Pittsburgh & Lake Erie. For additional information on all Athearn and Roundhouse brand products contact a dealer or visit athearn.com.



Atlas Model Railroad Company plans to

release HO scale versions of Alco RS-32/36

diesels in new paint schemes and new road numbers during the fourth quarter of this year. Road names for the 2,000 hp RS-32 will be Chicago & North Western, Central Vermont, and Lamoille Valley.



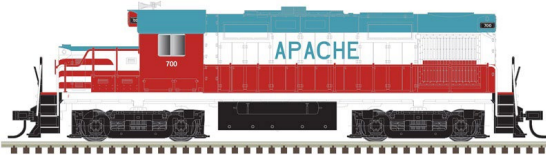

The physically identical 1,800 hp RS-36 locomotive will be available decorated for Apache, FNM-Ferrocarriles

Nacionales de Mexico, Ontario Central, Norfolk & Western, and Livonia, Avon & Lakeville. Undecorated versions will be available with and without dynamic brakes. Both DC and DCC versions of the HO scale ready-to-run locomotives will be available. Atlas Master Silver Line DC models will have an NMRA 8-pin plug for an aftermarket decoder. Master Gold Line DCC models will come with a LokSound Select Dual-Mode decoder for operation on DCC as well as on DC layouts.



A new production run of kits for an Atlas Trainman series 1937 AAR 40-foot boxcar is scheduled for release during the fourth quarter

of this year. The economy priced kit features molded on ladders and grab irons and a one-piece underframe. Road names will be Atlanta & West Point, Canadian Pacific, Erie Lackawanna, Great Northern, Norfolk Southern, Western Maryland, Union Pacific, and New York Central. An undecorated kit will also be available.



Atlas has scheduled a new run of HO scale cylindrical covered hopper cars for release during the first quarter of 2018. The Atlas Master Line model is

based on a new tank-style design ACF introduced in 1961. Cars

JULY NEWS | 13

with triple-bays will be available for Seaboard System, Conrail, El Rexene Plastics, Jersey Central, Shell, and Tenneco.

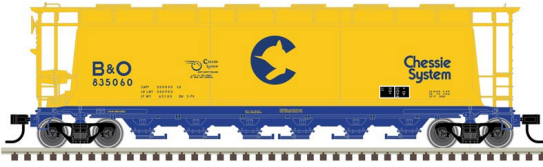

A similar car with six discharge bays will be produced for Chessie System (B&O), and Texas & Pacific. For

additional information on Atlas products contact a dealer or visit atlasrr.com.



Bachmann's latest version of the class GS4 4-8-4 steam

locomotive is available with the Sound Value SoundTraxx 16-bit polyphonic steam package that includes exhaust chuff, short and long whistles, bell, air pump, and steam release. Additional features include a dual-mode NMRA-compliant decoder, operating headlight, and E-Z Mate Mark II couplers that are compatible with Kadee and other popular knuckle couplers. The HO scale ready-to-run model is available decorated in Southern Pacific's Daylight color scheme and in the red, white, and blue Bicentennial scheme shown here. For additional information contact a dealer or visit bachmanntrains.com.

Bowser Manufacturing sells a selection of specialized kits to retrofit Bowser and old Stewart diesel locomotive chassis for DCC and sound. For details visit bowser-trains.com/history/pschassis.html.

Bowser is accepting reservations through the 14th of July for a February 2018 release of 40-foot steel boxcars. Road names for the HO scale ready-to-run models will be Arcade & Attica,



JULY NEWS | 14



Buffalo Creek, Canadian Pacific, CP Rail (PacMan scheme), Delaware & Hudson, and Erie Lackawanna.



Additional road names include Ontario Northland, Penn Central, Rock Island, New Haven,

New York Central, and WAG-Wellsville, Addison & Galetton. For more information on all Bowser products contact a dealer or visit bowser-trains.com.



Broadway Limited is selling both pre-1946 and post-war versions of Pennsylvania Railroad 2-8-2 class L1 Mikado steam locomotives.

The prototype L1 was the predecessor to PRR's class I1sa and the M1a/b locomotives and shared the same boiler as the Pennsy's famous K4 Pacifics. The HO scale ready-to-run models feature BLI's Paragon3 sound system and puffing smoke synchronized with exhaust chuff. Features include a golden white LED headlight and rear light, engineer and fireman figures installed in the cab, heavy diecast chassis, front and rear metal knuckle couplers, and positionable cab roof vents.

BLI has also officially announced their Norfolk & Western Class J 4-8-4 locomotive in two versions with several road numbers. The Class J, including N&W 611 which survives today in excursion



service, was perhaps the pinnacle of Norfolk & Western's steam development, featuring lightweight connecting rods, streamlining, and roller bearings

on all wheels and rods. They were used to haul the N&W's premier passenger trains as well as Southern Railway passenger trains on the N&W. The BLI model will be available with both flat and rounded tender decks as well as solid or spoked leading truck wheels. Unlettered versions of the flat tender deck with solid wheels and the round tender deck with spoked wheels will also be available. Flat deck tenders will be equipped with Class J tender trucks and round deck tenders will have Class A trucks. The #611 Museum version will come equipped with single side rods. All other models will have double side rods. The bell position will be road-number specific. All models will be equipped with Paragon3 sound systems and have a recommended minimum radius of 22 inches. For complete details contact a dealer or visit broadway-limited.com.

.....



Con-Cor has introduced a Greenville 100-ton triple-bay coal hopper decorated as Trump 100 – Liberty Coal. The HO scale ready-to-run model marks

President Trump's first 100 days in office and joins Con-Cor's collector series that includes previously issued cars celebrating presidents Clinton and Obama. A realistically cast resin coal load is included. A display version of the new car comes with a section of Bachmann track. For additional information visit con-cor.com/website/product-category/collector-series.

.....





Digital Fox is selling a kit for an HO scale Pullman-Standard 4750 cu. ft. covered hopper decorated with a

CSXT patch on an ex-Chessie System car that was originally a B&O car. The kit is available in four different numbers. The model was produced by Accurail and includes Accumate (Kadee compatible) couplers and appropriate trucks with Delrin wheelsets. For additional information visit digitalfox.com.

.....



ExactRail is now selling an HO scale Southern Pacific 65-foot 100-ton class

G-100-22 mill gondola. The ready-to-run model replicates a prototype introduced by Thrall Car Manufacturing in 1974. Features of ExactRail's Platinum series model include wire grab irons, brake rods, brake cylinder lever hangers and tie downs; metal top chord tie-downs, an etched brake step and ACI plate. The car comes with Kadee #158 couplers and rides on appropriate 100-ton trucks with machined metal wheelsets. ExactRail is offering the model in the 1974 as-delivered paint scheme in nine road numbers. For additional information visit exactrail.com.

.....



InterMountain Railway has released a GP10 diesel locomotive decorated for a wide range of regional railroads including

JULY NEWS | 17

four different paint schemes for Illinois Central / Illinois Central Gulf. The HO scale ready-to-run model is based on retired GP7 and GP9 locomotives that Illinois Central rebuilt in the 1970s in their Paducah shops.



Additional road names are Chicago, Central & Pacific; Midsouth, Conrail, Iowa Interstate, ADMX, Arkansas-Oklahoma,

Precision, Twin Cities & Western, Farmrail, Paducah & Louisville, and U.S. Army. The model features numerous road-specific details such as Horst air filters, horizontal nose headlight, extended front tool boxes, and engine access roof hatches. Non-sound versions of the ready-to-run model will be fitted with an ESU LokPilot DCC decoder. Sound units come with an ESU LokSound Select DCC decoder.



InterMountain is taking dealer reservations for a future release of 4750 cu ft triple-bay outside

braced covered hoppers and Canadian-style cylindrical covered hopper cars with four discharge outlets. Road names for cylindrical hoppers include ALNX Alberta, ALPX Alberta, CNWX Canadian Wheat Board, Ferrocarriles Nacionales De Mexico, and Santa Fe (ex-Koppel).



InterMountain will offer this triple-bay covered



hopper decorated for Burlington Northern, CSX, Illinois Central Gulf, BLMR Grain Train, Klemme, GRPX General Chemical,

NAHX Garvey Elevators Inc, PTLX FMC, and Union Pacific. For additional information on all InterMountain products contact a dealer or visit intermountain-railway.com.

.....

Kadee is developing a 40-foot ATSF PS-1 boxcar with a 6-foot Youngstown door for release in November. The ready-to-run model will be based on a Santa Fe prototype built in 1950 and repainted in 1980.



Also scheduled for release in November is a 50-foot PS-1 boxcar equipped with a 10-foot Youngstown corrugated steel door.

The model follows a Glacier Green prototype built in 1966. Both of the new HO scale models will have Kadee #2100 knuckle couplers and two-piece self centering trucks.

Also in the development stage is a special Christmas car which for 2017 will be a twin-bay open hopper car decorated in holiday silver. For more information on all Kadee products contact a dealer or visit kadee.com.

.....

Monster Model Works is selling a kit that builds into a brick Freight Yard Office. The HO scale version is based on a structure located in the Bangor yard facility of the Maine Central Railroad.

JULY NEWS | 19



The kit features 3D laser-engraved aged American Brick walls and corners, laser-cut door, laser-cut peel & stick windows with glazing, pre-cut bracing, and 3D printed stairs. The assembly instructions include several weathering tips. The

assembled structure is 5 inches high and has a footprint of 8 x 2.75 inches. For more details including ordering instructions visit monstermodelworks.com.

.....

Rapido Trains has announced that the projects to produce a HO scale F9B diesel locomotive and the steam generator car have been cancelled. In making the announcement, Rapido president Jason Shron said the tooling used for previous runs no longer meets his company's standards and must be redone. Unfortunately the level of pre-production reservations will not economically support any significant retooling. In a related issue, Shron noted that Rapido is now working directly with their tooling production company rather than through a middle agent as they have done in the past.

.....



Tangent Scale Models has released a new production run of its highly-regarded GA 3500 cu. ft. Dry-Flo covered hopper.

The HO scale model replicates a prototype built by General America in 1959. The ready-to-run models available in this release all have road-specific details that are correct for each paint scheme. Road names include GACX Diamond Sugar – Montreal (above), GACX Quebec Iron & Titanium, CB&Q in original gray, and CGW as a 1977 Clinton repaint.



JULY NEWS | 20



Additional cars in the release include a Burlington Northern C&S repaint with the same misspelling that appeared on the prototype car (left). Completing the

release is a Missouri Pacific car in original gray from 1959, and a 1972 Penn Central repaint of a former PRR car. An undecorated model is also available. For more information visit tangentscalemodels.com.

.....



VoltScooter Models has developed a collection of HO scale 3D printed items for detailing orchards and citrus groves.

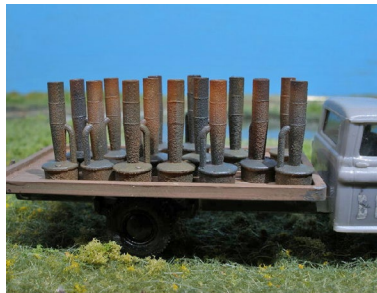

Items include empty lug boxes, orchard ladders, orange shipping crates, smudge pots, and other field accessories. For additional information visit shapeways.com/shops/voltscooter?section=HO+Scale&s=0.

.....

Walthers is quoting a January 2018 release date for an upgraded version of EMD's SW1200 diesel switcher. The HO WalthersProto scale model will feature variations in several road specific details such as air horns, antennas, headlights, spark arrestors, and pilot footboards. Road names will be Canadian National (AAR type A

JULY NEWS | 21



Photo courtesy of Don Jaworski

trucks with plain bearings, 600 gallon fuel tank), New Haven (Flexicoil trucks with roller bearings, 600 gallon fuel tank), and Great Northern (Flexicoil trucks with roller bearings, 980 gallon fuel tank).



Photo courtesy of Sid Vaughn

The production run also includes Illinois Terminal and Denver & Rio Grande Western locomotives. Rio Grande will have AAR type A trucks with plain bearings and a 930 gallon fuel tank

and the IT model will come with plain bearing Flexicoil trucks, a 930 gallon fuel tank and exposed air cooler coils. An undecorated version of the SW1200 will also be available. The model will be available for standard DC operation and with LokSound Select and DCC decoder.



Walthers anticipates the arrival of six new paint schemes for their WalthersMainline

59 foot NSC 4550 cu. ft. cylindrical hopper at the end of July. Road names include Heritage Fund ALNX, Heritage Fund ALPX, Canadian Wheat Board CNWX, Koppel KPLX, Procor UNPX, and Scouler SCOX. Cars are equipped with trough or round loading hatches as appropriate, with see-through running boards and detailed brake gear and end ladders. Four road numbers will be available for each road name.



Walthers has also announced a series of construction and commercial vehicle kits in their SceneMaster line. The vehicles do not follow any specific prototype but are generic representations of the type. Kits announced include a tracked excavator, dragline, truck crane, cement mixer, tracked loader, road grader, four-wheel drive farm tractor, and a heavy forklift. For additional information on all Walthers products contact a dealer or visit walthers.com.

.....

N SCALE PRODUCT NEWS



Athearn N scale models scheduled for release next May include a

36-foot wood boxcar with truss-rods and a horizontal brake wheel mounted on a vertical shaft. In addition to the Maryland & Pennsylvania scheme shown here, road names will be Mississippi Central, New York Central, Pacific Electric, Virginia & Truckee, and three Southern Pacific schemes.



A General American 65-foot

JULY NEWS | 23

6-inch mill gondola is also set for release in May. The N scale Ready-to-Roll model features interior details and working drop ends. Road names will be Baltimore & Ohio, Central of Georgia, Chicago & North Western, SSW-Cotton Belt, Rock Island, Wabash, and Chesapeake & Ohio as shown. Both the boxcar and gondola will have screw-mounted trucks.



The final item on Athearn's May 2018 production schedule is a

40-foot exterior post trailer. The model will be decorated for Santa Fe, Bangor & Aroostook, Pennsylvania, Reading, Northern Pacific, and Penn Central. For additional information on all Athearn products contact a dealer or visit athearn.com.



Atlas plans another release of its N scale Baldwin VO-1000 diesel switcher with new road names and numbers

during the fourth quarter of this year. Road names will be Elgin, Joliet & Eastern; Louisville & Nashville, Southern Pacific, Western Maryland, Western of Alabama, and Rock Island.

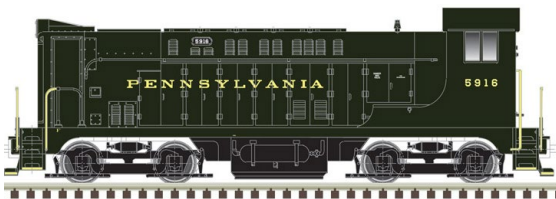

The production run will include two new road numbers for a locomotive decorated for Pennsylvania Railroad. A basic DC model will be

available as well as a DCC version with an NCE decoder.



JULY NEWS | 24

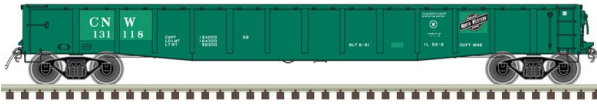

Also scheduled for release during the fourth quarter are Atlas ACF 70-ton 52-foot gondolas in new paint schemes. The N scale ready-to-run model is based on a PRR class G31 welded car. The model comes with BLMA 70-ton ASF solid bearing trucks fitted with 33-inch metal wheelsets. Multiple road numbers will be available for Chicago & North Western, Penn Central, Birmingham Southern, Delaware & Hudson, Erie Lackawanna, and Detroit, Toledo & Ironton.

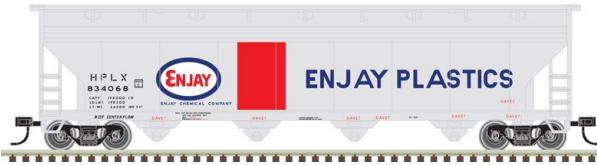

In addition to the Enjay Plastics scheme shown here, road names will be Chicago & North Western, The Andersons, Great Northern, Kansas City Southern, Rock Island, SCBX-Standridge Color Corp., and Union Pacific.



Completing Atlas's fourth quarter release of N scale models is a Trainman series 40-foot boxcar with double Youngstown doors and Improved Dreadnaught ends. Road names will

be Atlantic Coast Line, Canadian Pacific, Chesapeake & Ohio, Hoboken Shore, Southern Railway, and Soo Line as shown. All Atlas N scale models come with AccuMate knuckle couplers.

New from Atlas in N scale, the 1973 Ford F-100 Pickup Truck will come in three single color paint schemes, two two-tone paint

JULY NEWS | 25



schemes and an undecorated version. The single colors are Candy Apple Red, Wind Blue, and Winter Green, while the two-tone schemes are Mallard Green/

Wimbledon White and Sequoia Brown/Wimbledon White. These models, which feature side view mirrors, headlight glazing, and a movable tailgate, will be sold in two packs and are anticipated to arrive in late 2017. For additional information contact a dealer or visit atlasrr.com.

.....



Con-Cor has introduced a Greenville 100-ton triple bay coal hopper decorated as Trump 100 – Liberty

Coal. The N scale ready-to-run model marks President Trump's first 100 days in office and joins Con-Cor's collector series that includes previously issued cars celebrating presidents Clinton and Obama. A realistically cast resin coal load is included. A display version of the new car comes with a section of Bachmann track. For additional information visit con-cor.com/website/product-category/collector-series.

.....

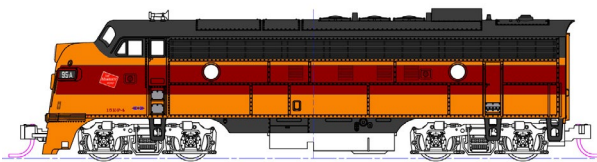

Kato USA has released locomotive artwork and a reproduction sample of the observation car for its N scale



JULY NEWS | 26

Milwaukee Road Olympian Hiawatha train set. A new shell and mechanism being tooled for the F7B reflects several details specific to the Olympian Hiawatha locomotives.



Seven unique post-1952 cars are being created including the super-dome lounge and distinctive Skytop lounge observation car. Completing the consist

are a baggage-dormitory, 48-seat coach, diner, 14-section sleeper, and 10-6 sleeper. All of the cars will be equipped with new low flange wheelsets and Kato magnetic knuckle couplers. An optional car interior lighting kit will be available as a separate purchase. Delivery of the Milwaukee Road Olympian Hiawatha is planned for later this year. For additional details, including reservation information, contact a dealer or visit katousa.com.



New N scale models from **Micro-Trains Line** include this Baltimore & Ohio

70-foot heavyweight mail/baggage car. The ready-to-run model is decorated in B&O's post-war blue and gray two-tone scheme. Micro-Trains also offers a parlor, baggage, and horse car in the



This N scale Southern Pacific twin-bay 2970 cu. ft. covered hopper car is now available from Micro-Trains.

JULY NEWS | 27



Micro-Trains is selling a three-pack of ACFX 56-foot tank cars. Each car is individually numbered.



Modern Bettendorf-style swing-motion trucks have replaced the original arch bar trucks on this 34-foot wood sheathed caboose. The N scale model follows a prototype built in the

early 1920s. For additional information on all Micro-Trains Line products contact a dealer or visit micro-trains.com.



Showcase Miniatures is selling a body shell kit for a PE Hollywood car. The design of the N scale trolley car is loosely based on a Pacific Electric prototype. The kit consists of lead-free pewter castings,

photo-etched stainless steel and brass parts, a cast resin roof, pre-cut window glazing and Microscale decals. Fully illustrated instructions for assembly and painting are included. A lighting kit is available separately. The shell is designed to fit Kato power units 11-105, 11-106 or 11-107 (not included). For additional information visit showcaseminiatures.net.



Z SCALE PRODUCT NEWS



Micro-Trains Line is taking pre-orders through July for its new Z

scale SD40-2 locomotives, the first of which will be released in March 2018. Anticipated road names include Norfolk Southern, Union Pacific (yellow & gray and Desert Storm), Canadian Pacific, Santa Fe, GATX, Southern Pacific, CSX, Canadian National, Chesapeake & Ohio, Conrail, BNSF, and undecorated. For additional information visit micro-trains.com.

.....

NEW DECALS, SIGNS AND FINISHING PRODUCTS

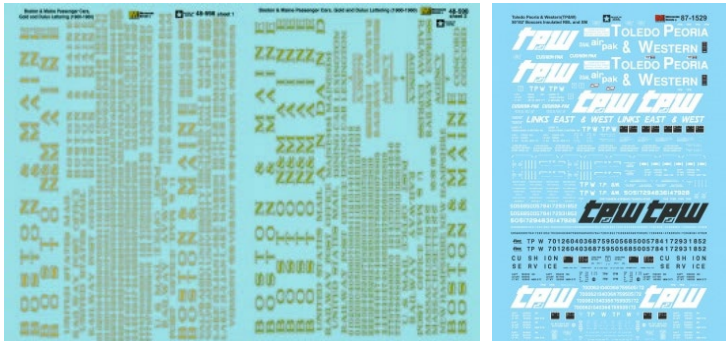

New decals from **Microscale Industries** include a dulux gold set for Boston & Maine passenger cars. The set is available in N, HO and O scale. Also new are HO and N scale lettering sets for TP&W-Toledo, Peoria & Western 50- and 52-foot insulated RBL and XM boxcars, and STSX-Staley, Tate & Lyle tank cars. For additional information contact a dealer or visit microscale.com.

.....



SEND US YOUR PRODUCT ANNOUNCEMENTS

If you are a hobby manufacturer with a product announcement, just [click here](#) and submit your announcement to us. Our web site and free magazine reach continues to grow, so get on board this new media train! ■
.....

DISCLAIMER

The opinions expressed in this column are those of the writer and do not necessarily reflect the opinion of *Model Railroad Hobbyist* or its sponsors. Every effort is made to provide our readers with accurate and responsible news and information, however, neither *Model Railroad Hobbyist* or the writer of this column can be held responsible for any inaccuracies or typographical errors that may inadvertently appear in this column.



[Click here to rate or comment on this article](#)





BRIEFLY NOTED AT PRESS TIME ...

Dan Kohlberg has released new HO scale decal sets for Burlington Northern 50-foot green boxcars, both original 1972 delivery and 1990 repaints. The decals are suitable for use on **Cannon & Company's** new Burlington Northern P-S 50-foot boxcar kit.

Also released are decals for Milwaukee Road 50-foot yellow PC&F boxcars from 1973, intended for use with Cannon & Company's new Milwaukee Road PCF 50-foot boxcar kit. For more information on these products please see home.mind-spring.com/~paducah and shop.cannonandco.net.

Microscale Industries has released HO and N scale decals for FXE - Ferrocarril Mexicano, aka the Mexican Railway auto carrier. Also new is an O scale lettering set for Burlington Northern fuel tenders and locomotive data. For additional information contact a dealer or visit microscale.com.

Morning Sun Books has released two new hardback book titles: *B&O Power in Color – Steam & Cab Units*, by Bob Withers; and *Illinois Central Gulf in Color – Across the System*, by John P. Kohlberg. For additional information visit morningsunbooks.com.

Rapido has announced that they will be producing a GMD SW1200RS model in HO scale and a TurboTrain and New Haven 8600-series coach cars in N scale. The SW1200RS and NH coaches are expected in early 2018 and the TurboTrain at a later date. We will have full coverage of these announcements in the August issue. For more information visit rapidotrains.com.

Resin Car Works has a very limited number of HO scale kits for a GATX Type 30 class 103/203 tank car. The kit consists of a two-piece cast resin tank, one-piece frame casting, and resin detail sheet. Also included are decals, Precision Scale Company brass handrail stanchions, pipe "T" and air hoses, Elgin Car Works etched tank bands and GATX tank car stirrups, and Plano Models etched tank car placard boards. The kit does not include trucks, couplers or any of the brake components, grab irons, or wire. For additional information visit resincarworks.com/kits.htm.

Walthers will release a group of 40-foot Trailmobile Dry Vans in late August. The vintage HO scale trailers represent piggy-back service of the 1970s and 80s. Features include positionable landing gear and multicolor decorating schemes. Vans include Santa Fe, Boston & Maine, Chicago & North Western (Falcon Service), Illinois Central (Piggy logo), and Conrail. The ready-to-run trailers will be available in 2-packs. For additional information contact a dealer or visit walthers.com.

.....

**Want to help keep
MRH free?**

Then *click on ads!*





SELECTED EVENTS

July 2017

(Please note that many events charge a fee. Check individual info website for details.)

CALIFORNIA, POMONA, July 8-9, The Great Train Show, at Fairplex, 1101 West McKinley Avenue. Info at trainshow.com/pomona.

FLORIDA, ORLANDO, July 30-Aug 5, NMRA National Convention, Rosen Plaza Hotel, 9700 International Drive. Info at nmra2017.org.

FLORIDA, THE VILLAGES, July 10-12, Model Train Show, at Savannah Regional Center, 1545 Buena Vista Blvd. Info at thevillagesmodeltrainclub.com.

ILLINOIS, BELLEVILLE, July 22-23, The Great Train Show, at Belle-Clair Fairgrounds & Expo Center, 200 South Belt E. Info at trainshow.com/belleville.

NEBRASKA, DESHLER, July 1-2, Train Show & Open House at Spring Creek Trains, at 4th and Race Street. Info at springcreek-modeltrains.com.

OKLAHOMA, TULSA, July 10-15, National Garden Railway Convention, at Renaissance Hotel & Convention Center, 6808 South 107th Avenue. Info at thinktulsa17.com.

PENNSYLVANIA, PENNSDALE, July 15, Lycoming Summer Train Meet, at Pennsdale Civic Center, 261 Village Road, Info at facebook.com/686526574799623/photos/pb.686526574799623.-2207520000.1497556615./1177114772407465/?type=3&th ter.

August 2017, by location

COLORADO, GREENWOOD VILLAGE, August 27-30, Rio Grande Modeling & Historical Society Convention, at La Quinta Inn , 7077 South Clinton Street. Info at rgmhs.org.

FLORIDA, ORLANDO, August 4-6, National Train Show, at Orange County Convention Center, 9800 International Drive, 276 West Center Street. Info at nationaltrainshow.org.

NEW HAMPSHIRE, CONCORD, August 20, CMRC Annual Train Show, at Everett Arena, Loudon Rd., Info at trainweb.org/cmrc.

PENNSYLVANIA, ALTOONA, August 19-20, 13th Annual N-Scale Weekend, at Jaffa Shrine Center, Broad Avenue & 22nd Street. Info at n-scaleweekend.com.

Future 2017, by location

AUSTRALIA, SOUTH ADELAIDE, OLD REYNELLA, September 7-10, 15th National N Scale Convention, at St. Francis Winery Function Centre, 14 Bridge Street. Info at convention2017.nscale.org.au.

CANADA, ONTARIO, BRAMPTON, September 30 –October 1, Brampton Model Railway Show, at Brampton Fairgrounds, 12942 Heart Lake Road. Info at bramptonmodelrailwayshow.com.

COLORADO, DENVER, August 30-September 2, National Narrow Gauge Convention, at Marriott Denver Tech Center Hotel. Info at 37nngc.com.

ILLINOIS, LISLE, October 26-28, Chicagoland RPM (formerly known as Naperville RPM), at Sheraton Hotel and Conference Center. Event hosted by Mike Skibbe and co-sponsored by NMRA. Info at rpmconference.com.



SELECTED EVENTS | 3

INDIANA, INDIANAPOLIS, September 8-9, Hoosier Traction Meet and Midwest Interurban & Streetcar Society, at Clarion Waterfront Plaza Hotel, 2930 Waterfront Parkway West. Info at hoosiertractionmeet.com.

INDIANA, SOUTH BEND, September 22-23, NMRA, Michiana Division Education & Training Conference – Modeling Like the Prototype, at McKenna Hall Conference Center. Info at michiana-nmra.org.

MICHIGAN, EAST LANSING, November 5, Lansing Model Railroad Club Show & Sale, at Michigan State University Pavilion, 4301 Farm Lane. Info at lmrc.org.

MICHIGAN, WYOMING, October 14, Grand River Valley Railroad Club Fall Train Show, at Home School Building, 5625 Burlingame Ave. Info at grandrivervalleyrrc.org/shows.html.

OHIO, MARION, August 12, Summerail 2017, at Marion Palace Theater. Info at summerail.com.

SOUTH CAROLINA, COLUMBIA, October 14, Model Train Show, at Jamil Shrine Temple, 206 Jamil Road. Info at southcarolinatradeshows.com.

UTAH, SANDY, November 11-12, Intermountain Train Expo, at South Towne Expo Center, 9575 South State Street. Info at intermountaintrainexpo.com.

VIRGINIA, VIRGINIA BEACH, September 30-October 1, 28th Annual Train Show & Sale, sponsored by Tidewater Division Model Railroaders, at Virginia Beach Convention Center, 1000 19th Street. Info at nmra-mer-tidewater.org.

2018 and beyond, by location

MISSOURI, KANSAS CITY, August 5-12, 2018, NMRA National Convention. Info at kc2018.org.

UTAH, SALT LAKE CITY, July 7-13, 2019, NMRA National Convention. Info at nmra2019slc.org. ■



**Click here to rate or
comment on this article**



**DID YOU
KNOW MRH
SUBSCRIBERS GET
FREE BONUSES?**

CLICK TO SUBSCRIBE NOW - IT'S FREE!



Clickable advertiser index – 1

[Accu-Lites](#)

[American Ltd \(San Juan\)](#)

[ANE Models](#)

[Archer Fine Transfers](#)

[Athearn](#)

[Atlas Model Railroad Co.](#)

[Bachmann](#)

[Backdrop Junction](#)

[Banta Modelworks](#)

[Berrett Hill Trains](#)

[Black Cat Publishing](#)

[Blair Line](#)

[Bowser](#)

[Canyon Creek Scenics](#)

[Clever Models](#)

[Coastmans Scenic Products](#)

[Coffman Graphics](#)

[Crow River Products](#)

[Digitrax \(2 page spread\)](#)

[ESU LokSound](#)

[Fast Tracks](#)

[Fine Scale Miniatures](#)

[Fox Valley Models](#)

[Good Deals DCC](#)

[Great Decals](#)

[HO Diesel Supply](#)

[Iowa Scaled Engineering](#)

[ITLA Scale Models](#)

[Ken Patterson.com](#)

[Lights 4 Models](#)

[Litchfield Station](#)

[Logic Rail Technologies](#)

[Main Street Heritage Models](#)

[Model Railroad Benchwork \(1\)](#)

[Model Railroad Benchwork \(2\)](#)

[Motrak Models](#)

[Model Railroad Control Systems](#)

[Mountain Subdivision Hobbies](#)

[MRH Store](#)

[Mt Albert Scale Lumber](#)

[National NG Convention](#)

[National Train Show](#)

[NCE \(2 page spread\)](#)

[Nick & Nora Design](#)

[Norfolk & Western Hist. Society](#)

[North American Railcar Co.](#)

[Pre-Size Model Specialities](#)

[Precision Design Co.](#)

[Rapido \(1\)](#)

[Rapido \(2\)](#)

[Ring Engineering \(1\)](#)

[Ring Engineering \(2\)](#)

[Rulers-of-the-World](#)

[Scale Trains](#)

[Scotty Mason Show](#)

[Sea Port Model Works](#)

[Select Model Railroads](#)

[Streamlined Backshop Services](#)

[Soundtraxx \(Blackstone\)](#)

[Southern Digital](#)

[TAM Industries](#)

[TAM Valley Depot](#)

[The DCC Shop](#)

[Tony's Train Exchange](#)

Clickable advertiser index – 2

[Train Control Systems](#)

[Trainfest](#)

[TrainMasters TV \(1\)](#)

[TrainMasters TV \(2\)](#)

[TrainMasters TV \(3\)](#)

[TSG Multimedia](#)

[Walthers](#)

[Westerfield Models](#)

[Yankee Dabbler](#)

[Yarmouth Model Works](#)

Clickable “other” index

[Other – Contents](#)

[Other – Cover](#)

[Other – Derailments](#)

[Other – Hobby Marketplace](#)

[Other – MRH Sponsors](#)

[Other – Yes it’s a model](#)

DOWNLOAD ISSUE



DOWNLOAD PORTRAIT



DOWNLOAD LANDSCAPE

• INDEX



SUBSCRIBE
(free)

• TABLE OF CONTENTS



REVERSE RUNNING

commentary

DON HANLEY
.....



[Click here for
reader comments](#)

THE SUMMERTIME DOLDRUMS

FOR MOST OF US SUMMER IS WHEN MODEL RAILROADING takes a back seat to vacations, barbecues, yard work, gardening, and a host of other outdoor activities. Really: who wants to spend time in the basement when the weather is great outside?

The hobby falls in the want-to-do category, not the need-to-do. Instead of undertaking a large project, pick something small, or a maybe a little project out of your comfort zone.

For me that project was building my first craftsman kit from Sunshine Models many years ago.

Maybe for you it's the idea of scratchbuilding a structure, building some scenery, or one of the other nagging items on your to-do list.



▶ STEPPING OUTSIDE THE BOX WITH A CONTRARY VIEW

Pick a project, then find at least two hours per week to work on it. There are 168 hours in a week to choose from. By Labor Day and the “official” end of summer, you will have spent 16 hours on your project. I know that I can accomplish a lot in 16 hours of modeling.

Can I build a layout in that time, no, but building a craftsman kit, yes. In the process I will have at least one of my to-do projects checked off. So what if I don’t get as much done as I had originally planned. It doesn’t mean I’m a failure if life got in the way. It’s not worth beating yourself up over it.

Or maybe just cleaning up the layout from last winter’s construction work is as much as you want to take on. Even doing this gives you the opportunity to organize your hobby world, which can be valuable.

While cleaning up, you may find yourself day dreaming about possibilities for the layout. Make some notes of your ideas. You can come back to them when the weather is not so nice outside and you have the desire to tackle a larger project.

Some readers may find that spending a few moments to read the magazine is all they want to do, and they don’t have the time or the desire to model during the summer months. That’s fine. There is no law that says that X,Y, and Z need to be done by a specific time.

Work runs by deadlines. Our hobby, on the other hand, is for fun. If this means you take the summer off from modeling, don’t feel guilty. Just come back in the fall when you’re more in the mindset to do some modeling.

To some model railroaders this may sound sacrilegious, but surprise! There are more important things in life than model railroad-ing. Take time for the important people in your life first, and then to your modeling. Here’s a little YouTube video that nicely demonstrates the value of appropriately prioritizing your time: [youtu.be/6 N uvq41Pg](https://youtu.be/6Nuvq41Pg).





DERAILMENTS

MODEL RAILROAD RULES TO LIVE BY

1. The object of this hobby is to have fun.
2. Buy some freight and passenger cars to go with your gross of locos.
3. Never ever tell a fellow modeler your scale is better than his.
4. At some point stop planning and start building the layout.
5. Never put perfection in front of running the trains.
6. Not paying close attention to the trackwork can kill the fun.
7. Hold a meet and bring your favorite engine, and have your friends bring their favorite locos too.
8. Have a plan and an era so you don't buy a lot of stuff you don't need.
9. Listen to the critics, weigh their suggestions, and then do what *you* think is best.
10. Never argue with a rivet counter. You will lose.
11. Good running engines and dependable rolling stock are required to really have fun.
12. You don't have to agree with your fellow modelers to be friends.
13. Have a spare tools because you will lose the first one.
14. Keep the lubrication supplies handy and use them sometimes.
15. Clean the track *before* the trains stop running.
16. Know your funds, time, and space resources – and plan accordingly.

▶ BIZARRE FACTS AND HUMOR (SUPPOSEDLY)

MORE RULES TO LIVE BY ...

17. In this hobby, “do it over” is a fact of life.
18. If you are a perfectionist, lighten up and cut other modelers some slack.
19. If you are not a perfectionist, lighten up and cut other modelers some slack.
20. Never ever forget rule one. ■

— *Posted on the MRH website by Laurell K. Hamilton*

[\[mrhmag.com/node/7955\]](http://mrhmag.com/node/7955)

GET PAID ...

If you're the first to submit a bit of good humor or bizarre facts and we use it, it's worth \$25! Just send to derailments@mrhmag.com ■

Coming next issue ...

- Our third-place winning “One Module” Challenge layout design by two teens
- Modeling a concrete industry
- TOMA layout car weathering project by Nick Campbell
- Latest OP SIG book FIRST LOOK
- And lots, *lots* more!

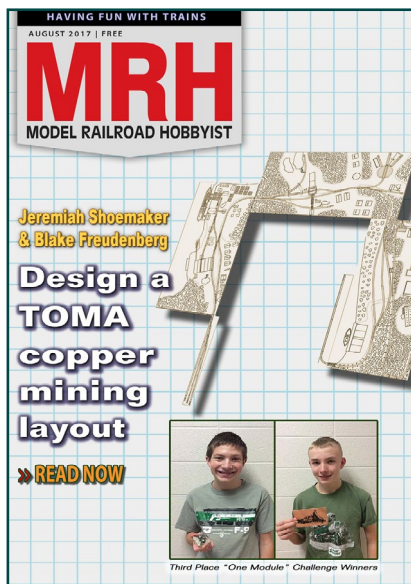

HAVING FUN WITH TRAINS
AUGUST 2017 | FREE
MRH
MODEL RAILROAD HOBBYIST

Jeremiah Shoemaker
& Blake Freudenberg

Design a
TOMA
copper
mining
layout

» READ NOW

Third Place "One Module" Challenge Winners



[Click here to rate or comment on this article](#)

• [INDEX](#)



[SUBSCRIBE](#)
(free)

• [TABLE OF CONTENTS](#)