

JUNE 2017 | FREE

# MRRH

MODEL RAILROAD HOBBYIST

## ALSO:

- The secret to needing less layout
- Doing a major layout overhaul
- Modeling the Easton Lumber Co.
- Jim Gore's Jamez & Rio Grande
- Kitbashing a modern depot

*... and lots more inside!*

**Don Hanley on**

# Blending scenery into a 3D backdrop

» **READ NOW**



STANDARD EDITION | PORTRAIT



DOWNLOAD



SUBSCRIBE  
*(free)*

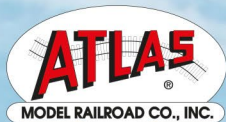

# A LOCOMOTIVE THAT SOUNDS AS GOOD AS IT LOOKS

## ATLAS HO TRAINMAN® RS-32/36 AVAILABLE FOR PRE-ORDER IN JUNE 2017



Chicago & North-Western

**CLICK HERE!**

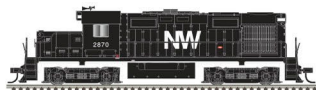

Norfolk & Western



Lamoille Valley+



Apache



Ontario Central



Central Vermont+



FNM+



Livonia Avon & Lakeville

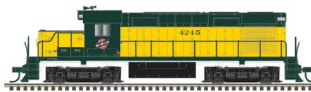

Chicago & North Western



+ Low Nose RS-11 represented by Low-Nose RS-36



# STAFF CREDITS

(Updated 5/26/2017)

**Front cover:** MRH Assistant Editor, Don Hanley, shows how he creates a 3D backdrop, making it hard to tell where the layout ends and the backdrop begins.

**ISSN 2152-7423**

## Editorial Staff

Joe D. Fugate, Publisher and Editor

Don Hanley, Assistant Editor

## Production

Patty Fugate, Pasteup and Layout

Joe Brugger, Copy Editing

Mike Dodd, Copy Editing

## Technical Assistant

Jeff Shultz

## Advertising

Les Halmos, Account Manager

Daniel Nava, Advertising Assistant

Jean-François Delisle, Marketing Assistant

## News and Events

Richard Bale, News and events

Jeff Shultz, News and events



## Columnists

Les Halmos, Modular railroading

Larry Smith, Narrow Gauge/Shortlines

Bruce Petrarca, DCC

Ken Patterson, Reporter at large

## Rotating Columnists

Jack Burgess, Getting Real column

Nick Muff, Getting Real column

Mike Rose, Getting Real column

Tony Thompson, Getting Real column

Rob Clark, Imagineering

Dave Meek, Imagineering

Ray Dunakin, Imagineering

Issue password: Jun2017

Published for the glory of God. [What's this?](#)





# MRH SPONSORS

## A - E



[acculites.com](http://acculites.com)



[americanlimitedmodels.com](http://americanlimitedmodels.com)



[railroadhobbyshow.com](http://railroadhobbyshow.com)



[anemodel.com](http://anemodel.com)



[archertransfers.com](http://archertransfers.com)



[athearn.com](http://athearn.com)



[www.atlasrr.com](http://www.atlasrr.com)



[bachmantrains.com](http://bachmantrains.com)



[bachrus.com](http://bachrus.com)



[backdropjunction.com](http://backdropjunction.com)

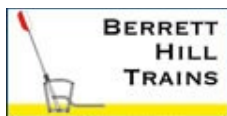

[berrethill.com/trains](http://berrethill.com/trains)



[blairline.com](http://blairline.com)



[bowser-trains.com](http://bowser-trains.com)



[coffmaneng.com](http://coffmaneng.com)



[www.digitrax.com](http://www.digitrax.com)



[esu.eu/en](http://esu.eu/en)

[Vendors: Get your clickable logo here ...](#)

# MRH SPONSORS | 2

## F - R



[www.handlaidtrack.com](http://www.handlaidtrack.com)



[foxvalleymodels.com](http://foxvalleymodels.com)



[www.iascaled.com](http://www.iascaled.com)



[lights4models.com](http://lights4models.com)



[litchfieldstation.com](http://litchfieldstation.com)



[store.mrhmag.com](http://store.mrhmag.com)



[modelrectifier.com](http://modelrectifier.com)



[monstermodelworks.com](http://monstermodelworks.com)



[stores.ebay.com/Motrak-Models](http://stores.ebay.com/Motrak-Models)



[mtalbert.com](http://mtalbert.com)



[37nngc.com](http://37nngc.com)



[ncedcc.com](http://ncedcc.com)



[nickandnora.com](http://nickandnora.com)



[nwhs.org](http://nwhs.org)



[www.pwrs.ca/main.php](http://www.pwrs.ca/main.php)



[rapidotrains.com](http://rapidotrains.com)



[ringengineering.com](http://ringengineering.com)

[Vendors: Get your clickable logo here ...](#)

• [INDEX](#)



[SUBSCRIBE](#)  
(free)

• [TABLE OF CONTENTS](#)

# MRH SPONSORS | 3

## S - Z



[sanjuancarco.com](http://sanjuancarco.com)



[scaletrains.com](http://scaletrains.com)



[selectmodelrailroads.com](http://selectmodelrailroads.com)



[soundtraxx.com](http://soundtraxx.com)



[sodigi.com](http://sodigi.com)



[sbs4dcc.com](http://sbs4dcc.com)

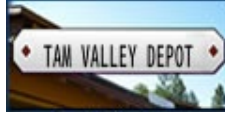

[tamvalleydepot.com](http://tamvalleydepot.com)



[tcsdcc.com](http://tcsdcc.com)



[tonystrains.com](http://tonystrains.com)



[trainmastermodels.com](http://trainmastermodels.com)



[traintekllc.com](http://traintekllc.com)



[tsgmultimedia.com](http://tsgmultimedia.com)



[walters.com](http://walters.com)



[yankeedabbler.com](http://yankeedabbler.com)

[Vendors: Get your clickable logo here ...](#)

Looking for something? Check the MRH Marketplace!

Take me there!

**HO**  
SCALE

**DCC**  
SOUND VALUE  
ON BOARD



## ANNOUNCING THE RETURN OF THE "J"! NEW SOUND VALUE N&W CLASS J 4-8-4

Designed for optimum-speed passenger service, the "J" was the last mainline steam locomotive to run in the United States. The Class J 4-8-4 has returned to the Bachmann HO line in a new DCC Sound Value version that includes a *SoundTraxx*® steam package with authentic prototypical chuff, short and long whistles, bell, air pump, steam release, and blower—all in 16-bit polyphonic sound. Visit your favorite hobby dealer to get this magnificent steam locomotive speeding around your HO passenger line.

### Features include:

- DCC sound-equipped
- dual-mode NMRA-compliant decoder
- precision motor
- operating headlight
- separately applied metal parts
- alligator cross heads
- see-through frame
- RP25 wheels
- *E-Z Mate*® Mark II couplers

SHIPPING NOW!  
MSRP \$429.00 each



NORFOLK & WESTERN #611- RAIL FAN  
Item No. 53201



NORFOLK & WESTERN #613  
Item No. 53202



Bachmann Industries, Inc. • 1400 East Erie Avenue • Philadelphia, PA 19124 USA • [www.bachmanntrains.com](http://www.bachmanntrains.com)

• INDEX



SUBSCRIBE  
(free)

• TABLE OF CONTENTS



# TABLE OF CONTENTS

## FEATURES

### Creating a 3D backdrop

*DON HANLEY*

Add realistic depth to your layout backdrop

---



### One Module Challenge: First place

*PETER VASSALLO*

Model the Easton Lumber Company using TOMA

---



### The Jamez & Rio Grande

*JIM GORE*

Visit this On30 layout at the Orlando convention

---



### Crash barriers

*MIKE HOLLY*

Protect your crossing signals with a crash barrier

---



### Depot for the Pittsfield Branch

*BARRY SILVERTHORN*

Kitbashing a modern depot for our TOMA layout

---



**ALSO:** MRH Marketplace | Subscriber extras



# TABLE OF CONTENTS | 2

## COLUMNS

**MRH Q-A-T: Canopy glue, track bumpers, and more**

*compiled by JOE BRUGGER*

**DCC Impulses: Digitrax duplex radio hints**

*BRUCE PETRARCA*

**Getting Real: Layout kaboom!**

*MIKE ROSE*

**What's Neat: Tricked out UP Challenger and lots more**

*KEN PATTERSON*

**Photo feature: Yes, it's a model**

*compiled by DON HANLEY*

**Derailments: Bizarre facts & humor**

*compiled by the MRH STAFF*

## NEWS and EDITORIAL

**Publisher's Musings: Secret to needing less layout**

*JOE FUGATE*

**News & Events: June 2017**

*RICHARD BALE & JEFF SHULTZ*

**Reverse Running: Model railroading, R.I.P.**

*DON HANLEY*



# Complete Your UP Excursion Train Post-2006 Water Tender Set

\*Truck chains not included



WWW.SCALETAINS.COM



**SAVE  
\$15**

Scene and photography by Ken J. Johnson  
First test model shown

Buy Now at [www.ScaleTrains.com](http://www.ScaleTrains.com) and Participating Select Retailers™

# RIVET COUNTER

**SAVE \$5**  
each

**SAVE \$10**  
each

**SAVE \$15**  
each

MIX & MATCH

MIX & MATCH

MIX & MATCH

**\$34.99**

**\$29.99**

**\$24.99**

each

each

each

BUY 1-5

BUY 6-11

BUY 12-MORE

# HO TANK CARS



WWW.SCALETAINS.COM



Buy Now at [www.ScaleTrains.com](http://www.ScaleTrains.com) and Participating Select Retailers

Scene and photography by Ken J. Johnson  
First test model shown

In stock only. Available at [www.ScaleTrains.com](http://www.ScaleTrains.com) and participating Select Retailers.

Offer ends June 30, 2017 or while supplies last. Not applicable to prior sales. Visit our website for complete details.

© 2017 ScaleTrains.com, Inc. Rivet Counter, Select Retailer(s), and respective logos are trademarks of ScaleTrains.com, Inc. ScaleTrains.com, Inc. 7598 Highway 411 Benton, TN 37307 844-9TRAINS 844-987-2467 International 423-299-3689

FOR FATHER'S DAY  
**NOT TIES**  
**TRAINS**



# PUBLISHER'S MUSINGS

editorial

JOE FUGATE



Click here to rate or  
comment on this article

## THE SECRET TO NEEDING LESS LAYOUT

**WE PERIODICALLY GET REQUESTS TO DO MORE** layout stories on smaller layouts and to do fewer stories on basement-filling behemoths. Yet when we run layout stories on smaller, more limited-scope layouts, they often don't rate as well.

I think there may be a "pseudo-frugal bias" where most of us feel compelled (because of limited resources) to "make do" with a smaller layout, with the practical side of us asking for examples. But if the truth be known, in our heart-of-hearts, many of us believe it's the really large layouts that will be more satisfying.

It's a commonly held fallacy of the hobby, I believe, that bigger is better. Let me tell you that a smaller layout can be every bit as satisfying as a larger layout. You think I'm kidding?

I'm putting my "money where my mouth is" so to speak, as I dismantle my Siskiyou Line 1 (SL1) and move to a modular section approach for my new Siskiyou Line 2 (SL2) using TOMA. For more on TOMA (The "One Module" Approach), see my editorial in the [October 2015 MRH](#).



## PUBLISHER'S MUSINGS | 2

With TOMA, the idea is to build your home layout using portable sections, and to complete each section all the way from bare benchwork to a finished module section with all the scenery, details, structures, and bridges totally done. If you have signals or lighted grade crossings, they all work. In other words, each TOMA section is completely finished before going on to the next TOMA module section.

Rather than just have a “still life” layout section, TOMA thinking encourages you to add flattop staging to both ends of the module, then go ahead and run trains. No need to wait for the entire layout to get into operation. With TOMA, the idea is to experience the entire breadth of the hobby from beginning to end

### ADVERTISEMENT

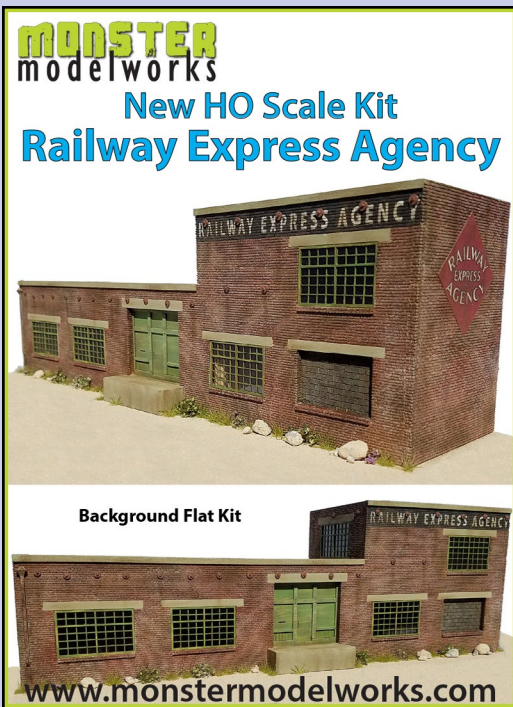

**MONSTER**  
modelworks

New HO Scale Kit  
**Railway Express Agency**

Background Flat Kit

[www.monstermodelworks.com](http://www.monstermodelworks.com)

The advertisement features two views of a brick building model. The top view shows a three-story brick building with a sign that reads "RAILWAY EXPRESS AGENCY" and a red diamond-shaped sign on the side. The bottom view shows a two-story brick building with a similar sign. The website address is listed at the bottom.

### ADVERTISEMENT

**Backdrop Junction**  
Your Stop for Railroad Backdrops

**Click Here** →

**For the Finest in Custom  
Designed backdrop**



[www.backdropjunction.com](http://www.backdropjunction.com)

• **INDEX**

• **TABLE OF CONTENTS**

# WHAT IS ATHEARN ROUNDHOUSE?



## FUN

Classic model trains inspired by real railroading. Setting a foundation for excitement and enjoyment.

## ROBUST

Designed to pass the test of time. Tried and true products that last a lifetime.

## VARIETY

Colorful equipment for everyone – from vintage to modern. Perfect for beginning and experienced enthusiasts.



These points are the basis for the new Athearn Roundhouse®. This collection is home to the hobby's best-loved classic models. A wide variety of eras and railroads are available with an emphasis on fun, creating a product line for both beginning modelers and experienced hobbyists.

A rich history is not exclusive to real railroading alone. The year 2017 will see Athearn Trains celebrating our 70th year of offering model railroaders fun, exciting and accurate models. Athearn – the biggest little railroad in America™ since 1947.



**HORIZON**  
H O B B Y

**VISIT**  
Your Local Retailer

**CLICK**  
Athearn.com

**CALL**  
1.800.338.4639

**SERIOUS FUN™**

©2017 Horizon Hobby, LLC. Athearn, Genesis, Ready To Roll, Trains in Miniature, Serious Fun and the Horizon Hobby logo are trademarks or registered trademarks of Horizon Hobby, LLC. The Union Pacific mark and other marks owned by Union Pacific are made under trademark license from Union Pacific Railroad Company. All other trademarks, service marks and logos are property of their respective owners. Final models may vary slightly from photos shown. 55850

• INDEX



SUBSCRIBE  
(free)

• TABLE OF CONTENTS

HO GP60M, GP60B AND GP60 Locos



NOW AVAILABLE !



DC OR DCC WITH SOUND!



www.foxvalleymodels.com

**NEW!**Carbone's Service Station  
HO Scale Kit #ST027**NICK & NORA DESIGNS**

Uniquely inspired craftsman kits

Craftsman Structure Kits in HO &amp; N

Detail Parts,

laser cut shingles,

HO Vehicles, Tru-Color Paints,  
glues, tools & more!

www.nickandnoradesigns.com

## PUBLISHER'S MUSINGS | 3

including ops – but because you're doing your layout just a small piece at a time, you can get to completion a lot more quickly.

With my SL2 layout using TOMA, I'm planning to follow this “build it in smaller bits” approach. My one concession is I plan to do a “town at a time” – which translates generally to 3 or 4 TOMA sections six feet long to form the complete scene.

At first, this will be a lot less layout than I've been used to, but I'm not at all worried. In fact, if I never get the full new layout completed, I won't be at all concerned. Let me explain why.

With SL1, I was in such a big hurry to get the room-full-of-layout operational that I cut corners – and lived to regret it later. I had trackwork issues, rolling stock issues, and loco performance issues. Sure, SL1 was big, but was also a big headache all too often.



ORDER DEADLINE  
EXTENDED TO  
JUNE 26TH, 2017



MODEL T6H-5307N - with optional equipment

## NEW LOOK "53's"

# CLICK HERE FOR INFO

• INDEX



SUBSCRIBE  
*(free)*

• TABLE OF CONTENTS

I started going back and redoing things to improve the layout's performance. It has been this relentless pursuit to improve SL1's ops performance that lead to my *Run like a Dream* thinking and my book series by that same title ([store.mrhmag.com/store/p115/ebook/run-like-a-dream](https://store.mrhmag.com/store/p115/ebook/run-like-a-dream)). These books document getting the very best ops performance from track, cars, and locos.

Unfortunately, SL1 had issues that were more than skin deep and could only be corrected by rebuilding. After 26 years, SL1 finally became dumpster fodder, and I'm now gearing up to start SL2.

Recently, I got this question on the MRH forum about my move to TOMA methods with SL2:

*"You want to build a very large layout using TOMA, but if you build one module at a time from start to finish, it would take a very long time before you could hold an op session with a fair amount of people."*

To answer this, I pointed out I've become more interested in *quality* of run than in *quantity* of run. Put another way – I'm finding a bit of really good "micro ops" to be far more satisfying than lots of mediocre "macro ops."

As a result, my plan with SL2 is to limit myself to 3 or 4 modules at the start, but build them to a fine level of completion before moving to more sections. I will add staging and do op sessions as I go.

The latest crop of modern sound decoders with braking functions is transforming the ops experience for me. In the decoder programming, I add lots of acceleration and deceleration to each loco. Running a train now becomes a lot more involved – and a lot more fun!

Here's how I'm running trains these days: I'll release the brake, ramp up the loco throttle carefully, approach where I want to stop, cut the throttle so I'm coasting, then apply the brake in small bursts to stop the loco exactly where I want it. The sound is great because when I apply the brake, the decoder randomly generates some amount of braking squeal – but each time is slightly different.



# FAST TRACKS BUYS MT. ALBERT SCALE LUMBER CO.

Fast Tracks is helping the world build EVEN better railroads with the addition of Mt. Albert Scale Lumber.

New Mt. Albert products and model kits coming soon.



**Easy ordering • Live online support**  
**Earn Waypoints with every purchase**

shop online 24/7

[handlaidtrack.com](http://handlaidtrack.com)

1-888-252-3895

[service@fast-tracks.net](mailto:service@fast-tracks.net)

• INDEX



SUBSCRIBE  
(free)

• TABLE OF CONTENTS

Introducing the **WALTHERS** *PROTO*.

# George Washington

CLICK  
HERE TO  
LEARN MORE



For business or a relaxing get-away, there was no finer way to travel between Washington and Cincinnati than the Chesapeake & Ohio's *George Washington*. Known simply as the *George* to its many fans, the train's unique personality was reflected in everything from hardworking heavyweights up front carrying mail and baggage, to impeccable service inside the rebuilt Dormitory-Diner. Travel back to a time when getting there really was half the fun aboard our newest HO Scale name train, featuring seven cars and matching E8A diesels.

## HO C&O Class PE-225 EMD E8A Units



## HO C&O George Washington passenger cars



**First car arrives in January 2018 - reserve now!**

**WALTHERS**

Support your local hobby shop • visit [walthers.com](http://walthers.com) • call 1-800-4-TRAINS

Prices and delivery dates shown were accurate at press time, for updates please visit [walthers.com](http://walthers.com). Photos show preproduction models for illustration purposes only, some colors and details may vary. CSX proprietary marks used by permission of CSX Transportation Inc. ©2017 Wm. K. Walthers, Inc.

• INDEX

• TABLE OF CONTENTS

## PUBLISHER'S MUSINGS | 5

The coasting is fun because the loco will roll a long ways when I shut off the throttle, giving me a sense of great mass.

With all this momentum, I don't want to ramp the speed up too high now because then it becomes hard to stop on a dime. I tend to run slower and I have to think about moves more. It's delightful.

I'm expecting as I build SL2 using TOMA sections, I will be making everything conform to my *Run like a Dream* standards from the get go.

With TOMA, the scope is smaller: I can hand-pick a few locos and just enough rolling stock for ops on these sections, while keeping this fine-tuning effort very manageable.

Near flawless performance coupled with all sound locos, braking, and lots of momentum and *it won't take much layout to be a totally engrossing blast to operate, even for the run-through trains.*

The problem with *quantity of run* (lots of layout) is it takes a mammoth effort to execute well. You may have a *lot* of layout, but you'll likely also have *a lot more issues*. Downsize your scope and make the quality of run the priority. Smaller is easier to do really well, and at the end of the day, I find it satisfies more.

TOMA deliberately limits scope to a more realistic level and it presumes *quality of run* trumps *quantity of run*. I have found that's true, so TOMA bakes this kind of thinking into the layout building process.

Recently on a TrainMasters TV video comment thread, Tim Garland succinctly summarized this great secret to smaller being more satisfying: "Most folks will find the more prototypical they make their operating sessions, the less layout they need."

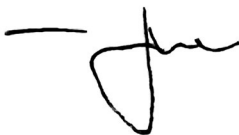

[Click here to rate or comment on this article](#)



## *MRH 2016 survey, Prototype or freelance?*

Here is the response from our 2016 reader survey question asking our readers whether they prefer to model the prototype or some level of freelancing. The statistical validity is +/- 2.5% with a 95% certainty.

### **Do you prefer prototype or freelance?**

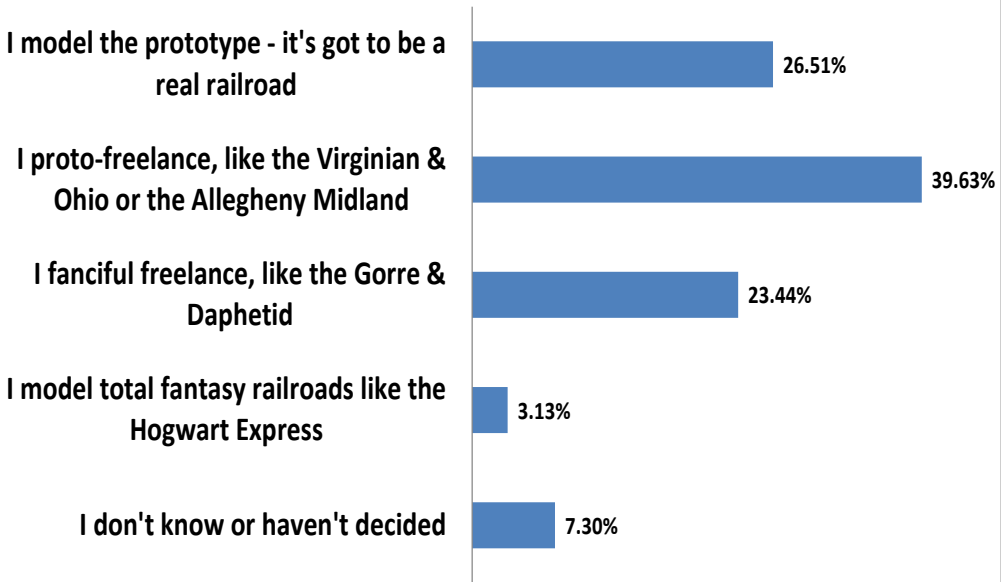

While there has definitely been a trend in the hobby press toward more prototype-based articles, it appears over 60% of our readers still prefer some amount of freelancing. Only about 27% are a stickler for no compromise prototype modeling.

That said, if we lump the pure prototype modelers in with the proto-freelancers, then we also get about 65% of our readers who prefer more prototype-oriented material.

Either way, a mix of prototype and freelancing content should be satisfying as long as it doesn't get too fanciful.



# Announcing our next Limited Run PWRS / Micro-Trains® Car!!!



## Canadian Pacific Railway (CP) & Canadian National Railway (CN) 4-packs



### CPR

- stacked block lettering
- moderate weathering

CLICK HERE FOR  
**CPR Box Car**



### 40' Standard Box Car, Single Door

**COMING**  
December 2017

### CNR

- "Serves all Canada" green maple leaf herald
- moderate weathering



CLICK HERE FOR  
**CNR Box Car**



## Pacific Western Rail Systems

• INDEX



SUBSCRIBE  
(free)

• TABLE OF CONTENTS



# LAST ISSUE'S RATINGS

The five top-rated articles in the [May 2017 issue](#) of *Model Railroad Hobbyist* are:

- 5.0** Derailments
- 4.8** Lite and Narrow: Shay-powered coal railroads
- 4.7** Getting to the fun part: Modeling Bradford
- 4.6** What's Neat: Homemade leaves, ...
- 4.6** Modeling CP Rail 5406

Issue overall: **4.3**

**Please rate the articles!** Click the reader comments button on each article and select the star rating you think each article deserves. Thanks! ■

## ADVERTISEMENT



**Archer**  
FINE TRANSFERS  
PROUDLY SERVING MODEL BUILDERS SINCE 1989

THE ORIGINAL  
**SURFACE DETAILS™**

**WE NOW HAVE MORE THAN 130 SHEETS OF RIVETS, LOUVERS, TREADPLATE, WELD SEAMS AND MORE CAST ONTO MICROSCALE CLEAR DECAL FILM**

**LOW SHIPPING:**  
DOMESTIC USA ORDERS \$2.80  
INTERNATIONAL ORDERS \$9.95

CLICK HERE TO VISIT OUR WEBSITE!

*"Archer Fine Transfers 3D decals have revolutionized kitbashing and scratchbuilding. Putting rivets or other low-relief details like louvers or weld seams on your models is now as easy as applying decals."*

Joe Fugate, Publisher/Editor Model Railroad Hobbyist

Archer Fine Transfers • PO Box 1277 • Youngsville, NC 27596 • USA (919) 570-1026 • info@archertransfers.com • archertransfers.com

## ADVERTISEMENT

**TRINITY 3 2 8 1  
IN STORES NOW**



Norfolk Southern -- 12 #s



ICE-GATX -- 8 #s



Winchester & Western -- 12 #s



NRLX Ciment Québec -- 12 #s

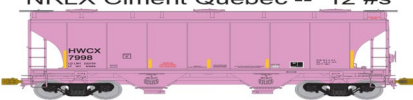

HWCX -- 7 #s

**American Limited**

www.americanlimitedmodels.com

**Hobby  
persistence  
gone?**

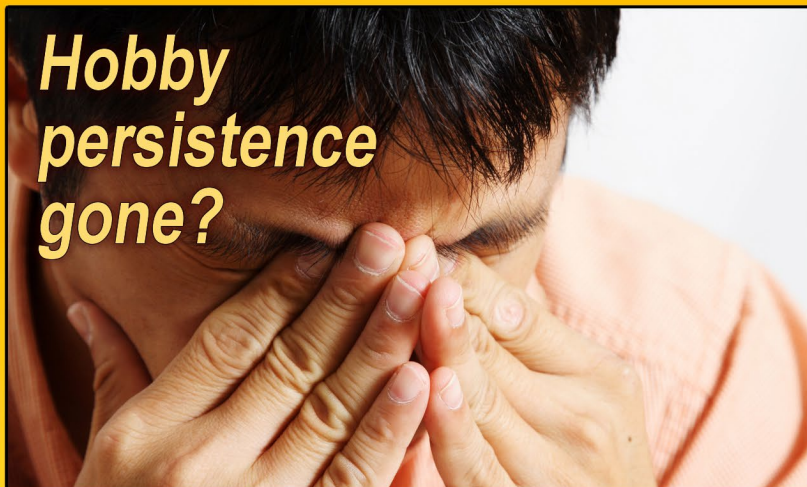

***“Persistence isn’t needed when you know how to do it right the first time.”***

# **TRAINMASTERS TV**

**Our experts teach you to *do it right from the start.***



click here to  
**Become a member >>**

**www.trainmasters.tv**



***“I can’t imagine life before Trainmasters TV.  
It is worth every penny.” – Guy E.***

• **INDEX**



**SUBSCRIBE**  
*(free)*

• **TABLE OF CONTENTS**

# George Sellios *has produced his* **FINAL KIT**



  
**FINE SCALE MINIATURES**  
I.M. Dunn Co. \$280 + S&H



*Destined to become an  
instant collector's item*

**BUY NOW >>**

Brought to you by the MRH Store: [store.mrhmag.com](http://store.mrhmag.com)





Model Railroad Hobbyist | June 2017 | #88

# MRH Q-A-T

column

compiled by  
**JOE BRUGGER**



[Click here to rate or comment on this article](#)

## QUESTIONS AND ANSWERS

### Formula 560 canopy glue

**Q.** I'm looking for a glue that will adhere painted part to painted part for structure building. I prefer to paint all component parts first, but have had issues with painted parts glued with CA coming loose. I've seen videos with modelers using Formula 560 Canopy Glue by Pacer to glue painted scenery objects directly to other painted objects of different types/textures on their layouts, and it dries clear as well. As long as it works, setting time won't be an issue with me. I've become tired of scratching off the paint on model parts before gluing with CA.

—James S.

**A. Chris Palermo:** Canopy cement is fairly viscous (thick), so for small parts, care would be needed to ensure that dried glue is not visible. Further, the setting time is much longer than CA. It's counter-intuitive to use, because it looks and flows almost like

▶ MRH QUESTIONS, ANSWERS, AND TIPS

• [INDEX](#)



**SUBSCRIBE**  
(free)

• [TABLE OF CONTENTS](#)

## MRH Q-A-T | 2

ordinary white glue, but behaves quite differently. Buy a bottle and try it with a small structure. Even if you don't use it for all your structures long-term, it has many other applications, such as gluing weights into freight cars, so you won't regret the purchase. It has a long shelf life.

**Dave B.:** When gluing painted parts together, the adhesion of the paint to the part is going to determine the ultimate bond strength. A different glue might not help if the CA bond is breaking between the paint layers.

**Steven (rgs\_info):** You might try Alene's Tacky Glue. It works well on lots of surfaces, although I wouldn't use it for a structural bond (like gluing walls together) on painted parts. For smaller parts, I think it could work well. Easy to find at craft stores and online.

Read the ongoing discussion at [mrhmag.com/node/28176](http://mrhmag.com/node/28176).



1. YouTube video showing how to build and install a wooden track bumper.



2. This is a Durable brand bumper on the Maine Central. It's very similar to bumpers on the Boston & Maine. *Photo by MRH subscriber "Stephen"*

## Track bumpers

**Q.** My railroad is supposed to be a 100-mile-long short line between the New Haven and the B&M in the late '50s. I have laid all the ballast and am now thinking about track bumpers.

There is a video on YouTube by PennCentral 99 showing how to make timber bumpers [1].

Would something like these be used, or maybe just a couple of railroad ties buried and making a cross to stop any run-aways. I am not that committed to full accuracy. How about a pile of dirt?

—Long-haired David

**DaveN:** On the old Southern Pacific, a dump truck load of dirt at the end of a spur was common. I've also seen ties buried in an X pattern, and some nice manufactured steel bumpers in industrial areas. I'd build them to match the area involved. Maybe Google Earth some nearby towns and see what's used there?

## MRH Q-A-T | 4

**Alan Rice:** Depends on what is beyond the end of track. In urban/industrial areas you may see a built-up bumper or a wheel/car stop to insure that the car will not go beyond the end of track. Go to [westernsafety.com/wch-railroadproducts/wchpg7.html](http://westernsafety.com/wch-railroadproducts/wchpg7.html) for examples [2].

If there is something important to protect at the end of track like a building, street, and so on, these “positive” stop solutions would be more likely. For less critical areas or more open, rural/suburban areas, crossed ties or a load of dirt would do the trick.

End-of-track devices might more be the decision of the industry served. It’s their money, and usually not the railroad’s, that will determine what acts as a car stop.

**MikeC in Queensland:** In places I use piles of dirt as well as crossed ties and, in a more industrialized spot, wheel stops cut from card.

Track bumpers are actually fun to make. I made [3] from matchsticks ( front legs), scrap wood (central pad), and rail (rear legs).



3. MRH subscriber “MikeC” scratchbuilds bumpers from matchsticks, scraps of wood, and rail.

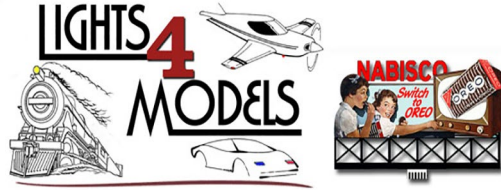

Miller Signs  
Evan Designs



Iron Penguin  
Ring Engineering

EZ Line

Tomar

ITT Sound Boards



**Shop Now**

Want it on Blu-ray?

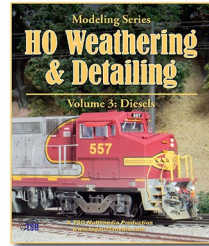

Selected titles are  
now available on  
Blu-ray disc in  
spectacular HD!

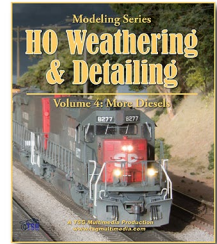
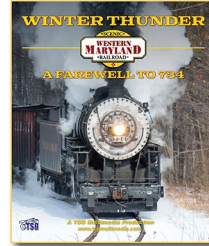

CLICK FOR  
BLU-RAY



**TSG Multimedia**

Checked us out lately?

- ✓ HO/N and now O scale products too!
- ✓ Laser-cut Structures & Bridges.
- ✓ Advertising & Storefront Signs.
- ✓ Highway Signs, vintage & modern.
- ✓ New Detail Items.
- ✓ Laser-cut Grade Crossings.
- ✓ Billboards, roadside & rooftop.
- ✓ Laser-cut Graffiti Decals
- ✓ 1000's of satisfied customers.

WHAT'S  
NEW?



Established 1993...

**Blair Line**

**Select MODEL  
RAILROADS**

**Design & Build Services  
For Discriminating Modelers**



**WE WILL:**

**Complete Unfinished Railroads  
Fix or Rebuild Bad Railroads  
OR  
Design & Build A Custom  
Railroad Of Your Dreams**

CLICK HERE FOR OUR WEBSITE  
[www.SelectModelRailroads.com](http://www.SelectModelRailroads.com)

**(844) 872-4670**



## MRH Q-A-T | 5

Its rear legs are lost in long grass just beyond the rails so as not to cause short circuits, although the legs don't quite meet at the top anyway. It would be easy to add bracing between the rails at the foot of the front legs. For the front legs, you can also bend styrene strip in warm water to form an inverted U-shaped hoop.

See MikeC's blog at [mrhmag.com/node/14628](http://mrhmag.com/node/14628).

**RDGAndrew:** I picked up several kits of white metal Durable Model D bumpers at a show last year. I always liked the chunky cast look of these, as opposed to the welded ones made of I-beams. Another favorite is the Ellis bumper, of which several ancient ones



4. Well, it *did* stop the car. Photo courtesy of MRH subscriber "BrownShoeSailor"

Norfolk and Western Historical Society



**Available Now!**  
**Standard Station Kit**  
**HO Scale**



**Over a decade out of print!**  
**This Laser-cut kit is a**  
**detailed model and fits any**  
**era from 1895 on**  
**New limited run now in stock!**  
**Item 134.32**  
**Retail \$84.95**

**Click Here!**

**Combo Right Clamp™**

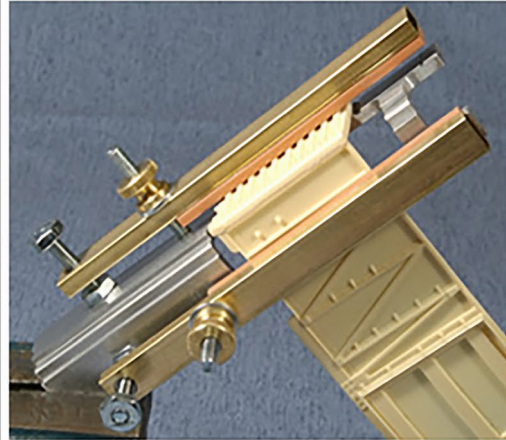

**Combo Right Clamp™**  
with cast resin boxcar

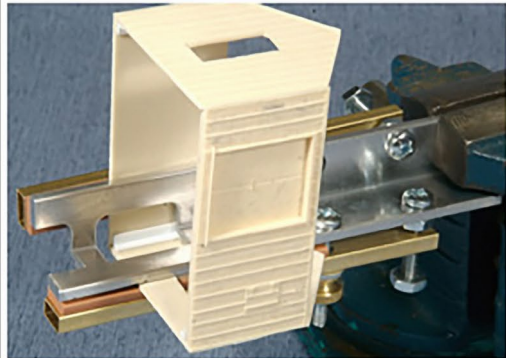

**Combo Right Clamp™**  
with Wolf Design Pump House

**Click here for**  
**all our products ...**

**Tools for Modelers**  
**Coffman Graphic Solutions Co.**  
**1500 River Circle, Richmond,**  
**KY 40475-7907**



are still around here in the Philadelphia area, protecting the ends of coal spurs that haven't seen a carload in 60 or 70 years. On that type, the rails angle up at 45 degrees and come together on a cast steel block behind a heavy wooden upright. I would think the Ellis would be right at home in New England. Google will give you plenty of pics – just be sure to include “railroad” in your search or you'll get lots of automotive bumper diagrams!

**ATCguy:** I use the Tomar H-803 wheel stops on my yard tracks. I plan to add grass and weeds around them later.

Read more ideas, see more photos, and get a couple of professional references to track bumpers in the full thread at [mrhmag.com/node/19356](http://mrhmag.com/node/19356).

## Hang slack like real cable

**Q.** The threads I have used to mimic cables on my ash dump and coaling tower do not hang straight up/down, and look goofy, bowed out, and twisted. No way to put enough weight at the end without distorting the look. Does anyone have a different material that might work, or have I missed something in several trips to Hobby Lobby?

—Larry S

**A. Rob Clark:** I use fine florists wire. It holds whatever shape you put it in and can be painted to represent any material you want.

**Pelsea:** This thing from Vero ([verotl.com/en/product/verowire-wiring-pen-part-number-79-1732](http://verotl.com/en/product/verowire-wiring-pen-part-number-79-1732)) dispenses fine, rather stiff 34-gauge wire. It isn't heavy enough to fall in a catenary curve, but it can be shaped with a stiff brush and will hold its shape better than thread does. I've coated this bit with glue and painted it with acrylic to see how it would do.



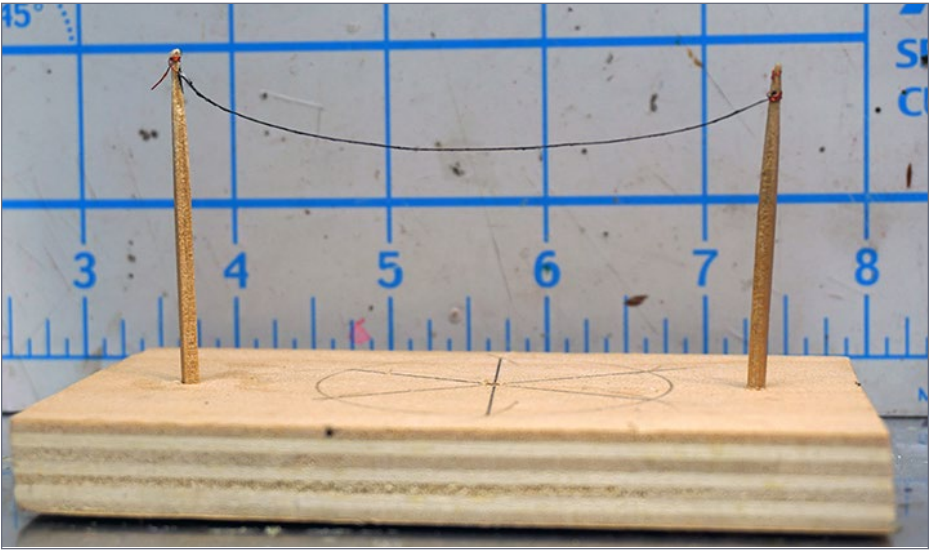

5. 34-gauge wire from Vero can be shaped into a hanging curve between poles. *MRH subscriber "Pelsea" photo*

**Smokey Dawson:** I hang two yards of black cotton thread from the ceiling, then put full strength white glue on my fingers and slide my fingers down the cotton. I found I had to slide my fingers twice to smooth out the glue. I used the cotton to run my power lines and got the sag I required. I put a drop of ACC on the poles to hold the 'wire' in place.

**Rick Sutton:** Shopping at the bead store, I pick up a lot of little items for telephone poles and some tiny braided wire that I use for cables.

**Gary60s:** Try EZ Line from [berkshirejunction.com/ezline.html](http://berkshirejunction.com/ezline.html). An easy way to string lines is with this tool shown at [nscale.net/forums/showthread.php?25269-Utility-line-stringing-tool-\(MYO\)](http://nscale.net/forums/showthread.php?25269-Utility-line-stringing-tool-(MYO)).

**Wynnewood:** Tried the EZ line; works great on telephone poles and hangs slack, but stretches when strung around the windlass to

the ash bucket. If you use thinned white glue, you are committed to a permanent position for the equipment.

**BR GP30 2300:** I too have been fooling around with EZ line, and find it easy to work with.

**Eric:** I use a length of thread and apply Johnson's Klear acrylic floor polish ( formerly Future, now marketed in some areas as Pledge Floor Care Finish). You need to apply a weight to the bottom end until it is dry. This effectively stiffens the thread and holds it in shape.

Read the full thread at [model-railroad-hobbyist.com/node/28796](http://model-railroad-hobbyist.com/node/28796).



**Click here to rate or comment on this article**



## GET PAID FOR YOUR TIP

We pay \$25 per tip we publish, or \$40 each if the tip also includes a photo or finished drawing. [Click here and select article type TIP.](#) ■  
.....

 TIPS

## Model paint stirrers

I am not sure if anyone has submitted this, but it has worked well for me.

Those “splash sticks” from that large corporate coffee house make great paint stirrers. Not only are they free, they work well with all of the common sizes of hobby-related paint. You can stir a bottle, and also scrape the settled paint from the sides and bottom. Re-cap, agitate the bottle a little to blend it all in, and voila.

—Eric P. Wiczorek



6. Stiff coffee stirring sticks can also break up clumps in paint bottles. *Eric Wiczorek photo*

## Flatten those model automobile tires

While building automobiles for my junkyard, I stumbled upon a technique that adds more realism. I clipped off the bottoms of the tires with flush-cutting pliers to produce a “flat tire” or “sunk-in-the-mud” look. However, I accidentally placed one of these cars destined for the junk yard on a road. Once I placed the “flat tire” car on the road it became obvious that clipping the tire bottom eliminated the “hovercraft” effect that I dislike. Clipping less tire material yields the “radial tire” look that I like, suitable for my roadways.

—Darin Evans



7. Clipping tire bottoms (left) takes away the “hovercraft” look and lets cars (right) rest on the ground or highway more naturally. And they won’t roll away. *Darin Evans photos*



[Click here to rate or comment on this article](#)



"Where we make DCC fun!"

S T A T I O N



\$49.95 - \$119.96



N & HO SELECT SERIES

\$85.95



\$70.00



\$87.96 - \$143.96



- Click here to visit our website -

www.LitchfieldStation.com  
623-298-7355

• INDEX



SUBSCRIBE  
(free)

• TABLE OF CONTENTS

# From first train set to railroad empire...

*Our complete line of DCC products  
grows with you. Discover the fun!*

- Designed and manufactured in the U.S.A.
- Preferred for ease of use and ergonomic design
- Unlimited scalability for any size model railroad
- Plug-and-play means more time running trains
- Great customer service and excellent support



## See your dealer



## Visit our new and improved web site for all your DCC needs!

- Get the latest new product announcements
- Watch our detailed how-to videos
- Browse the all-new Information Station
- Enjoy secure online sales, day or night!

Visit **ncedcc.com**



• [INDEX](#)



[SUBSCRIBE](#)  
(free)

• [TABLE OF CONTENTS](#)

# TONY'S TRAIN XCHANGE

*Committed to your DCC support!*

## New Athearn Genesis HO GP7 & GP9



New Road Names & Numbers!  
DC or Tsunami2 Sound & DCC  
FEC, CofG, CB&Q, GTW, RI,  
SOU, SP, WP, etc. In Stock!  
Starting at \$149.95

[Order Yours](#)

## Rapido HO Absolute RDC



Available in DC or  
With Rapido Exclusive  
ESU LokSound DCC On Board

CN, CN Rail, CP, CP Rail, BC Rail,  
NH Script, BM, MBTA, NYC  
(More roadnames available)

Starting at \$194.95

[Order Yours](#)

## Athearn Genesis HO GE U50



Available in DC or  
With Tsunami Sound & DCC

Genesis level detail and  
Genesis quality can motor,  
SP & UP units available.

Starting at \$199.95

[Order Yours](#)

**Do you need a Sound or  
DCC Installation done?**

**Get a quote!**

**TONY'S  
TRAIN  
XCHANGE**  
DCC SPECIALISTS

Providing unmatched person to person  
DCC support for more than 25 years, the  
kind of service that has made us #1 in DCC.

**DCC questions? CALL US! 1-800-978-3472**

*We'll get you on the right track!*

June 2017



• INDEX

• TABLE OF CONTENTS





# DCC IMPULSES

column

BRUCE PETRARCA MMR



[Click here for reader comments](#)

## DIGITRAX DUPLEX RADIO HINTS

**DIGITRAX HAS BUILT A REPUTATION FOR RELIABLE** wireless operation. Things are evolving in their camp, so I felt that it was time to delve a bit into the history and current status..

### History

When I started Litchfield Station (2000) there were a limited number of options for wireless cab connection of your DCC system. One of the most reliable and robust versions available at that time was the Digitrax radio system. It utilized a communication protocol known as simplex. The simplex radio cabs are distinguished by the letter “R” at the end of the part number, such as UT4R [1].

At that time, I recommended Digitrax to my customers who wanted radio, as the competitive (duplex) system from NCE was not as reliable.

As time went by, NCE found the stumbling block that was limiting their range and reliability. The NCE wireless system now has become quite reliable.

▶ DCC TIPS, TRICKS, AND TECHNIQUES



## DCC IMPULSES | 2

Both the Digitrax and NCE radio cabs utilized the same frequency in the (unlicensed) 915MHz band. Thus, if you had two layouts in the same general area, such as a train show, they would interfere with (step-on) each other. One of the tenets of unlicensed operation is that the user must accept any interference.

Not to be outdone, Digitrax released a duplex system in the middle of 2009. Their duplex system was established in the 2.4GHz band where there was less chance of interference from other DCC systems, cordless telephones, etc.

The duplex cabs carried the “D” suffix, such as the UT4D shown in figure [2]. The only thing that externally distinguishes the two

radio cabs from each other is the letter at the end of the model number (R = simplex; D = duplex) and the text near the model number (“RADIO EQUIPPED” vs. “DUPLEX EQUIPPED”).



Many early adopters of the Digitrax duplex system reported less than perfect performance: short battery life being one of the most prominent complaints. Digitrax listened and worked on the issues.

1. UT4R simplex radio cab from Digitrax. *Digitrax photo*



## 2. Digitrax duplex engineer's cab, the UT4D. *Digitrax photo*

When the duplex radio was announced, in 2009, Digitrax discontinued selling sets with the simplex radio components included. Only duplex components have come as part of a radio system from Digitrax since then.

In October of 2016, Digitrax announced the end of simplex. They would build base units and simplex cabs until February 2017. Maintenance support will continue until they run out of parts.

## Simplex vs. duplex

Okay, what's the big difference between simplex and duplex?

## DCC IMPULSES | 4

Simplex means that the base unit [3] only listens for signals coming from the cabs. The base never transmits anything by radio. So, there is no verification of commands being received. Since the process of acquiring a loco on a cab requires some communication in both directions, the simplex radio cabs cannot change locomotives without being plugged into the layout. This requires a LocoNet panel on the layout every place the operator(s) will need to address a new loco. It is a good design practice to have a number of cab panels scattered around the layout so that one can easily access the system in the event of a loss of radio communication.

Duplex means that the base unit [4] and the cabs both transmit and receive. This additional communication allows the operator to acquire a loco without plugging -in. Communication can be much

### ADVERTISEMENT



### Big Sound. Small Budget.

The ECO-200 Digital Sound Decoder provides a plug-in installation for great sound at an incredible price! Enjoy prototypical steam or diesel sounds, advanced motor control, and 6 lighting functions.

**SOUNDTRAXX™**  
www.soundtraxx.com

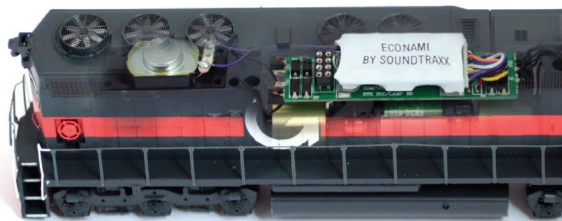

*Compatible with 9-Pin DCC-ready locomotives from Athearn, Walthers, and other model manufacturers*

[Watch the Install Now ▶](#)

# Great control in a tiny package



**Original  
Touch Toggles**

- Touch Toggle™ plug in controls
- Bright clear indication
- Easy setup
- Flexible system

Stall Motors, Twin-coils,  
Power, and Servos

Now for Tam Valley Depot  
and MRservo too!



Made in the USA 

What will they think of next?

[www.berretthillshop.com](http://www.berretthillshop.com)



**CLICK TO SEE OUR NEW WEBSITE!  
SAME GREAT SERVICES & PRICES!**

Don't forget to use the **SEARCH** button to search info you want to find

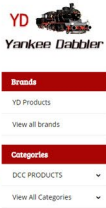

ALWAYS WILLING TO SHARE OUR EXPERTISE WITH FRIENDS



\*Specializing in DCC! \*The Best for Less! \*Sales-Services-Installation! \*

**Technical Coordination (727) 457-9227 9AM to 9PM EST**

**CLICK AND SAVE TODAY!**

Use coupon code "MRH" for FREE SHIPPING

YD installs DCC or RailPro in your engines



• INDEX



SUBSCRIBE  
(free)

• TABLE OF CONTENTS

## DCC IMPULSES | 5

more reliable, due to the base station's ability to acknowledge commands received and the cab's ability to resend commands that are not acknowledged in a reasonable period of time.

### Can I run both together?

In conjunction with the move to duplex communications protocol, the "D" series cabs operate on a different frequency and in a radio band far removed from where the "R" series systems



3. Digitrax UR91 base unit that receives simplex radio and infrared wireless signals. The two green wires seen in the photo are the antenna – remember rabbit-ears TV antennas? *Digitrax photo*

ADVERTISEMENT



**ROLLING ROADS**

**SPEEDOMETER** For Speed In Real Time!

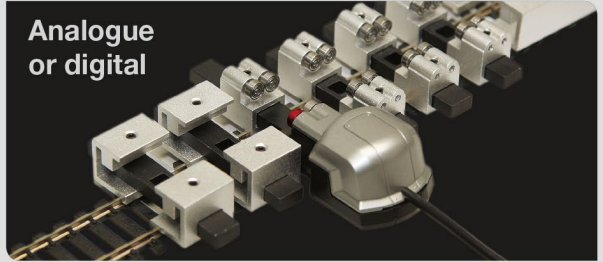
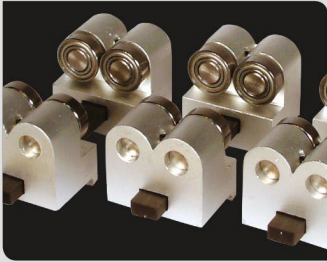

Analogue  
or digital

**CLICK HERE**

**Bachrus** inc  
RUNNING ON QUALITY

[www.bachrus.com](http://www.bachrus.com)  
Hannon, ON Canada

ADVERTISEMENT

**RailPro**™  
**NEW TECHNOLOGY**



**RE RING**™  
ENGINEERING

**NEW Starter Kit**  
**\$399.99 MSRP**

- Includes Wireless Color Touch Screen Handheld Controller and 56 Watt Power Supply
- Expandable to Virtually any Size Layout

**NEW Locomotive Module**  
LM-3 & LM-3S



- Direct Radio RF
- Sound and Non-Sound
- New Tiny Size
- 6 Light Outputs

**Click Here to Learn More**

For more information visit our Internet site: [www.RingEngineering.com](http://www.RingEngineering.com)

• INDEX



SUBSCRIBE  
(free)

• TABLE OF CONTENTS

## DCC IMPULSES | 6

operate. This diversity allows both systems to operate on a single layout at the same time. Of course, each system will have its own set of features and limitations. But folks don't have to completely scrap the cabs they have to start migrating from simplex to duplex.

### How difficult is it to change from simplex to duplex or add duplex to an existing layout?

In order to explain this process, I obtained a duplex radio cab (UT4D) and a duplex radio base (UR92). Our PebbleCreek Model Railroad Club ([pcmrc.org](http://pcmrc.org)) layout has had simplex Digitrax operation from the beginning in 2006. Here is what I did to install the base unit on the layout.



4. UR92 duplex radio base unit with infrared capability. The antenna is built into the (yellow) radio module.  
*Digitrax photo*



# DCC IMPULSES | 7

Once the UP5 was loose, I slid it out from the fascia a bit and unplugged the two LocoNet cables from the rear of the panel.

Near the middle of the room, I removed one of the (UP5) Universal LocoNet Panels, as shown in [5].

The new UR92 receiver is virtually the same size as the UP5 that it will be replacing. However, it will need AC line voltage layout power. The power supply that comes with the UR92 works on any mains voltage and frequency in the world, but has a North American plug. I selected the specific UP5 to replace due, in part, to its location. It was close to an outlet that is connected through our power switch to the Uninterruptible Power Supply. I plugged the power supply into the outlet and snaked the power cable out through the hole in the fascia [6].

ADVERTISEMENT

ADVERTISEMENT

**ANE Model**  
Navigator of Turnout & Doigital control

**LD101**  
Coming Soon

**ANE model**  
www.anemodel.com

**www.anemodel.com**

**www.SBS4DCC.com**

ESU TCS WOW Sound  
OSI Solutions ZIMO  
SOUNDTRAXX®  
NCE The Power of DCC DIGITrax™

DCC Specialties INNOVATION FOR DCC MRC Model Rectifier Corporation  
ACCUTRACK II SPEEDOMETER SPROG DCC The DCC Programmer and Control Family Digital plus by Lenz  
TAM VALLEY DEPOT Great Electronics for Great Model Railroads TEAM DIGITAL, LLC Improving the world of DCC

**N - HO - HOOn3 Scale Trains**

• INDEX

✉ SUBSCRIBE (free)

• TABLE OF CONTENTS



5. Mounting screws have been removed allowing the UP5 panel to slide out of the PCMRC layout.  
*Bruce Petrarca photo*



6. UR92 sitting in the fascia, ready to be screwed into place. *Bruce Petrarca photo*

# IOWA SCALED ENGINEERING

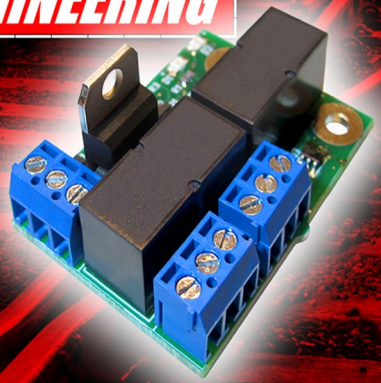

## MRServo Slow Motion Turnout Controller

[LEARN MORE >](#)

# TamValleyDepot.com

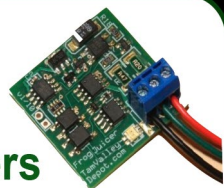

## Frog Juicers

Automatic DCC polarity reversers for frogs on turnouts and crossings.

## Servo Switch Machines

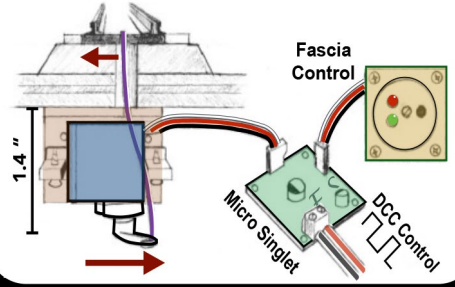

Make LocoNet wiring extremely simple!



### Suitcases belong in your baggage cars, not under you layout!

Introducing the DCC Vampire II ...  
this guy does the job of two suitcase  
connectors!  
And really holds the connection good  
too!

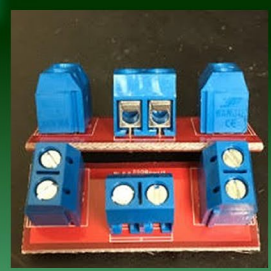

**CLICK NOW TO DISCOVER THE AMAZING VALUE!**

Dealer Inquiries Accepted

• INDEX



SUBSCRIBE  
(free)

• TABLE OF CONTENTS

## DCC IMPULSES | 9

Now it is time to screw the new UR92 in place on the layout. I like to use washers between the screws and the plastic-coated aluminum front panel. The washers keep the screw heads from grabbing the plastic and pulling it away, as shown in [7]. My preferred washers are the white nylon ones, as they disappear next to the white face plate.

Once the new base station (UR92) was installed [6], all that was left was to power up the layout, plug the new UT4D into any LocoNet socket on the layout, select a loco and run a train.

Wait a minute, I said you didn't have to plug in to select a loco. Yup, but the cab and the UR92 and the command station must agree that they are all part of the same family for communication to happen. Plugging the UT4D in and selecting a loco gives it time to get all those planets aligned. From then on, loco selection can be wireless.

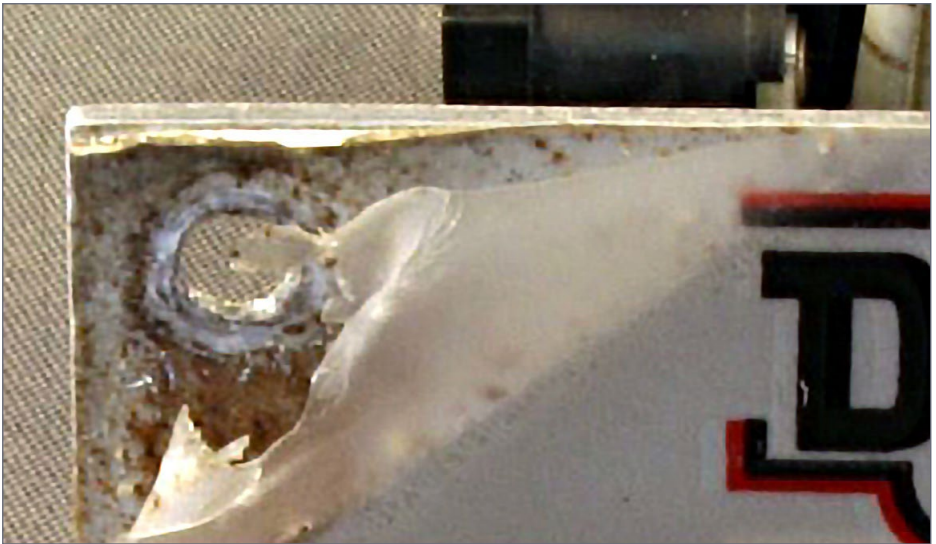

7. Screw damage to a Digitrax UP or UR plate caused by a lack of washers to protect the plate. *Bruce Petrarca photo*

## Can I convert my cab(s)?

Digitrax offers duplex radio conversions for DT400 series cabs (DT400, DT400R, DT402 and DT402R). When a DT400 or DT400R is converted to duplex, it will also be upgraded to the functionality of a DT402D. Similarly, the UT4 or UT4R can be upgraded to a UT4D. They must be sent to the Digitrax factory. Information and pricing is available on the Digitrax website ([digitrax.com/support/conversions](http://digitrax.com/support/conversions)). DT500 cabs can be converted to DT500D.

## Where can I use a cab with a “D” suffix?

These cabs can be used with the UR92 base in the USA, Canada, Australia and New Zealand.

## What about Europe?

There is a separate version of the duplex hardware to comply with European Union rules. The base panel is known as a UR92CE. The cabs have a “CE” suffix, instead of the “D” suffix. “CE” panels and cabs must be used with each other. They will not communicate with “D” or “R” series hardware.

## What about infrared cabs?

I understand why Digitrax offers an infrared option. It allows folks outside the EU and the USA, Canada, Australia & New Zealand block to have Digitrax wireless operation. Some folks feel it is better than no wireless option. I find that the line-of-sight needed to get a signal from the cab to the base to be very limiting. So, I do not recommend it.

Okay, so you can add a UR92 (or UR92CE) to your layout and immediately use “D” or “CE” series cabs wirelessly. If your layout is already wireless with a UR90 (infrared only) or UR91 (simplex



# DCC IMPULSES | 11

and infrared), the UR92 can be added and not interfere, allowing both simplex and duplex cabs to operate simultaneously.

## How did it work?

With a couple of operating sessions under my belt, I have found fewer operating glitches with the UT4D than I've had with my UT4R recently. Things seem to run more smoothly. I had fewer times where the loco ignored a direction change command. I never had loss of control, even on a friend's layout where the simplex system rarely operates properly for more than 10 minutes at a time, due to some local interference.

137,000 have seen this MRH video ... *have you?*



Watch the video now 

# Got Steam?

**Full Throttle Steam  
Available Now!!!**

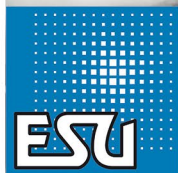
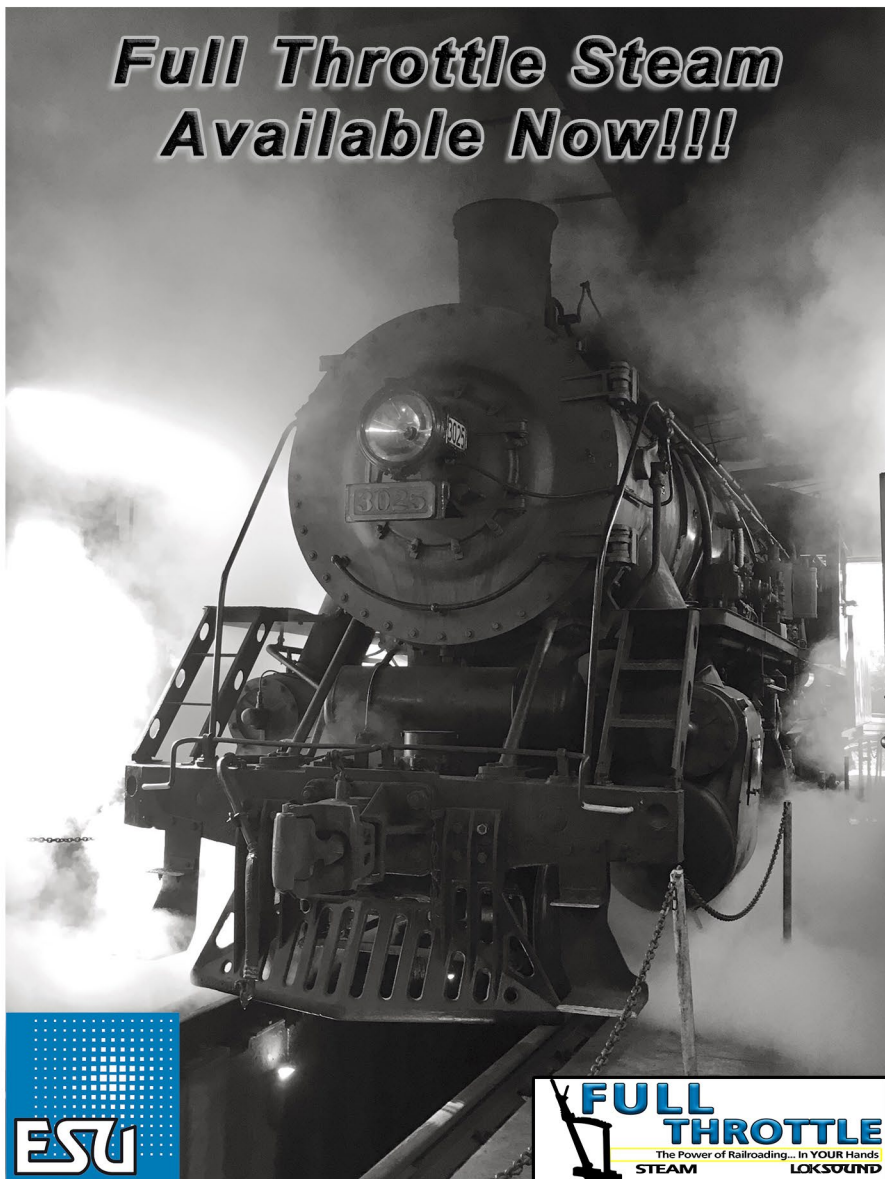

**[www.LokSound.com](http://www.LokSound.com)**

• **INDEX**



**SUBSCRIBE**  
(free)

• **TABLE OF CONTENTS**

## DCC IMPULSES | 12

Check out Mr. DCC's Workbench after this column. I'll be show you how to keep from damaging your Digitrax cab when you shut off the battery power.

Please share your experiences and ideas. Just click on the Reader Feedback icon at the beginning or the end of the column. While you are there, I encourage you to rate the column. "Awesome" is always appreciated. Thanks.

Until next month, I wish you green boards in all your endeavors. ☑



[Click here for reader comments](#)

ADVERTISEMENT

**TCS**

# WOWSound

**Version 4 of WOWDiesel  
NOW SHIPPING!**

WOWDiesel Version 4 Introducing the  
**645 Non-Turbo Prime Mover**

All with Unmatched CD Quality Sound at  
TRUE 16 bit Resolution that nobody else can  
come close to!

[click here](#)

Learn why loco sound fans prefer WOWSound ...

Remember you "Rivet Counters", Sound has rivets too and TCS counts them better than anyone!

[www.TCSDCC.com](http://www.TCSDCC.com)

• [INDEX](#)

• [TABLE OF CONTENTS](#)





# Southern Digital

WWW.SODIGI.COM

Celebrating 25 Years of serving you !



**Soundtraxx Tsunami  
Motor/Sound Decoder**  
**50% Off while they last**

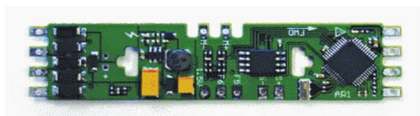

**Super Sale**



Simplex Radio  
Throttle clearance  
while they last



**Close Out**

**DT402R**  
**\$165**

**UT4R**  
**\$99**

**DCC Conversions, Service & Support**

E-mail: [sales@sodigi.com](mailto:sales@sodigi.com) (770) 929-1888



• INDEX



SUBSCRIBE  
(free)

• TABLE OF CONTENTS

## MR. DCC'S WORKSHOP

### Hints for Digitrax cab batteries

Mark Juett has become a friend of mine. Mark writes the DCC column for the *NMRA Magazine*. In a recent issue he shared an idea that I really like. I asked him for permission to share it with my readers and he was gracious enough to allow me to do so.

All Digitrax cabs prior to the DT500 require that you remove the battery connection to power down the cab. This involves either completely removing the battery, or rotating it 180 degrees to reverse the battery voltage. The cab is protected against reverse polarity, so this rotation effectively disconnects the battery.

Some talented folks even cut a slot in the battery door, allowing them to insert a piece of plastic between the battery and the terminal to shut the cab off.

The problem is that some folks will flip the battery end-for-end. This places the battery terminals in contact with the spring clip



8. UT4 cab spring end. Shrink tubing has been added to the lower spring. This shows a “before and after” of the installation, making it easier for the shape of the metal spring to be seen in a photo.

*Bruce Petrarca photo*

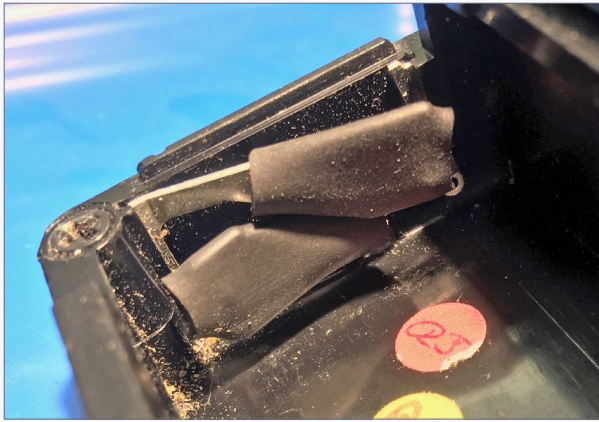

9. UT4 cab with the tubing installed and shrunk. I did both sides of the spring. Theoretically, only one needs to be insulated. However, I believe in over-kill for safety.

*Bruce Petrarca photo*

in the housing. The resulting short circuit is hard on the batteries and can melt the plastic housing.

Mark suggested slipping some  $\frac{1}{4}$  inch diameter shrink tubing (about  $\frac{1}{2}$  inch long) onto the spring ends to insulate them. Once the tubing is shrunk in place [9], the spring is protected.

Such a simple solution, thanks for this great tip, Mark.



10. DT500 cabs have an on/off switch included, so they don't need their batteries flipped to shut them off. They have a different style of spring, making the insulation technique

discussed here difficult. I have chosen not to insulate my DT500. *Bruce Petrarca photo*



# Introducing

Complete Train Control

## *The next Evolution in* Complete Train Control®

- Premium Advanced 5/8 Amp Starter Sets.
- Starter sets are available as standard tethered or duplex radio.
- The system features a DCS210 Advanced Command Station, DT500 series throttle, and includes a power supply to make getting started easier than ever.
- The DT500 series throttles can be purchased separately from the new Starter Set.



Find out more @ [www.digitrax.com](http://www.digitrax.com)

E  
St  
DT  
PS  
  
E  
D  
DT  
PS

# the **EVOLUTION**™



## Evolution (shown) | **\$450 MSRP**

Standard Set Includes: DCS210 Advanced Command Station, DCS2500 Advanced Super Throttle, UP5 Universal Panel, 6615 power supply, and a LT1 LocoNet Tester.

## Evolution Duplex | **\$660 MSRP**

Duplex Set Includes: DCS210 Advanced Command Station, DCS2500D Advanced Duplex Throttle, UR92 Universal Panel, 6615 power supply, and a LT1 LocoNet Tester.



# WISH: Shadow expert home layout builders and learn their best tricks ...



2.5' X 7'

## GRANTED:

MODULE 3  
2' X 7'

# In the 2017 TMTV season, we do just that.



Brought to you by  
**MRH**  
MODEL RAILROAD HOBBYIST

# TRAINMASTERS.TV

Don't miss out: Click now and join in!

DCC system provided by  
**NCE**  
*The Power of DCC*  
ncedcc.com



MIKE ROSE  
.....

# GETTING REAL

column



[Click here to rate or comment on this article](#)

## LAYOUT KABOOM | ... WHAT THE IMPLICATIONS ARE WHEN YOU GO ALL-IN!

**THE TERM “LAYOUT KABOOM” GOES BACK QUITE** a while. It was originally coined by my buddy Dave, who often showed up on Train Night (as he faithfully did) with a whole new-and-improved concept for the layout. He'd explain the whole thing – and the ideas almost always had a lot of merit, but inevitably required tossing out of hundreds of man-hours of previous work. I'd point that out to him, and he'd grin heavily and simply say “layout kaboom!”

I'll admit that my layout has probably been rebuilt more than most. I started out with half a basement and a totally freelanced “somewhere in Pennsylvania” model railroad set in the early 1990s. It has evolved into a largely prototype-based layout set in 1984 or 1985. I'm still fine-tuning that year decision, based on constantly evolving new roster information that I come across. It now occupies the entire basement.

The prototype modeled is Conrail's Lehigh Line ( former Lehigh Valley) from Pittston PA to Sayre PA. Previous columns have dealt

► **MODELING REAL RAILROADS AND WHAT THEY DO**



# GETTING REAL | 2

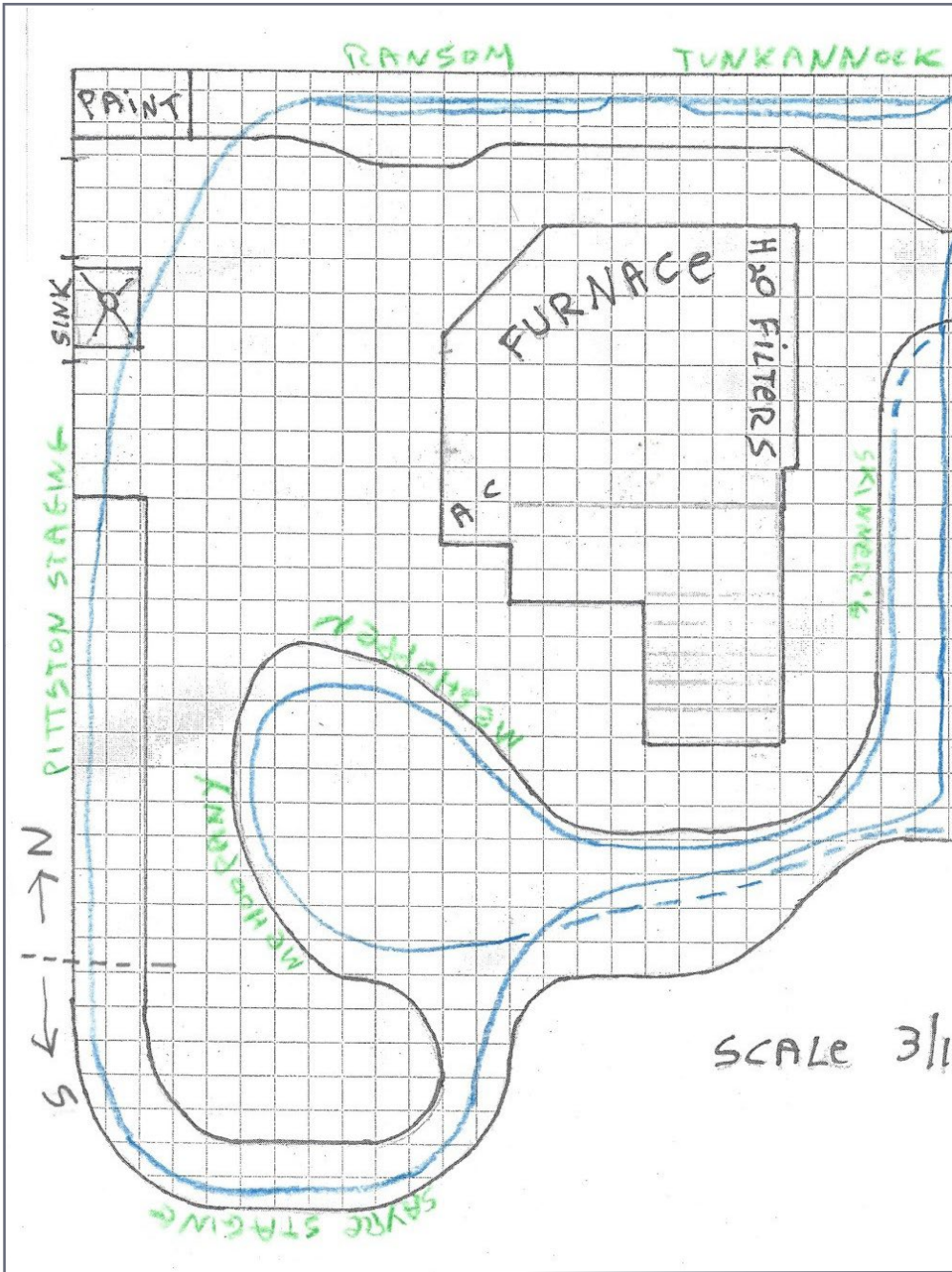



## GETTING REAL | 3



with how I used the relocation of utilities to create more layout space, but I am always looking for ways to better use existing space.

In my last column, I mentioned how I decided to create space for building Pittston Yard by dropping an existing staging yard. Of course, the method of actually getting TO the dropped staging yard still needed to be solved. I toyed around with various helix concepts and even considered building a new install desk *inside* the helix, but none of these options appealed to me. In order to better understand the issues, I decided to make a scale drawing of the basement, the benchwork, and existing layout trackage [1]:

1. My hand sketch here reveals the towns of Ransom and Tunkhannock, areas with working track but otherwise “to be built,” and an area created by moving the air conditioning and water treatment equipment. Entry to the basement is via a walk-out side door. The doorway is between the sink and paint booth on the left. Dotted lines indicate hidden track and the Conrail main line is in blue.

6" = 1'



## GETTING REAL | 4

The significant point to keep in mind at this point is that what is now marked on the left as Pittston Staging will be Pittston Yard, and we need a way to get to the staging yard underneath. The empty area bordered by the sink, AC, and the Mehoopany/Meshoppen peninsula is where the desk fitted for my DCC installation business is, and where I was considering a helix.

It would have worked, in that we could have used it to get to the lowered staging yard. But, as my friend Dave so aptly pointed out, “it sure would have been nice to have trains run *through* Pittston”. Since that would have required track on the south end of the yard and I saw no way to do that, I dismissed it. Even so, it gnawed on my brain.

I kept thinking that there must be a way to do it. For two months I chewed on this: mentally, staring at the diagram, then walking away from it. Eventually, on one of my walks, I got a bright idea: use the whole basement as the helix! This would save space and allow trains to arrive into Pittston from the south. But, could I build it without blowing up the whole thing up and starting over?

The key proved to be the two tracks showing on the far right. These two hidden tracks are actually built into a groove in the wall, with the exposed concrete wall visible behind them. (That is, if they weren't hidden!) In previous iterations, these provided a path for trains to go back and forth. I realized that the way these tracks were being used currently wasn't necessarily etched in stone and if I used them differently, I might be able to pull this off.

Putting colored pencil to paper again, I came up with the following [2].

Now, just because you can do something doesn't mean that you should! I took some time to think this through, and ran it by several of the ops crew regulars to see if the concept was sound and the disruption would be worth it. After all, I'd finally arrived at a working

## GETTING REAL | 5

layout that ran well and held regular op sessions, and it seemed like no sooner had I done that, I would be throwing it all away.

To understand the true scope of the effort, I decided to lay out the steps in the entire project and assign some rough man-day estimates to each task. This helped me to establish the scope of the effort, would allow me to keep track of things as I went along, check things off as “done,” and not miss an important step. Marking off items on a checklist is always good for morale.

Clearly this was to be the most complicated layout project I’d ever done. Here’s a page from my final work plan [3]. Bear in mind it evolved during the project, with some scope changes and whole new segments added. For example, the last “Getting Real” column’s East Yard effort was not originally thought of as part of this plan but it became obvious during demolition that there would never be a better time to do it.

ADVERTISEMENT

# SPECIAL!



Layouts 1 and 2 DVDs:

**GET BOTH FOR \$39.99 >>**  
+ shipping/handling

Layouts 1 and 2 Download:

**GET BOTH FOR \$ 19.99 >>**

Get Layouts 1 and 2: That’s 28 inspiring layout in all!

• [INDEX](#)



**SUBSCRIBE**  
(free)

• [TABLE OF CONTENTS](#)

# GETTING REAL | 6

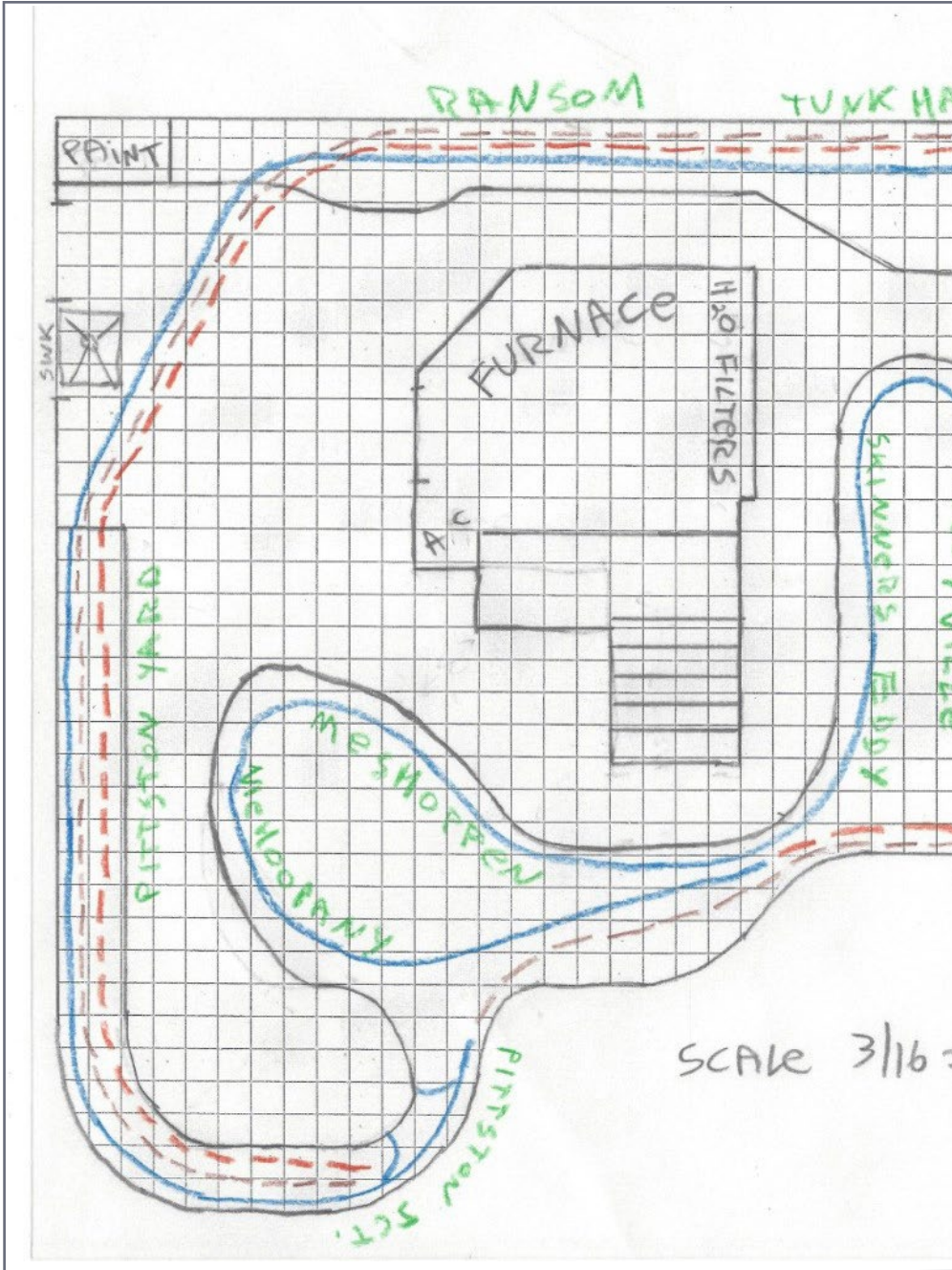

# GETTING REAL | 7

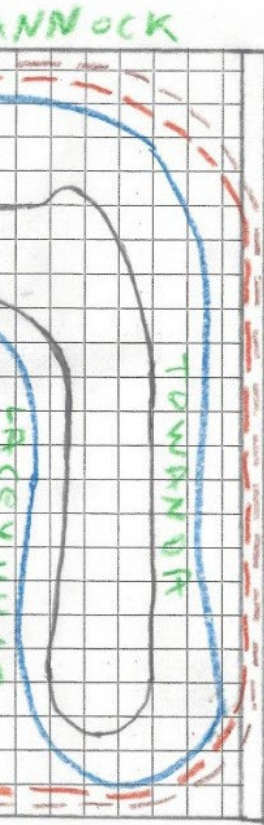

- VISIBLE CONRAIL MAIN LINE
- - - HIDDEN ROUTE TO ALLENTOWN STAGING
- - - HIDDEN ROUTE TO BUFFALO STAGING

2. This hand sketch shows my exploration of the “whole room as a helix” variation. By adding different connections on either end of the two hidden “groove tracks” and by using almost three walls of the basement to descend to the new staging yard, I could make this work.



# GETTING REAL | 8

Complete	Priority	Task	Duration	Timeline	Work Scheduled for....
Y	1	Move A-Line carts to garage. Move red tool chest under Ransom to cart area. Remove paint rack and consider consolidating to smaller paint rack in elec panel area.	1 man-day	April	
Y	2	Make track cuts, feeder cuts, remove Tunkhannock sub-roadbed to stream	1 man-day	April	
Y	3	Raise Ransom-Tunkannock 2.25" in height	1 two-man day	April	Train Night
Y	4	Remove viaduct on other side of aisle from aisle to Milan siding switch.	1 man-day	April	
Y	6	Extend 4" sub-roadbed for two tracks from bridge location at Ransom to Tunkhannock, underneath.	2 man-days	April	
Y	7	Lower main line track ("front track") from former Presswood to Milan siding switch to head down, not up (behind Masonite). This gets extended to meet up with main on Tunkhannock level.	2 man-days	April	
Y	9	Lower main line from Towanda under former viaduct to head down under Tunkannock/Ransom.	1 man-day	April	
Y	10	Remove right hand old staging ladder, remove old sub-roadbed to bridge, remove old wiring and panel.	1 man-day	April	
Y	13	Prep for lowering staging yard: add wall cleat at new height, add temp legs of proper length, add front joist stiffeners at joints, add cross joint stiffeners at rear.	1 man day	April	Week of 4/18
Y	14	Remove left hand old staging ladder, remove old wiring and panel.	1 man-days	April	Week of 4/18
Y	16	Lower and shorten DCC install desk, add casters, trim lower shelf to allow sitting more under it, design to roll under new Pittston/PNE benchwork.	2 man-days	April	
Y	17	Lower existing staging yard to staging feeder track height.	1 two-man day	April	Week of 4/18
Y	20	Build staging connection and new main line connection from cross aisle bridge to Pittson and lower staging.	1 man-day	April	Week of 4/25
Y	21	Build new 3-track double height cross aisle bridge	5 man days	April	Week of 4/25
Y	22	Install cork for RH staging ladder	1 man-day	May	Week of 5/2

3. Time estimates for each phase gave an idea how big a project my layout improvements would become. The entire plan was about four printed pages. If anybody would like the entire spreadsheet or PDF of the whole project, please message me directly and I'll be happy to share it! Taking the above project plan chronologically, you can see that once I moved my A-Line storage carts out into the garage to make room, it was time to start the major surgery!



[Click here to rate or comment on this article](#)

# Bowser

## HO SD40-2F

CP Rail



## HO Baldwin AS-16, AS-616, DRS 6-6-1500

Road Names: C&O, Erie Lackawanna, Milwaukee Road, Minneapolis, Northfield & Southern, Pennsylvania, Reading, Southern Pacific, & Western Maryland



## HO MLW M636

Road Names: CN, CP Rail, Cartier, WNY&PA, Delaware-Lackawanna, & Minnesota Commercial

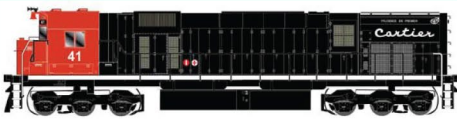
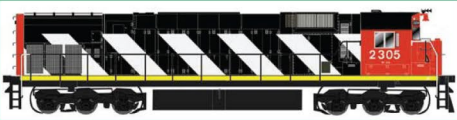

Click here to check out the details for these and other great Bowser Products

[INDEX](#)



SUBSCRIBE  
*(free)*

[TABLE OF CONTENTS](#)

## GETTING REAL | 9

The first thing I decided to do was to raise Ransom and Tunkhannock. This was partially to give me clearance to get the new hidden tracks underneath them, and also to allow me to build those two new tracks.

The next article, as a follow-up, will deal with the massive re-do of the entire Skinner's Eddy peninsula, and subsequent columns or articles will deal with the many other phases of this work, including Pittston Yard itself. We'll wrap it all up with a column (and maybe a video!) of the first and subsequent sessions, lessons learned, and plans for the future. What, I'm not done? Stay tuned ...



4. The carts I'd built long ago to hold my A-Line storage boxes were rolled one at a time out of the basement, up the driveway, and into the garage where I'd cleared a space. They were to stay here nearly a year.



## GETTING REAL | 10



5. The above shot shows Tunkhannock has “flipped its lid!” I severed the track and wiring connections and simply stood it up against the wall, track and all, to allow access to the areas below.



6. How do you raise a layout section by yourself? Why, with a hydraulic jack, of course! Once Ransom had been disconnected from the wall, it was simple to jack it to the correct height and reattach.



7. No it's not the result of an earthquake, but it does show how much Ransom got raised from its original height.

## GETTING REAL | 12



8. The pesky blue water pressure tank that has plagued many of my layout efforts was at it again! There was only one way to get two tracks to pass underneath Tunkhannock, and that was to sneak them behind the tank near the top. Clearances were tight – I just made it. The strange L-shaped plywood brackets were created so that I could chop off the existing joist ends. This was the area the new tracks needed to pass through.



[Click here to rate or comment on this article](#)





9. Looking into the original layout room and heading towards the paired hidden tracks in the “groove,” you can see the new hidden tracks diverge. The left hand path will ultimately exit at Pittston Jct., while the right fork will allow the new main line to go through Towanda. Previously this was not the case, and I considered this a major improvement over the original hidden main line route.



10. Looking back towards the tank and staging, you can see how the original joist ends have been cut off, and the way the new brackets now tie the benchwork to the wall.



11. Viewed from underneath, you can see the “slot” created where the new pair of tracks will be installed in the cut-out of the L bracket.

**Want to help keep  
MRH free?**

**Then *click* on ads!**



12. Ready for track! The new pathway to the lowered staging yard is in place below Ransom and Tunkhannock.

## GETTING REAL | 17



13. How do you lower a 22-foot-long curved staging yard? You do it very carefully and with a lot of planning. Shown here are temporary legs screwed to the front of the existing yard benchwork, along with cleats on the wall where the rear of the bench work will rest until screwed to the studs.



[Click here to rate or comment on this article](#)





14. With the advance prep done, on train night I had my wife, Karen, and buddy Dave to help steady the entire thing while I went underneath and started removing screws from the walls from one end to the other. It got a little exciting at one point but largely went as planned.

# Please tell your buddies about MRH!

WE RELY ON WORD-OF-MOUTH TO GROW AND A BIGGER CIRCULATION MEANS MRH IS MORE LIKELY TO STICK AROUND FOR A LONG TIME TO COME!





15. This close-up shows the original height of the yard and its new height. My plan was going to be to connect it to the lower track in front of the retaining wall – but that all got scrapped once I began planning Pittston Jct. and especially the new East Yard. The current staging yard is stubbed on this end and is divided into two four-track segments (north and south) about 22 feet long.

## GETTING REAL | 20



16. Since my clearances between the new Pittston Yard and the dropped staging yard were less than ideal, I decided not to use a conventional splice plate between the sub-roadbed sections and instead to use my new favorite tool: The Kreg Jig and pocket holes.



[Click here to rate or comment on this article](#)



## GETTING REAL | 21



17. I created an entirely new yard ladder for staging, removing the old Custom Trax turnouts but leaving the track and using new Pecos. You can also see the cleat for the new staging yard on the wall.



[Click here for  
reader comments](#)



18. The pre-cut sections of new sub-roadbed are staged for installation. The straight sections could easily be attached to the wall cleats and I used shelf brackets for the curved section.

***TrainMasters TV is part of  
the MRH product family.***

*TMTV members not only get great network TV level  
videos, they help pay for MRH and keep it free ...*





19. Wooden blocks are used as temporary supports for front of the new segment. You can't have too many levels for this kind of work.



[Click here to rate or comment on this article](#)





21. The temporary wood blocks have now been replaced by threaded rod. I recessed the nuts on top so they would not protrude above the cork. I'm using threaded pipe hangers as the bottom fastening point for the rod, since the new yard is slightly wider than the lower staging yard.

**Did you know  
there's an  
MRH index  
available?**

**CLICK TO FIND OUT MORE**



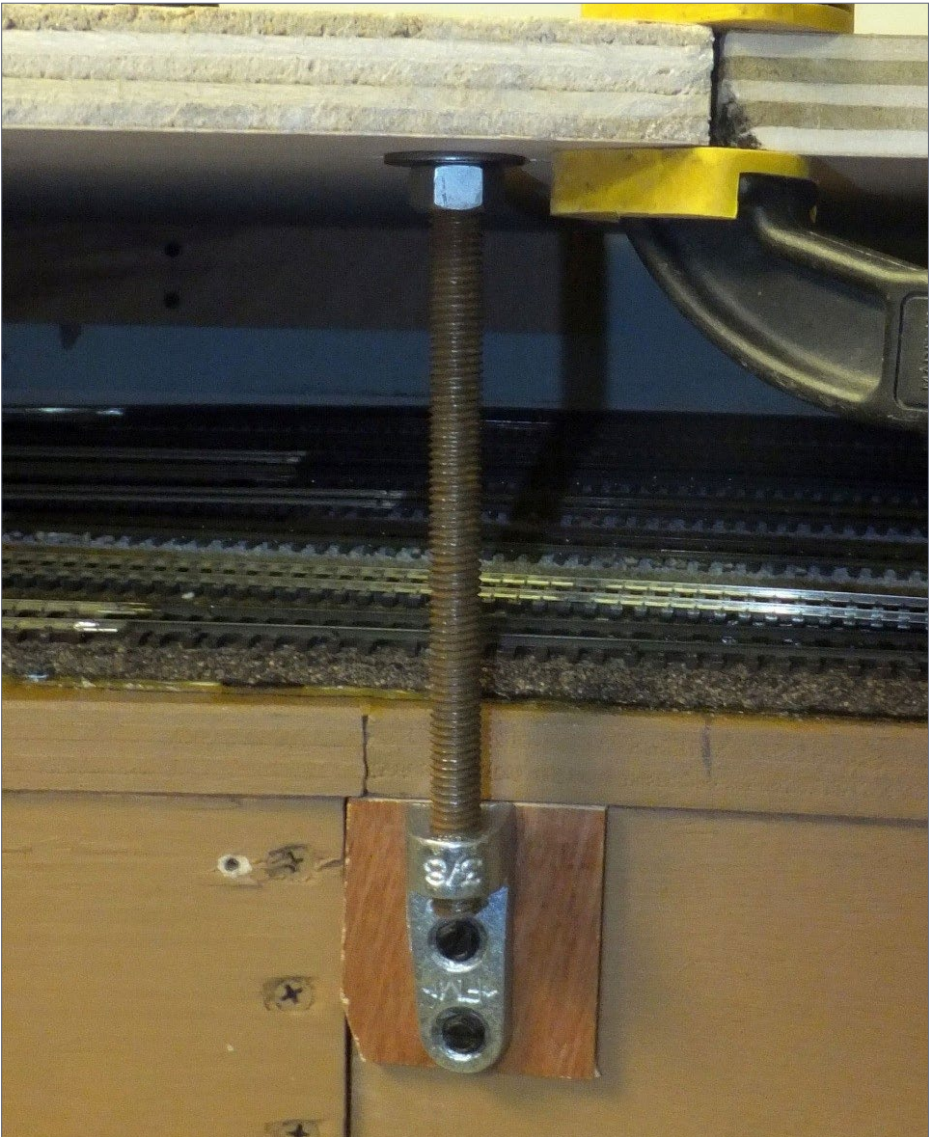

22. This close-up shows the threaded rod mounting. I employed nylon stop nuts for the top connection, which is a real pain, but I didn't have to account for the thickness of lock washers and won't have to worry about them loosening up at some point.

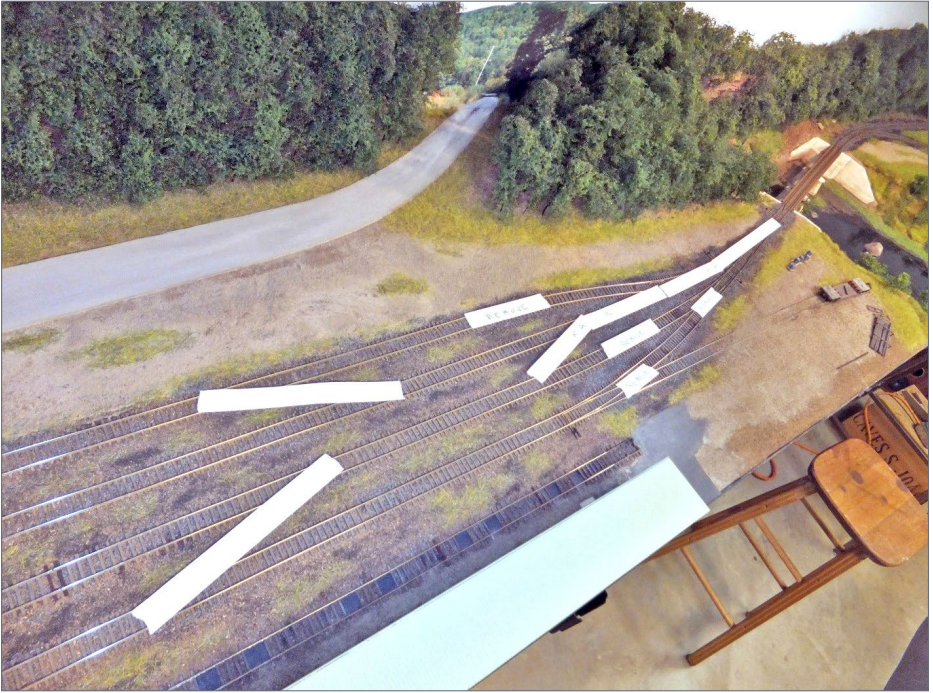

23. Back in Towanda, the yard ladder needed major changes for it to now look like a main line track was going through here. We're using tape and labeling everything, then taking pictures to guide the rebuilding effort.



[Click here to rate or comment on this article](#)



24. I wanted to get some elevation to get that “main” feel. I didn’t want to have to accommodate a full quarter-inch for the cork, so I used 1/8” foam for the first time.





25. A spray bottle of water and an old chisel proved to be the right tool combo for modifying the existing ballasted track and turnouts. I had to work carefully here because I didn't want to gut what was previously a finished scene.



26. New Peco code 83 flex track was glued to the foam with DAP acrylic caulk. Here I'm masking off the surroundings so that I can paint the new flex track with camouflage brown spray paint.

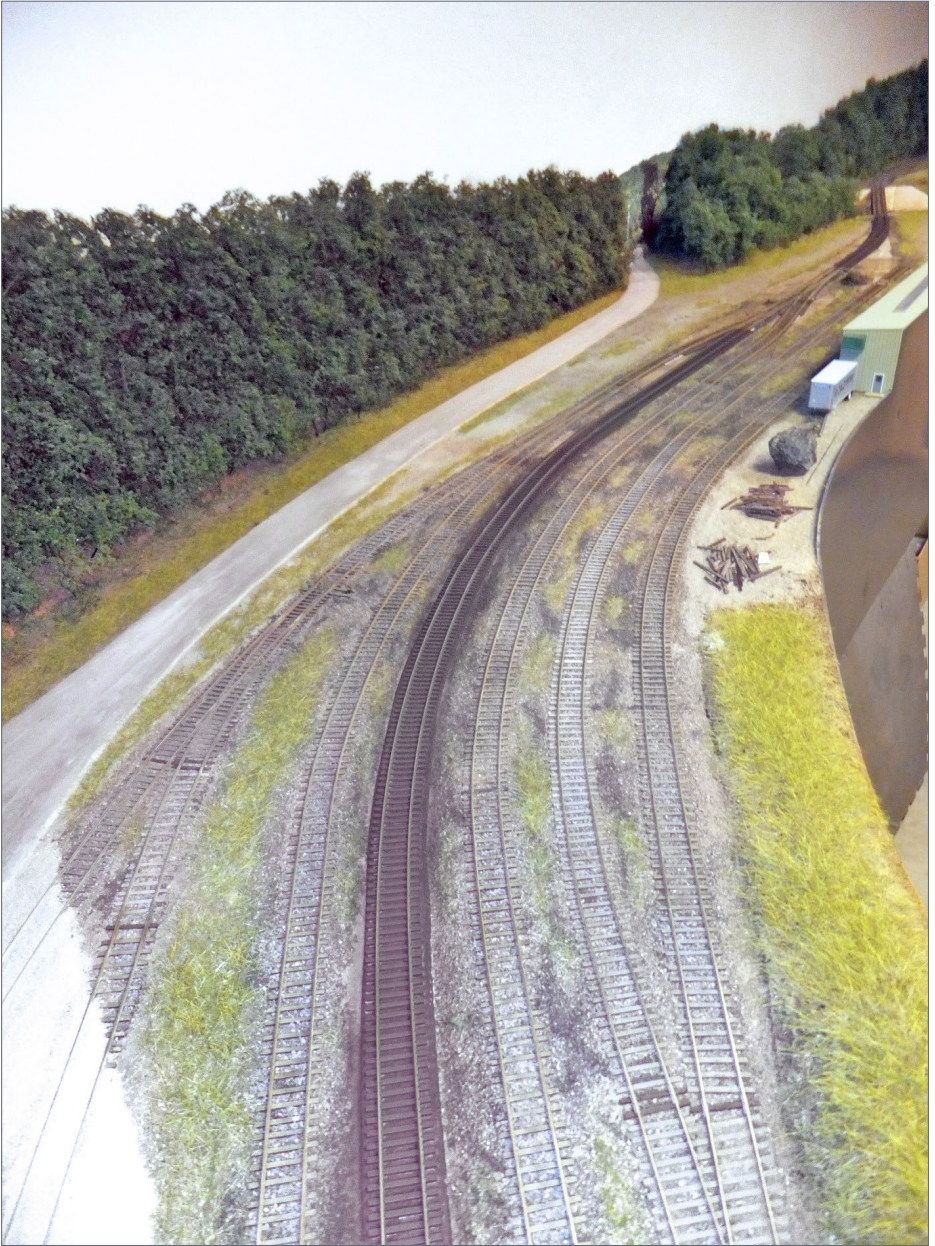

27. The newly painted main line is in place, ready for ballast.



28. The yard track on the left has been greatly shortened. Here's the freshly ballasted main in front of the Masonite plant.



29. Here's the view from the opposite end, coming off the bridge over the Susquehanna River into Towanda. The former yard track closest to the green building (Osram Sylvania) is now on the branch line to Monroeton.



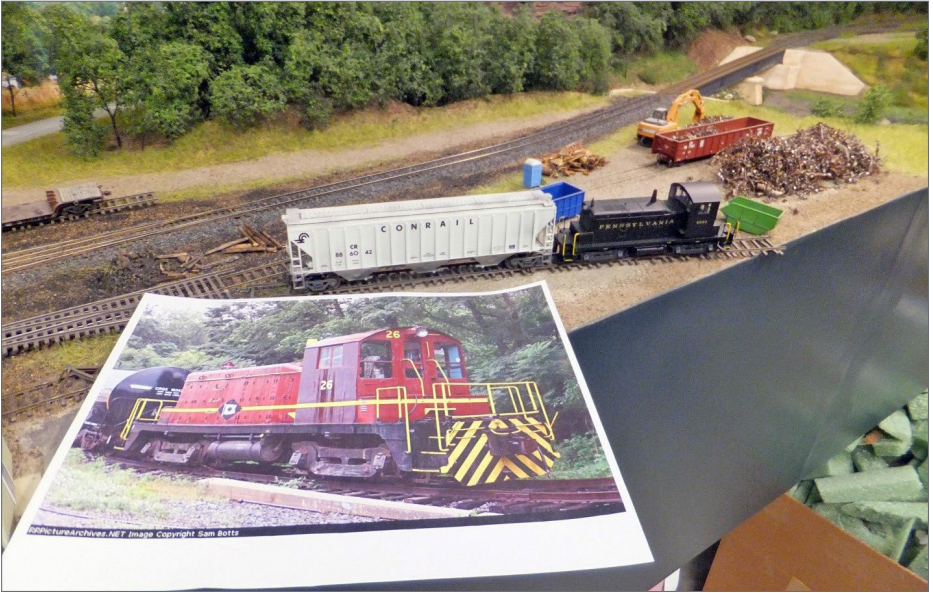

30. The final modifications including the branch line heading off the layout to “Monroeton.” The picture is of the Towanda-Monroeton Shippers Lifelike SW-1, and the PRR unit shown is being painted for me in that scheme by my friend Bob Harpe. Op sessions will start just like this, with the switcher and a grain car coming off the branch, switching the scrap yard and a couple of other consignees and interchanging with Conrail. The depressed center flat car peeking out in the upper left corner is on the newly relocated Pennsylvania Power & Light siding, and the scrap yard is mocked up in the former PP&L area. Why did the scrap yard need to be moved? Well, because the Agway Fertilizer Mixing facility was relocated there, so I could put Wyalusing Planing Co. where that used to be, so ... you can see why I needed a project plan! ■



[Click here to rate or comment on this article](#)



# WHAT'S NEW on TMTV!

Non-members: Watch episodes for \$1.49; become a member for unlimited access



Make it run like a **Dream**: TRACKWORK



Start Small **THINK BIG.**

TOMA project layout: wiring

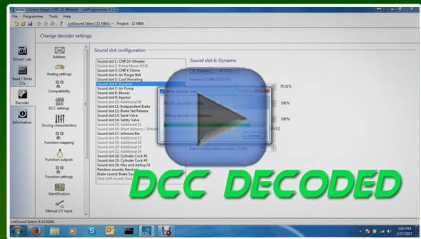

**DCC DECODED**

DCC Decoder function remapping



Jerry Fassnacht's Pennsy & Reading



**Crew Call**

New ops series: Crew Call



# TRAINMASTERS.TV



• [INDEX](#)

• [TABLE OF CONTENTS](#)



# WHAT'S NEAT WITH KEN PATTERSON

column

KEN PATTERSON  
.....



[Click here to rate or  
comment on this article](#)

## NIGHT PHOTOS BY FIRELIGHT, A SPECIAL CHALLENGER, LOK SOUND, AND MORE FOAM SCENERY ...

**THIS MONTH, GEORGE BOGATIUK STOPS BY TO** show us his tricked-out Union Pacific 3985 Challenger locomotive, complete with sound in the boiler and an array of servicing lights all around the model just like the prototype. For layout construction, I present an update on the progress of my BTS Saw mill complex, and show how I built the benchwork to be functional and have a furniture like appearance.

For photography, this month we shoot a model photo using real fire to light the scene with pretty dramatic results. Matt Hermann from ESU LokSound explains in great detail how no two prime movers sound the same, with variations from cylinder count to motor block size and all the various other mechanical details that effect the way locomotives sound while operating. Matt explains how LokSound captures these sounds for our model

▶ [PHOTOS AND VIDEO OF SUPERB MODELS](#)



## WHAT'S NEAT | 2

locomotives. For scenery construction, we carve a scene in foam to include the correct track profile dictated by water runoff from rain. We do this in real time in the video in just a few minutes, showing the process and the tools while showing just how easily it can be done.

### Fire photo shoot



1. (Above) This is a special promotional photo I made for the Athearn First Responder train set. Using fire to light the scene. It is creative and dramatic, and now I will show how you can shoot a model photo like this.

2. (Top right) Here you see the basic set up. The train set is sitting on Bachmann E-Z Track on a four-foot-long piece of foam. My painted mountains flat is placed to fill the background scene.

I am shooting the photo in total darkness outdoors, lighting the train set for only a few seconds with a flashlight. The camera is set to "bulb" ('B' on the shutter speed dial) so the shutter can remain open for the two-minute-long exposure. My ISO is set to 100. The f/stop is closed all the way down to f/22.

# WHAT'S NEAT | 3



Playback problems? [Click here ...](#)

• INDEX



SUBSCRIBE  
(free)

• TABLE OF CONTENTS



3. While the shutter is open, I walk and wave the fire around the tops of the mountain peaks. I also cast some of the firelight on to the train set and the lower front portions of the mountains.

**Want to help keep  
MRH free?**

**Then *click* on ads!**

## WHAT'S NEAT | 5

### George Bogatiuk's 3985 Challenger



4. George Bogatiuk from SoundTraxx created this UP 3985 showpiece. George used a small SoundTraxx cube speaker enclosure just inside and under the front smokestacks so the sound will sound like it is coming from the pistons as the locomotive rolls by. George also installed an 18x40mm speaker in the tender to further enhance the sound.



[Click here to rate or comment on this article](#)



## WHAT'S NEAT | 6



5. The locomotive has LEDs installed in the headlight, marker lights, and cab light along with an array of service lights all around the locomotive. He used 603 golden/white LEDs, which SoundTraxx may add to their line of LEDs, which can be found online at [soundtraxx.com/access/wiring.php](http://soundtraxx.com/access/wiring.php). George uses a Tsunami2 steam decoder which allows him to control the brightness of this locomotive's lights through CVs 61 and 62. He wired the class lights and the number board lights on CV 61 and the running lights and cab lights on CV 62.



## B.T.S. Sawmill project up date



6. This is a photo of my partially-complete benchwork to hold my B.T.S. sawmill diorama measuring nine by three feet overall. This month we will build the benchwork for this new section of my HO scale 3-foot narrow gauge line.



[Click here to rate or comment on this article](#)



## WHAT'S NEAT | 8

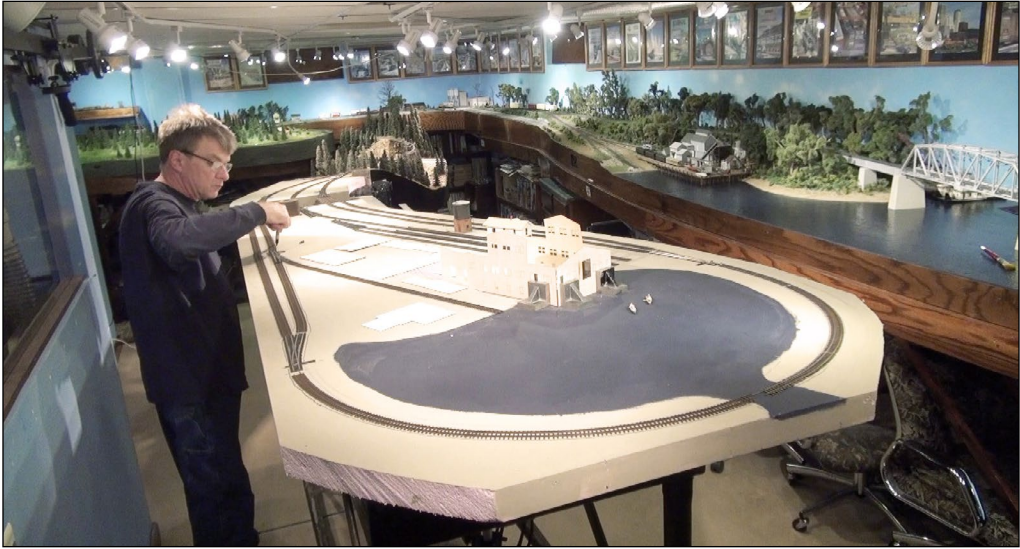

7. I start the process of building the B.T.S. sawmill complex by figuring the space required for all the buildings, and then place track around the scene with function, operation, and a minimum radius of 27 inches in mind. I draw lines with a black Sharpie where the tracks will be placed around the buildings and through the module.



[Click here to rate or comment on this article](#)

*Have you seen this?*

**CHECK IT  
OUT!**



**kenpatterson.com**

*click here to ...*

**Visit Ken's website**

**Ken Patterson  
reveals his modeling  
secrets on video!**



## WHAT'S NEAT | 9



8. I then start stacking or layering two-inch-thick sheets of foam, gluing them together with Foam Pro Adhesive.

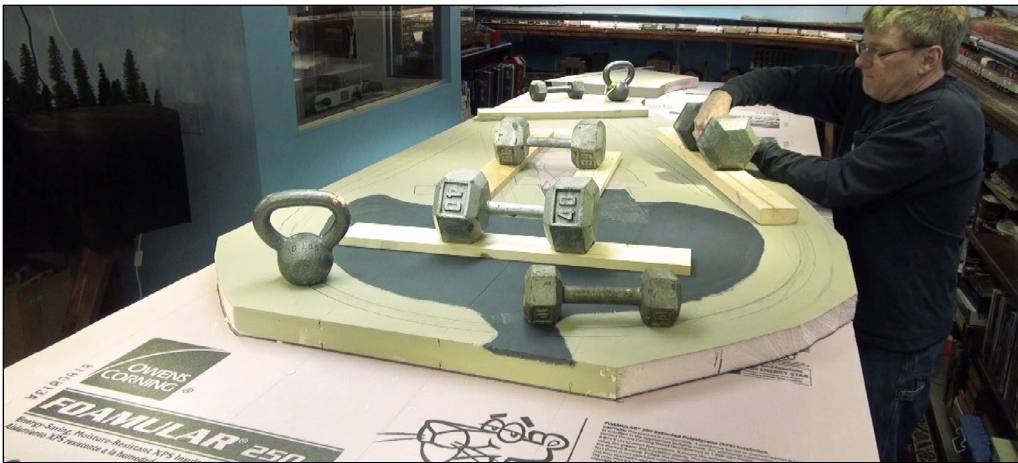

9. I place an assortment of weights and boards on top of this foam stack for about 30 minutes until the glue cures. Then, I cut around the edges of the new layer of foam until it is cut flush with the top layer.



10. I repeated this process and glue a third layer of foam in to place, making the module six inches thick. I cut around this layer of foam with a Chinese pull saw, squaring off the sides of the module and pull away the excess foam to reveal the over-all look.

## Please tell your buddies about MRH!

WE RELY ON WORD-OF-MOUTH TO GROW AND A BIGGER CIRCULATION MEANS MRH IS MORE LIKELY TO STICK AROUND FOR A LONG TIME TO COME!



# WHAT'S NEAT | 11



11. To hold the foam module I build benchwork from 2x4s, measuring from the floor to the top of the railhead. Every leg had to be cut to a different length as I was not going to use leg levelers on this project. Compensating for the uneven concrete floor ensures a level surface for the entire diorama.



12. I attach these two-way locking wheels I found at Home Depot. It is very important to be able to both lock the wheel and to also lock the pivot. Locking this pivot point ensures the module won't wiggle from side to side, ensuring solid and tight benchwork.

## WHAT'S NEAT | 12



13. I rout all the corners on the wood benchwork with a 1/2-inch curved bit. I then sand the wood with 150 grit fine sandpaper to make everything smooth to the touch. I then stain the benchwork with red oak stain and applied three coats of polyurethane to give the benchwork a furniture-quality appearance.



[Click here to rate or comment on this article](#)



## WHAT'S NEAT | 13



14. Now it is time to put all the pieces together. I roll the benchwork into position close to the bridge module that will connect with the sawmill diorama. If my measurements are correct, the rail height will match perfectly on both scenes as they go together. I slide the sawmill diorama on top of the smooth benchwork. I carefully position the foam even and square to the benchwork, matching marks I drew on the foam underneath to ensure an exact placement on top of the benchwork.



[Click here to rate or comment on this article](#)





15. When I roll the scene into position, it matches the height of the adjoining module perfectly. I love it when a plan goes together.

***TrainMasters TV is part of  
the MRH product family.***

*TMTV members not only get great network TV level  
videos, they help pay for MRH and keep it free ...*





16. To prevent the foam from sliding on top of the bench work when pushed or bumped, I drill countersunk holes in to the bottom of the wood, and drill three-inch screws up into the foam. This holds it firm yet makes it easy to detach quickly to move the layout outside for photos or video when needed.

**Did you know  
there's an  
MRH index  
available?**

[CLICK TO FIND OUT MORE](#)

## WHAT'S NEAT | 16



17. I also attach or hang brass plumb bobs to each end of the benchwork. These will point to an X on the floor when the benchwork is positioned in the room. This ensures the modules will be replaced in their exact location in the room after being moved for maintenance or photography. When the benchwork is back in its location, make sure each plumb bob points to its X. Then simply lock the wheels, slide the rail joiners on the track into position, and you're ready to run trains.



[Click here to rate or comment on this article](#)



# WHAT'S NEAT | 17

Matt Hermann, ESU LokSound



## WHAT'S NEAT | 18

18-19. (Left, top and bottom) In this month's video, Matt Hermann of ESU LokSound makes the point that every prototype locomotive has various characteristics that makes its sound different from others on the rail, even locomotives of the same type. It's an amazing presentation to watch, and he gets faster with the information all the way to the end. I took notes and will try to convey his points here. As he went through a line of 12 or so locomotives of various types, he described starting with the GP38-2 with its 16-cylinder non-turbo 645E prime mover. LokSound recorded four variations that can be download directly into your locomotive's decoder.

He said they also recorded turbo and non-turbo 645 prime movers, 16-cylinder 645E models, the 12-cylinder 645E, and the eight-cylinder 645E. EMD also used the 645E for the GP15 and SW1500. Matt says LokSound also recorded 567 prime movers in 16-cylinder, 12-cylinder, eight-cylinder, and six-cylinder versions. All sound different. Then there are updated 567 prime movers with 645 power assemblies with varying stack arrangements. The 567 D3 prime mover was used in the SD24, and GP35. The 567 turbo-diesel in the GP20 has a different idle speed than the others.

The Alco 12-cylinder and 16-cylinder 251 prime mover was used in variations C, D, and B with electric start or air start, and different governors. The Alco C420, RS11, and RS18 all had variations of the 251 prime mover, all recorded and available on the LokSound site for download.

The SD39 in Athearn's #340 is the only one in existence, so LokSound recorded that very locomotive. The 645 16-cylinder turbo in the SD40-2s, the 645 12-cylinder turbo in GP39-2s and SD39s, the 16-cylinder 654-E3 found in SD40s varied in high idle and low idle; in extended-range dynamic brakes, non-extended dynamic brakes, and no dynamics at all. There are different fans, etc. The -2's and -3's have different rates as to when various appliances are activated. There are the 20-cylinder SD45-2s SD45T-2s, etc. ...

*Caption continues on the next page ...*



# WHAT'S NEAT | 19

While everyone pays attention to scenery, roads, trees, scale handrails, and scale wheels, it's important to point out the fourth dimension of detail, "SOUND". That is what LokSound strives for by making scale model locomotives sound exactly like their specific prototype right down to the specific characteristics of any serial numbered locomotive block. It's an amazing presentation to watch on video – then he goes on to demonstrate the sound in the Canadian Pacific Alco locomotive on the layout.

## Layout construction: Carving track profile topography in foam



20. As we got together to run some trains on the layout on Saturday night, Ed Richardson asked me, "Ken, how do you carve the track profile in your foam scenes to look so realistic? I just can't seem to achieve the same result as you."

That starts this segment. We pulled out the video camera and went through the process, showing Ed one way it can be done in a very short amount of time. In this month's video, see the finished product, shot outdoors with Jason Quinn's Chessie SD40-2s running through the newly created scene.

## WHAT'S NEAT | 20



21. When planning your track areas, think about where the water will go as it rains. This is the main factor that dictates the carving of topography around mainline tracks. Watch as I pour a cup of water on to the scene, with Ed And Mike looking on.



22. I find it useful to also pour water on a scene to understand how a creek will flow when the clear resin is poured on. Sometimes it's easy to miss a high spot, or a creek that is high in the middle and low on the ends. Water will point these mistakes out before you actually pour the resin to form a creek.



## WHAT'S NEAT | 21



23. Now, back to our scene. I like to trace with a marker where the track will be to avoid carving this area, and keep it smooth and flat when the track is glued in place.



24. I like to carve the track profile with this bent horse rasp. It fits your hand like a set of brass knuckles and allows fast carving of foam on both sides of the main line.





25. We use a hot foam cutter to cut a culvert next to the track, where a creek will flow through the scene.



26. To carve surrounding scenery for the creek and tracks we use a pruning saw blade attached to a strong handle. This allows for fast rough cutting of foam, to tear through the topography quickly.



27. We then follow up with a Stanley Surform planer to smooth the foam and cut final details into the scene. This will save the amount of paint necessary to cover the scene.



28. We will use latex paint to glue the track in place. After the entire scene is painted, I evenly apply sifted dirt to the scene. Most of it sticks to the paint and I dump the excess off into a trash can. Now the diorama had an even coat of dirt.

## WHAT'S NEAT | 24



29. Mike Budde brought up the fact that before ballasting the track, it is a good idea to weather your ties individually with varying shades of white, gray, brown, or black dry-brushed on various ties. This makes track look good and weathered.



[Click here to rate or comment on this article](#)





30. We apply ballast to the scene and spread it with a curved artist brush. The curve in this brush allows only the tip to come in contact with the scene, making it very easy to spread the ballast smoothly between the ties. A brush like this retails for \$28 but is well worth the price for perfect smooth ballast and time saved.



31. The scene is soaked with a spray of Woodland Scenics Scenic Cement. When dry, this will make the ballast and dirt hard and solid.



32. Before the scenic cement dries, we apply static grass to the scenery surrounding the creek and tracks. This time, we are using  $\frac{1}{4}$ -inch green which stands straight up in the wet, muddy, and painted ground surface. Simply touch the scene with the alligator clip and the scene becomes charged within nine or so inches around the clip as the static gun applies grass in the area.



[Click here to rate or comment on this article](#)





33. We then add varying sizes of sifted creek stones to the area where water or rain would drain in to the low run-off gully under the track and glue this stone creek bed into place with more scenic cement



34. With that work done, we had a track scene with the correct-looking profile cut into the foam. Live on video, we make the entire scene in less than 15 minutes from start to finish. After the scene dried a few days, I added bushes and trees, did a little final carving of the culvert under the tracks, painted it gray, and shot the Chessie color photo outdoors for the opening shot of this segment.



[Click here to rate or comment on this article](#)





# MRH MARKETPLACE

Where the Rail Meets the Sea...



**CRAFTSMAN KITS & BUILT-UPS**  
HO – O – N Scale



H141-HO 77' Converted Menhaden Steamer Kit

[www.seaportmodelworks.com](http://www.seaportmodelworks.com)

Click here for our website:



## Yarmouth Model Works

HO scale resin kits and detail parts

..... U.S.A. MAILING ADDRESS  
3560 Pine Grove Ave. Unit 617  
Port Huron, MI 48060

Tel. 519-633-7574  
pierre.oliver@start.ca

[www.yarmouthmodelworks.com](http://www.yarmouthmodelworks.com)

..... CANADIAN MAILING ADDRESS  
85 Hiawatha St.  
St. Thomas, ON N5P 2T5

## THE DCC SHOP

YOUR COMMAND CONTROL SPECIALISTS

[www.DCCSHOP.com](http://www.DCCSHOP.com)



Quantity Pricing for  
the Layout Builder



HO Brass



Start your model railroad  
empire on the right track  
with **THE DCC SHOP**

The Little Train Store that is **BIG** on Customer Service!

[www.DCCSHOP.com](http://www.DCCSHOP.com)

ph. 208-889-9111

LOOK  
at what's new at  
Black Cat this month

Click here for  
our website

CPR decals  
Smiley & "V" face



**Black Cat Publishing**  
(204)489-5005  
ajfergus@mymts.net  
blackcatdecals.com





# MRH MARKETPLACE | 2

Your ad could be in  
this space for as low  
as \$28 a month.

Click to learn more ...

**MODEL RAILROAD**  
**BenchWork**  
.com



Affordable Modular (domino)  
Benchwork in 200+ sizes  
Custom built to order benchwork also available!

**Trees**



coastmans.com HO

*Imagine that!*  
Laser Art Products

**ITLA Scale Models**



*Olympia Tool & Die*  
*HO Scale Laser Cut Wood Kit*

CLICK HERE FOR MORE INFORMATION  
[www.itlascalemodels.com](http://www.itlascalemodels.com)

**LOGIC RAIL™**  
TECHNOLOGIES

"Sophisticated  
Model Railroad  
Electronics"



Please visit our website and online store!

21175 Tomball Pkwy  
Suite 287  
Houston, TX 77070

Phone: (281)251-5813  
<http://www.logicrailtech.com>  
info@logicrailtech.com



GREAT LOOKING  
TREES  
MAKE ALL THE  
DIFFERENCE

CANYON SCENES

**PRE-SIZE**  
MODEL SPECIALTIES

P.O. Box 6 Paonia, CO 81428  
Ph. 970 527 4586  
Made in The USA

Cast resin items for All Scales.  
Tunnel portals, bridge piers, abutments,  
culverts, and retaining walls.  
Trackside details and sage brush tree  
armatures.

"FREE SHIPPING see website for details"

**CROW RIVER PRODUCTS**

HO Kits 214 Stiff Leg Derrick \$ 60.00  
& Kit 215 Hoisting Shed \$ 55.00 (sold Separately)  
The shed is cast resin & the derrick is wood brass and  
cast metal. All Items made in USA



**HO & O Scale Machinery, Derricks,**  
Engines, Hardware & Waterfront Models  
Pawtucket, RI 02861 Tel 401-723-0065  
[www.crowriverproducts.com](http://www.crowriverproducts.com)  
We Accept Visa, Master Card, Discover or PayPal

• INDEX



SUBSCRIBE  
(free)

• TABLE OF CONTENTS

**UNIQUE STRUCTURES**  
*no one else has!*

click here to  
**Browse NOW >>**



**clever** models LLC  
Cardstock models & materials

Try one today!

[www.clevermodels.net](http://www.clevermodels.net)

FEATURING  
**America's Historic  
Main Street Architecture**



O-Scale model shown (HO available)

**MAINSTREET  
HERITAGE**

[www.mainstreet-heritage.com](http://www.mainstreet-heritage.com)

**W** GOLDEN AGE LINE  
**WESTERFIELD**  
MODELS, LLC

New One Piece Body Kits:  
USRA STEEL AUTO BOX  
#3000 Series: MC, NYC



[westerfieldmodels.com](http://westerfieldmodels.com)

**GOODDEALSDCC**

[WWW.GOODDEALSDCC.COM](http://WWW.GOODDEALSDCC.COM)



HOME OF THE  
**PROGRAMMER TEST TRACK SYSTEMS**

DC & DCC COMPATIBLE  
ALL SCALES AVAILABLE  
CUSTOM ORDERS  
DEALER INQUIRIES WELCOME

GARY COHN  
106 CENTER STREET  
FOX RIVER GROVE, IL 60021  
GARY@GOODDEALSDCC.COM

MODEL RAILROAD  
**BenchWork** .com

Affordable built to order Benchwork  
starting at only \$20 a Sq Ft.



## TAM Industries

*"Preserving the Romance"*

The highest quality in Display Cases for sharing your excitement of Model Railroading. We manufacture Display Cases for all gauges of Model Railroading, from "G" to "N". Custom Sizes are available for some styles.



Visit us today at:  
[www.TAM-IndustriesOnline.com](http://www.TAM-IndustriesOnline.com)

## Great Decals!™

FEC, Interstate, Virginian  
Railway, & L&N Titles  
After Hours Graphics Line  
Coupler Gages and More  
In O, S, HO, and N Scales



## HO DIESEL SUPPLY

KATO EMD SD SPECIALIST-REPAIRS-UPGRADES

New and Rebuilt Locomotives

Powered Chassis-Trucks-Motors

Bodies and Parts-Handrails-Electronics

[www.hodieselsupply.com](http://www.hodieselsupply.com)

email:kato@hodieselsupply.com

## MOUNTAIN SUBDIVISION HOBBIES

[www.modelrrsupply.com](http://www.modelrrsupply.com)

FREE USA SHIPPING OVER \$29.00

NCE - SOUNDTRAXX - DIGITRAX - PECO - CIRCUITRON  
DCC SPECIALTIES - INTERMOUNTAIN - CMX - ATLAS  
BAR MILLS - BOWSER - KATO - MRC - TOMAR - RIX -  
PIKESTUFF - LOGICRAIL - CENTRAL VALLEY AND MORE!

## Model Railroad Control Systems

Geoff Bunza Project Boards

DCC Occupancy Detectors

CMRInet Compatible Nodes

Layout Telephone Systems

RFID Switchlist Generator

Switch Machines and Drivers



## RULERS-of-the-WORLD

Scale Rulers \$4 each

Over 200+ scales!

Metric or Imperial

[www.rulers-of-the-world.com](http://www.rulers-of-the-world.com)

## PRECISION DESIGN CO.

LASERCUT KITS - CUSTOM DECALS

**PDC.CA**

Authorized *RailPro* Dealer

FREE SHIPPING in the US and CANADA

**HOBBY  
MARKETPLACE**  
ads are  
economical and  
effective.

Click HERE to learn more.



# *Creating a* **3D backdrop**



*Making a great-looking  
backdrop with minimal  
painting required ...*

• INDEX

• TABLE OF CONTENTS



1. It's a quiet afternoon on Maple Street as a couple of cars drive up and down the residential street.

• [INDEX](#)



[SUBSCRIBE](#)  
(free)

• [TABLE OF CONTENTS](#)

BY **DON HANLEY**  
ALL PHOTOS BY THE AUTHOR



[Click here to rate or comment on this article](#)

**FOR ANYONE BUILDING OR PLANNING A LAYOUT,** A few common threads apply to all of us. We choose our favorite road or roads, our favorite location, our favorite time of year, and the time period in which the layout is set. In short, we create a miniature piece of space and time. Since we all have limited space, a good backdrop is a key element in making the space look larger and convey a sense of the larger world.

Until recently the answer was to paint the backdrop. However, for the vast majority of us, our painting skills are, well let's say, not up to par with our modeling skills. So here we are with highly detailed locomotives, rolling stock, structures, and scenery, but the backdrop appears to be painted by a five-year-old. It's not

**Use our custom  
Google search on the  
MRH website to find  
topics of interest**

[CLICK TO FIND OUT MORE](#)

## CREATING A 3D BACKDROP | 4



### 2. Sample of Rob Spangler's painted backdrop.

that we didn't do our best, but that's not where our talents are. We end up destroying the effect of our creation because the backdrop isn't on par with our other work. Sound familiar? I have seen some absolutely marvelously painted backdrops; I'm just not that good.

My odyssey developing this 3D concept came from a the realization that when I look at the sky, nothing touches it. Absolutely nothing, not even the tallest mountains. So I began to wonder, is there a way to build the background scenery and create the sense of distance without painting it on the backdrop? I had the beginnings of how this would work when I volunteered to do a clinic at the 2016 NMRA convention held in Indianapolis.

There is nothing like a deadline and commitment to focus one on the task at hand. So let's begin.



## Understanding perspective

The first thing to address is perspective. Perspective is simply the position from which we view an object. When two objects of identical size are placed one behind the other, the object closest will appear larger than the one farther away.

But perspective also has to do with how high our eyes are above the track and benchwork. The lower the track and benchwork, the higher the vantage point. This can work to your advantage or disadvantage. The advantage of lower track and benchwork is that it's easier for switching and operations. You can reach the areas you need without arms and elbows catching scenery or structures. The disadvantage is that we see more things in the distance, which means more detail is needed to create the sense of a larger world.



3. Sample of Tom Johnson's backdrop.



## CREATING A 3D BACKDROP | 6

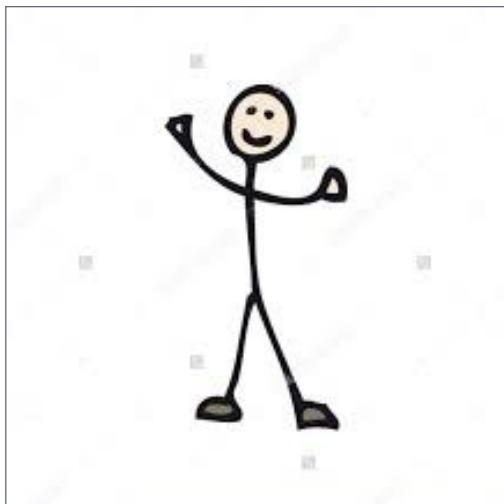

4. The reality of the majority of model railroaders' painting skills.

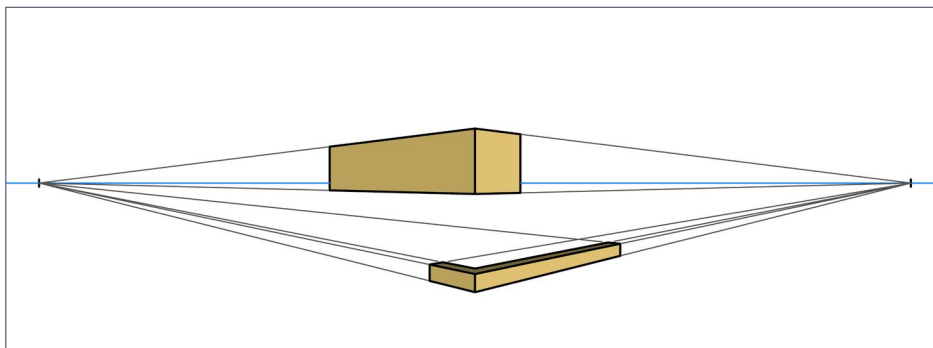

### 5. Perspective drawing.

On the other hand, the higher the track and benchwork, the lower our vantage point is, requiring less detail on the backdrop to create the sense of being a part of the larger world. The disadvantage is that with operations you need to be careful when you reach to uncouple a car so your arms and elbows don't wipe out anything.

My personal preference is to have my layout at about mid-chest or armpit height. I find this a good compromise.

# CREATING A 3D BACKDROP | 7

## Benchwork and backdrop design

With the height determined, I had two other considerations to accommodate in the design of my layout. The layout is located in my garage, so I had to leave space to park the family car. The second is the garage is also where my woodworking tools reside – my other hobby. Since both are not compatible with a layout, I needed a way to protect the layout from its co-inhabitants. With these two considerations, I decided to use a shadow box design for the layout.

The shadow box design allows me to protect the layout from the elements in the garage when it's not in use. I simply hang a cloth from the valance across the front of the layout. I got this idea from the episode of TMTV featuring George Sellios' Franklin and South Manchester.



6. I used the lid from a 5-gallon plastic bucket to mark the radius for the cove supports.

## CREATING A 3D BACKDROP | 8



7. The corners were installed first, then I leveled the top of the backdrop using them as my height guide. The spine of the corner pieces are sections of 2x4 that I ripped at a 45° angle and attached to two of the curved pieces for the cove.



8. I added the brackets and extensions adjacent to the corner pieces, plus some additional cove pieces so there is plenty of material to screw the Masonite into.



## CREATING A 3D BACKDROP | 9

I consider the order in which the various components of the layout are built to be very important. I work from top-to-bottom and back-to-front. I know this isn't normal but it allows me walk-up access to the backdrop for painting, as well as easy access to install lighting along the valance.

I began building the backdrop by attaching 6" x 8" shelf brackets to wall studs, with three 2" screws per bracket. Overkill? Probably, but it provides a solid anchor and I don't ever have to worry about it pulling out. I attached 2x2 furring strips to the tops of the brackets. The furring strips project 22" from the wall, matching the depth of the layout. I made curved pieces from 3/4" plywood to help anchor the cove that would be created when the Masonite® brand hardboard backdrop was put in place. For the vertical portion of the curve in the corners, I used some of the



9. The shelf brackets have been installed, and 2x2 furring strips and the cove pieces have been added. Now it's time for the Masonite.

## CREATING A 3D BACKDROP | 10



10. The main backdrop sections are in place, along with the vertical cove section. Now all I have to do is add the little triangle piece.

3/4" curved pieces and notched out the back corners for a spine that I cut from a 2x4 at 45° to fit in the corner. Once the pieces were made, I attached them in the corners.

With help of a couple of friends, we pushed the 1/8" Masonite into place. The valance acted as a stop for the front. We shoved the bottom up until we achieved the proper cove, and then screwed it in place with 1-1/4" drywall screws. I was glad I didn't use 1/4" Masonite, or we would never have gotten it curved into the cove. After all the pushing and shoving required to bend the Masonite, I think the shelf brackets receive more upward pressure than they ever will downward, so I don't regret using 2" screws.

At the inside corners, I mitered the top portion of the Masonite at 45° so the two corners would fit together at the top. After the

## CREATING A 3D BACKDROP | 11

sides were in place, I forced a piece of Masonite I had previously cut to size into the corner.

Now I was left with a small pie-shaped piece where the two curves came together. I cut several small pieces to fill in the shape. I since discovered I did this the hard way. Barry Silverthorn, Executive Producer of TMTV, told me about using an exercise ball with the same radius as the cove. After marking out the general shape of the corner on the ball, I used mesh tape and plaster to form the piece to fit the corner. The key is to leave the material thin at the edges and thicker in the middle.

After the Masonite was in place, I used drywall mesh tape and joint compound to seal the joints. I did have a failure on one of the joints after I painted the sky on the backdrop. The tape did not seem to bond to the Masonite, so I peeled out the drywall



11. I filled in the corners with small pieces of Masonite, test-fitting each piece before I nailed it in place.

## CREATING A 3D BACKDROP | 12



12. My air nailer is a handy tool for doing small pieces like this. If you don't have a nailer, screws will work also.

### ADVERTISEMENT



Announcing  
*Motrak Models New Structure Kit*  
*HO Scale "The Tool Shed"*

**CHECK  
IT OUT!**



Website: [motrakmodelsusa.com](http://motrakmodelsusa.com)  
Email: [info@motrakmodelsusa.com](mailto:info@motrakmodelsusa.com)

• INDEX



SUBSCRIBE  
(free)

• TABLE OF CONTENTS

## CREATING A 3D BACKDROP | 13

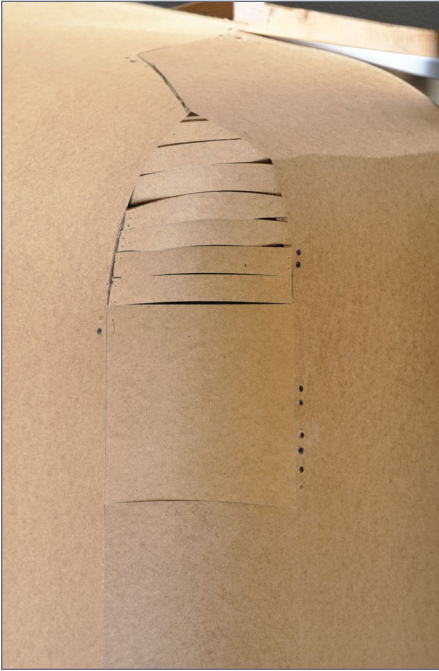

13. All the pieces have been installed.

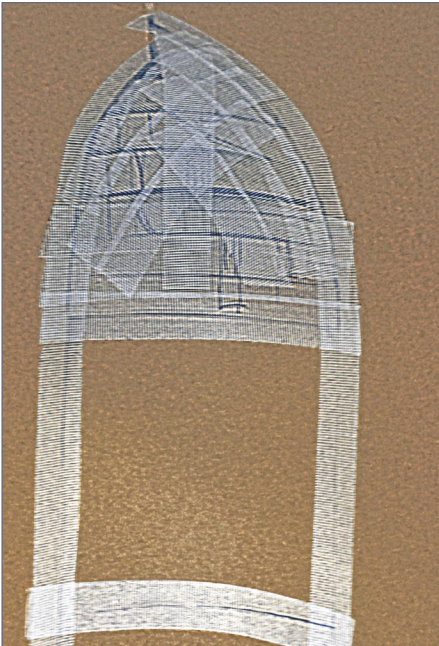

14. With all the pieces in, I applied mesh tape over the joints in preparation for joint compound.



## CREATING A 3D BACKDROP | 14



15. After all of the Masonite was installed, I attached a piece of 1 furring strip across the top of the backdrop. I added a 4" strip of plywood across the top to anchor the front face of the backdrop. I used my table saw with a dado blade to notch out for the 2x2.

compound, and re-taped the joint, this time adding some yellow glue to hold it to the Masonite. Once the glue had dried, I applied mud to the joint and repainted the effected area.

### Painting the sky

Choosing the color of blue for the sky is a personal choice; here is how I did it. I picked up numerous color cards of blue from my local Home Depot store and then compared them to a mid-afternoon sky on a clear day. Be aware that the sky changes shades from a light or whitish blue to a darker blue as you move up from the horizon to overhead, and also due to atmospheric conditions; a single shade of blue doesn't match every color you see in nature.



## CREATING A 3D BACKDROP | 15

I ended up choosing a blue that matched the sky about 20° above the horizon, since this is approximately my vantage point above the layout. That color is Behr Little Pond blue, and I purchased a gallon at my local Home Depot store. To create the transition from whitish blue to the darker blue, I also purchased a gallon of Behr interior Flat White. I made a 50/50 mix of the flat white and Little Pond blue to create a light blue.

Before I began painting the sky, I primed the Masonite with a coat of flat white. I then rolled the blue paint from the top front of the backdrop down to the bottom of the cove. From the bottom of the cove down to the top of the benchwork, I divided the backdrop into three equal parts. I rolled on the three colors of paint; the blue on top third, then continuing from the top down, my 50/50 blue-white mix in the middle third, and finally the white on the bottom third. I do small sections at a time, and



16. For this article I did a sample board showing how I paint my backdrops. I first primed the Masonite with flat white.

## CREATING A 3D BACKDROP | 16



17. I painted 1/3 of the board with the base blue, 1/3 with the 50/50 blue white mix, and 1/3 with the flat white. On my backdrop, from the cove above was the base blue, and I divided it into thirds below the cove.

while the paint is wet I use 2” - 4” brushes to blend the colors together – one for the base blue and 50/50 mix, the second for the 50/50 mix and white. I find that applying the paint rather heavy helps make this task easier.

The goal is to create a uniform gradation from white to blue. Don't worry if you don't get it right the first time. It's easy to repaint and blend them together again.

Once the sky was dry, I was ready to paint on the clouds. Since clouds are far away and can appear to be part of the sky, they don't detract from the 3D effect. Besides, it's hard to mess them up. If you are not sure how to paint clouds, take time to study from photos on the internet, [google.com/search?q=photos+of+clouds&ie=utf-8&oe=utf-8](https://www.google.com/search?q=photos+of+clouds&ie=utf-8&oe=utf-8) or better yet, study them from your patio or deck while enjoying your favorite beverage.



## CREATING A 3D BACKDROP | 17

A couple of thoughts about painting clouds.... Clouds are big and cover a lot of space. As modelers, we tend to make them too small. After I began the scenery, I wished I had made mine even larger than they are. Again, remember perspective – clouds close to the horizon are farther away and therefore smaller. Finally, a key to making the clouds look right is to make sure that they are all going in the same direction.

I make two colors of blue for my clouds. The first is three parts flat white to one part of the 50/50 mix. The second is one part flat white to three parts of the 50/50 mix. Using a 2” brush, I apply the first mixed paint for the base of the clouds using a stabbing or stippling motion. I immediately apply the second blue to the top of the first. Sometimes I do a little blending of the two blues to make a third color; other times I don't. It's just a matter of what looks right at the time. While the second blue paint is still wet, I add some of the flat white to the top to create the effect of sun on the clouds. Again, sometimes I do a little blending, sometimes not.

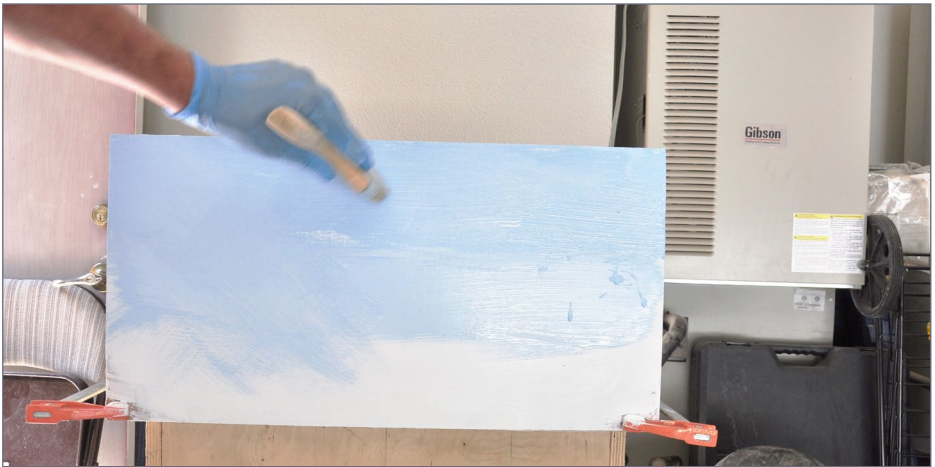

18. I blended the colors using an X pattern.

## CREATING A 3D BACKDROP | 18

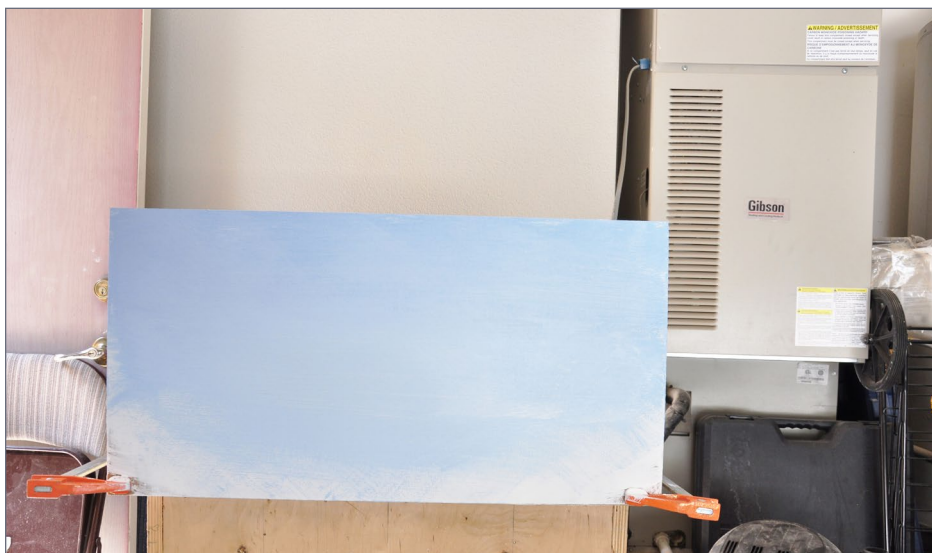

19. Once the colors were blended, I did a final horizontal brushing.



20. The first color that I used for the clouds is 25% white with 75% of my 50/50 mix. Beginning down near the horizon, I painted areas where I wanted the clouds. I applied all the cloud paint to the backdrop with a stabbing or stippling motion.



## CREATING A 3D BACKDROP | 19

When adding the white to the clouds, I start at the top of the highlighted area and work my way down into the cloud. As the white is applied, it's removed from the brush, leaving less the lower you go into the cloud, creating a change in color. Because I add the initial white while the blue is still wet, they tend to blend together. Later I go back and add white to the tops of the clouds in various places.

That is extent of the painting required for the backdrop. While it may seem a bit complicated, there is nothing that is too difficult for the average modeler. If you mess up an area, start over.

### Beginning the 3D backdrop

Since I am building my layout from the top down, back-to-front work on the backdrop was at a standstill until I had the



21. A second cloud has been added. Notice how the first cloud on the left almost disappears into the sky. This was the effect I was after.

## CREATING A 3D BACKDROP | 20

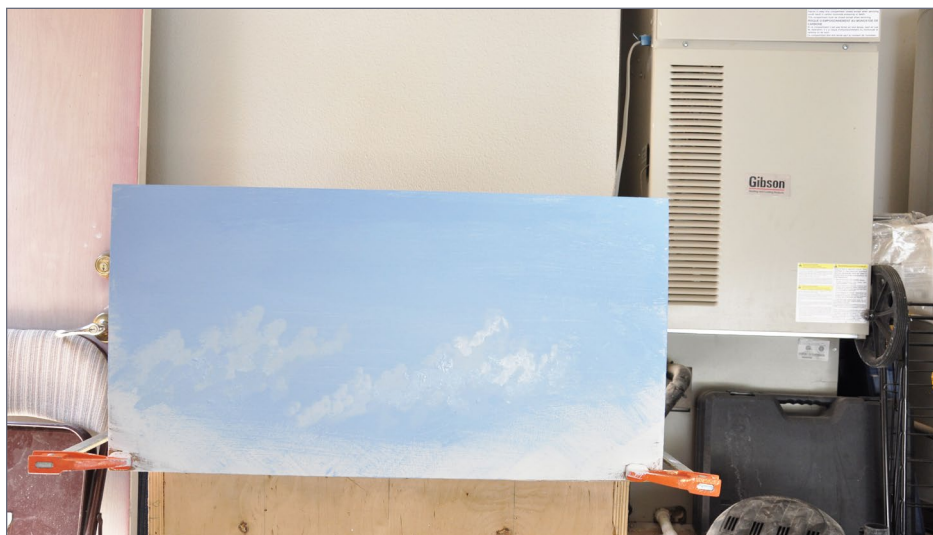

22. I added the second color of blue to the clouds, which is 75% white and 25% of my 50/50 mix. I added this to the tops of the first blue of the cloud base.

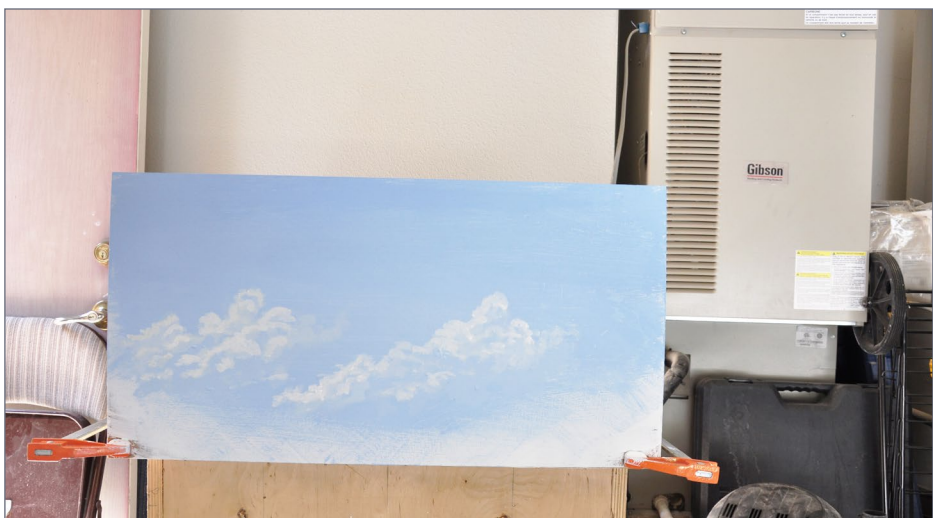

23. I added white to the tops of the background clouds and blended it into the blue just painted.



## CREATING A 3D BACKDROP | 21



24. Now I added a foreground cloud. It is above the background clouds and is larger. Again I started with the 25% white, 75% 50/50 mix. Don't be afraid to cover portions of the background clouds, as can be seen in the photo.

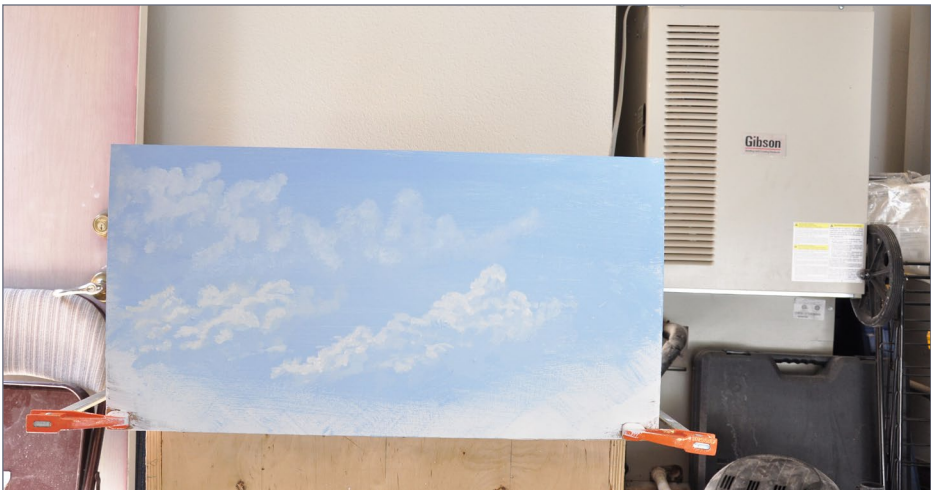

25. I added the 75% white, 25% 50/50 mix to the top of the foreground cloud the same as the background clouds.



## CREATING A 3D BACKDROP | 22

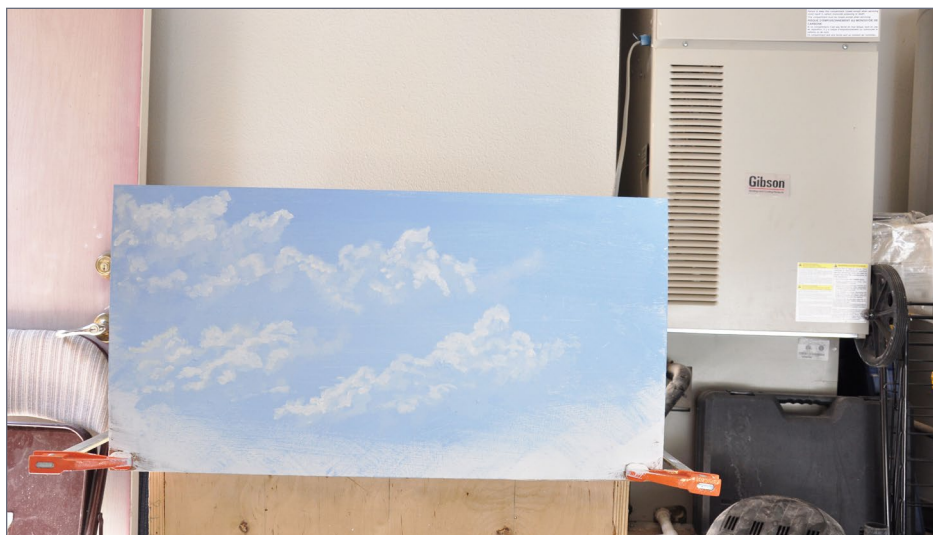

26. I added white to the top of the cloud and for the foreground clouds and blended it into the blue just painted.

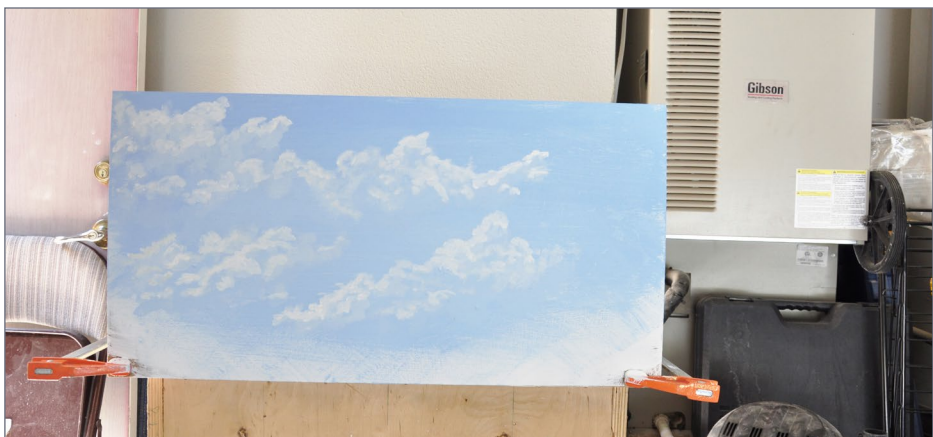

27. One last detail is adding another layer of white to the very tops of the clouds once the paint is dry. The first coat white paint tends to turn a little blue because I add it while the blue is still wet. The second coat of white adds the last little bit of brightness often seen at the tops of clouds.



## CREATING A 3D BACKDROP | 23

benchwork, track, and foam scenery base in place. Then it was time to get to work creating the 3D backdrop I had volunteered to present at Indy.

If you look at the cross-section of my layout, you'll notice a small channel adjacent to the Masonite backdrop. The channel is only 3/8" wide with a 1/8" piece of Masonite added to the front. I use



Masonite that has a white face on one side. I plan to add some back-lighting in the future, and this makes a perfect tray for light-emitting diode (LED) strips. Once the scenery was blocked-in, I made a mark approximately 3/4" - 1" above the rough scenery, following its contour. I pulled the

28. The backdrop sits while the benchwork and track work are completed. Working on the layout with a sky backdrop is an added bonus.



29. I added the Masonite spacer between the backdrop and where the foam scenery base will be. This keeps the rest of the scenery separated from the sky.

front piece of Masonite out and trimmed it along the line, then re-installed it.

Since I am modeling an urban setting, I need houses, but this approach isn't limited to urban scenery; any type of scenery can be modeled. I took photos of as many houses as I could find, focusing on the rear elevation. After I had a good selection, I chose those I thought would fit best in the scene. There is nothing scientific or magical about this; it was just choosing ones that looked right in a particular location.

A note on perspective: when viewing our models we look down on them; when taking pictures of houses we look up to the peak. Having the two different perspectives can ruin the desired effect. To minimize this problem, I stand as far away as possible from the house I am photographing. I bring the photo into Adobe

## CREATING A 3D BACKDROP | 25

Photoshop and use the lens correction feature. I bring the top of the house forward, reducing the two different perspectives as much as possible. If you don't have a photo editing program available, you can download GIMP, a free program, [GIMP.org/downloads](http://GIMP.org/downloads), or just keep the two perspectives as close to the same as you can when you take your photos.

Next I take time to adjust the scale of the pictures. I choose a doorway to make sure the house in the photo is at the same scale as one of the houses I am using. Once I have the photo properly sized, I reduce it to 90%. This simple step creates an illusion of distance. I also reduce the opacity of the photo to 97% to help with this illusion.

I initially print the photos on standard bond paper, and cut them out to verify size and placement. Once I am satisfied with the



30. The road and curb have been added, and work on the grading for the sidewalk, park-strip, and slope of the front yards is underway. The black lines are my lot lines for each property.

## TYPICAL STREET CROSS-SECTION

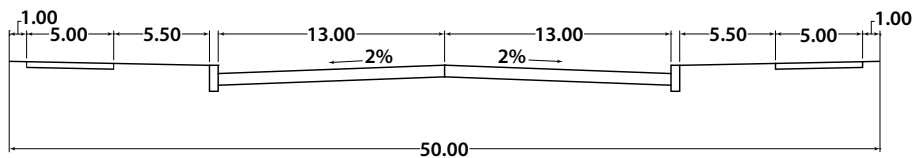

*(Pre-1950 residential area - Midwest US)*

### 31. Typical cross section of an older residential street in Fort Wayne, IN.

results, I print the photos on photo paper. After the final printing, I mount them to styrene with spray adhesive, and set them aside to dry for several hours. Once the adhesive is dry, I cut the photo from the sheet of styrene and spray it with two coats of a matte clear coat for protection. I use Rust-Oleum matte clear finish. On my first attempts I used 0.020" styrene but it warped, so I went to 0.040" styrene, which works fine.

Now for a little detour into the world of property development. When a site is developed, lots and street rights-of-way are plotted. The controlling government agency has standards the developer must meet. To create the look of a planned development, I laid out the lot lines with a 20' setback for the face of the house, not the porch. I also graded the building pads for each house, since my street is on a gentle slope. I set my foreground houses on the lots where I thought they would fit best. Once I positioned the houses, I marked the locations on the sub-base and then worked out where I wanted the photos placed. There is no point in placing a backdrop photo that is going to be completely hidden by something in the foreground. This process is simply an exercise in finding what looks pleasing to you.

## CREATING A 3D BACKDROP | 27

With the Masonite secured in place and the background houses ready, I mounted them to the front of the Masonite using Beacon 3-in-1 Advanced Craft glue. This glue attaches just about anything to everything. I used a 6" level to ensure the house flats were level. If the flats are not level, it will throw off the illusion. Time taken making sure windows or roof lines are level is time well spent.

Once the backdrop houses were in place, I had a couple of garages to add. I used the same procedure for the garages as for the houses, mounting them to styrene. However, for anything that sits in front of the houses, I added 0.040" styrene spacers to the back. I added the spacers even if there is a third structure in front of the second one. It is important that the spacers be set in between 3/8" and 1/2" from the edge of the flats. Visible ends will ruin the scene.



32. The area between the railroad and the street was low, so I filled it in with spray foam. Be careful with this stuff, as it expands a lot and sticks to everything.

## CREATING A 3D BACKDROP | 28



33. I began working on the rest of the backdrop by tentatively placing houses on the lots.

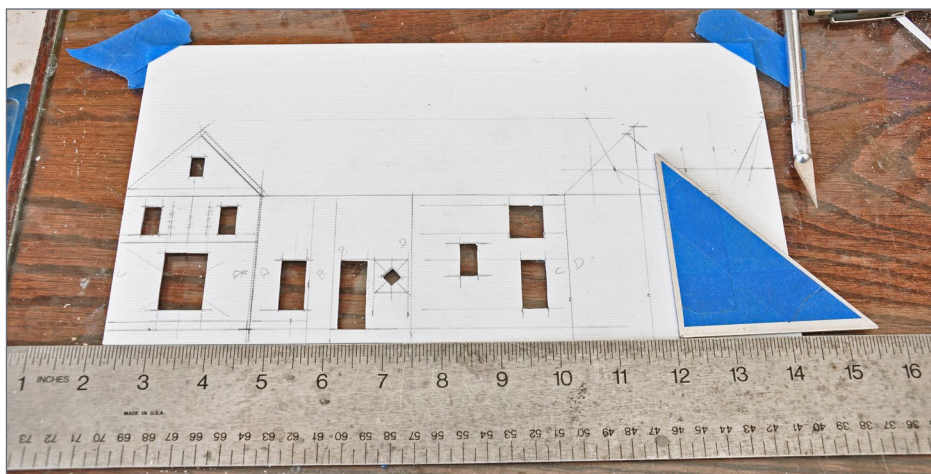

34. I scratchbuilt several of the homes using Grandt Line windows and Evergreen styrene siding to fit the space. Every home on the block has only three sides and is 20' deep.

## CREATING A 3D BACKDROP | 29



35-36. Before I place any home I make sure that the foundations sit level, side-to-side, and back-to-front. If a structure is not level, it will stand out and ruin the scene.



## CREATING A 3D BACKDROP | 30



37. I printed the background houses on regular paper and began placing them where I thought each would fit best.



38. Once I determined the houses I wanted, I printed them on photo paper, and protected them with two coats of clear matte finish.



39. The photograph houses are glued to the backdrop spacer, and the foreground houses are set in front of them. The white garage is set out 0.040" from the brown garage, which is set out 0.040" from the brown house behind it.

The spacers position the front flat out just a bit from the one behind it, creating the illusion of distance between the structures. I experimented not using the spacers, but the illusion disappears. The reason this works is because, as you move a bit from side-to-side, you can see a portion of the house that was not visible from the previous vantage point, just like in the real world.

### Making background trees

Once I have all the structures in place it is time to make the background trees. From what I've seen, most layouts have very small trees, about 2"-4" in height. That's only 16' to 32' tall in HO scale. Where I come from in northeastern Indiana – also the area I am

## CREATING A 3D BACKDROP | 32

modeling – that is a small tree. The vast majority of mature trees are between 60'-100' tall, and some ash and maples are as tall as 140'. Also, most mature trees have a spread slightly less than or equal to their height, and the most mature trees have trunks 36"-60" in diameter.

My first attempt was to use a branch from a Spirea bush that's a part of my home landscaping. There are many varieties; I have the dwarf pink type. The bush has a nice branch structure, so it was off to the races – or so I thought. I used some poly-fiber and teased it apart, then added it to the tree. I then added some

Woodland Scenics foliage over that. When it was all said and done, I had a green blob – a short tree, with a small trunk, not exactly the result I wanted.

Pondering what to do next, I wondered, since the buildings in the background are flats, could the trees also be flats? I quickly sketched the shape of

39. This is my first 3D background tree. I drew the trunk and the lower branches on 0.040" styrene.



## CREATING A 3D BACKDROP | 33

a mature tree trunk and the lower branches on a scrap of 0.040” styrene, and painted it black. Tree trunks and branches are round, so to create the appearance of a flat surface being round, I used some medium gray craft paint mixed with some black, and painted it down the center of the trunk, feathering it to black along the edges. I also did this on the branches. Result: the trunk and branches appear round.

To make the rest of the branch structure, I teased apart a Scotch Brite Industrial scouring pad. I managed to tear some of the pieces smaller than intended, but soon discovered that you

can put two pieces together and they will stick to each other, much like Velcro.

I glued the scouring pad branch structure to the styrene trunk with Beacon 3-in-1

41. I painted the trunk with craft paint and then added some gray-black mix in the center to give the illusion of a circular trunk. Very little detail has been added to the trunk to add to the illusion of distance.





42. On my first attempt I discovered that the 0.040" styrene trunk was not rigid enough to stand up, so I added some 0.10" x 0.10" styrene strips to stiffen it. The 0.040" piano wire supports the branch structure that was made from the scrub pad.

glue. But the branch material did not have enough strength to stand up, and just flopped over. Not to be deterred, I ran some 0.040" piano wire down through the branch material, then glued it to the styrene with Beacon glue. As I said, it glues just about anything together.

Clamping the tree to the Masonite, the branches stood up straight but the trunk flopped over. I solved the problem on this tree by cementing 0.10" x 0.10" styrene to the trunk. On all my other trees, I ran the piano wire down the base of the trunk, giving it the necessary rigidity. This also has the advantage of

## CREATING A 3D BACKDROP | 35

creating an offset when the trees are placed over one of the backdrop photos. Once all of the branches were in place to my satisfaction, I gave them a quick coat of black paint with approximately 80% coverage. Then it was time to add foliage.

By not painting the scouring pad branches solid black, I began creating an illusion of depth in the tree. Black tends to appear dark blue/green the farther away it is. Next I added Woodland Scenics dark green foliage on the underside and the areas where I wanted the inner leaves of the tree. I followed this with medium green foliage over the majority of the tree, and light green foliage on the top that is in direct sunlight. Since these are background trees, I didn't add any other foliage material. I am working to create the illusion of distance, so detailed leaf material is a NO-NO, and reserved for foreground trees.



43. On the rest of the trees I ran the .040" piano wire far enough down to stiffen the trunk.



44. Once the piano wire was attached to the trunk I teased apart a Scotch Brite industrial scrub pad and pushed it down over the wire, covering part of the lower branches. The scrub pad makes a great branch structure for trees once it has been teased apart.

I model early fall, with the foliage just beginning to change color. The predominate color in early fall is yellow. Orange and red are generally late-fall colors. I picked up two rattle cans of yellow, Rust-Oleum Summer Squash and Lemon Grass, from local Home Depot. I only sprayed every fourth or fifth tree, and then only a small portion of each tree, creating the effect of leaves just beginning to turn colors.

Once I had enough trees, I staged the houses I made for the scene into their respective positions. Then it was time to stage the

## CREATING A 3D BACKDROP | 37

trees, adjusting the mix and location to create the desired effect. I had one tree that extended out a little too far, so I flattened it by pressing on the foliage with my hand. Once the locations were established, I glued and clamped them to the face of the Masonite with the Beacon craft glue, allowing it to dry overnight.

After removing the clamps from the trees, I mixed a small batch of 40-minute fast-set plaster. I added a bit of craft paint to give it a beige color, then filled in the space between the plaster-covered foam and the backdrop I'd just created. It is important to be careful and not get any plaster on the building flats or trees. Even

though the building flats have a clear coat, it is possible to wash the ink off the photo paper if too much moisture gets on it.

### Filling in the scenery

As you can see in the photographs, I already had the streets and



45. After attaching the scrub pad, I sprayed the pad portion of the tree with black paint, going for about 80% coverage.



## CREATING A 3D BACKDROP | 38



46. After the scrub pad was in place, I added Woodland Scenics dark green foliage that I have teased apart. I aim for about 20% coverage, but there is nothing hard-and-fast about the percentage. You just don't need to cover the entire tree; that's a waste of material.



47. Next I added Woodland Scenics medium green foliage, aiming for about 50% coverage.



48. Finally I added Woodland Scenics light green foliage to the top portions of the branches, aiming for about 20% coverage. The tree is ready for planting along the backdrop spacer.



49. Since I am modeling early fall, a few of the trees got a light spray of yellow.

## CREATING A 3D BACKDROP | 40



49a. Here I begin to add a scrub pad to one of the sagebrush armatures.



49b. The armature with the scrub pad applied.

## CREATING A 3D BACKDROP | 41



49c. Here I begin to add medium green foliage from Woodland Scenics. Since this is going to be a mid-ground tree, I chose not to use dark green foliage, helping to create the illusion of depth in the scene.



49d. The medium green foliage covers about 90% of the tree. I used less of the medium green foliage near the top.

## CREATING A 3D BACKDROP | 42



49e. The Woodland Scenics light green foliage has been added. I also placed it over the medium green foliage to help create the illusion of depth.



49f. Since this is a mid-ground tree, I sprinkled it with Noch leaf material. When placed in front of the background trees, the added detail of the leaves will help force the perspective of depth.

## CREATING A 3D BACKDROP | 43

sidewalks in place, as well as the lots for individual houses. The streets are made from foam board painted with Rust-Oleum Primer Gray, and weathered with chalks. The curbs are 6" x 6" styrene strips glued to the top of the roadway. The sidewalks are 0.040" strips of styrene cut 5' wide, which is a standard sidewalk width in Fort Wayne, Indiana, where I lived and worked for many years. The yard walks are also .040" styrene and are 30" wide.

All the steps are made from 0.10" x 0.10" styrene angle. I glued 6" x 8" styrene to the inside of the angle, then filed down the leg on the 6" face. I added another piece of 6" x 6" styrene to the back of the step to provide a surface to glue the next step. Each step has a 6" rise, so I know how many steps I need to get to the porch or the yard. The sides of the yard steps are 6" x 8" styrene that is glued and shaped. The porch steps have 2" x 10" or 2" x 12" stringers.



50. The background trees are staged to determine the best location for each one.



51. I glued the background trees to the background and added turf material. I use a dark green paint as the base on which to sprinkle the Woodland Scenics dark turf. I took time to mask the sidewalks and protect areas that I didn't want green paint to get on. While I painted a little past the foundation lines, I wasn't as careful with the turf, as can be seen in this photo.

The curbs, sidewalks, steps, and yard walks are all painted with Rust-Oleum Ivory Silk followed by a light misting of the Primer Gray. I set all the walks in place, and weathered them with chalks after the turf had been applied. The porch steps are painted a color appropriate for the house they are used with. The paints I used on these structures are Rust-Oleum rattle cans.

With the subdivision improvements in place, it was time to add grass to the yards. I used Woodland Scenics fine turf. I began by painting the base a color similar to the grass I am using; in this case it was Behr Cypress Vine. Before painting and prior to removing the staged houses, I re-marked their foundations on

## CREATING A 3D BACKDROP | 45

the scenery base. Taking my time, I painted the base, going just inside the foundation outline, , then sprinkled on turf material. Before the paint had set, I placed the house back into position.

After sprinkling on the turf, I used a soft brush and moved the excess around to create a smooth surface. Think of your yard – you want a nice smooth lawn for mowing, so I am thinking the 1:87 future home owners on this block would like the same. After I had added the turf to the block, and made sure it was smooth, I glued the excess in place with diluted white glue. However, in this case I used precision glue applicators, instead of the standard glue bottle, and a spray bottle. While it was a bit tedious doing it this way, it gave me control over where the wet water and glue were going, so I didn't worry about turf material ending up where I didn't want it.



52. The houses are in place and the scene is beginning to take shape. Already the 3D effect is taking shape.





53. Now it's time to add details like the yard-walks up to the houses, and steps up to the porches. I carved out the plaster where the steps will be so that they will sit in the ground.

### More trees

Now it's time to add trees between the houses and in the park strip. I am fortunate to live in the high desert, and have access to all the sagebrush I need. There are two types of sage where I live, one with a branch structure in an upward pattern, and the other with a more horizontal pattern. The first is good for maple, ash, walnut, and elm trees. The second is good for oak, beech, and sycamore trees.

For the oak trees in my scene, it was relatively easy to pick some good armatures to begin with. For the maple and ash trees I needed to piece-together some of the uplifted-style sage. Choosing a piece for the trunk, I cut additional branches for it

## CREATING A 3D BACKDROP | 47



54. I added stairs to four of the homes, and installed a retaining wall around the brick home. I couldn't resist adding a few autos in this shot.



55. All of the houses have their yard-walks and porch steps added. Now it is time to add some mid-ground trees.



56. These are the two types of sage in my area. The one on the left is appropriate for oak, sycamore, and beech trees. The one on the right is appropriate for maple, elm, and ash trees.

and glued them into place. I held the branches in place with florist tape while the glue dried. Finally I drilled each trunk with a 1/16" hole, and I inserted a #16 1-1/4" brad that I had cut the head off. I stuck the trees into a piece of foam to hold them while I teased apart a scouring pad and applied the pieces for the branches, the same as with the backdrop trees. I used Beacon craft glue to hold the branches in place.

Once all of the branches were in place, I painted the entire tree black, covering approximately 90% of the branch material. I left a little of the natural pad color to give an illusion of distance, but

## CREATING A 3D BACKDROP | 49

not as much as the background trees. I covered the trees with foliage in the same way as the backdrop trees. Once the foliage was in place, I sprayed the tree with a light coat of 3M Super 77 spray adhesive, then added a little of the turf material to increase the texture of the tree.

A word of caution: The 3M Super 77 label says that it dries clear, but I found it to be just a little opaque. So use it sparingly.

Once all of the trees were finished, I painted a few with one of my yellow colors for early fall. I ran out of foliage material while preparing for the NMRA clinic in Indianapolis, so I planted one tree as a dead one. Don't be afraid to have dead branches or trees in the scene; it's very natural.



57. I drill the trunk of each tree with a 1/16" drill bit and then insert a 1-1/4" finish nail with the head cut off. This allows me to stick the trees in the scenery and stage them before adding the foliage. In this photo I have placed the tree bases around the scene. This is not necessarily the final location of the trees, but this is part of the process to build the scene.

## CREATING A 3D BACKDROP | 50



58. For the mid-ground trees, I teased apart the scrub pad as I did for the tree flats.



59. I affixed the scrub pad to the tree with white glue. You can see a few drops in the photo. Once all the desired portions of pad were added, I trimmed stray pieces of the pad to create a more realistic branch structure.



## CREATING A 3D BACKDROP | 51

When I began planting the trees, I needed to move some around so the they would fit around each other, and the scene would balance. One pleasant surprise I discovered was that I could pull a tree out of its initial spot and move it without having to worry about holes showing up, or white plaster chips all over the place. I am not sure what I did differently, but when the nail is pulled from the hole, the turf material seems to heal its self.

Overall, I am very pleased with the results of my first attempt. None of the work is very difficult. I would say that anyone with moderate modeling skills can do the same. The biggest problem most of us have is that we have never done anything similar before, and it's outside our comfort zone. I encourage you to experiment with this process on your own layout or diorama.. I found that it is a simple way to have a great-looking backdrop with minimal painting skills. It gives those of us artistically challenged an opportunity to create a great backdrop without painting.



60. An overall view with the scene 90% complete.



61. Fences, hedge rows, and flowers are present. Other details to add in the future will be chimneys to the houses, along with some window treatments to give the lived-in look. I also need to weather the houses since they all have the freshly painted look that should be toned down.



[Click here to rate or comment on this article](#)



# Debug trackwork *like an expert.*

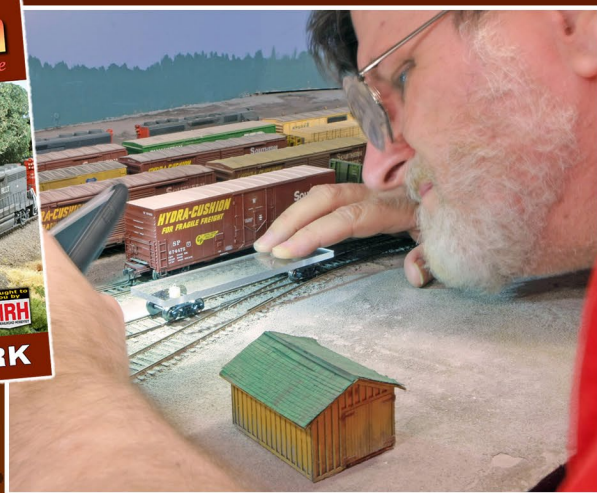
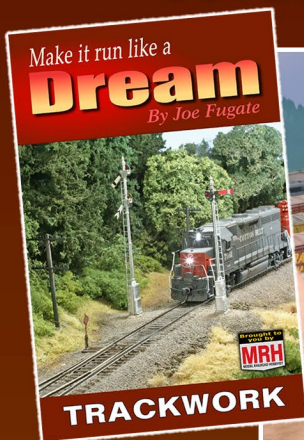

~~\$12.99~~

\$11.49

eBook

Also in  
paperback

Click me to  
**LEARN MORE ...**

# Make it run like a **Dream**

TRACKWORK: *By Joe Fugate*

From the MRH Store: [store.mrhmag.com](http://store.mrhmag.com)

Other books in this series: *ROLLING STOCK* (Jul 2017) and *LOCOS* (Jan 2018)

• INDEX

• TABLE OF CONTENTS





# YES, IT'S A MODEL

*compiled by*  
**DON HANLEY**  
.....



[Click here to rate or comment on this article](#)



1. The San Diego La Mesa Model Railroad Club's model of the Tehachapi Loop is almost done. Trees still need to be added, and some finishing of the creek bottom remains. Access to this extremely deep HO model scene is gained through access hatches and walking on the sturdy scenery. Long-time club member Don Mitchell provided the photo.

► **MRH'S MONTHLY PHOTO ALBUM**







**\$ GET PAID FOR YOUR PHOTO**

We pay \$40 per photo we publish. If you'd like to get your modeling in our photo feature, just start posting your photos on the MRH website, especially in the Weekly Photo Fun thread created each week.

See [mrhmag.com/help](http://mrhmag.com/help) for more on how to post an image. You need to be an MRH subscriber to post photos to our website, and becoming a subscriber is free, [just fill out this form here](#). ■

ADVERTISEMENT

# END OF TRAIN DEVICE

**NEW SAFETY GREEN**



**Bright Red  
Flashing Light!**

**Installs in minutes!  
No freight car  
modification required!**

**Patented Technology - US Patent 7,549,609**

**Does not affect Load!**

↓ Car without Load ↓



↓ Car with Load ↓



**Click Here to  
Learn More**

**RE RING™  
ENGINEERING**



**Come join us for a  
Colorado Narrow  
Gauge Adventure!**

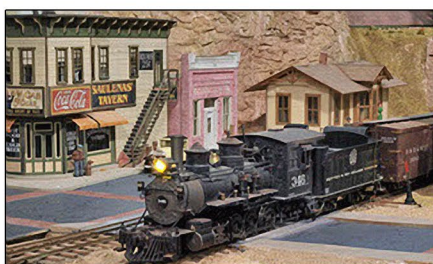
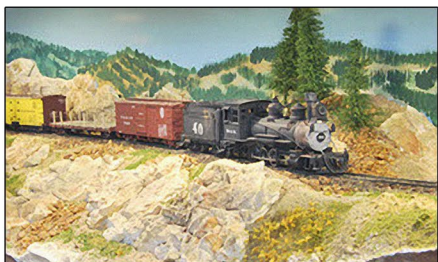

**37th National  
Narrow Gauge Convention  
Aug. 30th - Sept. 2nd, 2017  
Denver, Colorado**

**LEARN MORE >>**



# One Module Challenge

First place winner

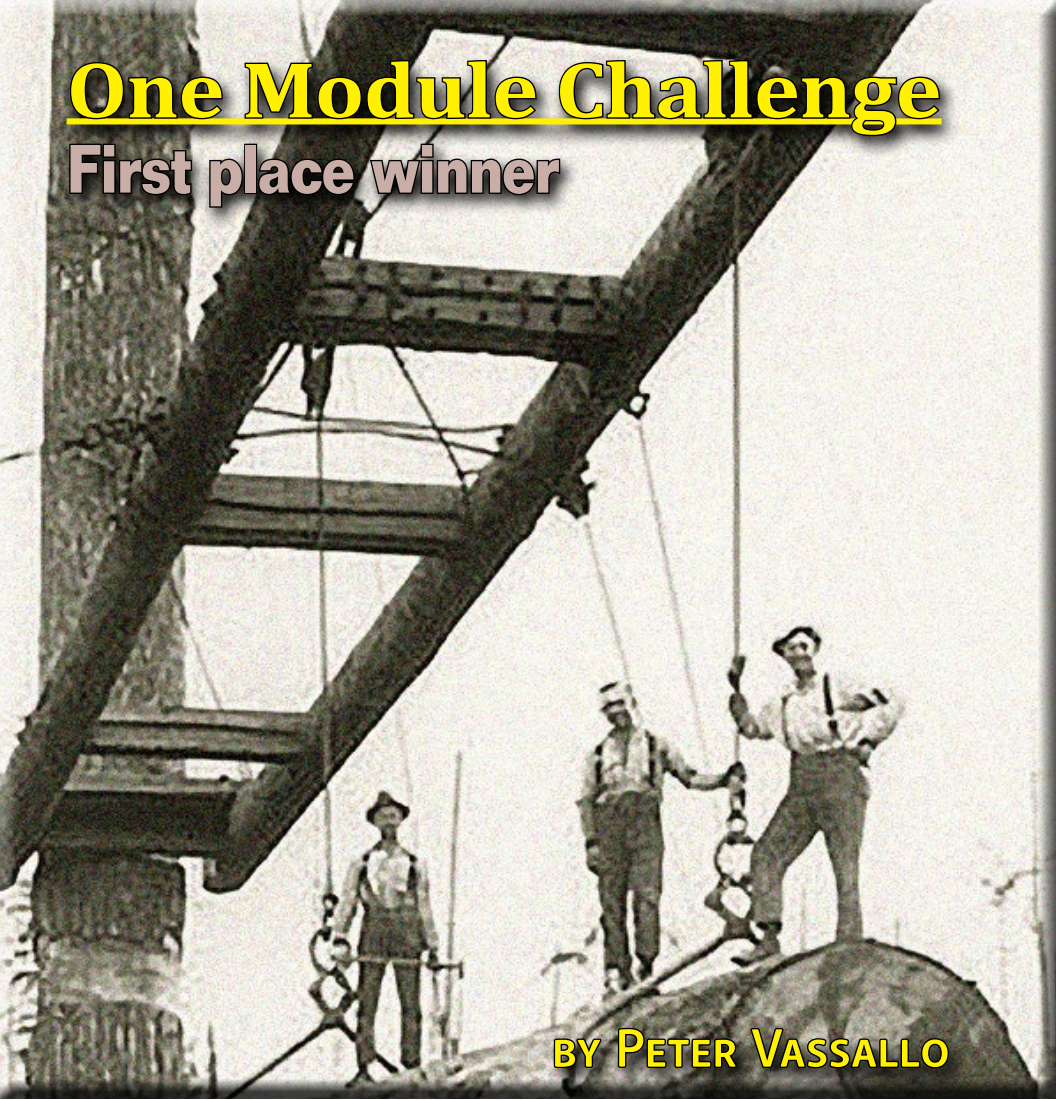

BY PETER VASSALLO

## *The Easton Lumber Company ...*

**AS I MULLED THEMES FOR THIS YEAR'S CHALLENGE,** I kept coming back to the old, dramatic logging lines of the early 1900s, which are well suited to compact operations and offer plenty of modeling opportunities. And so the Easton Lumber Company was born, a freelanced railroad based on California logging lines prevalent during the timber boom era.

• [INDEX](#)

• [TABLE OF CONTENTS](#)



[Click here to rate or comment on this article](#)

I decided to go the freelance route as it allows combining favorite aspects of the prototypes without violating any particular prototype feature. Any structure you want to include is fair game and no one can say “That doesn’t belong here!” Logging lines lend themselves to such treatment as they were largely seat-of-the-pants operations.



1. Logging camps contained many bunkhouses for the crews, as well as cookhouses, equipment sheds, supply stores and service facilities. Rails were laid into the woods and small wooden structures brought along to their temporary locations. Larger buildings were erected onsite. Here loaded log cars are being brought to camp from more distant loading areas. These loads will be collected and assembled into trains for eventual transport to the sawmill.



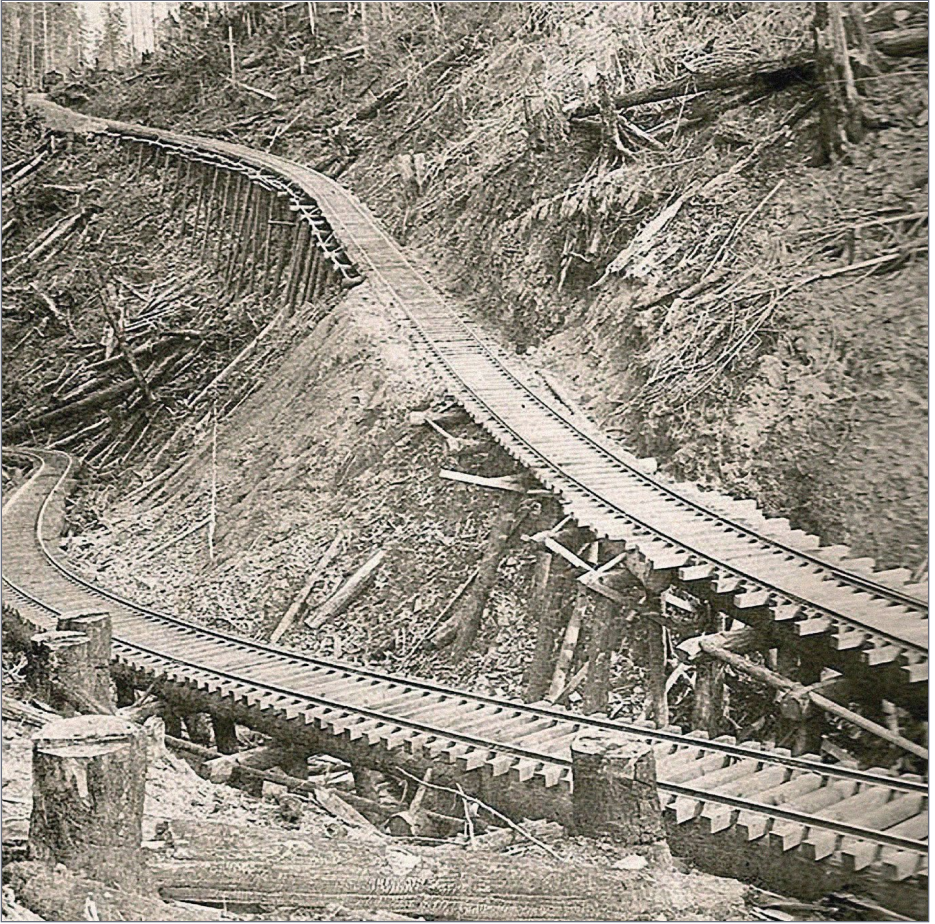

2. Switchbacks were used to gain elevation along hillsides to reach dense timber stands. This particular switchback has grades of about 10%. Only geared locomotives, including Shays, Climaxes, and Heislors, could negotiate such grades. These engines could generate significant torque but were slow and so were used mainly in the woods while rod engines were used along the main line where the grades were much less. Notice all the excavation—felled trees and stumps—and the trestles built in place to accommodate the track. This is all wonderful material for the railroad modeler.



## Background

I searched the internet for details and inspiration and browsed through pictures on Google. Some of these pictures [1-4] highlight particular elements I want to include in the module design. The black and white shots were obtained from [mendorailhistory.org](http://mendorailhistory.org), which has a wide variety of information on California logging operations, both prototype and model.



3. At the loading site, a large central “spar tree” was cleaned and rigged with boom, pulley blocks and lines to position cut logs on rail cars. Steam donkeys reeled or released the various lines to swing, raise, and lower the boom. Donkey engines also were used to pull logs from cut locations to the loading area. Gravity was often used to roll the empty flat cars into place below the boom. Note the tong hooks which grip into the logs.

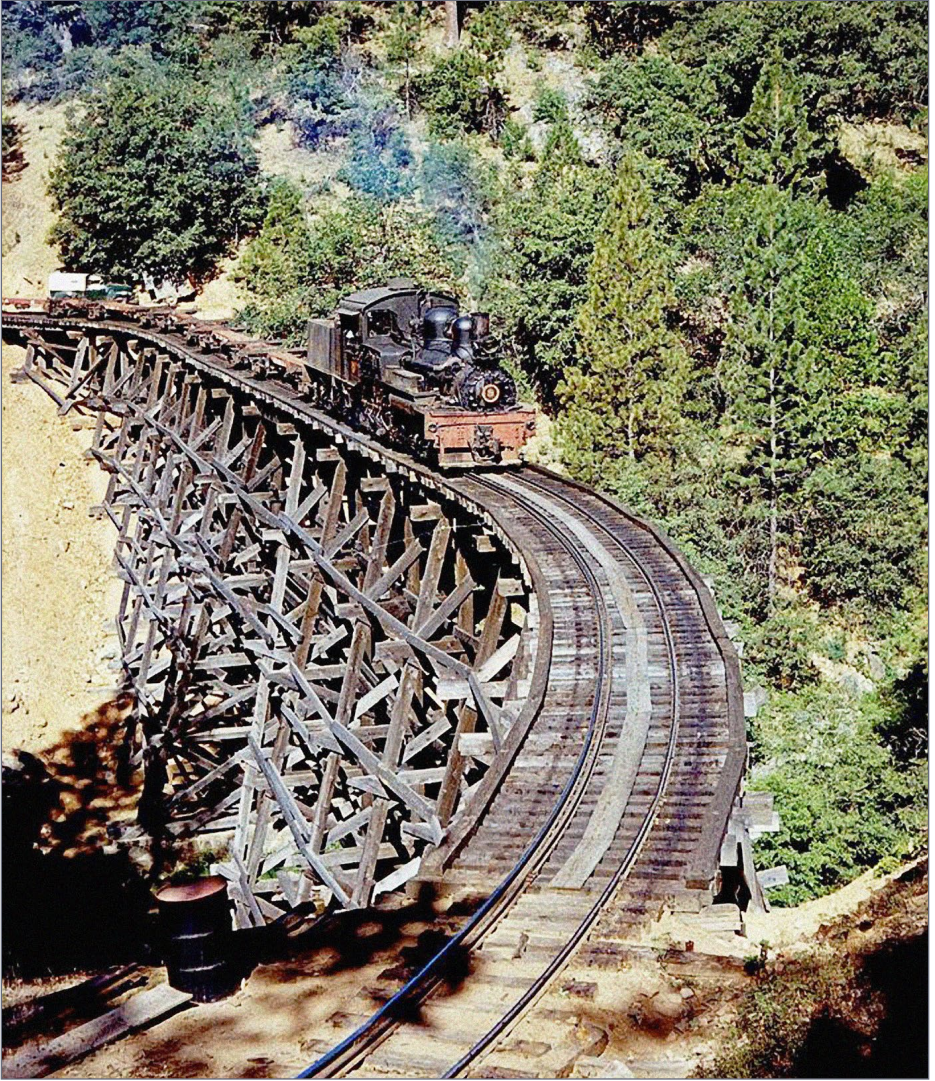

4. The West Side Lumber Company was one of the most famous California logging lines. Here, Shay no. 8 leads empties across River Bridge trestle in October, 1960. Trestles of every shape and size were prevalent on logging railroads. This picture is especially good for noting textures and colors of the landscape, trestle, track and abundant trees. *John West photo*

## Module design

I designed a compressed logging camp, switchback and loading site with a trestle or two thrown in for good measure [5]. A runaround allows exchanging loads and empties between the mainline train, which enters camp through the tunnel, and the local engine which operates the switchback. A spur in camp supplies the cookhouse and sheds, and there's a siding for the local engine.

Camp structures include bunkhouses, sheds, transfer crane, and water and coal for the engines. A curved trestle over a gorge leads up a 4% grade to the switchback opposite the camp. At the top of this hill is the loading site with two steam donkeys, a spar tree and tail tree.

### ADVERTISEMENT

Get the latest Model Railroading News, Tips, Reviews & Opinions



**Our iTunes feed has changed search for  
"Mike And Scotty Live" to receive the latest episodes!**

**[www.themodelrailroadpodcast.com](http://www.themodelrailroadpodcast.com)**

Hosts:

Scott Mason: [www.scottymason.com](http://www.scottymason.com)

Mike Rose: [www.mrhobby.com](http://www.mrhobby.com)

**Don't Miss our Monthly Interviews  
& Product Announcements**

• **INDEX**



**SUBSCRIBE**  
(free)

• **TABLE OF CONTENTS**

# ONE MODULE CHALLENGE | 7

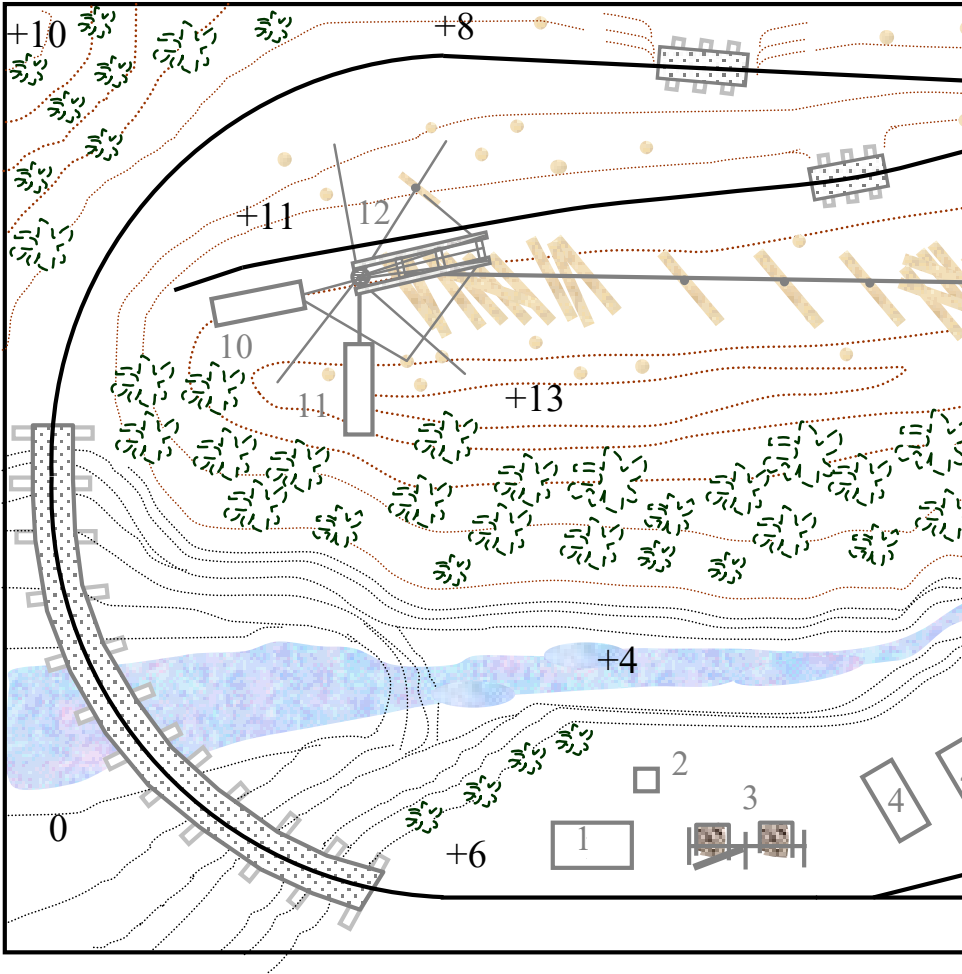

5. Easton module track plan, with buildings keyed to Table 1. It is HO scale with 18" minimum radius curves, and No. 4 turnouts. The overall size is 42 x 84 inches. Elevations indicated in inches.

# ONE MODULE CHALLENGE | 8

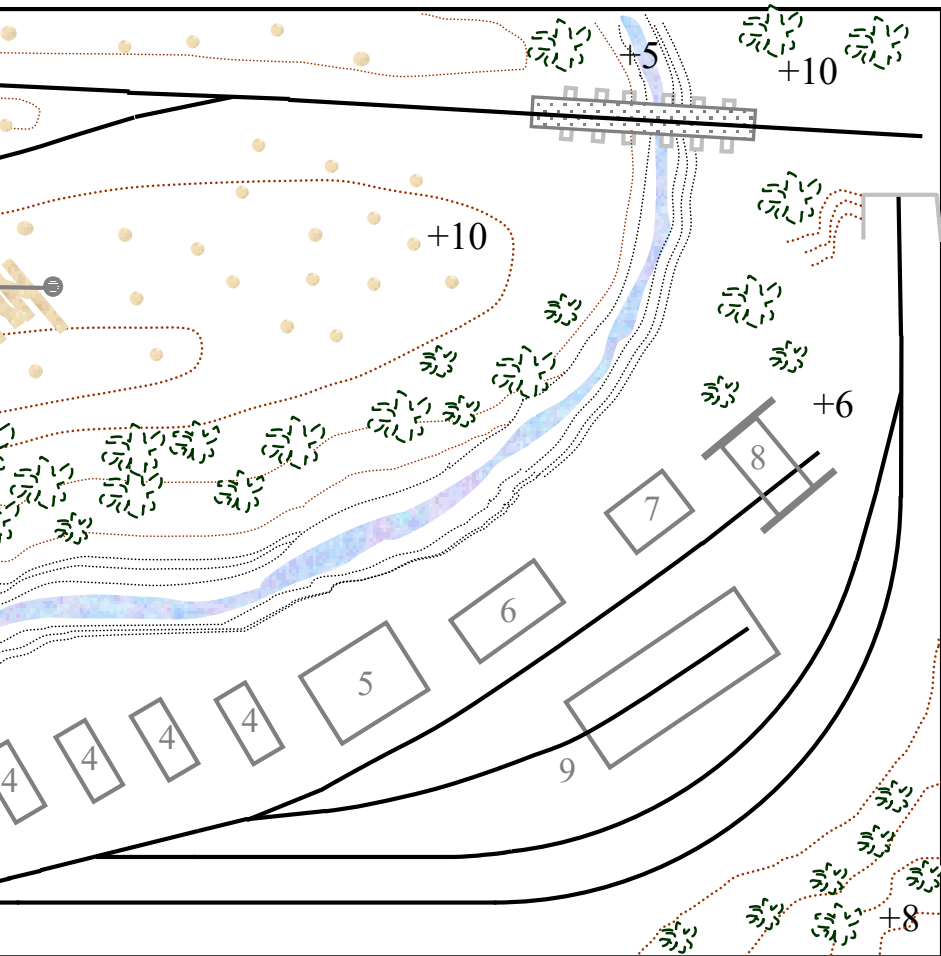

[Click here to rate or comment on this article](#)



**TABLE 1 - List of Structures and models**

Nbr	Structure	Suggested kit	Price
1	Water tank	Campbell #372 branchline water tank & shed	\$55.00
2	Tool shed		
3	Coal loader	Durango Press	\$22.95
4	Bunkhouses	Campbell #231	\$16.00 ea.
5	Cook house	Campbell #381 farm house	\$55.00
6	Supply shed	JL Innovative Trackside Jamboree	\$32.95
7	Repair shed		
8	Overhead crane	Durango Press	\$16.95
9	Engine house	Scratchbuild	\$30.00
10	Loading donkey	KMP models	\$51.00
11	Yarding donkey	KMP models	\$51.00
12	Spar tree with boom and pulleys	KMP models	\$31.50
<b>Total:</b>			<b>\$426.35</b>

The module’s central hill serves as a view block. On the camp side is lush vegetation and trees along the hill similar to [4]. On the loading side you see fallen trees, brush, stumps, and logs similar to [2]. The height of the module should emphasize the view block while allowing a good view of the loading site and camp.

I find it difficult to plan 3D scenic forms purely on paper as they will naturally evolve during construction. I’ve provided a basic plan for the scenery but the final decisions and implementation would be up to the builder. I think foam is an ideal choice for the upper hill scenery as the track can be laid directly onto it and the foam shaped to look natural, including depressions and gaps, while the trestles are built in place using wood. Also, the foam readily accepts bushes and trees.

## Building the module

Materials for the benchwork, track, and scenery are listed in Tables 2-4. A benchwork diagram is shown in [6].

### TABLE 2

Track and Electrical	Quantity	Price
MicroEngineering HO Code 70 flextrack, 36 inches long	2 pkgs (6 each)	\$76.00
Shinohora HO Code 70 No. 4 left hand turnout	2	\$42.00
Shinohora HO Code 70 No. 4 right hand turnout	2	\$42.00
Shinohora HO Code 70 No. 4 wye turnout	1	\$21.00
Caboose ground throws	5	\$20.00
No. 20 wire, 20 feet	1	\$4.00
Atlas HO scale metal track joiners	1 pkg. (48)	\$5.00
Atlas track nails	1 pkg.	\$5.00
Cork roadbed, 3/16 x 1 3/4 x 36 inches	8 pieces	\$12.75
<b>Total price:</b>		<b>\$227.75</b>



**Click here to rate or comment on this article**



## TABLE 3

Benchwork Materials	Quantity	Purpose	Price
4 x 8 ft plywood, 3/8 inch thick	1	Sub-roadbed	\$15.00
1x4 inch pine board, 4 ft long	6	Framing, risers	\$30.00
1x4 inch pine board, 10 ft long	3	Framing, risers	\$27.00
2x2 inch pine, 8 ft long	2	Legs	\$8.00
1x2 inch pine, 8 ft long	5	Leg bracing, risers	\$10.00
Pink insulation foam 2 inch x 2 ft x 8 ft	1	Basic terrain	\$34.00
Stanley Surform Shaver	1	Shaping foam	\$6.50
Liquid Nails	1	Gluing foam	\$6.00
4 x 8 ft Masonite 1/8 inch thick	1	Profile boards	\$12.00
Wood glue	8 oz.	Fastening	\$3.00
Wood screws	1 pkg.	Fastening	\$8.50
2 inch swivel casters with brakes	4	Mobility	\$12.00
Miscellaneous nuts/bolts	As needed	Leg fastening	\$5.00
<b>Total Price:</b>			<b>\$177.00</b>



[Click here to rate or comment on this article](#)



## TABLE 4

Scenic material	Quantity	Purpose	Price
Dirt/gravel	As required	Ground cover	N/A
Crushed oak leaves	As required	Ground cover	N/A
3/8 x 3/8 x 36 balsa	10	Pine tree trunks	\$14.00
Caspia		Pine tree branches	\$15.00
1/8 x 1/8 x 36 balsa	15	Trestle bents	\$15.00
3/32 x 3/32 x 36 balsa	10	Trestle ties and girts	\$10.00
3/32 x 3/16 x 36 balsa	6	Trestle stringers	\$6.00
1/32 x 3/32 x 36 balsa	6	Trestle braces	\$6.00
Woodland Scenics fine turf, burnt grass	18 cu. in.	Ground cover	\$4.00
Woodland Scenics coarse turf, burnt grass	18 cu. in.	Ground cover	\$4.00
Woodland Scenics foliage clusters, light green	45 cu. in.	Landscaping	\$11.00
Woodland Scenics fine leaf foliage, light green	1 pkg.	Landscaping	\$18.00
Woodland Scenics fine leaf foliage, olive green	1 pkg.	Landscaping	\$18.00
Woodland Scenics narrow plaster cloth	1 pkg.	Creek / gorge banks	\$6.00
Woodland Scenics scenic cement		Fixative	\$10.00
Acrylic paint: earth, black, blue, white	As required	Coloring	\$20.00
Acrylic gloss medium	4 oz.	Water	\$7.00
Hydrocal plaster		Rocks	\$12.00
Rock molds		Rocks	\$10.00
Sculptamold	3 lbs.	Rocks/blending	\$7.00
<b>Total price:</b>			<b>\$193.00</b>



# ONE MODULE CHALLENGE | 13

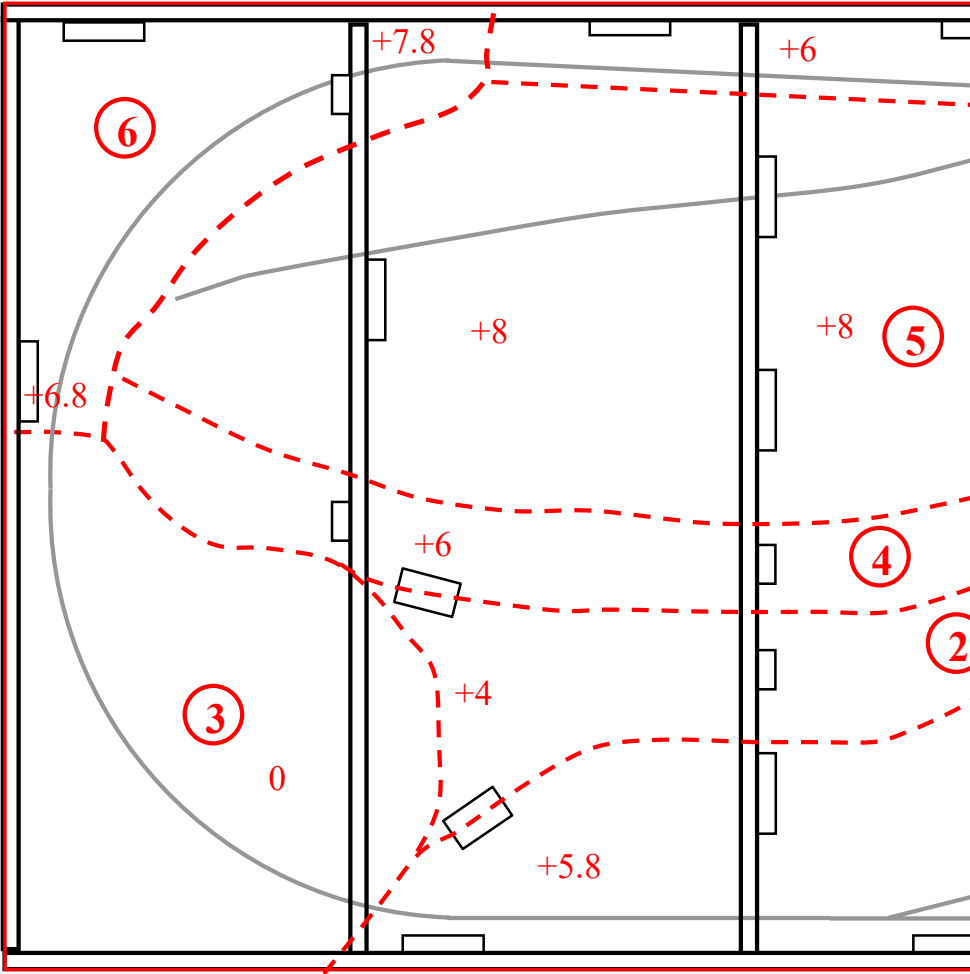

6. Benchwork diagram and plywood cutout guide. Elevations in inches.

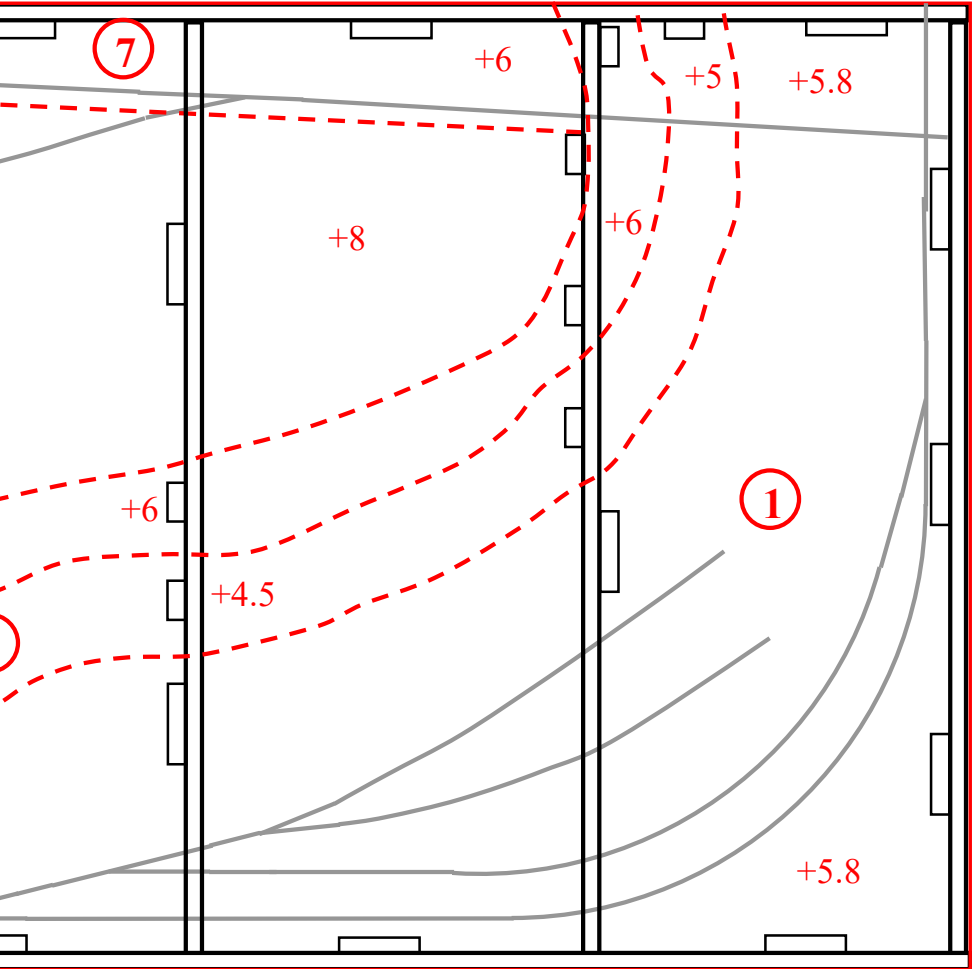

**Click here to rate or comment on this article**



## ONE MODULE CHALLENGE | 15

The following steps may be taken to build the module.

1. Assemble the frame as shown in [6].
  2. Cut the plywood to fit the frame and draw the track plan on it. The track and turnouts can be placed on the plywood and used as a guide when drawing the track plan.
  3. Cut the plywood into the 7 sections indicated in [6].
  4. Use Sections 4, 5, 6 and 7 as a guide to cut the foam that will lay on those pieces. Some of these pieces will have multiple layers of foam.
  5. Add risers to the benchwork grid and attach the 7 plywood sections to the risers at the appropriate elevations. Refer to [6] for guidance.
  6. Add cork roadbed and track to the Section 1, camp area. Spend time preparing and weathering the track. Many of the ties should be removed and re-spaced for a backwoods appearance. Clip some of the ends of the ties and paint and weather with a variety of wood tones. After the track is laid on the roadbed, dirt, gravel and weeds can be added all around to serve as ballast and natural terrain.
  7. Use sections of plaster cloth to form the creek and gorge areas, then add Sculptamold and some plaster rock castings. Paint using acrylic tints. Tinted acrylic gloss gel and medium can be used to simulate water at the base of the creek.
  8. Add cork roadbed to Section 6 then curve track around and attach to cork. Cut most of the ties of the track over the gorge away leaving the rails spaced by a tie every four inches.
- Make the trestle in place: glue the rails to the wood platform (made of ties glued to stringers), leaving space to extract the remaining plastic ties. After removing the last plastic ties, fill in the wood platform and add the trestle bents and cross members.

## ONE MODULE CHALLENGE | 16

9. Add the foam to the benchwork. Shape the foam as the track up the hillside is positioned, including the trestles. A small jig saw and Stanley Surform are good tools for shaping the foam. Liquid Nails can be used for foam/foam, foam/wood and track/foam connections. Foam would also be used to fashion the hill above the tunnel.
10. Paint the foam and track, add dirt, crushed leaves, grass, foliage, trees, etc.
11. Cut and attach the Masonite profile sheets to the sides of the layout.
12. Add structures and continue detailing!

Many of the suggested structures (Table 1) are high quality wood kits, of the type being modeled. The bunkhouses can be connected by wood walkways, if desired. I recommend scratchbuilding a large shed for the engine area using scale lumber, board and batten, and corrugated aluminum roofing to represent a simple structure constructed in place. There are also single engine house kits available which can be used as well. The KMP steam donkeys and spar tree are available from multiple online sources; the prices I quoted are from [modelrail-roadstuff.com](http://modelrail-roadstuff.com), which I've had good experience with. I believe there is plenty of potential with the kits I've identified—just thinking how they may be built, weathered and installed into the scenes raises my pulse rate just a bit.

At the loading site, two steam donkeys would be positioned around the spar tree. The “yarder” pulls cut logs from outlying areas to the loading zone. The other donkey, with two drums, runs the “loader” to lift and position the logs onto skeleton cars. The diagram [7] shows an arrangement of the steam donkeys, spar tree, tail tree and high lead line.

The haulback line moves the boom laterally, pulling against a counterweight (suspended log) on the opposite side of the boom.



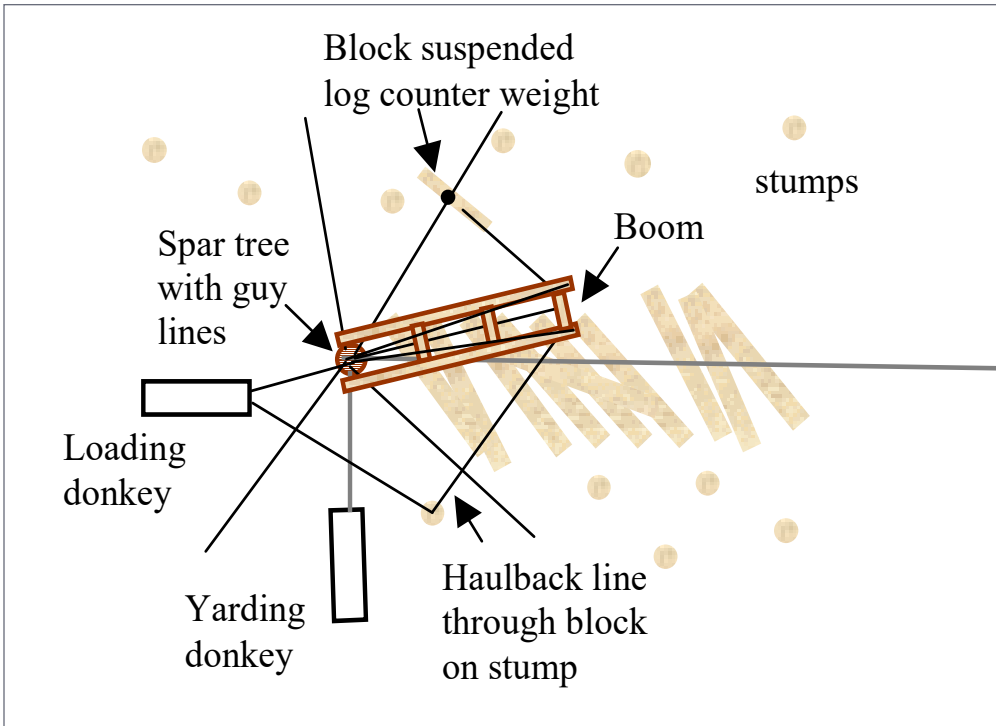

## 7. Top view of loading site with yarding and loading steam donkeys.

A good picture of a similar set up may be found in Fig. 10 of Jeff Sargeant's layout from the May 2015 MRH. Expand the picture and you will see how the suspended log and haulback works along with good examples of a two-drum steam donkey, spar tree, boom, and tong lines.

Trees add a lot of visual impact to the module. The tree types and sizes should be varied to look like a realistic forest. The big pine trees would be expensive to purchase and can be made much more cheaply using balsa wood trunks and caspia branches inserted into the trunk. John Olson described this method back in the '70s; more recent articles may be found in the 2015 April and June MRH. For demonstration, I've provided a photo of trees

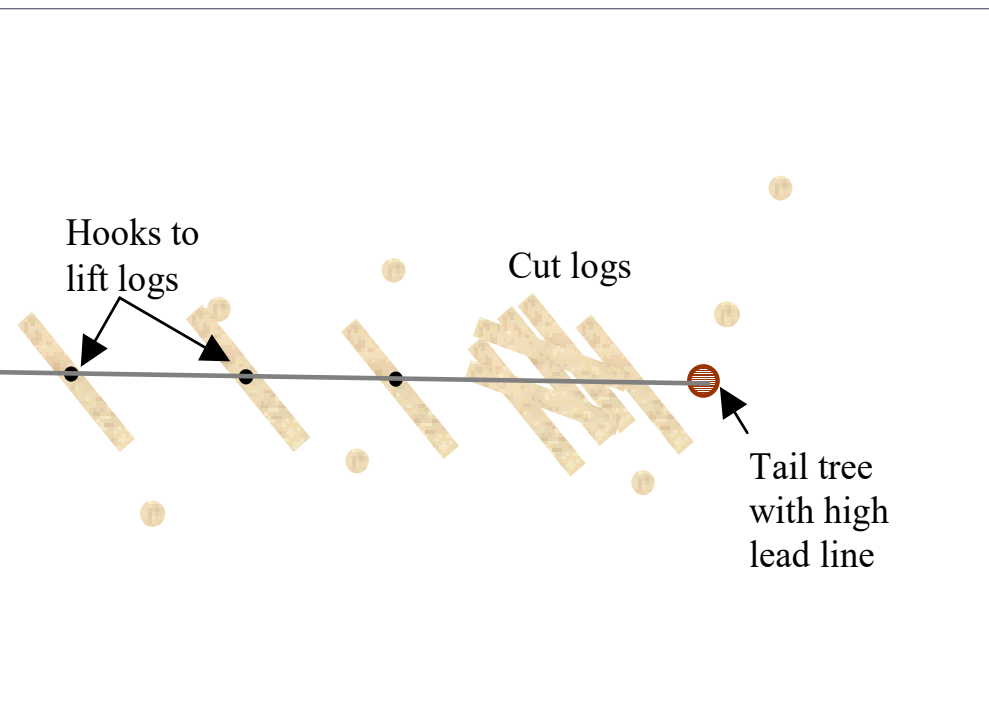

I've made using caspia along with the Campbell bunkhouse and a section of scenicked foam [8].

Other details include figures (Woodland Scenics makes a line of logging figures) and equipment and tools from Evergreen Hill Designs and Rio Grande Models.

The curves are tight on this layout. Engines and rolling stock should be kept as short as possible for best operation. Bachmann makes a nice looking Climax; it can sometimes be found for less than \$200. You could move the era up to the 1940s and introduce small diesel engines to do the switching work. Bachmann offers some old time cars that would work well. Reefer and flat car kits, both 36-feet long, are available from JV Models. You could scratchbuild short skeleton cars or use Kadee model kits for your logging fleet.

## Expanding the layout

My favorite part of this challenge is designing not just the first module, but all the modules that would eventually fit together to fill the defined space. I'll briefly describe the modules I envision and show how they can be joined to increase operating potential over time.

### Stage 1

First is the Easton module plus staging/runaround tracks and a short bridge section that connects to the track entering the tunnel. Positioning part of the staging module inside the closet maximizes

walk-around space while providing good access to all tracks.

Stage 1 operations include empty log cars into Easton, trading these with the loaded cars left by the local engine, and departing in



8. Campbell bunkhouse, and pine trees made of balsa and caspia branches.



reverse for the runaround staging track. The log loads in that train would be removed and placed on the empty skeleton cars being brought up the hill. It may take two trips to load the skeleton cars from camp as there is only room on the switchback for four cars plus engine. When all the cars are loaded and ready, a second train in the staging spur repeats the process. The engine in the first train can run around the cars and back into the staging spur to create another train. This process can keep two operators happily engaged, particularly if they alternate duties.

### Stage 2

The natural end of a logging line is the sawmill, and that would be the featured element in the Westlake module [10]. The closet area is perfect for this module; the doors would be removed and the module shaped to slide and rotate into place between the jambs. A curving backdrop and overhead lighting would set the view off nicely.

The log dump contains a ramp made of logs. A “poke” made of metal or wood angles across the track by the ramp at a height just above the cars. As the engine pushes the cars forward against the poke, the logs are pushed onto the ramp and slide down into the pond.

The pond itself would be modeled with many logs floating on the surface. The sawmill, to the left of the pond, has a jack-slip descending into the water to extract the logs one-by-one, winching them up and in. Many sawmill kits are available and can be highly detailed. Outbuildings can be placed along the right side of the module.

The Easton module and staging tracks connect to the Westlake mill module [10]. A curved corner piece and the bridge track provide more room for the operators. This layout supports up to three operators, one at the mill, one on the switchback, and another



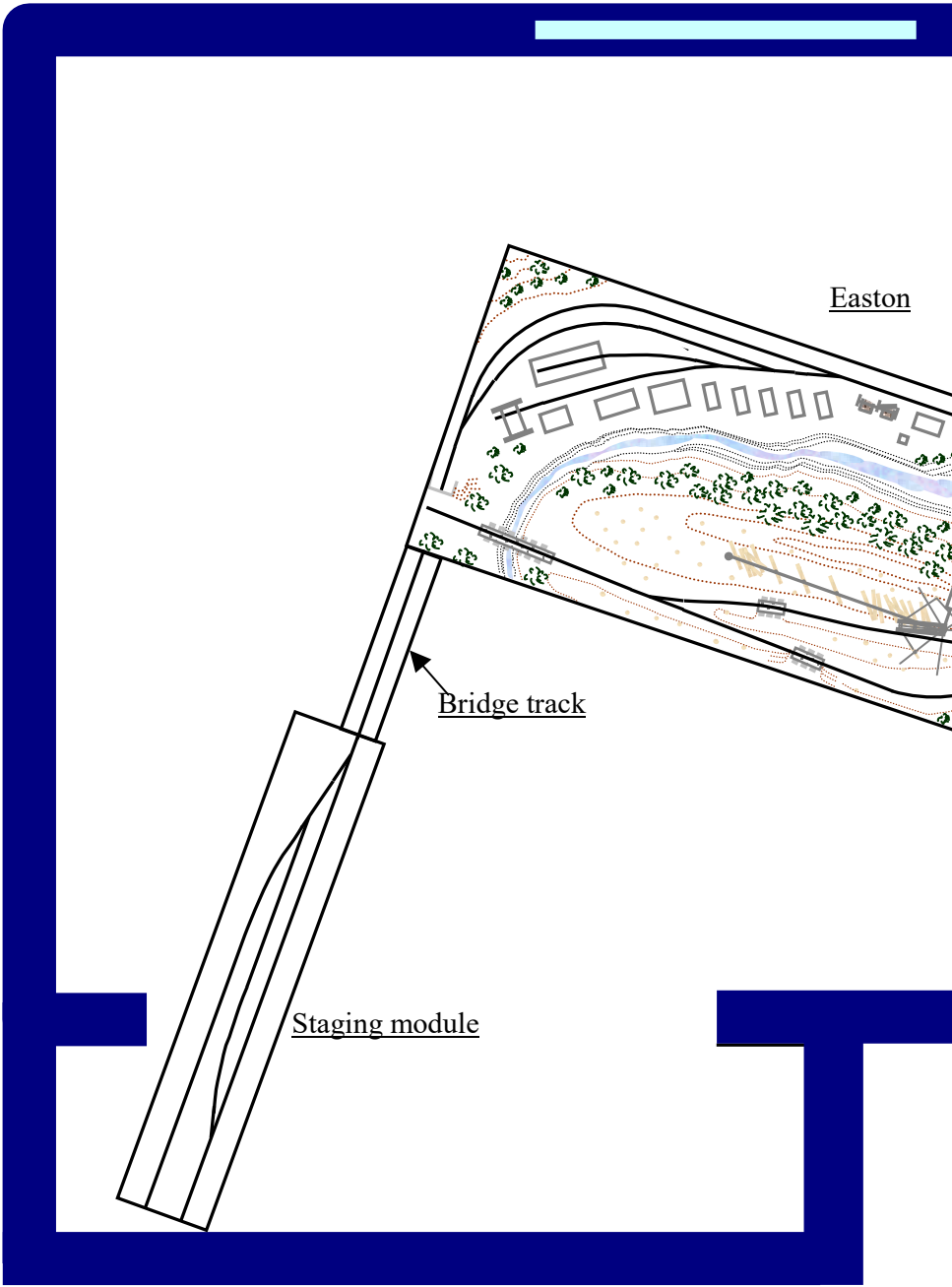

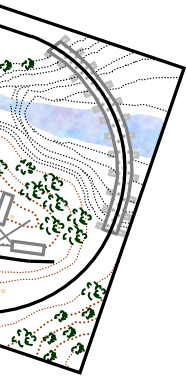

running the main. Switching log cars between the sawmill and Easton is a perpetual load-empty procession. Adding cars like boxes, flats or reefers for the Easton spur adds variety to the operations.

### Stage 3

In stage 3, the staging tracks are relaid as part of the Westlake yard module adjacent to the sawmill [11]. The yard has a turntable with engine service facilities and a car repair shop. There's a yard office, ice house and freight house. Hills are modeled in back with a mainline interchange track disappearing into a tunnel.

Operators shuttle log cars from the yard to the sawmill, exchange cars via interchange, service engines, and handle car repairs. Note that the car repair spur must be directly opposite the turntable lead track to allow an engine to push or pull cars across the turntable to the shop. Reefers from the

9. Stage 1 layout—staging and bridge sections added to Easton module.



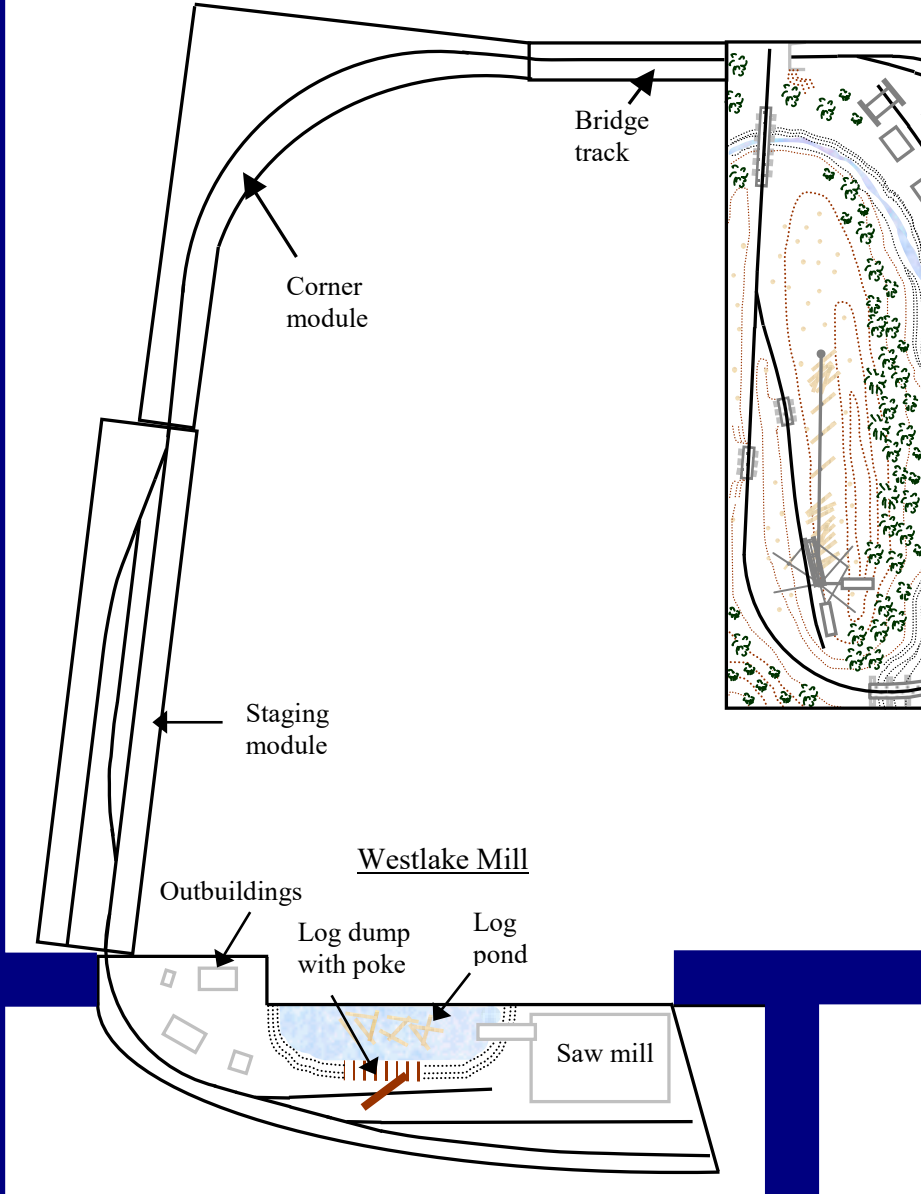

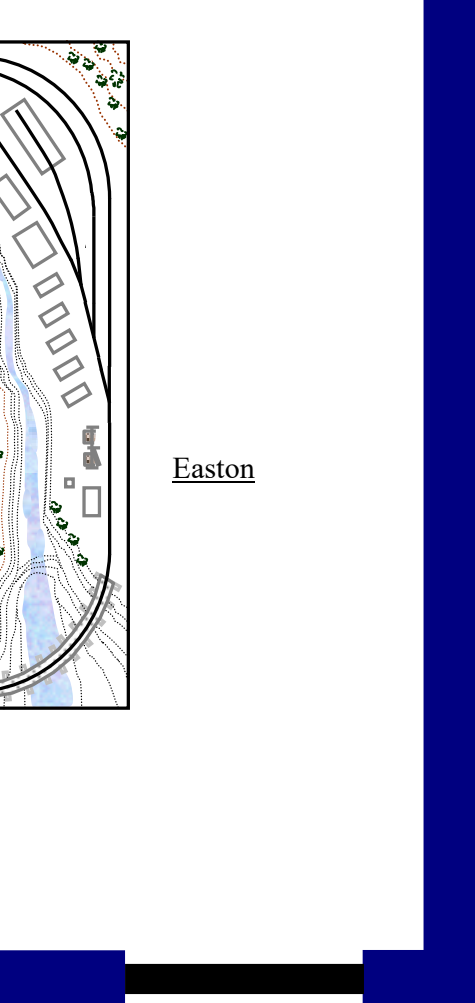

interchange can be iced prior to shipment to Easton, and the freight house also has cars to be switched.

## Stage 4

Stage 4 adds a furniture factory, warehouse and depot [12]. The Westlake town module increases the switching potential at Westlake as it provides a destination for the lumber in box cars loaded at the sawmill.

Also added is a stretch of main line and a turntable at Easton. Although steam locomotives can run in reverse, it's best if they run forward over longer runs, and the turntable provides that capability. The thin mainline

10. Stage 2 layout—Westlake Mill and corner module added.



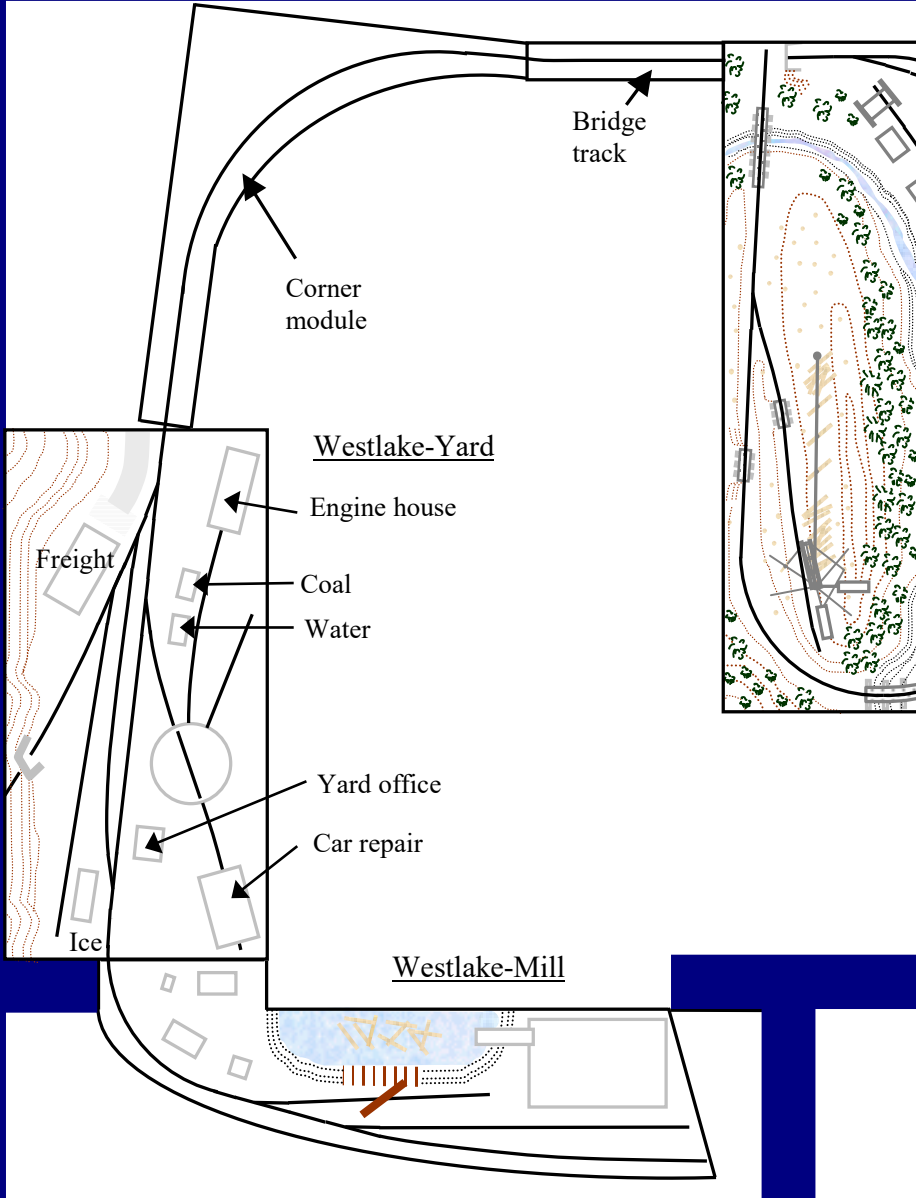

## ONE MODULE CHALLENGE | 26

stretch between Westlake and Easton is meant to convey several miles of distance, as depicted in the system map [13]. This map also shows how the interchange and the logging branch from Easton fit into the overall scheme.

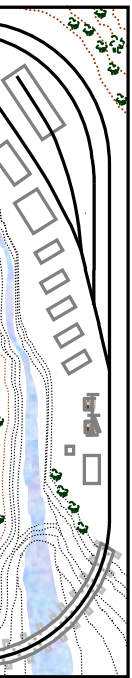

Easton

11. Stage 3 layout—Westlake Yard replaces staging module.



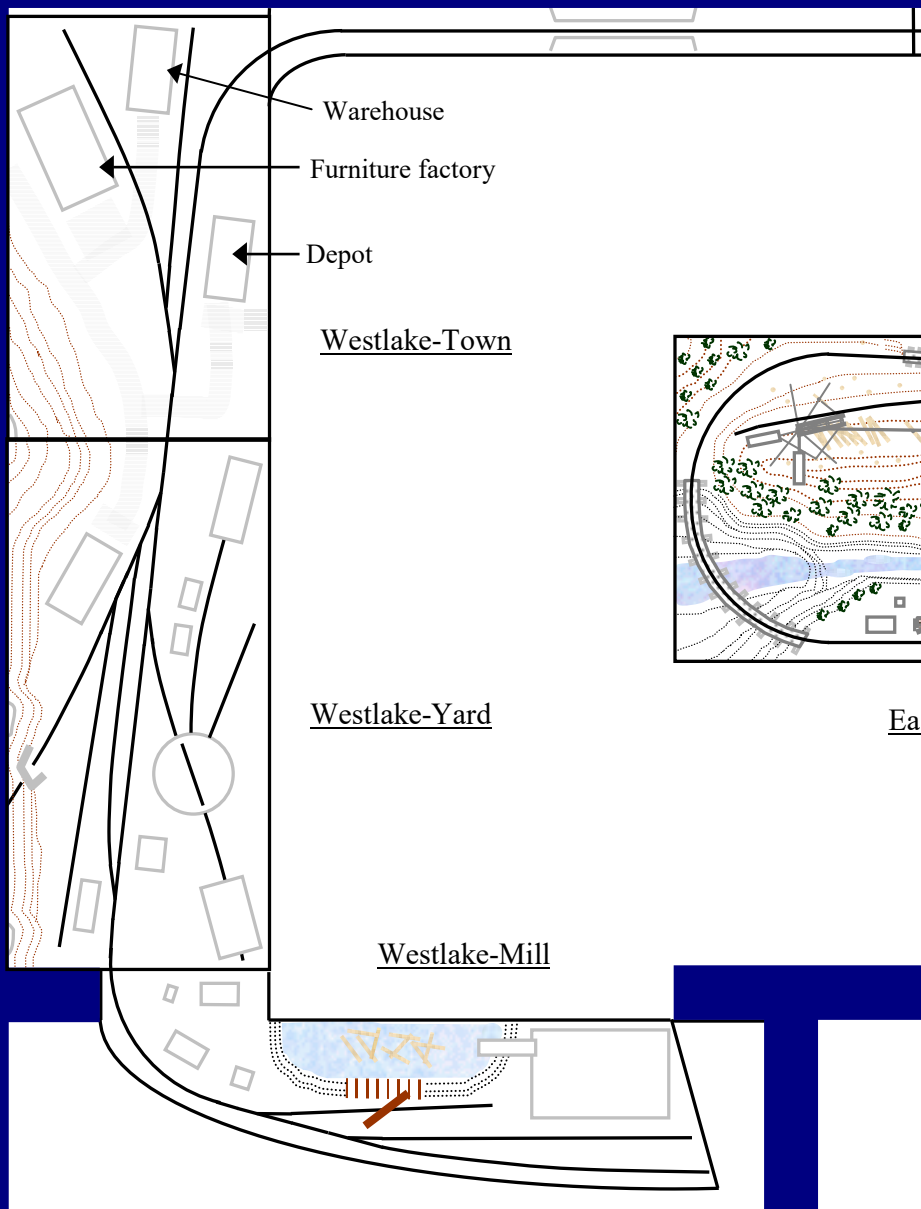



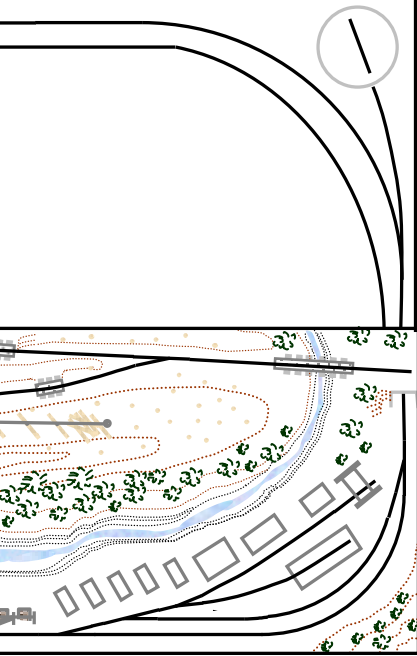

ston

The final layout provides a comfortable place to run trains with the aisles kept at three feet minimum width and there is nothing to duck under. Up to four people can enjoy operations: two switching Westlake, one running mainline trains from Westlake to Easton, and one operating the Easton switchback.

Many other car movements are also possible: cars to be repaired at the car shop, reefers of food obtained via interchange to be iced and sent to



[Click here to rate or comment on this article](#)

12. Stage 4 final layout—Westlake Town, connecting track and turntable added.



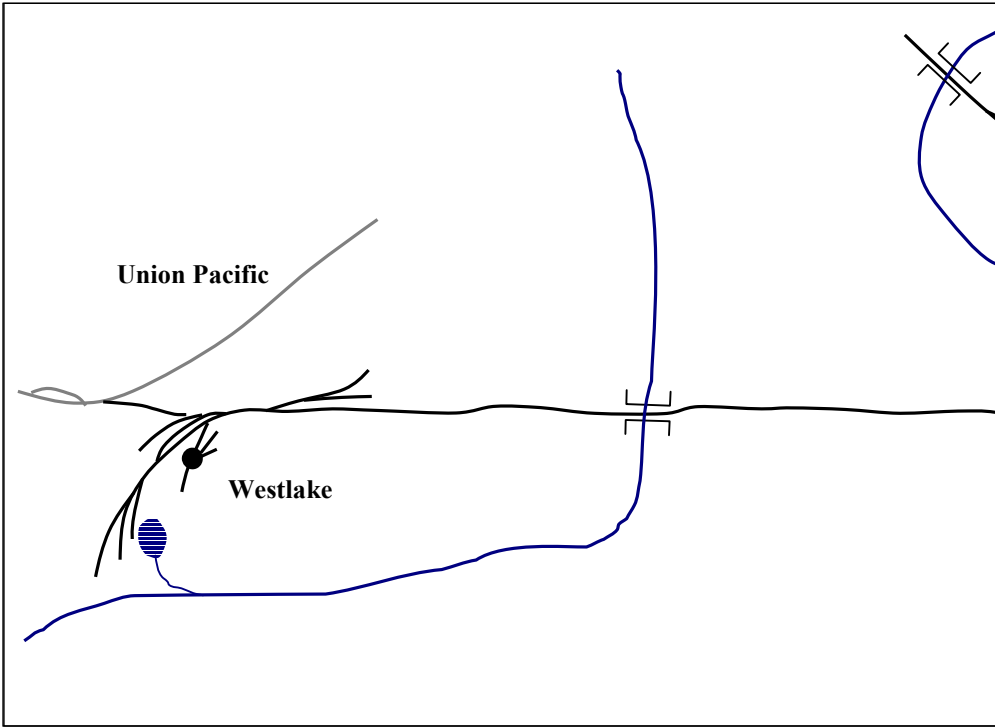

### 13. Easton Logging Company System Map.

the cookhouse in Easton, tank cars carrying fuel for the steam donkeys obtained via interchange and sent to Easton, flat or box cars carrying supplies from the warehouses in Westlake and mail/passengers picked up at the Westlake depot for travel to Easton. Engine service and turning would also play a large role in the operations of the layout.

All modules can be removed from the room if the need arises. Any of the Westlake modules or Easton would make for a fine display at outside shows. The modules wider than 30 inches would have to be tilted upright to pass through the door. The Easton module is about 18 inches high, not counting trees, so depending on the height of your trees, you may have to remove

## ONE MODULE CHALLENGE | 30

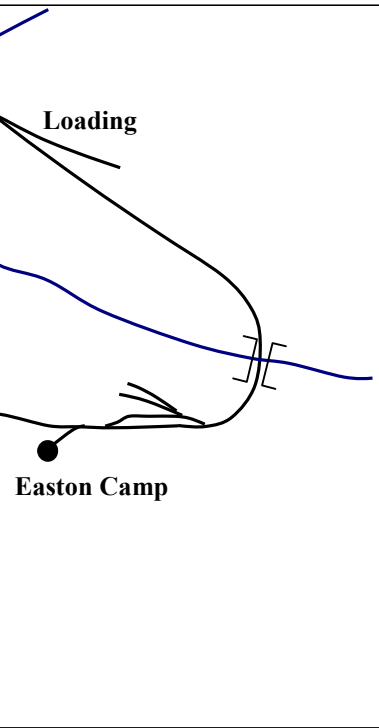

some of them and the spar tree before proceeding.

I hope you enjoyed this foray into the woods and back. I know I have. It's been fun. If anybody decides to build Easton I'd love to see a picture or two.



[Click here to rate or comment on this article](#)

**Want to help keep  
MRH free?**

**Then *click* on ads!**



## PETER VASSALLO



Peter lives in Albany, NY and works as a mechanical engineer. Despite living in New York all his life, he has developed a fondness for western railroads, particularly the old narrow gauge lines of Colorado and California. He enjoys both modeling and photographing these types of scenes. A story on his freelanced HO<sub>n</sub>3 layout, The Alistair Road, is scheduled to appear next spring in the Narrow Gauge and Short Line Gazette.

**Please include  
a phone  
number when  
contacting  
MRH**

**(in case your spam  
filters eat our  
email response)**

### ADVERTISEMENT



**COMING SOON  
IN HO SCALE!**



**We plan to produce an HO Scale version  
of our very popular Mt. Albert Lumber Yard  
kit later this year. Please watch our website  
and Facebook page for more details.**

# The MRH Media family

## Model Railroad Hobbyist magazine™

mrhmag.com

store.mrhmag.com

Model  
Railroad  
Hobbyist  
*Store*

Brought to  
you by

**MRH**  
MEDIA

trainmasters.tv



Shop the MRH Store ...



Model Railroad  
Hobbyist *Store*

Helping you achieve your model railroading dreams



Search

MRH Storefront

About MRH Store

Contact MRH

Cart (0)

## Welcome to the Model Railroad Hobbyist *Store*



Problems with an order? Call 800-920-6020 for help during US business hours.  
Or email store@mrhmag.com any time.

Select the category you want to browse:



Videos



Books



Downloads



Other

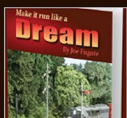
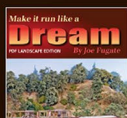

• INDEX



SUBSCRIBE  
(free)

• TABLE OF CONTENTS



# The Jemez & Rio Grande

*— A continuously evolving layout*

BY JIM GORE, MMR

***This layout will be on tour at the  
NMRA National Convention in  
Orlando this summer!***

**MY ON30 LAYOUT, THE** Jemez (pronounced “Hay-mez”) & Rio Grande, has been in existence for about a decade but it is always being changed and rearranged. By most standards it is not “typical” of today’s layouts; being quite small [only 12’ x 16’] and much more of an exhibition



• [INDEX](#)

• [TABLE OF CONTENTS](#)

1. Southbound #125 down-grade from Caballo Pass into Valle Grande about to cross Frijoles Creek. *Photograph by Greg Komar*



[Click here to rate or comment on this article](#)

layout, showcasing detailed scenes, than it is a large operator's layout. Oh, I do operate the layout from time to time [it will accommodate 3 or 4 people] but 99% of the time, my wife and I are the only ones who view the layout and we both enjoy detailed scenes that tell a good story.

The J&RG is a prototype-freelanced railroad, based upon a rumor and a single photograph. That photograph, which appeared on the History Channel quite a few years ago, was of J. Robert Oppenheimer, director of the laboratories in Los Alamos, New Mexico, during World War II, as a focus of the Manhattan Project (the atomic bomb).

He is seen, standing with some other unidentified people (rumored to be other scientists or his "keepers") standing on the rear platform of an observation car of a D&RGW passenger train.

The location of the photo is not identified but is said to substantiate the theory that the narrow gauge Santa Fe Division, otherwise known as the Chili Line, was not abandoned in late 1941, but continued to operate, serving the needs of the laboratory, since there was a small "station" [actually an old boxcar and a platform] at Otowi, a few short miles from the lab, and the Tea Room operated by Edith Werner, also station agent, was frequented by laboratory scientists. I guess, with enough imagination, these are all good reasons.

Having grown up in Los Alamos and having hiked the old narrow gauge roadbed with my father, when we fished the Rio Grande near Embudo, NM, I have always been fascinated by the railroad



# THE JEMEZ & RIO GRANDE | 3

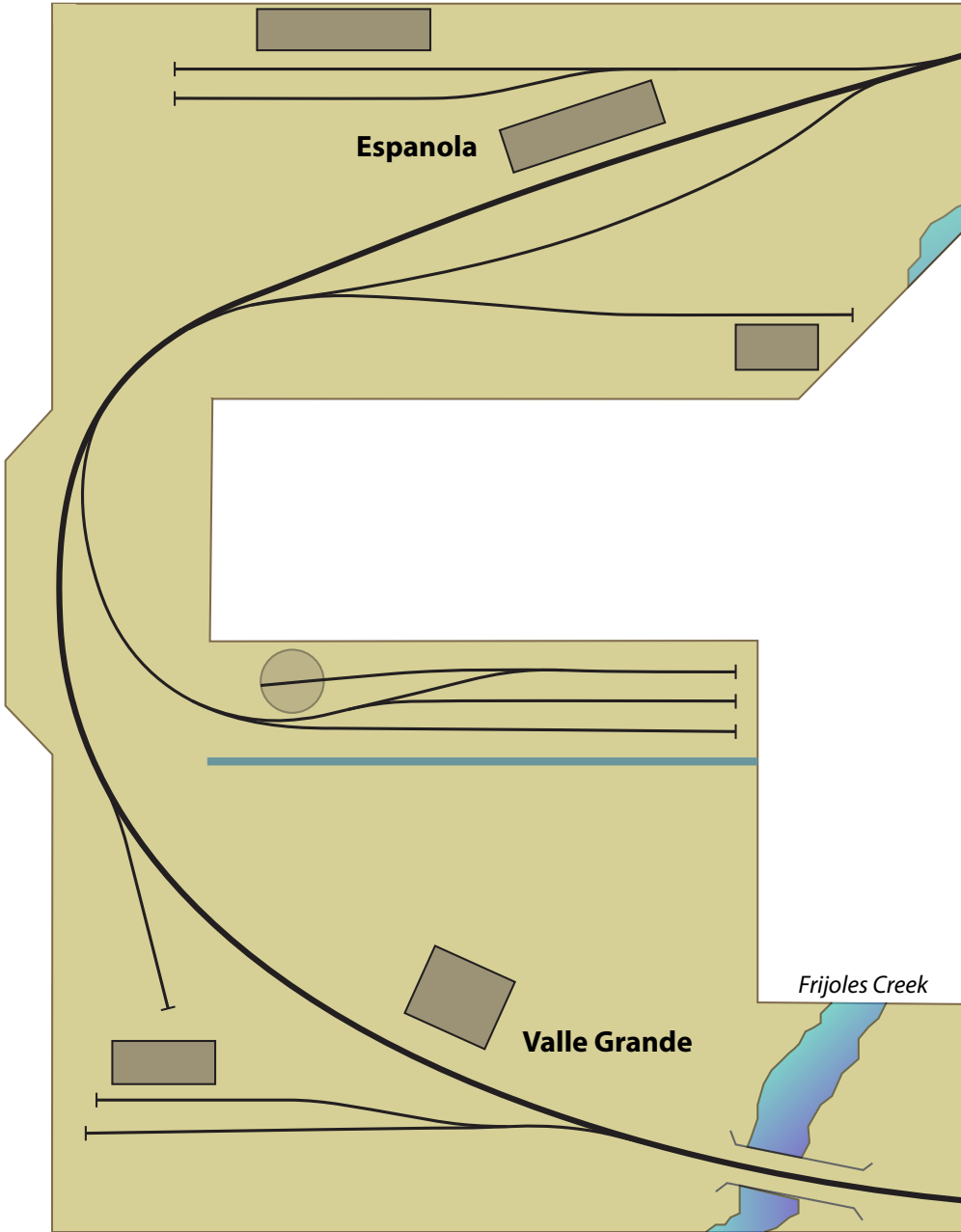



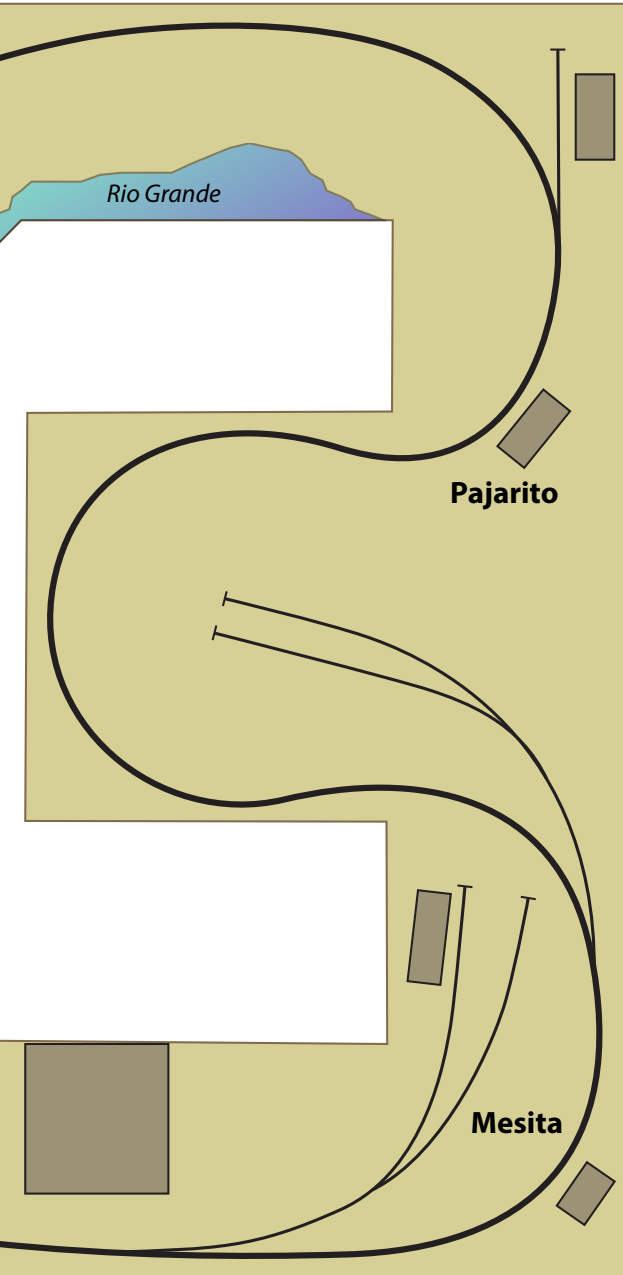

# The Jemez & Rio Grande TRACKPLAN

Layout size:  
12' x 16'

Scale: On30



# THE JEMEZ & RIO GRANDE | 5

I never saw (I was born 8 years too late). There were so many rumors circulating about Los Alamos during and immediately after the war, including speculation that they were making submarines in the high desert of New Mexico, just about anything was possible. So, the J&RG was born out of some daydreaming, one day; “What if.”

## The Story

The J&RG lies in that hazy area between prototype-freelance and purely fictional. It relies upon D&RGW-style structures and rolling stock and follows scenery typical of the high deserts and mountains of northern New Mexico.

It is a narrow gauge layout but, even there, I made compromises. After 20-some years modeling the SP&S and the NP in HO, I simultaneously bought an On30 Bachmann set for the Christmas

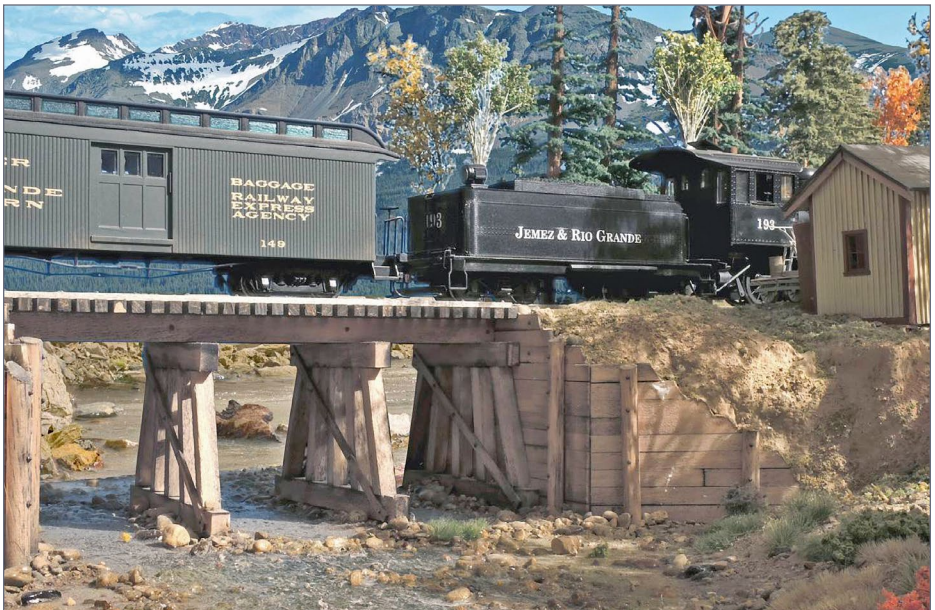

2. A day later, southbound mixed train #125, crossing Frijoles Creek. *Photo by Greg Komar, courtesy of the NMRA*



3. A typical adobe hacienda in Espanola, NM. My father-in-law reading his newspaper and drinking his morning coffee. Typical New Mexico vegetation including yuccas outside the wall and prickly pear in the center of the patio. Since it is October, the prickly pear is bearing fruit (made from mustard seed).  
*Photo by Jim Gore*

tree and moved from Georgia to Florida and a new job. The Bachmann equipment ran so smoothly that I decided to abandon HO and see what could be done with On30 in my new Florida basement, an enclosed 2-car garage. Indeed, On30 had the “heft” that I enjoyed in my days of Lionel.

At the time, On30 was less expensive than On3 but large enough to add detail easily and O-scale structures really hit me as fun to build and detail; really telling a story. Since then, any number of large and small manufacturers has added to the availability of locomotives, rolling stock, and structures.

## THE JEMEZ & RIO GRANDE | 7

I also discovered that the more finely detailed On3 rolling stock was easy to convert to On30. With all of this in mind, I could finally model an area that reminded me of my youth in and around Los Alamos.

Google Maps helped me to determine the best route and location of the railroad. Much like the restrictions on scientists to travel beyond Otowi during the war, I assumed that security would still make it a difficult decision to allow a railroad to travel into the laboratory areas which, in the early 1950's were not consolidated into a single area on "The Hill," Pajarito Mesa.



4. Los Alamos National Labs receives its shipments at Zia Receiving in Valle Grande. They've just accepted four barrels of radioactive material. The building is cardstock and has been on the layout for over 10 years, same for the water tank behind, a Clever Models kits based on an old John Allen design.

*Photo by Jim Gore*



5. Another cardstock structure, the Caldera Brewery (to the left) receives materials from the J&RG. The platform to the left is a transfer point to the Santa Fe Northern standard gauge. *Photo by Greg Komar, courtesy of the NMRA*

So, if the railroad continued to exist during WWII, or if a new branch was completed later, it would go to an outlying location where materials transfer could take place. Following the lead of the small facility at Otowi, I created a similar transfer point in the Jemez Mountains, a little closer to Los Alamos and accessing the richest cattle producing area, the Baca Ranch in the Valle Grande, now called the Valle Caldera Preserve; operated by The Nature Conservancy.

With active railroad service to the labs and the ranches [along with a small mining operation], I reasoned that the town of Valle Grande would expand a bit and could also be a transfer point between the narrow gauge J&RG and the standard gauge Santa Fe Northern, a logging operation that was linked to Santa Fe.

## The Layout

The J&RG is a fairly simple design so that a lot of scenery, structures, and detail can be exhibited. It occupies a 14' x 16' space in our enclosed two-car garage. The layout is a loop for exhibition but has a small yard so that a single person can assemble a mixed train, take it north or south and service the few industries along the way.

The trackplan is relatively simple with both continuous running and point-to-point operation possible; the staging yard representing Santa Fe or somewhere close.

Benchwork is commercially produced by Mianne (I hate benchwork, since my hands apparently terminate in 10 thumbs) which



6. Part of the barrio in Espanola, showing the other types of native vegetation in the high desert; ocotillo (to the left) and ironwood (center). Back in the early '50s, wandering burros were common in some parts of town.



7. Number 603, an outside-framed Consolidation crosses Frijoles Creek. Photo by Jim Gore



# THE JEMEZ & RIO GRANDE | 11

is now supporting its fourth layout. Bench width is 32” at its widest which creates mighty narrow aisles inside the layout but, since there is usually only one operator (me), it is not much of a bother.

All turnouts are #5 and the maximum grade is some 3%, so short trains (usually six or so cars, in keeping with the mixed train concept of the old Chili Line) are the order of the day. Except for one spot, the minimum radius is 24” but, even then, K-27s, etc., look goofy, so I don’t run them, sticking with 2-8-0s and 4-6-0s. However, the road just purchased a 2-6-6-2 to serve some new mining activity.

The layout has been under construction for some 15 years and, in its infancy, I used Peco code 100 rail; now being replaced by Micro Engineering code 83 track and turnouts. The layout is DCC with drops for every section of track.



8. The “adobe” end of Valle Grande; populated by Thom Yorke plaster kits and a few cardstock structures from Clever Models.  
*Photo by Greg Komar*



When I first heard about DCC, I was just down the road from Digitrax in Atlanta, so it was my obvious choice. If I screwed up (I am prone to do that), technical support was close. So far, I haven't screwed up as we have both moved farther apart.

I've tried everything for the basic landforms including ceiling tiles for rockwork and Howard Zane's red rosin paper scenery, but most of it is foam-supported cardboard webbing and wadded newspapers covered with plaster cloth. To me, soil and appropriate vegetation makes the layout come alive, so I have been careful to create the correct environment.

### The Environment

The layout is set in the first weekend of October, 1951; the time of the Feast of San Geronimo at many pueblos in northern New Mexico. That gave me an opportunity to portray the pueblo people setting up a celebration and also wearing some unique regalia for the ceremonies. Yes, I know I still have a long way to go on that particular scene. I chose 1951 since the D&RGW was still operating narrow gauge a little further north and it gave the owners of the J&RG some time to get things up and running after the war.

In my mind, one of the pleasant components of any model railroad layout is to create an atmosphere that is similar to the area being modeled. Soil on the layout has been collected from areas around Los Alamos, Santa Fe, Buckman Mesa, and along the Rio Grande in New Mexico. All surfaces are first covered with a custom blend of brown latex paint similar in color to the mud used in making adobe, then sprinkled with the native soil, other contrasting soil colors, ground foam and Silflor tufts for ground cover.

Trees are commercial and hand-made using various types of sage armatures, twigs, Sweetwater Scenery armatures, and SuperTrees, as appropriate to the scenery needs. Some aspens are made from pepper grass.



## THE JEMEZ & RIO GRANDE | 13

Water features are made by two methods. Frijoles Creek was painted various colors of sand and dark green to show the transition from shallow depositional areas to deeper pools. Rock and wood debris was placed in appropriate areas, and a layer of Woodland Scenics “water” poured onto the area.

When it was dry, it was first painted with a coat of gloss medium. After the medium had dried, various “riffle” features were created using a crystal clear calking material which was dry-brushed with a little white acrylic paint and then covered with gloss medium again.

The small portion of the Rio Grande was first painted and then covered with layers of gloss medium, crystal clear calk and more layers of gloss medium. The pond in front of the old mountain cabin is poured resin with appropriate underwater features, and cattails, etc.



9. The “bumblebee” 2-8-0, borrowed from the D&RGW, climbs Caballo Pass (2.5% grade). *Photo by Jim Gore*

Not only do soils and rock formations come into consideration, but vegetation must be convincing. Having lived in the area helps and being a professor of environmental science for over 40 years doesn't hurt either! High desert environments of New Mexico are characterized by some very distinctive plants, trees and shrubs.

Below about 6000' elevation, dry areas are dominated by sage, isolated grasses, prickly-pear cactus, ocotillo, and, of course, the state flower, yucca. Along the streams and rivers, one can always see willows and cottonwood, turning red and yellow in the Autumn.

Above these elevations, the distribution of trees is determined by the amount of exposure to the sun. On the west-facing slopes, Ponderosa pines and Douglas fir dominate while east-facing slopes tend to be dominated by Engelmann spruce and sub-alpine fir. All of these conifer forests have patches of another relative of the cottonwood, aspen, as an indicator of previous fires and disturbance.

Structures in the region are unique to northern New Mexico. This is the land of adobe structures, especially pueblos occupied by Native Americans of the region; Taos Pueblo being the most famous. This architecture was also adopted by the Spanish colonists so variations on this architectural are widespread; even buildings of brick covered in stucco to resemble adobe.

If not adobe, most structures were wood with distinctive western flavor. My layout then is replete with adobe structures, some made by Tom Yorke, from his "Frijoles Flats" series, along with some structures, including the San Pablo Pueblo, made from balsa (see *Narrow Gauge and Shortline Gazette*, November 2008).

I have constructed the buildings from scratch using 3/8" balsa covered with the brown latex base coat, and impregnated with a fine dust to give texture. The pueblo at San Pablo is my own design and incorporates features from Taos, Santa Clara, and Jemez.



## THE JEMEZ & RIO GRANDE | 15

Doors are a combination of wood and blanket (painted foil). However, in northern New Mexico, there were as many wooden structures as adobe, so structures must be western in appearance. For example, although a few shingle roofs appear, most roofs were covered with corrugated iron, seamed iron, or tarpaper. I remember green tarpaper was very common.

Fences and signs are added where appropriate. Power lines have been wired with a stretch-line used in beading. The angled power poles are done on purpose – when I was a kid, they never seemed to stand vertically, especially in Espanola.

I love to create highly detailed structures with lighted interiors so those kits designed by Roger Malinowski are a particular favorite and appear in many layout scenes. Finally, I have become known



10. Wright's Repair demonstrates that even a good cardstock structure can have a complete, lighted and detailed interior.  
*Photo by Greg Komar*

for building structures from cardstock, both kit and scratchbuilt. With a little work and layering and painting of material, I can make structures that are detailed and have lighted interiors. I have test-built structures for Clever Models and many appear on my layout. One was good enough to appear on the cover of *O Scale Trains* a few years ago.

Although many visitors think that the cardstock models are not durable, will warp, or fall apart, I have structures on my layout that are over 15 years old without fading or warping. There are a few tricks I have learned over the years, like using lip balm on the bottom edges to prevent moisture from wicking in and spraying the structure with a dull coat to prevent UV damage, but if they can survive the changes in humidity in Florida, cardstock structures are another medium to consider.

Ultimately, I want every visitor to the layout to enjoy the movement of the trains through realistic high desert and mountain scenes along with “stories” that the visitor must discover. I love to hear repeat visitors tell me that they see that I added this or that to a scene when it has been there for years.

That’s a basic principal of creating museum dioramas (a course I took in my undergraduate years some 50 years ago. The central subject can be viewed and appreciated in a short time, but a closer examination will reveal a wealth of detail and “stories” about the scene.

## The Future

I always look at every layout as a chance to experiment and a chance to learn for the next layout. The J&RG is not my last layout. In a few years, the J&RG will come down as we move to a new home and I begin the construction of the “retirement layout.”



## THE JEMEZ & RIO GRANDE | 17

I already have the room picked out and have already determined some new ideas and requirements:

- Keep the detailed structures – that’s my favorite part
- 3% grades are acceptable so I can use helpers
- I need a little more operational interest so the next layout will be about twice the size – I will keep the same timetable and train-order operation – after all, there is only one northbound and one southbound per day
- I want a little more of Santa Fe – perhaps the line running down Guadalupe Street
- More generous radii is a must – I want to operate the “Mudhen” and the K-36 that are just sitting on the shelf
- Although the Bachmann rolling stock is nice, it will be replaced by more D&RGW type cars
- Expand cattle operations

The current J&RG will be on the Orlando NMRA tour and I hope that people will enjoy my small layout. In a few years you will have to come to New Hampshire to see the new and expanded Jemez & Rio Grande.

***Jim's layout  
is on tour at  
this summer's  
Orlando NMRA  
National***



## JIM GORE



Jim Gore has been a model railroader pretty much all of his life, graduating from his father's standard-gauge Lionel layout to N to HO to On30. Jim has published his work in *O Gauge Railroading*, *O Scale Trains*, *Model Railroader*, *Sn3 Modeler*, *NMRA Magazine*, and *Narrow Gauge & Shortline Gazette*. Jim is a retired Dean and Professor of Biology and spends most of his time traveling with his wife, gardening, and kayaking rivers of

Florida. He also does custom building of structures out of card-stock and other exotic materials.

Jim is a Master Model Railroader (MMR).

---



[Click here to rate or comment on this article](#)



# CRASH BARRIERS



BY MIKE HOLLY

## *Safety first, a crash barrier for your grade crossing signal in N scale ...*

**FINISHING A LAYOUT SCENE IS SOMETIMES DIFFICULT** in N scale due the lack of detailing parts. I needed some crash barriers to protect my grade crossing from road traffic.

Follow along as I demonstrate how to make convincing N scale crash barriers in any length.

• [INDEX](#)

• [TABLE OF CONTENTS](#)





[Click here to rate or comment on this article](#)

## Step One

Barriers are constructed from two copper wires. The first task is to straighten two 30 cm (11-3/4") pieces of 1 mm diameter (AWG 18) wire. I clamped the two pieces onto a piece of scrap wood. With the two wires held tightly together, I filled the gap on the top side with solder, starting on one end and proceeding along the length. The copper wire holds heat a long time, so don't burn your fingers!

After the soldering was completed, and the wire cooled, I cut the raw crash barrier to the desired length using a wire cutter. I added 0.5 cm (0.2") to each end of the barrier for the end fenders [1, 2].

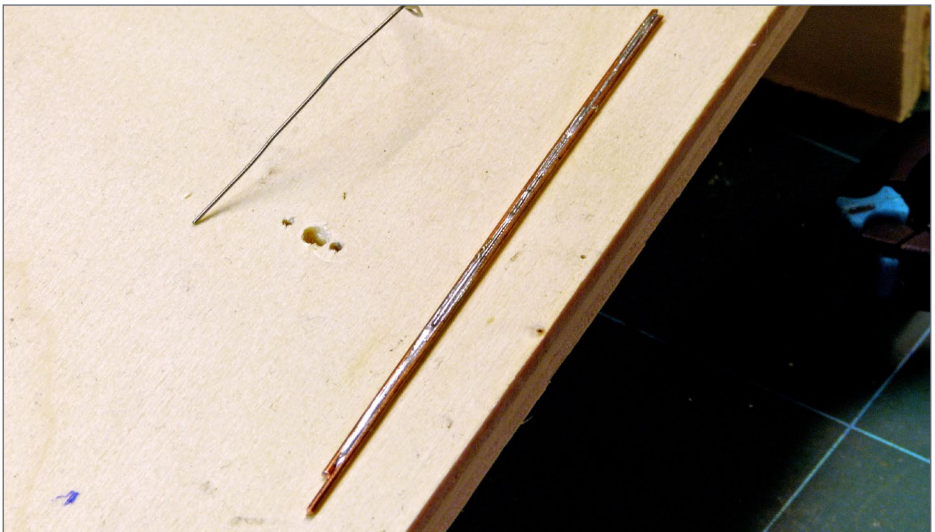

1. I straightened two pieces of copper wire and soldered them together.



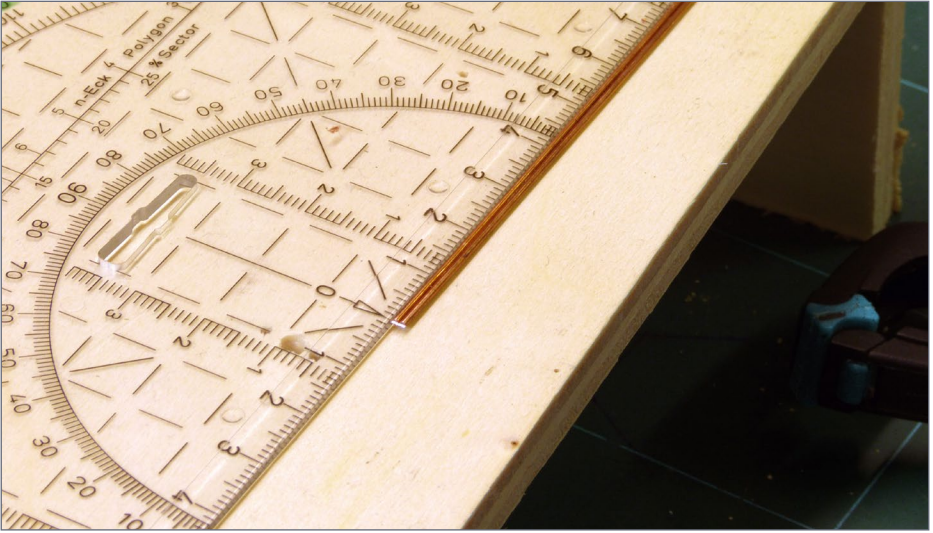

2. After soldering, I used a wire cutter to trim the barrier to the desired length.

## Step Two

I formed the fenders at both ends of the barrier by clamping 0.5 cm (0.2”) of the end between two flat steel plates, and secured them in the bench vise. I gently tightened the bench vise to flatten the barrier ends.

Next I cut down the long fenders, and used a file to bevel the transition from the barrier to the fender. A little twist on the very last section of the barrier will help the fender to smoothly face the barrier [3, 4].

## Step Three

For the crash barrier to wrap around the crossing gate, I needed to bend the barrier two times, forming a U-shaped profile. I did this using two flat-nose pliers.

## CRASH BARRIERS | 4

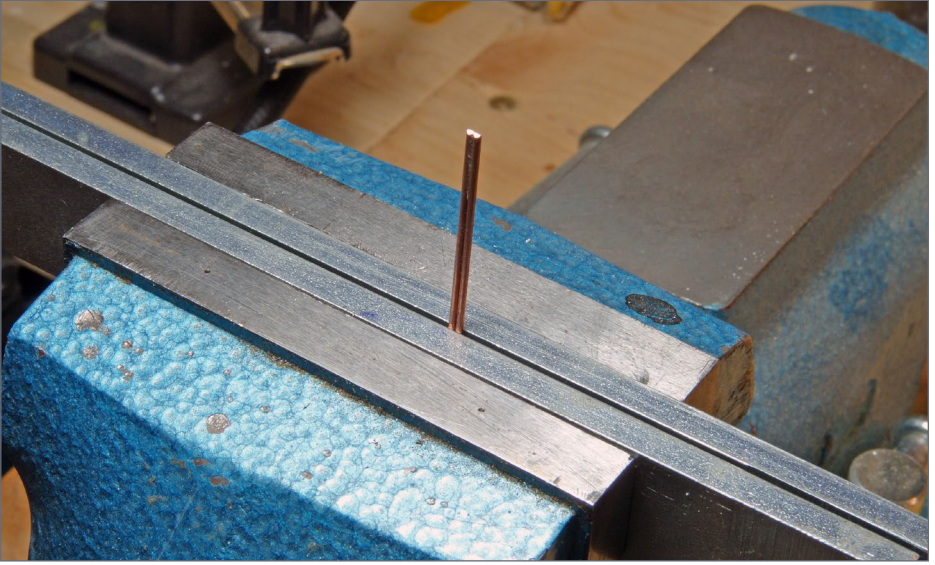

3. To form the fenders, flatten the ends of the barrier using a bench vise.



4. After flattening the ends, they need to be trimmed off and filed to make a smooth transition to the barrier.

## CRASH BARRIERS | 5

Next I soldered mounting brackets to the barrier, long enough to secure the barrier into the sub-terrain of my layout. I used 0.5 mm diameter (AWG 24) copper wire for these brackets. To prevent melting the solder joints on the barrier itself, I just lightly touched the hot iron to it. Tinning the mounting brackets first helped reduce soldering time as well [5].

### Step Four

With the brackets mounted to the barrier, I test-fitted the assembly and made corrections where appropriate.

Then I removed grease and dirt from the barrier using 90% isopropyl alcohol, and spray-painted the barrier light gray [6, 7].

Hopefully this tutorial will help you make crash barriers for N scale easily!



5. After bending the barrier to a U-shape, I soldered 0.5 mm (AWG 24) brass wire to it to make a mounting post.

## CRASH BARRIERS | 6

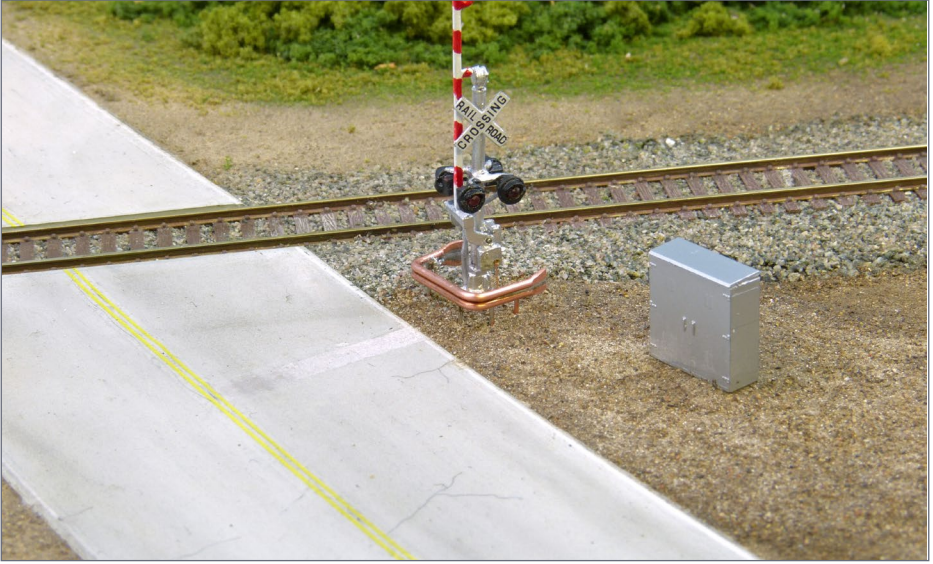

6. After all the work was done, I test-fitted the barrier around the gate to ensure everything was correct.



7. Finally I spray-painted the barriers gray, and glued them into the final position with white glue.

## MIKE HOLLY

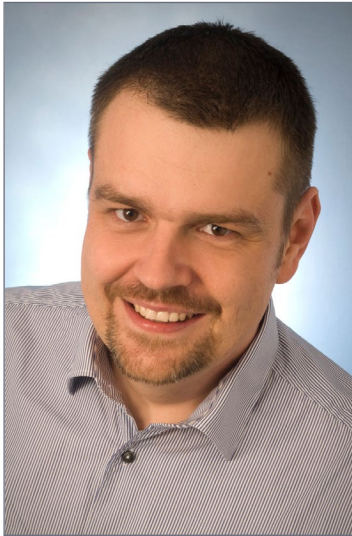

Mike lives in Germany, near Wiesbaden.

He got his first train set at the age of 10. After that he began two German-themed layouts. After visiting a local U.S. model railroad convention a couple of years ago, he got infected by the US model railroad virus.

While planing his house, he convinced his wife to add a dedicated room in the basement for his model railroad. After moving in he started planning his first, and current U.S.-themed-layout. It was proto-freelanced and called the “Elizabeth Oaks Branch Line,” which is operated by the fictional Cleveland & Eastern Railroad Company, and set in Northeast Ohio and western Pennsylvania. Construction began in 2011, and he is planning to extend the layout to add more operation spots.

Mike earned a Bachelor of Engineering degree in Road Design and Construction. In 2015 he joined the National Model Railroad Association (NMRA) – European Region, and was awarded the Golden Spike Award in November 2015.

He is married to Nicole, and has a 4-year-old daughter who loves railfanning.



[Click here to rate or comment on this article](#)

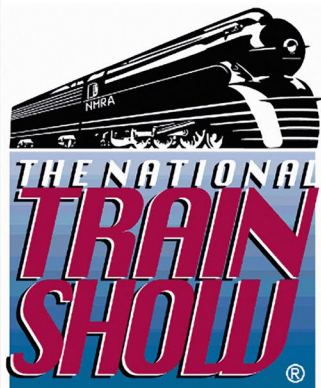

# 2017 National Train Show

August 4 - August 6, 2017

in **ORLANDO, FLORIDA**

Get the details >>

*(click me)*

## Fun for the Whole Family

From your littlest engineer ...

To the most experienced Model Railroader



- The World's Best Known Manufacturers
- Over 180,000 square feet of exhibit space
- Hands-On Demonstrations
- 44,000 Sq. Feet of Modular Layouts
- Ask The Collectibles Appraiser
- The Incredible Lego® MiniLand



A depot scene for the ...



# PITTSFIELD BRANCH

BY BARRY SILVERTHORN

## *Building a Scene for Our TOMA Layout on TrainMasters TV ...*

**WHEN WE BEGAN PLANNING OUR TOMA** (The One Module Approach) layout for TrainMasters TV, the fictitious Pittsfield Branch, I had to find someone who could assemble a pile (literally) of structure kits Walthers had provided for the project.

Looking at the selection of models that we had to work with, I quickly realized that building them would be a lot of fun, and since they were sitting just a few feet away from my workbench, I was probably the best person for the job. A recent trip to Vermont to photograph the prototype Vermont Railway had left me with plenty of inspiration to launch the project. I was hired!





[Click here to rate or comment on this article](#)

Recreating the flavor of rural Vermont using readily available kits was a pleasant challenge, but there were a couple of scenes in particular I was really looking forward to building and detailing. The first was the depot at Pittsfield.

If you study photos of today's Vermont Railway you'll find a charm that's missing from most modern railroading. Many of

Vermont's depots are still standing – if not occupied. When I came upon the shuttered station at Ludlow, Vermont I was surprised to see an intact semaphore on the mast outside the operator's window – an unusual and quaint feature for any railroad in 2017.

There are few opportunities to include stations on a contemporary model railroad. I



1. Here are just a few of the structures I had to assemble. I have the best job in the world!



## A DEPOT SCENE | 3

thought, “How novel would it be to include a depot while modeling a short line in the present day?” Being able to board up the windows seemed like a great excuse to weather it heavily. Here is a chance to let the scene tell a story about the history, and present day use, of the location.

A mothballed station scene offers a great opportunity to add lots of details. In fact, it could be argued that modeling a modern scene around a lesser-used station can be more interesting than building one that’s in service.

I started out with Walthers’ Pella Depot kit. Although the actual prototype station is located in Iowa, to me it’s typical of a small brick depot that could be found just about anywhere in eastern North America.

The kit’s assembly instructions recommend installing the windows before putting the walls together, but I had other plans. First of all, the station would be placed on a slight easement



2. The depot at Ludlow has avoided the wrecking ball.



3. Walthers Pella Depot is a readily available kit that would look at home on most eastern US layouts. Ironically, the backdrop in this photo looks more like Vermont than Iowa, which is where the actual station is located. *Credit: Wm. K. Walthers*

curve, which meant I would have to custom-build a platform to conform to the curve.

The herringbone brick pattern that's molded into the kit's platform is just too nice to discard, so I cut the base to match the curve in the track and added two rows of 0.125" x 0.156" Evergreen styrene to represent a timber edge. I test-fitted the platform to the curve before painting.

Following the kit instructions, I assembled the walls, dormer and chimneys, sprayed them with some Krylon red primer, and let them dry overnight.

Moving on to the roof, I sprayed it with a medium green color, and then brushed some individual shingles at random with Polly S Grimy Black, Pullman Green and Depot Olive. This is tedious business, but with a bit of patience this technique can really bring out the detail in the roof.

## A DEPOT SCENE | 5



4. The detailed brick platform is fitted to the curve. The base of the station helps hide a joint between the benchwork modules.

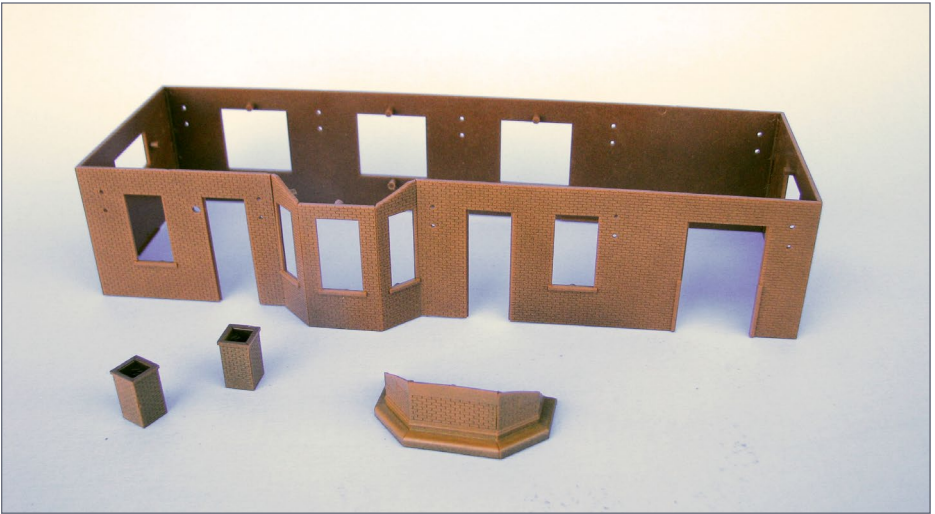

5. Brick elements ready for painting.

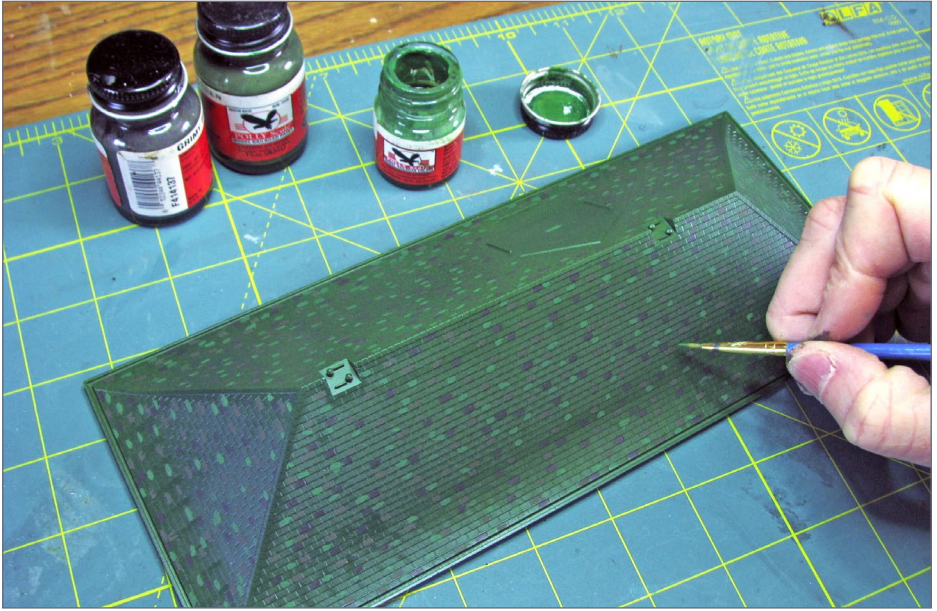

6. An hour or so of painting brings out the detail in the roofing shingles.

I like to have some music or a podcast playing in the background to make the time pass faster. Once I was satisfied with my work, I sealed it with Testors Dullcote to prepare it for weathering with Pan Pastels.

I've developed a simple technique for creating mortar in the bricks using drywall compound and India ink. I add a few drops of ink to the plaster until I have a medium- to dark-gray tone. The plaster will dry much lighter, so if you try this it might take some experimentation to come up with a shade you're happy with.

I slather this "mortar" on the walls liberally and spread it into the mortar lines with a cheap brush, working on a couple of square inches at a time.

## A DEPOT SCENE | 7



7. Drywall compound spread on the brick surfaces. Don't forget to apply it to the sides of door and window openings as well.

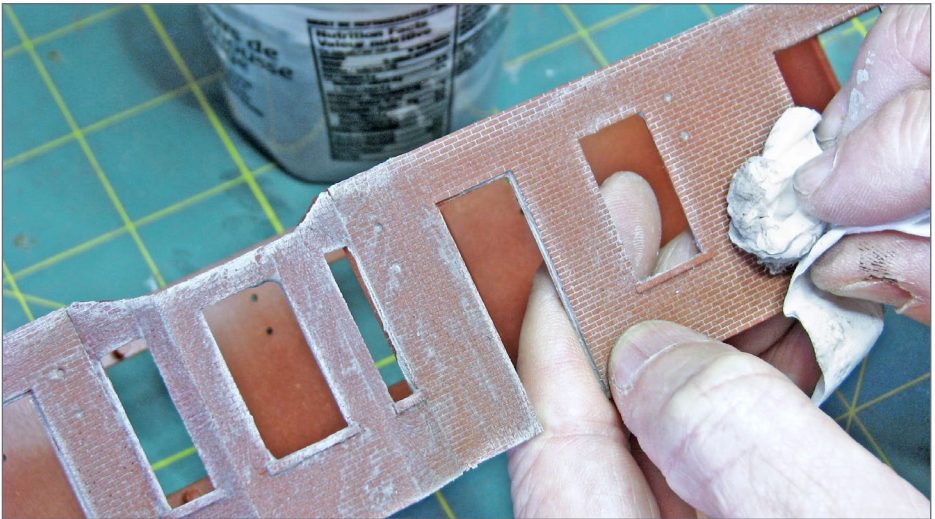

8. Even after removing most of the plaster, the effect on the walls will look overdone. There's no need to panic – the effect will come together in the next step.

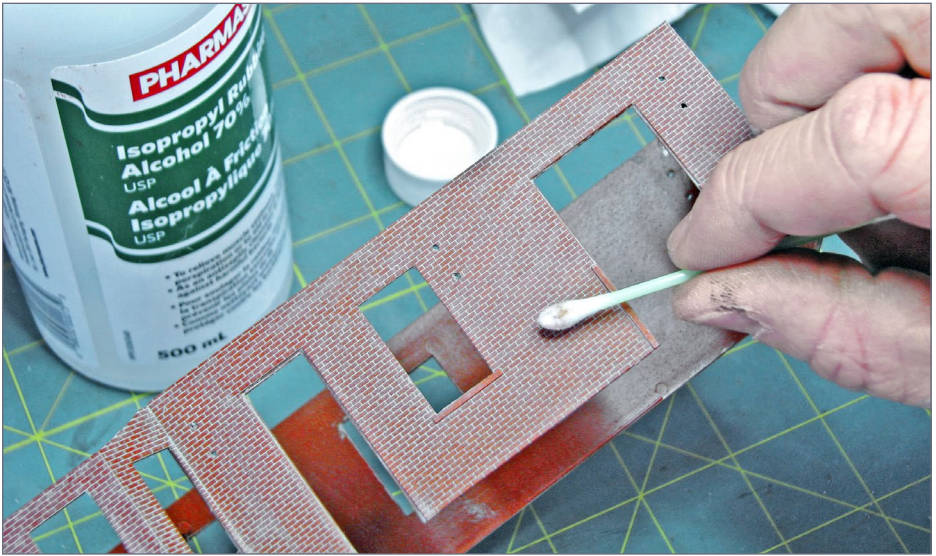

9. Remove the remaining plaster haze with a swab. Be careful not to use too much alcohol, which would wash into the mortar lines. The aim is to wipe the surface of the bricks only.

Before it has a chance to dry, I wipe as much as possible off the model using a paper towel or tissue. The mud will start to dry at this point.

I use a cotton swab slightly dampened with rubbing alcohol to remove the mud from the surface of the bricks, rotating it as I go so I'm not just spreading it around. I go through quite a few swabs on a model, so I use cheap ones I can get at a dollar store. The alcohol dries quickly, so I can see the results right away and make another pass if there's still too much haze on the brick faces. I repeated the same treatment on the platform bricks as well.

I painted the windows and trim Depot Buff and installed them in the finished walls. I then weathered the walls and roof with Pan Pastels to tone down everything and bring out the details.

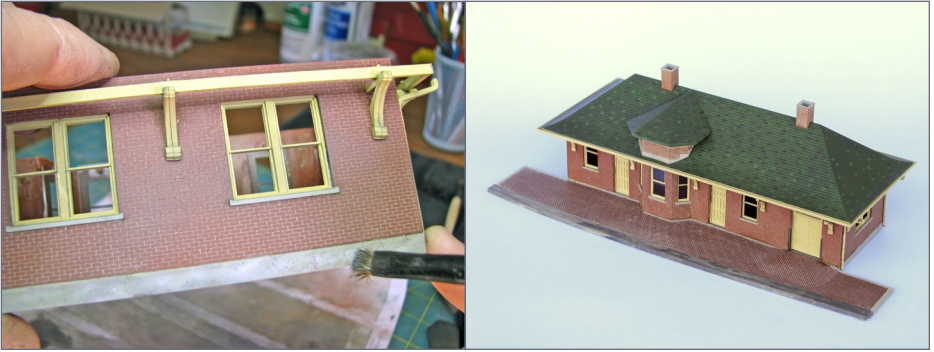

10. Pan Pastels in gray, brown, and black tones weather the walls and roof.

With the basic building assembled, the depot was ready for details. The first order of business was to board up most of the windows. If the building is to be used for storage, there's no need to have outside light. Any kind of glass in an unattended structure is nothing but a liability for a railroad. To simulate plywood, I used veneer card material, available from Lee Valley.

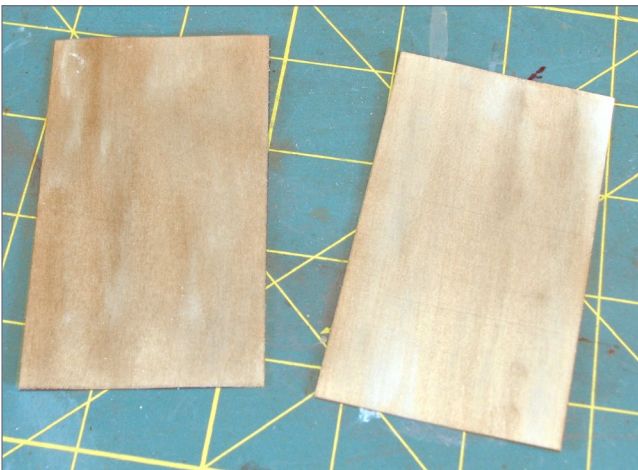

11. These veneer sheets can be used for a variety of scratchbuilding projects, and are handy for simulating plywood. Weathering with paint or stain would cause them to warp, so chalks and pastels are a better choice.



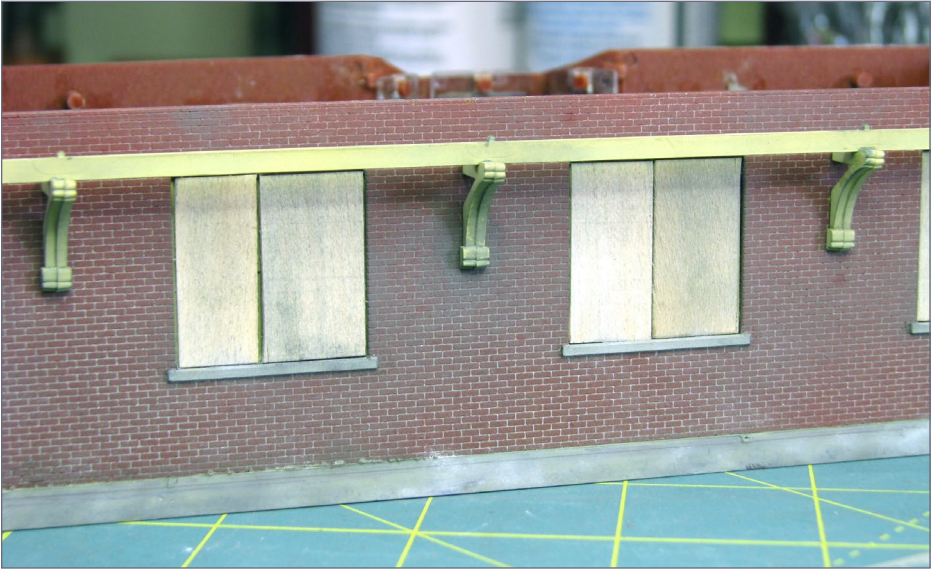

### 12. This depot is now definitely out of service.

These 2" x 3-1/2" maple sheets are typically used for creating novel gift tags or business cards, but I find them ideal for making plywood sheets in HO scale. I used a variety of Pan Pastels shades to weather them and then cut a stack of 4' x 8' HO-scale panels. These were then cut to fit the window openings and glued in place with CA adhesive.

I've noticed one trend with many older railroad buildings, like freight sheds and stations, is the addition of a vestibule on the entrance. For example, the Canadian Pacific Railway station at Woodstock, Ontario has a small breezeway at the platform door that's probably a good spot for crew members to take a quick smoke break, or stash their snow shovels and brooms.

I built my vestibule with some Evergreen Styrene .060" novelty siding with some scraps for bracing. I used 0.010" x 0.040" strips

## A DEPOT SCENE | 11

to trim the corners and placed it on a base of 0.125" x 0.125" stock. A structure about 8' x 10' seemed typical. The window and door came from my spare-parts box. I used black masking tape to simulate a tarpaper roof.

Often you'll see shuttered railroad structures with an office trailer outside for use by train crews. The Buffalo, Rochester & Pittsburgh (B&O) station at East Salamanca, New York has been out of service for more than two decades. The crews were operating out of two rooms on the main floor for some time, but now work out of a mobile office [16].



13. To add insult to injury, a local graffiti "artist" has tagged right over the sign that told him not to.

## A DEPOT SCENE | 12

Walters offers a simple kit (949-2900, Mobile Construction Office) that can be used to simulate a temporary crew office [17],  
The Vermont Railway had invested heavily in Trailer-on-Flat Car service in the late-1960s, and I wanted the scene to allude to



14. The vestibule on the station at Woodstock, Ontario. Could the driver not choose a better parking spot?

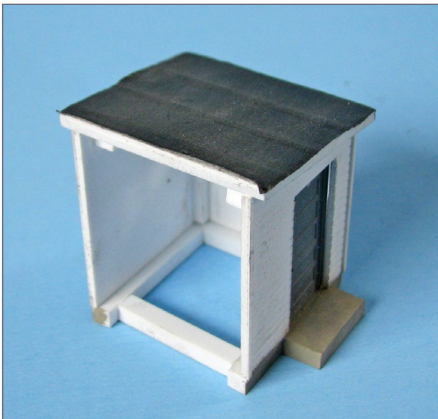

15. Vestibule assembled and ready to be installed on the building.

## A DEPOT SCENE | 13

that. Most of the examples of small town trailer ramps I could find were simple affairs that used timber frames with asphalt or concrete decks. Once I started studying them, I noticed that the remains of a concrete ramp still exist within a mile of my home near the Canadian National yards, and I had driven by it dozens of times without ever seeing it. It's amazing how modeling makes you pay attention to the world around you! There isn't much left of the facility at Belleville, Ontario, but you can still identify the coupler pocket and steel bridge plates in photo 18. I can only speculate what the two shallow pockets were for, but my best guess is there were wooden platforms parallel to the tracks, and the ends sat in these saddles.

I imagine that the TOFC ramp in my Pittsfield scene doesn't see action any more, but the siding there can be used for transloading materials from rail cars. I used 0.100" x 0.250" Evergreen



16. The substantial station facilities at East Salamanca, New York have been reduced to a spartan trailer. Still, the office here tells a story about Salamanca's role on the railroad today.

## A DEPOT SCENE | 14



17. A 20-foot container hardly seems to fit the railroad modeler's definition of a station office, but that's the intended function. *Credit: Wm. K. Walthers*



18. The concrete TOFC ramp at Belleville, Ontario will probably stand long after the trucks that it served have rusted away.

## A DEPOT SCENE | 15

styrene to make the timber sides of the ramp. Before assembly, I dragged a razor saw across the strips to create a woodgrain effect in the plastic. The posts were made from .100" x 0.100" strips, also woodgrained. Grant Line nut/bolt/washer castings were added to the posts. Plain 0.060" styrene was used for the deck. This is a simple one-evening project that can cost just a few dollars, and adds a lot of interest to a layout.

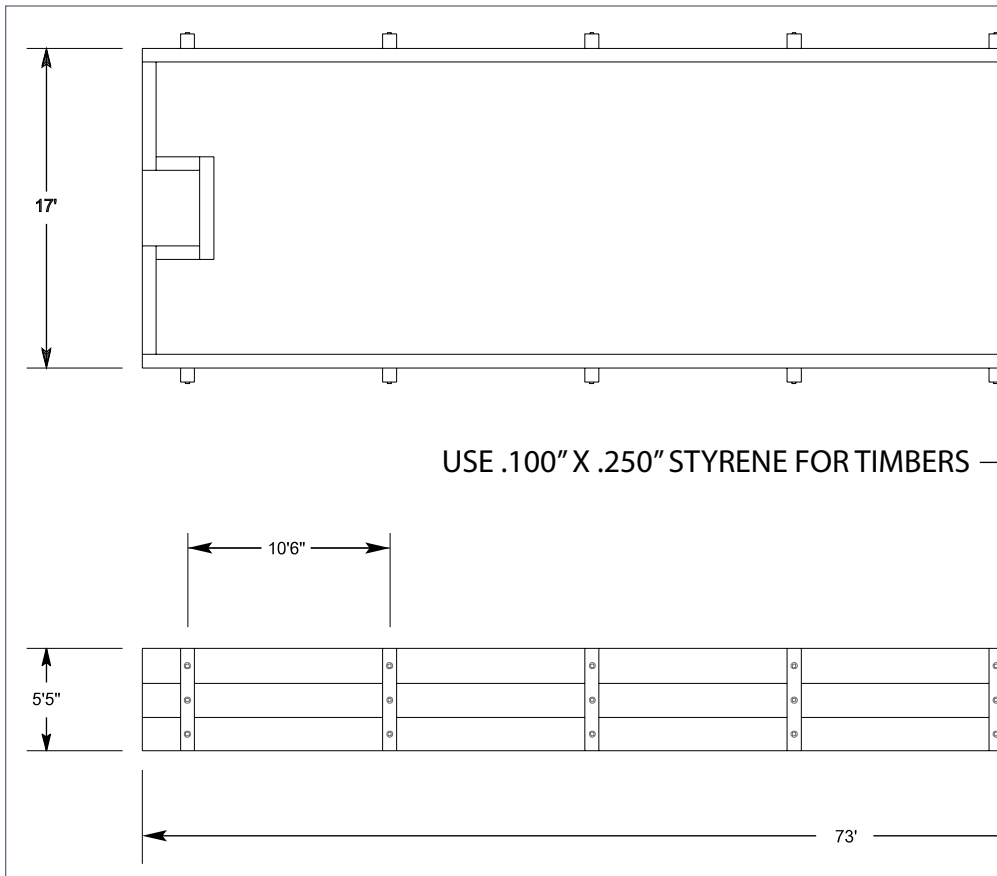

19. Here is my compressed version of a simple TOFC ramp. Remember to leave enough room at the bottom of the grade for trucks to back trailers up the ramp.

## A DEPOT SCENE | 16

Once I had assembled the parts, it seemed that the sheet styrene deck I made was too perfect, especially for a ramp that had probably been around since the days of steam. I decided to go at it with a Dremel motor tool and a cut-off disk, grinding out random potholes. I then smoothed them out with some Squadron Putty, and painted the deck with flat gray primer.

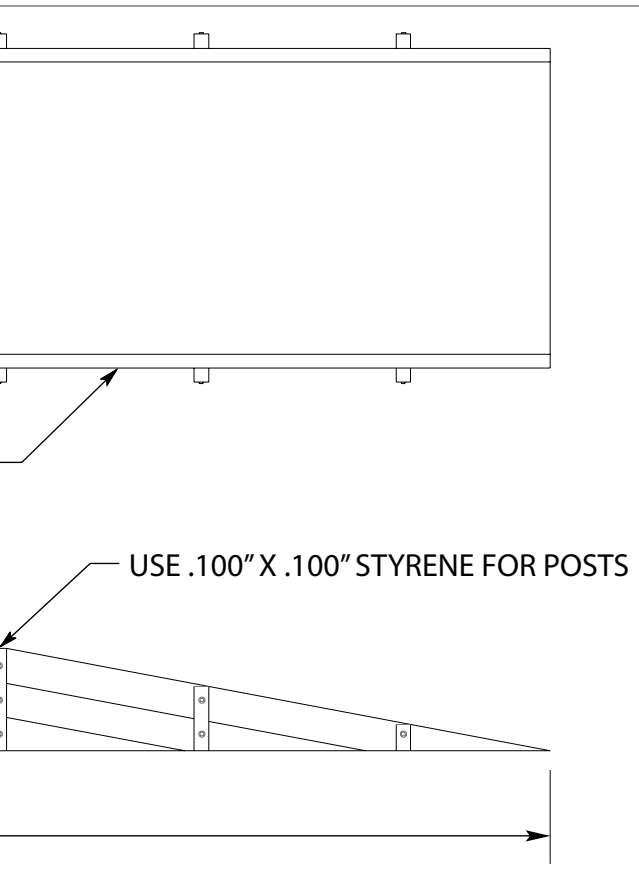

## A DEPOT SCENE | 17

I masked the deck and used Krylon camouflage brown from a spray can to color the timbers. I dusted the finished ramp with a variety of Pan Pastels.



20. Taking a grinder to your work sounds a bit extreme, but in this case it simulates the deterioration of the asphalt surface. Don't forget to wear your eye protection!



21. The finished ramp. Consider “junking it up” with details such as shipping pallets, cement blocks, oil drums, lumber scraps, and weed tufts. Photos and your imagination are your best decorating tools.



## A DEPOT SCENE | 18

With the two main structures completed, it was time to set them into the scene and decorate. Once again I turned to the prototype for ideas. When it comes to details, the CSX (B&O) depot at Meyersdale, PA has it all, including an ice machine.

Luckily there are lots of modern detail parts available to dress up a scene. Here are a few I included:



22. The depot at Meyersdale, PA provides a treasure trove of detailing ideas. Flammable materials are stored in their own fenced compound away from the building. Note the ornamental tree on the loading dock.

## A DEPOT SCENE | 19

- Dumpster bin - High Tech Details
- Johnny-on-the-spot – BLMA Models
- JCB backhoe - Herpa Models
- Fairmont push car - Grandt Line
- LP tank - Scale Scenics
- Radio tower - BLMA Models
- Light pole - Woodland Scenics
- Tufts and weeds - Bachmann and Scenic Express

Certainly building a scene like this is more interesting than just modeling a parking lot or building foundation where a busy depot once stood. It's an opportunity to tell a bit of history of a rail line that has stood the test of time. So often we hear that modeling a modern prototype railroad is less interesting than older eras. This project taught me that working in any era can be rewarding if you approach it with a bit of imagination.



23. Details installed around the building. Remember that structures need to be protected whenever moving equipment is around. Steel posts painted yellow are often seen in industrial parking lots, and rarely are they pristine. Accidents happen!

## BARRY SILVERTHORN



Barry Silverthorn is the Executive Producer of TrainMasters TV. He got his start in the hobby at age four and has built models in N, HO, S and O-scales, and has operated a model train shop.

Barry's S-scale structure kits received a National Association of S-Gaugers award for Manufacturer of the Year in 2010. He lives in a replica train depot on Canadian National's busy mainline between Toronto and Montréal.

---



[Click here to rate or comment on this article](#)



## A DEPOT SCENE | 21

Next month, I'll show off the industrial park scene on the Pittsfield Branch.



24. View of the finished station scene from the parking lot side.



[Click here to rate or comment on this article](#)





▶ ⏪ 🔊 3:51 / 5:41

CC HD 📺 🗑️

SUBSCRIBE

**CLICK HERE TO  
WATCH THE VIDEO**



▶ ⏪ 🔊 1:19 / 5:41

CC HD 📺 🗑️

SUBSCRIBE

• [INDEX](#)

• [TABLE OF CONTENTS](#)

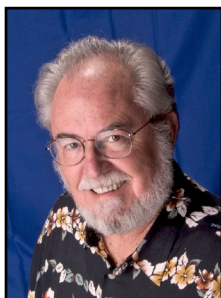

# JUNE NEWS

column

RICHARD BALE *and* JEFF SHULTZ



[Click here to rate or comment on this article](#)

**CMW Holdings**, the parent company of Classic Metal Works and Mini Metal brand HO and N scale vehicles, has entered into a five-year licensing agreement with **Round 2 LLC**, the hobby industry's major producer of vehicle kits, diecast vehicles, and slotcars. In announcing the move, CMW president Bill Giacci cited the difficulty smaller firms such as CMW have experienced in attempting to maintain control of pricing and delivery commitments from Chinese manufacturing sources. Giacci said it made sense to partner with Round 2, which has a significantly greater influence with manufacturers in China. Thomas Lowe, president and CEO of Round 2 said, "The addition of the Classic Metal Works line of model railroad inspired vehicle models and accessories was a natural for Round 2, an established producer of such familiar hobby brands as AMT, MPC, Lindberg, Hawk, Auto World, American Muscle, and Ertl Collectibles. Round 2's combined product catalog is now the most diverse in the industry,

► THE LATEST MODEL RAILROAD PRODUCTS, NEWS & EVENTS

• [INDEX](#)



SUBSCRIBE  
*(free)*

• [TABLE OF CONTENTS](#)

## JUNE NEWS | 2

with virtually every type of model kit imaginable, including diecast models, slotcars, and now model railroading inspired vehicles.” As a managing partner for CMW, Giacci will function as a product development and marketing consultant to Round 2. For more information on Round 2 products visit [round2corp.com](http://round2corp.com) ...

---

### NEW CLUB CARS



**The Nickel Plate Historical & Technical Society** is selling an HO kit for a 36-foot double-sheathed wood boxcar designated for maintenance of way service. The kit is based on an Accurail 1300 series

model with Murphy 6/6 corrugated steel ends, a metal roof, horizontal brake wheel on a vertical shaft, and National wood sliding doors. The kit is available in two road numbers. For more information visit [nkphs.org/store](http://nkphs.org/store).

---

### NEW PRODUCTS FOR ALL SCALES

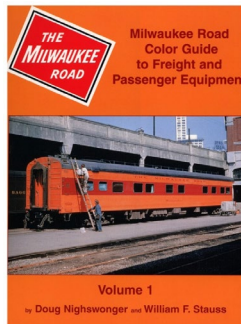
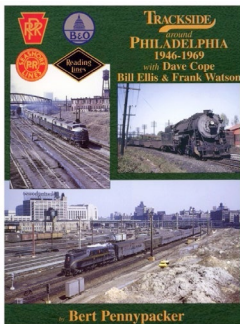

**Morning Sun** is selling a digital reprint of *Trackside Around Philadelphia 1946-1969*, edited by Bert Pennypacker. Also available now in digital format are volumes 1 and 2 of *Milwaukee Road Color*



*Guide for Freight and Passenger Equipment.* For additional information visit [morningsunbooks.com](http://morningsunbooks.com).

.....

**Model Railroad Control Systems** now has available a Dispatcher/Operator Telephone Board. The board provides all the electronics and connection points to make a dispatcher or operator's station as part of a layout communications system. The board features independent receive and transmit volume controls, supports "computer" headsets that use 1/8" (3.5mm) headset plugs as well as separate microphones and speakers, and is compatible with other communications devices. For more information go to [modelrailroadcontrolsystems.com/dispatcher-operator-telephone-board](http://modelrailroadcontrolsystems.com/dispatcher-operator-telephone-board).

.....

## O SCALE PRODUCT NEWS



**3rd Rail Division of Sunset Models** is developing an all-brass O scale model of a CB&Q class O-1a 2-8-2 Mikado steam locomotive. A freight version with a straight side tender will be produced along with a switcher version with slanted sides on the tender coal bunker as seen here.

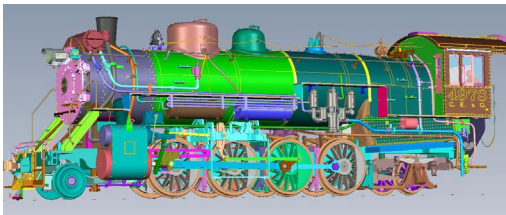

This CAD drawing gives an indication of the numerous individual brass parts that must be handcrafted for the highly-detailed model. Although not shown here,



## JUNE NEWS | 4

the model will have a fully detailed backhead with lighted instruments. Both 2-rail and 3-rail versions will be produced. For more information visit [3rdrail.com](http://3rdrail.com).

.....

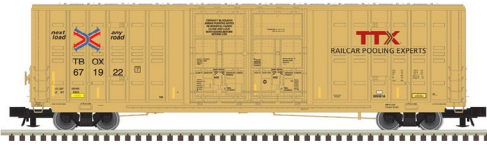

**Atlas O's** fourth quarter schedule includes the release of three new cars. First up is a 60-foot

Berwick Hy-cube boxcar. The Master series model is based on a prototype built in the late 1970s by Berwick Forge & Fabricating Corporation with waffle pattern sides and double plug doors. In addition to the TTX car shown here, road names will be BNSF, CSX, and Canadian Pacific. The 100-ton roller bearing trucks will have rotating axle caps.



Also due late this year is a 1923 ARA 40-foot steel boxcar, a popular design utilized by many roads, perhaps the most significant being the class

X-29 of the Pennsylvania Railroad. In addition to the PRR Railway Express Agency version shown, Atlas O will offer the Master series model decorated for Baltimore & Ohio, Erie, Erie-Lackawanna (MOW), Maine Central, and New York Central.



Completing Atlas O's fourth quarter release is a Trainman series steel cabooses with a center-mounted cupola. The O scale model is based on a prototype Magor Car Co. built in

1937 for the Chesapeake & Ohio. In addition to C&O, road names

## JUNE NEWS | 5

will be Chicago, Indianapolis & Louisville (Monon); Chessie System, Boston & Maine, Burlington Northern, and Virginian. An undecorated version will also be available. The ready-to-run model features interior lighting with an on-off switch mounted on the underframe. All Atlas O rolling stock is available for 2-rail or 3-rail operation. For additional information contact a dealer or visit [atlaso.com](http://atlaso.com).

.....

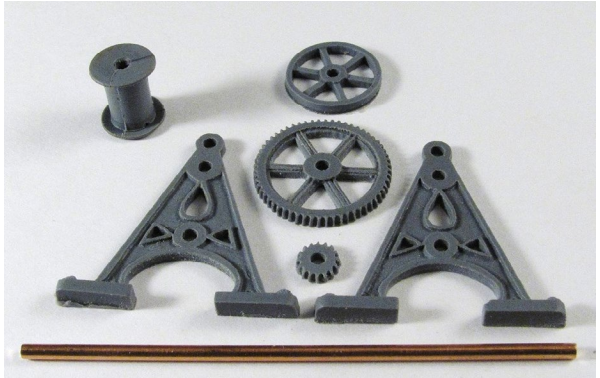

**Frenchman River Model Works** is selling an O scale kit for a float barge winch. Mechanisms of this type were used to haul boats out of the water and up onto land for repairs. Similar types of winches using chain, wire cable, or rope could be found in numerous industrial applications. Components in this nicely detailed kit include cast resin parts and copper shafting. The assembled kit has an approximate footprint of 1.025 x 650 inches by 1.025-inches high. The figure is not included in the winch kit. For more information visit [frenchmanriver.com](http://frenchmanriver.com).

.....

**Rusty Stumps Scale Models** has released a kit for an overhead I-beam hoist. The O scale model is composed of detailed 3D printed plastic components, a length of chain, bronze wire, and





a two-page instruction guide. Although listed as an O scale item, the crane could also serve as a heavy-duty S scale model. For additional information visit [rustystumps.com](http://rustystumps.com).

## HO SCALE PRODUCT NEWS



New **Accurail** HO scale kits now available include this Detroit, Toledo & Ironton triple-bay covered hopper car. The model is

based on an ACF prototype built in 1973. All Accurail kits include appropriate trucks and Accumate knuckle couplers.



Accurail has introduced a two-kit set of Norfolk & Western 40-foot single-sheathed wood boxcars. The models are patterned after a prototype that had National

wood sliding doors, wood ends, a horizontal brake wheel mounted on a vertical shaft, a fish belly steel underframe, and Bettendorf trucks.



This Grand Trunk Western covered hopper is representative of the thousands of 4750 cu. ft. triple-bay cars

## JUNE NEWS | 7

Pullman Standard built beginning in the 1970s. The Accurail kit is based on a car GTW took delivery of in 1976 and rebuilt ten years later. For additional information on all Accurail kits contact a dealer or visit [accurail.com](http://accurail.com).



**Athearn** has scheduled the release of its new GP39-2 locomotive for March 2018. Built by EMD between 1974 and 1984, the mid-horsepower diesel followed the design of most four-axle road switchers of the period. Athearn's HO scale Genesis model will offer road-specific variations in such details as nose length, grille treatments, roof fans, battery boxes, antennas, air horns, fuel tank size, and trucks. The Delaware & Hudson Phase I version seen here is an ex-Reading unit with an 81-inch nose and Blomberg-B trucks.



Athearn's Santa Fe version is a Phase II unit with the nose extended to 88 inches. It has a low EMD-type plow in front, and Blomberg-M trucks.



The release will include an MKT Phase III unit from the 1983-1988 period that has large GP50-style intakes and radiators, and Blomberg-B trucks. Additional road names in this release are

Burlington Northern (Phase IIb), BNSF (Phase IIb ex-BN), and Union Pacific Phase III.

All Genesis sound-equipped locomotives feature an onboard DCC decoder with SoundTraxx Tsunami2 sound. The sound unit will operate in both DC and DCC. DC-only models are DCC-ready with both 8- and 9- pin connectors to simplify installation of an after-market decoder.



Athearn has updated the tooling for the 60-foot arch-roof Harriman-style heavy weight passenger cars introduced decades ago by Model Die Casting. Upgrades include improved window glazing, appropriate trucks with machined metal wheelsets, and body-mounted knuckle-style couplers. The removable roof is held in position with magnets and the artwork for the lettering schemes has been vastly improved. Body types available in this release include RPO, baggage, baggage/coach combine, coach, diner, and an open-platform observation car. In addition to the Santa Fe scheme shown here, the HO scale Ready-to-Roll models will be available decorated for Baltimore & Ohio, Canadian Pacific, Denver & Rio Grande Western, New York Central, and Union Pacific.



Express boxcars suitable for high-speed service with the above mentioned passenger equipment will be available in the same passenger-style liveries. Road names will be Canadian Pacific, New York Central, Denver & Rio Grande, Union Pacific, Santa Fe, and Baltimore & Ohio. Scheduled for release in March, the

## JUNE NEWS | 9

40-foot steel cars will be fitted with double Youngstown sliding doors and high-speed passenger trucks.



Also due from Athearn in March is a group of FMC 60-foot 100-ton hi-cube exterior post boxcars with 10-foot Youngstown doors. Features of the HO scale Ready-to-Roll models include separately applied grab irons, end ladders and brake wheel; photo-etched cross-over platforms, and appropriate trucks with machined metal wheelsets. Road names will be Milwaukee Road, CP Rail, Louisville & Wadley, Western Pacific, and two different Union Pacific schemes. An undecorated version will also be offered.



Athearn's March 2018 release schedule includes bathtub gondolas with a coal load. The efficiency of using rotary dumpers and bathtub gondolas allowed railroads to haul more bulk cargo per carload than conventional open-top hoppers. The bathtub design eliminated the need for slope sheets and unloading gates, resulting in greater load carrying capacity per car. Road names will be Union Pacific, CP Rail, Oneida & Western, Procor, SRPX-Salt River Project, and UFIX-Utility Fuels. The HO scale Ready-to-Roll model features separately applied grab irons, end ladders and brake wheel; knuckle couplers, and roller bearing trucks with 36-inch machined metal wheelsets.

Intermodal equipment coming from Athearn next March includes 28-foot trailers. The models feature a landing dolly and



# JUNE NEWS | 10



rubber tires. The trailers will be sold in two-packs with two different numbers and in some cases two different decorating schemes. Trailers with different schemes will be available for McLean, Estes, Roadway Express, and Spartan. Trailers with matching schemes include Roadway (smooth side), Yellow Freight, YRC, Ringsby, owner operator, and owner operator with conspicuity stripes.



Completing Athearn's March production release is a Ford F-850 Rescue Truck featuring molded cab interior with a separate steering wheel, clear window glazing, and rubber tires. The HO scale vehicle will be available decorated for Rescue Squad (red, above).



Additional schemes include County Fire (white over red), Rescue County (all white), and FPD Rescue 14 (day-glo, above).

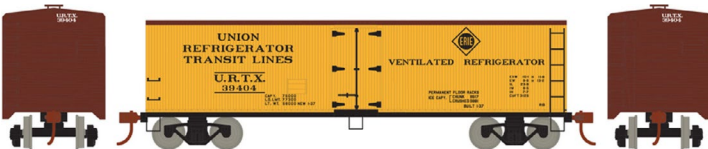

**Roundhouse** brand products scheduled for release next March include a run of 40-foot wood ice refrigerator cars. In



# JUNE NEWS | 11

addition to the URTX-Union Refrigerator with an Erie herald shown here, the ready-to-run model will be available decorated for Bangor & Aroostook, DSDX-Dairy Shippers Despatch, MKT, Nickel Plate Road, and New York Central/Michigan Central Merchants Despatch. The HO scale model comes with knuckle couplers and 50-ton Bettendorf solid-bearing trucks with 33-inch machined metal wheelsets.



A 50-foot TOFC flat car with molded-on detail will be available in March with a pair of 25-foot trailers. Road names include Conrail, Santa Fe, Burlington Northern, Chicago & North Western, and Norfolk Southern with Triple Crown trailers.

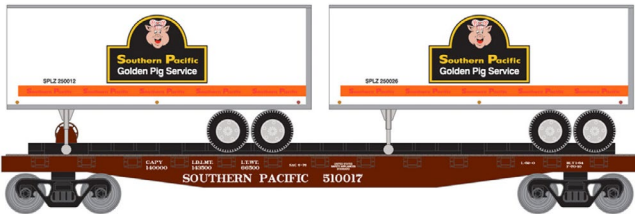

Completing the release is a Southern Pacific car with Golden Pig Service trailers. For additional information on all Athearn and Roundhouse brand products contact a dealer or visit [athearn.com](http://athearn.com).



**Atlas Model  
Railroad  
Company's 2018 first  
quarter production**



## JUNE NEWS | 12

schedule includes the release of a GP40-2(W) diesel locomotive. The Atlas HO scale version is based on a 1974-prototype Canadian National ordered with a wide four-window comfort or safety cab. The cab featured a full-width nose (W designation) that was intended to improve crew safety in the event of a collision.



In addition to two CN decorating schemes, the HO scale model will be available for Dakota, Missouri Valley &

Eastern; Iowa Northern, New England Central, Hudson Bay Railway, Georgia & Florida Railnet, MBTA-Massachusetts Bay Transportation Authority, and Vermont Railway System (shown). The models feature several road specific details. Both DC (DCC-ready with 8-pin socket for aftermarket decoder) and DCC ESU LokSound-equipped versions of the Atlas ready-to-run model will be available.



Atlas has scheduled a 2017 fourth quarter release for a 70-ton Hart ballast car. The ready-to-run model is based on an ACF-built prototype with unique

hopper doors that allowed ballast, or other lading, to be discharged to the center of the rails, to the center and the sides of the rails, or to the side of the rails only. Like the prototype, the Atlas HO version rides on 70-ton Bettendorf-style solid bearing trucks. Additional details include separately applied grab irons, uncoupling levers, train line hose, brake piping detail, interior cross-bracing, and side stiffeners. Road names will be Chicago, Burlington & Quincy; Canadian Pacific, Erie Lackawanna, Milwaukee Road, Soo Line, and Chicago & North Western.



This HO scale steel caboose with centered cupola will be available from Atlas late this year. The Trainman series ready-to-run model is based on a prototype Magor

Car Co. car built in 1937 for the Chesapeake & Ohio. In addition to C&O, road names will include New York, Ontario & Western; Amtrak, Black River & Western, Lehigh Valley, Reading, Union Pacific, Lackawanna, Pere Marquette, and B&O Chessie System. An undecorated model will also be available. All Atlas HO rolling stock comes equipped with Accumate knuckle couplers. For additional information contact a dealer or visit [atlasrr.com](http://atlasrr.com).



**Broadway Limited Imports** has scheduled a September release for a group of 2-8-0 Consolidation steam locomotives. The HO scale model will feature

BLI's Paragon3 sound and operation system with Rolling Thunder. Additional features include engineer and fireman figures, Kadee couplers, and traction tires. In addition to the painted but unlettered version shown here, the ready-to-run model will be available decorated for Bessemer & Lake Erie, Canadian National, Denver & Rio Grande Western, Frisco (St. Louis-San Francisco), Milwaukee Road, Missouri Pacific, Rock Island, Southern Pacific, and U.S. Army. For information on all Broadway Limited products contact a dealer or visit [broadway-limited.com](http://broadway-limited.com).

**Bowser** has released a GMD SD40-2 diesel decorated for the Wellsboro & Corning Railroad, a 35-mile short line that





operates between Wellsboro PA and Corning NY. WCOR is now a part of the Genesee & Wyoming

Railroad. Notable features of the HO scale locomotive include a brass bell and horn, air and MU hoses, cab interior, metal grab irons, windshield wipers, a can motor, GMD-style steps, and individually controlled classification lights. A DCC version of the HO scale model locomotive comes with an ESU LokSound Select. A DC version has a 21-pin plug to ease installation of an aftermarket decoder. Bowser recommends an ESU #53614.



Bowser is booking reservations for a January release of Alco C628, C630 and C630M Century diesel locomotives. Road names for the C628 version of the HO scale ready-to-run model include an Alco demo, Delaware & Hudson, Chicago & North Western (four schemes), and Lehigh Valley (three schemes).



The nearly identical C630 unit will be available decorated for Duluth Missabe & Iron Range (ex-Union Pacific), Reading (two schemes), and Louisville & Nashville.

Models of the Montreal-built C630-M will be available for Canadian Pacific, and two different schemes for Canadian National. Both analog DC and DCC models will be available.

# JUNE NEWS | 15

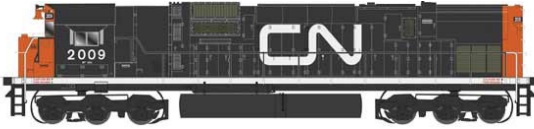

For more information on all Bowser products contact a dealer or visit [bowser-trains.com](http://bowser-trains.com).

.....



**Con-Cor** has released HO scale models of an old-time coach and coach/baggage combine car. The models represent truss-rod era

equipment with clerestory roofs, wood siding, and open end-platforms. The ready-to-run models come with seat interiors and knuckle couplers. Road names include Virginia & Truckee, Denver & Rio Grande Western, Central Pacific, Union Pacific, Santa Fe, and three different Durango & Silverton schemes.



Additional road names available now are Great Northern, Canadian Pacific, Canadian National, Baltimore & Ohio, Western & Atlantic, and two

Pennsylvania schemes. For more information contact a dealer or visit [con-cor.com](http://con-cor.com).

.....



**East Coast Railroads** has scheduled the release of a new 36-foot wood caboose to coincide with the 2017 National Train Show to be held August 4-6 in Orlando, FL.



## JUNE NEWS | 16

The ready-to-run model is based on a prototype built by Magor Car Company. The HO scale model will have separate factory-installed grab irons, knuckle couplers, and Vulcan cabooses with elliptical springs. Decorating schemes will be Norfolk Southern (road numbers 393 and 394), and Seaboard Air Line in eight road numbers. Several of the SAL cars also carry slogans or division identification prototypically correct for the caboose number. For additional information visit [east-coastrailroads.com](http://east-coastrailroads.com).

.....



### **Frenchman River Model Works**

is selling a kit for an HO scale Lobster Shack. The cast resin kit is composed of a one-piece hollow building with cast-on details and laser-cut window material. Also included are four cast lobster traps and four cast lobster boxes. The pier shown in the illustration is sold

separately. For additional information visit [frenchmanriver.com](http://frenchmanriver.com).

.....



### **InterMountain Railway**

is booking reservations for five versions of a Milwaukee Road 40-foot rib-side boxcar. Delivery is planned for

November/December of this year. IMRC's last release of this distinctive car was in the fall of 2012. The HO scale ready-to-run model features an etched-metal running board, metal wheelsets, and Kadee couplers. Lettering arrangements with new road numbers include the original 1945 Route of the Hiawathas scheme with a seven-panel Superior door (above). Three additional schemes with Youngstown doors cover prototype practice in 1958, 1959, and 1972.

# JUNE NEWS | 17



An all-new model in this release is a Milwaukee Road rib-side car specially fitted with roof hatches to handle brewery spent grain. An

orange Youngstown door readily identifies the model which follows a 1965 prototype decorating scheme. For information on all InterMountain products contact a dealer or visit [intermountain-railway.com](http://intermountain-railway.com).



**Kadee** is working on a Seaboard Air Line 50-foot PS-1 boxcar for release in September. The HO scale ready-to-run model will have distinctive 10-foot

Youngstown sliding doors and will be decorated in the SAL 1962 as-built Green Hornet paint scheme.



An October release is planned for a Kadee ACF 11,000 gallon ICC-105A insulated tank car decorated for FCX-Fuelane Corporation. The HO model will have a full loading plat-

form as built in 1947. The silver decorating scheme will include the Happy Cooking slogan. All Kadee HO scale models come with Kadee couplers and two-piece self-centering trucks. For additional information contact a dealer or visit [kadee.com](http://kadee.com).

**Northwest Short Line** is selling precision engineered steel replacement gears for Bachmann's On30 Rail Bus (next page left) and Rail Truck (next page right). The bus kit includes six gears



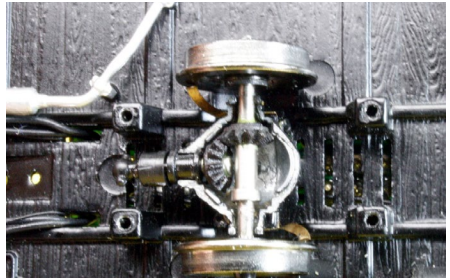
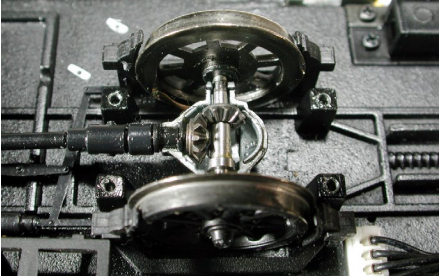

while the truck kit has three line shaft gears. Both replacement kits include step-by-step instructions and a small tube of Loctite 620, an industrial strength material to secure the steel replacement gears to the original shafts. For additional information visit [nwsl.com](http://nwsl.com).

.....



**Rapido Trains** has developed an HO scale version of a Rocky Mountaineer dome car. The ready-to-run model replicates the 10-year old 89-foot-long and 18-foot-tall prototype cars that were recently refurbished

at Ontario Northland's Remanufacturing and Repair Centre (RRC) at North Bay, ON. Details on the model include 74 dome seats, 38 dining room seats, a full galley, ADA-compliant elevator between levels, and a 9-foot extended observation platform. Sale of the model will initially be exclusively to passengers aboard the real cars. Others wanting to purchase the model should request information from Rocky Mountaineer at [rockymountaineer.com](http://rockymountaineer.com).

.....

**Resin Cars Works** is selling a limited run kit for an HO scale Insulated AC&F Type 27 Class 103/104 10,000 gallon tank car. Cast resin components are produced from new masters. The first release of this new kit series has a tank size (10,000 gallons)





generally used in the transport of asphalt. The craftsman-type kit is composed of cast resin parts, cast brass parts from Precision Scale Company, etched parts from Yarmouth Model Works, plastic details, wire, and grab

irons from Tichy Train Group. Appropriate truck side frames from Tahoe Models are also included. Road names (decals) are available for Shippers Tank Car Lines and for lessees Paluxy Asphalt, Cities Service, and United States Rubber Company. For additional information visit [resincarworks.com](http://resincarworks.com).

.....



Rusty Stumps Scale Models has released a kit for an overhead I-beam hoist. The HO scale model is composed detailed 3D printed plastic components, a length of chain, bronze wire and a six-page instruction guide. For more information visit [rustystumps.com](http://rustystumps.com).

.....

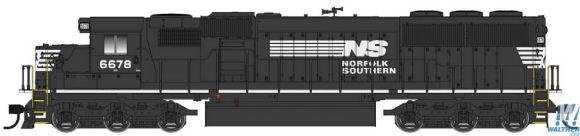

**Walthers** is scheduled to release an HO scale EMD SD60 diesel next month. The Mainline series

HO scale model will feature an upgraded drive system with newly tooled power trucks and triple axle sideframes. The body shell has also been updated with a Spartan cab and molded drill starter points for grab irons (sold separately).



Road names will be Norfolk Southern, Canadian National,



# JUNE NEWS | 20

CSX, Union Pacific, Chicago & North Western, and Soo Line. DCC models will have SoundTraxx sound. Analog DCC-ready versions will have a 9-pin plug for an aftermarket decoder.

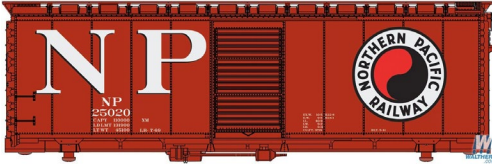

Also due from Walthers in July is a group of 40-foot AAR 1944 boxcars with an interior height of 10-foot 6-inches. Features of the HO

scale Mainline series model include 4/4 Improved Dreadnaught ends, a Murphy panel roof, a see-through Apex steel running board, and 6-foot Youngstown sliding doors. Road names will be Spokane, Portland & Seattle; Ann Arbor, Missouri Pacific (buzz saw herald with Route of the Eagles slogan), New Haven, Southern Pacific (silver Overnight scheme), and Northern Pacific.



Walthers Cornerstone has released truck and rail scales (non-operating) as used by railroads and truck lines to determine load weights. The HO scale models include two below ground track scales and two detailed truck scales. Two shacks and appropriate signs are also in the kit. For additional information on all Walthers products contact a dealer or visit [walthers.com](http://walthers.com).



**Yarmouth Model Works** is scheduled to release an HO scale cast resin kit for a Canadian Pacific 40-foot single-sheathed wood automobile boxcar this month. The craftsman-style kit covers three variations of the prototype car. Features include a one-piece cast body, and a laser-cut running board. Ladders, rungs



and additional detail parts are photo-etched. Tahoe Model Works arch bar trucks and custom decals produced by Black Cat Publishing complete the kit. Yarmouth plans to introduce the kit on June 2 at the North East

RPM in Enfield, CT. After NERPM the kit will be available for sale through the company's website at [yarmouthmodelworks.com](http://yarmouthmodelworks.com).

In other news, Yarmouth has acquired the line of resin car parts created by the Canadian Railway Model Parts Guild and previously marketed by Sylvan Scale Models. This line of parts includes NSC, Dreadnaught, and Improved Dreadnaught ends; and Hutchins and Murphy flat panel roofs. A decision on which of the components to revive is pending. For additional details visit Pierre Oliver's blog at [elgincarshops.blogspot.ca/2017](http://elgincarshops.blogspot.ca/2017).

.....

## N SCALE PRODUCT NEWS



New N scale models coming from **Athearn** next March include a 53-foot GSC TOFC flat car with

a 40-foot exterior-post trailer. The ready-to-run model features screw-mounted trucks and McHenry knuckle couplers. The TTX flat, shown here with a B&O trailer, will also be available with a PRR trailer. Additional road names will be Canadian Pacific, Erie Lackawanna, Grand Trunk Western, and Norfolk Southern.



# JUNE NEWS | 22



Additional intermodal equipment coming from Athearn next March includes a series of 28-foot trailers. The N scale models feature a landing dolly and rubber tires. The trailers will be sold in two-packs with two different numbers and in some cases two different decorating schemes. Trailers with different schemes will be available for Spartan, McLean, Estes, and Roadway Express. Trailers with matching schemes include Roadway (smooth side), Yellow Freight, YRC, Ringsby, owner operator, and owner operator with conspicuity stripes. For additional information on all Athearn products contact a dealer or visit [athearn.com](http://athearn.com).

.....



**Atlas** has scheduled another release of its popular N scale EMD GP38-2 diesel locomotive for the fourth quarter of this year. EMD's Dash 2 series, unveiled in 1972, featured significant changes such as a solid-state modular electrical control system and improved engine components designed to increase traction and reduce exhaust emissions. A reliable workhorse, the GP38-2 remains one of the most successful locomotives ever built. Most are still in service today.



The Atlas Master Silver version is sound-ready and is equipped with a speaker for easy conversion to DCC sound.

## JUNE NEWS | 23

Road names on this release will be CSX, BNSF, FNM- Ferrocarriles Nacionales de México, Indiana Harbor Belt, Norfolk Portsmouth Belt Line, Norfolk Southern, Wisconsin & Southern, Boston & Maine, and Rock Island.



FMC's Plate B IPD (Incentive Per Diem) 5077 cu. ft. boxcar was designed as a universal car that would be interchangeable on most common railroad clearances. The basic

design includes non-terminating box corrugated ends, exterior posts, and a Stanray X-panel roof. Many of the 4,300 cars FMC built had end-of-car cushioning. Atlas's new N scale version will be available late this year decorated for Green Mountain, Hartford & Slocumb; Clarendon & Pittsford, CSX (Ease Up slogan), CSX (safety stripes), Providence & Worcester, Sabina River & Northern, Sierra Railroad, Vermont Railway, Vermont Northern, Railbox, and Burlington Northern.



Atlas has scheduled a 2017 fourth quarter release for a 70-ton Hart ballast car. The ready-to-run model is based on an ACF-built prototype with unique hopper doors that

allowed ballast, or other lading, to be discharged to the center of the rails, to the center and the sides of the rails, or to the side of the rails only. Like the prototype, Atlas' N scale version rides on 70-ton Bettendorf-style solid bearing trucks. The model is detailed with interior cross-bracing, and side stiffeners. Road names will be Chicago, Burlington & Quincy; Canadian Pacific, Erie Lackawanna, Milwaukee Road, Soo Line, and Chicago & North Western.



# JUNE NEWS | 24

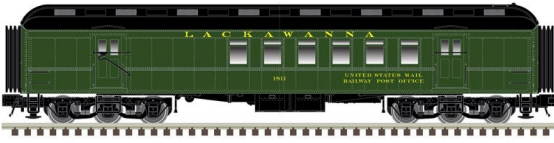

Atlas is working on a group of 60-foot N scale passenger cars for release during the first quarter of 2018. Car types include baggage, RPO, baggage/coach combine, coach, and open observation.



The ready-to-run N scale models will have clear window glazing, individual roof vents, diaphragms, and interior details (except the baggage car).



Each body type will be available painted green with a black roof but unlettered. Fully decorated cars will be available for Lackawanna, Chicago & North Western, Chesapeake & Ohio, New Haven, and Santa Fe.

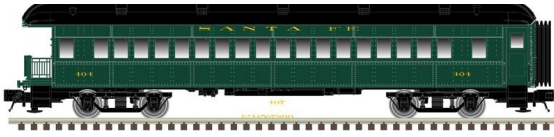

All Atlas N scale rolling stock comes equipped with Accumate knuckle couplers. For additional information contact a dealer or visit [atlasrr.com](http://atlasrr.com).

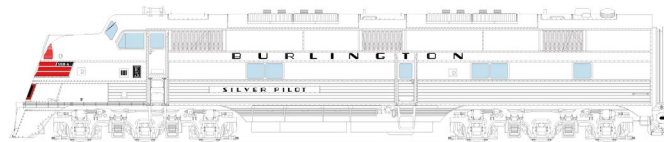

**Kato USA** has announced the August re-release of the 2010 California Zephyr 11 car set and a brand new CB&Q E5A locomotive in two “Red Band” paint schemes, both the CB&Q in its '60s appearance as well as #9911A when it was acquired by the

# JUNE NEWS | 25

Illinois Railway Museum. For more information visit a dealer or [katousa.com](http://katousa.com).

---



**Micro-Trains Line** has released several new N scale models including this 70-foot Husky-Stack well-car decorated for CRLE-Coe Rail Leasing. The car can handle containers up to 48 feet long in the well.



Also new from Micro-Trains is this Santa Fe 50-foot boxcar. The prototype had its running board removed but retained its full length ladders in a 1974 rebuild.



Micro-Trains is selling an 89-foot enclosed tri-level Autorack decorated for Norfolk Southern.



This N scale Pittsburgh & Lake Erie 100-ton triple-bay open hopper is available now from Micro-Trains. The ready-to-run model comes with a

removable coal load. For additional information on all Micro-Trains Line products contact a dealer or visit [micro-trains.com](http://micro-trains.com).

---

**ScaleTrains.com** has scheduled a November release date for a Thrall triple-bay 5750 cu. ft. carbon black covered hopper. Unlike traditional c-hops in which the end slope sheets are clearly visible, this Trinity design has fully enclosed ends. Additional spotting





features are the ten side posts, triple butterfly-type outlet gates, a unique roofline, and multiple 16-inch round roof hatches. The running boards and end platforms on this N scale

Rivet Counter series model are photo-etched stainless steel. The ready-to-run model comes with body-mounted type E couplers, and ASF Gould 70-ton Ride Control trucks with 33-inch machined metal wheelsets. It will be available in four road numbers each for Cabot-CABX, Sid Richardson-SRCX, Witco-WITX, and Columbian Chemicals-CCX.



A more traditional appearing covered hopper with a rated capacity of 4725 cu. ft. is also scheduled for release this November. Designated for carbon black service,

the triple-bay Rivet Counter series model has visible slope sheets. Other features include butterfly outlets, multiple round loading hatches, and sampling spigots set into the side of the car. Like the prototype, the N scale ready-to-run model rides on Barber S-2 70-ton trucks with 33-inch machined metal wheels. Road names will be Columbian Chemicals-CCX, Degussa-DCBX, Orion-EQCX, and Sid Richardson-SRCX. For additional information on all ScaleTrains.com products visit [scaletrains.com](http://scaletrains.com).



## NEW DECALS, SIGNS AND FINISHING PRODUCTS

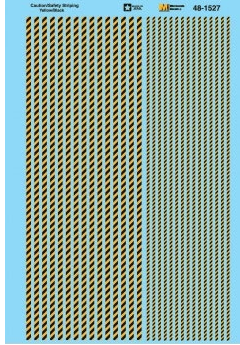
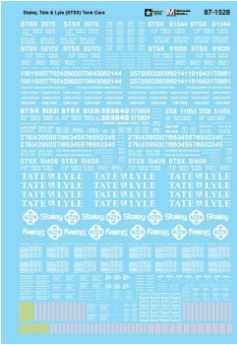

**Microscale** has HO and N scale water-slide decals for Staley, Tate & Lyle (STLX) tank cars. Also released this month are HO and O scale decals for caution and safety floor striping. For information on all Microscale products con-

tact a dealer or visit [microscale.com](http://microscale.com).



## SEND US YOUR PRODUCT ANNOUNCEMENTS

If you are a hobby manufacturer with a product announcement, just [click here](#) and submit your announcement to us. Our web site and free magazine reach continues to grow, so get on board this new media train! ■

### DISCLAIMER .....

The opinions expressed in this column are those of the writer and do not necessarily reflect the opinion of *Model Railroad Hobbyist* or its sponsors. Every effort is made to provide our readers with accurate and responsible news and information, however, neither *Model Railroad Hobbyist* or the writer of this column can be held responsible for any inaccuracies or typographical errors that may inadvertently appear in this column.





## BRIEFLY NOTED AT PRESS TIME ...

**Atlas O** has begun shipping replacement Santa Fe F7 A and B body shells to customers who purchased models in the initial 2016 release. Atlas agreed to replace the original shells after problems were discovered in the paint and general decoration of the initial release. An Atlas O official said models of other road names from the 2016 release with similar problems are also being corrected and will soon be ready to ship. Corrected models can be viewed at [youtube.com/watch?v=hvJUl7zHrI&feature=youtu.be&utm\\_source=Atlas+Insiders+E-News+Flash&utm\\_campaign=f5456b43eb-EMAIL\\_CAMPAGN\\_2017\\_05\\_12&utm\\_medium=email&utm\\_term=0\\_9f9fd5b26c-f5456b43eb-80763677](https://www.youtube.com/watch?v=hvJUl7zHrI&feature=youtu.be&utm_source=Atlas+Insiders+E-News+Flash&utm_campaign=f5456b43eb-EMAIL_CAMPAGN_2017_05_12&utm_medium=email&utm_term=0_9f9fd5b26c-f5456b43eb-80763677).

**KatoUSA** has added Burlington Northern Bicentennial locomotive #1876 to its select group of EMD SD40-2 Kobo custom decorated models. The diesel unit is detailed with prototypical horn placement and beacon as well as the distinctive Sitting Bull and General Custer signboards on each side. As with all Kobo custom models this is available in limited quantities only. For additional information go to [katousa.com/Zcart/index.php?main\\_page=product\\_info&cPath=157&products\\_id=1813](http://katousa.com/Zcart/index.php?main_page=product_info&cPath=157&products_id=1813).

**Mount Vernon Shops** has released a new set of HO scale decals for a Conrail two-axle scale test cars. Sufficient material is provided to letter two cars and covers all schemes from 1976 through to present day. For additional information go to [mountvernonthops.com](http://mountvernonthops.com).

The next HO scale famous name train from **Walthers** will be the George Washington as operated by the Chesapeake &

Ohio Railroad between Washington D.C and Cincinnati, OH. Individual cars decorated in the post-1954 paint scheme include two 70-foot heavyweights head end cars: an RPO/ baggage combine and an arched roof baggage car. Three lightweight 85-foot Pullman-Standard cars include a 52-seat coach, a 10-6 sleeper, and a dormitory/diner. The P-S cars have fluted sides and will be available with and without skirts. The cars will be available next January in deluxe 7-car sets with factory printed names and numbers, LED interior lighting, and Preiser passengers and crew installed throughout the train. Individual models without passengers or lights are scheduled for release in February. A decal set with appropriate names and numbers will be included with each car. Motive power will be provided by authentically decorated Proto EMD E8A and E8A-A diesel units in a choice of either DC or DCC with LokSound. For more information visit [walthers.com](http://walthers.com).

.....



**Click here to rate or  
comment on this article**





# SELECTED EVENTS

## June 2017

*(Please note that many events charge a fee. Check individual info website for details.)*

**ALABAMA, BIRMINGHAM**, June 9-10, NMRA Southeastern Region Convention & Model Train Show, at Bessemer Civic Center, 113 9th Avenue SW. Info at [2017serconvention.com](http://2017serconvention.com).

**AUSTRALIA, TOOWOMBA, QUEENSLAND**, June 3-4, 4AK/4WK Toowoomba Model Trains, Craft, & Hobby Expo, Founders Pavilion, Toowoomba Showgrounds, Clive Berghofer Events Centre, Glenvale Rd. Info at [ddmrc.com.au](http://ddmrc.com.au).

**CALIFORNIA, FREMONT**, June 10-12, 6th annual Open House at Tri-City Society of Model Engineers, Niles Plaza Depot & Freight Building, 37592 Niles Blvd. Info at [nilesdepot.org/niles/modelrailroads.html](http://nilesdepot.org/niles/modelrailroads.html).

**CALIFORNIA, RICHMOND**, June 17, Bay Area Prototype Modelers Meet, at St. David's School Hall, 871 Sonoma Street. Info at [bayareaprototypemodelers.org](http://bayareaprototypemodelers.org).

**COLORADO, DURANGO**, June 8-11, NMRA Rocky Mountain Region Convention, at Durango Double Tree by Hilton Hotel. Info at [rnr-nmra.org/RMRConvention2017/AnimasRails.html](http://rnr-nmra.org/RMRConvention2017/AnimasRails.html).

**CONNECTICUT, ENFIELD**, June 2-3, Northeast Proto Meet, at Holiday Inn Springfield South, 1 Bright Meadow Boulevard. Info at [nerpm.org/index.html](http://nerpm.org/index.html).

## SELECTED EVENTS | 2

**CONNECTICUT, ENFIELD**, June 22-25, National O Scale Convention, at Holiday Inn Springfield South, 1 Bright Meadow Boulevard. Info at [snemrr.org/index.html](http://snemrr.org/index.html).

**FLORIDA, TALLAHASSEE**, June 24, 26th Annual Tallahassee Model Railroad Show & Sale, at North Florida Fairgrounds, 441 Paul Russell Road. Info at [bbmra.org/show.html](http://bbmra.org/show.html).

**ILLINOIS, COLLINSVILLE (St Louis area)**, June 23-24, St. Louis Prototype Modelers Meet, hosted by Lonnie Bathurst and John Golden, at Gateway Convention Center. Details at [icg.home.mindspring.com/rpm/stlrpm.htm](http://icg.home.mindspring.com/rpm/stlrpm.htm).

**KANSAS, HUTCHINSON**, June 3-4, Model Railroad Expo, sponsored by Kansas Central Model Railroaders, at State Fairgrounds, Sunflower North Building. Info at [kansascentral-modelrailroaders.org/train-show.html](http://kansascentral-modelrailroaders.org/train-show.html).

**KANSAS, LENEXA (Kansas City metro area)**, June 24, Kansas City Area Narrow Gaugers (KCNG), 14th Annual Meet, at Johnson County Library, Lackman Branch, 15345 West 87th Street Pkwy. PDF flyer at [tc-nmra.org/KCNG.pdf](http://tc-nmra.org/KCNG.pdf). Request info from Larry Alfred at [captlalfred@gmail.com](mailto:captlalfred@gmail.com).

**MARYLAND, TIMONIUM**, June 17-18, Great Scale Model Train Show, Maryland State Fair, 2200 York Road. Info at [gsmts.com](http://gsmts.com).

**NORTH CAROLINA, DENVER**, June 9-11, Modular Layout Display by the Sipping and Switching Society of North Carolina, Salem United Methodist Church, 378 N. Pilot Knob Rd. Information at [facebook.com/events/119917138534262](https://facebook.com/events/119917138534262).

**OHIO, DAYTON**, June 24-25, 12th Annual Rail Festival, sponsored by Carillon Park Rail & Steam Society, at Carillon Park. Info at [railfestival.com](http://railfestival.com).



## SELECTED EVENTS | 3

**OKLAHOMA, TULSA**, June 21-25, Annual Convention of the Santa Fe Railway Historical & Modeling Society. Info at [sfrhms.org/conventions](http://sfrhms.org/conventions).

**PENNSYLVANIA, PITTSBURGH**, June 21-25, National N Scale Convention, at Sheraton Pittsburgh, 300 West Station Square Drive. Info at [nationalnscaleconvention.com](http://nationalnscaleconvention.com).

**TEXAS, HOUSTON**, June 7-11, NMRA Lone Star Region 2017 Convention, at Hilton Westchase, 9999 Westheimer Road. Info at [bayoucitylimited.org](http://bayoucitylimited.org).

**WASHINGTON, SPOKANE**, June 7-10, NMRA, Pacific Northwest Region “Spokane Falls Express” 2017 Convention, at Hotel RL by Red Lion, West 303 North River Drive. Info at [pnr5d.org/index\\_spokanefallsexpress2017.htm](http://pnr5d.org/index_spokanefallsexpress2017.htm).

### July 2017, by location

**CALIFORNIA, POMONA**, July 8-9, The Great Train Show, at Fairplex, 1101 West McKinley Avenue. Info at [trainshow.com/pomona](http://trainshow.com/pomona).

**FLORIDA, ORLANDO**, July 30-Aug 5, NMRA National Convention, Rosen Plaza Hotel, 9700 International Drive. Info at [nmra2017.org](http://nmra2017.org).

**ILLINOIS, BELLEVILLE**, July 22-23, The Great Train Show, at Belle-Clair Fairgrounds & Expo Center, 200 South Belt E. Info at [trainshow.com/belleville](http://trainshow.com/belleville).

**NEBRASKA, DESHLER**, July 1-2, Train Show & Open House at Spring Creek Trains, at 4th and Race Street. Info at [springcreek-modeltrains.com](http://springcreek-modeltrains.com).

**OKLAHOMA, TULSA**, July 10-15, National Garden Railway Convention, at Renaissance Hotel & Convention Center, 6808 South 107th Avenue. Info at [thinktulsa17.com](http://thinktulsa17.com).

## Future 2017, by location

**AUSTRALIA, SOUTH ADELAIDE, OLD REYNELLA,** September 7-10, 15th National N Scale Convention, at St. Francis Winery Function Centre, 14 Bridge Street. Info at [convention2017.nscale.org.au](http://convention2017.nscale.org.au).

**COLORADO, DENVER,** August 30-September 2, National Narrow Gauge Convention, at Marriott Denver Tech Center Hotel. Info at [37nngc.com](http://37nngc.com).

**FLORIDA, ORLANDO,** August 4-6, National Train Show, at Orange County Convention Center, 9800 International Drive, 276 West Center Street. Info at [nationaltrainshow.org](http://nationaltrainshow.org).

**ILLINOIS, LISLE,** October 26-28, Chicagoland RPM (formerly known as Naperville RPM), at Sheraton Hotel and Conference Center. Event hosted by Mike Skibbe and co-sponsored by NMRA. Info at [rpmconference.com](http://rpmconference.com).

**MICHIGAN, EAST LANSING,** November 5, Lansing Model Railroad Club Show & Sale, at Michigan State University Pavilion, 4301 Farm Lane. Info at [lmre.org](http://lmre.org).

**OHIO, MARION,** August 12, Summerail 2017, at Marion Palace Theater. Info at [summerail.com](http://summerail.com).

**PENNSYLVANIA, ALTOONA,** August 19-20, 13th Annual N-Scale Weekend, at Jaffa Shrine Center, Broad Avenue & 22nd Street. Info at [n-scaleweekend.com](http://n-scaleweekend.com).

**VIRGINIA, VIRGINIA BEACH,** September 30-October 1, 28th Annual Train Show & Sale, sponsored by Tidewater Division Model Railroaders, at Virginia Beach Convention Center, 1000 19th Street. Info at [nmra-mer-tidewater.org](http://nmra-mer-tidewater.org).



## 2018 and beyond, by location

**MISSOURI, KANSAS CITY**, August 5-12, 2018, NMRA National Convention. Info at [kc2018.org](http://kc2018.org).

**UTAH, SALT LAKE CITY**, July 7-13, 2019, NMRA National Convention. Info at [nmra2019slc.org](http://nmra2019slc.org). ■



**Click here to rate or comment on this article**

Layout tours – Trackwork – Structures – News – Tr  
Plann  
– Humor – Contrarian Opinions – News  
DCC  
Ballast – Multi-deck designs – Small layouts  
ering – First looks – Rolling stock – Signa  
guidelines – Clickable ads links – Video – Operatio  
Prototype modeling – Lighting – MRH forum – Int  
active reader feedback – Questions Answers and  
– Upcoming events  
signs – M  
Scenery  
tuning – The Tool Shed – Layout owner interview

# Model Railroad Hobbyist magazine™

**YES, subscribing MATTERS!**  
**(even though it's free)**

**It helps MRH get more  
advertisers**

**Click here to subscribe!**



## AMERICA'S LARGEST OPERATING MODEL RAILROAD SHOW

## 4 FOOTBALL FIELDS OF SERIOUS TRAIN ENTHUSIAST FUN

## TRAIN FUN FOR EVERY GAUGE OF RAILFAN

- 70 Detailed Operating Railroads
- 56 "How to" Clinics
- 75 Demos
- 60 Manufacturers – All the Majors & Cottage Industries too
- 50 Hobby Dealers
- 12 Train Historical Societies
- NEW "All Rail" Photo Contest

## MODELER'S DELIGHT

EXPERT MODELERS HOST 56 **FREE** CLINICS

A wide range of clinic topics will challenge every modeler skill level. Clinics are free with admission and held daily during Trainfest. Space is limited; register today at [trainfest.com](http://trainfest.com).

## NEW PRODUCTS UNVEILED

If a manufacturer is making a new product, they announce it at Trainfest – the nation's premiere train show. Make sure to visit all the manufacturers to see this year's new and exciting products and skills.

*New!*  
**1/2-PRICE  
TICKETS**  
NOW THROUGH 7/30/17  
AT [TRAINFEST.COM](http://TRAINFEST.COM)  
USE PROMO CODE  
**mrh2017**



# Trainfest

SATURDAY & SUNDAY · NOV. 11 - 12, 2017

9AM - 5PM · MILWAUKEE · WI STATE FAIR PARK

**RUN THE  
TRAINS  
ON MOST  
LAYOUTS!**

**Trainfest**  
America's Largest Operating Model Railroad Show

**GREAT FAMILY EVENT OF HUGE OPERATING RAILROADS, PLUS...**

- Kid-Friendly Activities
- Kids-Only Make 'n Take
- Clinics & Demos to Get Started in Modeling
- Become a Jr. Engineer
- Ride the MLES Train on 600 ft. of track

**CELEBRATE THE SOO LINE**

Trainfest is partnering with the Soo Line Historical Assn. to celebrate the Soo Line. We've created a spectacular 32-panel display on the railroad. Manufacturers will have Soo Line merchandise and layouts will be running the Soo. A limited-edition Soo Rolling Stock Freight Car is offered through [trainfest.com](http://trainfest.com). Reserve yours today to pick up at Trainfest.



Sponsored by the  
WISE Div of the  
National Model  
Railroad Association

**SHOW DETAILS, DISCOUNT TICKETS & LODGING DEALS AT [TRAINFEST.COM](http://TRAINFEST.COM)**

• INDEX



SUBSCRIBE  
(free)

• TABLE OF CONTENTS

# Clickable advertiser index – 1

[Accu-Lites](#)

[American Ltd \(San Juan\)](#)

[ANE Models](#)

[Archer Fine Transfers](#)

[Athearn](#)

[Atlas Model Railroad Co.](#)

[Bachmann](#)

[Bachrus](#)

[Backdrop Junction](#)

[Banta Modelworks](#)

[Berrett Hill Trains](#)

[Black Cat Publishing](#)

[Blair Line](#)

[Bowser](#)

[Canyon Creek Scenics](#)

[Clever Models](#)

[Coastmans Scenic Products](#)

[Coffman Graphics](#)

[Crow River Products](#)

[Digitrax \(2 page spread\)](#)

[ESU LokSound](#)

[Fast Tracks](#)

[Fine Scale Miniatures](#)

[Fox Valley Models](#)

[Good Deals DCC](#)

[Great Decals](#)

[HO Diesel Supply](#)

[Iowa Scaled Engineering](#)

[ITLA Scale Models](#)

[Ken Patterson.com](#)

[Lights 4 Models](#)

[Litchfield Station](#)

[Logic Rail Technologies](#)

[Main Street Heritage Models](#)

[Model Railroad Benchwork \(1\)](#)

[Model Railroad Benchwork \(2\)](#)

[Monster Modelworks](#)

[Motrak Models](#)

[Model Railroad Control Systems](#)

[Mountain Subdivision Hobbies](#)

[MRH Store \(1\)](#)

[MRH Store \(2\)](#)

[MRH Store \(3\)](#)

[MRH Store \(4\)](#)

[Mt Albert Scale Lumber](#)

[National NG Convention](#)

[National Train Show](#)

[NCE \(2 page spread\)](#)

[Nick & Nora Design](#)

[Norfolk & Western Hist. Society](#)

[North American Railcar Co.](#)

[Pre-Size Model Specialities](#)

[Precision Design Co.](#)

[Rapido \(1\)](#)

[Rapido \(2\)](#)

[Ring Engineering \(1\)](#)

[Ring Engineering \(2\)](#)

[Rulers-of-the-World](#)

[Scale Trains](#)

[Scotty Mason Show](#)

[Sea Port Model Works](#)

[Select Model Railroads](#)

[Streamlined Backshop Services](#)

[Soundtraxx \(Blackstone\)](#)

# Clickable advertiser index – 2

[Southern Digital](#)

[TAM Industries](#)

[TAM Valley Depot](#)

[The DCC Shop](#)

[Tony's Train Exchange](#)

[Train Control Systems](#)

[Trainfest](#)

[TrainMasters TV \(1\)](#)

[TrainMasters TV \(2\)](#)

[TrainMasters TV \(3\)](#)

[TSG Multimedia](#)

[Walters](#)

[Westerfield Models](#)

[Yankee Dabbler](#)

[Yarmouth Model Works](#)

# Clickable "other" index

---

[Other – Contents](#)

[Other – Cover](#)

[Other – Derailments](#)

[Other – Hobby Marketplace](#)

[Other – MRH Sponsors](#)

[Other – Yes it's a model](#)

## DOWNLOAD ISSUE



DOWNLOAD PORTRAIT



DOWNLOAD LANDSCAPE

• INDEX



SUBSCRIBE  
(free)

• TABLE OF CONTENTS



# REVERSE RUNNING

commentary

DON HANLEY  
.....



[Click here for reader comments](#)

## MODEL RAILROADING, R.I.P.

**IN LAST MONTH'S COLUMN,** Publisher Joe Fugate claimed the hobby is really not dying, providing anecdotal evidence. This month, I am taking the reverse view: the hobby is dying a slow agonizing death.



My evidence includes:

- Hobby stores are becoming more scarce every day
- The cost of the hobby is skyrocketing
- Model trains fit our instant gratification society less and less
- Hobby publications have declining readership and content
- Many in the hobby are sure it's on the way out

The first is obvious. Hobby stores keep shutting their doors as owners retire or cannot make a profit any longer. Since the banks may feel brick and mortar retail is on a downhill slide, they have little or no desire to make loans to would-be hobby shop buyers.

▶ **STEPPING OUTSIDE THE BOX WITH A CONTRARY VIEW**

The cost of the hobby is well north of many hobbyists' income and way above what most young people can afford. Today's young people generally have a tough decision to make: what is more important? The latest iPhone 7plus, a Galaxy S8, or some model railroad equipment for a layout?

It's generally more important that they impress their friends with the latest and greatest technology. And let's be honest with ourselves, a lot of model railroading is old technology: most DCC system designs are well over 20 years old now.

As for instant gratification: observe people in a restaurant. Look around and you will see many interacting with their devices rather than engaging in conversation with each other. Come to think of it, have you been in the typical model railroader's layout room? They prefer to interact with their devices (the trains) rather than engage in conversation with others in the room, too!

And we are all generally aware of the struggles the hobby publications have been going through with their declining readership since the 1990s. Several magazines didn't make it and are no more: *Railmodel Journal*, *Mainline Modeler*, and *Model Railroading Magazine*. But at least the environmentalists should be happy, that's a few more trees per decade saved.

Finally, many old timers in the hobby insist it's dying. There is a philosophical belief that the more you speak of something, the more likely it is to happen. Since there is a large segment within the hobby that seem to believe and keep saying the hobby is dying, that may be enough to make it happen.

Yes, it's sad to see our old friend, the model railroading hobby, slowly withering away. But like an aging old friend, you can still enjoy their company. I for one intend to enjoy the hobby as long as I can.

P.S. To those of you who seriously believe the hobby is dying, can you refrain from saying it quite so often? I'd like it to be around for at least as long as I am! ☑





# DERAILMENTS

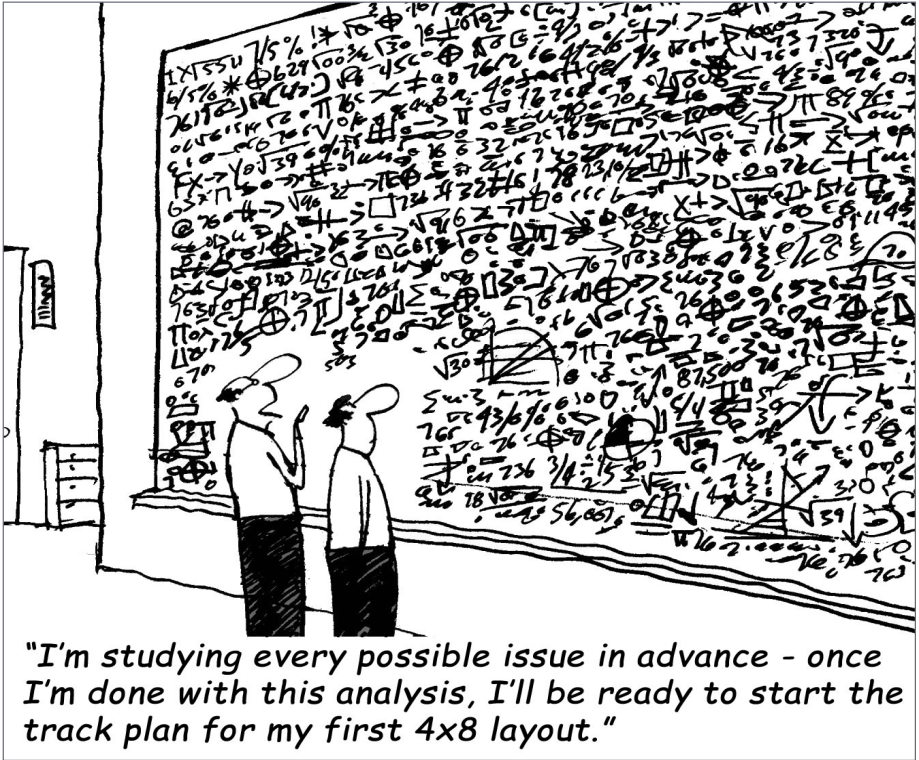

Jerry King

## THOMAS THE TANK FUN

**Q:** What do you get when you cross a Thomas Train and Shakespeare?

**A:** Toby or not toby, that is the question!

► BIZARRE FACTS AND HUMOR (SUPPOSEDLY)

# OFF THE RAILS ...

Railroad problem reports and the response by the shop crew:

**Report:** Dead bugs on windshield.

**Solution:** Live bugs on order.

**Report:** Setting loco brake causes throttle lever to stick.

**Solution:** That's what it's there for.

**Report:** Locomotive handles funny.

**Solution:** Locomotive given verbal warning to be serious. ■

## 💰 GET PAID ...

If you're the first to submit a bit of good humor or bizarre facts and we use it, it's worth \$25! Just send to [derailments@mrhmag.com](mailto:derailments@mrhmag.com) ■

## Coming next issue ...

- Bill Brillinger examines potash car operations
- Adding sound in N scale
- One Module Challenge Second Place layout design
- Another TOMA layout structure project by Barry Silverthorn
- And lots, *lots* more!



**Click here to rate or comment on this article**



• INDEX



SUBSCRIBE  
(free)

• TABLE OF CONTENTS