

HAVING FUN WITH TRAINS

MAY 2017 | FREE

MRH

MODEL RAILROAD HOBBYIST

ALSO:

- Free universal modeling sizes chart
- Small town scene modeling
- Battery-powered DCC, part 3
- Modeling CP Rail 5406
- Shay-powered prototype coal line

... and lots more inside!

Jerry Fassnacht's Proto-freelanced Pennsy and Reading

» **READ NOW**

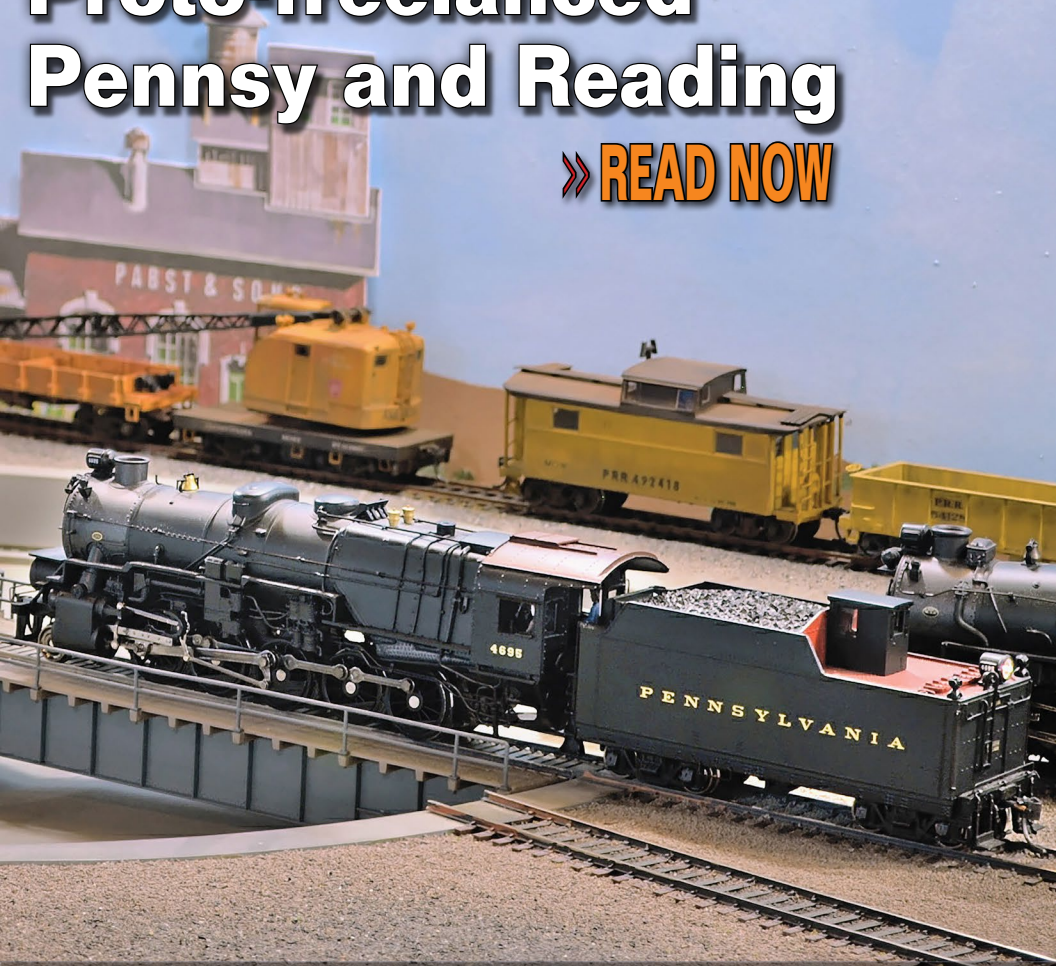

STANDARD EDITION | PORTRAIT



DOWNLOAD



SUBSCRIBE
(free)



WHAT A "STEEL"!

ATLAS MASTER® HO & N 42' COIL STEEL CARS AVAILABLE NOW!



Bethlehem Steel

CLICK HERE!



Indiana Harbor Belt



Conrail-CoilSHIELD 2



Wisconsin Central



CSX® (Blue)



Union Pacific



Canadian Pacific



US Steel++



Norfolk Southern



Elgin Joliet & Eastern ++

HO Models Shown
*CSX Licensed Product
++ Alternate History paint scheme



STAFF CREDITS

(Updated 5/2/2017)

Front cover: MRH visits Jerry Fassnacht's proto-freelanced Pennsy and Reading railroad this month. Jerry's layout will be open for tours at the NMRA national in Orlando this summer!



ISSN 2152-7423

Editorial Staff

Joe D. Fugate, Publisher and Editor
Don Hanley, Assistant Editor

Production

Patty Fugate, Pasteup and Layout
Joe Brugger, Copy Editing
Mike Dodd, Copy Editing

Technical Assistant

Jeff Shultz

Advertising

Les Halmos, Account Manager
Daniel Nava, Advertising Assistant
Jean-François Delisle, Marketing Assistant

Richard Bale, News and events
Jeff Shultz, News and events

Columnists

Joe Brugger, Questions & answers
Les Halmos, Modular railroading
Larry Smith, Narrow Gauge/Shortlines
Bruce Petrarca, DCC
Ken Patterson, Reporter at large

Rotating Columnists

Jack Burgess, Getting Real column
Nick Muff, Getting Real column
Mike Rose, Getting Real column
Tony Thompson, Getting Real column

Rob Clark, Imagineering
Dave Meek, Imagineering
Ray Dunakin, Imagineering

Issue password: May2017

Published for the glory of God. [What's this?](#)



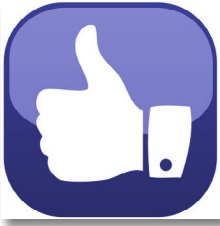

MRH SPONSORS

A - E



acculites.com



americanlimitedmodels.com



railroadhobbyshow.com



anemodel.com



archertransfers.com



athearn.com



www.atlasrr.com



bachmanntrains.com



bachrus.com



backdropjunction.com

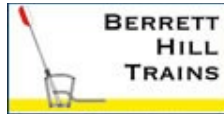

berrethill.com/trains



blairline.com



bowser-trains.com



coffmaneng.com



www.digitrax.com



esu.eu/en

[Vendors: Get your clickable logo here ...](#)

MRH SPONSORS | 2

F - R



www.handlaidtrack.com



foxvalleymodels.com



www.iascaled.com



lights4models.com



litchfieldstation.com



model-trains-video.com



modelrectifier.com



monstermodelworks.com



stores.ebay.com/Motrak-Models



mtalbert.com



ncedcc.com



nickandnoradesigns.com



nwhs.org



www.pwrs.ca/main.php



rapidotrains.com



ringengineering.com



rustystumps.com

[Vendors: Get your clickable logo here ...](#)

• [INDEX](#)



[SUBSCRIBE](#)
(free)

• [TABLE OF CONTENTS](#)

MRH SPONSORS | 3

S - Z



sanjuancarco.com



scaletrains.com



selectmodelrailroads.com



soundtraxx.com



sodigi.com



sbs4dcc.com

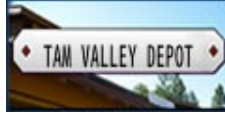

tamvalleydepot.com



tcsdcc.com



tonystrains.com



trainmastermodels.com



traintekllc.com



tsgmultimedia.com



walters.com



yankeedabblers.com

[Vendors: Get your clickable logo here ...](#)

Looking for something? Check the MRH Marketplace!

Take me there!

George Sellios *has produced his* **FINAL KIT**



FINE SCALE MINIATURES
I.M. Dunn Co. \$280 + S&H



*Destined to become an
instant collector's item*

BUY NOW >>

Brought to you by the MRH Store: store.mrhmag.com

• INDEX



SUBSCRIBE
(free)

• TABLE OF CONTENTS



TABLE OF CONTENTS

FEATURES

Jerry Fassnacht's Pennsy and Reading

JERRY FASSNACHT and the MRH STAFF

A layout on tour at the Orlando NMRA Convention



Modeling CP Rail 5406

ALEX REED

An ex-Quebec, North Shore & Labrador SD40



Getting to the fun part

NEIL SCHOFIELD

Freelancing the model scene at Bradford, VT



Universal modeling sizes chart

the MRH STAFF

Download this free MRH subscriber bonus



Window bars from tape

GENE LETOURNEAU

Clever method for modeling windows with bars



ALSO: MRH Marketplace | Subscriber extras

TABLE OF CONTENTS | 2

COLUMNS

MRH Q-A-T: Stripped coupler screws, and more

compiled by JOE BRUGGER

DCC Impulses: Wireless battery-powered DCC, part 3

BRUCE PETRARCA

Lite and Narrow: Shay-powered coal railroad

LARRY SMITH

What's Neat: Homemade leaves, and lots more

KEN PATTERSON

Photo feature: Yes, it's a model

compiled by DON HANLEY

Derailments: Bizarre facts & humor

compiled by the MRH STAFF

NEWS and EDITORIAL

Assistant Editor's Thoughts: Getting the proper focus

DON HANLEY

News & Events: May 2017

RICHARD BALE & JEFF SHULTZ

Reverse Running: True size of model railroading

JOE FUGATE





First Time in HO

AOK

BNSF

CMO



& Heritage Cars   



Gundersen 5188cf Covered Hopper

Preorder Now

© 2017 ScaleTrains.com, Inc. ScaleTrains.com, Operator, Rivet Counter, and respective logos are trademarks of ScaleTrains.com, Inc. ScaleTrains.com, Inc. 7598 Highway 411 Benton, TN 37307 844-9TRAINS 844-987-2467 International 423-299-3689



Scene and photography by Ken J Johnson
First test model shown



Model Railroad Hobbyist | May 2017 | #87

ASSISTANT EDITOR

editorial

DON HANLEY
.....



Click here to rate or
comment on this article

GETTING THE PROPER FOCUS

I CAME ACROSS THE FOLLOWING POST BY

Michael Mainridge on the MRH forum: “Longtime railfans/modelers – how did you select an era, location, and prototype to model?” [mrhmag.com/node/29216]

Michael asks a question I think is key to really enjoying the hobby long term. How do you find what you really like? What do you do if you don't have a clear vision of what you would really like to model?

One of my dreams has been to model the Chicago & Western Indiana some time between 1950 and 1955. The C&WI was a relatively short railroad, approximately 22 miles in length, running from Dearborn Station in Chicago, IL to State Line Junction. It included the Dolton branch which ran from 83rd Street to Dolton, IL.

This prototype line meets all of my wants: lots of switching, heavy duty mainline, a mix of rural/suburban/urban/industrial areas, and lots of interchange with a mix of eastern and western railroads.

To model the C&WI, I would need to include its owner roads, which were the Chicago & Eastern Illinois, Erie, Grand Trunk, Monon,

• INDEX
.....



SUBSCRIBE
(free)

• TABLE OF CONTENTS
.....

ASSISTANT EDITOR'S THOUGHTS | 2

Wabash, and tenant Santa Fe. I would also need to model the other roads that interacted with it, which was just about every railroad that entered into Chicago.

Did I mention the C&WI had over 200 miles of yard and industrial track? Or that it had a four track main in some spots? I would want to model that in part, along with some four track main. I would also want to build Alton Junction, commonly known as 21st Street. Some of the junctions had over 100 trains a day moving through them!

Wait, time for a reality check. To take on such a project would require a large space and the expense would be – well let's just say – way north of my income! It would require hundreds of locomotives, thousands of cars, and take 50 years to build, even with help.

ADVERTISEMENT

Checked us out lately?

- ✓ HO/N and now O scale products too!
- ✓ Laser-cut Structures & Bridges.
- ✓ Advertising & Storefront Signs.
- ✓ Highway Signs, vintage & modern.
- ✓ New Detail Items.
- ✓ Laser-cut Grade Crossings.
- ✓ Billboards, roadside & rooftop.
- ✓ Laser-cut Graffiti Decals
- ✓ 1000's of satisfied customers.

WHAT'S
NEW?

Established 1993...

Blair Line

ADVERTISEMENT

Select MODEL RAILROADS

Design & Build Services For Discriminating Modelers



CLICK HERE FOR OUR WEBSITE
www.SelectModelRailroads.com

(844) 872-4670

• INDEX

• TABLE OF CONTENTS

CROSSING THE PRAIRIES IN A 50-YEAR-OLD FISHBOWL

CLICK ON A TV TO WATCH THE ADVENTURE!



LIGHTS 4 MODELS

With the every purchase of a Rotating Sign receive a free 2507 Flush mount plate.

Over 17 signs to choose from

* orders with new signs get free shipping *



find us on facebook.

Shop Now



Want it on Blu-ray?

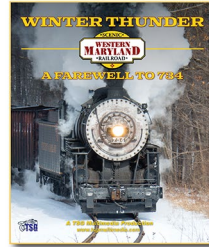
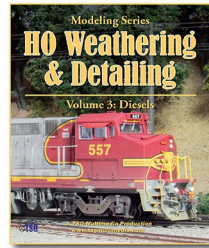

Selected titles are now available on Blu-ray disc in spectacular HD!

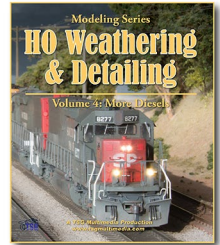

CLICK FOR BLU-RAY



TSG Multimedia

ASSISTANT EDITOR'S THOUGHTS | 3

I would be 111 when it's finished. This will not work, since I only plan on living to be 105!

Okay, back to reality: I have elected to model the Erie as my railroad of choice. It all began in 1976 when Conrail was formed. The railroad began routing former Erie Lackawanna traffic over the old PRR line that was about 100 yards away from my parents' house in Monroeville, IN.

I saw those slate and maroon units with the yellow stripes and ends and I was enamored. I researched more about Conrail and discovered its predecessor roads, the Erie and the Lackawanna.

The more I learned, the more I liked the Erie – and it grew on me, so I chose a time period where the Erie was in its heyday. Another reason for this time period is I prefer the smaller 40-foot cars as well as the glitz of the premier passenger trains of the 1950s.



▶ KANSAS CITY SOUTHERN #651
Item No. 67203

WHAT DOES 3,000 HORSEPOWER SOUND LIKE? LISTEN TO BACHMANN'S HO SOUND VALUE SD40-2

The dependable, versatile 3,000-HSP SD40-2 was one of EMD's best-selling locomotives. Bachmann has added a DCC sound-equipped version to its line of popular SD40-2 diesels. It includes the Sound Value SoundTraxx® diesel sound package with prototypical prime mover, 3 air horns, and bell—all in polyphonic 16-bit sound. This model also features all-wheel drive, operating headlight, and E-Z Mate® Mark II couplers. Visit your favorite hobby dealer to hear this diesel rumble down your line today!

SHIPPING NOW! MSRP \$209.00 each



▶ CP RAIL #5612 - DUAL FLAGS
Item No. 67201



▶ CSX #8013 - DARK FUTURE (HTM)
Item No. 67202

Click to
learn more



▶ NORFOLK SOUTHERN #3430
Item No. 67204



▶ UNION PACIFIC® #3450
Item No. 67205



Bachmann Industries, Inc. • 1400 East Erie Avenue • Philadelphia, PA 19124 USA • www.bachmanntrains.com

Click for more information.

• INDEX



SUBSCRIBE
(free)

• TABLE OF CONTENTS

Doing more research, I discovered that in the early 1900s there was an attempt to build a road from Cincinnati to Chicago, called the Cincinnati, Bluffton, & Chicago. The CB&C did manage to build from Huntington, IN to Portland, IN but got no further and was scrapped in 1917. No problem, I just rewrote history a bit and said the line did make it to Dayton, OH and was eventually taken over by the Erie.

Due to space limitations, I only have room for a switching layout along one wall of my garage. By making the town of Bluffton a little larger and more industrial, I am able to model the mix of industrial, residential, and commercial structures that I like.

I am taking various industries that were located in Northeastern Indiana and placing them in my chosen location of Bluffton. I adhere to the architecture of the buildings in this region, adding to the credibility of my freelanced scenes. I also added an interchange with the NKP (Nickle Plate) which ran through Bluffton.

The key to protolancing is to keep it believable, so to do this I limit myself to just equipment the Erie ran.

What has this focus done for me? It has kept me from purchasing things I don't need, saving me a lot of money. I model just the time period I like and I model a geographical area where I lived for almost 50 years. I am very familiar with it, which helps tremendously.

Finally, protolancing gives me the flexibility to pull parts and pieces of things I like into a scene as long as it fits the geographical area and is appropriate for the time period.

So for those who are beginning the layout planning phase or wanting to start over, what can you do? Do what Michael did.

Michael made a list of pros and cons for what he was thinking of modeling: and not just for one option, but for two he was considering. This is a great idea, and I recommend it, especially if you have more than one option.



H0 Model Shown

TWO SCALES: ONE DISTINCTIVE LOCOMOTIVE

ANNOUNCING

The spartan cab SD70 diesels were built by GMDD in London, Ontario, in 1993-1994. With most railroads opting for the wide-nosed safety cab for their new locomotives at this time, these unique units retained their standard EMD Spartan Cab—making them look much like their SD60 predecessors before.

However, they have several features that set them apart, such as the Integrated Cab Electronics (ICE) bulge on the engineer side of the nose, and HTCR radial trucks. Originally ordered by NS, IC, and Conrail, the CN became a second hand owner via the IC purchase. These locomotives can be seen today in revenue service throughout North America.



For the first time in N-scale, the spartan cab SD70 makes a debut. Equipped with a precision drive and a very detailed injection molded plastic body, this locomotive comes to life.



The H0 Genesis SD70 odyssey began in 2001 as a flag ship product with the first release and in a brand new Athearn product category. The SD70 series lives on today after being refreshed in 2015 with even more detail and many other enhancements.

VISIT ATHEARN.COM FOR PRICING AND COMPLETE SELECTION OF ROADNAMES!

HORIZON
H O B B Y

VISIT
Your Local Retailer

CLICK
Athearn.com

CALL
1.800.338.4639

SERIOUS FUN™

©2007 Horizon-Hobby, LLC. Athearn, Genesis and McHenry are registered trademarks of Horizon Hobby, LLC. All other trademarks, service marks and logos are property of their respective owners. Final models may vary slightly from photos shown. 54971

• INDEX



SUBSCRIBE
(free)

• TABLE OF CONTENTS

MAKING RAILROAD HISTORY
WALTHERS PROTO
EMD GP35 Phase 2

HO SCALE



FIRST SERIES - JUNE DELIVERY

- Completely new model from rails to roof
- Limited Edition - one time run of these engine numbers
- Based on Phase II units in service from 1965 on with correct frame, inertial filter hatch & road-specific details

Santa Fe*



Erie Lackawanna



Burlington Northern*



Milwaukee Road



Chesapeake & Ohio**



Southern Pacific†



CLICK HERE TO LEARN MORE!

WALTHERS

Support your local hobby shop • visit walthers.com • call 1-800-4-TRAINS

©2017 Wm. K. Walther, Inc. Delivery dates, prices and specifications were accurate at press time, for updates visit walthers.com. Photos show early preproduction models, colors and details may vary.
 *The ATSF and BN marks are licensed marks owned by BNSF Railway Company. **CSX proprietary marks used by permission of CSX Transportation Inc. †Union Pacific licensed product.

• **INDEX**

• **TABLE OF CONTENTS**

ASSISTANT EDITOR'S THOUGHTS | 5

After making the lists, the one with the most cons should be eliminated. Take the pros that tug at you and fit them into your space.

From the lists you discarded, there may be pro elements in the other lists that could be incorporated into your final list. It's important to take your time and don't rush.

Editor Joe Fugate went through a process of determining what he wanted and ended up with a layout that served him well for many years. I have done the same, and although I didn't write it down, it's firmly fixed in my mind. Writing down your choices and goals for a layout can be helpful, though.

Also consider the TOMA concept (the "one module" approach) even if you are planning a large layout. By building your layout in sections, you can determine if your plan works as you go. With TOMA, it is easier to replace a section that doesn't work than it is to rebuild parts of a more monolithic layout design.

While you may think that a large layout with 20-25 operators is ideal, you may find you prefer only 5-6 operators after you've tried things out for a while. TOMA gives you the flexibility to adapt as needed partway into building a layout.

I am reminded of a cartoon in *Model Railroader* many years ago. Two modelers were discussing a layout and said "They don't call them layouts for nothing. You lay out \$5 and \$10 at very alarming rates!" Now, however, it's more like \$50 and \$100 at very alarming rates!

Planning what you really want and bringing that into sharp focus will save you lots of wasted money and time. As the saying goes "Failing to plan is planning to fail."



[Click here to rate or comment on this article](#)



MRH 2016 Survey, Time spent on the hobby?

Here is the response from our 2016 reader survey question asking our readers how long they've been interested in the hobby of model railroading. The statistical validity is +/- 2.5% with a 95% certainty.

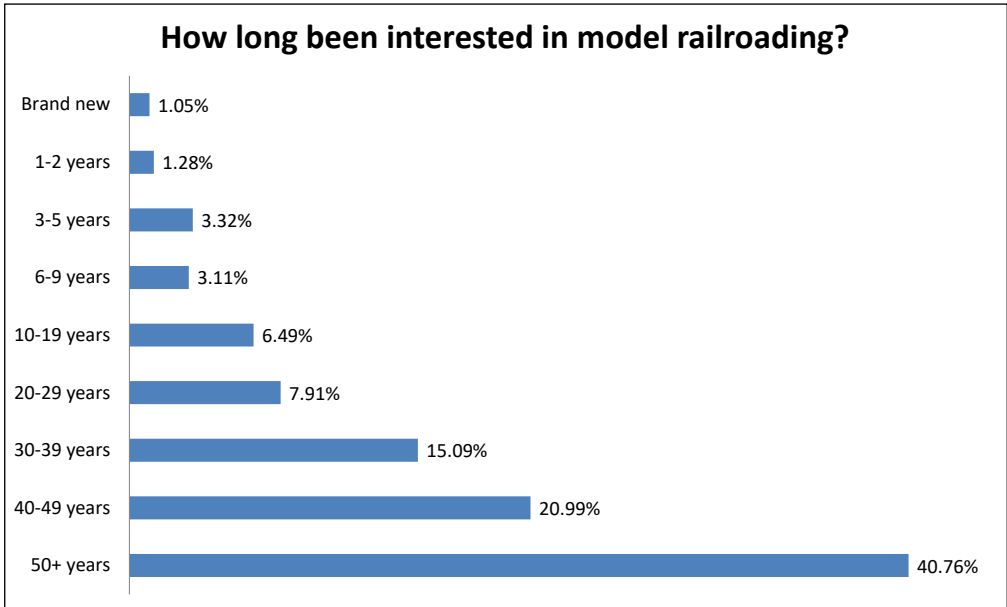

Looking at our results above gives us about 60% of our readers who have been interested in model trains less than 50 years and 40% who have been interested in model trains for 50 years or more.

It's encouraging to see more modelers in total who are newer in the hobby than modelers who have been in the hobby "forever." This is just another data point on the "graying of the hobby" observation. As long as the newcomers outnumber the old-timers, the hobby should have a long future.

Bowser

HO & N N5 Caboose

Road Names: B&M, Conrail, D&M, Long Island, New Haven, Penn Central, & PRR

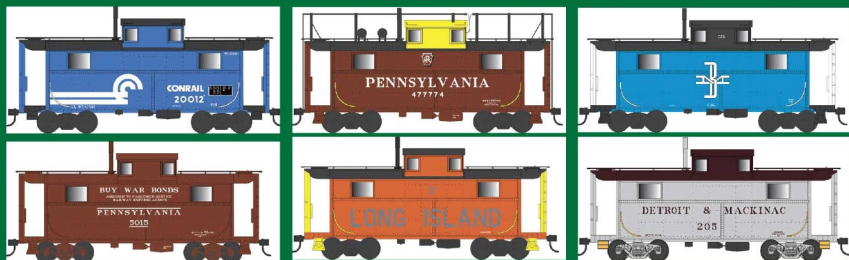

HO 100 Ton Hopper Cars

Road Names: C&NW, D&M, LV, NYS&W, P&LE, R&N, Reading, RI, SP, & Wisconsin Central



N Scale 2 Bay Airslide Hopper Cars

Road Names: ADM, BNSF, Brach's Candy, BN, Chessie System C&O, D&RGW, GATX, Milwaukee Road, MKT, Santa Fe, & UP



Click here to check out the details for these and other great Bowser Products





LAST ISSUE'S RATINGS

The five top-rated articles in the [April 2017 issue](#) of *Model Railroad Hobbyist* are:

- 4.7 Dwarf seachlight signals with SMD LEDs
- 4.6 Ocean Spray boxcars
- 4.6 Getting Real: Finally getting it right
- 4.6 Yes, it's a model
- 4.5 What's Neat: Foam-based layout tips, ...

Issue overall: **3.6**

Please rate the articles! Click the reader comments button on each article and select the star rating you think each article deserves. Thanks! ■

ADVERTISEMENT

CRAFTSMAN KITS

Our instruction manuals are second to none!
CHECK IT ALL OUT AT
WWW.RUSTYSTUMPS.COM
 THE QUALITY IS INSIDE BECAUSE OUR NAME IS OUTSIDE

ADVERTISEMENT

NEW! Carbone's Service Station
 HO Scale Kit #ST027

NICK & NORA DESIGNS

Uniquely inspired craftsman kits
Craftsman Structure Kits in HO & N
 Detail Parts,
 laser cut shingles,
HO Vehicles, Tru-Color Paints,
 glues, tools & more!
www.nickandnoradesigns.com

FAST TRACKS BUYS MT. ALBERT SCALE LUMBER CO.

Fast Tracks is helping the world build EVEN better railroads with the addition of Mt. Albert Scale Lumber.

New Mt. Albert products and model kits coming soon.



Easy ordering • Live online support
Earn Waypoints with every purchase

shop online 24/7

handlaidtrack.com

1-888-252-3895

service@fast-tracks.net

• INDEX



SUBSCRIBE
(free)

• TABLE OF CONTENTS

**Hobby
persistence
gone?**

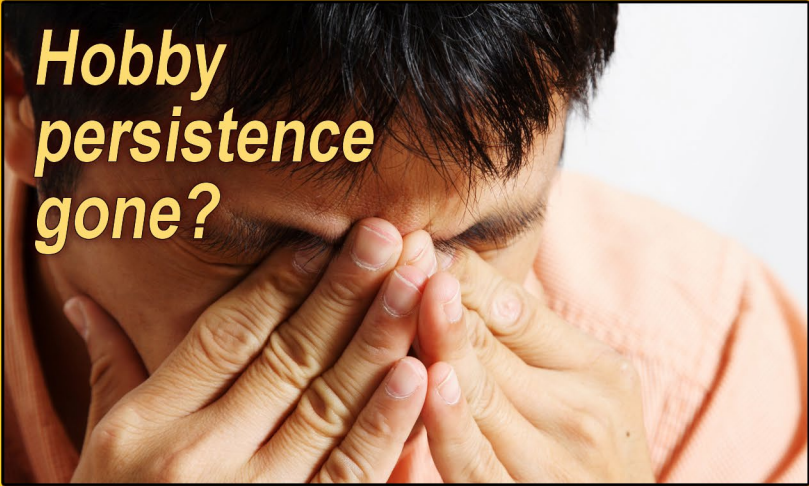

“Persistence isn’t needed when you know how to do it right the first time.”

TRAINMASTERS TV

Our experts teach you to *do it right from the start.*



click here to
Become a member >>

www.trainmasters.tv



“I can’t imagine life before Trainmasters TV. It is worth every penny.” – Guy E.



Model Railroad Hobbyist | May 2017 | #87

MRH Q-A-T

column

compiled by
JOE BRUGGER
.....



[Click here to rate or comment on this article](#)

QUESTIONS AND ANSWERS

Stripped coupler screws

Q. As careful as I try to be, I've managed to strip a couple of coupler screws in two of my locos. Actually, the screws are just fine. The threaded plastic they screw into is the problem. I've always managed to figure some convoluted way to make things work, but was wondering what other more skilled folks do to deal with this issue.

—John C

A. Don Mitchell: Just put a drop or two of CA on the stripped threads and hit it with a spray of accelerator. Put the screw back in with a reasonably gentle twist and the CA will be enough to hold the screw. The treatment can be redone if necessary but, for screws that are used frequently, use Joe F's method . . .

Joe Fugate: ... get some styrene rod that just fits into the hole, glue it in and soak it good with styrene solvent. Once it sets up

▶ MRH QUESTIONS, ANSWERS, AND TIPS

• [INDEX](#)
.....



SUBSCRIBE
(free)

• [TABLE OF CONTENTS](#)
.....

MRH Q-A-T | 2

for a couple hours, trim the top flat. Most coupler mounts are set up for a 2-56 screw. To keep the hole centered, start with a smaller drill size and then open up the hole with a #50 drill (.070") before tapping the new threads.

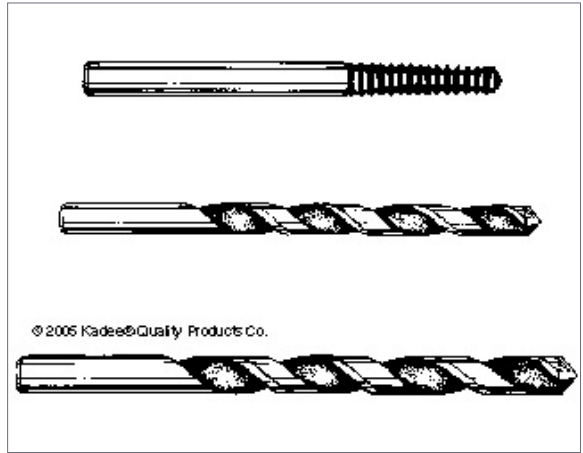

Graham Line:

Among my leftovers is a shoebox of plastic sprues from kits. Some have a minute hole at the center to center your drill. Sprues come in lots of colors and the plastic is easy to turn to size with a drill and a file. To avoid screws hanging up and stripping threads, put a tiny dab of beeswax or plastic-compatible grease on the screw threads.

Drill and tap kits are available from several suppliers, including A-Line ppw-aline.com/collections/bulls-eye-drill-tap-jigs and Kadee kadee.com/~kadeecom/htmbord/page246.htm.

Road width

Q. How wide should a normal two-lane road be for my late 1950s-era railroad? What I have allotted right now doesn't look correct to me. How about the width of a street in town? I don't care if I get it in inches or scale feet, I just need something to go on to make it all look right.

—Dagenham

A. Steve in Iowa City: Is it a rural paved state highway? Would you have a shoulder or not? Without actually measuring, I've taken



1. Michael Rose makes his N scale roads 2 inches wide, which means a lane width of about 13 feet.

a few HO scale cars and trucks and added what looked “right” on either side. Do the mirrors of oncoming vehicles smash into each other? Too close! There are DOT standards on such things, but I think roads in model railroading are sort of like trees. If they are actually to scale in some instances, they just look huge. In some old, “locked in time” small towns I’ve driven through, where the road gets really wide as you enter town, you can usually tell which is Main Street. So I say whatever looks right probably is!

Brian (G1000vista): My highway lanes are 10 to 12 feet wide. I take two scale model cars or trucks, put them side by side and see what looks correct. Roads vary – main highways are wider, two-lane county blacktops can be narrower. Gravel roads range from real wide to very narrow. Add a few feet for a shoulder. It really depends on how much space you have to work with. If it is a narrow spot, well, everything can be scaled back a bit and still look OK.

James S: 12 to 15 foot lanes look better when a vehicle has visible space around it. Making the lane width the exact size of the vehicle does not look at all realistic.

Irish Rover: Depending on where your road is, a one-way street can save some space. I built a diorama with a two-lane road so tight there would certainly be no on-street parking. Now, it's a one-way street with on-street parking, and has plenty of space for a car to park and a car to pass. In some places, the roads are older than the DOT standards with no practical way to widen them. In New Hampshire's White Mountains, there are some adequate roads with one-lane bridges or underpasses. Early bridges can be much too solid to alter easily.

JC Shall: Here is a link to a chart published by the Federal Highway Administration. I assume the chart is for today's roadways, however I think the narrower widths listed in a range would be applicable to your time frame. Roads and highways 60 years ago frequently had narrow shoulders or none at all. I remember as a kid with a bike riding on some that if you swerved off the road, you'd end up in the ditch.

Look at safety.fhwa.dot.gov/geometric/pubs/mitigationstrategies/chapter3/3_lanewidth.cfm.

Allen (atsf0001): Here's a great source for details on signage for roads, grade crossings, etc. for various time periods: ceprofs.civil.tamu.edu/ghawkins/MUTCD-History.htm.

I don't know that you'll find anything about lane width, but that seems well-addressed. I also model the late 1950s and have found the info from this website very helpful.

India ink washes

Q. I am trying to remember the ratio of India ink to alcohol given in the past for a solution to be used as a go-to wash for



Archer

FINE TRANSFERS
PROUDLY SERVING MODEL BUILDERS SINCE 1989

**THE ORIGINAL
SURFACE DETAILS™**

**WE NOW HAVE MORE
THAN 130 SHEETS OF
RIVETS, LOUVERS,
TREADPLATE, WELD
SEAMS AND MORE
CAST ONTO
MICROSCALE CLEAR
DECAL FILM**

LOW SHIPPING:

**DOMESTIC USA ORDERS
\$2.80
INTERNATIONAL ORDERS
\$9.95**

CLICK HERE TO VISIT OUR WEBSITE!

Archer Fine Transfers • PO Box 1277 • Youngsville, NC 27596 • USA
(919) 570-1026 • info@archertransfers.com • archertransfers.com

"Archer Fine Transfers 3D decals have revolutionized kitbashing and scratchbuilding. Putting rivets or other low-relief details like louvers or weld seams on your models is now as easy as applying decals."

Joe Fugate, Publisher/Editor Model Railroad Hobbyist



TRINITY 3281 IN STORES NOW



Norfolk Southern -- 12 #s



ICE-GATX -- 8 #s



Winchester & Western -- 12 #s



NRLX Ciment Quebec -- 12 #s



HWCX -- 7 #s



www.americanlimitedmodels.com

HO GP60M, GP60B AND GP60 Locos



Now Available!



DC or DCC with Sound!



www.foxvalleymodels.com



COMING SOON IN HO SCALE!



HO SCALE PILOT MODEL SHOWN

We plan to produce an HO Scale version of our very popular Mt. Albert Lumber Yard kit later this year. Please watch our website and Facebook page for more details.



all things on a layout. I remember there being two basic levels, sort of a 2% or a 5% type thing. Could anyone help?

—Marxalot

A. Joe Atkinson: At lancemindheim.com/roads.htm, Lance Mindheim recommends 2 teaspoons India ink per 1 pint of alcohol. I started there, but ended up adding more ink for road weathering purposes.

Lance Mindheim: There is probably no single technique that contributes more to the realism of roads and structures than the wash, so it is certainly worth putting into your weathering arsenal. I originally picked it up from a George Sellios video.

As mentioned, I have a bottle of 1 tsp./pint of alcohol that I use for lighter surfaces and a bottle of 2 tsp./pint for darker surfaces. On occasion I may go slightly lighter or darker. I use Higgins brand ink I buy at Michaels. Alcohol strength doesn't seem to matter, so I go with 70%.

Ink and alcohol runs differently from paint, You have to babysit it a bit until it dries, to make sure you don't get odd pooling or mottling. Keep handy some straight alcohol and a rag and/or cotton swabs. Wipe vertically downward if you get an odd look. This application and wiping produces a nice effect on its own. It's a cheap, easy, and highly effective technique, so give it a try.

Rick Wade: I use a number of mixes with the same ratio as Lance. With India ink available in different colors, I have mixes using black, brown, black and brown mixed together, and blue mixed with brown. For staining a group of individual boards I'll divide them into groups and stain them with three or four different color mixes and then, when dry, mix the boards all together to give some variety.

Norfolk and Western Historical Society

**Brand New
Video!**

**Feature
length DVD
or Blu-Ray.
The official
story of
611's 2015
restoration**

to operating condition.

**How can I add this great disc
to my collection?**



Click Here!

• INDEX



SUBSCRIBE
(free)

• TABLE OF CONTENTS

 TIPS

Make touch-up scenicking easy

When I was doing some touch-up work on a diorama I use for photography and display, I realized how ridiculous it was for me to haul around huge bags of turf or shaker bottles of ballast. I model in N scale, so for a touch-up, the most minute amount was enough. Lugging around huge bags and bottles was asking to make a mess or knock over something fragile. Trying to reach some tight places forced me to make little turf piles and try to sweep it where I wanted it to go. I needed a better way.

I'm a model railroader at night, but a college student during the day. When I was going through my school gear I stumbled onto my solution: I found an empty mechanical pencil lead case. These refill cases



2. A mechanical pencil's lead case or eraser case makes a great spot applicator for touching up scenery, especially in hard to reach areas.

usually hold 10-20 pieces of pencil lead in 0.7 mm diameter range. They are very small and usually have a friction-held sliding opener for a single finger to flip it open or closed. I filled my case with some turf, and it worked great for when I repaired a small patch of scenery. I also found an empty eraser case for ballast. No more giant bags and imprecision. Now I have very portable containers with only the material that's required.

If you do not have mechanical pencil paraphernalia in the house, you can pick these up at a store for a few bucks. At the store the other day, I saw a package of two mechanical pencils, a lead refill case, and an eraser case for \$3. And you get two nice pencils to design your base-ment empire.

—Peter Muto



[Click here to rate or comment on this article](#)



GET PAID FOR YOUR TIP

We pay \$25 per tip we publish, or \$40 each if the tip also includes a photo or finished drawing. [Click here and select article type TIP.](#) ■





Introducing

Complete Train Control

The next Evolution in Complete Train Control®

- Premium Advanced 5/8 Amp Starter Sets.
- Starter sets are available as standard tethered or duplex radio.
- The system features a DCS210 Advanced Command Station, DT500 series throttle, and includes a power supply to make getting started easier than ever.
- The DT500 series throttles can be purchased separately from the new Starter Set.

Find out more @ www.digitrax.com



E
St
DT
PS

E
D
DT
PS

the **EVOLUTION**™



Evolution (shown) | **\$450 MSRP**

Standard Set Includes: DCS210 Advanced Command Station, T500 Advanced Super Throttle, UP5 Universal Panel, 6615 power supply, and a LT1 LocoNet Tester.

Evolution Duplex | **\$660 MSRP**

Duplex Set Includes: DCS210 Advanced Command Station, T500D Advanced Duplex Throttle, UR92 Universal Panel, 6615 power supply, and a LT1 LocoNet Tester.



Southern Digital

WWW.SODIGI.COM

Celebrating 25 Years of serving you !



**Soundtraxx Tsunami
Motor/Sound Decoder
50% Off while they last**



Super Sale



Complete Train Control

Simplex Radio
Throttle clearance
while they last



Close Out

**DT402R
\$165**

**UT4R
\$99**

DCC Conversions, Service & Support

E-mail: sales@sodigi.com (770) 929-1888





DCC IMPULSES

column

BRUCE PETRARCA MMR
.....



[Click here for
reader comments](#)

WIRELESS DCC, PART 3, BRINGING IT ALL TOGETHER

IN THE LAST TWO MONTHS, I'VE TAKEN YOU readers on a journey through the background of sending DCC signals wirelessly to your locomotives in mrhmag.com/magazine/mrh2017-03/dcc-impulses and the intricacies of batteries in mrhmag.com/magazine/mrh2017-04/dcc-impulses.

This month, I'm going to bring all that together in a real-life example of what has worked for me. I'm writing this in the afternoon after our club (PCMRC.org) held its spring open house [1] this morning, Good Friday, April 14, 2017.

I built three battery cars to pull behind the locos in the garden. Here is a bit of how they came together and some lessons learned both for garden and smaller gauge dead track operations.

Here's what I did to get our club's RS3 [2] running on batteries.

1616 is one of our older garden locos and has had a QSI Magnum DCC decoder installed for about a decade now. My

► DCC TIPS, TRICKS, AND TECHNIQUES





1. Two of the trains running on battery power at the PCMRC open house. *Bruce Petrarca photo*

plan was to add a AirWire miniCONVRTR board with an external antenna to drive the QSI decoder. A connector for the trailing battery car would finish the installation.

I spent several hours dealing with prior work in the loco, mostly mine, and getting the AirWire board installed. I added a switch to allow either battery or track power operation [3] and a battery connector hanging off the rear. After the installation was done, it wouldn't run on battery. I was frustrated.

Then I found a sheet of paper, an addendum to the miniCONVRTR instructions. No, I hadn't read all the instructions. I did one of these installations in my Bachmann rail truck earlier and knew it all – so I thought.



2. PCMRC's RS3 runs with a trailing battery car. Sharp-eyed readers will see the (silver-colored wire) antenna just sticking out in front of the exhaust stack and the interconnecting cable of red and black wires between the loco and the Rio Grande box car. *Bruce Petrarca photo*

DCC IMPULSES | 4

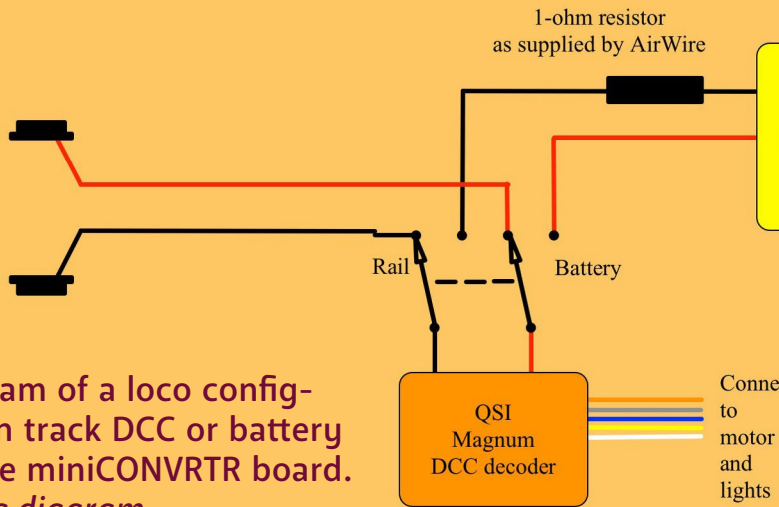

3. Block diagram of a loco configured to run on track DCC or battery and an AirWire miniCONVRTR board.
Bruce Petrarca diagram

ADVERTISEMENT

Make LocoNet wiring extremely simple!

ACCU-LITES, inc
Your DCC Center!

Suitcases belong in your baggage cars,
not under you layout!

Introducing the DCC Vampire II ...
this guy does the job of two suitcase
connectors!
And really holds the connection good
too!

CLICK NOW TO DISCOVER THE AMAZING VALUE!

Dealer Inquiries Accepted

• INDEX

• TABLE OF CONTENTS

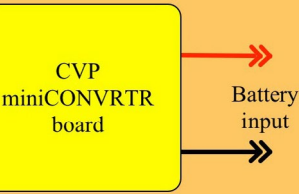

The sheet contained a list of a very few DCC decoders that had been tested with the miniCONVRTR, and notes about what it took to work with them. Aha! No QSI decoder was listed. However, it suggested that the use of the (included) 1-ohm resistor in series between the miniCONVRTR and the decoder might keep the miniCONVRTR from shutting down.

It was worth a try, so I put the resistor in the circuit [3] and the loco came alive.

Run time

As I discussed last month, I was shooting for a run time of 3+ hours of roundy-round operation. I measured a running current of just about an amp (1000 mA) for this loco. We purchased 6800 mAH batteries for all uses. I expected as much as seven hours of running time with these batteries.

While early (less than two-hour) test runs were positive, I was waiting for the open house to really prove my

ADVERTISEMENT

www.SBS4DCC.com

ESU TCS WOW Sound QSI Solutions ZIMO

SOUNDTRAXX[®]

NCE The Power of DCC Digital[®]

DCC Specialties INNOVATION FOR DCC MRC Model Rectifier Corporation

ACCUTRACK II SPEEDOMETER SPROG DCC the DCC Programmer and Control Family Digital plus[®] by Lenz

TAM VALLEY DEPOT Great Electronics for Great Model Railroads TEAM DIGITAL, LLC Improving the world of DCC

N - HO - HO3 Scale Trains



theory. Today, we ran 1616 for 3-¾ hours continuously at about ⅓ maximum speed; a nice show pace. Recharging put only 2532 mAH back into the battery. From that I predict that the loco may run as long as 10 hours on one charge. Far beyond my wildest expectations. BTW, this recharge took just over 1-½ hours with the X1 charger I described last month.

The battery car

Now, I'd like to share some of the details of the battery car with you. For the basic car, a Piko 40-foot box car looked like a winner. It is era-appropriate, has operating doors with latches, is nicely detailed, has an easily removable roof with full interior access

ADVERTISEMENT



ANE Model
Navigator of Turnout & Digital control

LD101
Coming Soon

ANE model
www.anemodel.com

www.anemodel.com

ADVERTISEMENT



WAY TO GO, TRAIKTEK!
Already great prices
and NOW ...

**FREE SHIPPING
ON ORDERS OF
\$79 or more***

Start saving now!

TrainTek

*some exclusions apply

and is reasonably priced at \$67.99 MSRP. The photos here are of Piko #38848, D&RGW car #62803. Other road names were selected for the other battery cars.

Our coupler standard is Kadee garden couplers and the car comes with the hook and loop couplers popularized by LGB. A Kadee 906 gear box and coupler set mounts nicely under the end lip of the car [9].

A couple of pieces of 0.06 inch thick styrene shims the gear box down about 1/8 inch to clear the lip and sets the coupler at the correct height per the Kadee gauge. I cut the Talgo-style mount off the trucks and turned the trucks around so there is no chance of the remaining nubs catching on the Kadee gear box. One word of caution: the draft gear

ADVERTISEMENT

TCS *WOWSound*

**Version 4 of WOWDiesel
NOW SHIPPING!**

WOWDiesel Version 4 Introducing the
645 Non-Turbo Prime Mover

All with Unmatched CD Quality Sound at
TRUE 16 bit Resolution that nobody else can
come close to!

click here

Learn why loco sound fans prefer WOWSound ...

Remember you "Rivet Counters", Sound has rivets too and TCS counts them better than anyone!

www.TCSDCC.com



DCC IMPULSES | 8

box limits the truck rotation, the wheels hit the draft gear box. Don't use this coupler set if you have the smaller radius garden tracks like LGB 1100 series.

The first trick is to get the roof off the car. It is easy once you know where to push and pull [4].

I built an insert out of black 0.06 inch styrene to hold the parts shown in the schematic diagram [5].

The insert [6] fits between the doors and holds the battery pack, the on-off switch and a digital volt meter. In operation, with the doors closed [2], the car looks normal, except for the battery cable running out of the A -end [9].



4. Removing the roof from the Piko box car. Open the doors, pull lightly out on the side wall just above each door. The tabs on the roof that engage the side walls should be able to be popped out, leaving the roof bowed from end to end. A slight tug on the end will release the end tabs. *Bruce Petrarca photo*

TONY'S TRAIN XCHANGE

Committed to your DCC support!

New Athearn Genesis EMD SD70 Series



New Road

Names & Numbers

in DC or Tsunami2 Sound & DCC
CSX SD70M, NS Spartan Cab
SD70, BNSF Warbonnet SD75i,
UP SD70M & CN SD70i

Starting at \$149.95

[Order Yours](#)

SoundTraxx Tsunami2 Decoders

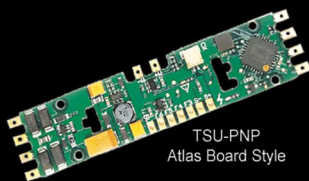

TSU-PNP
Atlas Board Style

The Tsunami2 Features Superb
Sound, Motor & Lighting Control.
Available in 5 Formats!

Starting at \$87.96

[Order Yours](#)

TDS SuperSonic Speakers & Enclosures



Incredibly Big, High
Quality Sound, From
Incredibly Small, High
Quality Speakers.
Don't Forget Enclosures!

[Order Yours](#)

**Do you need a Sound or
DCC Installation done?**

Get a quote!



Providing unmatched person to person
DCC support for more than 25 years, the
kind of service that has made us #1 in DCC.

DCC questions? CALL US! 1-800-978-3472

We'll get you on the right track!

May 2017



• [INDEX](#)



[SUBSCRIBE](#)
(free)

• [TABLE OF CONTENTS](#)

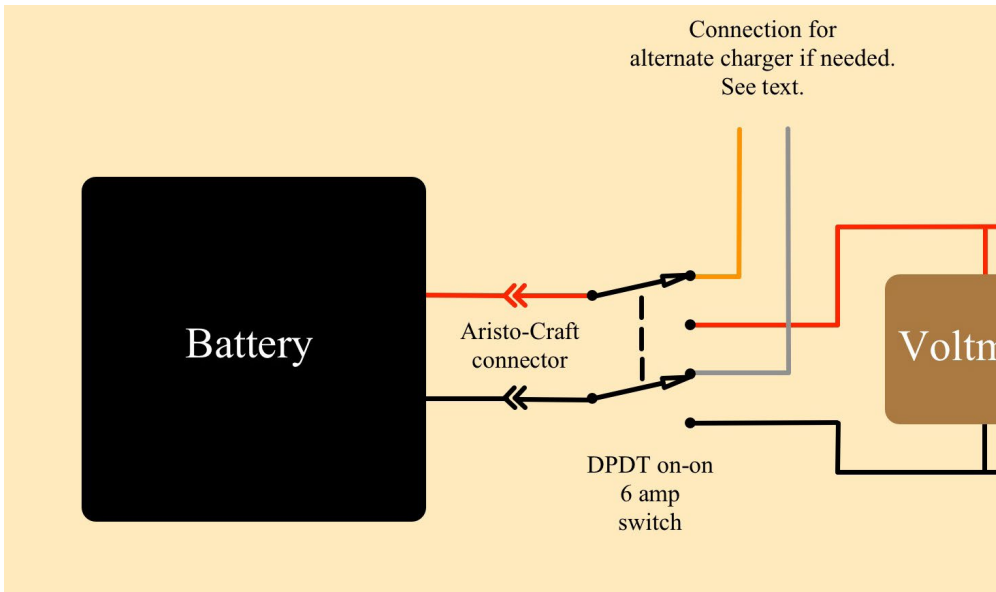

The goal of the insert design was to hold the battery securely, yet allow it to be changed easily. To avoid disrupting the car's operation, the battery needs to be centered and as low as possible in the car. This meant having the battery on its side, to keep the center of gravity down.

I purchased a "battery extension" cable from DeadRailInstalls.com. I got ones with Aristo-Craft polarity about 18 inches long. They are inexpensive and have silicone-insulated wire that is nice to work with. I cut the end that goes to the battery (male pins) off about 1 inch from the connector and wired it to the center contacts of the switch.

It seemed logical to me that the B end (brake wheel end) of the car would be away from the loco, so I drilled the A end bulkhead for the cable to fit through. After I put a bit of shrink tubing next to the connector, I inserted the remaining cable through the hole, leaving the connector hanging outside [9]. The shrink

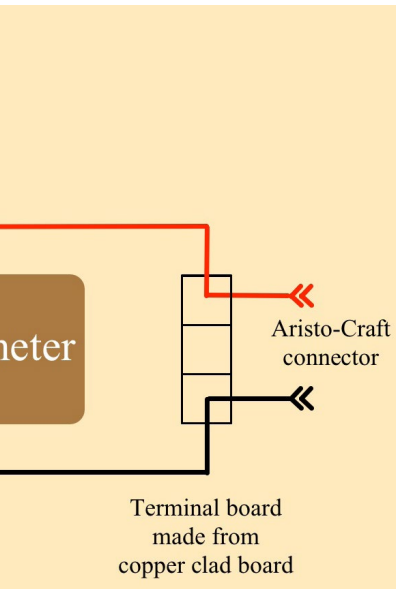

5. Schematic diagram for the battery car. I had no issues charging this battery with the digital meter connected. I used my X1 charger connected in place of the loco with the switch on. However, if your charger has issues connected this way, the charging connection shown (orange and gray wires in the diagram) could be added and used. If not needed, there is no reason for added confusion. *Bruce Petrarca diagram*

ADVERTISEMENT

RailPro™

NEW TECHNOLOGY

DIRECT™ RADIO

Click Here to Learn More

For more information visit our Internet site: www.RingEngineering.com

RE RING™

ENGINEERING

NEW Starter Kit

\$399.99 MSRP

- Includes Wireless Color Touch Screen Handheld Controller and 56 Watt Power Supply
- Expandable to Virtually any Size Layout

NEW Locomotive Module

LM-3 & LM-3S

- Direct Radio RF
- Sound and Non-Sound
- New Tiny Size
- 6 Light Outputs

RailPro™ Power ON Main Page

Handheld Controller Model # HC-2

Control Locomotive (CO) Link Forward

17.6% Link Forward

5714 UP 5714 Info

Frnt Light Dim Ditch Pop Off Next Page 1

Horn Bell Engine Back Light Exit Page

DCC IMPULSES | 11

tubing will protect the wires against chafing as the loco moves down the track.

To connect the wires and provide some strain relief for the external connector, I built a terminal board out of a piece of copper-clad board. I used my rotary tool to cut through the copper cladding so that I had three sections. The two outside ones are for the connections and the center one for the mounting machine screw. I drilled a hole for the mounting and bolted the terminal board and the battery carrier into the center of the car.

I cut off about six inches of the cable to use to wire between the switch and the terminal board.

Carefully maintaining polarity, I wired the cable between the PC board and the side of the switch that would be connected to the

ADVERTISEMENT



Big Sound. Small Budget.

The ECO-200 Digital Sound Decoder provides a plug-in installation for great sound at an incredible price! Enjoy prototypical steam or diesel sounds, advanced motor control, and 6 lighting functions.

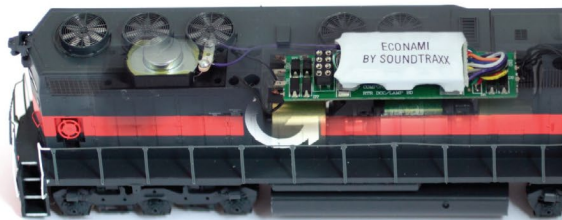

Compatible with 9-Pin DCC-ready locomotives from Athearn, Walthers, and other model manufacturers

[Watch the Install Now ▶](#)

DCC IMPULSES | 12

battery when the switch is thrown toward the A end of the car. I then twisted the wires from the switch to the wires from the connector and soldered them to the PC board.

The car is ready for the battery to be plugged in. Charge it up and run a train.

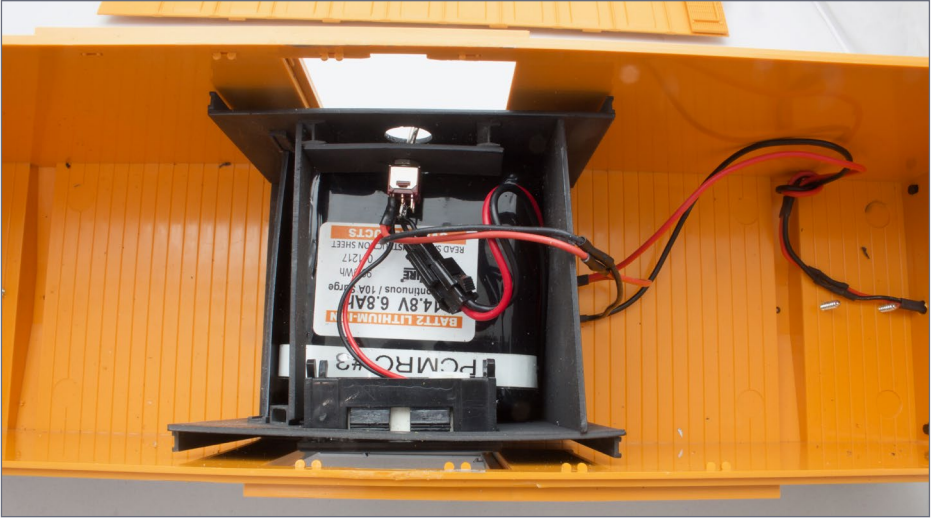

6. Battery insert (black) in Piko box car. In the photo, the on-off switch is at the top, the digital volt meter is at the bottom. The battery (CVP 6800 mAH 14.8 V) slides out when a piece of styrene is removed from the left side. Screws for mounting the Kadee couplers can be seen near the battery-wires on the right side. Mount the new couplers before installing wires, to avoid shorting out the battery. The wires from the switch are soldered to a small circuit board under the right-side mounting bolt with the connector wires terminating there, too. This keeps the external tugging from pulling the wires off the switch. Also, there is a knot in the wires to keep them from tugging on the solder connection. *Bruce Petrarca photo*



DCC IMPULSES | 13

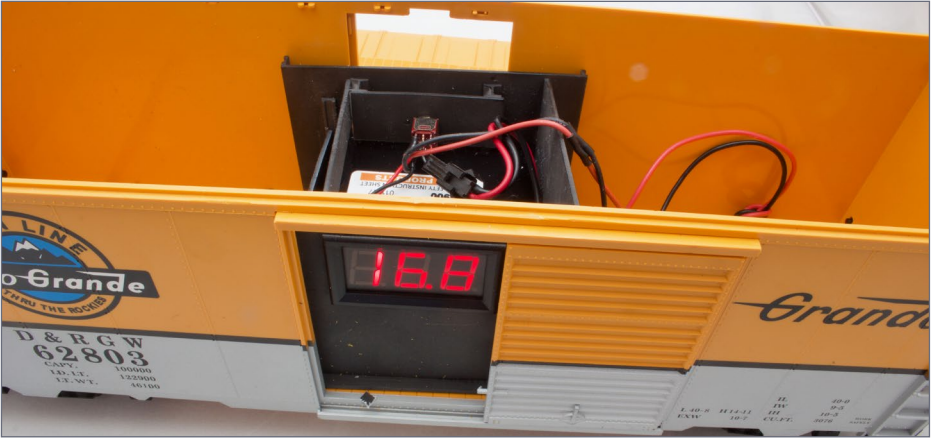

7. Side view of the Piko battery car showing the voltmeter. 16.8 volts indicates a fully charged battery. The batteries will hover between 15.25 and 14.75 volts for much of their life. Once they drop below 14 volts, it is time to turn off this battery car and charge it. *Bruce Petrarca photo*

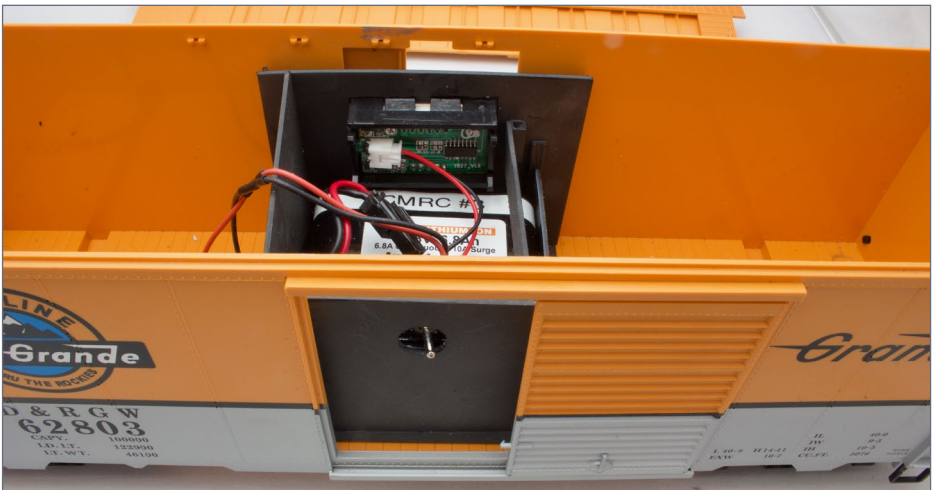

8. Opposite side showing on-off switch. I chose not to label "on" or "off." I may change my mind later. I set the switch so that it pointed forward when on. *Bruce Petrarca photo*

DCC IMPULSES | 14

After running these cars a bit, I would think of some sort of LED near the switch that would be illuminated when the power is on.

Another addition might be “run-charge” and “off” next to the switch. However, if you use the alternate charging connection [5], the labels would be “run” and “off-charge”. I’d suggest an different connector for this charging input, to avoid confusion.

Please share your experiences and ideas. Just click on the Reader Feedback icon at the beginning or the end of the column. While you are there, I encourage you to rate the column. “Awesome” is always appreciated. Thanks.

Until next month, I wish you green boards in all your endeavors.



9. A-end of Piko battery car showing the male-pinned connector to mate with a loco. A bit of shrink tubing reduces the chafing on the wires when the connector is pushed back into the car after the loco connection has been made.
Bruce Petrarca photo

PARTS FOR BATTERY CAR

Description	Qty	Manufacturer / source	Part Nbr
Box Car	1	Piko	38848
Kadee coupler set	1	Kadee Quality Products	906
Sheet 6 x 12 inches black styrene 0.06 inches thick	1	Evergreen Scale Models	9516
6800 mAH 14.8 volt battery	1	CVP	AirWire BATT2
DPDT miniature toggle switch 6A rated	1	AllElectronics.com	MTS-8
3.3 - 30 volt digital meter	1	AllElectronics.com	PM-123
4-40 nut and bolt	2	MicroFasteners.com	
Aristo-Craft style battery extension cable with 18 inch silicone wires	1	DeadRailInstalls.com	



**Click here for
reader comments**

Got Steam?

**Full Throttle Steam
Available Now!!!**

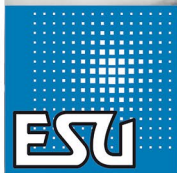
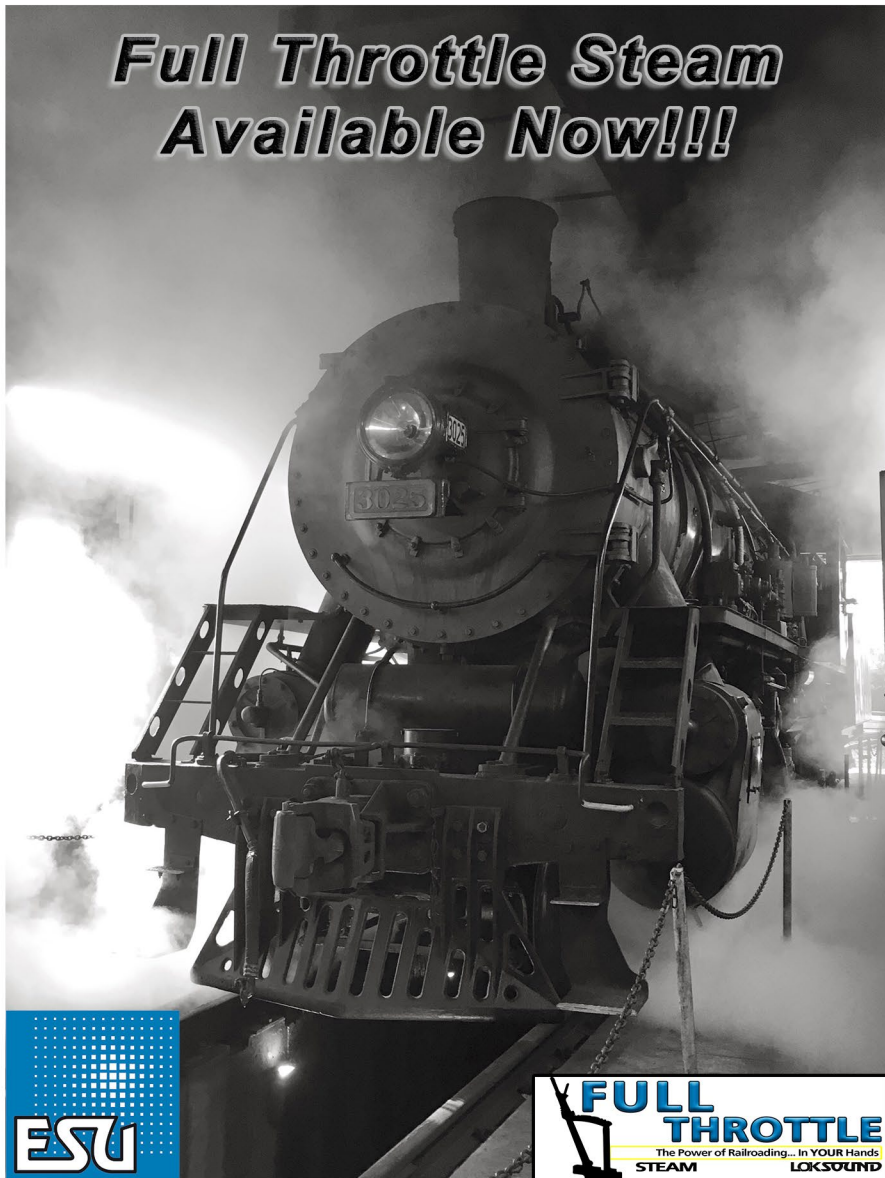

www.LokSound.com

• **INDEX**



SUBSCRIBE
(free)

• **TABLE OF CONTENTS**

MR. DCC'S WORKSHOP

Changing channels with the AirWire products

Setting these locos up for our club's open house, I needed to migrate the T5000 AirWire throttles off the default radio channel (zero) and have each cab on a separate frequency.

I numbered the cabs with our club abbreviation and a sequential number, i.e. PCMRC #2. I used a Brother P-Touch machine to make the labels and affixed them to the top of the cab [10].



The next requirement was to get both the AirWire loco board (either miniCONVRTR or G3) and the cab onto the same frequency. I read the instructions and tried several different methods with little success.

Here's what I did that really worked and was easy.

10. P-Touch label on the AirWire throttle to differentiate ownership and channel.

1. Make sure that there are no other AirWire cabs turned on in the area. Also no other transmitters on the 900 MHz frequencies, like NCE or Digitrax simplex radio cabs.
2. Turn on the loco and the cab and verify that you are controlling the loco.
3. Press the green PWR key and then the 4 key. This will put you into Service Mode programming. The display should look like this:
SV-CV - - - -
4. Key in the CV to change frequency (58). Now the display should be:
SV-CV - - 5 8
5. Press the ENT key. Display should be:
SV-CV 0 0 5 8
Value - - - -
6. Key in the desired frequency (0 to 16 are viable numbers). I was programming #2, so the display looked like:
SV-CV 0 0 5 8
Value - - - 2
7. One more press of the ENT key and the cab and the loco are on the new frequency. You can verify the frequency of the cab: the lower left portion of the basic display will show the frequency. In this case, it shows:
RF02
8. You may have to cycle the power on the loco (unplug the battery and reconnect it) before the radio channel changes.
Verify that when you use the cab, the loco responds.



MR. DCC'S WORKSHOP CONTINUED...

Photo [11] shows the T5000 display panel. Note the RF02 in the lower left.

It is that simple.



11. AirWire T5000 throttle on channel 02.



[Click here for reader comments](#)

Great control in a tiny package



**Original
Touch Toggles**

- Touch Toggle™ plug in controls
- Bright clear indication
- Easy setup
- Flexible system

Stall Motors, Twin-coils,
Power, and Servos

Now for Tam Valley Depot
and MRservo too!



Made in the USA



What will they think of next?

www.berretthillshop.com

IOWA SCALED ENGINEERING

Infrared
sensors!

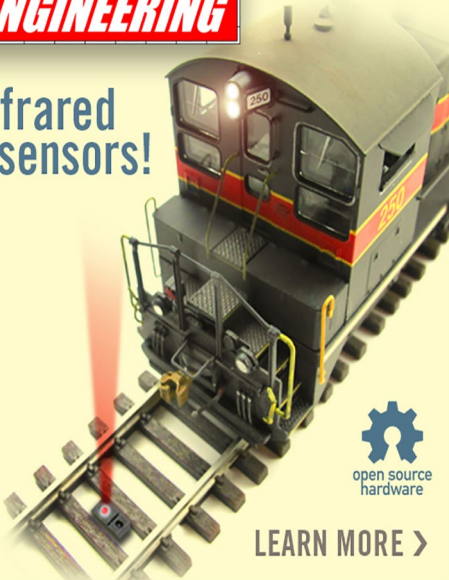

open source
hardware

LEARN MORE >

TamValleyDepot.com

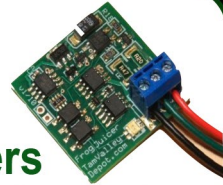

Frog Juicers

Automatic DCC polarity reversers for
frogs on turnouts and crossings.

Servo Switch Machines

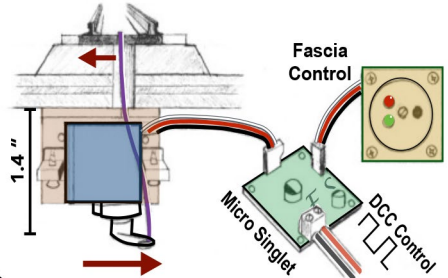

From first train set to railroad empire...

*Our complete line of DCC products
grows with you. Discover the fun!*

- Designed and manufactured in the U.S.A.
- Preferred for ease of use and ergonomic design
- Unlimited scalability for any size model railroad
- Plug-and-play means more time running trains
- Great customer service and excellent support



See your dealer



Visit our new and improved web site for all your DCC needs!

- Get the latest new product announcements
- Watch our detailed how-to videos
- Browse the all-new Information Station
- Enjoy secure online sales, day or night!

Visit **ncedcc.com**



• [INDEX](#)



[SUBSCRIBE](#)
(free)

• [TABLE OF CONTENTS](#)



S T A T I O N

NCE
The Power of DCC

DiGiTrax
Complete Train Control

Tsunami 2

LOKSOUND
SELECT

TRAIN CONTROL SYSTEMS

Model Railroad Technologies Accutrack Speedometer 2

Wow!
Only \$64.95



- Click here to visit our website -

www.LitchfieldStation.com
623-298-7355

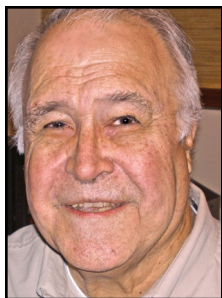

LITE AND NARROW

column

LARRY SMITH
.....

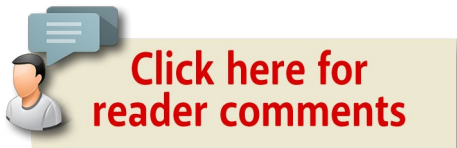

TWIN SEAM MINING COMPANY | A SHAY-OPERATED COAL RAILROAD, BELIEVE IT OR NOT ...

DECEMBER 29, 1962: THIS DATE WOULD BE THE last day of operations for the Twin Seam Mining Company. The US Army Corps of Engineers planned on confiscating, through the power of eminent domain, the western third of the railroad for the construction of the Holt Dam on the Black Warrior River.

Using Shay No. 5, the crew had assembled a 20-car train of loaded hoppers to take to the interchange track with the Gulf Mobile & Ohio at Fox Junction. Once delivered, the locomotive would return to Kellerman to pick up the rest of the loaded cars, and take them to Kellerman, and then operations would shut down.

The 16.5-mile railroad had four tunnels and 23 trestles on the line. One of the trestles was 250 feet long and 100 feet high. It is interesting to note that 21 of the 23 trestles crossed the same stream!

▶ RAMBLINGS ON THE NARROW GAUGE

LITE AND NARROW | 2

Fire was always a danger to the line, so the Shays were equipped with homemade spark arrestors in their diamond-shaped stacks. Additionally, a crew speeder was always kept patrolling the tracks. The railroad never owned any cabooses, so the conductor always rode under the slope sheet of the last hopper car.

That morning, the train had gone from Kellerman, and was crossing trestle number 12 at Daniel Creek (Peedee Creek, as it was known to the Twin Seam), near Searles, AL.

As the train crossed the trestle, something didn't feel right. The popping sounds of bolts pulling out of wood cut through the air and the bridge swayed slightly as the cars started rolling across.

Then, as if in slow motion, the trestle began to give way under the last three cars of the train! The conductor jumped off the last car and ran to safe ground beyond the end of the bridge, then turned to watch in horror as the last three cars crashed to the ground under the trestle. One end of the bridge was completely gone, and nothing



1. Wreck at trestle #12 taken two days after.
Tom Lawson photo, David Price collection

LITE AND NARROW | 3



2. Wreck at trestle #12 from a different angle, taken two days after. *Tom Lawson photo, David Price collection*

remained of the stringers, ties, or rails.

The engineer took the remaining 17 cars to Fox Junction and dropped them in the siding for the GM&O to pick up. Going to a nearby telephone at the lockmaster's home for Holt Lock Number 4 on the Warrior River, he called back to Kellerman

and told them what had happened. Supposedly he was told to drop the fire in the locomotive and go home – you're done. Within four months, the trackage was pulled up and the line was gone.

So ends the story of a unique shortline..

A brief history

In the November 2013 issue of *The Sandhouse*, a newsletter published by the Mississippi Great Southern Chapter National Railway Historical Society, J. Parker Lamb, a noted southern railroads historian, wrote an extensive article on the history of the Twin Seam Mining Company. Interspersed with the history

LITE AND NARROW | 4

are personal experiences of his visits to the railroad in the 1950s and early 1960s.

From this article, I extrapolated the history of the line which drew its roots from the Mobile and Ohio Railroad dating back to 1898. The Mobile and Ohio was chartered in 1847 to construct a railroad from the port of Mobile, AL to Cairo, IL.

Never really a money-maker, the M&O came under the control of the Southern Railway in 1901; however this wasn't until after the M&O built a line and began operating it from Columbus, MS to Montgomery, AL.

There were and still are major coal deposits in that region of Alabama, so the M&O built two coal branches to the new mines

Did you see this MRH video?



**Making zillions
of great-looking
trees quickly ...**

Watch the video now



LITE AND NARROW | 5

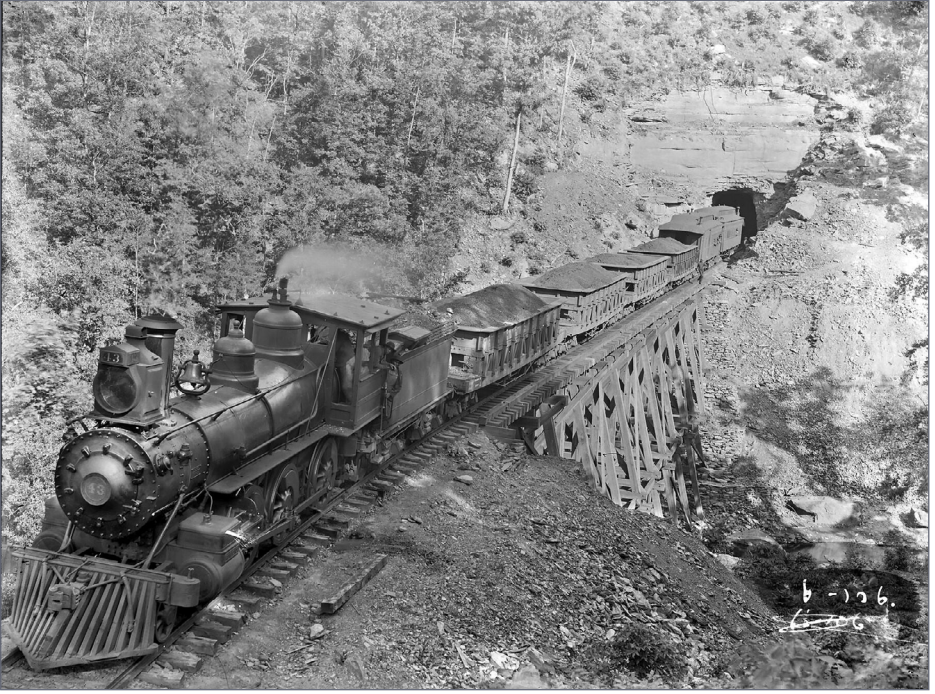

3. Warrior Southern freight exiting tunnel #3 west bound to Holt. *University of Alabama archives. David Price collection*

in the area. They were from Tuscaloosa to Searcy (9.5 miles) and from Eoline to Blockton (11.8 miles). Searcy was later designated Fox Junction.

Central Iron and Coal was formed April 1, 1899 when a group of Eastern business men conceived the idea of consolidating the nine small plants that were producing all the cast iron sanitary pipe and the fittings made in the US into one company, known as Central Foundry Company.

A major consumer of pig iron and coke, and to avoid the fluctuations in the unstable iron market, the company decided to

LITE AND NARROW | 6

produce their own raw materials. To do this they formed the Central Iron and Coal Company, a wholly owned subsidiary of Central Foundry Company.

Choosing a site at Holt, in Tuscaloosa County, a few miles north of the city, Central began construction of a blast furnace in the latter part of 1901. They also built a battery of 164 beehive ovens adjacent to the furnace which went into operation in 1903. They were of a design that utilized the gas under the boilers from the blast furnace. The furnace went into blast on August 1, 1903 and the first pig iron cast on August 3.

Coal deposits were found around 1900 at Lodge's Mines 16 miles from Holt. The town was renamed Kellerman in 1902 when the post office was opened. It is speculated that the town was named after a civil engineer at the mine.

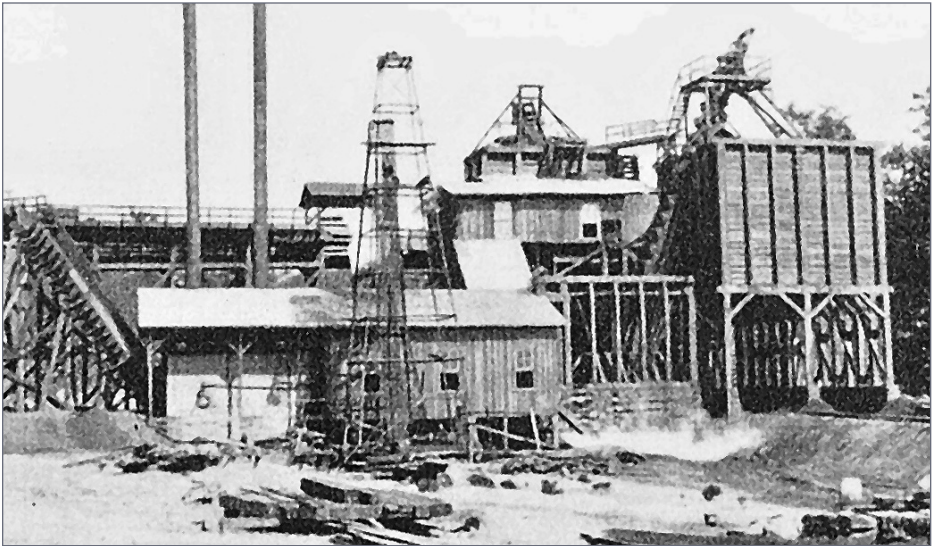

4. Twin Seam (Central Coal and Iron) tippie and washer Number 1. *Department of the Interior Bulletin 400 dated 1910*

LITE AND NARROW | 7

Convenient to the coke battery at Holt, Central Iron and Coal purchased the property; however the mine couldn't be opened due to the lack of rail service. To serve the mine, the M&O formed a separate company and constructed 13.7 miles to Kellerman. The extension, known as the Warrior Southern Railway was completed in 1903 and the mine opened.

This area of Alabama is located in the foothills of the Appalachian Mountains, with rivers and creeks cutting through them, thus making the construction of the railroad very difficult. When finished, the railroad had four tunnels and 22 timber trestles, with sharp curves in many places. One trestle was 250 long and 100 feet high. Some of the trestles (21 of them in fact) crossed the same stream.

Model Railroad Hobbyist magazine™

YES, subscribing MATTERS!
(even though it's free)

**It helps MRH get more
advertisers**

[Click here to subscribe!](#)

• [INDEX](#)



[SUBSCRIBE](#)
(free)

• [TABLE OF CONTENTS](#)

LITE AND NARROW | 8

The Warrior Southern operated the line with 2-6-0s, sometimes double-headed, not because of the grades, but because of the tonnage. This practice continued after the railroad was sold to Twin Seam Mining Company.

The Central Foundry Company began to fail as early as 1924, when the Valley View mine on Red Mountain in Birmingham

was closed. Never using more than 40% of the output of the Holt furnace, the remainder being offered on the open market, and combined with the weak economy, the company's financial picture became dimmer.

Holt furnace was blown out August 29, 1929 leaving the coke ovens and the Kellerman mines still in operation. This too ended in 1932.

5. Twin Seam tipple and washer Number 2 taken two days after shutdown.

Tom Lawson photo



The MRH Media family

Model Railroad Hobbyist magazine™

mrhmag.com

store.mrhmag.com

Model
Railroad
Hobbyist
Store

Brought to
you by

MRH
MEDIA

trainmasters.tv



Shop the MRH Store ...



Model Railroad
Hobbyist *Store*

Helping you achieve your model railroading dreams



Search

MRH Storefront

About MRH Store

Contact MRH

Cart (0)

Welcome to the Model Railroad Hobbyist *Store*



Problems with an order? Call 800-920-6020 for help during US business hours.
Or email store@mrhmag.com any time.

Select the category you want to browse:



Videos



Books



Downloads



Other

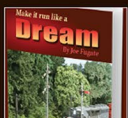
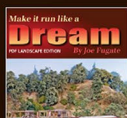

• INDEX



SUBSCRIBE
(free)

• TABLE OF CONTENTS

LITE AND NARROW | 9

1940 was a critical year for both Central Foundry and the M&O railroad. In early 1940, the Central Foundry Company became insolvent and was sold on September 4 in federal court to Associated Metals and Mineral Corporation of New York City. This included the Kellerman mine as well as the Holt furnace and the by-products ovens.

1940 also saw the end of the Warrior Southern Railway. This came about when the M&O merged into the newly formed Gulf, Mobile, and Ohio Railroad. However the WS didn't disappear, and wasn't abandoned. Only the name changed.

It was sold to the Twin Seam Mining Company, incorporated April 1, 1937, in Tuscaloosa, Alabama, and became a private railroad, not subject to ICC oversight, serving the tippie and



6. The loco shops at Kellerman with Shay No. 8 under the hoist and Shay No. 5 next to it. *David Price Collection*



7. Shay No. 5 taking on water at the Kellerman water tank. The tank is a converted tender with a spout added.
John C. Hawkins photo, hawkinsrails.net

washer at Kellerman. This private status led to some very interesting situations occurring on the railroad, as you will see later, and makes for great modeling ideas, although maybe not so great in the real world.

The Twin Seam Mining Company

The grades on the Twin Seam were fairly low, at least down-grade from the tipple, so the company purchased a pair of ex-M&O 0-6-0s from the GM&O. The two locomotives were deemed surplus by the railroad and were on the scrap line, but they were ideal for the Twin Seam. They also purchased a 2-6-0 from Alabama Central Railway (Autauga County).



LITE AND NARROW | 11

The Kellerman mine was a drift mine with underground trackage. Compressed-air locomotives were the motive power for the underground trains. By 1946 the seam was mined-out and coal production ended at Kellerman and the mine was abandoned. A new tipple and washer was soon built 2.5 miles to the northwest, and connected to the earlier line by a spur.

As mentioned before, the original WS line passed through four tunnels and crossed 22 timber trestles, the longest of which was 250 feet long and 100 feet high. The new branch was in terrain even more tortuous than the original line, and contained four percent grades on each side of the crest that separated the old and new washer facilities.



8. Shay No. 5 at Kellerman. Tipple and Shay 17 are in the background. August 1961. *William G. Gordon photo*

LITE AND NARROW | 12

These added barriers required another trestle over what was called by locals the Kellerman super highway. The trestle was the only one on the railroad that had steel and concrete components. The new extension put an end to the rod engines operating on the railroad, as they were unable to operate on the grades with any kind of loaded cars.

The first Shay to arrive on the property was Number 17. It was a class 90-3 built by Lima #2863 in 1917. This was a 90-ton three-truck locomotive. It was also the first locomotive to have the Lima diamond-shaped builder's plate. The Cherry River Boom and Lumber Company in Richwood, WV first owned the locomotive. It arrived on the Twin Seam property in 1946 and operated until 1953.

**Did you know
there's an
MRH index
available?**

CLICK TO FIND OUT MORE

• [INDEX](#)



SUBSCRIBE
(free)

• [TABLE OF CONTENTS](#)

LITE AND NARROW | 13

Shay Number 8 was purchased in 1948 from Scotch Lumber Company, their Number 8, at Fulton, AL (Alabama & Tombigbee Railroad). It was a class 70-3 built by Lima #3195 in 1922. This was a 70-ton three-truck locomotive.

The locomotive had been dormant since the sawmill at Fulton burned in 1935. The sawmill was rebuilt, but the company abandoned all rail operations, and turned to trucks instead. The locomotive was journal-deep in mud when Twin Seam rescued it. It was rebuilt and placed in service in 1953. It, like all of the other locomotives, was scrapped at Kellerman shortly after the shutdown.

Shay Number 5 was purchased in 1958 from the Meadow River Lumber Company in Rainelle, WV, their Number 5. It was a class 70-3 built by Lima #3247 in 1923. Like Shay Number 8, it was a 70-ton three-truck locomotive.



9. Shay No. 17 appears somewhat dismembered at Kellerman. *Caption and photo by William G. Gordon*

LITE AND NARROW | 14

The locomotive was purchased new for the Winchester and Western Railroad in December 1923 and came to the Meadow River Lumber Company in 1926. It was retired in 1958 when the Meadow River dieselized.

The trip from West Virginia to Alabama was arduous to say the least. While the locomotive had recently been shopped and was in running condition, it was limited to a top speed of 20 miles per hour as it traveled over three class I railroads, the Chesapeake and Ohio, Southern, and Gulf, Mobile and Ohio.



10. Shay No. 17 sitting at Kellerman. It was the only Shay to have lettering and numbers applied.
John C. Hawkins photo, hawkinsrails.net



LITE AND NARROW | 15

The routing would take it from Rainelle, WV to Lexington, KY on the C&O and the Southern from Lexington to Tuscaloosa, AL and finally on the GM&O to Fox Junction. With the speed restriction, it was tacked onto the rear of locals for the whole distance of 750 miles.

Master Mechanic, A.B. Barton traveled with the locomotive and lived in the boarded-up cab for the two-week journey, fraught with delays due to missed connections. Each time the locals would stop for work, he would climb down from the cab and make sure the journals were packed with waste and oil to prevent them from burning up while en-route.

Finally on March 15, the locomotive arrived on the property, and two days later was put into service, relieving a very tired Number 8 for repairs.

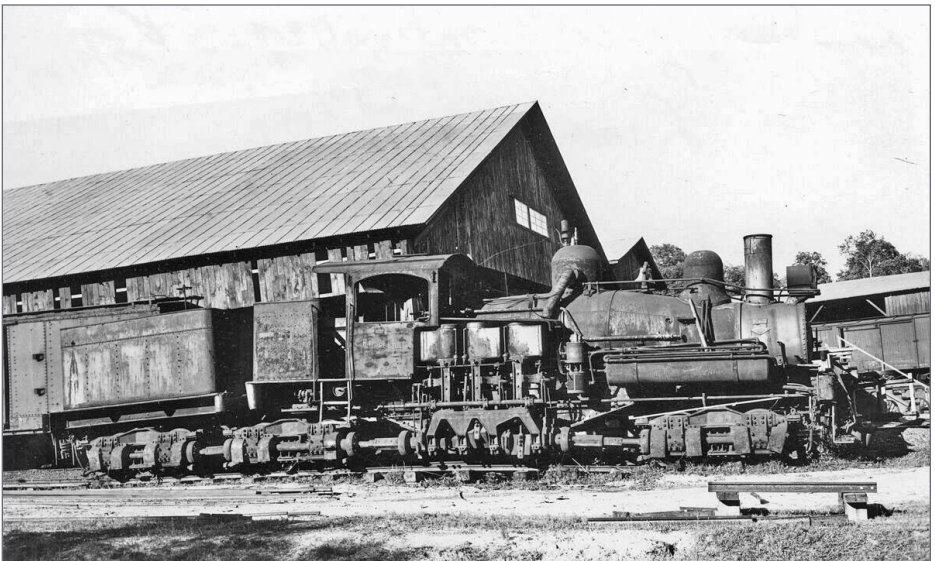

11. Shay No. 8 at Fulton, AL 1947. Surprising that it escaped the scrap drives of WW II. *C.W. Witbeck, Phillip Kotheimer Collection, published on Mississippi Rails*



12. Shay No. 5 crossing the Kellerman “super” highway. This is the last trestle built for the extension to the new tippie. It is the only one with steel and concrete used in its construction. *Photo by John B. Charles, used with permission*

Trackage on the Twin Seam was very light, considering the tonnage the railroad hauled. A normal train was 20 55-ton hopper cars. The new extension used 70-pound rail, while the rest of the railroad was 50-pound rail. To say that derailments were frequent would be an understatement. Several of them had some interesting outcomes.

Midway on the railroad was the old M&O water tank the railroad used. A cut of empty cars got loose near there and started rolling downgrade. After gaining speed, they left the track and began ricocheting off the sheer cliffs next to the track and then went down a 15-foot embankment.

LITE AND NARROW | 17

The Twin Seam's only wreck crane consisted of a block and tackle to retrieve the cars, so when the wreck crew arrived at the scene and saw there was no place to attach it, they left the cars where they lay. They may be there to this day, under water from the Holt dam.



13. Shay No. 5 required extra sand to move just five loaded cars from the tipple over the 4% grade. The brakeman rode the pilot, pouring sand from a bucket to gain traction for the grade. *David Price Collection*



14. Shay No. 5 is at the engine terminal at Kellerman, AL. Shay No. 17 can be seen in the far background.
William G. Gordon photo

Tunnel Number 1 was the culprit in two incidents. It was the only curved tunnel on the line. It was built in 1903, and never enlarged to handle 1950s longer cars. This also might explain why you never see any 70-ton hopper cars on the railroad.

A GM&O inspection car went on the line – why, no one knows for sure. It got to tunnel Number 1 and got wedged in the tunnel. Several hours later, it was drugged out with a lot more dents and scratches than when it went in.

Another incident happened at tunnel Number 1 on a hot September day, and was witnessed by Tom Lawson and others. The way the story goes, Shay No. 5 had already gone through the tunnel when there was a derailment in the tunnel, with a hopper

LITE AND NARROW | 19

car becoming wedged. Again it would take several hours to get the hopper loose and back on the track.

A local motorist offered the engineer a cold drink from a cooler he had in his car. The engineer declined, saying he'd already had five beers and was good! (You can read similar stories from Bill Gordon in the captions.)

There is one story of a wreck that occurred that could have only happened on a private railroad. Tuscaloosa County was a dry



15. Shay No. 5 at Kellerman, Alabama. Notice all of the junk and clutter on the ground, typical for a shortline that was private. Notice also the headlight. This was taken from a Frisco locomotive. The entire smokebox front on No. 5, including the door and number plate, was taken from Meadow River Lumber Shay No. 2. The shop in Rainelle cut a flat plate to cover the number 2 and installed the number 5 seen in this image. *William G. Gordon photo*



16. Shay No. 5 at Kellerman from the other side. Again notice all of the junk lying on the ground. *William G. Gordon photo*

county, as in no alcohol. This fact never stopped the moonshiners from pursuing the trade. Early stock car racing has its roots in moonshiners running their hot cars full of product and being chased by the law.

A.B. “Buck” Barton was Twin Seam’s resident locomotive repair and maintenance man. However he also was the premier bootlegger in Tuscaloosa County. By the end of the 1950s, he was working for the railroad only three days a week and on the other days kept busy providing top-quality shine to the county.

As it would happen, Shay No. 5 stubbed her toe about a mile south of the old Kellerman tipple spur, in 1960, and nose-dived into the kudzu, creeper brush, and vines covering the side of a steep hill on the locomotive’s right side. The loaded cars pushed the Number 5 almost crosswise to the track.

LITE AND NARROW | 21

Two of the loaded hoppers behind the locomotive jackknifed into the open cornfield on the other side of the track.

When the dust settled the superintendent, End Hamaker, and the fireman, Lasco Reed, decided to go find Buck. This also just happened to be one of Buck's off days from the railroad and he was out "quality checking" the latest batch of his new product.

When they found Buck in the woods behind his home, he could barely stand, much less walk. They dragged him out to the pickup truck, put him in the back, and took him to the wreck site. Supporting him between them, they walked him over to the wreck.



17. Shay No. 5 drifts through the sag leaving Kellerman before starting the pull up to the summit tunnel in September 1961. This is one of the few locations along this 15-mile line that was not closely enclosed by foliage. *William G. Gordon photo*



18. Shay No. 5 switching hopper cars at Holt, (Fox Junction). The front number plate seen here was no longer on the loco on Bill's next visit. Photo ca. 1960. *William G. Gordon photo*

Asking him what to do, he said there was room to build a track around this mess and to call Tommy Lawson to get a new Shay. (Tommy owned a used-locomotive business.)

The call never came, and the “wrecked” Shay worked on for two more years before the bridge disaster.

Modeling the railroad

To model the Twin Seam, you need three locomotives: all Shays, of course. One of the Shays needs to be a Bachman 90-ton and the



LITE AND NARROW | 23

other two Roundhouse 70-tonners. The Roundhouse Shays are now available from Wiseman Model Services.

You would also need a speeder as a track-inspection car to look for fires.



19. Shay No. 5 at the water tank at Daniel Creek near Tuscaloosa, AL 1962. A Twin Seam Mining company coal train is drifting down to the old Mobile and Ohio water tank along Daniel Creek. A crewman atop the train is signaling for the stop. Although long neglected, the tank still held enough water to serve the Shay.

This was a place difficult to access. Hike two-and-one-half miles, cross twelve trestles, and stumble through four tunnels. The front number: Someone had removed the number plate from shay number 5, so I chalked my own number onto the smokebox. The chalk number survived for several years.

Caption and photo by William G. Gordon

LITE AND NARROW | 24

And you will need lots of 50-ton hoppers.

The rail would be code 55 flex for the most part, except for the new tipple trackage, which would be code 70. The tipples will have to be scratchbuilt.



20. Although it may look like fuel, Twin Seam Mining company Shay No. 5 is getting water near Holt, Tuscaloosa County, AL. Body of water behind the locomotive is the Black Warrior River, which at the time was impounded by the old dam at Lock 14. Today, the area where the tracks are seen has been flooded by a new higher dam at Holt, as part of the Tennessee-Tombigbee Waterway.

Aug. 1962 photo William G. Gordon



LITE AND NARROW | 25

Water tanks are available, although you need to kitbash one into the proper water tank. The old M&O tank can be modeled using BTS McCabe Lumber open-top tank. The yard tank can be kit-bashed using Bar Mills Hank's Fuel Company.

For the many trestles, you can purchase plans or kits from Black Bear Construction and build them with your own jig, or just use their jig. From the text you can see that you have lots of choices as to length and height. You almost certainly will need to selectively compress the number of trestles.

A great mini-scene scene can be developed around the moonshining operation. At least three companies have a moonshine still available. Rusty Rail (cast scene), Catzpaw (3D-printed), and Showcase



21. Shay No. 5 is at Holt (Fox Junction), interchange, arranging a string of empty cars for the mine at Kellerman. September 1960. All hopper cars are two-bay. Perhaps operation was limited to 50-ton cars, since many trestles on the line were becoming decrepit. *William G. Gordon photo*



22. Perversity of Shays. Experience shows that Shays most often operate with the interesting engine and gears on the side away from the photographer, and when not on the wrong side, engine and gears will be in shade. Twin Seam Mining Shay No. 5 outbound with loads from Kellerman, crossing the 13th trestle up Daniel Creek from the Black Warrior River, Tuscaloosa County, AL. September 1960
Caption and photo by William G. Gordon

Miniatures (metal castings). You could use a Woodland Scenics auto with the trunk up and loading jugs or have one on the road followed by a police car. This would add some nice detail to your layout.

This layout would be a perfect one for TOMA (“The One Module Approach”). Start with the tippie end of the layout and build the steep grade up and over the ridge.

The real railroad never could get more than five loaded cars over this ridge at any given time. They would bring them over

LITE AND NARROW | 27

to either a siding near tunnel 4 or the tipple track. They would then assemble the train into a 20-car train and take it to the interchange.

Section number two and three could be nothing but tunnels and the water tank mid-point on the line, while section 4 would be the interchange track and the notorious tunnel 1.



23. Twin Seam Mining is running late with today's trip out of Kellerman. Daylight was mostly gone. Thinking...if I can't get a photo, at least wait and watch them run...when Shay number 5 quietly drifted onto this trestle at the lower end of Daniel Creek. One tunnel was ahead on the run down to Holt, on the Black Warrior River. Number 5 still has its original front number plate in this 1959 photo.

Caption and photo by William G. Gordon

LITE AND NARROW | 28

If you build it, please let us see some pictures of your work, either finished or in progress! ✓



[Click here for reader comments](#)



24. Twin Seam Mining Company Shay No. 5 has just emerged from curving tunnel 1, and now eases GM&O coal loads down the grade over one of the big trestles along Daniel Creek, from Kellerman. Brakeman is riding the third car. Twin Seam had four tunnels and several big timber trestles along Daniel Creek. *Caption and photo by William G. Gordon*

More photos following



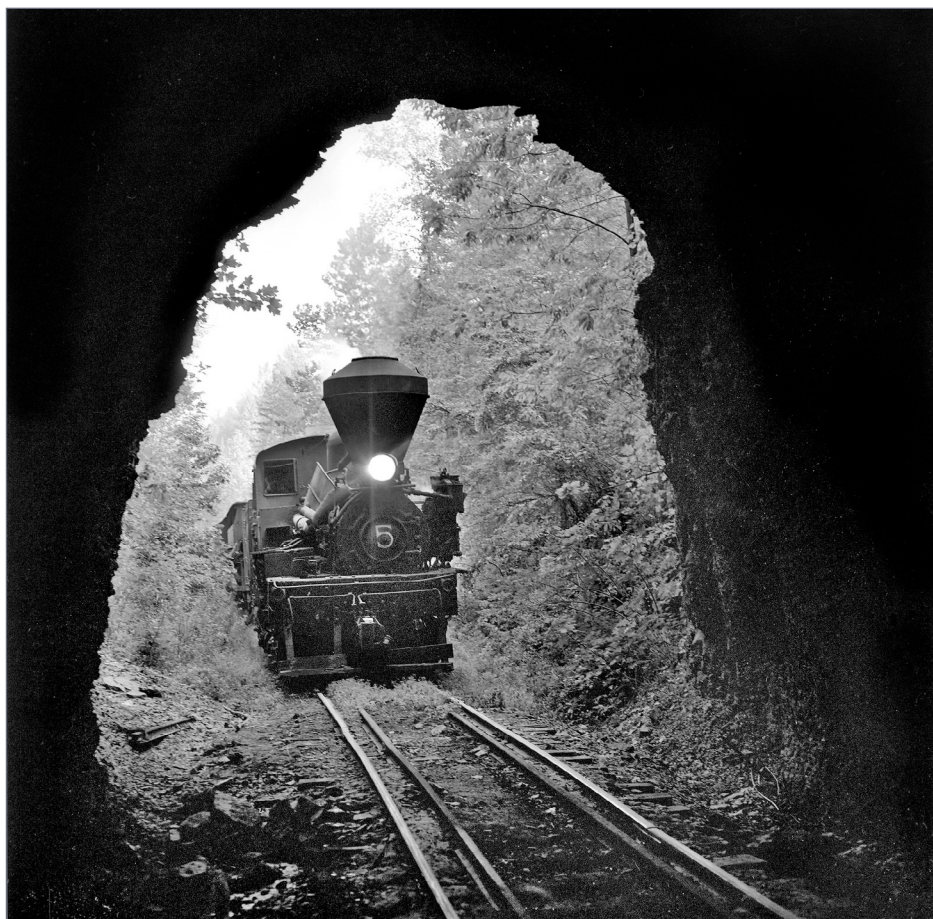

25. Alabama morning mist hasn't yet cleared, and since starting out, the Twin Seam Mining crew has already had to re-rail one hopper car. Here about to enter the first tunnel south of Kellerman (tunnel 4); ahead is bad track, several big wooden trestles, and three more tunnels on the trip down to Holt, (Fox Junction). Note the guard rails inside the tunnel.

William G. Gordon photo

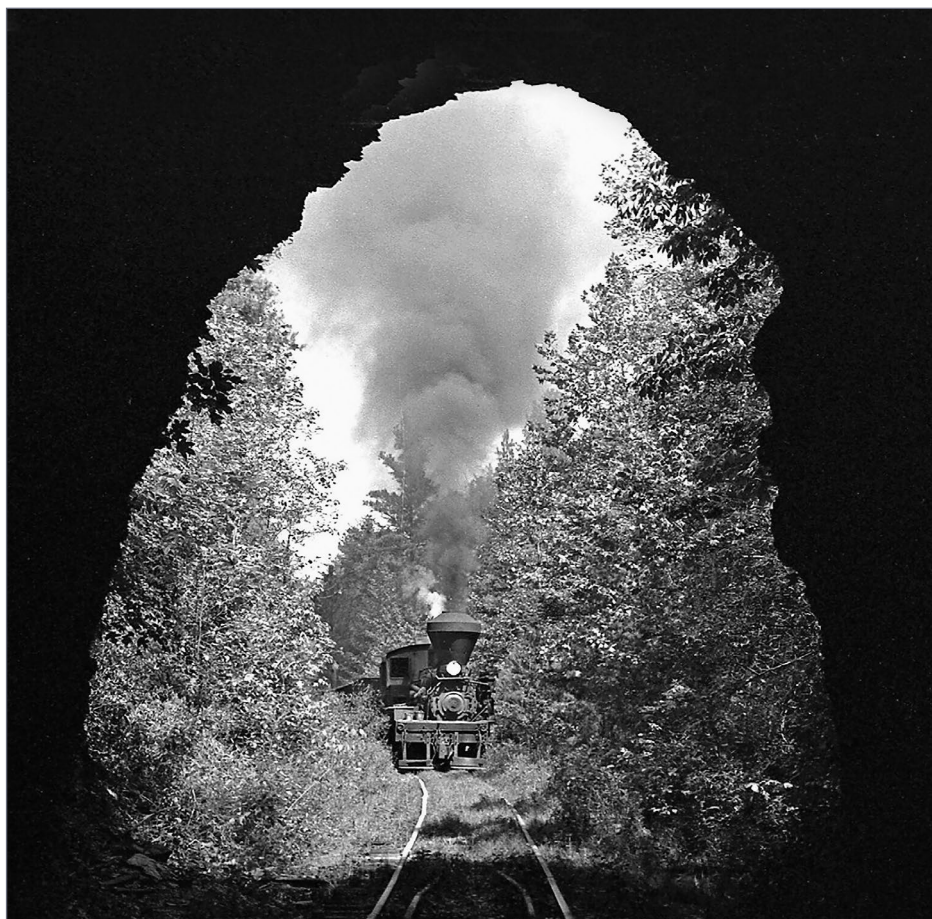

26. Twin Seam Shay No. 5 approaches the entrance to tunnel #4. Don't worry, there was time to get out of the way of the slow-moving Shay. *David Price collection*



[Click here for
reader comments](#)



LITE AND NARROW | 31



27. Twin Seam Mining Company - 5th Daniel Creek Trestle. View west from end of tunnel 3 across the fifth trestle up Daniel Creek. East end of tunnel 2 is in the distance. This trestle is about 350 feet in length. Note guard rails are on the outside of the running rails. *William G. Gordon photo*



[Click here for
reader comments](#)

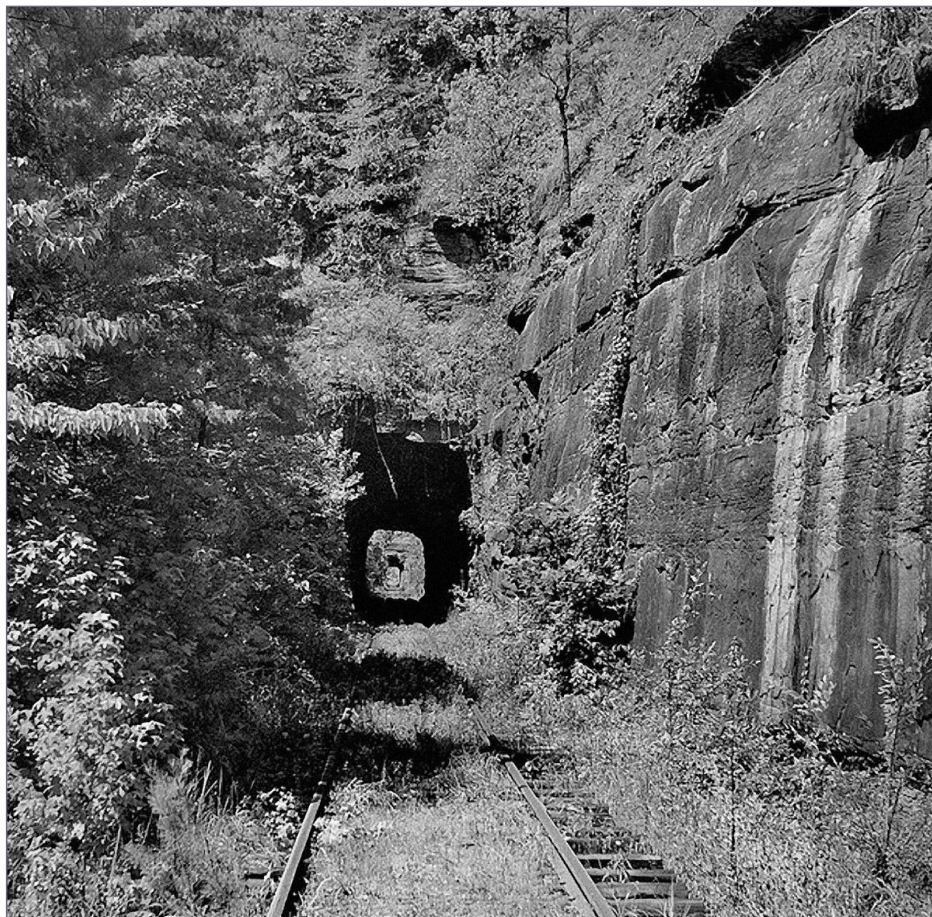

28. View is west into fourth tunnel up Daniel Creek from the Black Warrior River. The third tunnel is seen in the distance through tunnel 4 and across two trestles. Distance to the distant second tunnel portal is about 1500 feet. Tunnel 4 is 300 feet in length, then a 190 foot trestle, then through a cut and across a 225-foot trestle to 500-foot tunnel 3.

William G. Gordon photo



29. Twin Seam Mining 5 is late enough today with the out-bound coal that sunlight has got around to the southwest end of the tunnel. On my first visit to Twin Seam, I arrived after midnight, and slept in my station wagon, on the ridge above this tunnel. Next morning, waiting for the Shay to appear, there came repeated long whistle calls from track north of the tunnel. A coal load had derailed near where the loco appears in this photo, at the north end of the tunnel, less than two miles from Kellerman. The whistle blasts brought men and tools from the mine. This photo was my introduction to the very colorful Twin Seam Mining operation.

Caption and photo by William G. Gordon

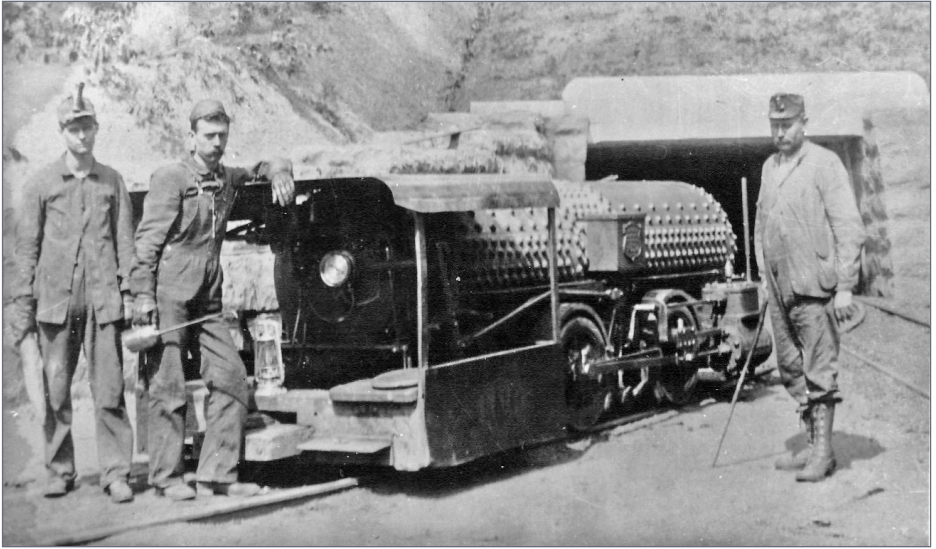

30. Compressed-air locomotive used by Twin Seam for underground operation. Central Coal and Iron 1903. Built by Porter April, 1903 C/N 2720.

Photo courtesy Tom Lawson collection



[Click here for
reader comments](#)



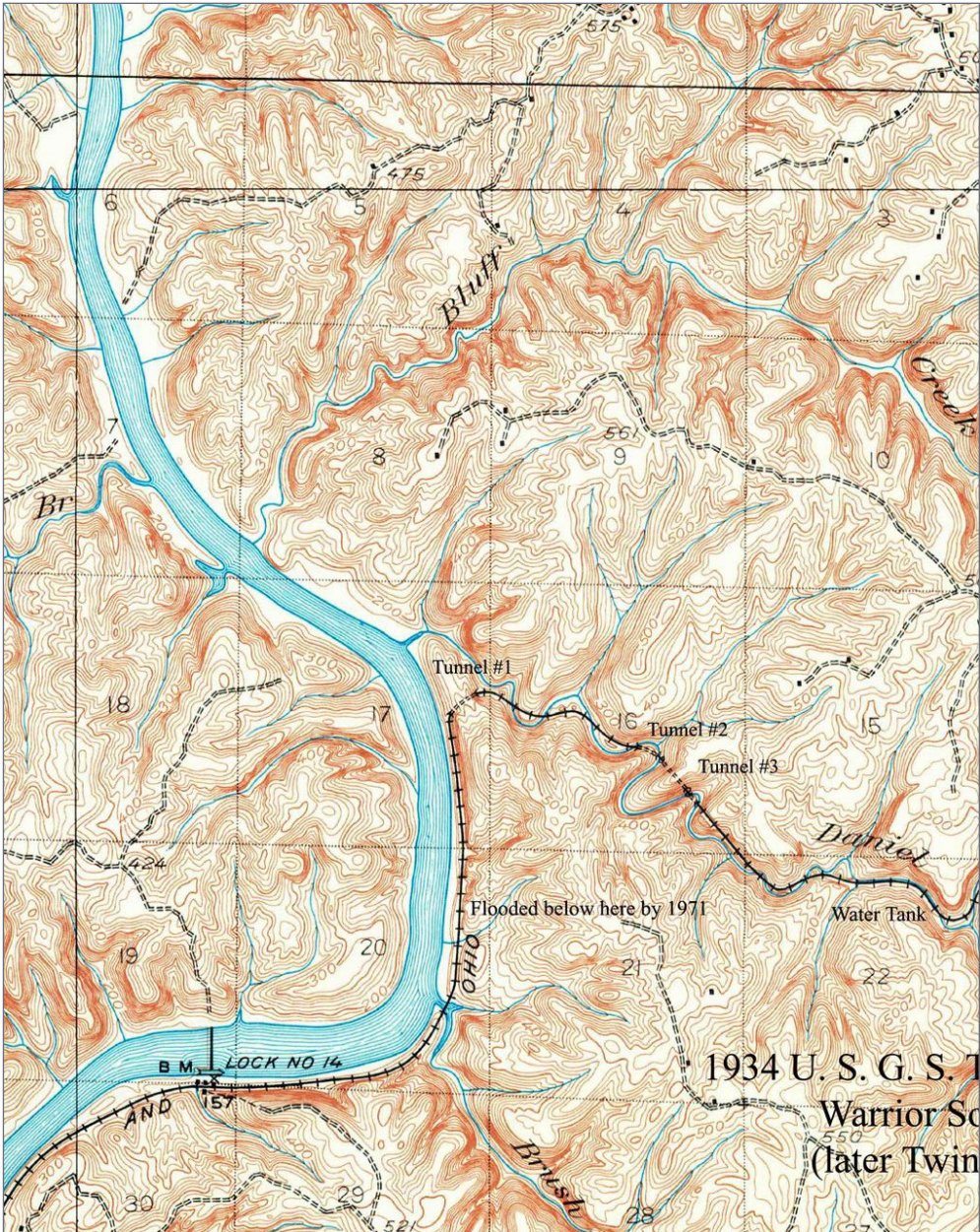

31. A 1934 topo map of the Warrior Southern Railway showing locations of tunnels and trestles



NORTH AMERICAN RAILCAR CORPORATION
 NORTH AMERICAN RAILCAR CORPORATION

Once again, North American Railcar Corporation has pushed industry standards, with the newest addition to our proud line-up of high quality model rail cars!

Pullman Standard 5077cf 50' Single Door Boxcars



Accuracy and Detail... in Scale

Look for these Railways in our first production of 16 Roads



So there it is, a new model, never before done by anyone...



NARC Cars are sold exclusively through

Pacific Western Rail Systems



Model Railroad Hobbyist | May 2017 | #87

WHAT'S NEAT WITH KEN PATTERSON

column

KEN PATTERSON



[Click here to rate or
comment on this article](#)

HOME-MADE LEAVES, MORE BUDDE AUTORACKS, WEATHERED FREIGHT CARS FOR THE MRH TOMA PROJECT, AND A SOUNDTRAXX 2 LESSON ...

THIS MONTH WE EXPLORE WAYS TO MAKE HO scale leaves in HO for use as ground cover under our deciduous forests and in super-detailed foreground scenes.

Mike Budde shows us one of his autorack trains with various loads, trucks and, carloads and auto parts cars. He explains how these trains were used on the railroads in pool service, and how he makes some of the loaded vehicles.

Jeff Meyer shows some weathered freight cars he has just finished for TMTV's TOMA layout project. George Bogatiuk from Soundtraxx demonstrates the process of setting up the Tsunami2 diesel decoder to run and sound just like the real thing.

▶ [PHOTOS & VIDEO OF SUPERB MODELS & METHODS](#)

• [INDEX](#)



[SUBSCRIBE](#)
(free)

• [TABLE OF CONTENTS](#)

WHAT'S NEAT | 2

Also in this month's video, there are some really nice modeled runbys that you simply can't experience in the column text.

Be sure to watch this month's video – it has a total run time of about 30 minutes. By watching it, you will pick up many things you can't get from just reading the text part of my column!

Modeling scale leaves



1. The fastest and easiest way to make scale leaves is to grind up real leaves. If you look at any forest of old growth trees, the ground is covered with four to six inches of fallen leaves year-round. I wanted to achieve this effect on a modeled scene along my mainline.

2. (Top right) Start with a household blender, dry leaves and water. Fill the blender with leaves, fill to the top with water, and blend on high for about one minute. The water pushes and moves the leaves around in the blender. Without the water, the knives just spin without moving the leaves at all.

WHAT'S NEAT | 3



Playback problems? [Click here ...](#)

• [INDEX](#)



SUBSCRIBE
(free)

• [TABLE OF CONTENTS](#)

WHAT'S NEAT | 4



3. Then pour the contents on to a fryer screen to drain the water, leaving a fine mush of ground-up leaves.



4. Dump the leaves in to a roasting pan. Spread them in an even and thin layer along the bottom of the metal baking pan.

WHAT'S NEAT | 5



5. Bake for many hours at a temperature of 200 degrees, to end up with a pan of very dry leaf material. I use a colander with 1/32 of an inch openings in the screen. Sift the dry leaves through the screen onto a clean surface.



6. This will produce HO scale dry leaves with just the right color. Use a colander with larger or smaller openings for other scales. I store this material in empty spice containers until I am ready apply it to my layout or photo diorama scenes.





7. Here I'm sprinkling the leaves on a hill on my layout where I plan to plant a forest of leafless wire trees.

**Want to help keep
MRH free?**

Then *click* on ads!

WHAT'S NEAT | 7

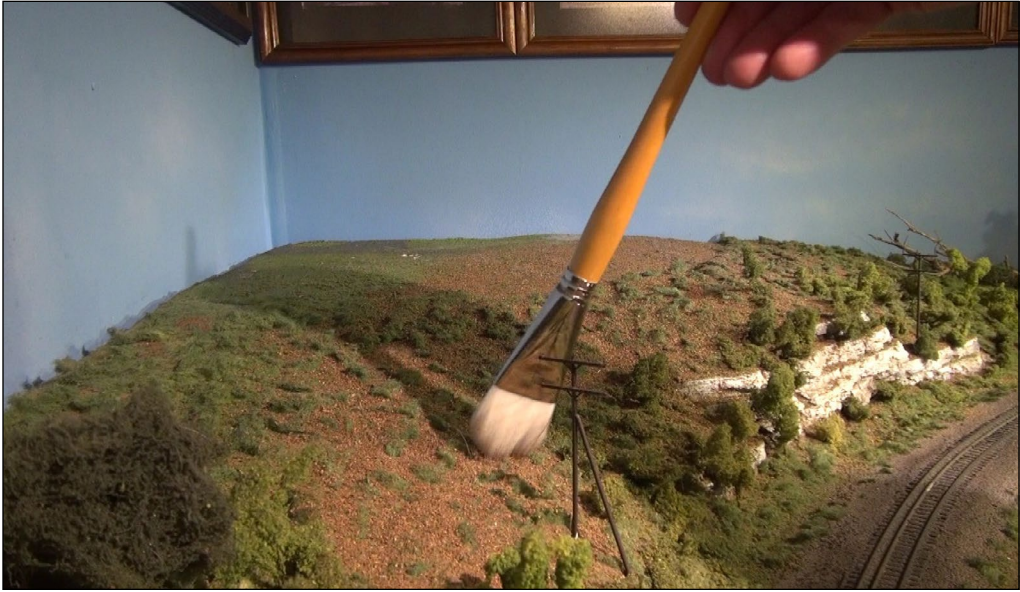

8. Tease the leaf material with an artists brush to allow the underlying vegetation to stand as the leaves settle evenly in the area.



[Click here to rate or comment on this article](#)





9. Once the trees are in place, the dry leaves create an effect that just looks right. You can mist Woodland Scenics Scenic Cement over the leaves to glue them in place. This dry leaf material looks good on the forest floor in summer scenes, fall scenes, winter and in spring.



[Click here to rate or comment on this article](#)

Have you seen this?

**CHECK IT
OUT!**



kenpatterson.com

click here to ...

Visit Ken's website

**Ken Patterson
reveals his modeling
secrets on video!**





10. I used this dry leaf scenery technique on the Midwest Valley Modelers layout in 1993 when the layout had a Fall 1953 theme. The leaves were spread around under the trees, along the roads and on top of building roofs.

11. (Top right) Now, let's say you did not glue your leaves in place and wanted to make changes to your layout. In my case, I use the leaves on a photo diorama and want to remove them after the photo shoot and save them for further use. I accomplish this by stuffing a coffee filter in to the end of my vacuum cleaner hose. Turn on the machine. Pick up the leaves. They are trapped in the coffee filter. Turn off the vacuum and empty the contents of the filter on to a piece of paper to pour into a storage container for use later down the road.



Please tell your buddies about MRH!

WE RELY ON WORD-OF-MOUTH TO GROW AND A BIGGER CIRCULATION MEANS MRH IS MORE LIKELY TO STICK AROUND FOR A LONG TIME TO COME!



WHAT'S NEAT | 11



12. Another way to make leaves is by using a leaf punch from the Green Stuff World website. I ordered one of these and tried it out on paper and dried leaves. It punches out leaves of various shapes measuring nine inches in HO scale, so it may lend itself well to S scale or O scale scenery projects. greenstuffworld.com/en.



**Click here to rate or
comment on this article**

WHAT'S NEAT | 12



13. I prefer Silflor's realistic HO scale leaves. 20 bucks buys a container like this in brown fall colors.



14. The product is a mesh type of material with modeled scale leaves that look amazing. Shake and rub the mesh to release the leaves, then apply them individually along roads, roofs and on top of vehicles.



WHAT'S NEAT | 13



15-16. If you look at the *Model Railroad Hobbyist* blogs you will find Tom Johnson's Logansport and Indiana Northern Railroad. Tom uses Silflor leaves effectively in his super-detailed foreground scenes, along roads and on top of roofs just as you would expect to find in prototype scenes. mrhmag.com/node/8934.

WHAT'S NEAT | 14

Jeff Meyer's weathered freight cars



17. This month, Jeff Meyer stopped by to photograph three freight cars that he weathered which will be displayed on the *Model Railroad Hobbyist* TOMA layout. All three cars are manufactured by Atlas.

TrainMasters TV is part of the MRH product family.

TMTV members not only get great network TV level videos, they help pay for MRH and keep it free ...

• [INDEX](#)



SUBSCRIBE
(free)

• [TABLE OF CONTENTS](#)

WHAT'S NEAT | 15



18. First is a GATX tank car which he weathered around the trucks and underframe. He also applied graffiti markings using decals.



19. The covered hopper is weathered with oil paints. The burnt umber rust streaks were applied with a fine artist's brush. He then applied colorful graffiti decals to make the car stand out.



20. The last car is a Seaboard System boxcar with a wash of oils, underbody dust, and additional graffiti painted in place with a brush.

**Did you know
there's an
MRH index
available?**

CLICK TO FIND OUT MORE



WHAT'S NEAT | 17



21. Mike Budde came by Saturday night with one of his auto rack consists a complete train running empty parts cars with fully loaded auto racks. In the first photo are a few of Mike's racks loaded with AMC Gremlins and Pacers painted in an array of schemes. These cars were available 10 years ago, at Walmart stores across the country. I myself hoarded 14 cases of them – Gremlins, Pacers, pickup trucks, and Ford vans in hopes of modeling an autorack train in the future.

22. (Top right) Mike also modeled racks loaded with Bell System telephone vans. He paints the whole van with "communications gray/greem," then follows up with the white.

23. (Bottom right) Various styles of trucks and vans are loaded on flatcars. One of the trucks is just a frame and wheels with the motor crated in a wood enclosure. Mike models from prototype photos to make up truck loads with correct details.

WHAT'S NEAT | 18



• [INDEX](#)



SUBSCRIBE
(free)

• [TABLE OF CONTENTS](#)

WHAT'S NEAT | 19

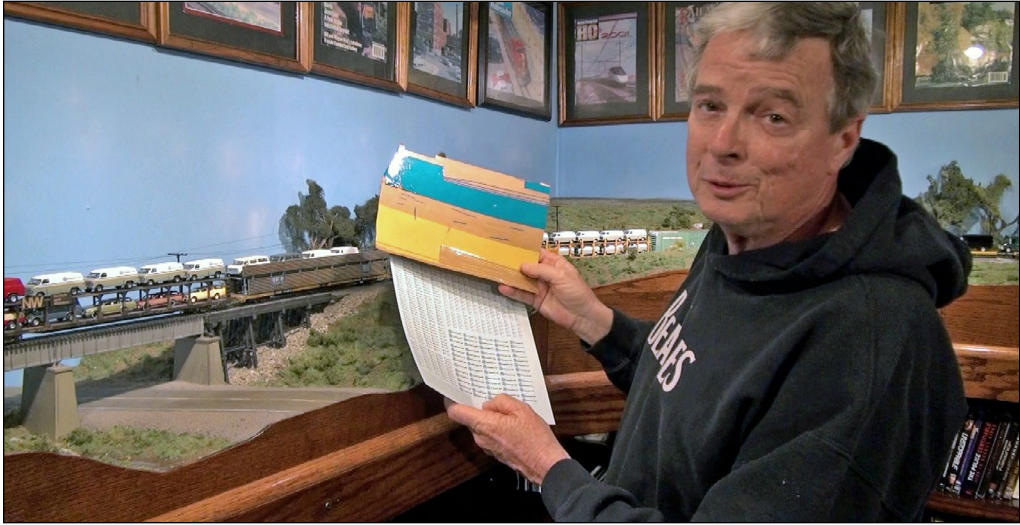

24. For the stripes, Mike cuts strips of reflective tape to match the colors on the prototype telephone trucks. He then attaches the strips to the model along with decals that he made from prototype photographs of 1974-era vans.



25. Here you see a close-up of one of Mike's Bell trucks. He gave it to me as a Christmas gift eight years ago and it was just opened this week to shoot this photo for Mike's What's Neat segment. The yellow and blue stripes reflect light just like the prototype. It looks really neat when the stripes catch the light as a train rolls past.

WHAT'S NEAT | 20



26. Here is a load of Mike's Chevrolet Impala station wagons and sedans. The glass in the windows is clear packing tape applied to the edges of the window frame from the outside.



27. To make the station wagon, Mike cuts up a Mini Metals four-door Impala and adds styrene to form the body of the station wagon. He uses prototype photos as a guide. Mike then makes a rubber mold to cast 12 or so station wagons.



WHAT'S NEAT | 21



28. He then makes various paint styles, striping, and colors, including the wood-grain look applied to many cars of that era. Mike uses Bare Metal Foil for the bumpers and grills. He is working on converting the four-door Impala in to a two-door model to add further variation to his autorack loads.



[Click here to rate or comment on this article](#)



29. Mike models his auto rack trains as per the prototype, in that he has empty auto parts cars mixed in the consist while the auto racks are running full. For the return run, Mike has an auto train with empty racks, flat cars with auto frames, and parts cars that would be running fully loaded to the automotive factory. Mike also notes that Frisco or MoPac racks could be seen running in pool service in California as the railroads worked to maintain the cars from other railroads in service to and from the auto plants.



Tsunami2 Diesel set up



30. This month, George Bogatiuk from SoundTraxx explains how to set up Tsunami 2 sound decoders to sound and run just like the real diesel locomotives they replicate. In the video, he covers the prime mover type, braking, dynamic digital exhaust, bells, horns and the sound car connection and activation.



31. George was in St. Louis to present a clinic at Mark Twain Hobby on programming and operating with the Tsunami 2 sound decoders. Many modelers attended the two-hour presentation on steam and diesel decoders.



[Click here to rate or comment on this article](#)





32. Because the E unit in this demo has two prime movers, George shows how to produce the 567 dual-prime mover sound by setting CV 123. When the model is started up on the layout, you hear each prime mover start up individually. Then he sets the bell type with CV 122. The decoder has 12 bells to choose from. The horn is programmed by setting CV 120 and there are 42 horn sounds in the decoder to match your locomotive.

Programming the DDE or Dynamic Digital exhaust replicates the sounds and behavior of the locomotive depending on the weight of the train and the grades the train is running along. It changes the tone and rpm of the locomotive's sounds to match its running environment. You program this by setting CVs 2.503 and 2.504. To get to the Dot 2 Platform you set CV 32 to 2. This lets you program in the 2 dot 500 series of CVs (2.500). With the locomotive running in notch 1 set CV 2.503 to 255. This allows the locomotive to calibrate its weight running light in speed step 1. Then set CV 2.504 to 255 while the locomotive is running in speed step 20. This allows the locomotive to sense its own gear ratio and weight running

WHAT'S NEAT | 26

light at speed step 20. With this set, adjust the decoder sensitivity to the speed in which it senses changes by setting CV 2.512 to 35. Add a little momentum by setting CV 3 to 75 and CV 4 to 50. You can experiment with these settings until you understand the performance of your locomotive while switching and adjust the CV to your satisfaction.

Tsunami 2 offers two types of train brakes, the automatic train brake that activates all the freight cars' brakes, and the independent brake that is activates only the locomotive brakes. To adjust CVs 117 and 118 to set the brakes push F12 to charge the brake lines. You will hear the compressor charge the line. Then push F11 to release the train brakes as the train starts to move until it levels out at the speed step setting of your throttle. Push F11 again and the train will slow to a stop with the squeal sound of the brakes.

125,000 have seen this MRH video - *have you?*

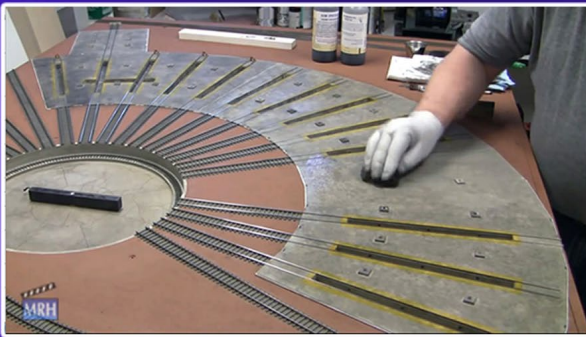

Watch the video now



Click here to rate or comment on this article



WHAT'S NEAT | 27



33. George backs a locomotive up to a car equipped with a Sound Car decoder. He waves a magnet across the roof of the passenger car and pushes F8 four times. This allows the freight car's decoder to look for or sense the locomotive decoder address and start making sounds when the locomotive is activated, to match the speed of the train. It's pretty amazing and watching the whole process in this month's video makes it look easy.



34. Once we have set up our locomotive, George takes the train for a run on the main line, pulling a full load. You can hear the prime mover rpm change as the locomotive pulls the grade on the layout. Add to this the brake sounds, and bells and whistle at the crossing, and we get the full effect the decoder has to offer.



[Click here to rate or comment on this article](#)





MRH MARKETPLACE



TAM Industries

"Preserving the Romance"

The highest quality in Display Cases for sharing your excitement of Model Railroading. We manufacture Display Cases for all gauges of Model Railroading, from "G" to "N". Custom Sizes are available for some styles.



Visit us today at:
www.TAM-IndustriesOnline.com



ITLA Scale Models



*Olympia Tool & Die
HO Scale Laser Cut Wood Kit*

CLICK HERE FOR MORE INFORMATION
www.itlascalemodels.com

CROW RIVER PRODUCTS

HO No. A 442 Clamshell Bucket Pewter Kit

Note: The picture is of an unpainted model.



HO & O Scale Machinery, Derricks,
Engines, Hardware & Waterfront Models
Pawtucket, RI 02861 Tel 401-723-0065
www.crowriverproducts.com

UNIQUE STRUCTURES NEW



click here to

Browse NOW >>



**banta
modelworks**

MRH MARKETPLACE | 2

FEATURING
**America's Historic
Main Street Architecture**



O-Scale model shown (HO available)

**MAINSTREET
HERITAGE**

www.mainstreet-heritage.com

Where the Rail Meets the Sea...



CRAFTSMAN KITS & BUILT-UPS
HO – O – N Scale



H116-HO Tug Exeter

www.seaportmodelworks.com

Click here for our website:



Affordable built to order Benchwork
starting at only \$20 a Sq Ft.

W GOLDEN AGE LINE
WESTERFIELD
MODELS, LLC

**New One Piece Body Kits:
USRA STEEL AUTO BOX
#3000 Series: MC, NYC**



westerfieldmodels.com



**DID YOU KNOW
MRH SUBSCRIBERS
GET FREE BONUSES?**

**CLICK TO SUBSCRIBE
NOW – IT'S FREE!**

• [INDEX](#)



SUBSCRIBE
(free)

• [TABLE OF CONTENTS](#)

MRH MARKETPLACE | 3



MODEL RAILROAD
BenchWork.com

Affordable Modular (domino) Benchwork in 200+ sizes
 Custom built to order benchwork also available!

Yarmouth Model Works
 HO scale resin kits and detail parts

U.S.A. MAILING ADDRESS
 3560 Pine Grove Ave. Unit 617
 Port Huron, MI 48060

TEL: 519-633-7574
 pierre.oliver@start.ca
 www.yarmouthmodelworks.com

CANADIAN MAILING ADDRESS
 85 Hiawatha St.
 St. Thomas, ON N5P 2T5

GOODDEALSdcc
 WWW.GOODDEALSdcc.COM

HOME OF THE
PROGRAMMER TEST TRACK SYSTEMS

DC & DCC COMPATIBLE
 ALL SCALES AVAILABLE
 CUSTOM ORDERS
 DEALER INQUIRIES WELCOME

GARY COHN
 106 CENTER STREET
 FOX RIVER GROVE, IL 60021
 GARY@GOODDEALSdcc.COM

Tree
 coastmans.com HO

clever models LLC
 Cardstock models & materials

Try one today!

www.clevermodels.net

LOGIC RAIL TECHNOLOGIES™
 "Sophisticated Model Railroad Electronics"

Please visit our website and online store!

21175 Tomball Pkwy Suite 287 Houston, TX 77070
 Phone: (281)251-5813
<http://www.logicrailtech.com>
info@logicrailtech.com

PRE-SIZE MODEL SPECIALTIES

P.O. Box 6 Paonia, CO 81428
 Ph. 970 527 4586
 Made in The USA

Cast resin items for All Scales.
 Tunnel portals, bridge piers, abutments, culverts, and retaining walls.
 Trackside details and sage brush tree armatures.

"FREE SHIPPING see website for details"

LOOK
at what's new at
Black Cat this month

Click here for
our website

Rutland 52' gondola decals



Black Cat Publishing
(204)489-5005
ajfergus@mymts.net
blackcatdecals.com



Great Decals!™

FEC, Interstate, Virginian
Railway, & L&N Titles
After Hours Graphics Line
Coupler Gages and More
In O, S, HO, and N Scales



HO DIESEL SUPPLY

KATO EMD SD SPECIALIST-REPAIRS-UPGRADES
New and Rebuilt Locomotives
Powered Chassis-Trucks-Motors
Bodies and Parts-Handrails-Electronics

www.hodieselsupply.com

email:kato@hodieselsupply.com

MOUNTAIN SUBDIVISION HOBBIES

www.modelrrsupply.com

FREE USA SHIPPING OVER \$29.00

NCE - SOUNDTRAXX - DIGITRAX - PECO - CIRCUITRON
DCC SPECIALTIES - INTERMOUNTAIN - CMX - ATLAS
BAR MILLS - BOWSER - KATO - MRC - TOMAR - RIX -
PIKESTUFF - LOGICRAIL - CENTRAL VALLEY AND MORE!

Model Railroad Control Systems

Geoff Bunza Project Boards
DCC Occupancy Detectors
CMRInet Compatible Nodes
Layout Telephone Systems
RFID Switchlist Generator
Switch Machines and Drivers



RULERS-of-the-WORLD

Scale Rulers \$4 each

Over 200+ scales!

Metric or Imperial

www.rulers-of-the-world.com

HOBBY MARKETPLACE

ads are
economical and
effective.

Click HERE to learn more.

PRECISION DESIGN CO.

LASERCUT KITS - CUSTOM DECALS

PDC.CA

Authorized *RailPro* Dealer

FREE SHIPPING in the US and CANADA



Jerry Fasnacht's PENNSY AND READING

BY JERRY FASSNACHT AND
THE MRH STAFF

Photos by Rick Wade



Also on TMTV!

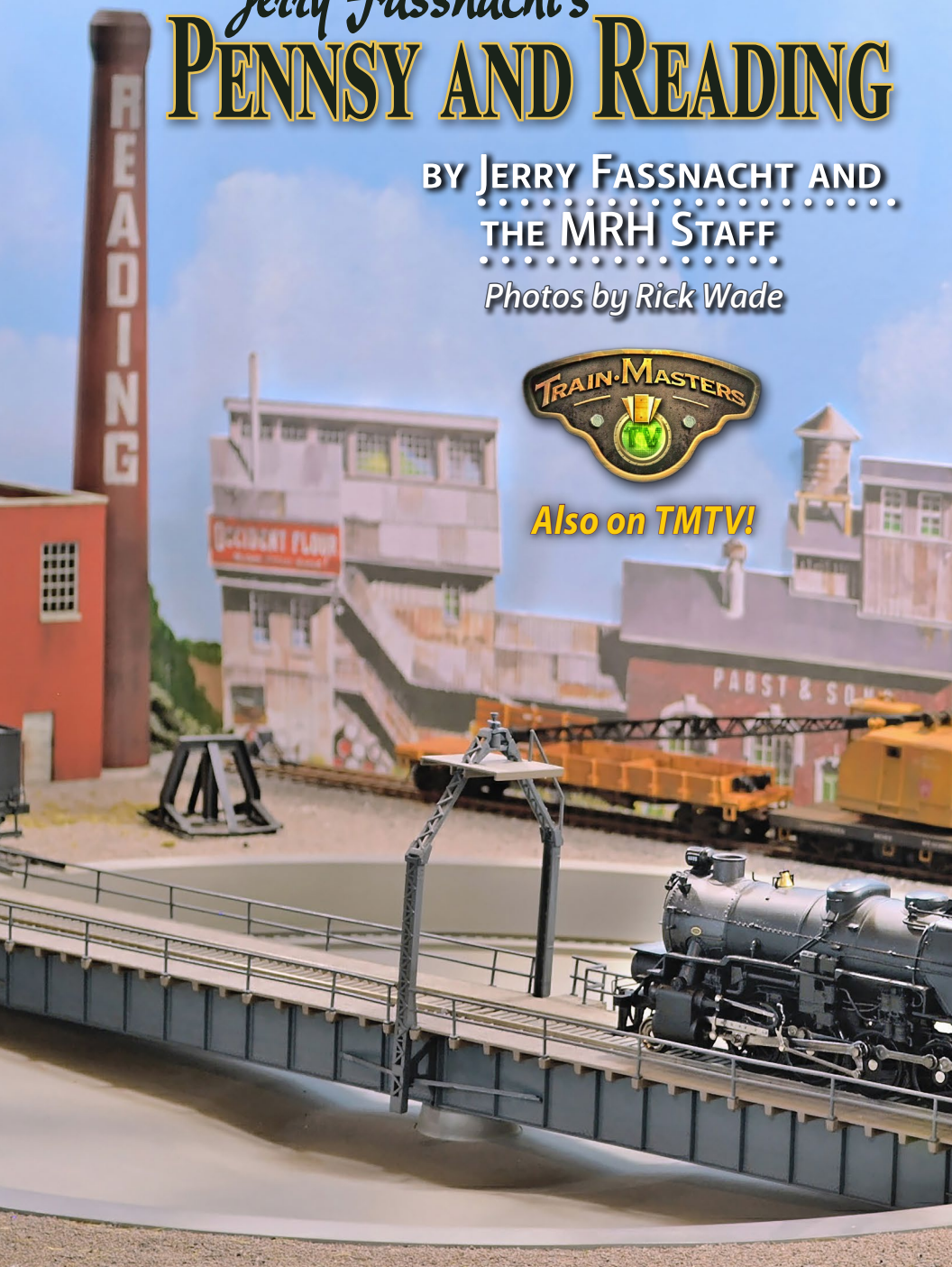

• INDEX

• TABLE OF CONTENTS

On tour at this summer's Orlando NMRA National



[Click here for
reader comments](#)



• [INDEX](#)



[SUBSCRIBE](#)
(free)

• [TABLE OF CONTENTS](#)

MODELING THE SCHUYLKILL BRANCH OF THE PENNSY WITH A FREELANCED READING & COLUMBIA BRANCH ...

MRH: JERRY, GIVE US AN OVERVIEW OF WHAT you're doing here.

Jerry: This is the Schuylkill branch of the Pennsylvania RR with a freelanced connection to the Reading & Columbia branch of the Reading. It models the late '50s, using late steam to early diesel.

It's eastern Pennsylvanian anthracite country through Pottsville, Schuylkill Haven, and New Boston, which is where the coal comes from. We've incorporated our hometown of Ephrata, Pennsylvania. Lancaster and Harrisburg is a separate Reading line to our Pennsylvania railroad. We interchange with Lehigh Valley in Pottsville, in this case.

We service coal to some industries in the Lancaster area from the New Boston area. We run about seven turns to seven different locations. We have an operation that runs around 27 trains in about four hours' time. We need eight or nine operators to run a session.

MRH: You talk about, "We did so and so ..." Who is we?

Jerry: "We" is my brother Jim Fassnacht and me. We started planning the railroad together in 2000, with the building of the railroad starting in April of 2002. He was a track guy for the Burlington Northern railroad during his career, located in the Panhandle of Nebraska. He worked Nebraska, Wyoming, and Montana territories for the BN.

Jim's job included things like hot potting switches to get frozen switch points operating at times like two o'clock in the morning.

“Some of my earliest memories as a child were waking up to hear the coal going down the chute from the coal truck into our coal bunker.”

Jim also helped take care of train wrecks that occurred on the main line. The BN would run their crews out and do a bypass until they could get main running again. Because he was in an area of Nebraska that required coal to always move, they had to keep the trains moving. Jim was very active in that aspect.

Jim's railroad background gave us insight into Burlington Northern practices. Jim also did research on the Pennsylvania way of doing things: clearances, rights-of-way, signaling, and things like that, too.

He had a lot of great experience and a lot of passion for railroading. It really rubbed off on me!

MRH: So Ephrata was your home town?

Jerry: Some of my earliest memories as a child were waking up to hear the coal going down the chute from the coal truck into our coal bunker. We lived half a block from the Reading and Columbia branch of the railroad that went through our home town of Ephrata. At the end of our block was probably 12 to 15 bays of various grades of coal that were dumped at a gravity-feed trestle.

The coal trestle became an important scene and moving coal became a central layout theme. We picked the Schuylkill branch because the end of the branch on the Pennsylvania went through numerous anthracite fields. The Pennsylvania railroad, back in the 1830s, built a line up through to New Boston to reach the coal fields.



JERRY FASSNACHT'S PENNSY/READING | 5

MRH: Seems coal operations loom large on this layout.

Jerry: Yes, we have an industry we serve in Lancaster that takes coal from the new Boston coal fields. We have about 36 cars on three trains that rotate and are in captive service. We have another 18 cars serving industries along the line, one of them being the coal bins I grew up next to in Ephrata.

We selected Reading as our hub, if you will. The Reading company started in Reading about 1830, and then the Pennsylvania came in the 1880s, about 50 years later.

The Pennsy and the Reading were competitors and didn't necessarily get along, but they get along in our fantasy world. They share marshaling and engine facilities as well as car shops. A departure from reality, but that's the beauty of freelancing.

MRH: OK, you're depicting the late 1950s. Why that era?

Jerry: We're actually depicting the summer of 1956. That's partly because we wanted to maintain some steam. RS3s were popular in our area and the RS3s would often tie up in our local town overnight. Trains came a few times a week, and we saw that operation.





2. Pennsy Class "I" Decapod #4695 is inbound for servicing at Reading engine facilities. The coaling tower has seen its share of soot and grime, especially located in the industrial side of town.

We would walk the rails – back then you go almost anywhere. Just get out of the way when the train came! We would drop pennies, metal, or whatever on the tracks to flatten them out. We got along great with the railroad.



MRH: How did you develop the track plan?

Jerry: We were good friends with Gale and Ross Allen, who we operated with on Brad Howard's B & O layout. Gale and Ross owned a layout construction company. We were intrigued by an article we saw on the Florida East Coast Key West Extension that Gale and Ross built for Cal Winters, back in 2000. (Since then, Ross has passed and Gale is now married to Greg Komar.)

It had a room similar in size to ours, it was double deck, had a helix on the peninsula, and allowed for a good bit of running. That track plan became a basis for how we started our plan. Obviously Florida is a lot different than Pennsylvania, and we also wanted more town locations.

In the Schuylkill Valley, we added New Boston, Pottsville, Schuylkill Haven, and then we added a fictitious town named Mount Carbon, which is where we have our coal mine. We moved towns around get an operating scheme that would not put people on top of each other while working towns on different decks.

MRH: Many iterations to get to the final plan?

Jerry: Yes we did. My brother was a dreamer and he had the time to spend on it. There were a few challenges I could see he was creating, such as five-foot-deep switching areas!

How do we support benchwork that wide, and how are you going to reach the back? So we did go through some back-and-forth.

“We found that because we are hilly with a lot of grades, we could end up with areas that were too high to operate in.”

We found that because we are hilly with a lot of grades, we could end up with areas that were too high to operate in. We had to move a town an entire aisle away because we found it was right at the top of the helix and was too high. The helix goes from the lower level to the highest point on the railroad, and then the track comes back down grade on the upper level.

MRH: When did you start construction? How has that gone?

Jerry: We started in April of 2002. We had been building cars and structures for a couple of years, and collecting things. It didn't always go smoothly, no. We had a lot of discussions and we ended up ripping some things out that weren't quite like they needed to be.

We built the helix first and we overcooked that one a bit. I had mounted the support joints on what I thought was the correct grade and we actually created a hump every couple feet. That was murder on cars and was so bad longer cars would uncouple.

It was nasty, so we rebuilt the helix a second time with less support. The second time around the plywood and the rails made the slopes much better.

MRH: What is the grade on the helix?

Jerry: The grade on the helix is 2%.

MRH: What's the grade on the visible railroad?

Jerry: I'd say about one and a half percent is the worst-case scenario. For the most part, it's a very easy climb. There is one spot where the engines may slip a little on rare occasions.

MRH: What would you say have been your greatest challenges? Did you foresee them or were they a surprise?

Jerry: I'm OK at woodwork, my brother was terrific at track-work. We complemented each other pretty well. We built a lot of



L-girders, put risers in, and so forth. We ended up reworking that some to get things working correctly.

As to challenges, I think of time more than anything. But I'm an early riser, so I could be down here early and work on it. We made good progress and were running trains fairly quickly.

We went through probably six months of figuring out our operating scheme. By that I mean doing time-and-motion studies to see what trains needed to run in what sequence so that we could have good passing meets. I've learned a lot from Brad Howard whom I met around 2000.

Brad would have opposing freights on his layout as well as opposing passenger trains. You've got to figure out where they can meet so you don't hold up any of the trains – for that you need to have adequate passing sidings. That was good training.

MRH: How long is the typical train?

Jerry: Trains are 10 to 12 cars plus engine and cabin car.

MRH: Then you figured out where the trains could meet?

Jerry: That's right. The other big thing is the storage capacity in the marshaling yard. You don't want the yard to get too full because that hampers your ability to drill and to classify cars. Keeping the yard with open space, that is key

MRH: What do you like the least about this layout?

Jerry: The thing I like least is the helix. It's within 40 feet of the layout start, so that area becomes a congregating point for all the operators. They naturally wait there for a train to enter or exit, plus it's near the marshaling yard.

We end up inevitably with four or five guys congregating at the end of the aisle, which is a downside to me. I've got three-foot aisles everywhere with four-foot balloons at the ends of the aisles. If I had



3. Reading RS3 #449 is moving out of the engine house on its way to pick up the string of empty hoppers seen in the background. These will be swapped with loads waiting in Reading Yard, and returned to LANCO Industries for use in its power plant. The staccato noise and vibration from engine 449 does not seem to bother the checkers game.

to do it over, the room would be bigger, number one – and the aisles would be wider.

MRH: The age-old bane of model railroaders: “I need more room.”

Jerry: Exactly. One of the things that we did wrong early-on was putting in too much track. We wanted as much action as possible, and that turned out to be a bad idea. Once we saw how bad it was, we redid things to add distance between towns and solve the age-old problem of still having a caboos in one town with the locos in the next town.

You need space between towns, so we cut things back to get more space. In Schuylkill Haven we had a series of switches to cross over several tracks, for example. We ripped out the switches and put in diamonds instead. That was a change we did mid-stream once we learned this lesson.



4. Train #91 has just passed Paterno Tower in the Schuylkill Valley and is rolling down grade all the way to Mount Carbon. Notice the tower access road through the rock cut just beyond the first line of trees.

MRH: What do you like most about the layout?

Jerry: I love the way it operates, and I credit a lot of that to DCC. We use the NCE system, and being able to have 10 engines all running at the same time is a delight. I also love the camaraderie of the people being involved, and the railroad operates well, which is very nice.

My brother was excellent at tracklaying, so we have very few problems with the trackwork or electrical work. We've had compliments on that. I think if you haven't got good electrical, you haven't got anything.

MRH: Why did you choose NCE?

Jerry: I was first introduced to System One on Brad Howard's layout, and that was a precursor to NCE. It was a simple choice for me at that point. Many of my operators also were NCE-based.

JERRY FASSNACHT'S PENNSY/READING | 12

When I first started, I had maybe three cabs, and I'd invite operators who had more cabs. Over time I have gotten enough cabs so everybody can operate without having to bring a cab over with them.

MRH: What kind of decoders do you have and why?

Jerry: When I buy new locos now, they often come with decoders. I've got the various Tsunamis, the QSI Revolution version two and three. We did a lot of Broadway Limited stuff, and they obviously come with their own sound decoders, too.

MRH: A lot of sound, then?

Jerry: Yes. I have maybe two or three engines that are non-sound. Over time I have added and replaced locos to get more with sound. Loco sound is great, and some of the new stuff sounds superb. I find the keep-alives to be quite interesting; it's a great new way to deal with power pickup glitches.

I also had a lot of Genesis stuff without decoders, so we had to put speakers and decoders in those.

MRH: One of the biggest objections to lots of sound locos is it gets on your nerves. After a while, you just want to turn them off and get back to peace and quiet. What's your response to that?

Jerry: That's a good point. When you've got engines idling in the engine facilities and they're clinking, clanking, and hissing, it's not against the rules to mute the sound. I turn the sound volume down so the engineer hears his engine and knows what's going on, but it's not in your face overall.

MRH: It's helpful to hear your comments on this issue. As you say, if the guy standing next to the locomotive can hear it, great, but nobody else needs to hear it.

Jerry: Right! Too much sound in the room was also one of the



issues early with the radio dispatching. You're trying to hear the dispatcher and people were talking over the top of each other. All that talking is another noise level that can be distracting, so we went just recently to a PBX close-circuit phone system.

MRH: Has that helped?

Jerry: It's helped a lot, yes.

MRH: Interesting. On a layout there are tasks that are not your favorite thing. What is that for you and how do you motivate yourself to do it anyway?

Jerry: I'm kind of past that point on this layout, but getting underneath the layout to work on wiring comes to mind. That was no fun. We did all our drops from on top, so that was not a problem. But running the power bus, getting the track polarity correct, and making sure it all works was just uncomfortable and tedious work.

We have a reverse loop to figure out and wire, we have four shields on the layout, with both a main command station booster and a second add-on booster. The four power-shields allowed us to separate the layout into four districts, which makes a big difference.

When somebody runs a switch and causes a short, that brings a district down. That's one thing I would say is occasional – overall the layout runs amazing at 15 years old.

There are still things like a track spot goes dead that was working for 12 years, and then you've got to figure that out.

MRH: Electrical gremlins, they're no fun at all.

Jerry: Exactly, exactly.

MRH: There are different ways to run trains: as a railfan and just watch them run. Or an op session with a dispatcher, car routing, etc. Tell us about your op sessions.



5. The Reading Junction Local led by RS3 #481 enters the siding to clear Howard Street so traffic will be unimpeded. It is a warm summer day and the kids are having a Coke on the sidewalk while someone else's day got a little warmer as evidenced by one of R.J.'s finest standing by the driver's window of the red sedan.

Jerry: I use Peter White's ShenWare program to develop all the car cards and waybills. What is neat about Peter's software is you decide up front what your commodities are, what kinds of cars you're going to use to move those commodities, and where they need to go. You put the data in and then it's just click and save!

I've got close to 200 car cards and waybills on the layout. Peter also included a program to put train orders together so I use those, with some modifications. You're trying to match engines to functions and jobs. If you have an engine go down, that needs to be communicated somehow, which is more involved than when it's all on paper.



6. Train #91 heads west on the Stoney Creek Branch Bridge on its way to Mount Carbon. The Pennsy River Sub is at lower-left.

Almost every operator I have is familiar with car cards and waybills, and that's a great thing.

In fact, I have some operators who are first-time visitors who come in and dispatch. I don't think this is the easiest railroad to dispatch, but they pick it up beautifully. It's amazing.

MRH: So a typical operating session has a dispatcher, and you use car cards with waybills to route the cars. How do the trains get their orders to move?

Jerry: We run four hours at a time and we run in sequence. I've got a departure and an arrival board above the marshaling yard, with the same sequence in the dispatcher's office so that whoever's up next gets the next job.

JERRY FASSNACHT'S PENNSY/READING | 16

It may be a short run from staging into the entry to the marshaling yard, or a longer run from staging into the other side of the marshaling yard where we cut and classify the trains. We have two unit trains that oppose each other and we have two passenger trains that oppose each other.

Then we feed into the marshaling yard with four trains, two from the east and two from the west. That's basically how the cars get on the layout.

We do about seven turns (local way freights) within that context.

We have an interchange with the Lehigh Valley, which allows us to move any kind of car off-layout to a third location. The Reading in Columbia has a small staging yard at one end as well. All told, there are four places to move cars to.

MRH: Do you have any paperwork you use to authorize movement of all these trains?

Jerry: I was introduced to track warrants at John Wilkes' L&N layout [mrhmag.com/magazine/mrh-2013-09-sep/john-wilkes-layout], and that took a little bit of getting used to. Everybody has their learning curve, and mine is kind of steep sometimes. I was at a proto rail convention over at Cocoa Beach where I visited at Tom Wilson's place [[mrhmag.com/magazine/mrh-2011-04-Apr/backs of buildings](http://mrhmag.com/magazine/mrh-2011-04-Apr/backs-of-buildings)], and he gave me copies of his track warrants.

So I put together a set of track warrants for the Pennsylvania Railroad and a set for the Reading. They're different colors, but they're otherwise identical. We run both railroads with one dispatcher. That's maybe a little odd, but that's how we do dispatching.

MRH: Well, that'll keep the dispatcher on his toes!

Jerry: Exactly!



“If I went to something smaller, I couldn’t see it. Anything bigger and I don’t think I would get the full enjoyment that HO gives us in this space.”

MRH: How do you manage staging?

Jerry: I’ve done all the staging yards tracks with toggles, so each rail can be toggled off. When you go into the staging yard and get a train, you have to toggle on the track because it’s not live all the time.

MRH: Why do that? With DCC, as long as you don’t address the loco, it should just sit there without moving.

Jerry: To me it’s a safety thing. I got that from Brad Howard and I still live by that. Every town has a panel with a track diagram on it.

With Peter’s software we use the system where each town is a zone, then there’s a track, and then there’s a spot number. In each town, I’ve tried to keep it consistent like how you read a book: from upper-left to lower-right for the numbers. Back upper-left is track one, and it might go up to eight tracks, lower-right, with the front track being the highest-numbered track.

Everybody going into a town can see where the spots are, based upon the track plan on the town’s panel diagram. You get used to the idea that the tracks are always numbered consistently, even though there’s a different layout in every town.

MRH: Your layout is HO. Would you ever consider doing a layout in a different scale or gauge?

JERRY FASSNACHT'S PENNSY/READING | 18

Jerry: I've got so much into this now I don't know that I could afford to change. And HO is still a good scale. I use reading glasses now to get into the details while I'm modeling. HO fits the room well, too. If I went to something smaller, I couldn't see it, number one. Anything bigger and I don't think I would get the full enjoyment that HO gives us in this space.

MRH: What would you say is your philosophy on doing a layout well? For example, how do you narrow the focus and actually get something accomplished?

Jerry: That is big. I know some folks that after 10 years are still trying to decide where they're going and what it is they're doing. Once we picked our region (which was easy because it's where we grew up), we stuck our heads down and just went at it. It was 85% done in probably six years, although the last 10% has taken more time.

The layout is fully scenicked now. There are a few buildings that are place-holders that I would like to kitbash into actual industries I've got photographs of.

I'm collecting materials for one right now that is another coal bin/lumberyard scenario that was very interesting. The coal bins were an elevated trestle and had chutes for dump truck loading. I counted 18 bays overall in the photograph I have. The road starts up high and the bunkers get deeper until it flattens out. I'm thinking it's at least 18 feet from railhead to the truck road below. It would be an interesting structure to model.

MRH: What advice would you give to someone just starting out in the hobby?

Jerry: I would say to build something with purpose and do a lot of different things to hone your skills. Make sure you run trains more than just looping around a track if you want to stay





7. **Penny Mountain #6755 approaches the Howard Street grade crossing in Reading Junction on its way west with Lehigh Valley Interchange traffic. Brother Jim built MM Tower in a nod to Jerry's wife "Margene Marie."**

interested. There's so much to learn in this hobby: if you can't keep learning until you're 90 with this hobby, there's something wrong with you!

MRH: Good advice. We have a philosophy we call "quality of run" that we talk about. The first point is to make the trains interesting and as you say, that's all about purpose.

Jerry: Some people are rivet-counters and they get so into the detail that if it's not exactly right then you're doing the hobby wrong. I don't share that philosophy.

JERRY FASSNACHT'S PENNSY/READING | 20



Both the Reading and the Pennsy had a twice-daily commuter train round-trip from Philadelphia up to Pottsville. It had a grill car and a lounge car. That ran with steam until 1948, and then went to diesel. I'm still running my version of this train with steam because I like it that way even though I'm modeling 1956. Go ahead and bend the rules. If it gives you joy, why not?

MRH: Give us some specs about your layout. About how many feet of main line do you have, including the helix?

Jerry: I have a little over 300 feet of main line on the Pennsy, about 70 feet on the Reading and Columbia

and about 80 feet on a branch line that we call the Stoney Creek. It's purely fictitious but it comes off the Pennsy main and runs up through the mountains to the coal mine.

About 105 feet is the helix on the Pennsy line.

MRH: What's your minimum radius?

Jerry: We try to stick with a 28" radius, and we broadened a curve when we could. We have some tight switching scenarios with some curved switches. I think the minimum on one of those is probably 20".

MRH: Speaking of turnouts, about how many do you have on the layout?

Jerry: I have 119 turnouts.

MRH: What are the typical sizes?

Jerry: We have 6s on the main and some 8s on the main, and then I've got some 4s on the ladder into the marshaling yard, and some industries are served by number 4s and number 5s.

MRH: What kind of track are you using?

Jerry: We're using code 83 flex track, Atlas, pretty much everywhere. We've got some code 70 in a few industry sidings that are down-in-the-dirt, into the weeds.

The main is obviously higher than a passing siding – and that's higher than a down-in-the-dirt track. We're fairly realistic in the transitions off of the main because that's the way it should be.

MRH: So the main line's literally the high iron then?

Jerry: Correct.

MRH: Anything else come to mind we've not discussed?

Jerry: The other side of things is the research we do for industries. Being from Pennsylvania, Lancaster had Armstrong World Industries. They made linoleum, carpet and things like that.

So I went on the web to find out, "what goes into linoleum?" It turns out you need linseed oil, chinks, dyes, and wood flour for the majority of it. Then you decide how that's brought into the industry, which adds to the fun. At the end of it all, you often go, "I didn't even know that was in there!"

MRH: So doing the research for the industries and figuring out what kinds of commodities are involved is a lot of fun for you?



8. Train #58, a coal drag coming off the Stoney Creek Branch with GP7s in the lead, approaches Stoney Creek Junction. The track adjacent is the PRR main between Reading Junction and Schuylkill Haven. The River Subdivision is at the bottom of the photo.

Jerry: That's right, I like determining what spots are needed to receive the raw material. Then I need to add interesting things like gravity dumps and other spots that would have tanks for pumping out the liquid portion of raw products. And then I need a shipping bay for the product to come out of the factory.

MRH: Sounds like fun! To wrap up here, how long have you been in the hobby?

Jerry: My father had a Lionel set that we put out around the Christmas tree every year. He had a passenger and a freight and that ran on a four-by-eight sheet of plywood. On the opposite side of the plywood he added a loop of HO track.

JERRY FASSNACHT'S PENNSY/READING | 23

My dad and my oldest brother had a couple of covered wagons (Pennsy F units) they ran. I loved that: even though we were not allowed to touch it, we still loved it. Once we were old enough to where my dad felt we were ready, probably 11 to 12 years old, we got to work on the four-by-eight ourselves.

We did a couple of loops around and added a crossover diamond to allow us to cross over the mains. We then moved on to building a couple of half-base-ment-size layouts and my father loved it. He was a railfan as well.

We added a yard so that you could run a train around in circles for 15 - 20 minutes, then pull it into the yard and bring out another train. We never finished any of those layouts because after a while it got boring.

Once I was introduced to the more serious operations side where you run trains with a purpose, I no longer grew tired of it. This layout is now 15 years old and I'm still not tired of it. Realistic operation is a big key so you don't ever get tired of the hobby. ☑



[Click here for reader comments](#)



9. #4695 Decapod is heading to the house. The MOW train and crew will be heading west soon to resupply the tie gang working outside Gap Tunnel.

You can see Jerry's layout
at the Orlando NMRA
Convention this August ...



• INDEX



SUBSCRIBE
(free)

• TABLE OF CONTENTS

JERRY FASSNACHT'S PENNSY/READING | 25

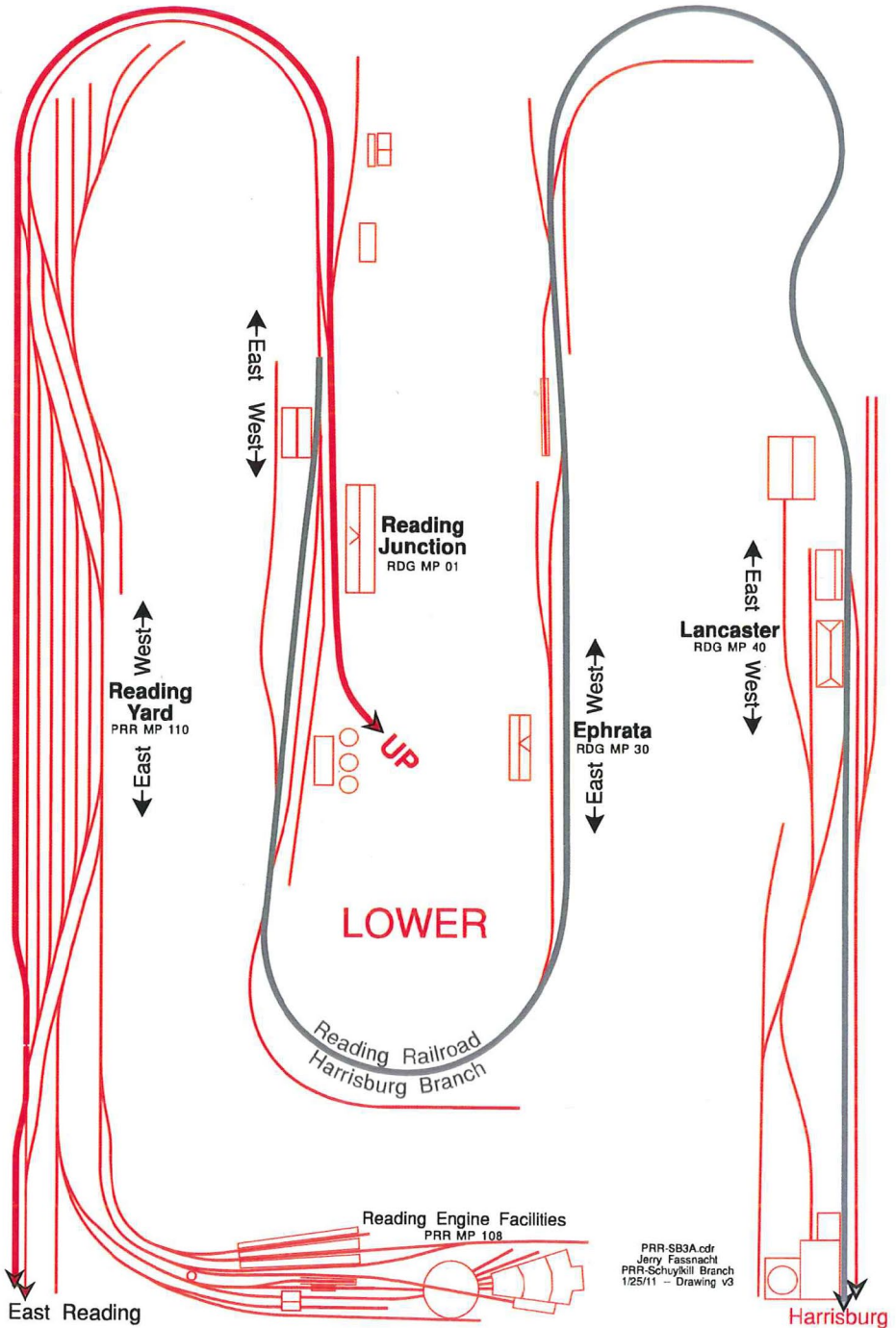

JERRY FASSNACHT'S PENNSY/READING | 26

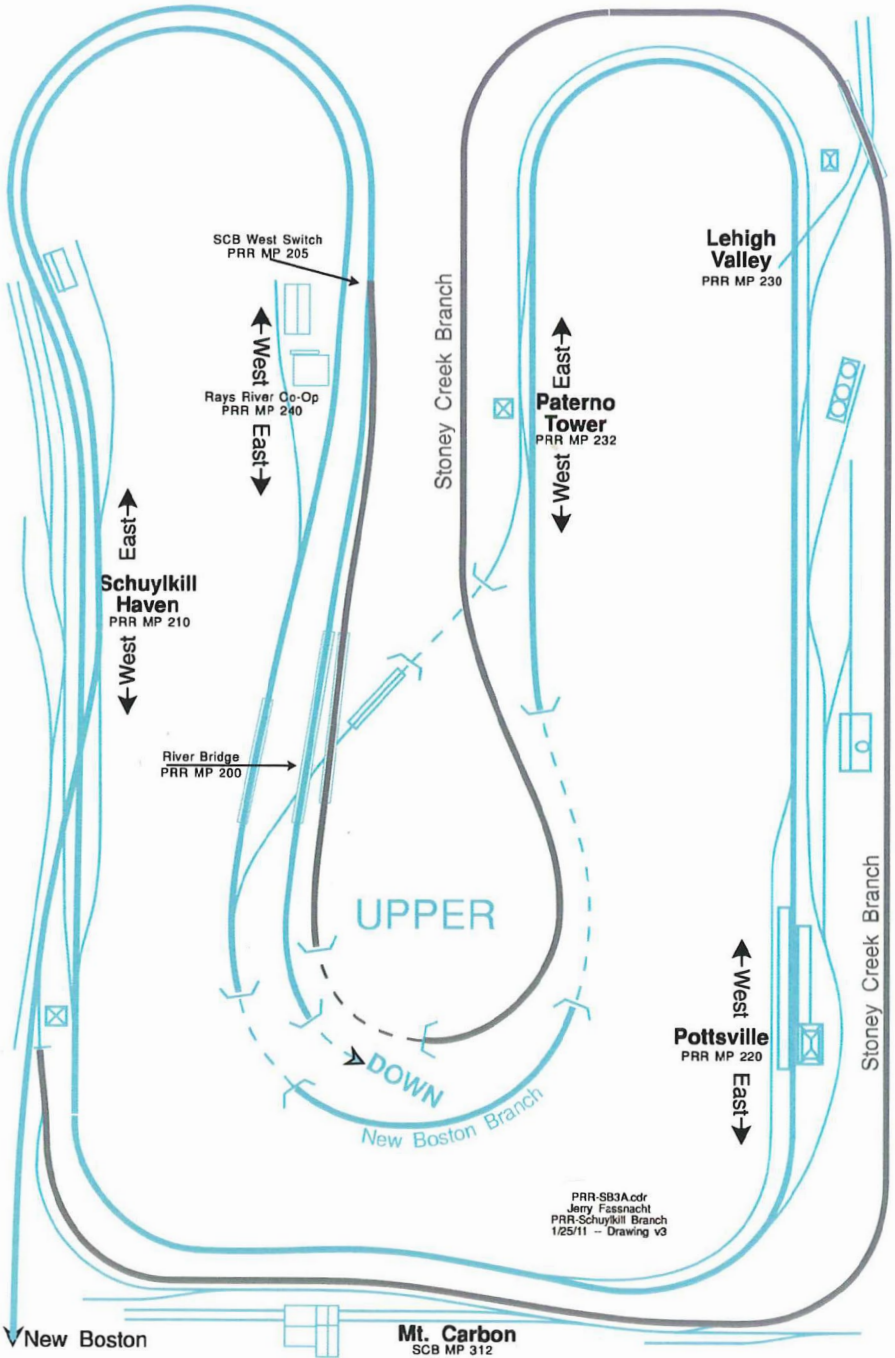

JERRY FASSNACHT



Jerry got his start in the hobby when his father would put up a Lionel set under the Christmas tree every year. His dad and his oldest brother had a couple of covered wagons (Pennsy F units) they would run, which got Jerry hooked on the Pennsy.

In his teens, Jerry and his brother worked on a four-by-eight layout and kept upgrading it with new things.

Jerry and his brother Jim (who worked as a railroader) started the current layout in 2002. Once Jerry discovered the more serious operations side of the hobby, he was hooked. The current layout featured in this story is now 15 years old and Jerry said he's never grown tired of it.

Jerry has been married 40 years and has 4 children and 8 grand-kids. He spent his career working in health care design and construction. Other interests include fishing and sporting clays. He and his wife volunteer at an equine therapy ranch which serves kids and adults with other physical and mental abilities. ■



[Click here for reader comments](#)

Also on TMTV!



2017 National Train Show

August 4 - August 6, 2017

in **ORLANDO, FLORIDA**

Get the details >>

(click me)

Fun for the Whole Family

From your littlest engineer ...

To the most experienced Model Railroader



- The World's Best Known Manufacturers
- Over 180,000 square feet of exhibit space
- Hands-On Demonstrations
- 44,000 Sq. Feet of Modular Layouts
- Ask The Collectibles Appraiser
- The Incredible Lego® MiniLand

• [INDEX](#)



• [SUBSCRIBE](#)
(free)

• [TABLE OF CONTENTS](#)

WHAT'S NEW on TMTV!

Non-members: Watch episodes for \$1.49 ea, become a member for unlimited access



NEW Ops Series:
Crew Call



Start Small. **THINK BIG.**

TOMA project layout: trackwork



Weathering / detailing rolling stock: 2

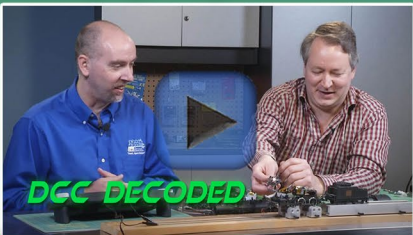

DCC DECODED

DCC sound install in brass steamer



LED lighting tips and tricks



TRAINMASTERS.TV



• INDEX

• TABLE OF CONTENTS



YES, IT'S A MODEL

compiled by
DON HANLEY
.....



[Click here to rate or comment on this article](#)



1. Delaware & Hudson E-42 #894 arrives in Rutland VT at the end of its journey from Whitehall NY, passing by Duffy's Coal and over the Pine Street bridge. Greg Wiggins modeled this locomotive using a Bachmann Spectrum 2-8-0. He reworked its boiler and coal tender with numerous brass detail parts and added Archer rivet decals. The old ad painted on the coal shed was made possible with the help of John Nehrich and the wonderful people of the Rensselaer Polytechnic Institute's New England Berkshire & Western.

▶ **MRH'S MONTHLY PHOTO ALBUM**



YES, IT'S A MODEL | 2



2. Rutland RS3 #208 leaves Rutland VT on its way to Burlington passing by the Burditt Brothers warehouse and coal shed on the north end of the Rutland yard. Greg Wiggins' locomotive and Swift reefer car are by Atlas. Greg kitbashed the gray Delaware & Hudson hopper car from an Accurail



55-ton hopper using the roof from a Bowser covered hopper kit. Greg scratchbuilt the Burditt Brothers building and surrounding structures out of styrene. He used Tichy window castings to match the actual prototype structure.



3. Scott Sanders modified a factory-painted Athearn Genesis MP15AC to match the MKT prototype engines. The big change needed was converting the Athearn MKT model from full-length handrails to the hand hold along the upper side of the locomotive found on Katy MP15ACs. Scott used .012" brass wire to simulate this distinctive feature. For weathering, Scott used oils and powders. He shot the photo on his yard diorama depicting the locomotive flat switching at the Katy's Eureka Yard in Houston, TX.

The twin-bay MKT covered hopper was detailed and weathered by Tony Sissons. The Athearn Airslide was modified, painted, decaled and weathered by Scott, and the ATSF beer car was weathered by Dave Schroedle.



[Click here to rate or comment on this article](#)

CROSSING THE PRAIRIES IN A 50-YEAR-OLD FISHBOWL

CLICK ON A TV TO WATCH THE ADVENTURE!



\$ GET PAID FOR YOUR PHOTO

We pay \$40 per photo we publish. If you'd like to get your modeling in our photo feature, just start posting your photos on the MRH website, especially in the Weekly Photo Fun thread created each week.

See mrhmag.com/help for more on how to post an image. You need to be an MRH subscriber to post photos to our website, and becoming a subscriber is free, [just fill out this form here](#). ■

ADVERTISEMENT



*Announcing
Motrak Models New Structure Kit
HO Scale "The Tool Shed"*



Website: motrakmodelsusa.com
Email: info@motrakmodelsusa.com

Floquil/PollyScale stash running out?



MRH has mapped the old familiar colors to new readily-available acrylic paints.

THE Model Railroad Hobbyist's
Guide to acrylic painting
... in a post-Floquil world

By Joe Fugate PDF LANDSCAPE EDITION

MRH's Floquil / PollyScale Paint Equivalents Conversion Chart - 1

Floquil/PollyScale Color (approx.)	Model Number	Valley/Monoco	MOORE	Notes
Primer Gray	MM 4763	VMA 71250	16-12	
Engine Black	MM 4888	ML 20008 VMA 71251	16-01	
Steam Power Black	MM 4795	VMA 71252	16-44B	
Oilily Black	MM 4792	VMA 71253	16-44*	
Weathered (Enameled) Black	MM 4793	ML 20022 VMA 71254	16-05	
Refer-Gray	MM 4887 MM 4761	VMA 71243	16-04	
Refer-White	MM 4873	ML 20004 VMA 71242	16-02	
Griny Black	MM 4887	ML 20020 VMA 71245	16-03	
Caboose Red	MM 4887* MM 4882	ML 20021 VMA 71246	16-08	ML 20021 with 20% Model Master's Fine-grain paint

* Indicates a close but not exact match. All MOORE paints is a sampling finish. Valley Model Acrylics Air, Monoco, and Model Master paints are from various markets. 1 Glass Finish. 2 Sampling Finish. 3 Model Master's new Air-Glass Finish is a shade darker than the old Floquil Refer-Gray. 4 Model Master's new Air-Glass Finish is a shade lighter than the old Floquil Caboose Red. Color 4882 (large bottle) gives a closer match to the old Floquil Caboose Red medium to get same glaze.

Page 14 MRH Guide to acrylic painting

MRH's Floquil / PollyScale Paint Equivalents Conversion Chart - 2

Floquil/PollyScale Color (approx.)	Model Number	Valley/Monoco	MOORE	Notes
Tuscan	MM 4885*	VMA 71256	16-15	
Refer-Orange	MM 4882*	VMA 71243	16-09	
Refer-Yellow	MM 4879	VMA 71258	16-10	
Rail Brown	ML 20009 VMA 71249		16-11B	
Railhead Teal Brown	ML 20002 VMA 71249		16-40** Clear match... Jan 16-04 Jan 16-04	
Rail Brown	MM 4028*	ML 20001 VMA 71239	16-13	
Rail	MM 4875	ML 20005 VMA 71247	16-12	
Concrete	MM 4876	VMA 71248** Clear match... Jan 16-04 Jan 16-04	16-11*	
Appl Concrete	MM 4875	ML 20002 VMA 71243	16-07** Clear match... Jan 16-04	

* Indicates a close but not exact match. All MOORE paints is a sampling finish. Valley Model Acrylics Air, Monoco, and Model Master paints are from various markets. 1 Glass Finish. 2 Sampling Finish. 3 Model Master's new Air-Glass Finish is a shade darker than the old Floquil Refer-Gray. 4 Model Master's new Air-Glass Finish is a shade lighter than the old Floquil Caboose Red. Color 4882 (large bottle) gives a closer match to the old Floquil Caboose Red medium to get same glaze.

Page 15 Chapter 2: Paint conversion chart TABLE OF CONTENTS

MRH Subscribers: Download your FREE Post-Floquil acrylic painting eBook

Want a hardcopy version? Post-Floquil acrylic painting guide: \$15.99 (MRH Store)

CP RAIL 5406



BY ALEX REED

An ex-Quebec, North Shore & Labrador SD40 ...

CANADIAN PACIFIC SD40 5406 WAS ONE OF A fleet of 15 locomotives (CP 5400-5414) that had a unique history in Canadian railroading. These locomotives were originally built in 1968 and 1971 for the Quebec North Shore and Labrador Railway (QNS&L 204-218). At the time, the railway ran between the port of Sept-Iles, Quebec and iron mines near Schefferville, 353 miles to the north.

The 15 SD40s worked on the QNS&L until they were leased to CP in 1983 and 1984. They were purchased outright by CP in 1985

• [INDEX](#)

• [TABLE OF CONTENTS](#)



[Click here to rate or comment on this article](#)

and were modified and repainted into CP colors over the following year.

From their arrival on CP in 1983 until the early 1990s, these locomotives served frequently on the mainline between Montreal and Chicago. This route is a strategic intermodal and manifest link, and the ex-QNS&L units often led hotshot trains. This significance was highlighted by Greg McDonnell who nicknamed CP 5409 “The Whale,” and chose it to race across the cover of his book *Signatures in Steel* (1991).

These locomotives were used across Canada during the 1990s. By the late 1990s several were downgraded to hump service in Alyth yard in Calgary, Alberta.

The 15 units were progressively retired between 1999 and 2003. Five units were sold to the Dakota, Minnesota & Eastern and the remainder were scrapped.

Prototype description

In appearance, these locomotives were much like other stock Canadian SD40s built by Diesel Division, General Motors Canada (GMD) with headlight on the low nose, bell between the number boards, and vertical instead of stair-like steps. There were number boards and a vertical dual-Pyle headlight on the rear hood.

Distinctive items on CP 5402-5414 were the front snowplow and extra-capacity fuel tank. Large snowplows were a must on the isolated QNS&L, but were cut down in size by CP in 1985-86.



CP RAIL 5406 | 3

GMD created the extra-capacity 4000-gallon fuel tank by increasing its height up to the walkway sill. It was retained as-is by CP. To make room, the air reservoirs were moved into the long hood beside the air compressor.

The other significant departure from typical SD40 design was the handbrake pedestal and wheel placed in the center of the rear porch.

For this project, CP 5406 was modeled as it appeared between 1985 and early 1988. One feature I wanted was functional classification lights. In the late 1980s, most CP Rail trains were extras, and displayed white classification lights and flags.



Base model

An Athearn Ready-to-Roll SD40 in the CP Rail Multimark scheme was used as the base model [1]. I was quite happy with the

1. Stock Athearn SD40 model.

lettering and overall paint job, so I chose to change the details and brush-paint as required. The Kato SD40 is another option.

Disassembly

The engine is easy to disassemble. First undo the screw at the bottom of the fuel tank and slide it off. Then undo the screws on the coupler pockets, remove the couplers, and slide the shell off the frame.

Detach the two air reservoirs from the shell, and the horn from the long hood. Carefully remove the front and rear light bulbs. The cab should also be popped off the shell.

Remove the trucks and motor from the frame. This is to avoid contamination by metal filings in later steps.

Remove numbers

The engine numbers are easy to remove with a small amount of paint remover on a cotton swab. Rinse with water afterwards.

Fuel tank expansion

The fuel tank needs to be extended in height to match the unique shape of the large-capacity tanks ordered by QNS&L. Since the top of the normal tank is sloped, whittle pieces of 0.125"×0.250" strip styrene (Evergreen 189) to fit on top. Look at the sketches for lengths and positions [2]. Some test fitting and sanding of the whittled face is required to get the pieces to sit flat [3]. Glue pieces of 0.030" styrene (Plastruct 91103) on top.

After everything dries, sand the outer edges to create a curved contour. Apply spot putty (Bondo), allow it to dry, and sand with 220- and 400-grit sandpaper until these surfaces are smooth.



CP RAIL 5406 | 5

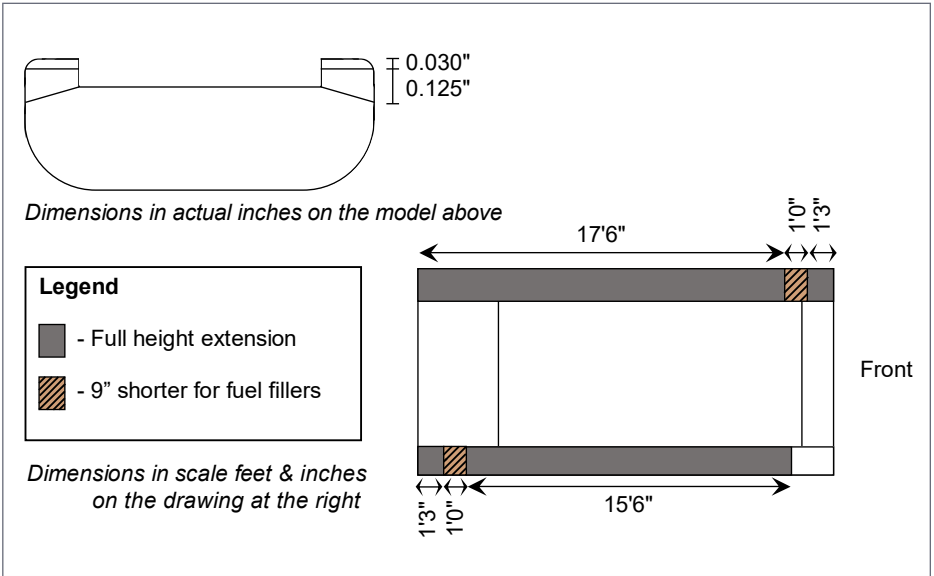

2. Dimensions of fuel tank modifications.

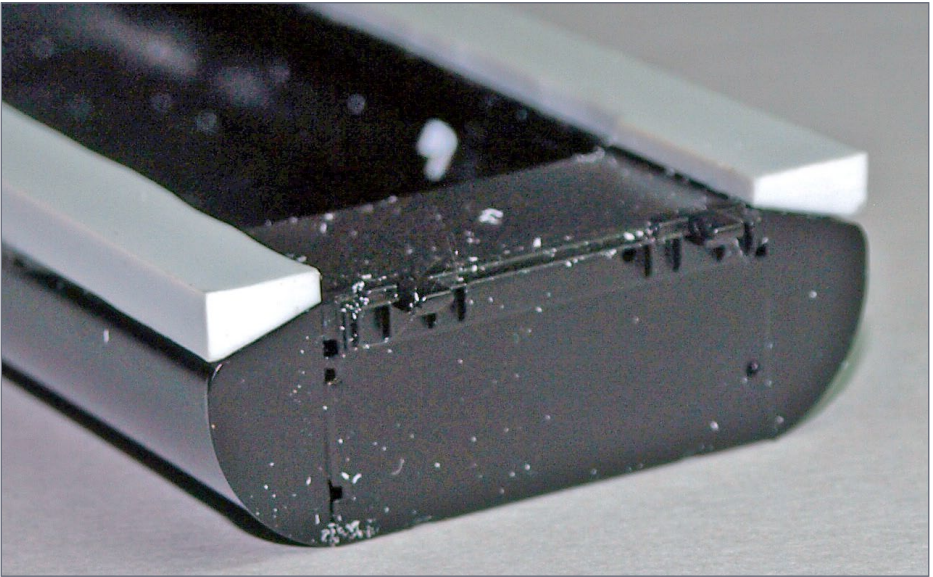

3. First stage of modifying fuel tank.

Fuel tank details

Drill holes for the fuel tank fillers and circular fuel tank gauges as instructed on the Detail Associates 3102 package. Cut the rear mounting bracket off each vertical fuel gauge. Then glue into place with plastic cement. Add the parts included in the Athearn box to the ends of the fuel tank [4].

Notches in frame

Now let's have a look at the frame. First, cut out notches for the larger steps. Use a Dremel motor tool with cutoff wheel to cut rectangular notches at each corner that extend a scale 3'-0" from each end of the frame. Next, grind off the top corners of the long hood. This will allow the cooling pipe to fit more easily later on. After cutting and grinding, smooth the edges with a file [5].

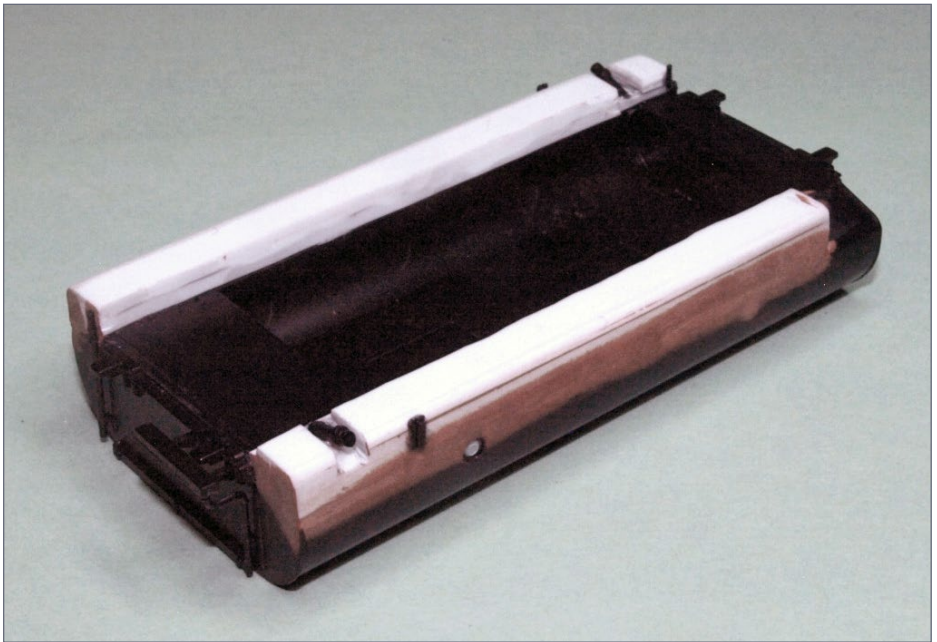

4. Fuel tank with all details applied.

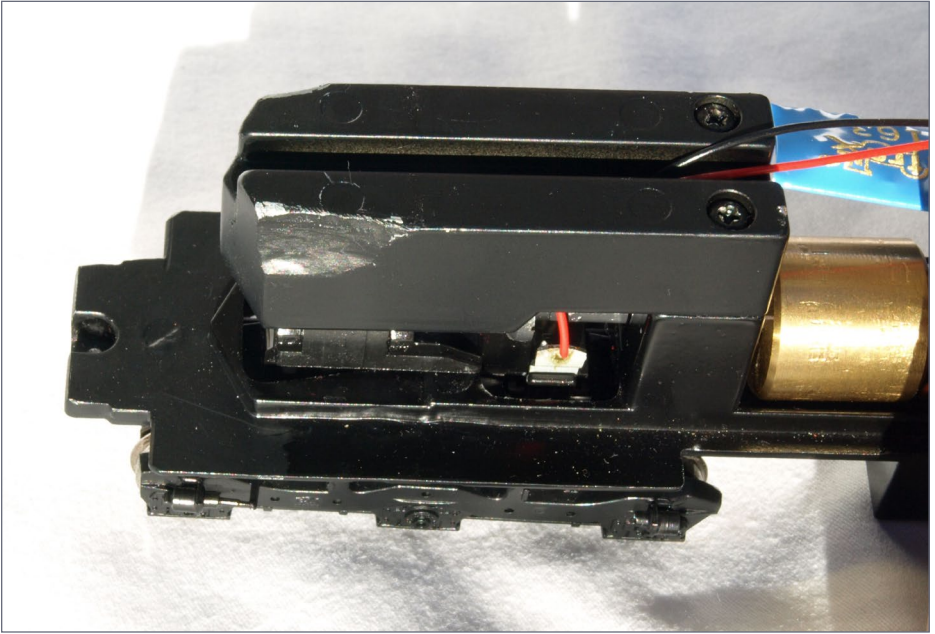

5. Notches in frame for steps and top of long hood.

Vertical steps

A major spotting feature of Canadian GMD units are their vertical steps as opposed to the stairs on American EMD units. Cut the old steps off the shell using a razor saw on the back side of the pilot and underneath the walkway. In their place I used the Railflyer Model Prototypes DP 6032 “CPR GP35/SD40 Steps.” Similar steps by Railflyer are still available at Walthers. An alternative is the Miniatures by Eric S17 “Canadian Steps.” Using the new steps as a guide, cut and file the shell until the new steps fit [6]. This will require scraping paint off the top of the walkway to let the top sheet of brass sit flush.

When satisfied with the fit of each step, glue them into place with epoxy. After curing, fill the gaps with spot putty, and sand down with 220- and 400-grit sandpaper after drying.

Truck side frames

Now for a test fit: put the frame on the trucks, followed by the shell. The shell will not fit since the steps jam on the truck side frames. Trim the outer edges of the side frames until the shell fits and the trucks swivel smoothly.

Glue Detail Associates 2801 brake cylinders to the side frames as pictured [7].

Nose details

To match CP 5406 and most Canadian second-generation GMD units, the class light moldings need to be removed from the nose, and a dual headlight added. Trim the class lights off with a knife, and sand with 220-, 400-, and 600-grit sandpaper. Cut a notch in the nose as shown in the drawing [8]. Epoxy a Miniatures By Eric

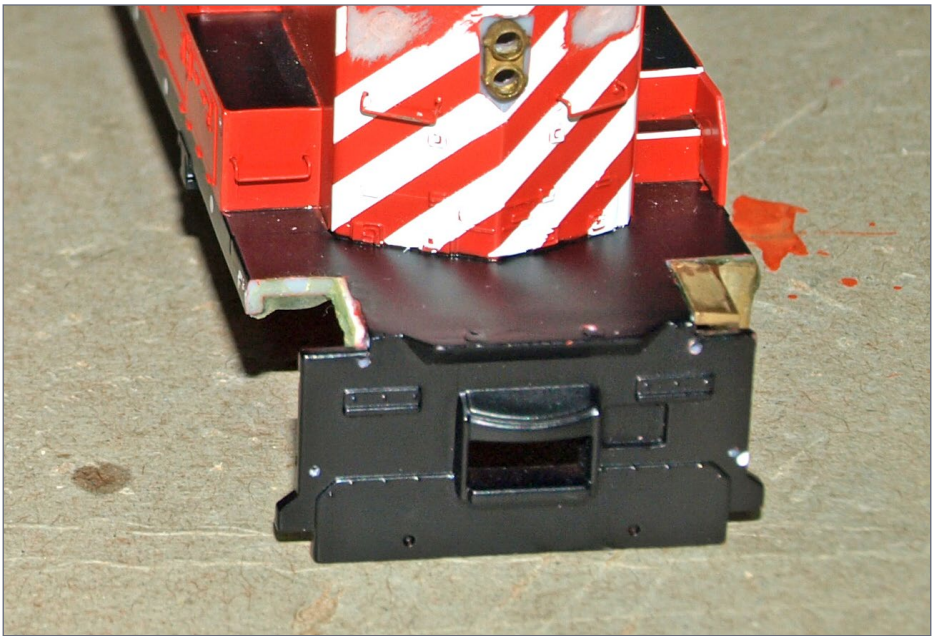

6. Cutting body to fit steps.

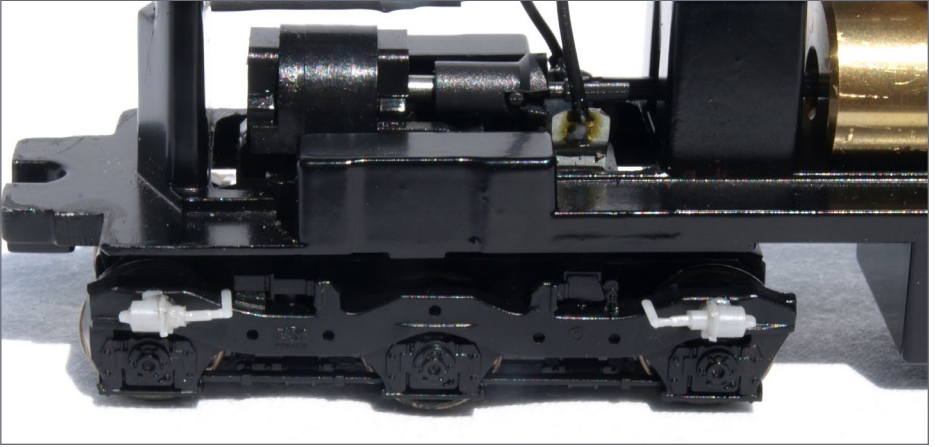

7. Brake cylinders on trucks.

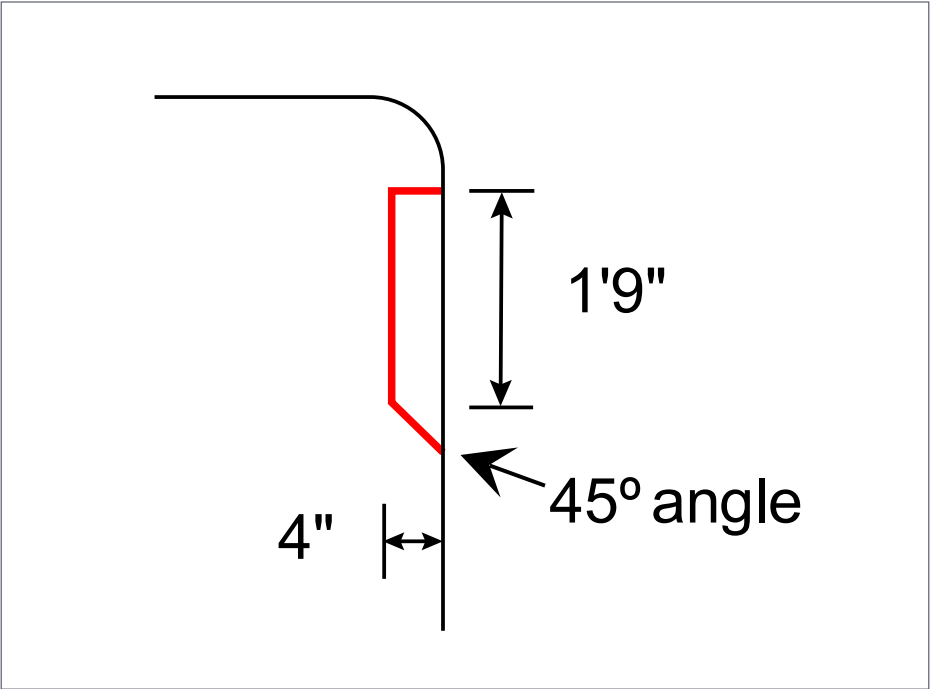

8. Dimensions of nose job (in scale measurements).

headlight L7 into place. After drying, drill out the headlights with a #50 bit [9].

Front pilot

In prototype photos, the snow plow appears to be an odd shape, so cut off the top third of a Details West PL-235 snowplow and file it smooth. Drill #54 holes into the shell using the PL-235 template and epoxy the plow into place.

Add the following items to the front pilot: ditch lights with lift lugs (Miniatures by Eric L1), drop step (Juneco C-31), and MU stand (Details Associates 1506). With the front handrails on, test-fit each of these items then epoxy in place.

The last thing to do on the pilot is to drill four holes with a #80 bit for the coupler lift bar (Detail Associates 2205). Fit the

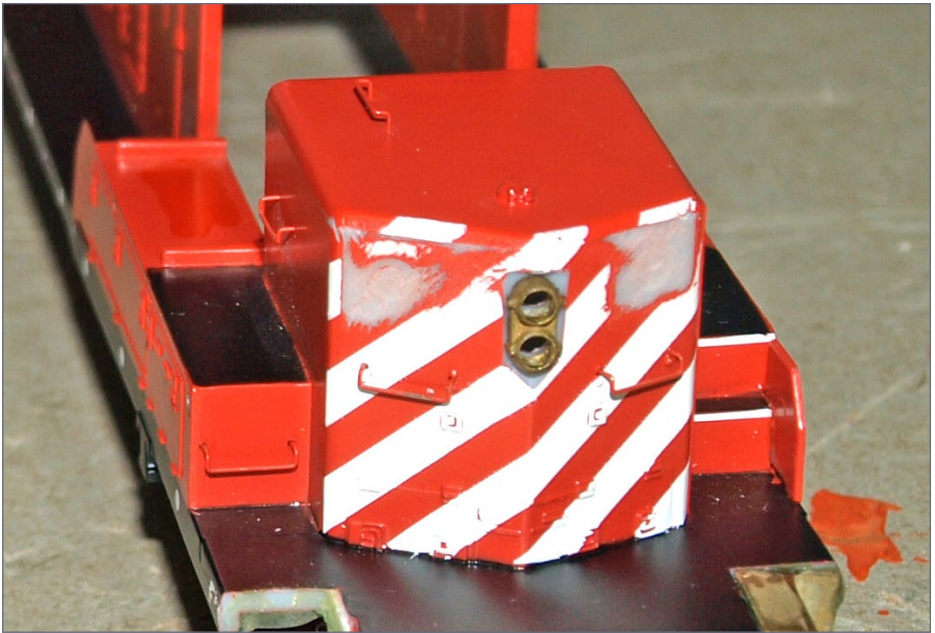

9. Headlight and other nose modifications.

eyebolts onto the coupler lift bar and then glue them into the holes with cyanoacrylate glue [10].

Rear headlight

The horizontal dual headlight on the rear hood needs to be replaced with a vertical dual headlight. Whittle the headlight off with a knife and sand smooth. Glue on a Juneco C-111 DDGM Backup Light. After the glue dries use a #50 bit to drill holes for later installation of lenses [11].

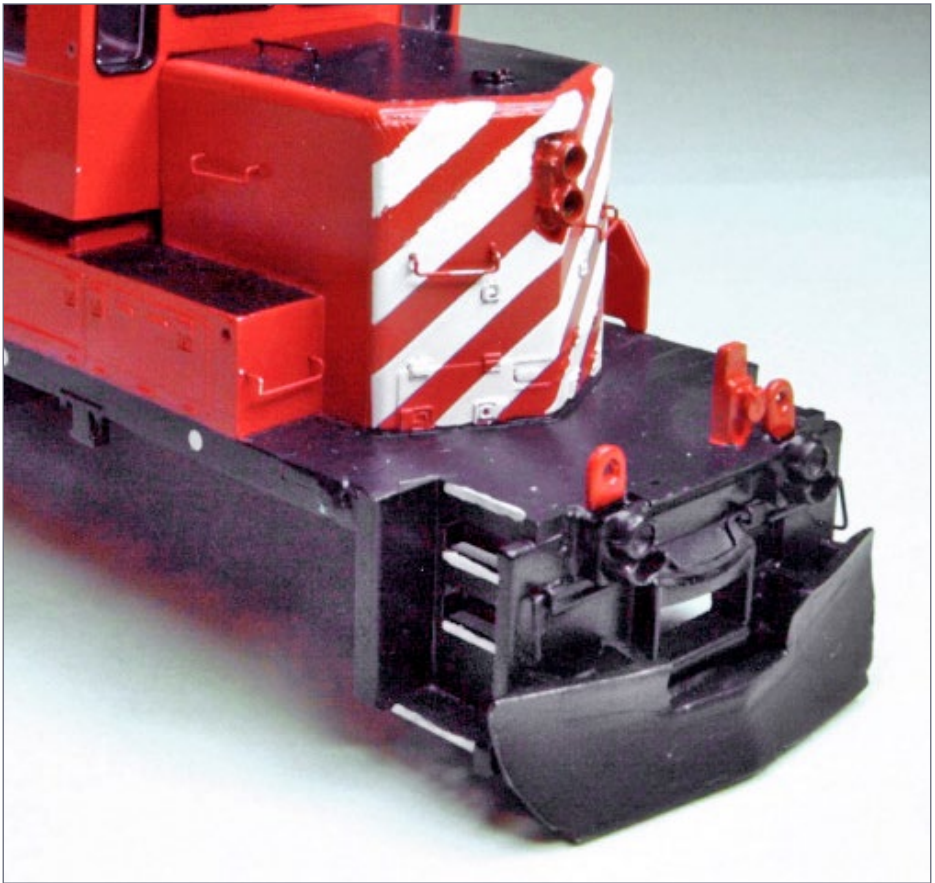

10. Front pilot details after painting.

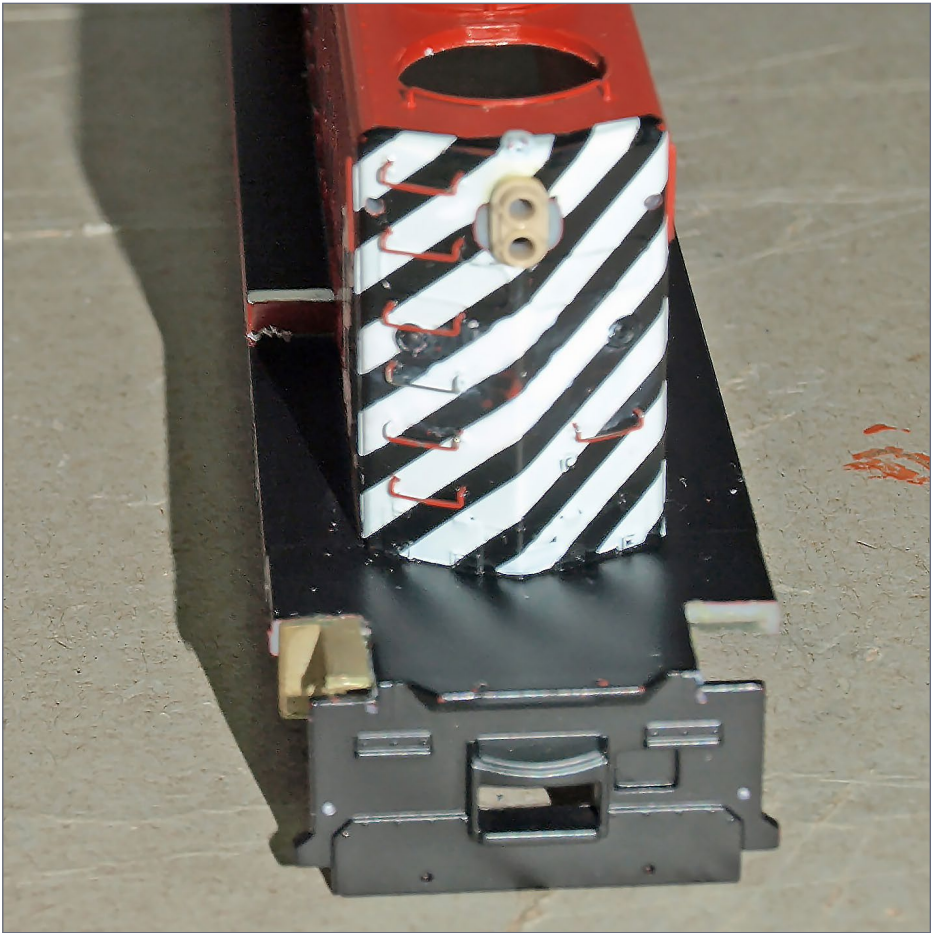

11. Rear headlight.

Rear pilot

The brake stand (Miniatures by Eric B9) should be placed against the center of the long hood on the rear platform. Drill two #71 holes to fit the sprues of the brake stand. Trim the sprues to 1/16" long each, then epoxy the brake wheel to the stand and the stand to the platform.

Add the following details to the rear pilot in a similar manner to the front pilot: lift lugs, drop step, MU stand, and coupler lift bar [12].

Cooling pipe

The cooling pipe is found at the rear of the long hood. It is a 2" pipe that enters and exits the long hood just above the number boards [12]. Drill #65 holes at these locations. Bend a 0.028"

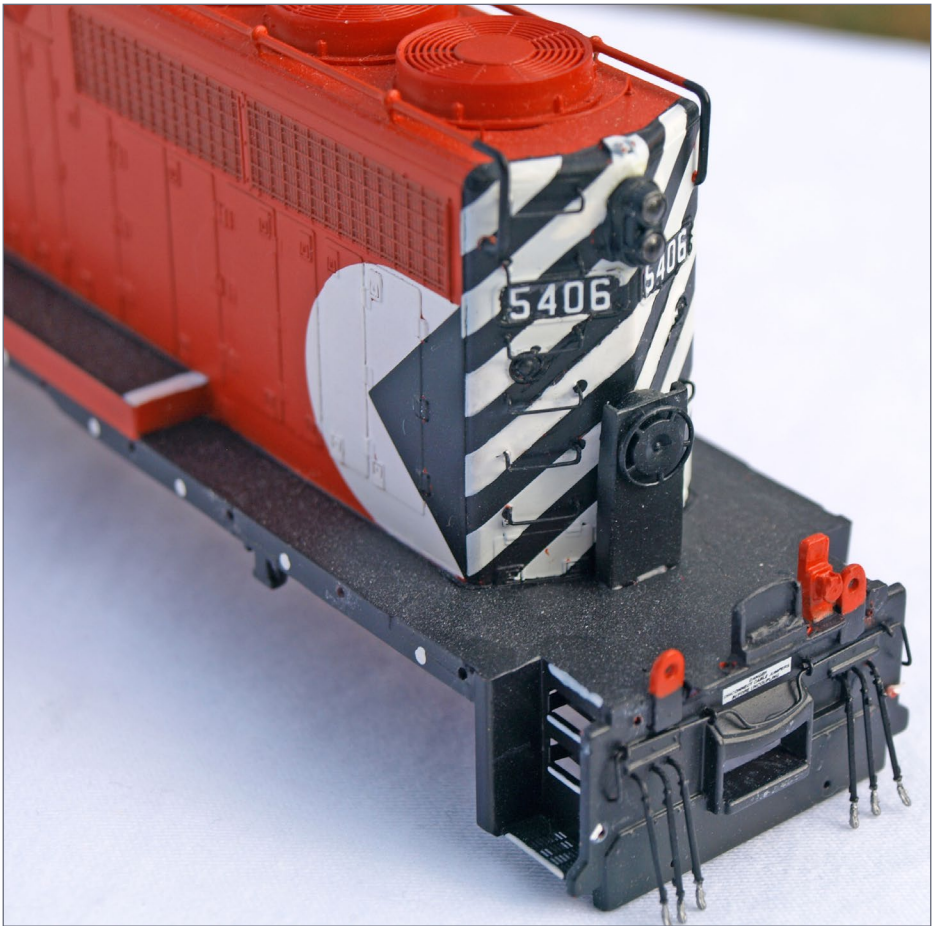

12. Rear pilot details and brake stand.

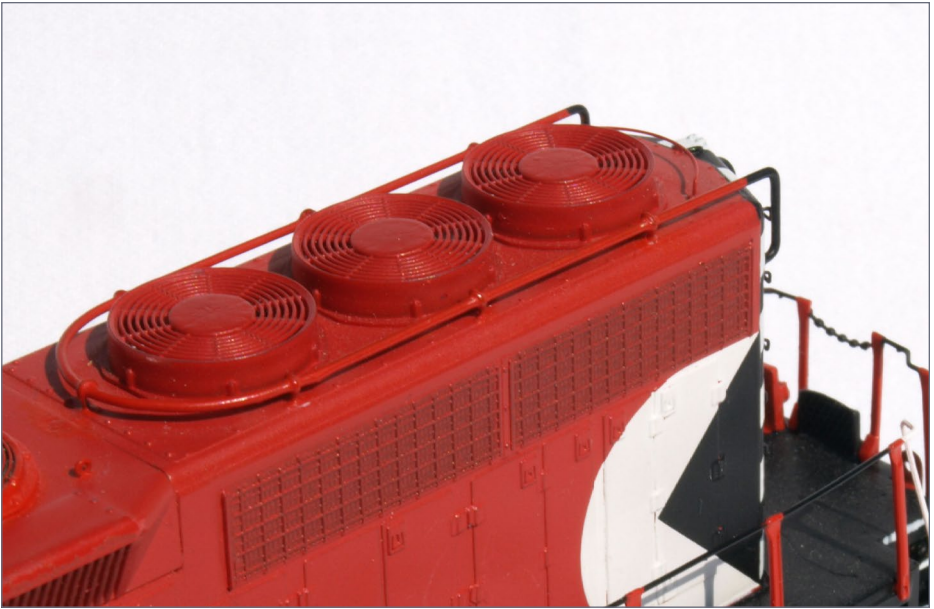

13. Cooling pipe on rear hood.

brass wire (Details Associates 2508) to fit with right-angle bends at each end, and a curve around the forward fan. Feed seven 3-1/2" eyebolts (Details Associates 2206) onto the pipe. Drill #80 holes for the eyebolts beside each fan and ahead of the forward fan. Slide the whole assembly into place and glue with cyanoacrylate [13].

Dynamic brake fans

Sometimes the World Wide Web is a blessing, sometimes it is a curse. When I was nearly done with the model, I discovered a prototype photo [14] that shows the dynamic brake fans on CP 5406 are dome-shaped like on GP9s.

The original fans were easily popped out of the shell. Two Details West CF-144 Cooling Fans (48" pan-top type) were painted before installing. The grille area was painted black, followed by

CP RAIL 5406 | 15



14. CP 5406 in Port Coquitlam, BC on October 11, 1986. Note the rounded dynamic brake fans. *Claude Prutton* mountainrailway.com



15. New dynamic brake fans.



16. Cab details.

dry-brushing red paint on the raised grille “wires.” More red paint was brushed onto the solid center and rim. When dry, I glued the fans in place [15].

Cab details

I found it easier to work on the following items while the cab was separated from the body. First, trim off the headlight and rounded housing underneath. Fill in the lower light hole with putty, and sand smooth. Epoxy a Juneco bell (C-11) into the upper hole.

Drill a hole above each cab number board with a #60 bit. Use CA to glue Railflyer Model DP6621 class light housings onto each hole [16]. Fiber optics and lenses will be discussed in a later section.

CP RAIL 5406 | 17



17. The completed awnings over the air intakes.

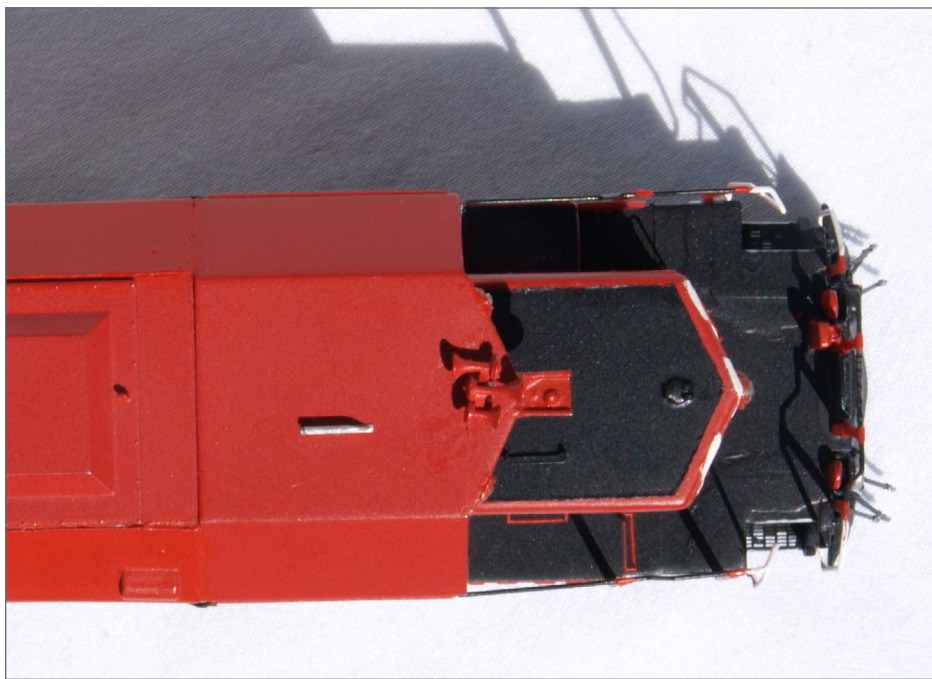

18. Cab roof details.

Awnings (snowshields)

At this point reattach the cab and glue it to the body. Chamfer the top edge of the air intakes in behind the cab, then glue Details West awnings AD-194 into place. I brush-painted them black as a primer coat followed by Action Red [17].

Horn, radio antenna

I reused the metal Athearn horn. Drill a #71 hole behind the bell on the cab roof and epoxy the horn in place. Mount a Sinclair radio antenna (Detail Associates 1803) to the right of center on the cab roof [18].

Painting details and handrails

I brush-painted details with each modification. This section summarizes items not previously discussed.

Paint the fuel tank, walkways, steps, and plow with PollyScale Engine Black. Also paint black the numberboards and rear grab irons. Mask the top of the nose with painters tape and paint it black [18]. (See [MRH Painting guide](#) for Floquil/PollyScale alternatives.)

Paint the sanded parts on the nose with True Line Trains CP Rail Action Red. Cut and apply painters tape to match the white striping. Brush on Polly Scale Reefer White paint in multiple thin coats, and then remove the masking [19]. Paint the classification lights and bell area in Action Red.

In prototype photos from 1988, it appears that the right ditch light of CP 5406 had an unpainted metal housing. Use Polly Scale stainless steel paint to mimic this [19]. This should also be brushed on the antenna.

Use three colors to paint the handrails: Action Red on the stations, black on the horizontal handrails, and white on the vertical handrails at the steps.





19. Nose and front pilot painting details.

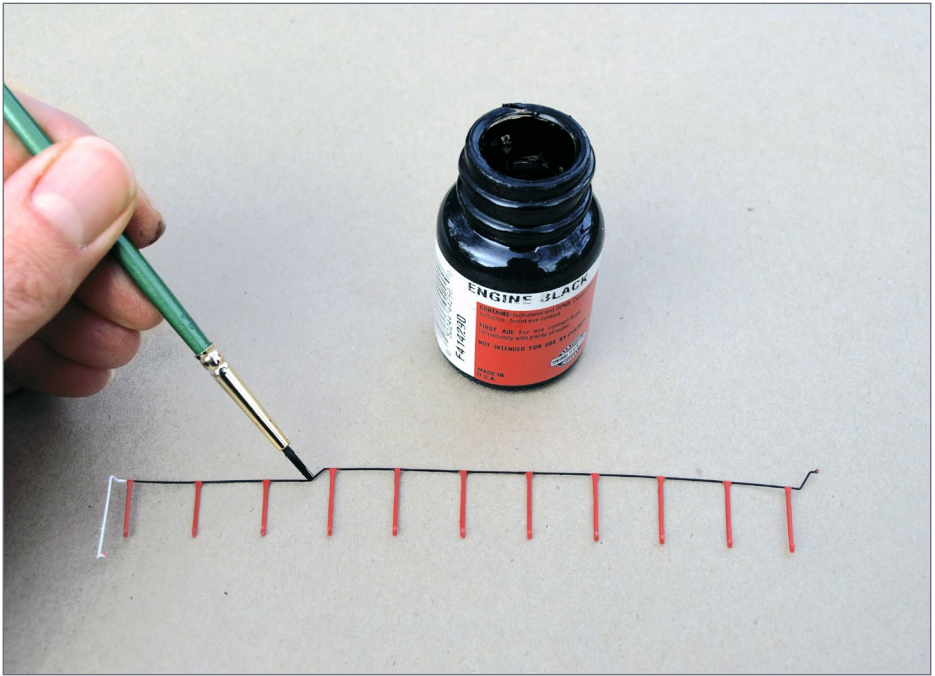

20. Painting a handrail.

Decals

Microscale 87-733 decals provide both engine numbers and safety warnings. Lightly brush Floquil gloss where required before applying decals. Numbers go on cab sides and number-boards. Apply safety decals to the plow, rear pilot, and cab door [19]. Place “F” decals by the front steps [14].

MU hoses

Place MU hoses (Detail Associates 1508) on the front and rear pilots as follows. Paint the hoses black while they are still on the sprue, followed by a dab of stainless steel paint on the fitting at the end of each hose. Drill six #71 holes on each pilot, install the hoses in each hole and affix with cyanoacrylate [12, and 19].

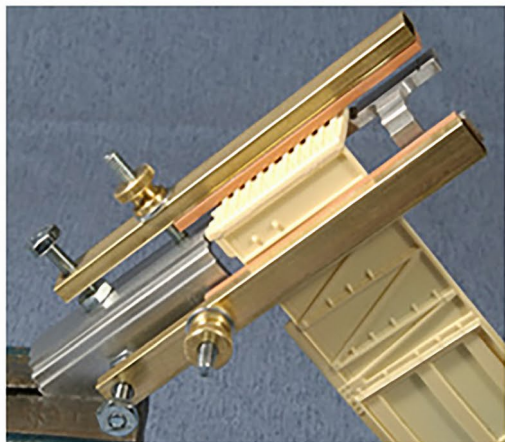
Combo Right Clamp™

Combo Right Clamp™
with cast resin boxcar

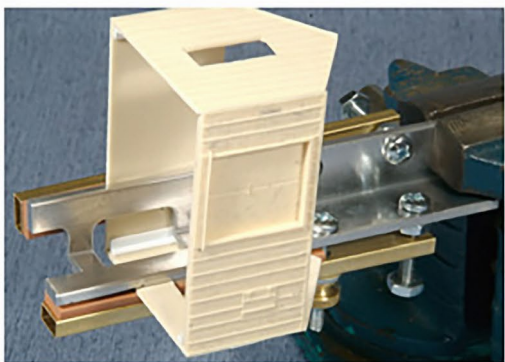

Combo Right Clamp™
with Wolf Design Pump House

**Click here for
all our products ...**

Tools for Modelers

Coffman Graphic Solutions Co.
1500 River Circle, Richmond,
KY 40475-7907

CP RAIL 5406 | 21**Flat finish**

At this point the model should be sprayed with a flat finish to seal the decals in place. Mask the windows with painter's tape. Use an airbrush to spray Floquil semigloss (or similar flat finish) over the entire model shell. Remove the masking afterwards.

DCC wiring

I installed a Digitrax DH163D decoder to allow independent control of the classification lights. This required removal of the Athearn plug-and-play circuit board, and redoing the DCC wiring. I reused the plug-and-play board in another engine.

Reassemble the frame, motor, and drive train components prior to wiring.

In general, it is best to wire one sub-assembly at a time, as described in the following paragraphs. Place the decoder over the rear flywheel to avoid having it above the motor. Where possible, loop the leads

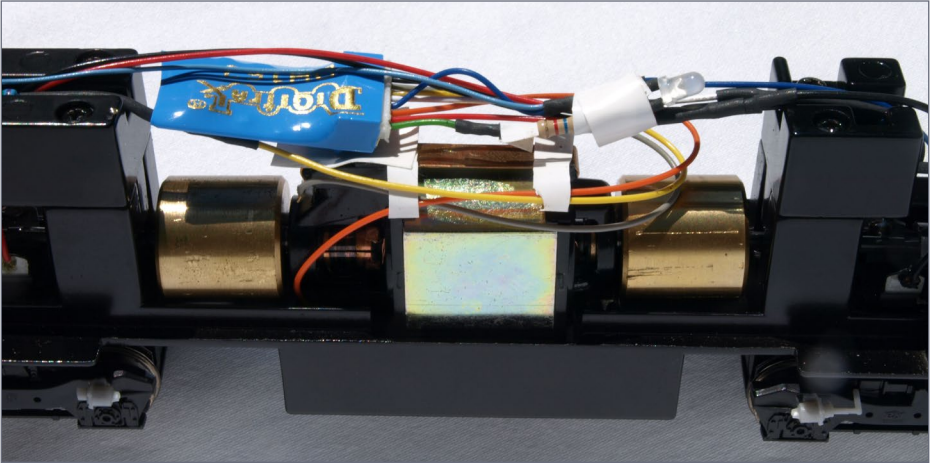

21. Completed wiring with orange and gray motor leads visible.

to allow easy access to the decoder, should it need to be replaced.
For each wire:

1. cut and strip it to fit;
2. slide a piece of 1/16" heat-shrink tubing down the wire;
3. solder the wire connection;
4. slide the heat-shrink tubing over the connection;
5. heat the tubing with a hot air blower.

Motor sub-assembly

Solder the orange and gray decoder leads to each brush clip on the motor. Since the Athearn Ready-to-Roll series was designed with DCC in mind, the motor is already isolated from the frame [21].

Truck leads sub-assembly

Solder the factory installed wire leads from the trucks to the red and black leads of the decoder (red for right, black for left).

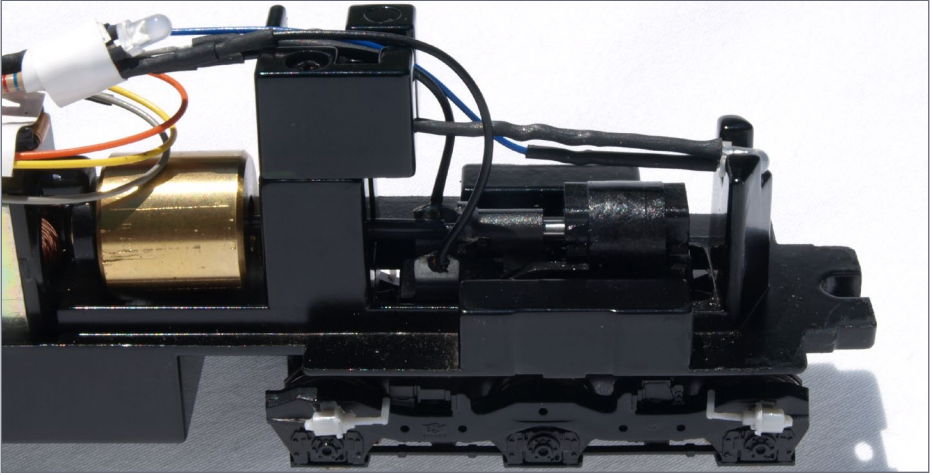

22. Location of front and middle (classification) LEDs.

Headlights sub-assembly

Use 3 mm megabright white LEDs for the front and rear headlights. Solder a 750 ohm resistor to each LED cathode (short lead). Connect the resistor of the front light to the white lead of the decoder, and the resistor of the rear light to the decoder yellow lead [22].

Classification lights sub-assembly

Place the LED for the classification lights in the middle of the engine, just above the front flywheel. Again, use a 3 mm megabright white LED, but with a 5600 ohm resistor on the cathode (short lead) to make it less brilliant. Connect the resistor to the green lead (Function 1) of the decoder. In order to fit the LED in this location trim these wires short.

Common return sub-assembly

Connect the anodes (long leads) of all three LEDs to the blue (common) lead of the decoder. Use blue AWG 24 stranded wires for this.

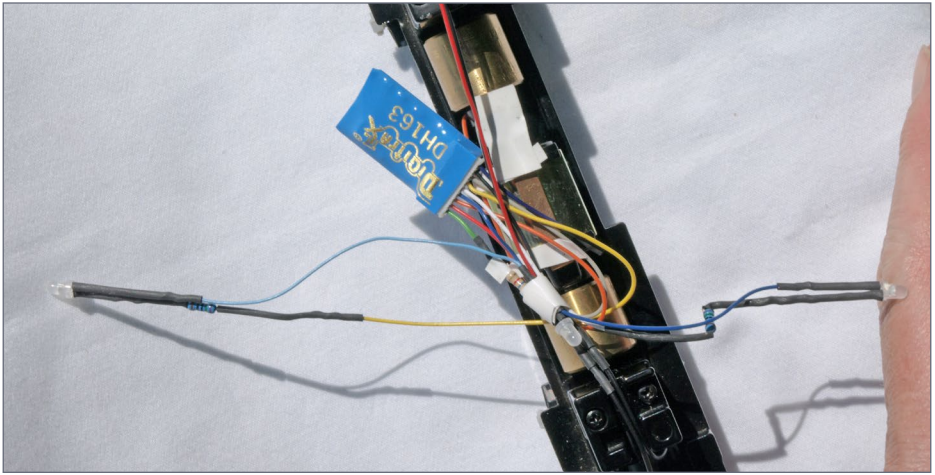

23. Light barriers and fiber optic “Y” harness inside shell.

Soldering the three blue wires to the anode of the middle LED is the easiest way to do this [23].

The violet lead (Function 2) of the decoder is not required. Trim it to one inch and apply a piece of heat-shrink tubing over the end.

Light barriers

Light barriers are needed to prevent light shining through the fans and solid shell. Cut an 11/16” × 2-1/4” piece of 0.030” styrene sheet to fit in the rear hood under the three cooling fans. Paint the top black, then glue it in place.

Add black paint, black PVC tape, and glue aluminum foil to the shell where needed to block light at the LED locations [24].

Lenses

Use Formula “560” Canopy Glue to secure four 7” headlight lenses (Detail Associates 1709) into the holes drilled out earlier in the front and rear headlight housings. Attach two clear jewels (Juneco B-6) in the ditch light housings with small dabs of epoxy.

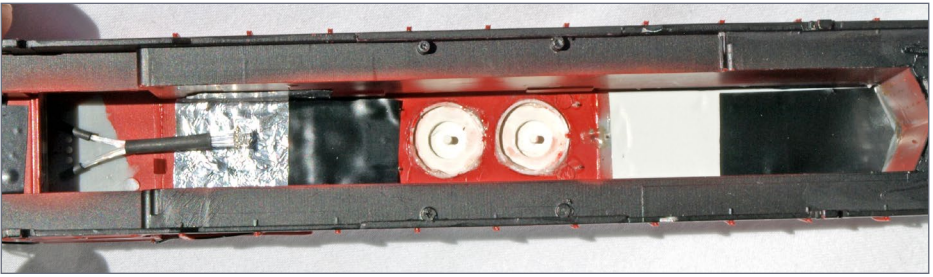

24. Light barriers inside shell.

Classification lights

Remember the holes that were drilled in the cab for the classification lights? Now it is time to give them life. First, fit two 4-1/2" headlight lenses (Detail Associates 1708) into the holes on the cab.

I used fiber optic fibers from a dollar store toy to carry light from the central LED to the classification light lenses. Gather two bunches of fibers to fit into each drilled hole snugly. Slide a short length of 1/16" diameter heat-shrink tubing onto each bunch. Touch the tubing lightly with a soldering iron to shrink it tightly around the fibers. Bind the two bundles into a "Y" with 1/8" diameter heat-shrink tubing.

Fit the two small bundles of fibers into the drilled holes. Cut the fibers at the base of the "Y" harness to sit just in front of the LED [24]. This will require multiple test-fits of the shell to the frame. When the harness fits correctly, make light-gathering lenses at the LED end by touching the fibers lightly on a soldering iron [25].

Affix the 4-1/2" lenses and fiber optic bundles into each drilled hole with canopy glue.

Final assembly

To finish the model, place the shell onto the frame, slide in the coupler pockets, and screw them in. Then slide on the fuel tank

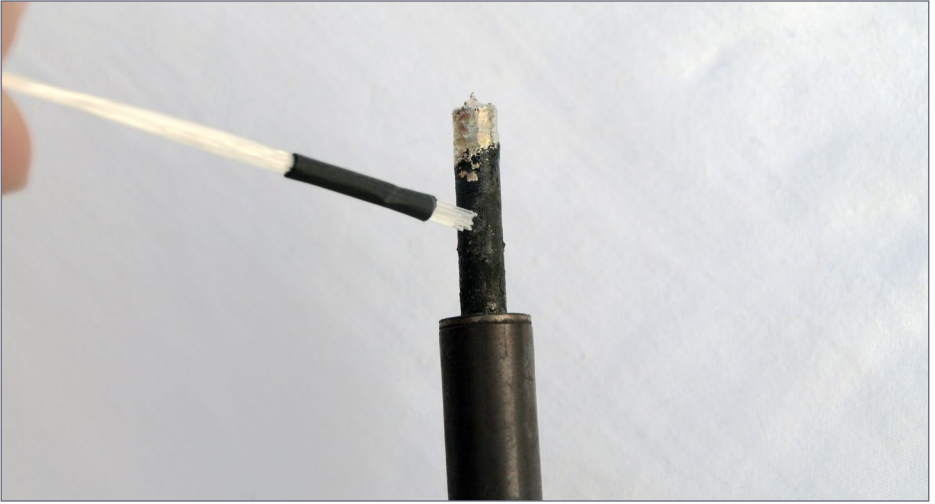

25. Using soldering iron to make light-gathering lenses.



26. Classification lights on.



27. Classification lights off.

and screw it into place. The model is now ready to test on the track. Function F0 will turn the headlights on and off as usual, and Function F1 will turn the classification lights on [26] and off [27].

CP 5406 is now ready to run a hot train through town and country, with white classification lights lit announcing its extra status. I hope you have fun with this model of a unique locomotive!



[Click here to rate or comment on this article](#)

ALEX REED



Alex first became aware of model railroading at seven years old when he saw a mountainous display layout at the Canadian National Exhibition in Toronto, Ontario. A Tyco HO train set showed up under the Christmas tree later that year.

He spent his teenage years doing 1:1 scale traction modeling at the Halton County Radial Railway near Rockwood, Ontario. However, there has always been

an HO model or layout on the go. He is a member of the Calgary Model Railway Society.

Alex is a petroleum engineer and lives in Calgary, Alberta with his wife and two children. He enjoys outdoor activities such as hiking, cross-country skiing and skating.

ADVERTISEMENT

END OF TRAIN DEVICE

NEW SAFETY GREEN

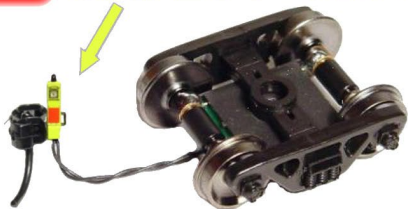

**Bright Red
Flashing Light!**

**Installs in minutes!
No freight car
modification required!**

Patented Technology - US Patent 7,549,609

Does not affect Load!

↓ Car without Load ↓



↓ Car with Load ↓



**Click Here to
Learn More**

**RE RING™
ENGINEERING**

ADVERTISEMENT

Get the latest Model Railroading News, Tips, Reviews & Opinions



**Our iTunes feed has changed search for
"Mike And Scotty Live" to receive the latest episodes!**

www.themodelrailroadpodcast.com

Hosts:

Scott Mason: www.scottymason.com

Mike Rose: www.mrhobby.com

**Don't Miss our Monthly Interviews
& Product Announcements**

• **INDEX**



SUBSCRIBE
(free)

• **TABLE OF CONTENTS**

LIST OF MATERIALS

Manufacturer	Item Number	Item Name
Athearn	93583	CP Rail SD40 (Ready-to-roll)
Details Associates	1506	MU connectors and stand
	1508	MU air hoses
	1708	Headlight lens - 4-1/2" diameter
	1709	Headlight lens - 7" diameter
	1803	Radio antenna, Sinclair
	2205	Coupler lift bars
	2206	3-1/2" Eye bolts (Need two packs)
	2508	Brass wire - 0.028" diameter
	2801	Brake cylinders for diesel trucks
Details West	3102	Fuel tank fittings
	AD-194	Awning
	CF-144	Cooling fan - 48" pan-top type
	PL-235	Snowplow - ATSF, CN
Digitrax	DH163D	Mobile decoder
Floquil	F110014	Crystal-cote (or similar)
	F110015	Flat finish (or similar)
Juneco	B-6	Clear jewels
	C-11	G.P. low hood bell
	C-31	CN & CP diesel drop step
	C-111	DDGM backup light
	B9	CNR brake stand
Miniatures by Eric	L1	Ditch light with lift lugs
	L7	Headlights, double
	S17	Canadian steps
Microscale Decals	87-733	CP Rail diesels (1969-1995)
Pollyscale	F414290	Engine black paint (or similar)
	F110011	Reefer white paint (or similar)
Railflyer Model	DP6032	CPR GP35/SD40 steps
Prototypes		
	DP6621	Assorted class lights

CP RAIL 5406 | 29

Manufacturer	Item Number	Item Name
Evergreen Scale Models	189	Strip styrene 0.125" x 0.250"
True Line Trains	TLT01006	CP Rail Action Red paint
Plastruct	91103	0.030" styrene sheet
3M Bondo		Glazing & spot putty
n/a		3 mm Megabright white LEDs
n/a		Resistors (750 ohm, 5600 ohm)
n/a		Heat-shrink tubing (1/16", 1/8")

ADVERTISEMENT



**CLICK TO SEE OUR NEW WEBSITE!
SAME GREAT SERVICES & PRICES!**

Don't forget to use the **SEARCH** button to search info you want to find

YD Yankee Dabbler

HOME SCALES BRANDS SHIP/RETURNS CONTACT SHOW SCHEDULE

ALWAYS WILLING TO SHARE OUR EXPERTISE WITH FRIENDS

Specializing in DCC • The Best for Less!

Technical Coordination (727) 457-9227 9AM to 9PM EST



CLICK AND SAVE TODAY!

HAPPY MEMORIAL DAY
SUPPORT OUR TROOPS!

Use coupon code "MRH" for FREE SHIPPING
YD installs DCC or RailPro in your engines

Use coupon code "Active/Vet"
FOR ADDITIONAL 5% Discount

• INDEX



SUBSCRIBE
(free)

• TABLE OF CONTENTS

GETTING TO THE FUN PART



Layout progress in the first year

BY NEIL R. SCHOFIELD

Getting past the grind of layout building, and finishing scenery in stages ...

GOING ON MY THIRD LAYOUT NOW, I'VE LEARNED a few things about layout construction and my (lack of) patience for tasks associated with anything other than scenery or operation. I'm much more of a modeler than I am an electrician, carpenter, or member of the track gang, meaning I much prefer getting the layout to a point of operation and scenery than I do

• [INDEX](#)

• [TABLE OF CONTENTS](#)



[Click here to rate or comment on this article](#)

spending significant amounts of time and effort doing benchwork, wiring, or even track work. To me these are just a means to the end for getting to the fun part.

That said, every modeler enjoys different aspects of model railroading and I have friends who enjoy expending the patience and skill that goes into building perfectly constructed benchwork, much the way a finish carpenter enjoys building furniture.

On the other hand, many modelers spend a significant part of the front end of layout construction ensuring the wiring and control system are perfect, right down to color coding and zip ties every 12 inches on the bus wires. That's not to say I don't spend time ensuring my benchwork is designed to support the layout while I'm leaning on it, that I don't finish my scenery to look good, or that my layout barely operates because I've only installed two drops from the bus wire on the entire layout. I do actually spend time doing these tasks appropriately, though I'm more likely to fix something after the fact than get it completely right the first time.

What I model

My layout is primarily based on CP Rail's Lyndonville and Newport Subdivisions in northern Vermont. There is something about red CP Alco and MLW engines operating against the lush green mountains of Vermont that has captivated my interests since childhood.

As much as I enjoy CP Rail's operations, the Boston & Maine's Connecticut River Line extending from Springfield, MA to the



paper mill towns of Berlin and Groveton, NH were nearly as attractive.

While the CP and B&M freight operations on the Lyndonville Subdivision included run-through power on the road jobs, without modeling at least some portion of the B&M, I was limiting my ability to model B&M locals with SW-type switchers and GP-7/GP-9 power.

As my layout design evolved, the modeled portion of the layout that represented the south end of the CP Lyndonville Subdivision at Orleans was already complete, as was the north end of the Newport Subdivision at Richford. Both of these areas on my layout represent a fairly strict adherence to the prototype.

Between those two locations and adjacent to the basement stairs was a vacant area that seemed like a perfect location for the town of Bradford.

Bradford is along the Boston & Maine Connecticut River Line, between White River Junction and St. Johnsbury, VT, about 60 miles south of the line I was actually modeling, so I didn't initially intend to model it. Bradford itself isn't very significant aside from a few feed-related industries, but what drew my attention was the Agway Feed Mill located in town. Operationally, the feed mill was interesting enough to warrant modeling. I had already built the model (see September 2014 MRH). However, when I started building the model, I hadn't committed to a location on the layout. It soon became apparent that the space adjacent to the stairs would be suitable for a fictitious representation of Bradford that could include the Agway mill. Even better, I had several structures from my previous layouts that could be added to the town with a little modeler's license.

As I started work on my third layout, I had several advantages over my first two. First, I had on hand structures, rolling stock,

GETTING TO THE FUN | 4

scenic details, lots of finished trees, and multiple dioramas already assembled. Most importantly, I had experience and knew what benchwork types work for me. I knew the basics of wiring and I had figured out my favorite approach to layout roadbed. Each bit of experience was based on my preferences and financial resources.

There may be better methods for all my techniques, but the experience (or mistakes I've made) allowed me to jump right into the layout knowing what works and what doesn't work for me given my time constraints and financial resources. Ultimately, that's the key to getting a layout to the point of scenery and operation more quickly – which is where the fun begins for me.

ADVERTISEMENT

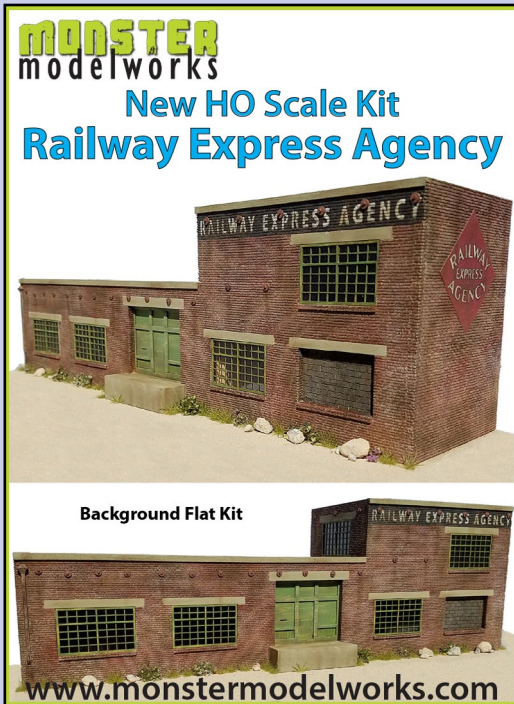

MONSTER
modelworks

New HO Scale Kit
Railway Express Agency

Background Flat Kit

www.monstermodelworks.com

The advertisement features two views of a brick building model. The top view shows a three-story building with a sign that reads 'RAILWAY EXPRESS AGENCY' and a diamond-shaped sign on the side. The bottom view shows a 'Background Flat Kit' version of the same building. The website address 'www.monstermodelworks.com' is at the bottom.

ADVERTISEMENT

Backdrop Junction
Your Stop for Railroad Backdrops

Click Here →

**For the Finest in Custom
Designed backdrop**



www.backdropjunction.com

• **INDEX**



SUBSCRIBE
(free)

• **TABLE OF CONTENTS**

Layout room preparation and benchwork

When I moved into the house in August 2013, many tasks at hand took priority over turning an unfinished basement into a layout room, never mind building a layout. So the first year was spent taking care of the “honey-do list” and making the house a home for my entire family. It wasn’t until May 2014 that I started framing up walls in the basement. Progress was slow but steady for the remainder of the year. By August I had the outside interior walls framed, insulated, and covered with drywall. Over Labor Day weekend, a few friends came over to help me get an initial coat of drywall compound on the walls. By Christmas 2014 I had finished sanding, painting, and installing a drop ceiling over half the basement.



1. Early stage of benchwork for Bradford.

GETTING TO THE FUN | 6

By January 2015 the room was essentially complete and I was able to start benchwork. As I mentioned previously, benchwork construction is only slightly more interesting to me than framing the basement, so my construction technique of open grid supported on heavy-duty wall brackets was fast and efficient for the first part of the around-the-wall layout.

My initial benchwork efforts focused on the modeled town of Orleans, VT. That was the site of a large Ethan Allen furniture factory on the Lyndonville Subdivision, and I modeled it along a linear wall section of my basement. This forms the south end of my railroad before entering staging. However, I knew that the Town of Bradford would be a very manageable section of the layout, approximately 12 feet long and 2 feet deep. Essentially,



2. Underside of benchwork for Bradford

GETTING TO THE FUN | 7

this was a small layout representing the B&M within a larger layout representing the CP Rail, that could be completed in a short period of time. I already had the structures from previous layouts. This would allow me to enjoy some operation early into the construction of the layout as I moved on to other unfinished portions of the layout – which I envisioned would take five or more years to complete.

So, after getting the benchwork up and track down in the town of Orleans, I turned my attention to completing the drop ceiling above Bradford, and starting more benchwork. With walls on either end of the town, I was able to span the entire site with open grid construction with 12-foot long 1x6 pine supported with heavy duty shelf brackets attached to the wall studs, as shown in [1, 2].



3. Completed trackwork in the Town of Bradford with primary structures placed for reference

GETTING TO THE FUN | 8



4-5. Basic backdrop installed and plywood painted to illustrate the rough outline of proposed roads.

Bradford would have backdrops on three sides, meaning both entrances into the scene would have to be hidden behind trees or some other view block. Fortunately, this made the scene manageable and not overwhelming. I could start in one corner and progress to the other corner in a matter of weeks rather than months.

This also served to add distance between Orleans and the rest of the layout, which better represents the geographical distance between the towns. The benchwork and trackwork [3] were built and completed over a single weekend. I survived on about eight hours sleep the whole weekend and paid the price returning to work the following Monday, but the enjoyment of seeing progress far outweighed the sleep deprivation. I also made sure that all the proposed structures were test-fit with the sidings in place.

The backdrop had yet to be installed but that allowed me to work on the track from both sides of the benchwork and expedite the installation process. A few evenings of work later the backdrop was in place and ready for painting.

Scenery in stages: Stage 1

I tend to approach scenery in stages. This allows me to make progress and develop a scene as my imagination sees it. In reality, I can't always see what I want the completed scene to look like until I get a base coat of scenery completed. This means I don't spend a lot of time on making the ground contours perfect. In many cases it's just the opposite. I'll generally plan the early stages of scenery in an eight-hour blitz of pink foam, dry-wall compound, brown paint, and dirt. It's basically an effort to get from a blank canvas to a colored canvas. The following photos show how the scenery progressed in just one day. The results at the end of the day aren't very impressive, but they accomplish Stage I and helped me to visualize how the final scene will look [6-11].

GETTING TO THE FUN | 10



6-7. Foam insulation to form rough terrain and roadway base glued in place.

GETTING TO THE FUN | 11

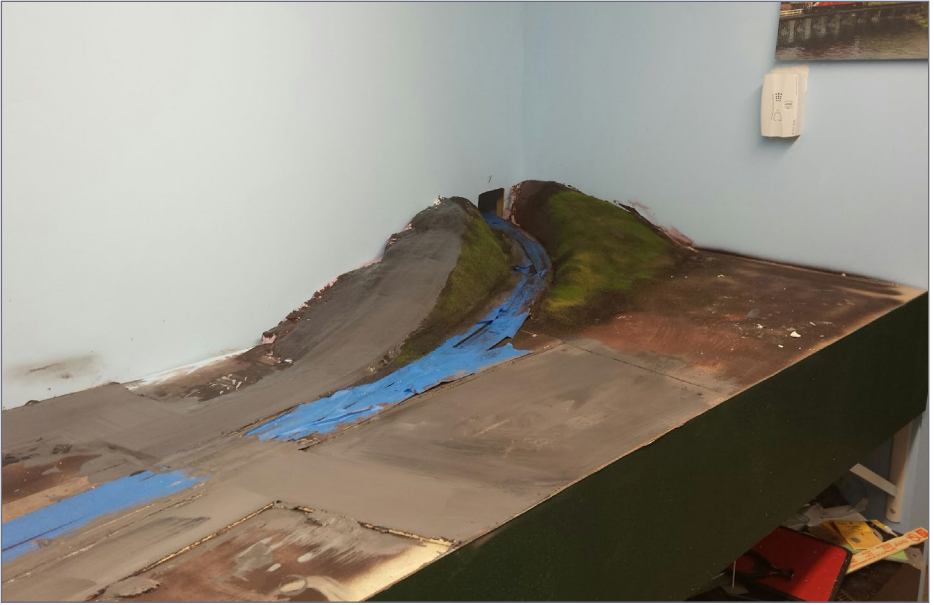

8-9. First coat of ground cover and plaster applied as part of Stage 1 of scenery construction followed by a coat of paint.

GETTING TO THE FUN | 12



10-11. Buildings temporarily placed following Stage 1 of scenery construction.

GETTING TO THE FUN | 13



12. Starting Stage 2 of scenery construction by installing the highway overpass to disguise the entrance through the backdrop along with rock molds.



13. Continuing with Stage 2 of scenery construction by applying an initial cover of static grass, coloring the rock molds, and installing the first trees to hide the transition into the backdrop.

GETTING TO THE FUN | 14

Getting the area to this level of completion allowed me to slow down and focus on one scene at a time starting from the back towards the front with the intention of hiding the tracks ducking into the backdrop. Getting past this stage required a few weeks to design and build a bridge to hide the tracks disappearing on the right side of the town, but once past this stage I was able to quickly turn the scene from rough scenery to a semi-completed scene.

Scenery in stages: Stage 2

In [12, 13], the rough pink ground foam and plaster has been refined to get the correct bridge height. I've installed some Woodland Scenics rock molds on either side of the cut to add some interest and added sieved dirt to cover the plaster.



14. Wrapping up Stage 2 of scenery construction, the overall scene is developing and with the addition of details and signs the scene will start to look finished.



15. Looking towards the Agway side of the town, the base coat of the gravel parking lot is in place.

A few evenings later, I added some static grass to the field on the right side of the bridge, and started placing trees to hide the background and blend the bridge into the backdrop. Completing this corner allowed me to move on to the foreground. Within a few weeks I had a semi-completed scene covering half the town, to the right of the grade crossing. It's at this point in the scenery construction the scene starts to develop for me, and all that's left is lots of trees and details.

I was also able to make some good progress in the town since two of the railroad-served industries contain large parking areas. These are finished with inexpensive sieved concrete mix to represent gravel parking lots [14, 15].

GETTING TO THE FUN | 16

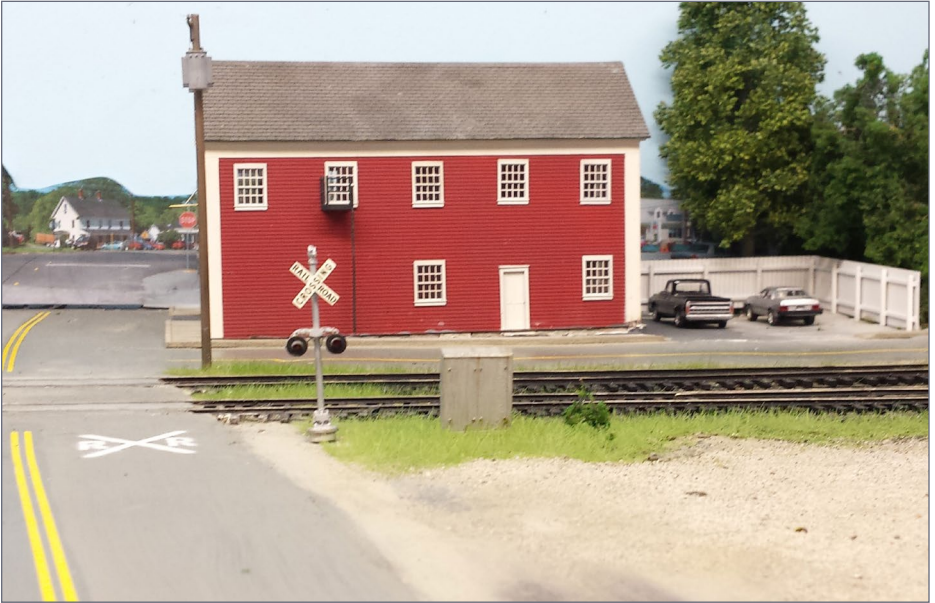

16-17. Before and after photos illustrating the effect of signs and details in stage 3 of Scenery.



GETTING TO THE FUN | 17



18-19. Before and after photos illustrate the effect of installing backdrop photos, which greatly expand the look of Bradford.



20. Looking down Route 25 and the backdrop transition. Note the curbing on the left hand side has yet to be glued. Also note the gas prices, which help to establish a time frame.

Scenery in stages: Stage 3

Details can really bring a scene to life [16, 17]. These extra details include things like roadway striping, grade crossing signals, building signs, roadway signs, and telephone poles.

Fortunately I had many of these supplies on hand from my previous layouts. Adding signs to some of the buildings, like my fictional Bradford Country Store, involved searching the internet for images of Vermont country stores.

In just an evening's work, by printing the pictures and signs on photo paper, I had created signs to make my Bradford Country Store a believable center piece of the town. I had used a similar



21. Prototype barn photographed in Vermont and used as a backdrop photo shown in photo 22.



22. The tracks transition through the backdrop with a barn photo in the background to expand the overall scene and cover up some of the blue sky.



23. Bradford nearly complete, looking towards the Agway Feed Mill.



24. Overall completed town of Bradford looking towards the highway overpass transition with Agway Feed Mill in the foreground.

approach for a sign on the local auto repair station, named after a co-worker who had an amazing ability to fix anything.

Using backdrops

As scenery progressed, it came closer to the time I would have to address backdrops and where to use them on the layout. Originally, my intention was to just install a photo backdrop for the main road, Vermont Route 25, which crosses the tracks in the center of the town and runs directly into the backdrop. I had some initial ideas of how make this work, but it wasn't until this stage that I felt a field trip to Vermont to capture the photo I was looking for would be worthwhile. About the same time, I found a photo I had taken about 10 years ago but never had a place for it on my previous layouts. I took some quick measurements and within an hour had the photo temporarily installed. The before and after results are in [18-19]. The photo instantly expanded the small Bradford layout into a much larger scene.

With the success of the initial backdrop photo, I added several smaller photos to address the Route 25 grade crossing [20]. Study photo [16] and the overall effect of the backdrop photo in expanding the depth of the scene can be easily appreciated. While I've seen much more effective backdrop transitions, I was pleased with the overall effect. With the backdrop for the central part of Bradford resolved, I turned my attention to the right side of the scene and found a good barn photo to help expand the farm field and give a nice backdrop for trains exiting under the roadway overpass [21, 22].

Bring it together and call it done

After completing Stage 3 of the scenery with details and backdrops, it's time to enjoy the effort, and stand back and enjoy the overall layout of Bradford from both ends [23, 24]. At this stage, it's an opportunity to run a B&M local out to switch the Agway

GETTING TO THE FUN | 22

Plant [25] or enjoy a Boston & Maine run-through with the CP Rail [26] as it blows for the crossing of Route 25.



25. Let the Fun Begin: B&M SW9 switching the local Agway Feed Mill.



26. Run-through CP Rail power rolls through town and past the local lumber and feed dealership.

NEIL R. SCHOFIELD



Neil Schofield lives in Charlton, MA with his wife, three children, and the family dog. He works in Holyoke, MA as a Senior Project Manager for an environmental consulting firm.

This is Neil's third feature in MRH. Thanks to his father, Neil has been interested in trains since he was 6 or 7. His childhood memories include many railfan trips throughout the Northeast, along

with fond memories of operating modern piggyback cars on his father's steam-era layout.

Growing up, he was a self-proclaimed rivet-counter when it came to rolling stock and locomotives. Since layout building commenced, the rivet counting has diminished in favor of getting trains running, building scenery, and structures. He's now about two years into his third layout that is based on CP Rail operations in Vermont. He has already installed his Agway Feed Mill featured in the September 2014 MRH magazine, and he is hoping to present the layout in a future MRH article.

While he enjoys modeling CP's operations in Vermont, he also occasionally strays toward other prototype modeling, generally railroads found throughout the northeast.

When he's not working, attending one of his children's sporting events, or modeling, he enjoys exercising and watching Boston's sports teams.



[Click here to rate or comment on this article](#)

The MRH Media family

**Model Railroad
Hobbyist magazine™**

mrhmag.com

store.mrhmag.com



trainmasters.tv



Browse the MRH forums ...

More helpful insights and advice!

Model Railroad Hobbyist magazine™
mrhmag.com
Magazine Advertisers Goodies News/Events Authors Help Staff only

New book series ... [Learn more](#)

Google™ Custom Search

[SEARCH](#)

Home / Recent posts

Recent posts

All recent posts
My recent posts

Type	Post	Author	Replies	Last updated
Topic	Soldering question new	DSteckler	2 2 new	1 min 16 sec ago
Blog	The Breitenbach - Rosenheim Railroad Version II	michaelrose55	885 7 new	3 min 2 sec ago
Blog	Resin Casting with Two Part Molds	Benny	34 8 new	12 min 38 sec ago
Topic	Pacific Northwest RPM Date 2017	ctown2gn19	5 3 new	16 min 36 sec ago
Blog	Hawaii Island Railroad	umauma railway	175 24 new	20 min 9 sec ago
Topic	Buffering Speed Unwatchable	DWC	11 1 new	26 min 44 sec ago
Topic	You get what you pay for	GregW66	3 2 new	27 min 9 sec ago

- ▶ Get current issue
- ▶ Recent posts
- ▶ Recent posts by type
- ▶ Make a web post
- ▶ Blogs
- ▶ Discussion forums
- ▶ Community
- ▶ My account
- ▶ Contact us
- ▶ Log out

Recent blog posts

• INDEX



SUBSCRIBE
(free)

• TABLE OF CONTENTS

Universal modeling sizes chart

**FREE
SUBSCRIBER
BONUS!**

(To become a subscriber, click the subscribe button in the page footer ...)

BY THE MRH STAFF

If you model in Z, N, HO, S, or O scale, get this chart and keep it handy while you model ...

MRH HAS COMPILED A UNIVERSAL MODELING chart that subscribers can download for free [[bonus extras](#)].

This four-page chart has English (inches) and metric (millimeter) measurements mapped to scale measurements in the five most common scales (Z, N, HO, S, and O). If you've ever wondered what one inch in S scale is, for example, you can look it up on this chart in an instant [2]:

• [INDEX](#)

• [TABLE OF CONTENTS](#)



Click here to rate or comment on this article

1" in S Scale = 0.016", or 0.406mm.

But that's not all! You can also see that to make a 1" hole in S scale, you need a 1/64" or #78 drill. You can also see that AWG 26 gauge wire will just fit into this hole and simulate a 1" rod or pipe in S scale.

When we compiled this conversion chart, we added some "smarts" to it. When you drill a given sized hole, for example, the wire that fits into the hole is always no larger than the hole, and often it's just an ever-so-slight ten-thousandths smaller. In other words, we rounded the proper direction on any ten-thousandth's dimension when it comes to drilling holes and using wire sizes just to ensure you can't drill a hole too small for a wire.

In addition, this chart includes screw sizes and the respective drill size needed for either a hole to tap with threads or a hole you want to drill that's clear (allows the screw to just slip through).

This chart starts at one thousandth of an inch and goes all the way to one quarter of an inch, increasing one thousandth of an inch at a time. Anything greater is large enough to measure with a scale rule or even with a standard tape measure.

English (in)	Metric (mm)	Drill Sizes			Wire AWG	Screws		Scale dimensions					
		ANSI	ISO	Decimal		TAP	CLEAR	Z	N	HO	S	O	
0.015	0.381	-	.40	-	27	-	-	-	-	-	-	-	3/4"
0.016	0.406	78	-	1/64	26	-	-	3-1/2"	2-1/2"	-	1"	-	-
0.017	0.432	-	.45	-	-	-	-	-	-	1-1/2"	-	-	-
0.018	0.457	77	-	-	25	-	-	4"	-	-	-	-	-

2. The red box shows an example of the info that's available on this chart.



Window bars from tape



BY GENE LETOURNEAU

An easy and fast way to bar your windows ...

MANY OLD PHOTOS I HAVE SEEN OF RPO AND extension mail cars use window bars to protect the mail and other valuables during shipping. I recently stumbled on a method to

• [INDEX](#)

• [TABLE OF CONTENTS](#)



**Click here to rate or
comment on this article**

replicate these bars while kitbashing a CB&Q Baggage-Mail Express car out of a troop kitchen car.

The Denver Library's online collection has a great prototype photo of CB&Q 8899, an ex-US Army car converted to express-baggage service after WWII. Note the window bars installed across all main windows, including the door.

digital.denverlibrary.org/cdm/fullbrowser/collection/p15330coll22/id/63290/rv/singleitem

There are super-detail parts available from Kit Bits and Blair Line that can be mounted inside or outside the windows to add this detail. Unfortunately, there are many limitations to what I have access to at local hobby shops here in Hamilton, Ontario, and online shipping to the Great White North is getting pretty expensive now.

I found that reinforced packing tape gives a plausible effect when mounted to the inside of the window glazing before gluing. The tape I found which works quite well is available at Canadian Tire (a common Canadian hardware store), and is manufactured by Cantech. An equivalent is likely available at a hardware or office supply store in your country [1].

The great thing about this tape is that it is clear, unlike many cellulose tapes that are frosted/opaque. I chose the roll on the store shelf which had the most equal spacing between the reinforcement strands (some of the tapes had spacing which were quite unequal). I cut off a piece, pick a section for the best "security bar" spacing, and stick it to the glazing material, applying pressure with the back of my fingernail evenly to avoid bubbles. Then



WINDOW BARS FROM TAPE | 3

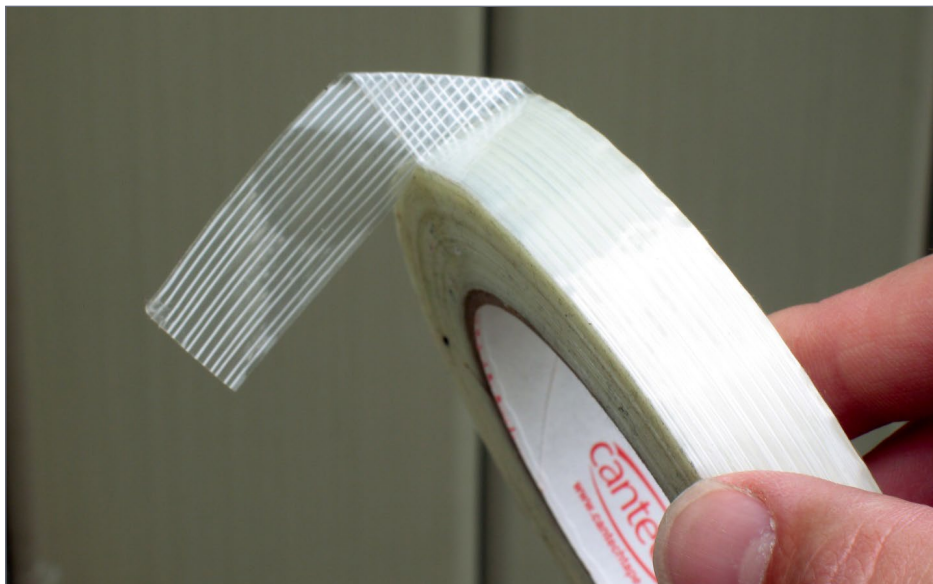

1. Ordinary reinforced packing tape is the key.



2. Walthers Troop Kitchen Car as rebuilt by CB&Q post-war.

WINDOW BARS FROM TAPE | 4

I glue the window inside the car body using a little CA cement, with the tape on the side facing the inside of the car. Depending on the manufacturer, too much CA can sometimes fog the edge of your window, but it can usually be repaired by brushing on a little Future floor wax to the affected area.

Photo 2 is a Walthers Troop Kitchen Car I converted to a CB&Q baggage-mail (for eventual service on an SP San Francisco Overland, which I am slowly assembling). Decals are Microscale, and paint is TruColor Pullman Green. The tape does a great job of representing the window bars, and it shows up well on the model.

I also recently finished a New York Central RPO I built for my old man for Father's Day. It's an old JC Silver Sides metal-stamped kit with a kitbashed IHC roof [4].

Trucks are Walthers, decals are Microscale again, and paint is Model Masters US Helo Drab (which is a very close match to Branchline's Pullmans).



3. Instant window detail – fast and easy.

WINDOW BARS FROM TAPE | 5



4. A New York Central RPO that I built for my Dad.



5. Eliminating bubbles in the tape makes for a cleaner look.

WINDOW BARS FROM TAPE | 6

Hope this gives you some ideas for different uses for this tape. The window bars add a small yet unmistakable detail element to the windows. The process is much easier and faster than trying to arrange small wire stock, and a roll of the tape is cheap. Plus, the whole roll should last me until my kids are building cars for me for Father's Day!



[Click here to rate or comment on this article](#)

GENE LETOURNEAU



Gene has been into Southern Pacific since receiving the ubiquitous HO Lionel GS-4 Daylight for Christmas in 1977. He enjoys all aspects of modeling, from the technical to the artistic.

When he's not cluttering up the dining room table with Vanderbilt tenders and Harriman roofs, he also enjoys the local arts scene, old guitars and amps, vintage vinyl and

audio, and craft beers.

He lives in Ontario, and serves the public as a Meteorological Technologist with Environment and Climate Change Canada. He has two wonderful boys and a very loving and tolerant wife.



WISH: Shadow expert home layout builders and learn their best tricks ...



MODULE 1
2.5' X 7'

MODULE 3
2' X 7'

GRANTED:

In the 2017 TMTV season, we do just that.



Brought to
you by
MRH
MODEL RAILROAD HOBBYIST

TRAINMASTERS.TV

Don't miss out: Click now and join in!

Trackwork provided by



atlasrr.com

• INDEX

• TABLE OF CONTENTS

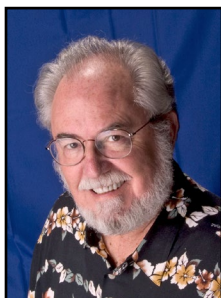

MAY NEWS

column

RICHARD BALE *and* JEFF SHULTZ



[Click here to rate or comment on this article](#)

Daniel David Peterson 1962-2017



Dan Peterson passed away suddenly at home in Apple Valley, Minnesota, on March 28, 2017. He was 55 years of age. Dan was the owner of San Juan Decals, a line of thin film silk-screened decals that focuses primarily on narrow gauge railroads including Rio Grande, Colorado & Southern, and Rio Grande Southern.

Dan purchased the well-regarded line of decals from Warren Griffith about five years ago. In recent years Dan has expanded the product assortment to include On3 multi-media rolling stock kits and laser-cut wood structure kits.

Dan's wife, Donna, is committed to maintaining the decal business. A final decision on continuing the laser-cut portion of the

▶ THE LATEST MODEL RAILROAD PRODUCTS, NEWS & EVENTS

• INDEX



SUBSCRIBE
(free)

• TABLE OF CONTENTS

family business is pending. Dan earned his bachelor of science in geophysics and geology from the University of Wisconsin in his home town of Madison. He was a quality assurance analyst for various semiconductor plants, including Intel and Agere, before pursuing a life-long dream of a career in model-railroading ...

.....

NEW PRODUCTS FOR ALL SCALES

Model Railroad Control Systems has announced its Integrated Turnout Controller (ITC). The ITC provides remote and local operation and locking of model railroad turnouts. Operable as a standalone turnout controller, it can also be controlled by a computer. The board has LED outputs with current limiting resistors as well as outputs for frog power switching. More information on all Model Railroad Control Systems products can be found at modelrailroadcontrolsystems.com.

.....

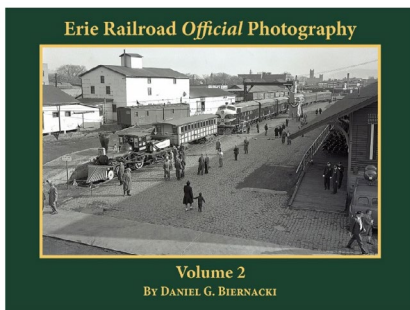

Morning Sun Books has released *Official Erie Railroad Photography, Volume 2*. Chronicled during the postwar years by company photographers with unlimited access to Erie operations, the large format black-and-white photographs present a richly detailed history of activity and equipment. Additional hardcover books just released by Morning Sun include *Reading Company Power*, by Robert L. Davis, Jr., and *Grand Trunk Western Power*, edited by Stephen M. Timko. For additional information on all Morning Sun products visit morningsunbooks.com.

.....

MAY NEWS | 3

The Operations Special Interest Group (OpSIG) has published a new book *A Compendium of Model Railroad Operations from Design to Implementation*, a new book on operations. Written by 10 experienced operations specialists, the 310 page book covers every aspect of prototype operations and how to apply them to a model railroad. Yard design, staffing, paperwork, communications, signaling, dispatching, and car forwarding are all covered. To order contact Steve Benezra at opsig.editor@gmail.com.

.....



SoundTraxx' new Digital Sound Decoder Catalog is now available on line. The 20-page catalog covers Tsunami2, Econami, and Tsunami SoundCar, and installation accessories. In addition to product photos, the catalog incorporates detailed diagrams of the decoders' technical specifications and installation photos. It is available at soundtraxx.com. Hard copies can be requested free-of-charge from sales@soundtraxx.com or by phone at (970) 259-0690.

.....

New from **Speedwitch Media** is Volume Three of the Steam Era Freight Cars Reference Manual, covering cars of Pacific Fruit Express, Santa Fe Refrigerator Despatch, American Refrigerator Transit, Fruit Growers System (FGEX/WFEX/BREX), Union Refrigerator including GARX, North Western Refrigerator Line, Northern Pacific, Western Refrigerator, Mather, meat reefers, and others. For more information on Speedwitch Media products visit speedwitchmedia.com.

.....

O SCALE PRODUCT NEWS



Atlas O has announced new items scheduled for release during the fourth quarter of this year. Heading the list are ACF three and

six bay covered hopper cars. Special details include operating hatches, see-through roof walks, separately applied grab irons and brake detail, and 100-ton sprung diecast roller-bearing trucks with rotating bearing caps. Two road numbers each will be available for Burlington, Burlington Northern, New York Central, Koppers Plastics, SHPX-Shell, Chessie System (B&O), and Burlington Northern.

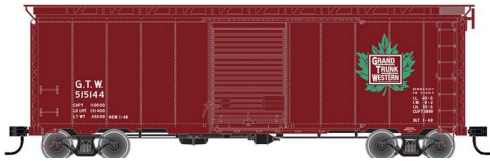

Also coming from Atlas O late this year is a group of ACF 40-foot steel boxcars with Youngstown sliding

doors. In addition to the Grand Trunk Western scheme shown, the ready-to-run model will be available decorated for Toronto, Hamilton & Buffalo; Nickel Plate Road, Norfolk & Western, Penn Central, and Western Pacific. All Atlas O models are available with appropriate trucks for either 2-rail or 3-rail operation. For additional information contact a dealer or visit atlaso.com.



Precision Vintage Classics has introduced Sn3 and On30 kits for an ore car designed by Bryan Ellerby. The sides of the car are injection-molded plastic.

MAY NEWS | 5

The frame and ends are cast resin. Kadee couplers and MDC trucks with Fox sideframes complete the kit. Decals are not included.

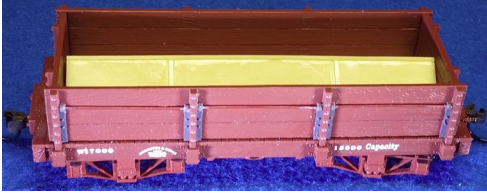

Also new from Precision Vintage Classics is a resin-cast kit to convert a Bachmann 18-foot 3-inch gondola into an A-Frame gondola. The kit includes the basic "A" casting, hinges, and a hinge rod. For additional information visit pvc-sn3.com.

.....



Rusty Rail has introduced two new junk piles of cable reels. The items consist of unpainted cast resin. The O scale figure, which shows the relative size of the detail parts, does not come with the casting. The group on the left measures 2 x 1.5-inches by 1.125-inches tall. The casting on the right is 2.5 x 1-inches by 1-inch tall. For more information visit rustyrail.com.

.....

HO SCALE PRODUCT NEWS

Accurail has released HO scale kits for four versions of its new 36-foot double-sheathed wood boxcars with steel roofs and fish



MAY NEWS | 6



belly underframes. A kit for a Missouri Pacific car with steel ends built in 1926 is available now. It is based on

a prototype rebuilt during WWII. A similar car painted but lettered with white data only is also available. Since it has no road name it is well-suited for lettering for any railroad a hobbyist might want.



A 36-foot car with wood ends is available decorated for Baltimore & Ohio. It is based on a prototype built in 1925 and rebuilt in 1942.

As with the MP car, the B&O version has double-sheathed wood sides, a steel roof and fish belly underframe. A virtually identical car painted but lettered with data only is also available now from Accurail. Eric Hansmann has prepared a tutorial to simplify assembly of the underframe on Accurail's new 36-foot cars. It is available at accurail.com/accurail/INSTR/36ftUnderframe.pdf.



Other new HO scale kits released by Accurail include a trio of privately owned ACF hopper cars. The limited run three-car set includes models decorated for ACFX-Continental Grain, ACFX-Cargill, and FLIX-Coop. All Accurail kits include appropriate trucks and Accumate knuckle couplers. For additional information contact a dealer or visit accurail.com.

MAY NEWS | 7



Athearn's all-new SDP40F diesel locomotive is on schedule for release in July. The Genesis model replicates a prototype introduced by EMD in 1973. Designed specifically for long-haul passenger service,

the SDP40F was Amtrak's first new locomotive. The SDP40F looks like an FP45 with the radiators moved forward to serve the smaller 16-cylinder prime mover. The earliest prototype units had a pointed nose; later ones were flat. Athearn's introductory model will have the flat face with a pointed nose scheduled for a later production run. Athearn is releasing four Amtrak models in slightly different schemes.



In 1984, Santa Fe traded some lower-powered locomotives to Amtrak for 18 SDP40F engines. They were reconditioned in ATSF's San Bernardino shops with new bolsters, the ballast and water supply were rearranged, and most importantly, they were regearred for freight service. Santa Fe christened them SDF40-2. Athearn's July release includes four Santa Fe road numbers.



Athearn's production schedule for next January includes Phase I and II versions of FP7 passenger diesels decorated for Soo Line and Southern Pacific in the Black Widow scheme. A Phase I B-unit will also be available for SP. Although these early EMD



MAY NEWS | 8

models were intended for passenger service, they served most of their careers hauling freight.



Athearn has added three Spokane Portland & Seattle GP9 diesels to its January schedule. The HO scale Genesis series models will be wired for operation with the long hood forward. SP&S road numbers will be 150, 153, and 154. All Genesis sound-equipped locomotives feature an onboard DCC decoder with SoundTraxx Tsunami2 sound. The sound unit will operate in both DC and DCC. DC only models are DCC-ready with both 8- and 9- pin connectors for an aftermarket decoder.

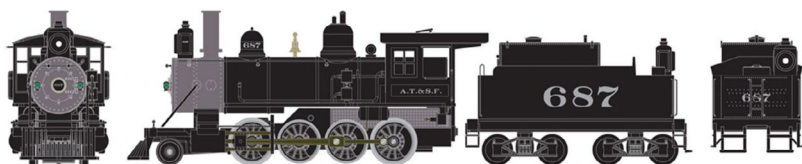

Athearn will release an early 20th century 2-8-0 Consolidation steam locomotive in February. The HO scale Ready-to-Roll model is a significantly upgraded version of a locomotive introduced several decades ago by MDC Roundhouse. The locomotive will be available for DC operation as well as fully equipped for DCC with Econami Sound by SoundTraxx. Road names will be Santa Fe, Baltimore & Ohio, Canadian Pacific, Denver & Rio Grande Western (yellow scheme), New York Central, and Union Pacific.

Also due next February is a group of post-WWII 40-foot steel boxcars fitted with Superior seven-panel sliding doors. Road names will include Chicago, Burlington & Quincy; Toledo, Peoria

MAY NEWS | 9



& Western; Chicago & North Western (FDDM&S reporting marks), Reading, Southern Pacific, Western Maryland and, as shown here, CIL-Monon.



Additional Ready-to-Roll models coming in February are a group of PS 4740 cu. ft. covered hopper cars. They are based on a prototype Pullman Standard produced in 1967. Athearn's HO scale version will be available decorated for Santa Fe, Chicago & North Western, Great Northern, Illinois Central, Milwaukee Road, Frisco, and Northern Pacific. Models decorated for Rock Island will be available as shown here as well as in Athearn's Primed for Grime scheme with faded base colors matching in-service prototypes.



A selection of 20-foot containers will be included in Athearn's February release. The International (ISO) containers can be stacked up to ten units high and secured by the cast twistlock fixtures at each of the eight corners. Athearn will offer the containers in three-packs decorated for Xines, American President Line, China Shipping, CMA-CGM, Cronos, GE Seaco, Maersk, PIL, TEX, Touax, and Tropical.



MAY NEWS | 10

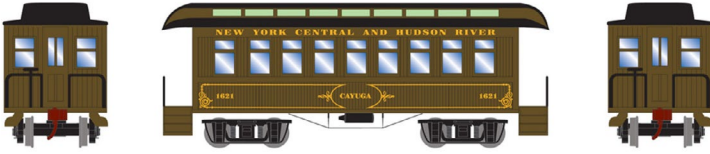

Roundhouse brand products coming from Athearn early next year include some updated truss rod-era cars suitable for operation with the 2-8-0 steam locomotive listed above. Overton 34-foot coaches will be released individually as well as in four-car sets with a baggage car, combination car, and business/observation car. Features of the HO scale ready-to-run models include clear window glazing and appropriate trucks with machined metal wheelsets. Road names will be New York Central & Hudson River, Santa Fe, Baltimore & Ohio, Canadian Pacific, Rio Grande, and Union Pacific.



The February release from Roundhouse will include 36-foot double sheathed wood reefer cars decorated for Pacific Fruit Express, American Refrigerator Transit, SFRD-Santa Fe, Grand Union, Mathieson Dry Ice, and Schlitz Beer.

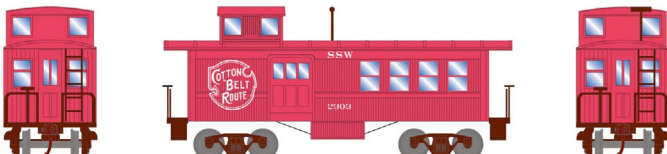

Completing the release of truss-rod era cars is a drover's caboose. The car has a side door for handling road supplies and LCL (less than car load) freight. It is equipped with clear window glazing and appropriate trucks with machined metal wheelsets. In addition to the Cotton Belt – St. Louis

Southwestern car shown here, the HO scale ready-to-run model will be available decorated for Santa Fe, Baltimore & Ohio, Canadian Pacific, Rio Grande, New York Central, Union Pacific, and Virginia & Truckee. For additional information on all Athearn and Roundhouse brand products contact a dealer or visit athearn.com.



Atlas is quoting a fourth quarter release date for the next run of its Trainman Plus series NRE Genset II locomotive.

Power for these contemporary locomotives is generated by two or three independent diesel engines that produce up to 700 HP each. The engines engage and disengage as more or less horsepower is required. Their low emissions and reduced fuel consumption make them popular in metro areas where air pollution is a concern.



New road names on Atlas' HO ready-to-run model will be Amtrak (blue & silver), Modesto & Empire Traction,

Tacoma Rail, and Metro Ports of LA. Repeated road names with new numbers include CSX, and Indiana Harbor Belt.

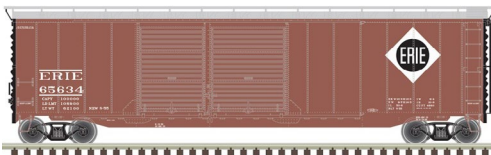

Also due in the fourth quarter is a new release of this 50-foot double door steel boxcar. The car has extended fish belly side sills

and paired 7- and 8-foot Youngstown sliding doors to cover the 15-foot opening. Depending on the practice of the prototype road being modeled, the cars will have steel Dreadnaught, Improved

Dreadnaught, or “Dartnot” ends. Road names will be Detroit, Toledo & Ironton (two different schemes); Grand Trunk Western, Kansas City Southern, Southern Pacific, Wabash, and Erie.

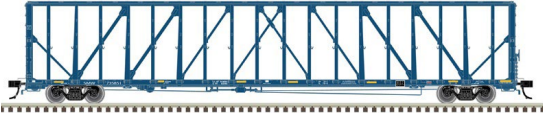

Atlas has scheduled the next release of its 73-foot FBC center partition car during

the fourth quarter of this year. Commonly referred to as center-beam flatcars, the prototype is designed to load, transport, and unload lumber, gypsum board and other construction products efficiently. Details on this feature-laden HO scale ready-to-run model include simulated tie-loops, ratchets, cable hooks, wire brake rods, detailed jacking pads, see-through top chord holes, wire grabs, and etched crossover platforms. Road names will be First Union Rail, St. Mary’s Railway West, TTX, Utah Central Railway, Union Pacific, and Wisconsin Central. For more information on all Atlas products, visit atlasrr.com.

.....



Fos Scale Models is selling The Pub Crawl, a craftsman-style kit for a row of four bars. The HO scale kit includes laser-cut clapboard walls, plastic windows, laser-cut sidewalk, roof

cards, metal detail parts, and numerous color signs as shown. Alternative signs are also included for businesses other than bars. The completed building has a footprint of 4 x 9 inches. Vehicles and figures are not included. For additional information visit fosscalemodels.com.

.....

MAY NEWS | 13

.....



InterMountain's fall release includes a new run of HO scale ACF Type 27 riveted 8,000 gallon tank cars. New road names include Kanotex

Refining on an aluminum body. New road names on black bodies will be Union Pacific, Mobile Rosin Oil, Mathieson Alkali Works, and North American Car Corp.



Previously released road names being reissued with new numbers include Spencer Kellogg, Harbor Tank Line, Union Tank Car, and

Canadian General Transit, all with black tanks.



Completing the run will be a Stauffer Chemical car with a silver tank and a black waist band. The HO scale ready-to-run models will feature

Kadee couplers and InterMountain turned metal wheelsets. For additional information contact a dealer or visit intermountain-railway.com.

.....



Later this summer **Kadee** will release two versions of its 50-foot PS-1 steel boxcar with double sliding Youngstown doors covering a 15-foot opening. First up will be a Denver & Rio Grande

Western car as built in 1957 and shopped in November 1967.



MAY NEWS | 14

.....



It will be followed in September with the release of a Western Pacific car in factory-new paint as built in 1954. Note the extended

side sill on the car and the 12-panel welded sides.



Kadee has scheduled an August release date for an HO scale ready-to-run version of this black Reading twin-bay coal hopper. Built in 1948, the AAR 50-ton car has flat ends and offset sides.

All Kadee HO scale ready-to-run models come with Kadee couplers and two-piece self-centering trucks. For additional information contact a dealer or visit kadee.com.

.....



KatoUSA has added road numbers 91 and 150 to its lineup of General Electric P42 Genesis Phase Vb locomotives. Features of the

HO scale ready-to-run model include coreless truck-motor drive, pre-printed number boards, and directional headlights and tail lights making it suitable for push-pull service. The model is available for standard DC operation or with either Soundtraxx or ESU Loksound DCC and Sound. For a detailed review of the coreless dual motor drive visit youtube.com/watch?v=ILK2tKssj5M. To view the operating capability of the P42 go to youtube.com/watch?v=MacUY1_YjeU. For additional information contact a dealer or visit katousa.com.

.....

MAY NEWS | 15



Monster Model Works has introduced a structure kit for an HO scale Railway Express Agency. The kit makes into a flat background building

that is just 3.4 inches deep by 12.25 inches long. Components in the kit include 3D laser-engraved aged American brick walls and corners, laser-cut freight door, peel & stick windows with glazing, precut bracing, a sign stencil and printed REA sign. Assembly instructions, including weathering tips, completes the kit. For more information visit monstermodelworks.com.



Rusty Rail has released a new junk pile suitable for an HO scale work yard or lumber mill area. The item is cast resin and is sold unpainted. The item measures 3 x 2 inches. For more information visit rustyrail.com.



ScaleTrains.com has announced plans to produce a Gunderson 5188 cu. ft. covered hopper. Ready-to-run HO scale models will be available in both Operator and Rivet Counter series with delivery planned

for October. The model is based on prototype plans and features numerous road-specific details including four different body styles, two different hatch types, three different outlet



MAY NEWS | 16

.....

gate options, and numerous factory-applied parts. ScaleTrains.com states this will be the first time the BNSF Heritage series paint schemes (Burlington Northern, Northern Pacific, and Santa Fe) and the Kansas City Southern Belle scheme can be applied to the correct HO scale hopper body. Additional road names will be AOK, CMO (Building America), CSX, KCS (gray), Norfolk Southern, and Union Pacific. For more information visit scaletrains.com.

.....



Summit Models has released a model of the La Grange, Texas MKT depot in HO scale. Their first all-wood laser-cut model kit is a replica of a depot built in 1897 which is now used as a museum. The kit features laser-cut micro-plywood, white and

clear acrylic, and self-adhesive diamond shingles. The completed model measures 9.5 x 5 x 2-inches. Additional information can be found at summit-customcuts.com.

.....



Tangent Scale Models has released new General American 8,000-gallon acid tank cars with welded underframes. Acid tank cars were rubber-lined, featured one percent expansion domes on

the top, and did not have bottom tank outlets. Of note is the small expansion dome at the top and the see-through safety walkway. Tangent's HO scale ready-to-run model replicates prototypes produced between 1949 and 1960 at GA's Sharon, PA plant. Decorating schemes available now include GATX Diamond Chemicals in black with a red diamond.

MAY NEWS | 17



Also available is the distinctive GATX Hooker Chemicals scheme. Notable features on all of these models include accurate lettering applied

to the underframe and air reservoir, road-specific poling pockets in the bolsters, wire grab irons and uncoupling bars, separate air hoses, Kadee couplers, ASF cast-steel trucks with spring plank, separate brake beams and machined 33-inch wheelsets.



GATX Petróleos Mexicanos is identified by the black center band and orange boxes that state “Rentado A Petroleos Mexicanos” on one side of the car, and “Usó Exclusivo Acido

Muriatico” on the other.

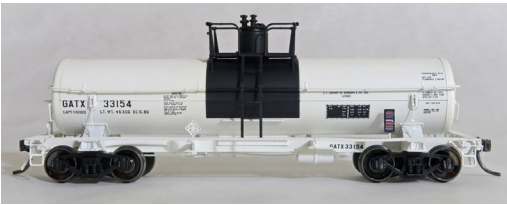

Completing Tangent’s initial release of the GATX acid tankers is this Dupont de Nemours car in the plain white lease scheme of the 1980-era.



Assembled, unlettered models painted black are available as well as undecorated unpainted kits. For additional information on these and other Tangent products visit tangentscalemodels.com.

.....

Walthers shared this computer view of their GE ES44C4 Evolution Series GEVO locomotive. The all new HO scale Mainline



series diesel is expected to be ready for release by late July.



Walthers has recently released an HO scale model of an ACF 50-foot Plate B exterior-post boxcar. The Mainline series ready-to-run model is available decorated for Norfolk Southern, Chessie System (C&O), Detroit & Mackinac, Green Bay & Western, Greenville & Northern, and Wabash Valley. For more information on all Walthers products contact a dealer or visit walthers.com.

.....

N SCALE PRODUCT NEWS



New N scale models coming from **Athearn** early next year include this classic 2-8-0 Consolidation steam locomotive. Features of the ready-to-run model include separately applied engine handrails and boiler mounted appliances, cab window glazing, coined metal side rods, traction tires on the rear driver, and a tender-mounted motor. Road names will be Santa Fe, Baltimore & Ohio, Canadian Pacific, Denver & Rio Grande Western, New York Central, and Union Pacific.



A group of 36-foot wood reefers from

MAY NEWS | 19

the truss-rod era will be included in Athearn's N scale release next February. Road names will American Refrigerator Transit, SFRD-Santa Fe, PFE, Grand Union, Mathieson Dry Ice, and URTC-Schlitz Beer.



Completing Athearn's list of N scale equipment

scheduled for release next February are four 34-foot Overton passenger cars. The mix includes a baggage, combine, coach, and observation/business car. The four cars will be released in sets with additional coaches being available individually. Road names will be Santa Fe, Baltimore & Ohio, Canadian Pacific, Rio Grande, New York Central & Hudson River, and Union Pacific. For additional information on all Athearn products contact a dealer or visit athearn.com.

.....



Atlas plans to release N scale versions of this NSC 50-foot plug door boxcar during the third quarter of this year. The model represents 70- and 100-ton cars built by National

Steel Car primarily for the Canadian paper trade. Important variations in both the prototype and Atlas' version include 9- or 10- foot plug doors, and steel ends with either nine or 10 box corrugations. Road names will be British Columbia Railway, Canadian National, Canadian Pacific, Grand Truck Western, Ontario Northland, Youngstown & Austintown Railroad (YARR), and Quebec Central. Undecorated models will also be in the mix.

Scheduled for release late this year is a group of 50-foot FGE boxcars. Atlas will offer the N scale ready-to-run models decorated for



MAY NEWS | 20

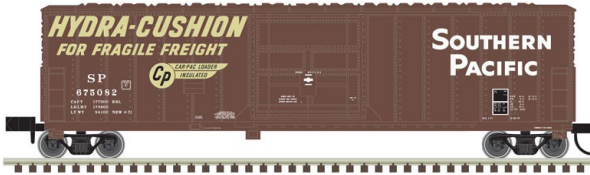

BNSF (Swoosh), CSX (How Tomorrow Moves), Louisville & Wadley Railway, Norfolk Southern,

Union Pacific (Building America), and Southern Pacific (Hydra-Cushion).



Completing Atlas' fourth quarter N scale release is a run of trucks based on Ford's 1984 LNT 9000 tractor cabs. Decorating schemes will be Vermont Railway, Delaware & Hudson, Union Pacific, Burlington Northern, Canadian National, Louisville & Nashville,

Rio Grande, and Santa Fe. Unlettered cabs will be available in black, dark blue, green, red, white, yellow, medium blue, orange, dark green, brown, and gray. Also orange over blue, red over white, white over black, and yellow over green. These N scale ready-to-run models will be sold in two-packs. For additional information on all Atlas products contact a dealer or visit atlasrr.com.



Work is underway at **InterMountain** on an SD38-2 diesel locomotive, which

is essentially a non-turbocharged, 2,000 HP version of EMD's successful SD40-2. In addition to Chicago & North Western, InterMountain's N scale ready-to-run model will be available decorated for Elgin, Joliet & Eastern; Chicago & Illinois Midland, Duluth, Missabe & Iron Range; Bessemer & Lake Erie, Louisville

MAY NEWS | 21

& Nashville, Southern Pacific, Yankeetown Dock Corporation, Iowa Interstate, and Frisco.



Options will include DC, DCC, and DCC with sound. Sound units will have an all new ESU LokSound

Select Micro slide-in decoder. The SD38-2 is expected to be ready for release next spring.

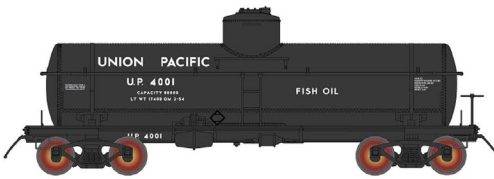

InterMountain's 2017 fall release includes a new run of N scale ACF Type 27 riveted 8,000 gallon tank cars. New road names on

black bodies will be Union Pacific, Mobile Rosin Oil, Mathieson Alkali Works, and North American Car Corp. A car decorated for Kanotex Refining will be available with an aluminum body.



Road names being reissued with new numbers include Union Tank Car, Spencer Kellogg, Harbor Tank Line, and Canadian General Transit, all with black tanks.



Completing the fall release will be a Stauffer Chemical car with a silver tank and a black waist band. The N scale ready-to-run model will be fitted with

InterMountain turned metal wheelsets. For additional information on all InterMountain products contact a dealer or visit intermountain-railway.com.



MAY NEWS | 22



KatoUSA has added three new road numbers to its selection of Siemens ACS-64 Amtrak locomotives: 627, 648, and 600 aka “David L. Gunn.” The N scale ready-to-run model is based on an American-built replacement for the aging AEM-7 and HHP-8 electric locomotives serving the Northeast and Keystone Corridors. Details on a release date are pending. For more information visit a Kato dealer or katousa.com.

.....



New N scale ready-to-run models released by **Micro-Trains Line** include this 70-foot

New Haven heavyweight horse car. It is based on a prototype specially fitted to transport thoroughbred race horses.



This Santa Fe covered hopper displays the ATSF “Q” logo promoting the railroad’s “Managing Total Quality”, a promotional program in

effect from the 1980s until ATSF merged with Burlington Northern. Features of the N scale model include triple discharge bays, elongated roof hatches, and roller bearing trucks.



Olde Frothingslosh Pale Stale Ale was a fictitious beer jokingly promoted as being so light that it floats on top of the foam. It was a running

gag on a Pittsburgh radio station during the 1950s. In the early 1960s the NMRA included HO scale paper sides for Olde Frothingslosh in an issue of the NMRA Bulletin. Micro-Trains has applied the humorous art work to a 36-foot N scale wood reefer.



This 31-foot bay window caboose is based on a prototype built for Western Pacific in 1955. Like the prototype, the Micro-Trains N scale version rides on swing-

motion roller bearing trucks with elliptic springs. For additional information on all Micro-Trains Line products contact a dealer or visit micro-trains.com.

.....



This narrow gauge tank car is available in kit form from **Showcase Miniatures**. Inspiration for the Nn3 model comes from a similar 24-foot prototype owned by the West Side Lumber Company. The kit includes a metal frame, laser-

cut wood decking, a cast resin tank, and etched stainless steel stanchions and brass wire. Flexible poly line is included for the undercarriage rigging. Trucks and couplers are not included. For additional information visit showcaseminiatures.net.

.....

NEW DECALS, SIGNS AND FINISHING PRODUCTS

Mask Island Decals has released HO scale decals for Southern Railway 100-ton hopper cars upgraded from cars initially rated at 70 tons. Additionally, decals for Frisco EMD black switch engine,



MAY NEWS | 24

C&EI 86 foot auto parts car, Central of Georgia pulp wood car, Rock Island 50-foot PS-1 boxcar, and Southern 60-foot PS-1 waffle-side boxcar are also available. To simplify purchasing Mask Island products, the company has updated its website and now accepts PayPal as well as checks or money orders. For further information visit maskisland.com.

Microscale has received a cease and desist order from Genesee & Wyoming Railroad instructing them to end production of decals for G&W and all of its associated rail lines in North America. Meanwhile, new decals issued by Microscale include BNSF Railway hopper and freight cars and New Jersey Transit ALP 46 electric locomotive. For more information contact a dealer or visit microscale.com.

New HO scale decals from **Speedwitch Media** include Milwaukee Road 40-foot ribside automobile cars, New York Central 70-ton gondolas, PRR automobile cars, boxcars, and flat cars; and Nashville, Chattanooga & St. Louis flat cars. To order visit speedwitchmedia.com.



SEND US YOUR PRODUCT ANNOUNCEMENTS

If you are a hobby manufacturer with a product announcement, just [click here](#) and submit your announcement to us. Our website and free magazine reach continues to grow, so get on board this new media train! ■

DISCLAIMER

The opinions expressed in this column are those of the writer and do not necessarily reflect the opinion of *Model Railroad Hobbyist* or its sponsors. Every effort is made to provide our readers with accurate and responsible news and information, however, neither *Model Railroad Hobbyist* or the writer of this column can be held responsible for any inaccuracies or typographical errors that may inadvertently appear in this column.

Want to keep MRH free?
CLICK on ads.

If ads in MRH don't get clicks, then advertisers won't advertise with us, it's that simple ...



**Click here to rate or
comment on this article**





BRIEFLY NOTED AT PRESS TIME ...

Deepwoods Software has released version 2.1.40 of its Model Railroad System. The package includes a collection of libraries and programs designed to minimize many of the more tedious tasks of managing other model railroad software. Included are libraries for communication with Chubb and Lenz XPressNet networks, a user-mode driver for the Rail Driver control console, a library to critically analyze XTrkCAD layout files, plus utilities for computing dropping resistors, camera view areas, creating railroad time tables, and creating switch-lists based a freight car forwarder system. For additional information visit deepsoft.com/ModelRailroadSystem.

ExactRail is expected to release an HO scale model of a Southern Pacific class G-100-22 mill gondola this month. The ready-to-run model is based on a 100-ton, 65-foot car Thrall Manufacturing delivered to SP in 1974. The Platinum series model will have wire grab irons and brake rods, etched top chord tie-downs and brake step, Kadee #158 couplers, machined metal wheelsets, and ExactRail's usual meticulous decorating schemes. For additional information visit exactrail.com.

InterMountain Railway has added 10 additional road names to the fall release of its SD40-2 diesel. In addition to the railroads initially announced, both HO and N scale versions of EMD's SD40-2 will be available decorated for Union Pacific (lettered for Missouri Pacific), CP Rail System, FURX (ex BN patch), Norfolk Southern (high hood), Milwaukee Road, Marquette Rail, G&W Marquette Rail, G&W Alabama & Gulf Coast, and Dakota, Minnesota & Eastern (two schemes). InterMountain reports that each of the newly-announced

schemes will have some railroad specific details. For additional details see the March 2017 edition of MRH or visit intermountain-railway.com.

Tichy Group has released kits for 58 highway billboards in N scale. The signs are based on actual advertising images from the 1930s through 1960s. The models are injection molded in black styrene with the color billboard printed directly on the plastic. Poles, platform, and a base complete the easy-to-assemble kit. For additional information visit tichytraingroup.com.

.....

Want to help keep
MRH free?

Then *click* on ads!





SELECTED EVENTS

May 2017

(Please note that many events charge a fee. Check individual info website for details.)

CANADA, BRITISH COLUMBIA, VANCOUVER, May 5-7, Railway Modellers Meet, at Simon Fraser University Burnaby Campus, West Mall Centre. Info at railwaymodellermeeetofbc.ca.

CANADA, ONTARIO, KITCHENER, May 5-7, NMRA Niagara Frontier Region Convention, at Conestoga College, Doon Campus, 299 Doon Valley Drive. Info at GrandRiverExpress.ca.

CALIFORNIA, SANTA CLARA, May 25-27, 27th Annual O Scale West, at Hyatt Regency Santa Clara, 5101 Great America Parkway. Info at oscalewest.com.

CALIFORNIA, SIMI VALLEY, May 20, Swap Meet at Santa Susana Depot, 6503 Katherine Road. Info at santasusannadepot.org/swapmeet.htm.

COLORADO, COLORADO SPRINGS, May 13, NMRA Pikes Peak Division Train Show & Swap Meet, at Trinity United Methodist Church gymnasium, 701 North 20th Street. Info at ppdnmra.com.

ILLINOIS, HOMEWOOD, May 20, Railroad Days Train Show, at H-F Park District Auditorium. Info at village.homewood.il.us/index.asp?Type=B_LIST&SEC={BE93EAAC-1362-4B4B-AD5F-07AF72FCBC8C}&#{D031C9E4-E2CE-4A50-BA75-424861EA56A6}.

SELECTED EVENTS | 2

IOWA, AMES, May 18-21, NMRA Thousand Lakes Region/Mid-Continent Region Joint Convention, at Quality Inn, 2601 East 13th Street. Info at mcor-nmra.org/Conventions/index.php.

OHIO, HILLIARD, May 19-21, Ohio N-Scale Weekend, sponsored by Central Ohio Ntrak, at Franklin County Fairgrounds, 4100 Columbia Street. Info at centralohiontrak.org/p/central-ohio-ntrak-n-scale-weekend.html.

OHIO, PAINESVILLE, May 6-7, Model Train Days, at Painesville Railroad Museum, 475 Railroad Street, info at painesvillerrailroadmuseum.org.

PENNSYLVANIA, ALLENTOWN, May 18-20, 23rd National Model Trolley Meet, sponsored by East Penn Traction Club, at Allentown Fairground Agri-Plex Charles Hall, 17th and Chew Street. Info at eastpenn.org.

PENNSYLVANIA, KIMBERTON, May 19-20, 34th Annual Module Meet, sponsored by Mid-Atlantic Narrow Gauge Guild, at Kimberton Fire Company Fairgrounds. Info at midatlanticng.org.

VIRGINIA, FISHERSVILLE, May 7, 31st Annual Shenandoah Valley Model Train & Railroading Show, at Augusta Expo, 277 Expo Road, sponsored by Augusta County Model Railroad Club. Info at acmrrc.org.

June 2017

ALABAMA, BIRMINGHAM, June 9-10, NMRA Southeastern Region Convention & Model Train Show, at Bessemer Civic Center, 113 9th Avenue SW. Info at 2017serconvention.com.

CALIFORNIA, FREMONT, June 10-12, 6th annual Open House at Tri-City Society of Model Engineers, Niles Plaza Depot & Freight Building, 37592 Niles Blvd. Info at nilesdepot.org/niles/modelrailroads.html.



SELECTED EVENTS | 3

CALIFORNIA, RICHMOND, June 17, Bay Area Prototype Modelers Meet, at St. David's School Hall, 871 Sonoma Street. Info at bayareaprototypemodelers.org.

COLORADO, DURANGO, June 8-11, NMRA Rocky Mountain Region Convention, at Durango Double Tree by Hilton Hotel. Info at rnr-nmra.org/RMRConvention2017/hotels.html.

CONNECTICUT, ENFIELD, June 2-3, Northeast Proto Meet, at Holiday Inn Springfield South, 1 Bright Meadow Boulevard. Info at nerpm.org/index.html.

CONNECTICUT, ENFIELD, June 22-25, National O Scale Convention, at Holiday Inn Springfield South, 1 Bright Meadow Boulevard. Info at snemrr.org/index.html.

FLORIDA, TALLAHASSEE, June 24, 26th Annual Tallahassee Model Railroad Show & Sale, at North Florida Fairgrounds, 441 Paul Russell Road. Info at bbmra.obbmrarg/show.html.

ILLINOIS, COLLINSVILLE (St Louis area), June 23-24, St. Louis Prototype Modelers Meet, hosted by Lonnie Bathurst and John Golden, at Gateway Convention Center. Details at icg.home.mindspring.com/rpm/stlrpm.htm.

MARYLAND, TIMONIUM, June 17-18, Great Scale Model Train Show, Maryland State Fair, 2200 York Road. Info at gsmts.com.

OKLAHOMA, TULSA, June 21-25, Annual Convention of the Santa Fe Railway Historical & Modeling Society. Info at sfrhms.org/conventions.

PENNSYLVANIA, PITTSBURGH, June 21-25, National N Scale Convention, at Sheraton Pittsburgh, 300 West Station Square Drive. Info at nationalscaleconvention.com.

TEXAS, HOUSTON, June 7-11, NMRA Lone Star Region 2017 Convention, at Hilton Westchase, 9999 Westheimer Road. Info at bayoucitylimited.org/Registration/BCLRegistration.html.

SELECTED EVENTS | 4

WASHINGTON, SPOKANE, June 7-10, NMRA, Pacific Northwest Region “Spokane Falls Express” 2017 Convention, at Hotel RL by Red Lion, West 303 North River Drive. Info at pnr5d.org/index_spokanefallsexpress2017.htm.

Future 2017, by location

COLORADO, DENVER, August 30-September 2, National Narrow Gauge Convention, at Marriott Denver Tech Center Hotel. Info at 37nngc.com.

FLORIDA, ORLANDO, July 30-Aug 5, NMRA National Convention. Info at nmra2017.org.

FLORIDA, ORLANDO, August 4-6, National Train Show, at Orange County Convention Center. Info at nationaltrainshow.org. ■

When talking to hobby vendors, please remember to mention MRH.



Click here to rate or comment on this article



Clickable advertiser index – 1

[Accu-Lites](#)

[American Ltd \(San Juan\)](#)

[ANE Models](#)

[Archer Fine Transfers](#)

[Athearn](#)

[Atlas Model Railroad Co.](#)

[Bachmann](#)

[Backdrop Junction](#)

[Banta Modelworks](#)

[Berrett Hill Trains](#)

[Black Cat Publishing](#)

[Blair Line](#)

[Bowser](#)

[Canyon Creek Scenics](#)

[Clever Models](#)

[Coastmans Scenic Products](#)

[Coffman Graphics](#)

[Crow River Products](#)

[Digitrax \(2 page spread\)](#)

[ESU LokSound](#)

[Fast Tracks](#)

[Fine Scale Miniatures](#)

[Fox Valley Models](#)

[Good Deals DCC](#)

[Great Decals](#)

[HO Diesel Supply](#)

[Iowa Scaled Engineering](#)

[ITLA Scale Models](#)

[Ken Patterson.com](#)

[Lights 4 Models](#)

[Litchfield Station](#)

[Logic Rail Technologies](#)

[Main Street Heritage Models](#)

[Model Railroad Benchwork \(1\)](#)

[Model Railroad Benchwork \(2\)](#)

[Monster Modelworks](#)

[Motrak Models](#)

[Model Railroad Control Systems](#)

[Mountain Subdivision Hobbies](#)

[MRH Store \(1\)](#)

[MRH Store \(2\)](#)

[MRH Store \(3\)](#)

[Mt Albert Scale Lumber](#)

[National Train Show](#)

[NCE \(2 page spread\)](#)

[Nick & Nora Design](#)

[Norfolk & Western Hist. Society](#)

[North American Railcar Co.](#)

[Pre-Size Model Specialities](#)

[Precision Design Co.](#)

[Rapido \(1\)](#)

[Rapido \(2\)](#)

[Ring Engineering \(1\)](#)

[Ring Engineering \(2\)](#)

[Rulers-of-the-World](#)

[Rusty Stumps](#)

[Scale Trains](#)

[Scotty Mason Show](#)

[Sea Port Model Works](#)

[Select Model Railroads](#)

[Streamlined Backshop Services](#)

[Soundtraxx \(Blackstone\)](#)

[Southern Digital](#)

[TAM Industries](#)

Clickable advertiser index – 2

[TAM Valley Depot](#)

[Tony's Train Exchange](#)

[Train Control Systems](#)

[TrainMasters TV \(1\)](#)

[TrainMasters TV \(2\)](#)

[TrainMasters TV \(3\)](#)

[Traintek](#)

[TSG Multimedia](#)

[Walthers](#)

[Westerfield Models](#)

[Yankee Dabblers](#)

[Yarmouth Model Works](#)

Clickable "other" index

[Other – Contents](#)

[Other – Cover](#)

[Other – Derailments](#)

[Other – Hobby Marketplace](#)

[Other – MRH Sponsors](#)

[Other – Yes it's a model](#)

DOWNLOAD ISSUE



DOWNLOAD PORTRAIT



DOWNLOAD LANDSCAPE

• INDEX



SUBSCRIBE
(free)

• TABLE OF CONTENTS



REVERSE RUNNING

commentary

JOE FUGATE
.....



[Click here for
reader comments](#)

TRUE SIZE OF MODEL RAILROADING

AS MORE HOBBY SHOPS FOLD AND THE SIZE OF

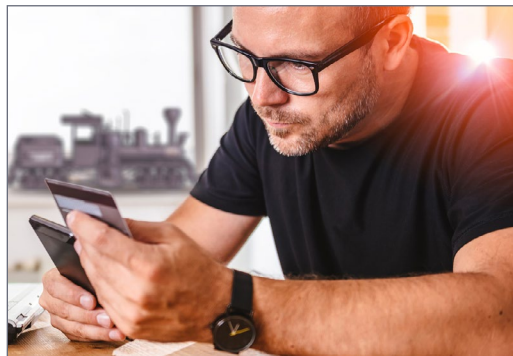

the Walthers catalog keeps shrinking, hand-wringing over the true size of the model railroading hobby continues. Yes, times are changing, but I also think the traditional bellwethers used to judge the health of the hobby are flawed.

The contention of some is that local hobby shops closing means the model train hobby is also on the skids. But is that really true?

It's no secret "brick and mortar retail" in general is shrinking, thanks to the growth of online retail and ecommerce purchasing.

This trend is now hurting the large retail chains like Sears and JC Penney. And it's also bringing an end to a community shopping fixture since the late 1960s: the Radio Shack stores.

▶ [STEPPING OUTSIDE THE BOX WITH A CONTRARY VIEW](#)

Consider the Radio Shacks closing. By the same rationale, that must mean the electronics business is dying! But you can see what a silly contention that is – the electronics hobby and industry are just fine. The Radio Shack closing trend simply indicates people want to get these products in other ways than at a brick and mortar store.

Another concern is the shrinking Walthers catalog. There used to be separate catalogs for N and HO scales, now Walthers has combined these scales back into one catalog. The hobby must be shrinking, too!

But wait a minute. If you are a new hobby business, is your first thought to get into the Walthers catalog and get into the hobby shops? That means wholesale and retail discounts you need to provide on your product. Rather, the new hobby business person wants to set up a website and sell direct to the consumer at full price.

Many significant hobby firms are not even in the Walthers catalog: Athearn, Scale Trains, and ExactRail are missing, just to name a few of the biggies. The list of hobby firm products that are *not in* the Walthers catalog is getting longer every day.

I've also seen concern that hobby sales are not what they used to be. But if hobby shops are closing and the Walthers catalog is shrinking, traditional measures of hobby sales would naturally be down. To get a true picture of hobby sales, you need to add in all the online outlets, but you also need to consider another biggie: eBay.

If I look on eBay in the model railroading category, I find over 600,000 items listed. The listings include both new items and used items. If I assume the average listing is \$50 and that most of what's listed on eBay sells through every week, that's a billion dollars in model railroading items every year. Somebody's buying that stuff!

And I haven't even considered the burgeoning 3D printing product market through Shapeways.

If you take in the *full scope* of how people can get their hands on goodies for their model railroad, the hobby appears quite robust!





DERAILMENTS



Crossing signal is laying down on the job!

Minutes before this video was taken, a tractor trailer accidentally knocked over the grade crossing signal in Brunswick, MD at South Maple Avenue.

Wait until CSX train L341 arrives and see what happens next! We would say this crossing will definitely need some flag protection ... ■

▶ BIZARRE FACTS AND HUMOR (SUPPOSEDLY)

OFF THE RAILS ...

Q: How many model railroaders does it take to change a light bulb?

A: None. If you run 16-volt bulbs at 12 volts, they will last forever!

Q: Why was the model railroader tossed out of the party?

A: Because he spiked the punch.

Q: If John Allen had ever made a movie, what would you suppose he might he have titled it?

A: Death of a Diesel Salesman. ■

GET PAID ...

If you're the first to submit a bit of good humor or bizarre facts and we use it, it's worth \$25! Just send to derailments@mrhmag.com ■

Coming next issue ...

- MRH's Don Hanley shows his techniques for blending scenery into a backdrop with 3D relief
- One Module Challenge First Place layout design
- Another Orlando layout that will be on tour
- And lots, *lots* more!

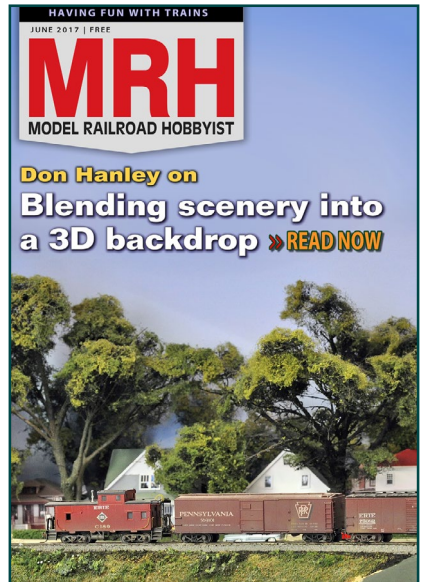

Click here to rate or comment on this article

• [INDEX](#)



SUBSCRIBE
(free)

• [TABLE OF CONTENTS](#)