

HAVING FUN WITH TRAINS

JANUARY 2017 | FREE

# MRH

MODEL RAILROAD HOBBYIST

## ALSO:

- End of the HO Siskiyou Line
  - SPSF Meadow Subdivision
  - Ride a prototype, then model it
  - Return to Allagash Country!
  - Two approaches to scenic depth
- ... and lots more inside!*

Actor Michael Gross shows his  
Realistic rolling stock  
weathering methods

» **READ NOW**

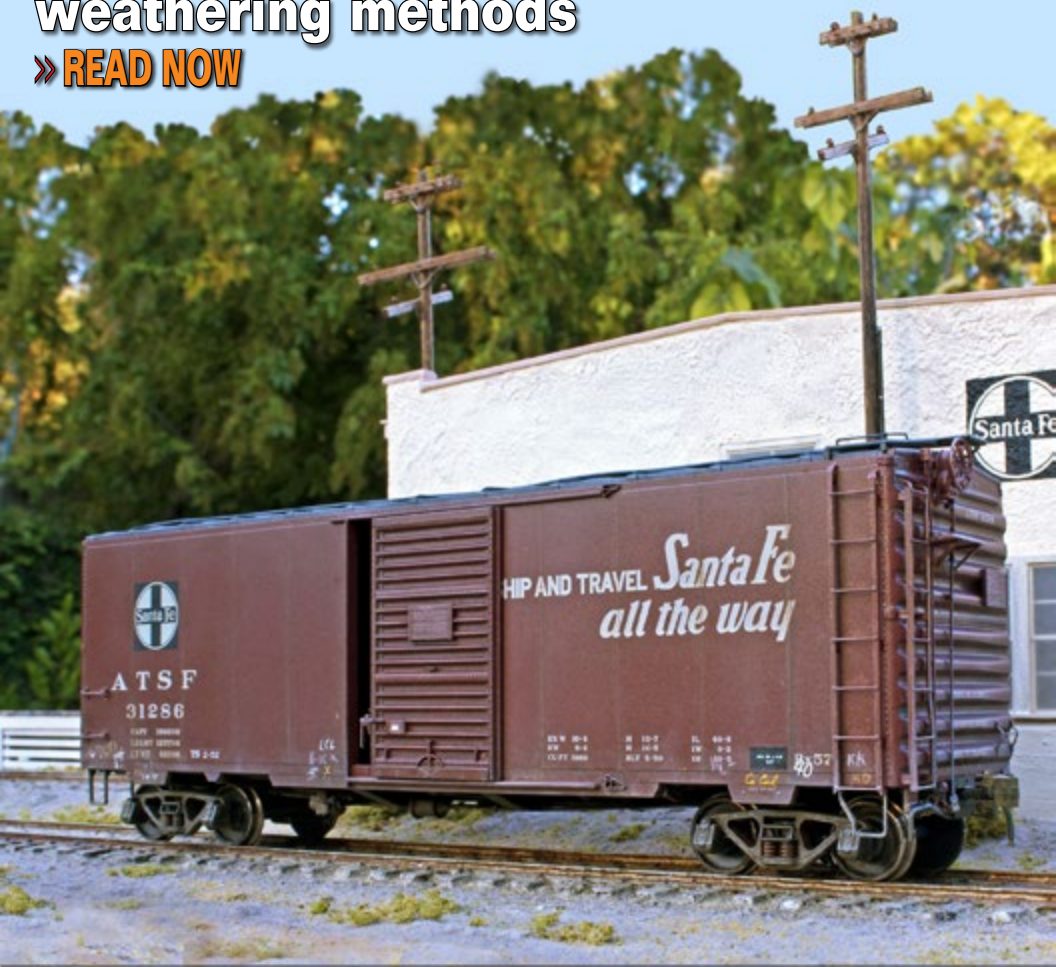

EMBEDDED EDITION | PORTRAIT



DOWNLOAD



SUBSCRIBE

(free)



# GOT TRACK?

*(Don't let your fun get stopped short...)*

## ATLAS HAS PLENTY!

### N SCALE TRACK



*N Code 80*



*N Code 55*

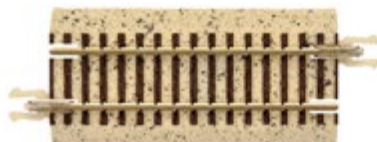

*N True-Track®*

### H0 SCALE TRACK



*H0 True-Track®*



*H0 Code 83*



*H0 Code 100*

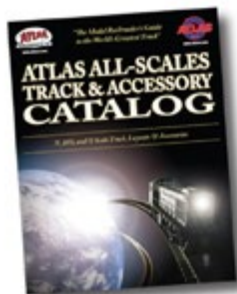

**FIND A  
DEALER NOW!**

For more information visit  
[www.atlasrr.com](http://www.atlasrr.com), or call  
1-800-872-2521 and request an  
Atlas All Scales Track and  
Accessory Catalog.





# STAFF CREDITS

**Front cover:** You may recall actor Michael Gross as Michael J. Fox's TV dad on the 80's *Family Ties* sitcom. Michael Gross is also a serious scale model railroader and he shares his weathering techniques in our cover story.



ISSN 2152-7423

## Editorial Staff

Joe D. Fugate, Publisher and Editor  
Don Hanley, Assistant Editor

## Production

Patty Fugate, Pasteup and Layout  
Joe Brugger, Copy Editing  
Mike Dodd, Copy Editing

## Technical Assistant

Jeff Shultz

## Advertising

Les Halmos, Account Manager  
Daniel Nava, Advertising Assistant  
Jean-François Delisle, Marketing Assistant

## Columnists

Richard Bale, News and events  
Jeff Shultz, News and events  
Les Halmos, Modular railroading  
Larry Smith, Narrow Gauge/Shortlines  
Bruce Petrarca, DCC  
Ken Patterson, Reporter at large

## Special Correspondents

Joe Brugger, Questions & answers

Issue password: Jan2017

Published for the glory of God. [What's this?](#)





# MRH SPONSORS

## A - E



[acculites.com](http://acculites.com)



[americanlimitedmodels.com](http://americanlimitedmodels.com)



[railroadhobbyshow.com](http://railroadhobbyshow.com)



[anemodel.com](http://anemodel.com)



[archertransfers.com](http://archertransfers.com)



[athearn.com](http://athearn.com)



[www.atlasrr.com](http://www.atlasrr.com)



[bachmanntrains.com](http://bachmanntrains.com)



[bachrus.com](http://bachrus.com)



[backdropjunction.com](http://backdropjunction.com)

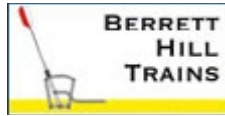

[berrethill.com/trains](http://berrethill.com/trains)



[blairline.com](http://blairline.com)



[bowser-trains.com](http://bowser-trains.com)



[con-cor.com/website](http://con-cor.com/website)



[coffmaneng.com](http://coffmaneng.com)



[cvrco.com](http://cvrco.com)



[www.digitrax.com](http://www.digitrax.com)



[esu.eu/en](http://esu.eu/en)

[Vendors: Get your clickable logo here ...](#)

# MRH SPONSORS | 2

## F - R



[www.handlaidtrack.com](http://www.handlaidtrack.com)



[foxvalleymodels.com](http://foxvalleymodels.com)



[glxscalemodels.com](http://glxscalemodels.com)



[www.iascaled.com](http://www.iascaled.com)



[litchfieldstation.com](http://litchfieldstation.com)



[model-trains-video.com](http://model-trains-video.com)



[modelrectifier.com](http://modelrectifier.com)



[monstermodelworks.com](http://monstermodelworks.com)



[stores.ebay.com/Motrak-Models](http://stores.ebay.com/Motrak-Models)



[mtalbert.com](http://mtalbert.com)



[ncedcc.com](http://ncedcc.com)



[nickandnora.com](http://nickandnora.com)



[nwhs.org](http://nwhs.org)



[www.pwrs.ca/main.php](http://www.pwrs.ca/main.php)



[rapidotrains.com](http://rapidotrains.com)



[ringengineering.com](http://ringengineering.com)



[rustystumps.com](http://rustystumps.com)

[Vendors: Get your clickable logo here ...](#)

• [INDEX](#)



[SUBSCRIBE](#)  
(free)

• [TABLE OF CONTENTS](#)

# MRH SPONSORS | 3

## S - Z



[sanjuancarco.com](http://sanjuancarco.com)



[scaletrains.com](http://scaletrains.com)



[selectmodelrailroads.com](http://selectmodelrailroads.com)



[signaturepress.com](http://signaturepress.com)



[soundtraxx.com](http://soundtraxx.com)



[sodigi.com](http://sodigi.com)



[sbs4dcc.com](http://sbs4dcc.com)



[tamvalleydepot.com](http://tamvalleydepot.com)



[sbs4dcc.com](http://sbs4dcc.com)



[tonystains.com](http://tonystains.com)



[trainmastermodels.com](http://trainmastermodels.com)



[traintekllc.com](http://traintekllc.com)



[tsgmultimedia.com](http://tsgmultimedia.com)



[walters.com](http://walters.com)



[yankeedabblers.com](http://yankeedabblers.com)

[Vendors: Get your clickable logo here ...](#)

Looking for something? Check the MRH Marketplace!



Take me there!



Click to  
learn more

GRAND TRUNK WESTERN® #529  
Item No. 52801

## BRING THE STEAM ERA TO LIFE! USRA LIGHT PACIFIC 4-6-2 with DCC SOUND

The advent of heavier, longer passenger trains in the early 20th century called for a new type of steam locomotive. The 4-6-2 (or Pacific class as it came to be known) answered that call in 1901. It went on to become the predominant express passenger engine for over 40 years. Bachmann's new DCC sound-equipped 4-6-2 includes our Sound Value *SoundTraxx*® steam package with authentic prototypical chuff, short and long whistles, bell, air pump, steam release, and blower—all in 16-bit polyphonic sound. Visit your favorite hobby dealer to bring the sights and sound of the steam era to life on your HO railroad!

### Features include:

- DCC-sound equipped
- dual-mode NMRA-compliant decoder
- die-cast chassis
- LED headlight and backup light
- prototypical headlight and bell locations per prototype

- metal handrails and stanchions
- metal cut levers
- metal wheels
- E-Z Mate® Mark II couplers

SHIPPING NOW!



BALTIMORE & OHIO® #5213  
Item No. 52801



NEW YORK CENTRAL® #4552  
Item No. 52802

Click to  
learn more



SANTA FE #1385  
Item No. 52803



UNION PACIFIC® #2880  
Item No. 52805



Bachmann Industries, Inc. • 1400 East Erie Avenue • Philadelphia, PA 19124 USA • [www.bachmanntrains.com](http://www.bachmanntrains.com)

Click to learn more.

• INDEX



SUBSCRIBE  
(free)

• TABLE OF CONTENTS



# TABLE OF CONTENTS

## FEATURES

### Simple three-step weathering

*MICHAEL GROSS*

Transform a ready-to-run model into a seasoned veteran

---



### Modeling the SPSF Meadow Sub

*ERIC MILLER*

Proto-freelancing a post-merger railroad

---



### Adding better sky to model photos

*PETER VASSALLO*

Simple model photo editing tricks for better sky

---

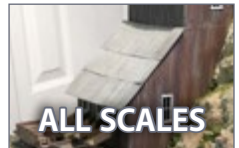

### Return to Allagash Country!

*MIKE CONFALONE*

“Prototype railfan trip” of some new Allagash scenery

---



### FIRST LOOK: NCE Power Cab

*DON HANLEY*

MRH takes a look at NCE’s DCC starter system

---



**ALSO:** MRH Marketplace | Subscriber extras



# TABLE OF CONTENTS | 2

## COLUMNS

**MRH Q-A-T: Proto 2000 lubing, and more**

*compiled by JOE BRUGGER*

**Getting Real: Riding & modeling a prototype**

*MIKE ROSE*

**What's Neat: Modeling on the road, and more**

*KEN PATTERSON*

**Imagineering: Scenic depth**

*ROB CLARK and DAVE MEEK*

**Photo feature: Yes, it's a model**

*compiled by DON HANLEY*

**Derailments: Bizarre facts & humor**

*compiled by the MRH STAFF*

## NEWS and EDITORIAL

**Publisher's Musings: Dismantling the Siskiyou Line**

*JOE FUGATE*

**News & Events: January 2017**

*RICHARD BALE & JEFF SHULTZ*

**Reverse Running: A matter of perspective**

*JOE BRUGGER*



# MRH SECOND ANNUAL "ONE MODULE" CHALLENGE

## CONTEST

**ENTRY DEADLINE: January 31, 2017**

**ENDS  
SOON!**

**Goal: Design the first "module section" for a sectional home layout design.**

Hypothetical room is 10' x 14' – 2'x'8' closet can be used; window can be covered.

*Note: This is a sectional home layout design, no modular standard required.*



### CONTEST RULES

- Modules can be any size or shape but must fit through the room door (7'-6" tall and 30" wide) without damage or pinching your fingers. Plan can have any number of modules.
- Scale: From Z to O, using any track gauge combination.
- Module section must connect to a temporary staging yard module on at least one end. A staging yard must have at least three yard tracks.
- Rough in the outlines of any other layout module sections to be built for the entire room. No track plan required, just an outline of the modules in the room is sufficient. Bonus points awarded for [showing a module construction progress plan](#).
- Modules can follow a standard or not. Custom sections are okay.
- Module support method / height up to you, but please describe.
- Innovative approaches get extra points: please describe and illustrate if possible.
- Include a cost estimate for the module. There is no need to actually build anything, this is a design contest only. Do be as comprehensive as possible in the cost estimate: the hypothetical goal is a completely finished, operational module.
- The best submissions will be published, so extra points are awarded for quality text, illustrations, photos and captions. Winners get a bonus payment rate.

**SUBMIT ENTRY (Choose "Contest Entry")**



# PUBLISHER'S MUSINGS

editorial

JOE FUGATE



[Click here to rate or comment on this article](#)

## END OF AN ERA: DISMANTLING THE SISKIYOU LINE

**YES, YOU READ RIGHT. I'VE DECIDED TO DISMANTLE** my current Siskiyou Line layout. This time, it's not an April Fools joke. I really am doing it.

The final op session on the layout is Saturday, January 21st, after which dismantling will begin.

However, this is not the end of the line for the Siskiyou Line in total. This is the end of the line for what I'm now calling Siskiyou Line-1. In its place, Siskiyou Line-2 will rise.

So what happened? Last year at this time I was celebrating the 25th anniversary of Siskiyou Line-1, and a year later, I'm dismantling the layout.

It's a long story, but basically the kids are all gone and my wife and I are now at retirement age and we want to get out from under a house payment. The way to do that is to move out of the subdivision we live in and move out to a rural location. We can get rural property with a shop outbuilding and put a modest manufactured home on it and pay it off completely.



## PUBLISHER'S MUSINGS | 2

However, we can't move yet because we're currently caring for my elderly mother. She is almost 90 now and lives two blocks from us. Mom is getting up there and she has increasing health issues, but we're not sure how much longer she will be with us. In the meantime, we're enjoying the time we have with Mom but we're preparing for the eventuality that's likely to come sooner or later by getting our current house ready to sell.

It should come as no surprise: you can't easily sell a house with a basement full of train layout. So the layout has to go.

My recent work on the TOMA (The "One Module" Approach) layout project for TrainMasters TV has shown me how flexible this approach can be for a home layout. Essentially, you design and build the layout as sections that can easily be moved between

### ADVERTISEMENT

Make LocoNet wiring extremely simple!

**ACCU-LITES, inc**  
Your DCC Center!

**Suitcases belong in your baggage cars,  
not under you layout!**

**Introducing the DCC Vampire II ...  
this guy does the job of two suitcase  
connectors!  
And really holds the connection good  
too!**



**CLICK NOW TO DISCOVER THE AMAZING VALUE!**

Dealer Inquiries Accepted

• [INDEX](#)

• [TABLE OF CONTENTS](#)



19373 122 FEET LONG 19377

# CHALLENGER

BUILT BY AMERICAN  
LOCOMOTIVE CO.



©2016 Zippert Collection

ANNOUNCING

## ALL NEW – ATHEARN® GENESIS® “ORIGINAL” CHALLENGER

Introducing the CSA-1 and CSA-2 Challenger Simple Articulated Class for the first time in plastic! These models possess better than brass detail, prototypical pilot variations, and new tender!



Boiler tube with widely spaced handrails



Steel bars with narrowly spaced handrails



Solid Cast Pilot



Steel bars with wide shield



Footboard pilot

5 photo series James L. Demberger Collection

### NEW FEATURES AND OPTIONS

- Coal and oil tender versions
- Single and twin stack versions
- Large and small dome versions
- Pre-war and post-war paint schemes
- With or without coal rack
- Two steam pipe versions



LEARN ALL ABOUT THE 4-6-6-4  
CHALLENGER AT [ATHEARN.COM](http://ATHEARN.COM)



**HORIZON**  
H O B B Y

VISIT  
Your Local Retailer

CLICK  
[Athearn.com](http://Athearn.com)

CALL  
1.800.338.6039

SERIOUS FUN™

©2016 Horizon Hobby, LLC. Athearn, Genesis, Ready To Roll, Train a Model, Series For and the Horizon Hobby logo are trademarks or registered trademarks of Horizon Hobby, LLC. All other trademarks, service marks and logos are property of their respective owners. Real models may vary slightly from plastic ones. 0902

• INDEX



SUBSCRIBE  
(free)

• TABLE OF CONTENTS

**www.SBS4DCC.com**

**ESU** **TCS** **WOW Sound**  
**QSI Solutions** **ZIMO**

**SOUNDTRAXX**

**NCE** **DiGiTrax**  
*The Power of DCC*

**DCC Specialties** **MRC**  
RENOVATION FOR DCC Model Railcar Corporation

**ACCUTRACK II SPEEDOMETER** **SPROG DCC** **Digital plus**  
by Lenz  
The DCC Programmer and Control Family

**TAM VALLEY DEPOT** **TEAM DIGITAL, LLC**  
Great Electronics for Great Model Railroads Improving the world of DCC

**N - HO - HO<sub>N3</sub> Scale Trains**

**TamValleyDepot.com**  
 Great Electronics for Great Model Railroads

**We are loading up the boxcars with Frog Juicers ready for your layout!**

## PUBLISHER'S MUSINGS | 3

layout room and workbench as needed. It's also very easy to break down a TOMA layout and take it with you when you move.

So that's the plan for Siskiyou Line-2. It's going to be a re-do of the current Siskiyou Line layout using state-of-the-art TOMA layout design and construction methods. Even if I wasn't doing a TOMA layout this time, layout construction methods have come a long way in 25 years, and so have my skills.

I love the Siskiyou Line layout concept, so I want to keep the same general idea for Siskiyou Line-2. However, this time it will not be a mushroom design. I'm going to go narrower in many cases and just try to fit more layout in the space – all on one level as TOMA sections.

What I'm planning to do is document this whole process and present it to MRH readers. I'm going to shoot the final op session

**WISH: Shadow expert home layout builders and learn their best tricks ...**



MODULE 1  
2.5' X 7'



MODULE 3  
2' X 7'

**GRANTED:**

**In the 2017 TMTV season,  
we do just that.**



**TRAINMASTERS.TV**

Don't miss out: Click now and join in!



• INDEX



SUBSCRIBE  
(free)

• TABLE OF CONTENTS

on video. Also, as I dismantle the current layout, I'm going to save as much as possible, so I'm going to document how I'm doing that and put that to video.

Then, as Siskiyou Line-2 starts to rise, I'm going to document what I'm doing differently this time around and tell why.

If Mom hangs around for a while, this still gives me a clear way forward for the future. I can dismantle Siskiyou Line-1 and turn the basement back into a nice carpeted family space. Meanwhile, I can start on Siskiyou Line-2 using TOMA methods without messing up this basement space, and it all will move with me when we go.

The new property can have a good sized outbuilding with plenty of space for the new Siskiyou Line-2 and room for the MRH Media office.

So that's the plan. Siskiyou Line-1 has been fun, but at now 26 years old, it's showing its age badly. I am excited about the fresh start and look forward to seeing what Siskiyou Line-2 looks like as it starts to materialize.

Watch these pages as I give you updates on the progress!

### Reminder: Subscription sweepstakes

Continuing until the end of January, we're having a new subscriber sweepstakes. If you become a Model Railroad Hobbyist subscriber, you get entered into a free drawing for \$250, and we make a drawing each month.

We're doing this because we want readers to realize how valuable becoming a subscriber is. We figure by offering a cash prize we can get you to seriously consider subscribing.

Subscribing is free, but it benefits both you and MRH. [Click here to subscribe.](#)

If you subscribe, you get weekly emails with current issue access links (never miss an issue release again) and you also get links to



Sale runs from December 25<sup>th</sup> to January 7<sup>th</sup>!Over 20,000 items  
on sale.We will add more  
items each day for  
12 days!

BOXING DAY

SALE

CLICK HERE FOR

12 Days of Sale!

**Pacific Western Rail Systems**

Later this month at the Amherst Railway Society's Railroad Hobby Show in West Springfield, Massachusetts, we will be formally announcing our next all new railcar, in both HO and N Scales. This totally new car has over 70 potential paint schemes from 1972 to the present, and many of these cars are still in service today, all over North America.

This car has never been available before - anywhere!

Our first car (the Cylindrical Hopper) has over 15 different structural variations (different ways we can build them)...

The 4000 cubic-foot Coal/Sulphur Gondola has 7 different structural variations...

The NSC 3-Bay Potash Car has 7 different structural variations...

# TEASER ALERT

But, this fantastic new car will be offered in 36 variations! Modern technology and out-of-the-box thinking allows us to do the previously impossible. Our factory in China has told us they have never done a project with this many variations (and hope not to ever again!). We are definitely pushing the bar on what can be done.

We'll see you at the Amherst Railway Society's Railroad Hobby Show January 28<sup>th</sup> and 29<sup>th</sup> for our announcement. Come visit us at booth 57 in the Better Living Center. See you there!

 NORTH AMERICAN RAILCAR CORPORATION

• INDEX



• SUBSCRIBE  
(free)

• TABLE OF CONTENTS

## PUBLISHER'S MUSINGS | 5

some of the best posts on our website – some of these are quite good, almost like getting a new mini-magazine each week.

The emails also have product announcements – and these days with limited runs, getting a heads-up about a new product can make the difference between getting something or missing out. Remember, we're ad-supported, so the weekly emails do have ads. But if you absolutely can't stand email ads we will also offer just the new issue notices and the best new posts emails without ads as a [\\$25 per year ad-free subscription](#).

MRH subscribers also get 10% off anything in the MRH Store, as well as 10% off on a TMTV membership.

Advertisers put big stock in our subscriber number because it represents how many "serious" modelers we're reaching – possible customers for them.

Finally, beginning with this issue, we're adding a "subscribe now" button to the footer of the magazine so it's super easy to subscribe. It's right there where you can't miss it.



[Click here to rate or comment on this article](#)

*Publisher's Musings continue on the next page with some additional notes ...*

**N Scale Pendolino**  
**Click here to reserve.**



• [INDEX](#)



**SUBSCRIBE**  
*(free)*

• [TABLE OF CONTENTS](#)

## MRH 2016 Survey, favorite prototype region

Here is our readers' favorite prototype region from our 2016 reader survey. The statistical validity is +/- 2.5% with a 95% certainty.

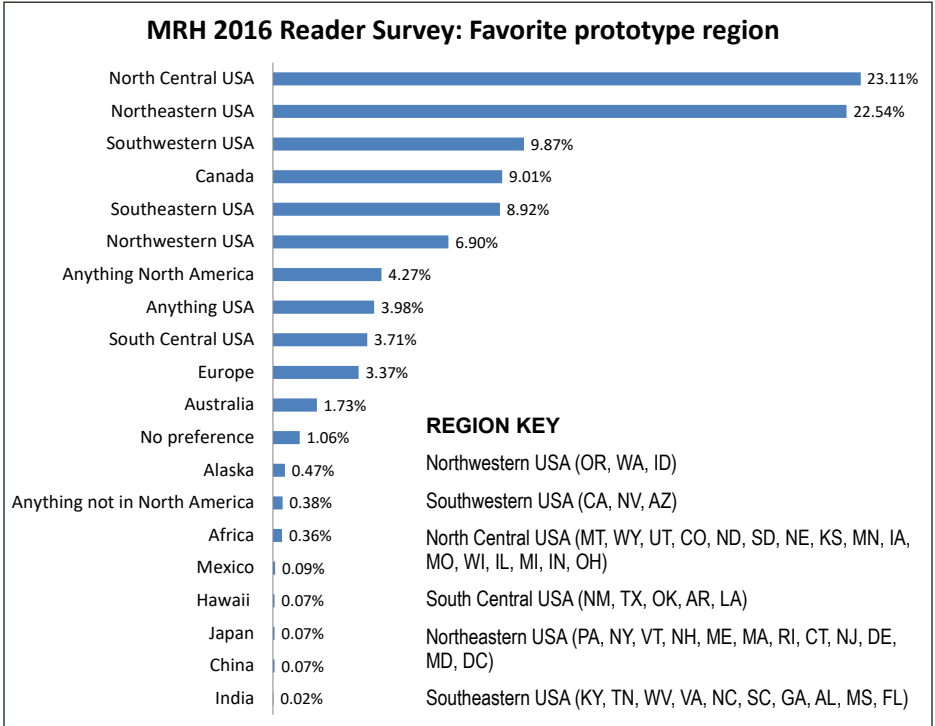

Note that adding anything North America, anything USA and no preference together gives 9.31%, so we can add that to any USA numbers. This means:

- Readers who like North Central or Northeastern US: 32%
- Readers who like Southwestern or Southeastern US: 19%
- Readers who like Northwestern US: 16%
- Readers who like South Central US: 13%
- Readers who like Alaska or Hawaii: 9%

Notice if you look on a map, where there's more railroad track density, there's often more prototype interest. The two tend to go hand-in-hand.

# Bowser

## New Product Announcement

### HO ALCo RS-3 & Other Variations Locomotives

Ready To Run with Locomotive specific details. Features: air hoses, windshield wipers, grab irons, coupler lift bars, operating headlight, window glass, road name specific details, roadname specific fuel tanks, can motor, flywheels, nickel silver wheels with RP25 flanges and knuckle couplers. Analog (DC) version features 21 pin plug for DCC, DCC/Sound version features LokSound Select decoder.



DC Analog Version \$199.95  
Sound/DCC Version \$299.95



Road Names:  
Boston & Maine  
Central Vermont  
Delaware & Hudson  
Erie Lackawanna  
Grand Trunk  
Greenbay & Western  
Louisville & Nashville  
Milwaukee  
NKP  
Northern Pacific  
Norfolk & Western  
Pennsylvania w/Train Phone  
SP&S  
BN Merger ex SP&S  
Western Maryland



Click here to check out the details for these and other great  
Bowser Products

• INDEX



SUBSCRIBE  
(free)

• TABLE OF CONTENTS



# LAST ISSUE'S RATINGS

The five top-rated articles in the [December 2016 issue](#) of *Model Railroad Hobbyist* are:

- 4.9 A modeler's introduction to the Arduino
- 4.7 Freight car roofs of the 20th Century
- 4.5 DCC Impulses: Digitrax Evolution first look
- 4.5 Getting Real: Modeling Grandview, MO
- 4.5 Merry Christmas from MRH

Issue overall: **4.8**

**Please rate the articles!** Click the reader comments button on each article and select the star rating you think each article deserves. Thanks! ■

## ADVERTISEMENT

**TRINITY 3281  
IN STORES NOW**

Norfolk Southern -- 12 #s

ICE-GATX -- 8 #s

Winchester & Western -- 12 #s

NRLX Ciment Quebec -- 12 #s

HWCX -- 7 #s

**American Limited**

[www.americanlimitedmodels.com](http://www.americanlimitedmodels.com)

## ADVERTISEMENT

**Archer**  
FINE TRANSFERS  
PROUDLY SERVING MODEL BUILDERS SINCE 1989

THE ORIGINAL  
**SURFACE DETAILS™**

WE NOW HAVE MORE THAN 130 SHEETS OF RIVETS, LOUVERS, TREADPLATE, WELD SEAMS AND MORE CAST ONTO MICROSCALE CLEAR DECAL FILM

**LOW SHIPPING:**

DOMESTIC USA ORDERS \$2.80

INTERNATIONAL ORDERS \$9.95

CLICK HERE TO VISIT OUR WEBSITE!

*"Archer Fine Transfers 3D decals have revolutionized kitbashing and scratchbuilding. Putting rivets or other low-relief details like louvers or weld seams on your models is now as easy as applying decals."*

Joe Fugate, Publisher/Editor Model Railroad Hobbyist

Archer Fine Transfers • PO Box 1277 • Youngsville, NC 27596 • USA  
(919) 570-1026 • info@archertransfers.com • archertransfers.com



# The Amherst Railway Society Railroad Hobby Show

Our 2017 Show will be

# January 28 & 29, 2017

Save the dates!

**Click  
to learn  
more ...**



## About The Show

Every year late in January or early in February, the Amherst Railway Society holds its Railroad Hobby Show at the Eastern States Exposition Fairgrounds (The home of The Big E) in West Springfield, Massachusetts. More than 25,000 railfans and public attended the Show each of the past three years.

The event features real life railroads and scale model railroads, historical societies, travel agencies, art shows, flea market dealers, importers, manufacturers and photographers. You have to see it to believe it!

• [INDEX](#)



**SUBSCRIBE**  
(free)

• [TABLE OF CONTENTS](#)

# HO 4566cf GATC Airslide® Covered Hoppers

Visually taller than the smaller 4180cf version



6 ROADNAMES TO CHOOSE FROM • PAINT SCHEME VARIATIONS



STANDARD SERVICE CARS



DUE MARCH



OIL TRAIN BUFFER CARS

**Preorder Now**

GATC 4180cf Airslide®  
Covered Hoppers  
Also available in...



© 2017 ScaleTrains.com, Inc. ScaleTrains.com, Operator, Rivet Counter, and respective logos are trademarks of ScaleTrains.com, Inc. ScaleTrains.com, Inc. 7598 Highway 411 Benton, TN 37307 844-9TRAINS 844-987-2467 International 423-299-3689



Scene and photography  
by Ken J Johnson  
Preproduction model shown

• INDEX

• TABLE OF CONTENTS





Model Railroad Hobbyist | January 2017 | #83

# MRH Q-A-T

column

compiled by  
**JOE BRUGGER**



[Click here to rate or comment on this article](#)

## QUESTIONS AND ANSWERS

### Proto 2000 clean-up

**Q.** I am aware of the split gear issues with the older blue box P2K locomotives, but I have several that have been stored for many years and plan to use them on the layout that is in the design phase. What can one do to clean the motor when the lubrication turns to “peanut butter,” without replacing the motor?

—Jason Greene

**A.** Dried-up grease and split axle gears are well-known problems with early runs of Life-Like Proto 2000 engines, particularly the four-axle GP units. If you hear thumping while the engine runs, there is at least one split axle gear. Even if the unit is locked up solid, the problem is usually not the electric motor.

The good news is that the issue can be almost always be corrected by cleaning the drive train and replacing drive axles with

▶ **MRH QUESTIONS, ANSWERS, AND TIPS**

• [INDEX](#)



**SUBSCRIBE**  
*(free)*

• [TABLE OF CONTENTS](#)

## MRH Q-A-T | 2

Athearn #60024 parts. If one drive gear is bad, replace all of them so you only need to do the repair routine once. Mark the bottom of the engine's fuel tank with an "A" after the original axles are replaced.

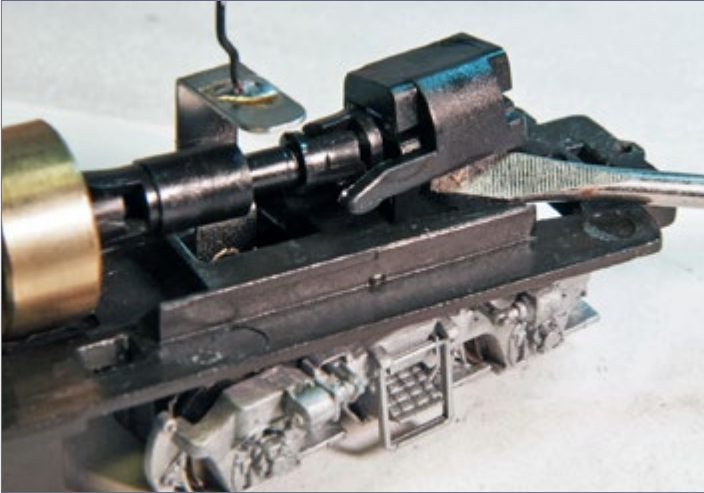

1. Use a small screwdriver to lever the top clip off the power truck, to release the worm gear and bearings.

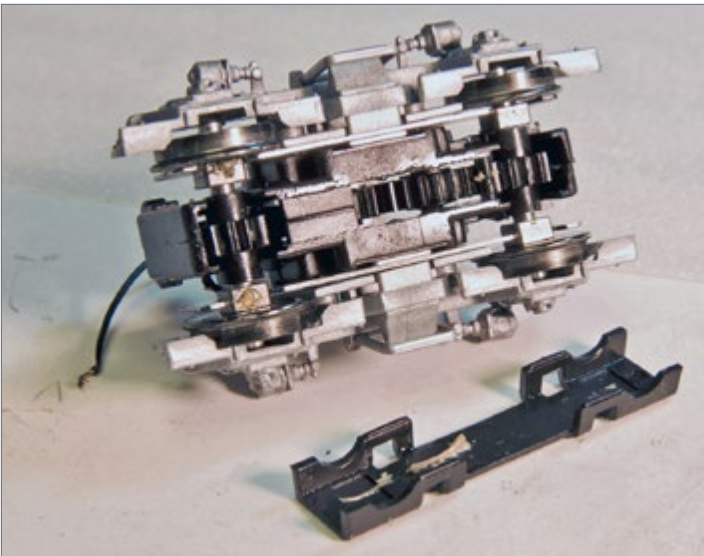

2. Pop off the bottom truck clip to remove the axle assemblies. There's also a small clip on the top front of the truck that must be removed.

## MRH Q-A-T | 3

The bad news is that it can take an afternoon or an evening to get a P2K drive freed and working smoothly.

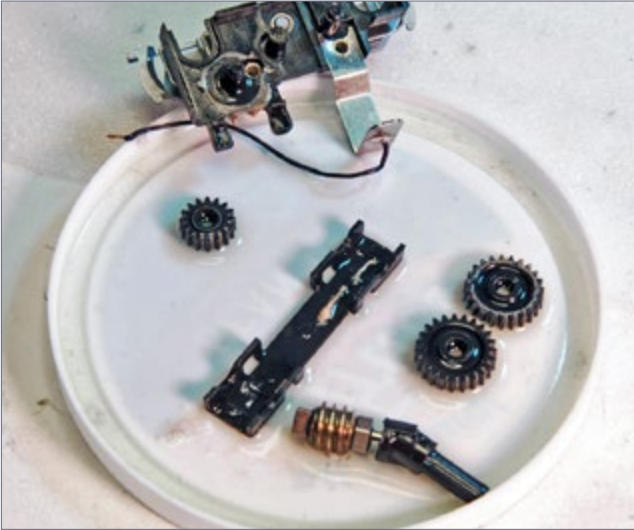

3. Give the parts a quick bath in Simple Green or alcohol to loosen the deposits of dried-up grease. Brush the parts with cleaner and let them “rest” for about five minutes before wiping grime away.

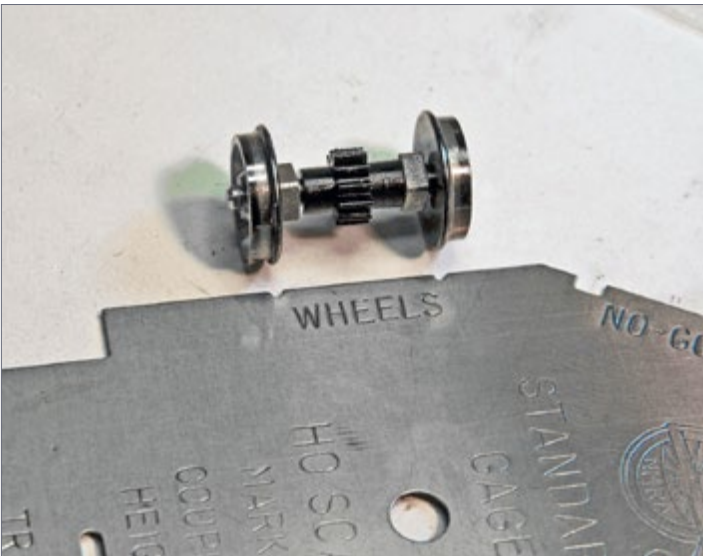

4. Check the rebuilt axle for correct wheel spacing before reassembling the power truck.

## MRH Q-A-T | 4

To clean out old grease from the power truck, pop off the rounded clip at the top of the power truck [1] and let the truck drop out the bottom of the frame. The axles are the easy part: Lever off the bottom cover on the power truck [2]. Lift out the wheel/axle assembly. Pull the wheels out of the plastic axle.

With the bottom and top clips removed, split the truck and clean the halves and the idler gears with isopropyl alcohol or Simple Green [3]. Soak the axle bearings in alcohol or mineral oil, then wipe them off and dry them. If you want to paint the wheels, now is an ideal time. Toothpicks, dental picks, strips of paper towel, and cotton buds are useful for removing hardened grease. Wipe the parts dry and reassemble. On some trucks, the worm gear bearings will be frozen on their shaft. Applying a drop of plastic-compatible light oil will let you work them apart to clean the worm and bearings.

Reassemble the new axle, wheels, and bearings. Check the wheel spacing with an NMRA standards gauge [4], lubricate the bearings, put a dot of plastic-compatible grease on the large drive gears, and then wiggle the assembly back into the power truck. Once the axles are seated correctly, snap on the bottom and top clips and feed the truck back up into the frame, guiding the drive shafts into their sockets.

If the motor doesn't spin freely at 6 volts, work a drop of light oil into the bearing at either end of the motor and then gently twist the flywheels back and forth until the motor is free. You need a pinpoint oiler to get to these bearings, which are partially blocked by the cast-metal frame.

Here's how readers cope:

**Paul Schmidt:** If you have access, look for Bruce Petrarca's decoder installation for a Kato NW2 at [trainmasters.tv/videos/soundtraxx-decoder-install-kato-nw2](http://trainmasters.tv/videos/soundtraxx-decoder-install-kato-nw2).

Con-Cor is re-running all the "HO" MUMP-54 Cars in Early 2017 (last run was 2012), Limited Quantities!

HO - MUMP-54 Cars - Pre-Order NOW!



Place your Pre-Order today for full selection. Road names include Long Island, Pennsylvania, and SEPTA that owned MUMP-54 cars.

Donald Trump's Inaugural Presidential Boxcar. (Limited Run)



See final artwork on website. Artwork shown is concept only.

Available in both "HO" and "N" Scale.

Order at  
www.Con-Cor.com/mhbbbs  
or by email at Orders@con-cor.com

**Backdrop Junction**  
Your Stop for Railroad Backdrops

**Click Here** →

**For the Finest in Custom  
Designed backdrop**



[www.backdropjunction.com](http://www.backdropjunction.com)

**MONSTER**  
modelworks

New HO Scale Kit Release  
**Engineers Tool Shed**



[www.monstermodelworks.com](http://www.monstermodelworks.com)



**COMING SOON  
IN HO SCALE!**



We plan to produce an HO Scale version of our very popular Mt. Albert Lumber Yard kit later this year. Please watch our website and Facebook page for more details.



You can download the January 2013 Model Railroad Hobbyist containing his Kato NW2 sound installation story at [mrhmag.com/magazine/mrh-2013-01-jan](http://mrhmag.com/magazine/mrh-2013-01-jan).

In the video, he shows how he cleans old lubricant out of the gears with an ultrasonic cleaner and some Simple Green. Then he re-lubes with Nano Oil. I'm assuming it is the goop in the gears, and hopefully not the motor – where the goop should not be – to which you are referring. I'm awaiting payday to get an ultrasonic cleaner. Wanted one for years but never had a good reason. Now I do.

**Don Mitchell:** Clean the motor with an old toothbrush, a thin rag (like a used handkerchief), and alcohol. Clean plastic parts with the toothbrush, rag, and soapy water made with dishwasher detergent.

Lubricate with Neolube as recommended. Run the motor, if possible, to warm up any remaining “peanut butter” and repeat the cleaning process. Continue until the motor runs smoothly.

More on rebuilding P2K mechanisms was posted on my Southern Mountain Railroad blog under “Alco power on the SMR” at [mrh-mag.com/node/27108](http://mrh-mag.com/node/27108).

**Christian Brown:** Some of the older P2K models I have on my roster came home with “solid” grease. It turned clear green, and seized up the gears in the locomotive. Once all that junk was knocked out, the engine ran just fine. I don't think you need to replace the motor.

**Larry of Z'ville:** The gear issue will depend on what type clone the trucks are. The early models were mostly Athearn clones. In this case, all the axle gears of this type crack over time – P2K and Athearn. My experience says that 80 percent are cracked, so I replace them all, to start the clock again. The later models tend to be Kato truck clones. These do not have as many cracked gears, but

# NICK & NORA DESIGNS

Uniquely inspired craftsman kits



Craftsman Structure Kits,  
Detail Parts, Shingles & More!  
[www.nickandnoradesigns.com](http://www.nickandnoradesigns.com)

ADVERTISEMENT

Your Dream,  
Our Ambition!



[www.anemodel.com](http://www.anemodel.com)



## Select MODEL RAILROADS

Design & Build Services  
For Discriminating Modelers



**WE WILL:**  
Complete Unfinished Railroads  
Fix or Rebuild Bad Railroads  
OR  
Design & Build A Custom  
Railroad Of Your Dreams

CLICK HERE FOR OUR WEBSITE  
[www.SelectModelRailroads.com](http://www.SelectModelRailroads.com)  
**(844) 872-4670**

ADVERTISEMENT

HO GP60M, GP60B AND GP60 Locomotives



Now Available!



DC or DCC with Sound!



[www.foxvalleymodels.com](http://www.foxvalleymodels.com)



recently I have seen some of those cracked. Because of the rarity of this problem, the replacement parts are harder to find.

**Jersey Midland:** I had a lot of these engines I had bought new and stored away for years. Despite being brand new and unused, they all needed to have the axle drive gears redone. I had decided to rationalize my collection, and had to re-gear the ones I was selling on eBay to avoid issues – which turned out to be a good selling point. Like anything else, once you've done a couple, you get really good at it and they fly through your hands. All my diesels with four-wheel trucks happily accepted the Athearn #60024 replacement gears which are inexpensive and were available at my local hobby shop.

**duckdogger:** I upgraded three older Proto E-units (three-axle trucks) with new gears. About half of the gears were split, but fortunately I had spares. Then came E-unit number four with three bad gears, and I was out of gears, so I bought an A-line replacement set (also sold by Walthers), their part #40005. No issue with installing the gears on the half axles.

The problem was the new gears did not play well with the truck gears. They look identical to the original gears but they do not mesh. Under magnification the teeth do look a wee bit thicker. I put the frame on rollers and ran it on DC power for about 30 minutes in each direction thinking they just needed breaking in. Nope.

I have always used the Athearn replacement gears without any issues, so I ordered a package from Horizon. I contacted A-line but have not received any reply yet.

Read more about cleaning and repairing Life-Like Proto 2000 engines at [mrhmag.com/node/27983](http://mrhmag.com/node/27983).



## Suitcase connectors

**Q.** I just saw a video in which IDC (suitcase) connectors were used with solid wire. I was under the impression they were for stranded wire only. Can somebody clarify?

—emdsd9

**A. Pelse:** It's the other way around. IDCs are effective and reliable on solid wire, but not so good on stranded wire. Stranded wire does much better with a compression joiner, like a barrier strip or wire nut. Solid wire presents a hard surface for the little knives to dig into, but loose individual strands often squirm out of the way, usually the first time the wire is flexed after you test it. You can get away with IDCs on the larger stranded sizes, but for 16 gauge and smaller you are pushing your luck.



## TIPS

### Smooth paint to the last drop

While many of us have airbrush equipment, occasionally we only need to spray one small item. In this case, a spray can of model paint may be a lot quicker than setting up and cleaning the airbrush. Unfortunately, when the paint in a spray can gets low, it can spit or sputter and otherwise produce uneven results.

A tried and true method of getting the last drop of usable paint out of a spray can is to increase its pressure by warming it. Place the spray can into a pan or a sink with warm (not hot) water up to about the level of the paint. Using a thermometer is optional unless you have extremely hot water from your tap. The water should not be not higher or the can will begin to float.



The can should be left in the warm water for about five minutes. The paint will usually create a smoother coat when heated this way. Some users advise not doing this with new paint cans until some of the paint is used, so the can does not become over-pressured. Do not use other means of warming the paint such as putting it in an oven, or it could explode. Do not put a metal can in a microwave, either.

Paper labels on model paint spray cans could be damaged by placing the can in water. As a precaution against this, I use an oil-based marker (such as a Sharpie) to indicate the brand and color of the paint on the top of the can, around the plastic spray head..

—Victor S. Roseman



## GET PAID FOR YOUR TIP

We pay \$25 per tip we publish, or \$40 each if the tip also includes a photo or finished drawing. [Click here and select article type TIP.](#) ■



S T A T I O N

Model Railroad Technologies  
Accutrack Speedometer 2

NCE  
The Power of DCC

DiGitrax  
Complete Train Control

Tsunami 2

LOKSOUND  
DCC SYSTEMS

TRAIN CONTROL  
SYSTEMS

WOW!  
Only \$64.95



ACCUTRACK II  
SPEEDOMETER

MRT  
Model Railroad  
Technologies

Off On

SETUP  
MPH  
KPH

- Click here to visit our website -

www.LitchfieldStation.com  
623-298-7355

• INDEX



SUBSCRIBE  
(free)

• TABLE OF CONTENTS

# From first train set to railroad empire...

*Our complete line of DCC products  
grows with you. Discover the fun!*

- Designed and manufactured in the U.S.A.
- Preferred for ease of use and ergonomic design
- Unlimited scalability for any size model railroad
- Plug-and-play means more time running trains
- Great customer service and excellent support



## See your dealer



## Visit our new and improved web site for all your DCC needs!

- Get the latest new product announcements
- Watch our detailed how-to videos
- Browse the all-new Information Station
- Enjoy secure online sales, day or night!

Visit **ncedcc.com**



• [INDEX](#)



[SUBSCRIBE](#)  
(free)

• [TABLE OF CONTENTS](#)



**Why settle for sound that is close enough when you can have the exact sound for your locomotives?**



[Click here for a complete listing of sound files and samples.](#) 

**One size does NOT fit all!  
Shown above are seven ALCO 12 cylinder 251's,  
all with slightly different sounds!**

ESU LLC

23 Howard Street, Montoursville Pennsylvania 17754

Phone +1 570-980-1980, Fax +1 866-591-6440

(Office hours: Monday through Friday, 8AM to 4PM (EST))

[WWW.LOKSOUND.COM](http://WWW.LOKSOUND.COM)



# GETTING REAL

column

MIKE ROSE  
.....



Click here to rate or  
comment on this article

## RIDING THE PROTOTYPE OF YOUR LAYOUT | AND THEN MODELING IT, TOO

**IT'S FUNNY HOW SOMETIMES LITTLE THINGS** like off-hand comments and chance meetings with other people can end up having a huge impact. After my last op session, our best yet here on my layout, my friend Mike Confalone remarked on how well the layout was running and coming together, and that the only thing it lacked was a large yard. Bear in mind this was in the context of us having many discussions about a remark that a friend of his had made about how “it’s a shame how much room staging yards take up.” The staging yard remark ended up with my helping Mike C. construct a cross-aisle bridge and scenic level above one of his large staging yards. That experience, combined with his off-hand remark to me, resulted in several weeks of thinking about how I could address my lack of a yard and perhaps use a scenic level above my own staging yard to essentially solve all the layout problems that remained.

What ensued was a decision to make some huge changes to the layout track plan, and included dropping a 22'+ staging yard in

▶ **MODELING REAL RAILROADS AND WHAT THEY DO**



## GETTING REAL | 2

order to allow a new level where it had been in order to model Pittston Yard (which had previously been represented off-layout in staging). Some of my regular readers may have noticed that I skipped a turn on my column; this was needed so I could deal with the massive chaos of this effort. This month's column is only about a relatively small but crucial component of that overall effort, more of which will no doubt be dealt with in future columns.

That covers the “off-hand remark,” but what about the “chance meeting?” Well, as part of my planning for Pittston Yard, I started asking questions on several of the Facebook groups I'm a member of, and started getting some great responses. Eventually one fellow instant-messaged me and said that if I wanted a tour of Pittston Yard, he could make that happen, an astoundingly gracious offer! It turns out that he had attended one of my clinics at a proto modeling meet in Valley Forge some years back, and I'd done that presentation on my efforts to model Mehoopany and the big P&G plant there. Small world!

An amazing tour of Pittston Yard resulted in June 2016, and I was able to get many crucial photos for the modeling effort. But when it was time to do the modeling of a key area on the layout, one that was easily the most difficult part of the rebuild, I realized I had almost nothing to go on. I'd never seen the north portal of

1. (Right) Here's what it looked like passing through Falling Springs (north Pittston Yard limits) when we set out in the morning in an R&N SD40-2, a well-traveled ex-MKT unit. The view is looking back at our train (we are running long hood forward on the trip north). The train included loads for Cascade Paper, Procter & Gamble, and a lot of empty salt cars to interchange with the Lehigh Railway at Mehoopany. Note the close proximity of the tracks to the road, and the road to the mountainside. On the other side of the tracks is the Susquehanna River.



# GETTING REAL | 3



• [INDEX](#)



SUBSCRIBE  
*(free)*

• [TABLE OF CONTENTS](#)

## GETTING REAL | 4



2. (Above) Coming back south, this was the view out the conductor's door. It was a fabulous late summer day, and I could really enjoy the natural beauty of this line. It's hard to believe this piece of railroad was not flooded and washed out more than it was!

3. (Right) Not something you get to see every day, here's the inside of Vosburg Tunnel with the other portal in view far in the distance (the white dot). The "bridge" is actually a support that was constructed by the Reading & Northern when they took over the line from Conrail. Previously a cave-in had truncated this line, and Conrail was serving Mehoopany from the north only. It's also an area where water dripped constantly, no doubt due to some underground spring that caused the cave-in in the first place. The tunnel was double-track in Lehigh Valley days, but the tracks were so close that only one train could traverse it at a time, so it was signaled accordingly.

# GETTING REAL | 5

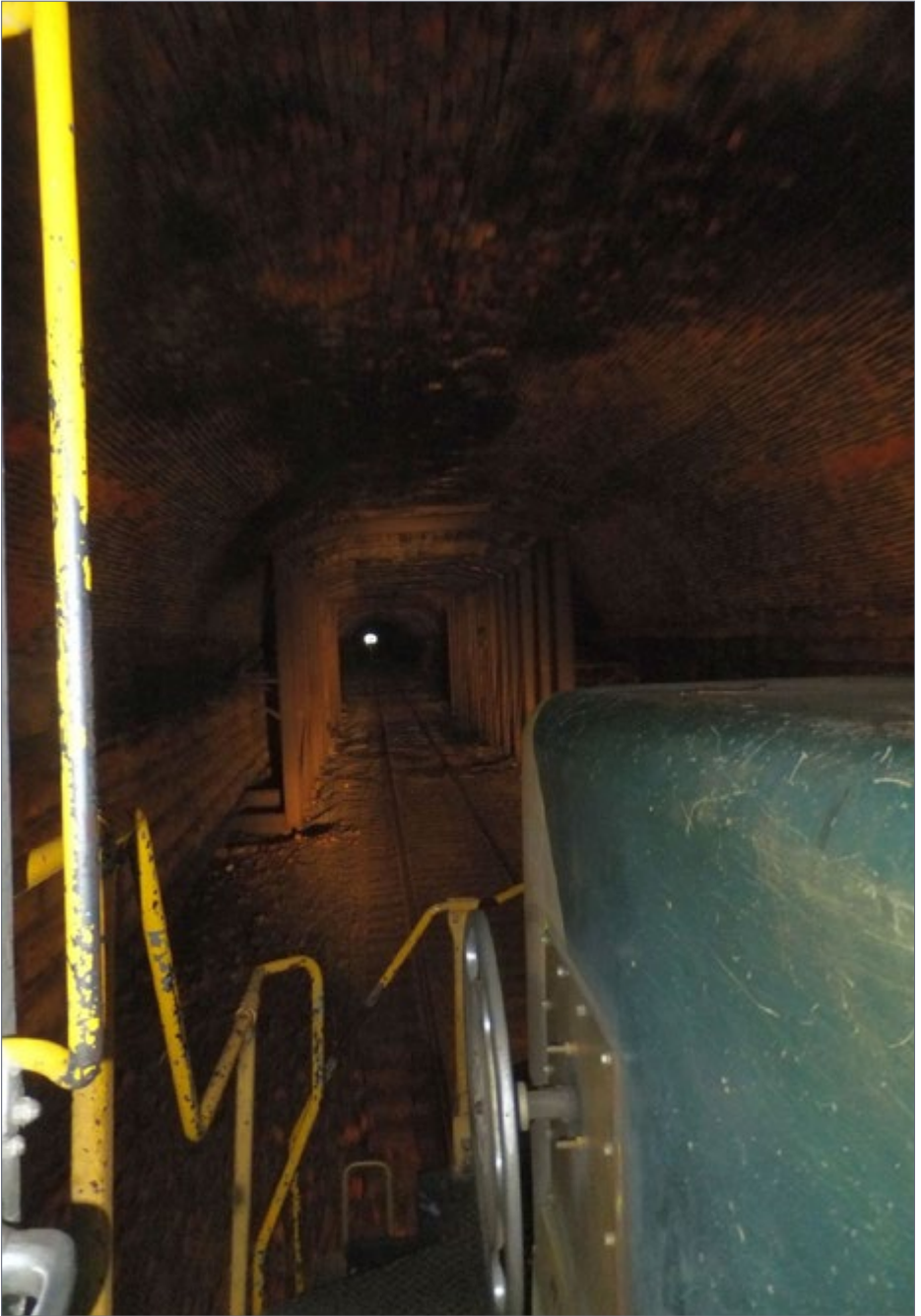

• [INDEX](#)



SUBSCRIBE  
*(free)*

• [TABLE OF CONTENTS](#)

## GETTING REAL | 6

Vosburg Tunnel, and had to build it. I could have winged it, but I decided to try to see it myself.

My new friend Tony V., who works for the Reading & Northern RR, was able to arrange for me to ride with the daily Mehoopany switcher that runs out of Pittston, traverses a significant section of the line I model (the former Lehigh Valley, now Lehigh Line in Conrail days, circa 1985), and switches a paper mill I needed



4. The money shot: Vosburg Tunnel's North Portal taken from the front platform of the stopped SD-40-2, a very convenient type of loco for this sort of thing. Not your typical portal in that it looks like an overgrown single-track portal rather than the stretched ellipse of a normal double-track portal. With some exposed rock on one side and mostly shrubs and trees on top and on the other side, it seemed straightforward to model, though I realized I'd have to mirror-image it for my situation.

## GETTING REAL | 7

to model, as well as the big P&G plant in Mehoopany. Since the train goes right through Vosburg Tunnel, it was an ideal thing to experience. This is the story of that amazing ride and the modeling efforts that resulted from it!



5. Here's my starting point, the former town of Athens. This was going to be the site of a small town and an Ingersoll-Rand plant, but all this was to be changed. For a point of reference, the foreground tracks on the lower level would be retained (they travel around the peninsula, first going through Meshoppen immediately to the right, then Mehoopany, before looping back UNDER Athens as you see it here). The big retaining wall comes out, the upper tracks get dropped and re-routed, and a THIRD track coming south from the yet-to-be-built Pittston Yard all need to coexist somehow right here. I determined the only way to do it would be to control viewing angles, based on where you were standing.



6. Here's the same area post-demolition, showing the retained front tracks. The sub-roadbed with the clamps is for the new track coming south from Pittston (around the curve to the right). The larger flat plywood sub-roadbed is for the new East Yard and main line. To the right rear of the picture the scene has been opened up to the Mehoopany area, but when finished you do NOT want to see Mehoopany from here! I found that the reciprocating power saw shown in the lower left to be ideal for the kind of demolition I needed to do for this project. Note the two tape measures in the shot. I use several tape measures on a project so that at any time I can find one of them ...



7. This shot, taken standing at Mehoopany, shows what I was up against. The new sub-roadbed for the main line south of Pittston is in place here, and I'm starting the foam for the rear backdrop. Note the exposed soil pipe that would need to be hidden somehow, and the re-routing of tracks toward the eventual East Yard. Chaos!



[Click here to rate or comment on this article](#)





8. An alternate view shows where Vosburg Tunnel's portal and mountain will need to be constructed. In order from left-to-right you see the main lines heading to Meshoppen and then Mehoopany, a big gap where that same main will need to run through after Mehoopany, and the south main from Pittston. Yes, I spent a considerable amount of time staring at this scene, trying to figure out how it could ever be something that looked "right."



[Click here to rate or comment on this article](#)





9. With the sub-roadbed in place, it was time to do the scenery that would serve as a backdrop here. I was determined to work from back-to-front, naturally. Here I'm trying to estimate how much foam I have versus what I'll need. What helps is that rather than do a solid mountain, I typically construct mine out of strips, either three or four inches wide. This 2" florist's foam cuts very easily on the table saw, and I use a band saw to cut curves. The foam gets glued together with a good hot glue gun.



10. (Above) Once the foam is in place and roughly carved, it's time for color and dirt. I buy "wrong mixed" earth-colored paint at Home Depot or Lowe's, and then quickly paint the green foam by dipping the brush in the paint and applying it while furiously squirting with a spray bottle of water (a Confalone technique he told me about). It works great and you can color an entire area like this in minutes. While the paint is wet, I sprinkle on real yard dirt I've dried and sifted through old aluminum window screen. Remember you're not trying to model finished ground here. All of this is largely covered by the trees to be planted. The blue tape is holding up a temporary piece of aluminum foil that is protecting the sky-colored paint on the wall.

11. (Right) I had a large stash of ready-made trees that had been salvaged from other demolition sites during the rebuild, and before the paint was even dry, I began installing trees from right-to-left. This area is deep, so the part shown was done with me literally standing inside the benchwork there, right behind my hat!



ADVERTISEMENT

## Great control in a tiny package



**Original  
Touch Toggles**

- Touch Toggle™ plug in controls
- Bright clear indication
- Easy setup
- Flexible system

Stall Motors, Twin-coils,  
Power, and Servos

Now for Tam Valley Depot  
and MRservo too!

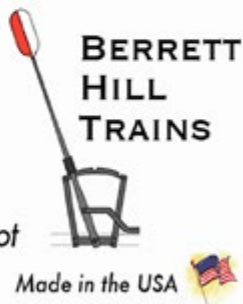

What will they think of next?

[www.berretthillshop.com](http://www.berretthillshop.com)

• INDEX  
.....



SUBSCRIBE  
(free)

• TABLE OF CONTENTS  
.....



12. What a difference trees make! This is the view from Mehoopany, showing the background fully treed.



## GETTING REAL | 16



13. (Above) Here's a view of the same backdrop from the Meshoppen aisle, with the main line now in place and ready for ballast. The auto rack is something I often use to check clearances. This entire hillside, including foam, paint, dirt and trees was done in one afternoon, believe it or not. That's how fast this type of construction goes.

14. (Right) Another "inside the layout" shot. Here I'm standing in the hatch area normally covered by the giant P&G building at Mehoopany. It was the only way to reach the area where I needed to construct a mountain to cover that exposed soil pipe. You want to have lots of foam at your disposal when doing something like this.



[Click here to rate or comment on this article](#)

# GETTING REAL | 17



Get the latest Model Railroading News, Tips, Reviews & Opinions



Our iTunes feed has changed search for  
"Mike And Scotty Live" to receive the latest episodes!

[www.themodelrailroadpodcast.com](http://www.themodelrailroadpodcast.com)

Hosts:

Scott Mason: [www.scottymason.com](http://www.scottymason.com)

Mike Rose: [www.mrhobby.com](http://www.mrhobby.com)

Don't Miss our Monthly Interviews  
& Product Announcements

• [INDEX](#)



SUBSCRIBE  
(free)

• [TABLE OF CONTENTS](#)

## GETTING REAL | 18



15. To the right you can see now how that “soil pipe mountain” is fully in place, and it allowed me to continue right-to-left with the berm that would partially hide the Pittston main (where the auto racks are). The concept is that I wanted to mostly hide that rear track but not have it be fully hidden track. You’ll be aware of your train moving through the trees that will be on this berm, but it will not scream at you that the track should not be next to what’s below, hopefully! The wide cork base below is where the main and East Yard will be located.



[Click here to rate or comment on this article](#)





16. This picture really captures the difficult task of disguising the view of the upper track crossing over the lower track. Somehow a mountain and tunnel portal need to happen here, without TWO tunnel portals!



17. For me, planning the tunnel started with the tunnel portal itself. I took a standard cut-stone Woodland Scenics double-track portal and cut off the outside pilasters on my band saw (an excellent tool for cutting plaster, as it turns out). Note the big keystone cast in place on it – that’s going to have to be changed, as there’s no evidence of anything like that on the prototype portal. Note also that I’m using the old retaining wall material to form the tunnel liner. It was important to line both sides of this tunnel because different insides of it were to be visible depending on your viewpoint, and photography would surely reveal any flaws later. I also wanted the tunnel to be sufficiently dark.

## GETTING REAL | 21



18. I cut half-inch plywood formers to help create the tunnel liner. The insides of the cutout are about half-an-inch larger than the portal's opening so that I could use the Scenic Express flexible retaining wall material as the liner. On the right is a section of Cripplebush rock casting I was testing, salvaged from another area. An area of difficulty is the close proximity of the upper track to the portal, and of the portal to the front main on the extreme left.



[Click here to rate or comment on this article](#)





19. (Above) I used Gorilla Glue and lots of clamps to build up the tunnel liner. The retaining material is a similar kind of foam, and the Gorilla Glue works great if you dampen the surfaces to be glued first. The plastic below is so I would not accidentally glue the whole thing to the cork.

20. (Right) If you're going to install a tunnel portal with liner, you'd better ballast the track first! Note the "muddy" color to the ties. I'd also paint the ballast this color too because that's what the tunnel track looked like when I saw it in person.



[Click here to rate or comment on this article](#)



ADVERTISEMENT



Announces their purchase of  
BEST's  
Laser-cut Structure Kits

CHECK  
IT OUT!



To order or get more information, please email Jeff at:  
[motrakmodels@centurylink.net](mailto:motrakmodels@centurylink.net)

• INDEX



SUBSCRIBE  
(free)

• TABLE OF CONTENTS



21. (Above) With the portal and liner in place, I began cutting up blocks of foam so I could picture how this mountain needed to look.
22. (Top right) From the back side of the mountain, you can see how I needed to blend the scenery of the mountain around the portal into the new scenery heading left toward Skinner's Eddy.
23. (Bottom right) I found it surprisingly easy to wet the plaster portal casting and carve off the keystone, then carve blocks into the blank area.



[Click here to rate or comment on this article](#)

# GETTING REAL | 25



• [INDEX](#)



[SUBSCRIBE](#)  
(free)

• [TABLE OF CONTENTS](#)

## GETTING REAL | 26



24. (Above) I tend to dry-fit all my foam as much as possible, then glue it all up. I learned the hard way that you'd better mark where all the pieces fit if you want to quickly reassemble it with the hot glue. Here I've begun that process and am using weights and a small level to insure proper fit while the glue sets (under a minute, typically).

25. (Top right) Additional roughly pre-carved shapes are beginning to be added here.

26. (Bottom right) The overall mountain shape is really coming together now. Note the relative smoothness of the foam pieces as compared to the previous picture. But it's still a long way from looking "right" here.



# GETTING REAL | 27





27. This overhead shot does a pretty good job of showing the three tracks juxtaposed with one another. Again, from left to right, the Meshoppen main line (with the pencil between the tracks), the return main line after leaving Mehoopany, going into the tunnel, and to the right of the green foam and along the tree line, the Pittston main.



28. Cripplebush rock castings and pieces of thin foam are being worked into place to give the flat mountainside some relief. The green foam allows even small shrubs to be planted anywhere with ease.



[Click here to rate or comment on this article](#)





29. (Above) Most of the foam here is now in place, ready for coloring. Even at this late stage, I'm unsure whether my premise is sound, and I won't really be able to tell until the majority of the vegetation is in place. Talk about going out on a limb! But it's not like I had a lot of choice here, so I soldiered on.

30. (Top right) Here's the opposite angle view of the same stage as the previous photo. All three lines are clearly visible in this atypical angle.

31. (Bottom right) Even coloring and dirt can make a huge difference when you're used to looking at all that green! The new track in East Yard has not yet been painted.

# GETTING REAL | 31



• [INDEX](#)



SUBSCRIBE  
*(free)*

• [TABLE OF CONTENTS](#)

## Combo Right Clamp™

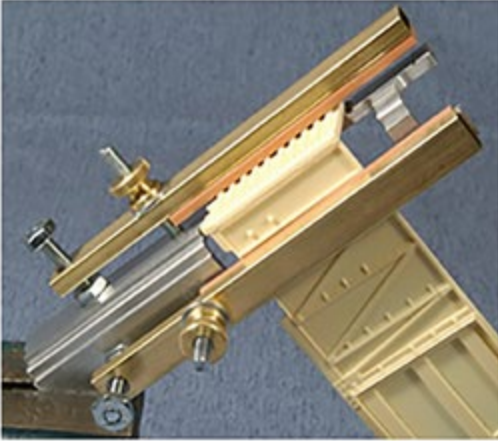

Combo Right Clamp™  
with cast resin boxcar

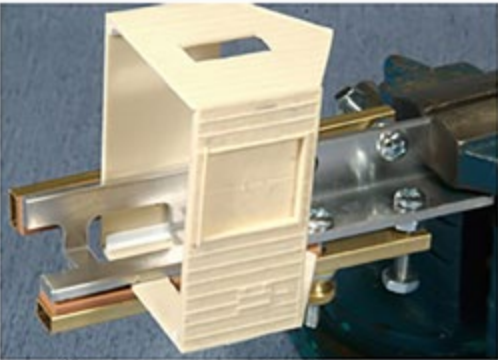

Combo Right Clamp™  
with Wolf Design Pump House

[Click here for  
all our products ...](#)

Tools for Modelers

Coffman Graphic Solutions Co.  
1500 River Circle, Richmond,  
KY 40475-7907

## GETTING REAL | 32



32. Did it work? I think so.  
Even from this "drone shot"  
angle, I don't mind it.



33. Two empties ready for hauling diapers, paper towels and Charmin T.P. are basking in the warm summer sun at East Yard.







## GETTING REAL | 35

34-35. (Top and bottom left) The ground-level shot at East Yard looking into Vosburg Tunnel. Prior to all of this, a train would simply materialize right at Mehoopany, not very prototypical. By pushing the portal back almost a train length, and having the yard be in the correct orientation, operations will now be greatly enhanced. Even on the prototype, the distance between this tunnel portal and the beginning of the P&G property is surprisingly close. I think it compares favorably in terms of “feel” with the prototype shot, shown in [35].

ADVERTISEMENT



[click here](#)

*What makes TrainMasters TV different?*  
We don't just "give you a fish,"  
we "teach you to fish."

Yes, help me  
improve my  
hobby skills

• [INDEX](#)



[SUBSCRIBE](#)  
(free)

• [TABLE OF CONTENTS](#)



36. From the more typical aisle view, you can see how the two CN boxcars are on the siding next to the main at Meshoppen (front track), and you can also see a hint of a boxcar roof in East Yard, but it does not scream “wrong” at you. The slight groove in the tree line is the main out of Pittston heading to staging. Yes it’s a lot of trees, but when you model Pennsylvania, this is what you need to do.



37. East Yard, with Vosburg Tunnel in the distance, taken from “plant grounds” at P&G, Mehoopany. The hillside on the immediate right is what I was working on when standing in the peninsula hatch shown earlier. The access road and yellow yard office building also are new. The main is to the extreme right. The thing to keep in mind is that the entire Vosburg Tunnel scene is designed to be viewed only from this distant, Mehoopany vantage point, yet it had to be built from the aisle down at Meshoppen. You can only guess how many times I trotted all around the peninsula to get a view of how it looked from Mehoopany!



[Click here to rate or comment on this article](#)





## GETTING REAL | 39

38. Am I looking relieved to be done with this phase of the project? Not really. Actually, in this picture I'm pretty much in a zen state after riding around "on" my layout all day. My thanks to Tony V. for making this happen for me, and for the great hospitality extended to me by the Reading & Northern RR and especially conductor Dave and engineer Breezy, both a wealth of information. I learned so much about operating from these two, not the least of which was confirmation that we're actually doing a pretty good job of it on the modeling side! I was amazed that the way they interacted and made decisions was almost identical to what we do in op sessions. And I never knew you could cook pizza on a locomotive cab heater ...

You can't *Get any more Real* than experiencing the actual prototype you model! Many more pictures and impressions from this trip will be part of future articles covering the construction of Pittston Jct. and Pittston Yard, along with the paper mill at Ransom, PA. Stay tuned.



[Click here to rate or comment on this article](#)





# Introducing

Complete Train Control

## *The next Evolution in* Complete Train Control®

- Premium Advanced 5/8 Amp Starter Sets.
- Starter sets are available as standard tethered or duplex radio.
- The system features a DCS210 Advanced Command Station, DT500 series throttle, and includes a power supply to make getting started easier than ever.
- The DT500 series throttles can be purchased separately from the new Starter Set.

Find out more @ [www.digitrax.com](http://www.digitrax.com)



E  
St  
DT  
PS  
  
E  
D  
DT  
PS

# the **EVOLUTION**™



## **Evolution (shown) | \$450 MSRP**

**Standard Set Includes: DCS210 Advanced Command Station, T500 Advanced Super Throttle, UP5 Universal Panel, 6615 power supply, and a LT1 LocoNet Tester.**

## **Evolution Duplex | \$660 MSRP**

**Duplex Set Includes: DCS210 Advanced Command Station, T500D Advanced Duplex Throttle, UR92 Universal Panel, 6615 power supply, and a LT1 LocoNet Tester.**

Brought to  
you by  
**MRH**  
MODEL RAILROAD HOBBYIST

# TRAINMASTERS.TV

## WHAT'S NEW!



More 3D printing tips



Diorama scenery tricks



Upgrading LokSound decoders



Patterned sheet modeling

Non-members: Watch most episodes for \$1.49; become a member for unlimited access

*Our videos are in-depth like MRH articles, except without ads*

• [INDEX](#)

• [TABLE OF CONTENTS](#)





Model Railroad Hobbyist | January 2016 | #83

# WHAT'S NEAT WITH KEN PATTERSON

KEN PATTERSON

column



Click here to rate or  
comment on this article

## MODELING ON THE ROAD, CLEANING UP, AIRBRUSH IMPROVEMENTS, AND BLOOPERS ...

**THIS MONTH MICHAEL GROSS STOPPED BY TO** discuss some of the hoops he needs to jump through to model on the road while acting. Jeff Meyer shows off a new Tangent freight car he weathered. We talk about an easy way to clean the dust off your trees for a fresh look fast. We also build a track cleaning tool that looks nice, works well and you'll be proud to own.

For painting tips, I show some improvements to my airbrushing/spray booth system. For photography tips this month I demonstrate a cover shoot for Athearn covering the basics of indoor layout photography. And finally, I show you a little behind the scenes action on making the Soundtraxx Tsunami 2 steam video along with a few bloopers at the end of the video – just to show a few bumps in my road where everything always seems to work out in the end.

▶ PHOTOS AND VIDEO OF SUPERB MODELS

• INDEX



SUBSCRIBE  
(free)

• TABLE OF CONTENTS

## WHAT'S NEAT | 2

### Track cleaning tool experiment



1. (Above) I like to use this drywall pole sander to clean my garden railroad track. The head rotates to lay flat with even pressure on the abrasive cleaning pad. It got me thinking: why don't we design something like this to use on the indoor HO scale layout to make track cleaning easier?

2. (Top right) We have been using abrasive track erasers for years to clean the track well without scratching the rail. Micro Engineering has these track cleaning pads in their catalog. Shown in the photo are the 2 ½ inch by 2 inch and the 1 by 6 inch track cleaning pads. These are easily cleaned with soap and water to be ready for more use. We will use these abrasive track cleaning pads as the basis for our track cleaning tool experiment.



[Click here to rate or comment on this article](#)

# WHAT'S NEAT | 3



Playback problems? [Click here ...](#)

• [INDEX](#)



SUBSCRIBE  
(free)

• [TABLE OF CONTENTS](#)

## WHAT'S NEAT | 4



3. I started with a scrap piece of oak floor board stock and cut this  $1 \frac{1}{4} \times 2 \frac{1}{2}$  inches and about  $\frac{3}{4}$  of an inch thick. After sanding it smooth, I located the center on the block of wood and drew an X to mark the spot.



[Click here to rate or comment on this article](#)

## WHAT'S NEAT | 5



4. I drew a centered half-inch square on the wood block and drilled a half-inch hole through the center of the square using a drill press.



5. I then used hand files to square the corners of our half-inch square in the wood block. This part was important to get right as you will see in a few more steps.

## WHAT'S NEAT | 6



6. To make our tool look nice, I stained the wood with red oak stain and followed this with a few coats of clear gloss polyurethane.

**Want to help keep  
MRH free?**

**Then *click* on ads!**

## WHAT'S NEAT | 7



7. I cut the Micro Engineering track pad to fit the block of wood. Then I drilled a  $\frac{5}{64}$ th inch hole through the track cleaner and into the wood about  $\frac{1}{4}$  of an inch. I then screwed in two short flathead screws to attach the track pad, sinking the screws  $\frac{1}{32}$  of an inch into the pad for clearance on turn-outs and crossings.



[Click here to rate or comment on this article](#)



## WHAT'S NEAT | 8



8. With this done, reach into your tool chest of ratchets and sockets and pull out your half-inch breaker bar. This will serve as a strong handle for the tool and has a pivot point to aid in our track cleaning tool's success. If I cut the central square correctly the breaker bar will fit perfectly into the block of wood. And, just like that, the tool is finished.



[Click here to rate or comment on this article](#)



*Have you seen this?*

**CHECK IT  
OUT!**



**kenpatterson.com**

*click here to ...*

**Visit Ken's website**

**Ken Patterson  
reveals his modeling  
secrets on video!**



## WHAT'S NEAT | 9



9. Upon testing our new tool it felt strong and well balanced. It made cleaning the inside of my long bridges easy.



10. I was easily able to clean the track in between the buildings on my wharf scene without having to move the structures and without damage to any of the details.



11. I also tested the cleaning tool in my staging/switch yard, where space is tight. It worked well here, too, keeping my hands clear of the freight car roofs.

# Please tell your buddies about MRH!

WE RELY ON WORD-OF-MOUTH TO GROW AND A BIGGER CIRCULATION MEANS MRH IS MORE LIKELY TO STICK AROUND FOR A LONG TIME TO COME!



# WHAT'S NEAT | 11



12. Using an extended length 25-inch breaker bar, I could reach the mainline behind my river scene without having to stand on a stool.



13. It also worked well reaching through the buildings to clean the track in the HOn3 narrow gauge car shops without breaking anything.

## WHAT'S NEAT | 12



14. Experimenting with various breaker bars handles, I noticed some had a higher pivot point than others and caused the 2-inch head to tip. They didn't work very well at all. The solution to this was to create an extended-length wood track cleaning head using the 1-inch by 6-inch Micro Engineering track cleaning pad.



[Click here to rate or comment on this article](#)





15. I found breaker bars varying in price from nine to 30 dollars. They varied in length from 15 inches to 25 inches. I made wood heads for all of them, including a bar with a 3/8" drive that worked well too. What a nice tool to make and give as a gift to a fellow modeler. It's functional, looks nice, and is a tool that will find a lot of use on my indoor layout.

# *TrainMasters TV is part of the MRH product family.*

*TMTV members not only get great network TV level videos, they help pay for MRH and keep it free ...*

## WHAT'S NEAT | 14

### Air brushing system improvements



16. I have just finished putting a roof on my new spray booth's ventilation blower and motor. The box was built from half-inch plywood with legs and has a cement foundation. It is sealed with paint, making it weather-proof. Moving the blower outside makes the room inside a lot quieter while painting. Now the blower sucks air out instead of blowing it, making any holes in the six-inch duct pipe irrelevant and no paint fumes leak into the air in the studio.



[Click here to rate or comment on this article](#)



## WHAT'S NEAT | 15



17. The blower and motor are sheltered in the box. I made doors to access the motor for oiling and fan cleaning and built in plenty of screens for ventilation to keep the motor cool.



[Click here to rate or comment on this article](#)





18. This motor was formerly attached to back of my spray booth in the studio. See it in this photo taken from the November 2014 "What's Neat" video where we talked about my painting system.

**Did you know  
there's an  
MRH index  
available?**

**CLICK TO FIND OUT MORE**



## WHAT'S NEAT | 17



19. (Above) This past fall my neighbors had an estate sale, and the family asked if I would give their father's machine shop compressor a good new home and show it some love. After finding a display location in the studio, I cleaned the machine to look like new. I built a base from  $\frac{3}{4}$  inch plywood with carpet to deaden sound and absorb any vibration. I painted the various parts of the compressor, added air lines to my spray booth, paneled the back wall with polished tread plate, and added LED strip lights to light the display.

20. (Top right) Another useful tool is this 50-foot retractable air hose reel. This allows me to access all corners of the layout with an airbrush without having to unroll and reroll and store loose air hoses as I did in the past.

21. (Bottom right) I also added this industrial quality inline air dryer I picked up at Harbor Freight for under \$30. This takes any moisture out of the air line, eliminating the chance of water spits in your paint work. I added three 6-inch, 100-pound clock gauges to the system giving me airline pressure, tank pressure, and airbrush pressure.

# WHAT'S NEAT | 18



• [INDEX](#)



[SUBSCRIBE](#)  
(free)

• [TABLE OF CONTENTS](#)

## WHAT'S NEAT | 19



22. To drain the tank of any water, I added these handy garden hose connectors to the tank and can run an 8-foot rubber hose out the door to blow the rusty oil-contaminated water outside.



23. I feel like I have preserved an antique tool, with a lot of function left in it, in a display setting fitting of a museum. The LED lights complement the compressor's interesting details. The functional display fits perfectly under the Kimswick River section of the layout, right next to my spray booth.

## WHAT'S NEAT | 20



24: Another benefit to moving the blower outside is the fact that I can now attach a 6-inch duct hose allowing the spray booth to be moved up to eight feet around the room to position it in front of larger painting projects.



[Click here to rate or comment on this article](#)



## WHAT'S NEAT | 21



25. On the inside of the spray booth I installed a sheet of copper plate to protect the wood from paint. When polished, it looks really nice. A charcoal furnace filter works well to keep paint particles from clogging up the squirrel cage blower fan fins. It also keeps cigarette odors from smelling up the duct and spray booth area in general in the event back pressure air blows into the room when the system is off.



[Click here to rate or comment on this article](#)

# WHAT'S NEAT | 22

## On the road modeling with Michael Gross



26. Our friend and fellow model railroader Michael Gross stopped by to run a few trains and talk about some of the process he follows when modeling out of a hotel room while on the road working as a movie actor. In this month's video, we travel with Mike to see the tools and process necessary to detail and build models on the road.



## WHAT'S NEAT | 23



27. This photo from the video shows the tools he carries with him to do freight car building and super-detailing. He packs parts like stirrups, coupler cut bars, brake rigging, air hoses, roof walks, grab irons, up-graded couplers and so on; simple stuff requiring a minimal number of tools and glues. He saves the airbrushing work for when he returns home to his workshop. This is his hotel room work “bench” where he can relax and enjoy his off time detailing freight cars.



# WHAT'S NEAT | 24



28. He usually carries four freight cars with him. These, along with his tools and parts fits into a box which fits well into his checked luggage for air travel. Watch as Mike packs things up for the next stop on his acting journey.



[Click here to rate or comment on this article](#)

# WHAT'S NEAT | 25

## Indoor Athearn photo shoot

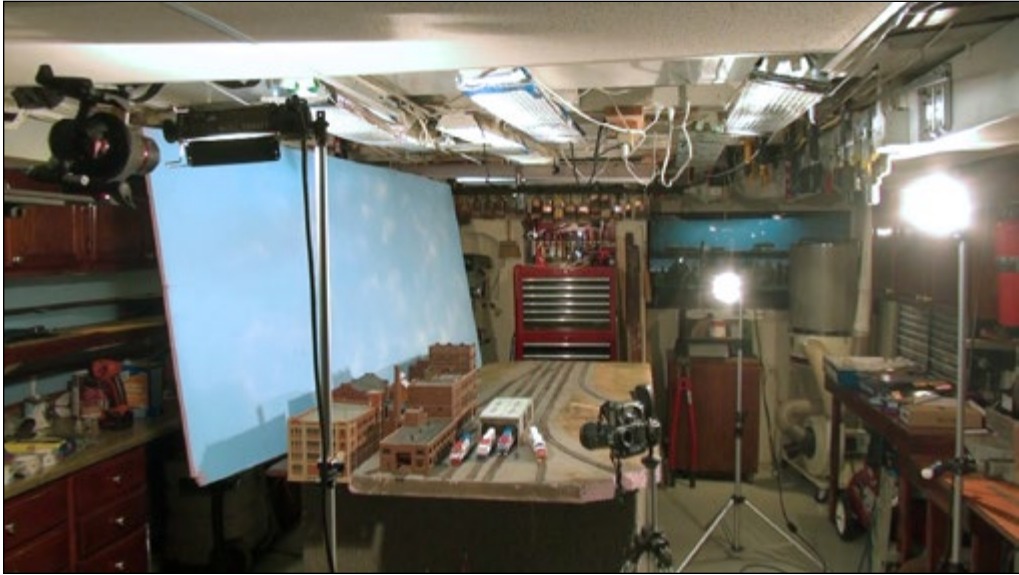

29. This month I show you the basic set-up to shoot this Athearn cover photo for marketing models. The scene is the switch yard diorama we build last year. The scene is lit with three 1000 watt lights. The backdrop is foam painted blue with a few clouds sprayed in place.



30. Shooting at exposures of  $\frac{3}{4}$  of a second at f22, with ISO of 100 and using a 12 to 18mm lens allows me to shoot well-balanced photos in a controlled environment without the hazards of outdoor photos – wind, bugs, high temperatures, too overcast, on and on.



## Jeff Meyer segment



31. This month Jeff Meyer stops by and shows us a new Tangent Airslide hopper he weathered to match a photo on the Tangent website at [tangentscalemodels.com](http://tangentscalemodels.com). As Jeff sets up to shoot his model, note his one-hand grip tripod head which makes setting up a photo faster than adjusting three pivot points on regular tripod head.



**Click here to rate or  
comment on this article**

## WHAT'S NEAT | 28



32. This is the model photo Jeff shot. He used oil paints to create the effect of grime collecting on the side panels where they flex or bow unevenly, making for grime collection points where the panels bow outward. By feathering the paint from light opacity along the edges to more enhanced centered grime, the effect is immediately identifiable for representing the wavy car sides seen in so many prototype photos.



# WHAT'S NEAT | 29

## Scenery tips: Dust removal magic



## WHAT'S NEAT | 30

33-34. (Left, top and bottom) I needed to shoot some runby video for a recent Athearn video and noticed gray dust on all the vegetation. Well, I needed to shoot video right now and needed this dust cleaned up fast. My solution was to spray the area wet with hair spray. This makes the dust magically disappear. What happens is the dust is encapsulated in the clear alcohol-based lacquers, causing it to change from gray to clear, essentially making the dust disappear in seconds. I find it helpful to follow up with a little fresh ground foam while the hair spray is still tacky, to freshen up the scenery.

ADVERTISEMENT



**1<sup>st</sup>** choice for model railway supplies and service.

Expedited mail service available across North America.

Click to visit  
**WWW.CVRCO.COM**  
**1 800 464 1730**



• INDEX



SUBSCRIBE  
(free)

• TABLE OF CONTENTS

## WHAT'S NEAT | 31

### Soundtraxx video: making props and bloopers



35. This was the city scene I set up to shoot the outdoor video footage in the making of the Soundtraxx Tsunami 2 Steam demonstration video. It is one of those scenes you only get to see set up once – then it's gone. I used every building I had on hand along with a 12-foot-long operating diorama hooked up to DCC.



[Click here to rate or comment on this article](#)



## WHAT'S NEAT | 32

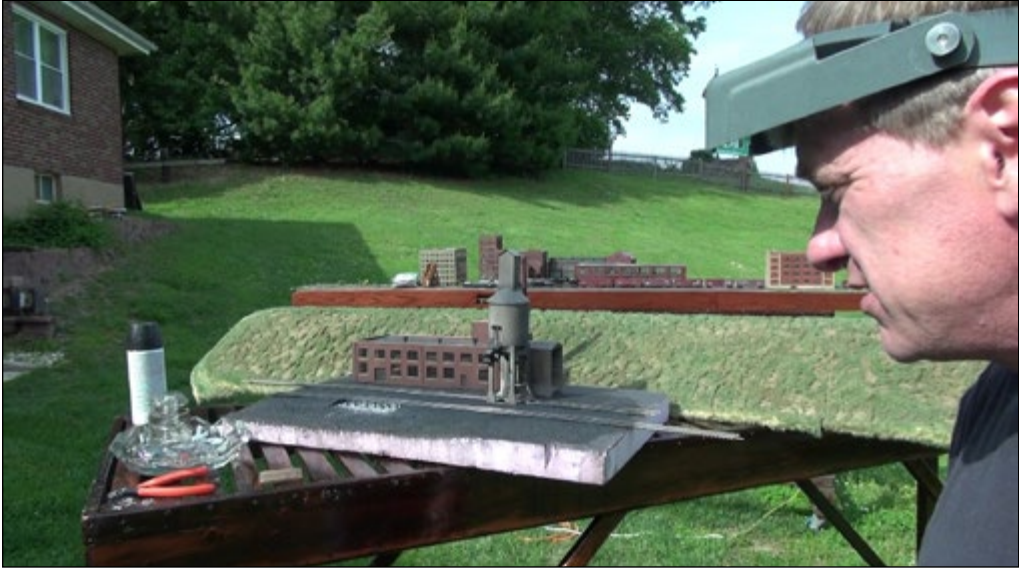

36. Here's an ash dump scene I had to build in an hour to shoot video of Fireman Fred cleaning the ash pan with full sound effects. I simply ballasted two rows of track with black ballast, elevating the rails over the pit with 6x6 posts.



37. The crazy thing was how I used cigarette ash to add color and texture to the ash pit. It worked perfectly, finishing the scene with accurate colors moments before the video shoot.





38. I end this month's video with bloopers and bleeps. They don't work well in the still text portion of the magazine but this one photo (also in the video) captures the overall funny effect and truly illustrates the hazards of outdoor model photography. ✓



[Click here to rate or comment on this article](#)



Make it run like a

# Dream TRACKWORK BOOK

104 pages

By Joe Fugate

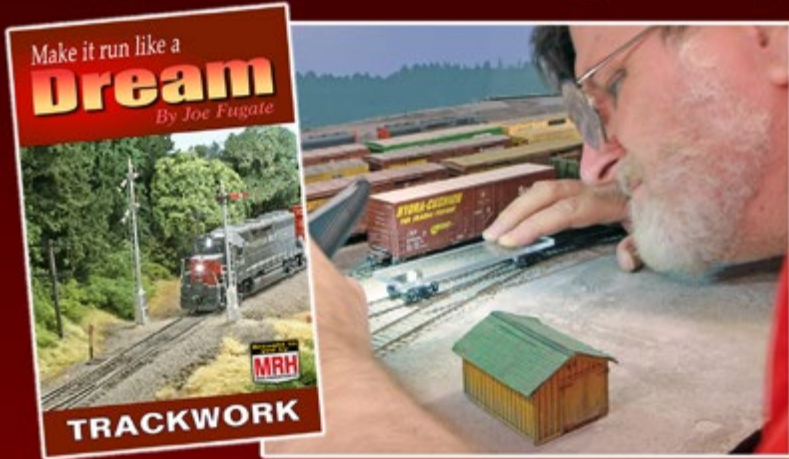

"The new bible of track laying." - *L.T.*

"Chapter 3 alone is worth the cover price." - *B.M.*

"A lot of info ... copiously illustrated.." - *J.A.*

Click me to  
**GET eBook NOW >>**  
~~\$12.99~~ \$11.99

Click me to  
**ORDER PAPERBACK >>**  
~~\$29.99~~ \$27.99 + S&H

Available from the MRH Store: [store.mrhmag.com](http://store.mrhmag.com)

Other books coming in this series: *ROLLING STOCK* (Mar 2017) and *LOCOS* (Sep 2017)

• [INDEX](#)

• [TABLE OF CONTENTS](#)



# IMAGINEERING

column

ROB CLARK AND  
.....  
DAVE MEEK  
.....



[Click here to rate or comment on this article](#)

## TWO VIEWS...

**SCENIC DEPTH IS AN AGE-OLD ISSUE FOR** railroad modelers. How do we achieve the feeling of outdoor openness in our train room?

Back in early 2015 Joe Fugate introduced the idea of an Imagineering column and defined the different kinds of prototype and freelance modeling we see in the hobby.

These are just points on a line between strict prototypical accuracy and total fantasy. Just to remind you:

- Strict prototype - total accuracy
- Loose prototype - small variances to increase fun
- Strict proto-freelance - actual prototype practices with freelance elements
- Loose proto-freelance - no such prototype, but keep it plausible
- Strict freelance – somewhat fanciful, but still feels like “real” trains
- Loose freelance – anything goes as long as it’s trains and it’s fun

▶ EXPLORING THE CREATIVE SIDES OF THE HOBBY



Rob Clark and Dave Meek are two of our Imagineering columnists who sit at points four (Cornhill and Atherton RR) and six (Thunder Mesa Mining Co.) respectively. They have entirely different types of railroads, both in terms of genre and implementation style, but share common views about the artistic aspects of the hobby.

Here they present some personal (sometimes opposing) views about the challenges that achieving scenic depth presents. Rob is focusing on the illusion of depth, while Dave presents a case for real scenic depth.

### Rob Clark : Scenic Depth – “I want it all”

Being a greedy individual I want the best of both worlds – easy to access/easy to model; narrow scenes and grand vistas extending into the wild blue yonder.

I have a small railroad room (11’ x 8’) and accessibility is the key word that covers all constructional aspects of the Cornhill & Atherton. Before the build started, I decided that 12 inches was the maximum reach that should be made for any uncoupling maneuver (I use the bamboo skewer technique) and 24 inches maximum reach for all other track locations. Maintenance and on-going improvements have to be possible if a railroad is to be continually operational and evolving.

There are the lucky ones among us who have large railroad rooms, but the techniques used to give the illusion of scenic depth in a small room are equally valid in a big room and can make a large space seem enormous.

Whilst still a popular “starter” choice, the modern trend is to move away from the 4’x8’ tabletop approach which spawned many deep and dense trackwork designs in the past. Now we tend more towards shelf-type railroads which run around the room.

So we have two challenges:

# IMAGINEERING | 3

- Shallow baseboard – easy uncoupling and maintenance, but how to get sense of depth?
- Deep baseboard – great visual depth, but what about uncoupling and maintenance?

Trackwork design easily solves the second problem by ensuring that no turnouts or industry/uncoupling points are out of reach. If you absolutely must have a piece of track at the back of a scene, then make sure you have no switchable industries “out there” and that you can reach it somehow, because it’s guaranteed that’s where the derailment is going to happen.

The key to getting depth in a shallow scene (and greater depth in a deep scene) is to steal theater techniques which exploit forced perspective and multiple layers, which visually interact [1].

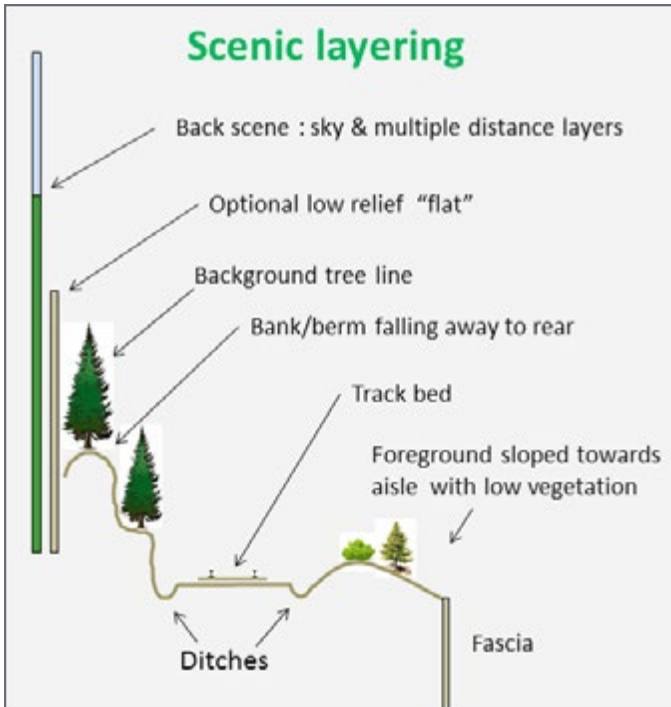

1. Scenic Layering.

## **Layer 1 – The back scene**

This is a realistic looking backdrop, suitably scaled. It can be a photographic or (much more difficult) painted scene, which can represent more than one distance layer. For example: sky, then distant mountains followed by a distant tree line. Buildings can also be included – again by suitably scaling to give the impression that they are far away.

## **Layer 2 – The low relief “flat”**

This very much an optional item, but you can apply another 2D picture layer to a supporting sheet of thin wood and place it (a centimeter will do) in front of the back scene. We get an extra dimension of depth for very little actual “depth cost” and texturing the flat, by applying ground foam or tree material can also greatly enhance the illusion of depth ([youtube.com/watch?v=bfaDY\\_ffjYs](https://www.youtube.com/watch?v=bfaDY_ffjYs)).

## **Layer 3 – Background tree line**

This is modeled “for real” using 3D trees which can be of a reasonable size. This provides the crucial link between the 2D and 3D worlds and sits on:

## **Layer 4 – Bank (or berm) at the rear of the track bed area**

This is where most of the vegetation, rock, scree, grass and shrub modeling takes place. The critical thing is to “roll off” the back of the bank at the rear, so that you can’t see the edge butting up to the back scene. You can also plant smaller trees and shrubs on the rear slope and since you can’t see the vegetation base, they look like they are in the distance.

## **Layer 5 – Foreground slope**

This can be raked like a stage from front to back and like the bank on the rear of the track bed, can benefit from a small



## IMAGINEERING | 5

drop off towards the track bed. Trees and shrubs provide mini view blocks which both assist with the sense of depth and also increase the separation of scenes, to make it feel like the train has traveled farther.

Whatever you are doing, keep the colors muted, particularly in the background – this helps with the illusion of depth because distance fogs clarity!

A picture tells a thousand words – so let's have a look at some examples of a variety of scenic depth techniques at work:



2. Here is an example of forcing perspective in a relatively shallow scene (17") through a number of techniques. The mirror on the creek is a cheap shot, but it works well. The distant hills are separated by a tree line immediately in front of the backdrop, the meandering stream slows the eye's movement from front to back and the surrounding scenery ascends into the distance before dropping off on the "horizon."

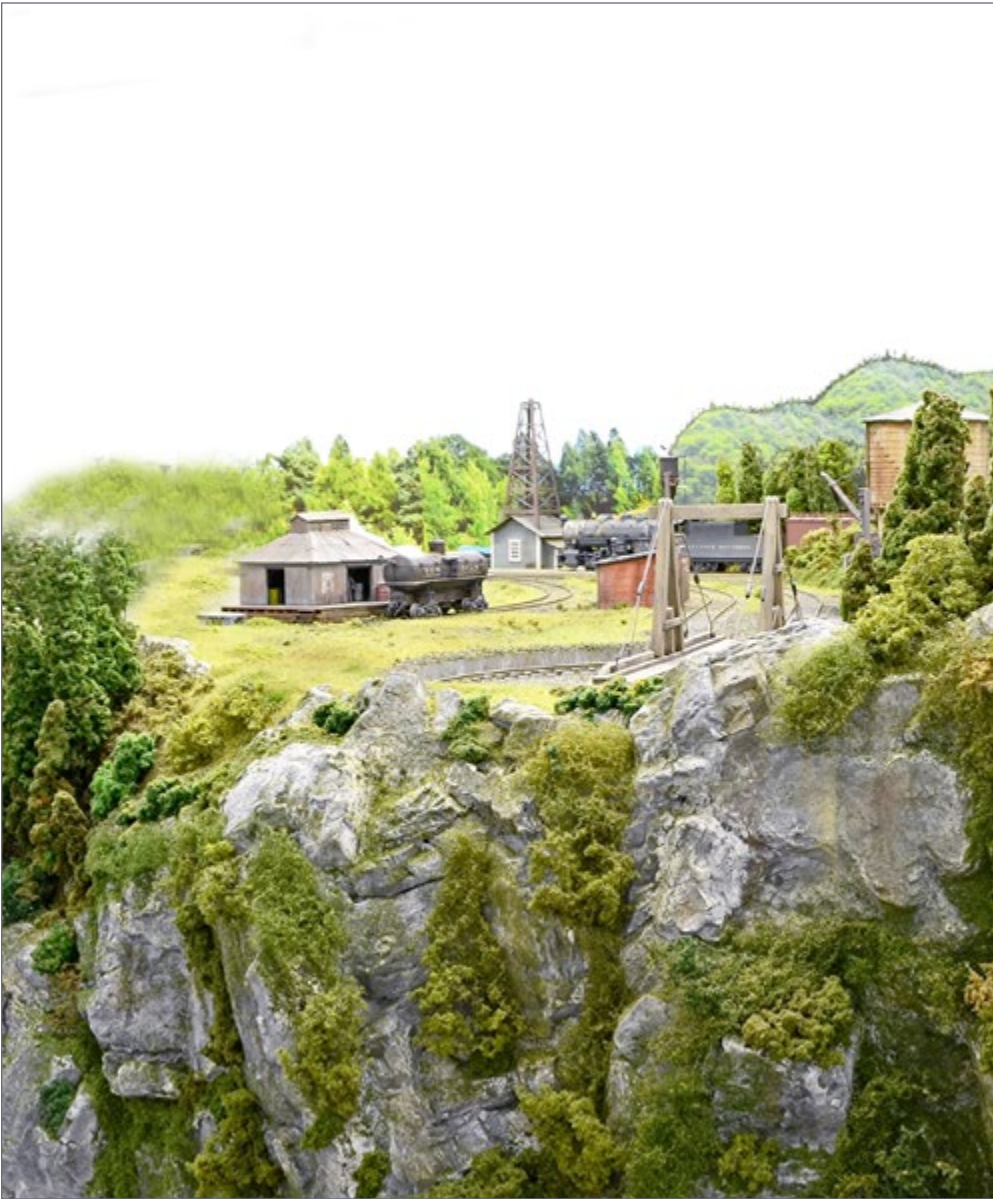

3. Forced perspective used "aggressively." The trees on the background hill are much smaller than those in the foreground giving a greater sense of distance. All of the tree groups are de-



signed to visually integrate from a number of viewing angles, so they appear to combine into a single scene.





4. This is a different view of the scene in [3] where we have lots of depth available (36") and further exploit it by borrowing the treeline from the far wall to the right. The turntable is at the front of the baseboard – so easy to operate. No uncoupling is required in the terminal area – only lone locomotives move around here. Careful track planning can allow deep scenes that are practical to operate and maintain.



[Click here to rate or comment on this article](#)





5. Remember that “depth” becomes “width” when viewed from the side! In this shot we are looking into a corner and again, the background scenery complements the foreground both in color and form. The base board is only 16” at its widest point at the left of the shot, but because it blends with the background it looks huge. OK – the camera angle helps with the illusion and I’ve Photoshopped a small patch of grass on the far left, but it still looks great in real life too!



[Click here to rate or comment on this article](#)





6. Only six inches from front to back in this shot, and formed from five layers of scenery. Two “flats” of mountains and then the distant tree line, then a background tree line followed by a





mid-distance bank with shrubs, then the track bed and finally foreground shrub and grass line sloped down from track. This scene forms the left background to [5].



7. Another example of forced perspective. On the left you can see the backdrop with mountains and the background tree line. Immediately above the mine buildings we have a “flat” that is inserted in front of the backdrop, and represents the mountain above the where the adit (horizontal) mine shaft enters. You can also texture these flats if you wish (a bit like decoupage).



[Click here to rate or comment on this article](#)





8. Notice how the darkness under the tree line gives the impression that you could “walk” into the forest. When you can’t see clearly what is going on, the brain fills in the gaps, and this can be used to our advantage with scenic depth.



[Click here to rate or comment on this article](#)





9. The opposite effect can also work. By having a bright neutral background, our eyes follow the view and assume that the path by the side of the engine house goes somewhere interesting “just round the corner.”



[Click here to rate or comment on this article](#)





10. Here's an old trick that many people do better than I. The road continues into the backdrop and is blended using careful color matching and a small "hump" in the road to disguise the joint. It's exactly the same principle as the rear fall-off on a background tree line (Layer 3 of the Scenic layering picture).





[Click here to rate or comment on this article](#)



## Dave Meek: Going deep

As Rob Clark has pointed out, there are many tried-and-true techniques for creating the illusion of scenic depth in what are actually relatively shallow scenes. But what if, like me, you want *real* depth? I'm talking John Allen-style floor-to-ceiling "Giant Canyon" type depth.

What if you want some deep, dramatic views on your layout that are 8, 10, 12 feet deep or more? With a little careful planning, it is possible to have that depth while still keeping all of the important stuff within easy reach.

Imagineers know how to stage compositions for maximum emotional impact. As a general rule, flat, shallow compositions where everything is staged parallel to the viewer and little perspective is revealed tend to read as comedic.

Think of your favorite comic strip or situation comedy for apt examples. Shallow scenes can appear cute, charming, funny, or just plain flat, but rarely as dramatic. On the other hand, deep scenes that reveal perspective, atmosphere and distant space are read as more dramatic.

Many classic paintings from the Renaissance offer good examples of this. Depth equals drama, and since we live in a world of expansive vistas, it's also far more realistic.

### **Designing for depth: In praise of the peninsula**

Many around-the-walls type layouts also employ a peninsula or two in order to make the most of available space. That's a good thing, but a modern trend has been to bisect these peninsulas with backdrops, effectively blocking the deep view of other parts of the layout and rendering them little more than freestanding shelves in the middle of the room. There are instances where this

might be appropriate, but if you want truly deep scenes, cutting your peninsula in half with a backdrop can be a design mistake.

A better option, in my view, is to plan for depth. The dead space of aisles between peninsula and wall sections can be used as found real estate to separate scenes into foreground, middle-ground, and background, with ever changing vistas as people interact with the layout. Paying careful attention to things like sightlines and the vertical separation between the highest scenery and the lowest can result in deep, dramatic scenes that look like they go on forever.

Combining a scenicked peninsula with sections of a layout that are up against the wall or backdrop gives you a

## ADVERTISEMENT

**CRAFTSMAN KITS**

Our instruction manuals are second to none!  
**CHECK IT ALL OUT AT**  
**WWW.RUSTYSTUMPS.COM**  
THE QUALITY IS INSIDE BECAUSE OUR NAME IS OUTSIDE



**DID YOU KNOW  
MRH SUBSCRIBERS  
GET FREE BONUSES?**

**CLICK TO SUBSCRIBE  
NOW - IT'S FREE!**



best-of-both-worlds opportunity for deep and dramatic views, while still keeping the operational advantages of an around the walls type plan. The foreground scenes in one area can also play the role of distant background for other scenes across the aisle.

Not every view on a model railroad can or will be perfect, but it is possible to pick out a few special places where everything comes together. These have been called “signature scenes” or “establishing shots,” but for this discussion let’s just call them **Primary Viewing Angles** [1]. These are the special, camera-worthy viewpoints that make the most of your layout’s scenic depth.

My On30 Thunder Mesa Mining Co. layout is still far from finished, but as I continue to build and plan, I pay special attention to areas of maximum scenic depth and the sight lines that will

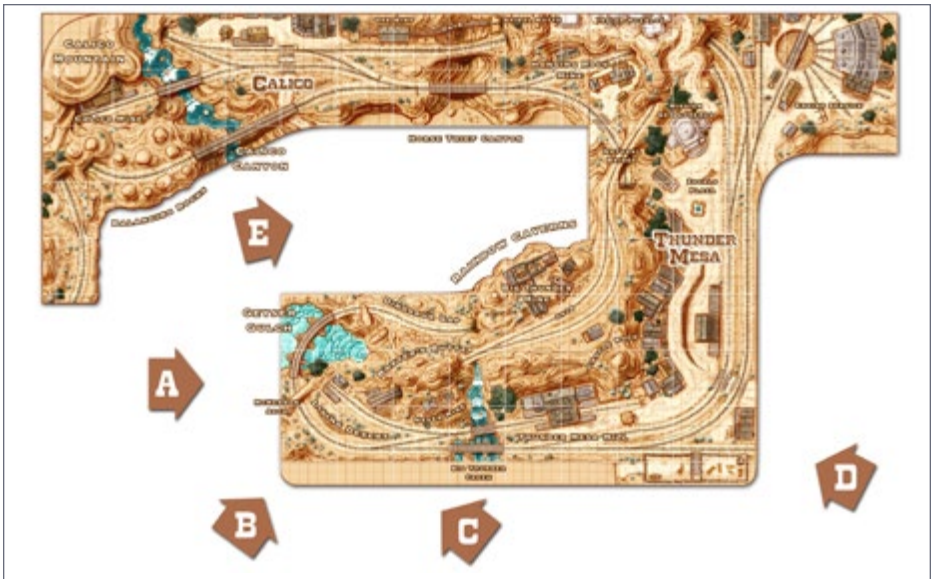

1. Some Primary Viewing Angles on the TMMC, showing how I plan sightlines to maximize scenic depth. Excluding the front aisle, the overall size of the layout is about 8.5 x 15.5'. That makes the longest views, like viewpoint **D**, over 16' deep.

offer the most dramatic views. These Primary Viewing Angles are spots that offer something interesting in the fore or midground, and vast expanses of modeled real estate in the background [2].

Moving around the layout, I use the camera as a design aide, framing vistas through the viewfinder and taking note of anything that might destroy the believable illusion of distance.

This camera view becomes the arbiter of how low the scenery should drop across the aisle so that no fascia can be seen, and it can also dictate the height and placement of other scenic elements for maximum visual impact [3].

If you ever have any questions about how a scene is working out, or what exactly is or isn't visible in the distance, I highly recommend getting out the camera and snapping a view frames from your own Primary Viewing Angles. More than just a way of documenting your work, a camera can be an invaluable design tool, especially when planning for deep scenes.

## **Enhancing the illusion of depth using vertical separation**

Since I'm modeling canyon country on my On30 Thunder Mesa layout, it's relatively easy for me to think of the aisles between sections as deep, un-senicked canyons. I've even named the primary aisle "Coyote Canyon" to remind myself of this.

Taking the idea one step farther, I drop the scenery at the layout's edge down low enough so that when viewed from across the aisle, the foreground peninsula scenes blend seamlessly with distant areas of the layout along the backdrop with no fascia visible to destroy the illusion. This is using vertical separation, that is, the relative distance between lower and higher scenic elements, to enhance the illusion of depth in a given view [4].

Naturally, there are many variables at work here, including the relative height of the viewer, but using your own eye level as a





2. From viewpoint **A**, this scene is about 12' deep. Forced perspective on the rocks at different levels enhances the feeling of distance. The backdrop is being built in two layers: A canyon scenery backdrop layer will be installed at the base of the sky backdrop to complete the illusion of wide-open spaces.



**3. Viewpoint B:** Checking sightlines with a camera here led me to lower the fascia on the far side of the aisle by several inches, ensuring that nothing but canyon scenery will be visible when this section is finished.

benchmark is as good a place to start as any. My Primary Viewing Angles are designed to achieve maximum impact when the foreground is at or just above eye level [5].

It's worth pointing out that this technique need not be limited to modelers of mountainous or canyon like terrain. The same effect could also be achieved with rolling hills, forests, or farmland. Very little of our world is actually flat. Even the wide open prairies have ravines and stream beds that could be used in this way to interesting scenic effect.

Get down and look across the aisle from a trackside perspective and imagineer your terrain with the fascia out of view for scenes that can reach to the horizon.



4. Looking towards Calico Mountain from near viewpoint C: From the bottom of Calico Canyon to the planned summit of the mountain will be approximately 42" (168' in O scale). This deep



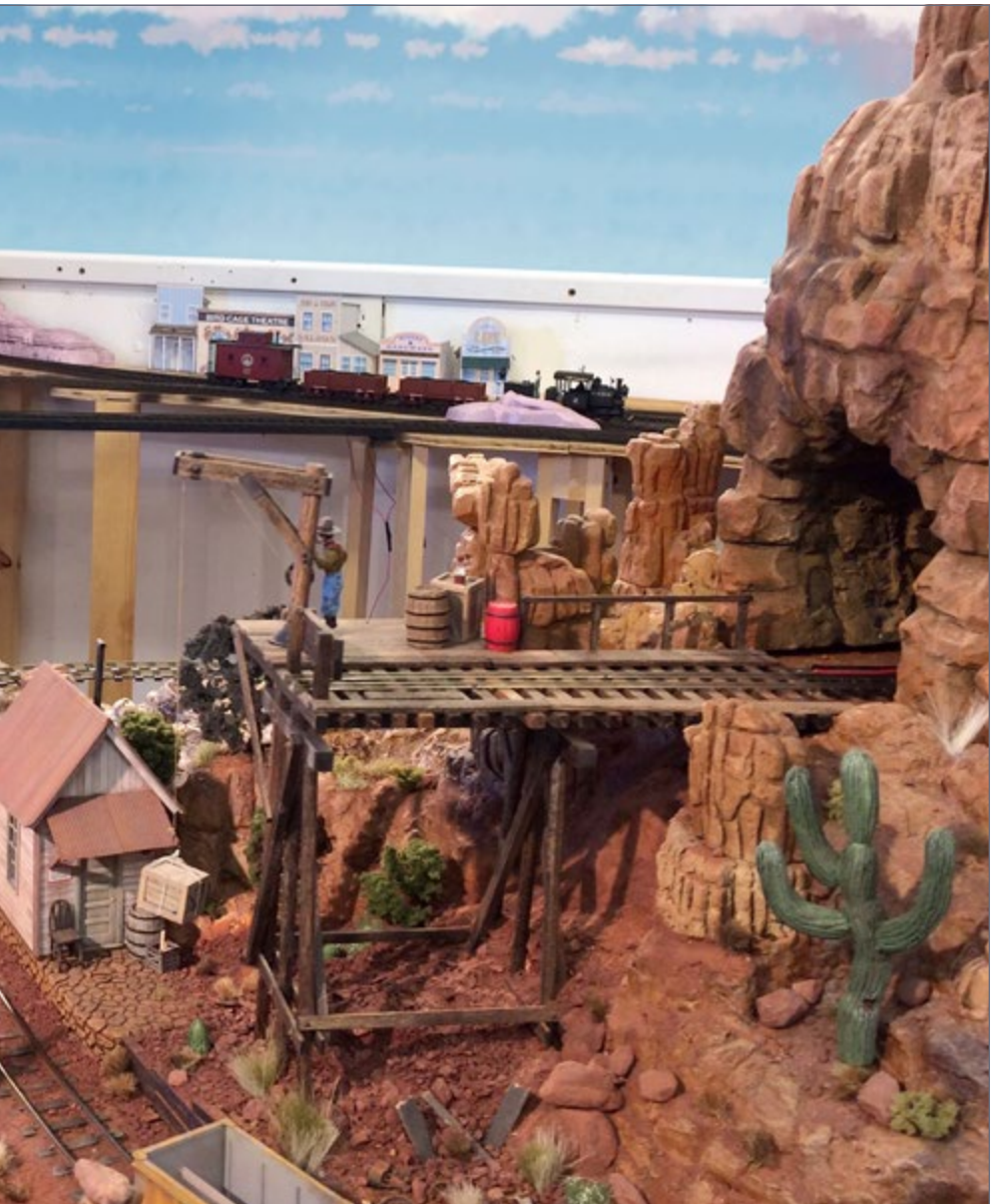

canyon makes the most of the “found real estate” in the main aisle, providing an unbroken view with the far scene of Calico as background for the peninsula.





5. At viewpoint **D**, from Thunder Mesa town to Calico Mountain, we can look across about 16' of model railroad. This is one of the deepest views on the layout and currently shows a lot of finished and unfinished scenery work, with mock-up structures



and other details holding the place for future models. Still, it gives some idea of the scenic depth that can be achieved on a relatively modest sized railroad.



## You have to build it

Not every model railroader enjoys building scenery. In fact, some seem to avoid it like the plague. But the fact is, if you like deep scenery and want those dramatic vistas on your railroad, you actually have to build them [6]. A backdrop, as the name implies, belongs in the back. It can be an enhancement and continuation of the modeled scene, but not a replacement for it. I think that part of the trend towards shallower shelf-type layouts has been driven by a desire to model less scenery more quickly.



6. Deep in the aisle, viewpoint E reveals just how much scenery is yet to be built. One day, this spot will offer great views for operators and guests, but if I want more vast expanses of deep scenery, I actually have to build it!

That's fine, but it puts nearly all of the emphasis on the foreground at the expense of believable depth. I have a hunch that one of the reasons why the venerable 4'x8' tabletop style layout continues to be one of the most common choices among first time layout builders is because it actually offers the opportunity for some deep scenes and immersive world building in a relatively compact space. From that perspective, it's really not a bad choice at all.

There was a point during the build of Thunder Mesa where I seriously considered ripping the whole thing out and starting again with a more mainstream, linear, around-the-walls type shelf design.

Fortunately a good friend stepped in and reminded me why that would be a terrible idea. He said that one of the most appealing things about my layout was the feeling of depth and distance in the scenes. Things had dimension; more than one side. You couldn't take it all in at once. That, he pointed out, was what made it a unique, immersive, and believable world.

I decided my friend was right and have kept on plugging away, building every nook and cranny of those deep, elaborate, canyon scenes. It can be labor intensive but I wouldn't call it work.

When I walk into the train room and the view takes me away to another place and time, I know that it's worth it.





# MRH MARKETPLACE



**Yarmouth Model Works**  
HO scale resin kits and detail parts

USA MAILING ADDRESS  
3550 Pine Grove Ave. Unit 617  
Port Huron, MI 48060

Canadian Mailing Address  
85 Hildaatha St.  
St. Thomas, ON N5P 2T5

Tel: 519-633-7574  
pierre.oliver@start.ca  
www.yarmouthmodelworks.com

**CROW RIVER PRODUCTS**

**KIT 317 SOUTHWEST LEDGE LIGHT**  
An "O" Scale Victorian Lighthouse  
For the Layout or the Display Shelf



The model is resin & Pewter castings with laser cut details.

Footprint 6 1/2" Sq.  
14" High

Price \$185.00

Made in USA

For adult Hobbyist

HO & O Scale

Machinery, Derricks,  
Engines, Hardware & Waterfront Models  
Pawtucket, RI 02861 Tel 401-723-0065  
www.crowriverproducts.com

*Imagine that!*  
Laser Art Products

**ITLA Scale Models**

*Precision Laser Cut Wood Products*

*Cooper's Alley  
HO Scale Laser Cut Wood Kit*



CLICK HERE FOR MORE INFORMATION  
[www.itlascalemodels.com](http://www.itlascalemodels.com)



GREAT LOOKING TREES  
MAKE ALL THE DIFFERENCE

CANYON CREEK  
scenics

**Trees**

[coastmans.com](http://coastmans.com) HO



# MRH MARKETPLACE | 2



## TAM Industries

"Preserving the Romance"

The highest quality in Display Cases for sharing your excitement of Model Railroading. We manufacture Display Cases for all gauges of Model Railroading, from "G" to "N". Custom Sizes are available for some styles.



Visit us today at: [www.TAM-IndustriesOnline.com](http://www.TAM-IndustriesOnline.com)

## NEW #8 HO/HON3 DUAL GAUGE LEFT TURNOUT TEMPLATE



Anyone can build track with Oak Hill.

Template Kit comes with everything cut, filed, gaped, and formed to make 5 turnouts, plus 1 free tube of Pliobond.

See Ken Patterson's What's Neat to see just how easy it can be!

[Click to see video](#)



[www.ohrtracksupply.com](http://www.ohrtracksupply.com)



Affordable Modular (domino) Benchwork in 200+ sizes

Custom built to order benchwork also available!

**PRE-SIZE**  
MODEL SPECIALTIES

P.O. Box 6 Paonia, CO 81428

Ph. 970 527 4586

Made in The USA

Cast resin items for All Scales.

Tunnel portals, bridge piers, abutments, culverts, and retaining walls.

Trackside details and sage brush tree armatures.

"FREE SHIPPING see website for details"

LOOK at what's new at Black Cat this month

[Click here for our website](#)

GTW post '61  
8 hatch or wood  
Reefers

GT

Black Cat Publishing  
(204)489-5005  
[ajfergus@mymts.net](mailto:ajfergus@mymts.net)  
[blackcatdecals.com](http://blackcatdecals.com)



Port Costa  
R.H

2 stall RH  
in HO scale all  
laser cut wood  
#2097 \$170



421 Hopkins Road, Dummerston, VT 05301

802-258-3869

See all of our fine products from HO to F/G scales at:

[www.bantamodelworks.com](http://www.bantamodelworks.com)

• INDEX



SUBSCRIBE  
(free)

• TABLE OF CONTENTS

FEATURING  
**America's Historic  
 Main Street Architecture**



O-Scale model shown (HO available)

**MAINSTREET  
 HERITAGE**

[www.mainstreet-heritage.com](http://www.mainstreet-heritage.com)

**W** GOLDEN AGE LINE  
**WESTERFIELD**  
 MODELS, LLC

**New Kits Available:  
 S-40-1 Pressed Steel U/F  
 Stock, LA&SL, OSL, UP**



[westerfieldmodels.com](http://westerfieldmodels.com)

**GOODDEALS DCC**  
[WWW.GOODDEALSDCC.COM](http://WWW.GOODDEALSDCC.COM)



**HOME OF THE  
 PROGRAMMER TEST TRACK SYSTEMS**

DC & DCC COMPATIBLE  
 ALL SCALES AVAILABLE  
 CUSTOM ORDERS  
 DEALER INQUIRIES WELCOME

GARY COHN  
 106 CENTER STREET  
 FOX RIVER GROVE, IL 60021  
[GARY@GOODDEALSDCC.COM](mailto:GARY@GOODDEALSDCC.COM)

**MODEL RAILROAD  
 BenchWork**



Affordable built to order Benchwork  
 starting at only \$20 a Sq Ft.

**NEW! Fusee Pro/M** **LOGIC RAIL™**  
 TECHNOLOGIES

The /M means it's **Mobile!** Track-powered;  
 move it wherever you need it!

"Sophisticated  
 Model Railroad  
 Electronics"

Please visit our website and online store!

21175 Tomball Pkwy Phone: (281)251-5813  
 Suite 287 <http://www.logicrailtech.com>  
 Houston, TX 77070 [info@logicrailtech.com](mailto:info@logicrailtech.com)

**clever**  
 models LLC  
 Cardstock models & materials



Try one today!

[www.clevermodels.net](http://www.clevermodels.net)

PRECISION DESIGN CO

Chains  
 Flat Car loads  
 Joint Bars  
 Signs & Posts



**FREE SHIPPING**





**North Texas Council of Railroad Clubs**  
[dfrtrainshow.com](http://dfrtrainshow.com)

**32nd Annual Dallas Area Train Show**  
**January 21-22, 2017**

Two full days of clinics, home layout tours, art, dealer tables, railroading, door prize drawings, a switching layout plus over 10 modular layouts on display representing, G, O, S, HO and N scales as well as American Flyer, LGB, and Lionel.



Plano Centre, 2000 E. Spring Creek Pkwy., Plano, TX 75074  
 Saturday 10 a.m. to 5 p.m. and Sunday 10 a.m. to 4 p.m.  
 Admission \$8 per person (12 & under free with paid adult), Scouts in uniform FREE  
**FREE PARKING!**

**HO DIESEL SUPPLY**

KATO EMD SD SPECIALIST-REPAIRS-UPGRADES  
 New and Rebuilt Locomotives  
 Powered Chassis-Trucks-Motors  
 Bodies and Parts-Handrails-Electronics

**[www.hodieselsupply.com](http://www.hodieselsupply.com)**  
 email:kato@hodieselsupply.com

**Model Railroad Control Systems**

Geoff Bunza Project Boards  
 DCC Occupancy Detectors  
 CMRInet Compatible Nodes  
 Layout Telephone Systems  
 RFID Switchlist Generator  
 Switch Machines and Drivers

[Click Here](#)

**LIGHTS 4 MODELS**



**BELIEVE!**

ADD SOME HOLIDAY DECOR TO YOUR LAYOUT

NEW PRODUCTS ADDED MONTHLY

LED lights, Animated Signs, & Sounds  
[www.lights4models.com](http://www.lights4models.com) 614-296-8691 [Shop Now](#)

**MOUNTAIN SUBDIVISION HOBBIES**

**[www.modelrrsupply.com](http://www.modelrrsupply.com)**  
 FREE USA SHIPPING OVER \$29.00

NCE - SOUNDTRAXX - DIGITRAX - PECO - CIRCUITRON  
 DCC SPECIALTIES - INTERMOUNTAIN - GMX - ATLAS  
 BAR MILLS - BOWSER - KATO - MRC - TOMAR - RIX -  
 PIKESTUFF - LOGICRAIL - CENTRAL VALLEY AND MORE!

**RULERS-of-the-WORLD**

Scale Rulers \$4 each  
 Over 200+ scales!  
 Metric or Imperial  
[www.rulers-of-the-world.com](http://www.rulers-of-the-world.com)

**Great Decals!**<sup>TM</sup>

FEC, Interstate, Virginian  
 Railway, & L&N Titles  
 After Hours Graphics Line  
 Coupler Gages and More  
 In O, S, HO, and N Scales



**HOBBY MARKETPLACE ads are economical and effective.**

Click [HERE](#) to learn more.

# Simple 3-Step WEATHERING



*A few simple steps can transform a ready-to-run model into a seasoned veteran ...*

• [INDEX](#)

• [TABLE OF CONTENTS](#)



*Follow along,  
step-by-step!*

• [INDEX](#)



[SUBSCRIBE](#)  
(free)

• [TABLE OF CONTENTS](#)

BY **MICHAEL GROSS**  
ALL PHOTOS BY THE AUTHOR



[Click here to rate or comment on this article](#)

**MANY OF TODAY'S TALENTED MODELERS** DEPICT the graffiti-covered and rusted rolling stock of the present, but in the transition era, graffiti was confined to the chalk marks of switchmen and class ones rarely allowed rust and faded paint to obscure slogans like “Mainline of Mid-America,” or “Speedway to America’s Sunshine.”

I model “The Chief Way” in 1954, so much of my weathering is confined to the basics: a flat finish, followed by contrasts and highlights. This article will illustrate several simple ways to weather a ready-to-run post-war boxcar.

**Use our custom  
Google search on the  
MRH website to find  
topics of interest**

[CLICK TO FIND OUT MORE](#)

# 3-STEP WEATHERING | 4

## STEP 1: THE MATTE FINISH

This most basic step eliminates the toy-like shine, protects factory paint and lettering, and prepares the surface for additional weathering effects.



1. The Kadee PS-1 is a common freight car color, perfect for my post-war modeling era, and requires almost no modification.



2. Begin by removing trucks, couplers, and wheelsets, scrubbing with dish soap and a soft toothbrush, and rinsing thoroughly. When dry,

check the model for any remaining impurities, and remove them with 70% isopropyl alcohol and cotton swabs. After washing, handle the model only with thin powder-free gloves.

## 3-STEP WEATHERING | 5

### STEP 1: THE MATTE FINISH *CONTINUED...*



3. I screw truck assemblies into the top of a dowel and use cheap plastic wheelsets to protect the axle openings from paint overspray.



4. Insert the wheelsets in a painting mask to protect the treads, and protect the pointed axle ends from paint with small bits of modeling clay, rubber cement, or artists' frisket.

## 3-STEP WEATHERING | 6

---



5. If couplers can't be removed easily, wrap them in pipe thread sealing tape, which easily adheres to itself yet leaves no sticky residue.



6. I insert lengths of coat hanger wire into the truck mounting holes and attach the body to a short length of 2x4 to facilitate painting. (This is an Intermountain BX-37.)



## 3-STEP WEATHERING | 7

### STEP 1: THE MATTE FINISH *CONTINUED...*



7. This view of the PS-1 components shows the trucks and underframe painted in a suitably grimy color, in this case a 3:1 ratio of Rail Tie Brown to Light Gray, while the wheelsets are painted slightly darker.



8. After airbrushing the roof, sides and ends with a clear flat finish – I used Model Master Acryl – the PS-1 in the foreground displays a duller, more faded finish than the out-of-box model behind it.



### STEP 2: CONTRASTS

Using a darker harmonious shade of the base color, I then add contrasts and shadows. Military modelers often use liquid washes for this effect. I think of “harmonious” colors as colors that are in the same family: warm colors used with other warm colors, cool colors used only with other cool colors. It is not scientific as much as it is subjective: colors that are compatible, that look right and do not call attention to themselves in proximity to another color.



9. Here is an example of a dark wash on a light background color. Notice the shadows around rivets, panels, and other details. Notice as well that the wash is not just black, but is a darker “earth tone” in harmony with the model’s basic color. (Model and weathering by Robert Tecau)

### STEP 2: CONTRASTS *CONTINUED...*



10. In this example of a dark wash on a dark base color, notice again that the wash is not simply black, but has hints of the base color's blues. (Model and weathering by Robert Tecau)



11. A light-colored wash on a dark background is an application that would prove particularly useful for model railroad tank cars. (Model and weathering by Robert Tecau)

## 3-STEP WEATHERING | 10



12. Washes are useful for rail modeling as well. As I prefer the slower drying time of solvent-based paints, I often use artists' oil colors with Turpenoid, an odorless turpentine substitute. Shown here are brushes, a small dish, cotton swabs, rags,

and, for this model, a mix of two darker "harmonious" colors: raw umber and burnt sienna.



13. I apply the wash to the roof, sides and ends, pushing the solution into corners, crevices and along rivet lines. Washes should be thought of as "tinted thinners," with a greater proportion of solvent to color.

### STEP 2: CONTRASTS *CONTINUED...*



14. The degree of contrast and shadow is up to you, so you may allow the oils to set for minutes, hours, or days, before removing the excess with a cotton swab, sponge, or other lint-free tool. (Note: some fast-drying acrylics are difficult if not impossible to remove.)



15. Use vertical strokes, but avoid rubbing too hard and bur-nishing the surface. Wet the swab with additional thinner if necessary, and leave what residue you choose in and around details. Shown is a fine-pointed Tamiya swab, useful around fine details.

## 3-STEP WEATHERING | 12



16. The combination of a flat finish and the contrasting oil wash greatly enhances this ready-to-run model.

### ADVERTISEMENT

# RailPro™

## NEW TECHNOLOGY

DIRECT™ RADIO



# RE RING™

ENGINEERING

## NEW Starter Kit

### \$399.99 MSRP

- Includes Wireless Color Touch Screen Handheld Controller and 56 Watt Power Supply
- Expandable to Virtually any Size Layout

## NEW Locomotive Module

LM-3 & LM-3S



- Direct Radio RF
- Sound and Non-Sound
- New Tiny Size
- 6 Light Outputs

[Click Here to Learn More](#)

For more information visit our Internet site: [www.RingEngineering.com](http://www.RingEngineering.com)

• INDEX



SUBSCRIBE  
(free)

• TABLE OF CONTENTS

### STEP 3: HIGHLIGHTS

Using a lighter harmonious shade of the base color, I next highlight the model to mimic natural sunlight and to “pop out” details.



17. Highlights are traditionally applied using a drybrush technique, but I also use Prismacolor Premiere “soft core” art pencils, which are inexpensive, available online or in art stores, come in a great variety of colors, and require no solvent.



18. Add highlights by dragging the side of your sharpened pencil across raised details while avoiding surrounding areas. Here I use a Prismacolor 30% Warm Gray color, again maintaining harmony with the warm base color of Santa Fe’s “mineral brown.” An Optivisor or other form of magnification is extremely helpful here.

## 3-STEP WEATHERING | 14



19. Rivets, handles, grab irons and tack boards are highlighted with 30% Warm Gray, while the door ribs are highlighted with Prismacolor Henna.



20. The completed car with its matte finish, oil wash contrasts, and pencil highlights.

## 3-STEP WEATHERING | 15

### EXTRAS: Roof, trucks and underframes



21. The roof and running boards are also treated with the matte finish, contrast wash, and highlights.



22. Trucks and wheelsets are given the same three-step process.



## 3-STEP WEATHERING | 16

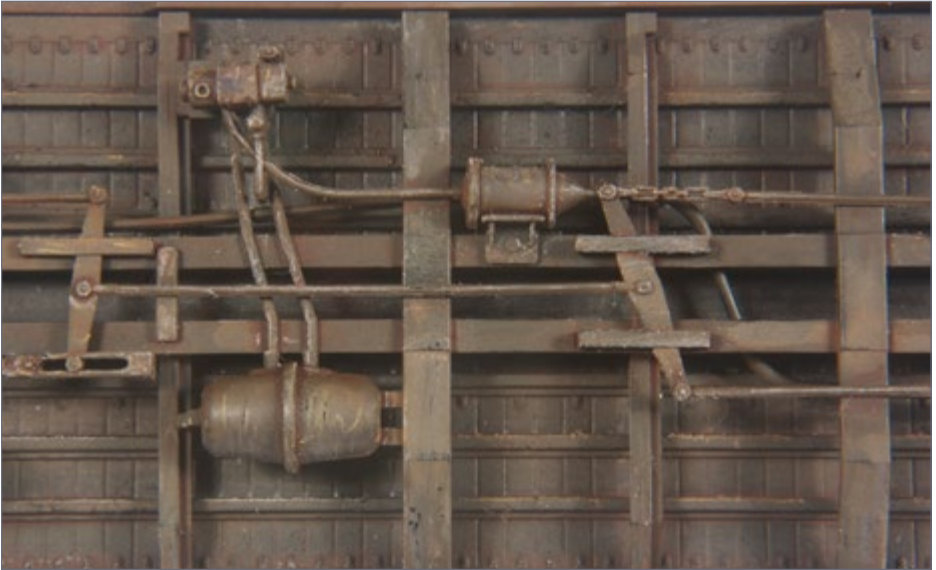

23. The factory underframe is similarly enhanced with a wash and pencil highlights.



24. Extras included PanPastels for side sill and wheel splash dirt, chalk marks, reweigh/repack data, route cards, and a protective coat of flat finish.

## BILL OF MATERIALS #1

- Kadee #4088 40-foot PS-1 boxcar with 6-foot door
- Dish soap
- Old toothbrush
- Distilled water
- 70% isopropyl alcohol
- Cotton swabs
- Powder-free latex gloves
- Masking material
- Painting jigs
- Pipe thread sealing tape
- Airbrush and supplies
- Clear matte finish for car body
- Pigmented matte finish for underframe, trucks and wheelsets
- Artists' oil colors
- Turpenoid
- Brushes
- Rags, and mixing container
- Pencil sharpener
- Short, stiff-bristled brush
- Prismacolor soft core pencils
  - Henna (PC1031)
  - Warm Gray 30% (PC1052)

## 3-STEP WEATHERING | 18

### A slightly different technique

While the airbrush, artist oil washes and pencil highlights have their place, I decided to weather another Kadee PS-1 by substituting aerosol sprays for the airbrush, and using art pencils for *both* contrasts and highlights.



25. The Santa Fe took delivery of 500 Pullman Standard BX-57 boxcars in 1950, four years prior to my modeling era.



[Click here to rate or comment on this article](#)



### 3-STEP WEATHERING | 19

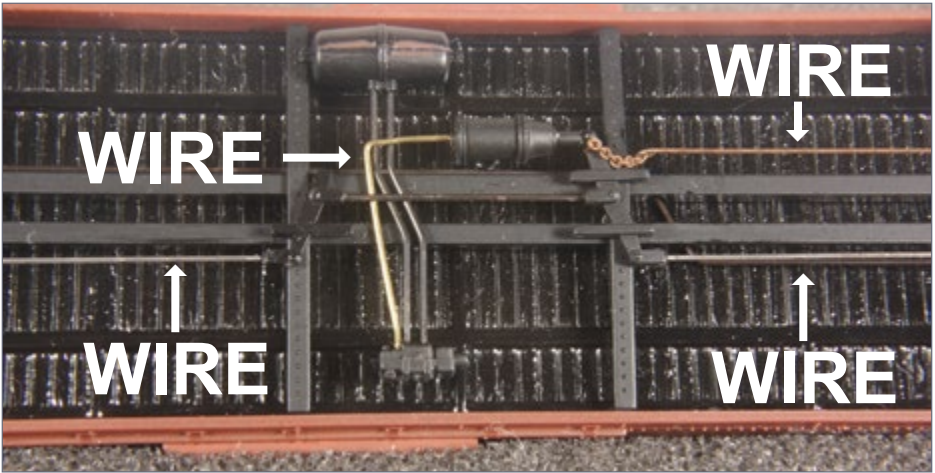

26. This time, before applying the matte finish, I replaced several plastic brake parts with metal wire and chain.



27. As usual, I began with a thorough washing of the car body, trucks and wheelsets, using distilled water for the final rinse to eliminate mineral residue. After air-drying, I mounted the components in painting jigs to apply the matte finishes, and handled the model only with thin, powder-free gloves.

## STEP 1: THE MATTE FINISH

While I typically use an airbrush, this time I used aerosol spray cans.

While aerosol paints can be custom-mixed ([myperfectcolor.com/Custom-Color-Spray-Paint/33865.htm](http://myperfectcolor.com/Custom-Color-Spray-Paint/33865.htm)), they are not that economical. It's easier to purchase the stock cans, which are widely available and can reduce the time associated with the set-up and cleaning of an airbrush.



28. Matte sprays are available from multiple manufacturers. Krylon is a popular brand found in hardware, craft and art supply stores. Modelers may also be familiar with brands like Tamiya, Model Master, Humbrol, and Testors Dullcote. Be sure to read and follow label instructions concerning recoating and drying times.

## STEP 1: THE MATTE FINISH *CONTINUED...*

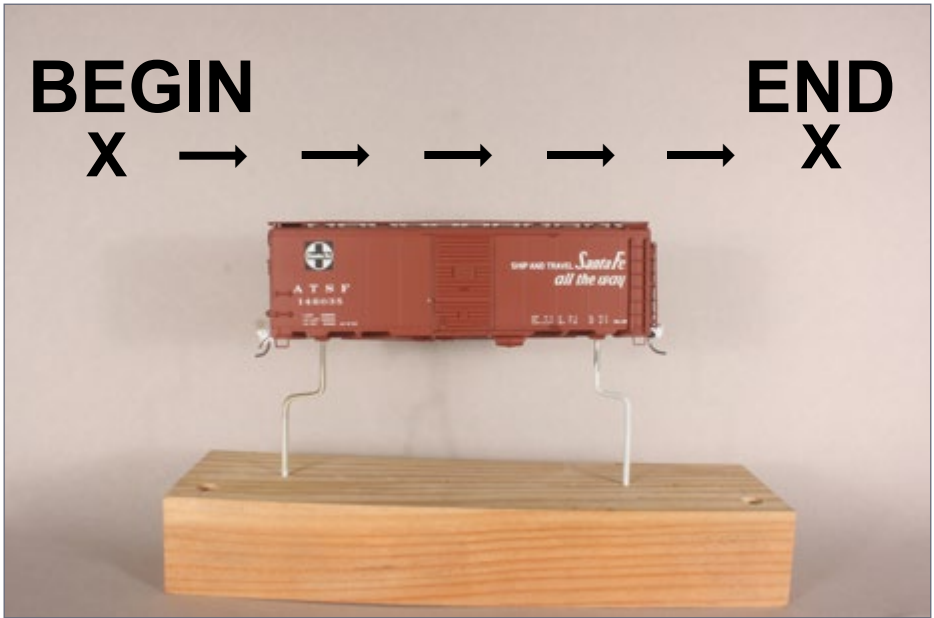

29. As with airbrushing, begin spraying *off* the subject, then move the nozzle across the model from one side to the other. Several light coats are always preferable to a single heavy application, and you may want to practice on an inexpensive swap meet model beforehand.



[Click here to rate or comment on this article](#)

## 3-STEP WEATHERING | 22



30. Tamiya, Model Master and other pigmented flat finishes can be used on trucks, wheelsets and underframes. Krylon flat finishes are sold in home centers and hardware stores, and Rust-Oleum offers six flat “camouflage” colors, two of which

are pictured here. If spraying more than one color, take care to spray compatible types: enamel on enamel, lacquer on lacquer, etc.



31. Following the clear spray to the body and pigmented spray to the trucks and underframe, I allow the finish to cure for a minimum of 24 hours. Notice what a striking difference the modifications to the underbody brake system and removal of the Kadee uncoupling pins make to a ready-to-run car.

### STEP 2-3: CONTRASTS & HIGHLIGHTS

In my first example, I used a wash for contrasts and pencils for highlights. This time, I decided to use Prismacolor “soft core” pencils for both contrasts and highlights, and applied them at the same time.



32. I began with the black roof. Prismacolor pencils feature six shades each of “warm” and “cool” grays and, though black is a cool color, I chose the warmer grays to help harmonize the roof with the warm tones of the car body, a color the Santa Fe called “mineral brown.”

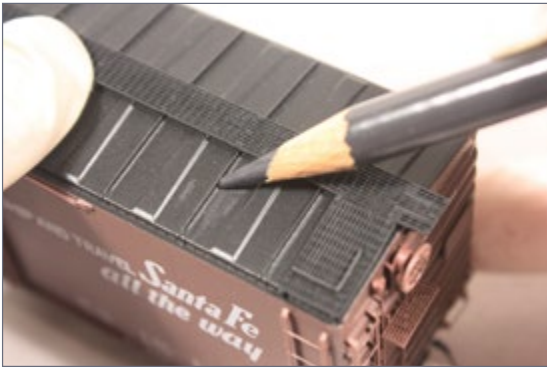

33. I started with a 90% Warm Gray pencil, and even that small percentage provided a welcome change to the stark, monochromatic black of the ready-to-run model. After covering the roof with this color, I followed with random accents of other warm gray hues, blending the colors together with a short, stiff brush.



## 3-STEP WEATHERING | 24

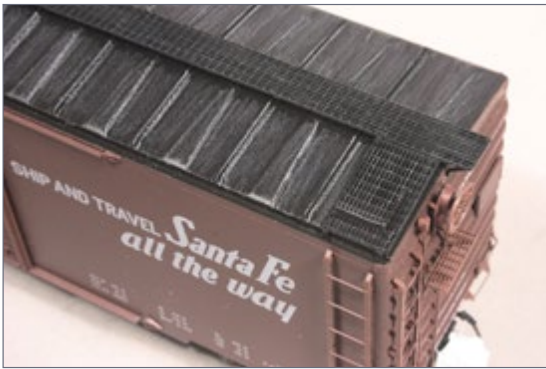

34. Though the finished roof is still unmistakably “black,” the addition of Warm Gray accents adds a great deal of visual interest. Note, as well, a few flecks of gray on the running boards and grab irons.

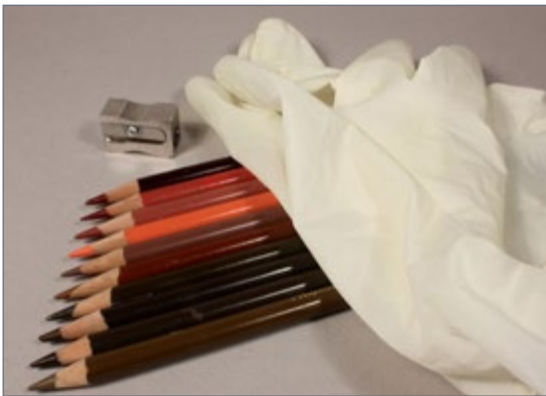

35. Previously, I used Prismacolor’s Henna and 30% Warm Gray to highlight body details. This time I chose a variety of red/brown “earth colors,” beginning with Prismacolor’s Pale Vermillion, the bright orange-hued pencil fourth from the top.



[Click here to rate or comment on this article](#)



## STEP 2-3: CONTRASTS & HIGHLIGHTS *CONTINUED...*



36. To help define individual car panels, I first apply a streak of Pale Vermillion to the right side of the weld lines, followed by a line of PrismaColor's Dark Umber, to the left.



37. Notice I am consistent in keeping my imaginary "sun" above and to the right of the model, with "light" to the right side of the weld line and "shadow" to the left. Notice, as well, the Pale Vermillion applied along the side sills, and the tops of side panels where they meet the roof.

## 3-STEP WEATHERING | 26



38. Having established the weld lines, I add additional Pale Vermillion in decreasing amounts as I move toward the center of the car panels.



39. I then did the same with my Dark UMBER shadows, applying it in decreasing amounts from right to left toward the center of the panels.



40. The next step was to blend the colors directly on the surface of the model with a short, stiff brush, taking care not to burnish the matte finish with too much pressure.

### STEP 2-3: CONTRASTS & HIGHLIGHTS *CONTINUED...*



41. The same process is used on ribs, rivet heads, hardware, ladders and appliances – anything touched by light and shadow: apply Dark Umber for shadows, Pale Vermillion for highlights, and blend with the stiff brush.



42. Tack boards are also defined with the use of color, using lighter hues at the tops of individual planks, and darker colors near the bottom.



[Click here to rate or comment on this article](#)

## 3-STEP WEATHERING | 28



43. Underbody details are also enhanced with darker pencils for shadows, followed by Prismacolor Chestnut, Ochre, and other lighter colors for highlights – always using “earth tones” rather than cooler blacks and whites. A close look reveals I have inadvertently broken the door latch – aargh!



44. Compare this photo to [34] to see the additional flecks of brown I added here and there to help tie the roof to the warmer colors of the sides and ends. It’s barely visible, but adds to the overall harmony of the work.



45. At normal viewing distances, this weathering is fine, but because I enjoy taking photos from an HO scale rail-fan’s point of view, I decided the panel shadowing needed some “toning down.” Applying pastel powders or a mist of highly diluted paint might have helped, but I decided again to use pencils.

### STEP 2-3: CONTRASTS & HIGHLIGHTS *CONTINUED...*



46. I softened the harsh lines by applying Prismacolor Light Umber over the original shadows, then used the stiff-bristled brush to blend the old with the new.



47. The resulting panel lines are subtler than those in Fig. 45. Add chalk marks, repack/reweigh information, and any additional weathering, then protect the work with a final coat of clear flat. (If you have not already guessed, this is the model pictured in the black and white “builder’s photo” at the beginning of this section.)

Simple weathering is fairly basic: a matte finish, contrasts, and highlights. Whatever your tools – the airbrush, the spray can, wet mediums or dry – a little practice can make your weathering as easy as one-two-three!

## BILL OF MATERIALS #2

- Kadee #4061 40' PS-1 Boxcar with 6' door
- Precision Details part no. 250 chain (40 links/inch)
- .012-.015 brass, steel or phosphor bronze wire
- Clear matte finish aerosol paint
- Pigmented matte finish aerosol paint
- Powder-free latex gloves
- Pencil sharpener
- Short, stiff-bristled brush
- Assorted Prismacolor soft core pencils
  - Chestnut (PC1081)
  - Cream (PC914)
  - Dark Umber (PC947)
  - Espresso (PC1099)
  - Light Umber (PC941)
  - Pale Vermillion (PC921)
  - Raspberry (PC1030)
  - Sepia (PC948)
  - Warm Gray 10% (PC1050)
  - Warm Gray 20% (PC1051)
  - Warm Gray 30% (PC1052)
  - Warm Gray 50% (PC1054)
  - Warm Gray 70% (PC1056)
  - Warm Gray 90% (PC1058)



[Click here to rate or comment on this article](#)



### MICHAEL GROSS



Michael can't recall a time when trains were not a part of his life – no surprise, as both his grandfather and great-grandfather were railroaders. His first model train was the windup variety, followed by an electric Marx train set which still operates today. He soon transitioned to Lionel and, about age 14, began moving from tinplate to HO scale in the pursuit of greater realism. Michael was already “weathering” his Lionel rolling stock with talcum powder

to dull the shine, and when he saw the first injection-molded HO boxcar, he never looked back.

Though Michael dreamed of a model railroad “empire,” he opted for modular railroading. His modules are built to Free-mo standards, and replicate an AT&SF Kansas branch line, circa 1954, during the summer wheatrush.

His other interests include photography, meditation, yoga, travel and reading. Years ago he served as the national spokesperson for Operation Lifesaver, and he is currently doing promotional work for the B&O Railroad Museum in Baltimore. His wife is also a railroad fan, and partly to ensure they always have a train to ride, they became part owners in the Santa Fe Southern Railway in Santa Fe, New Mexico.

Michael is an actor, and will soon be in South Africa to film Tremors 6, the fifth sequel to the 1990 film in which he plays iconic monster hunter, “Burt Gummer.” ■

.....



# YOU DON'T HAVE TO BUILD IT...

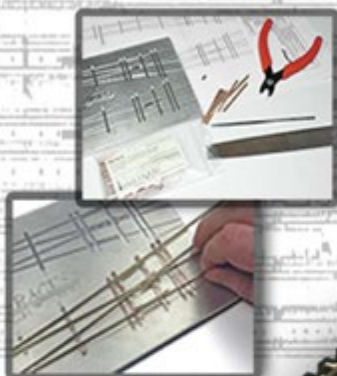

# YOU GET TO BUILD IT!

With track building tools  
and supplies from...



Visit [HANDLAIDTRACK.COM](http://HANDLAIDTRACK.COM) and start today!

• [INDEX](#)



• [SUBSCRIBE](#)  
(free)

• [TABLE OF CONTENTS](#)

# Norfolk and Western Historical Society

**Brand New  
Video!**

**Feature  
length DVD**

**or Blu-Ray.**

**The official  
story of**

**611's 2015**

**restoration**

**to operating condition.**

**How can I add this great disc  
to my collection?**



**Click Here!**



# YES, IT'S A MODEL

*compiled by*  
**DON HANLEY**  
.....



[Click here to rate or comment on this article](#)



1. New York Central RS-1 #9909 is pulling a box car full of gardening equipment from door 4 at Tino Tools, while sitting on the main is an iconic 19000-series caboose still in original condition with tongue-and-groove siding.

All this is taking place on Ray O'Neill's switching layout "59th and Rust." The RS-1 is by Atlas and the caboose is a Trix model. Ray took the photo and posted it first on the MRH forum in a recent "Weekly Photo Fun" thread.

▶ [MRH'S MONTHLY PHOTO ALBUM](#)





2. Here's a work train being assembled on Brian Moore's HO-scale Quisling module (see MRH July 2016). Ex-cab-forward tenders SPMW 4764 and SPMW 4764A (left and middle) were usually kept connected at Roseburg for fire-prevention service during the summer months until withdrawn from MoW duties in 1983. The tender SPMW 4705 nearest to the loco once ran behind an AC-9, and SP used four of these for static fuel storage.

Brian talked to SP tender expert Arnold Menke, who agreed that up to five tenders may well have seen this service. Many of these big tenders initially served behind steam-powered snow-removal rotaries after their assigned locomotives were scrapped.

Tender 4764A was eventually rebuilt to serve as Southern Pacific GS-4 SP 4449's auxiliary water tender, DLMX 4219. The allocated number reflects that it was once the tender of AC-10 cab-forward SP 4219, remaining with the locomotive all its working life.

# YES, IT'S A MODEL | 3



All three of these tenders are modified and repainted Rivarossi models, picked up second-hand. The two clerestory coaches are blue-box Athearn, and modified to be reasonably accurate models of Southern Pacific track gang cars.





3. It's 1984 down under in Australia on a hot summer day while two cars wait for a train to pass. Luke Towan took the photo, and he says, "This scene is loosely modeled from an actual location in Australia with a little bit of modeler's license applied."

Luke says, "People ask me the secret to modeling a realistic scene. The number one factor I tell people is composition: the scene has to be believable, and often this is best achieved by modeling from actual photos."

We heartily agree. Just like you want prototype photos when you're modeling a loco, piece of rolling stock, or a structure, get and use reference photos for modeling scenery as well. It will push your modeling realism up a notch!



## GET PAID FOR YOUR PHOTO

We pay \$40 per photo we publish. If you'd like to get your modeling in our photo feature, just start posting your photos on the MRH website, especially in the Weekly Photo Fun thread created each week.

See [mrhmag.com/help](http://mrhmag.com/help) for more on how to post an image. You need to be an MRH subscriber to post photos to our website, and becoming a subscriber is free, [just fill out this form here.](#) ■





# *Modeling the* **SPSF MEADOW SUBDIVISION**

BY ERIC MILLER

## *Proto-freelancing brings post-merger railroading to Nebraska ...*

**WHEN I STARTED OUT IN MODEL RAILROADING** in the mid-1990s, I saw an advertisement for Athearn that featured a photo of three bright red cabooses in an interesting scheme I hadn't seen before.

The ad read, "Our Kodachrome cabooses painted red and yellow for the failed SP-SF merger in the late '80s lives on in bay windows, wide





Click here to rate or  
comment on this article

vision and SF cupola incarnations.” I was intrigued and ordered the set from my local hobby shop. The paperwork inside the box gave more information on the merger the ICC rejected in 1986.

I thought it was a great idea for a real railroad and decided at that moment that someday I would build a model railroad layout based on the SPSF as if the merger was approved and the railroad actually existed. I was still early in the model railroad hobby and could barely apply decals to cars and locomotives, much less custom-paint them. I put this idea away in my pocket for later down the railroad.

In the meantime, I enjoyed seeing the few Kodachromes that still existed in that time, mainly old Southern Pacific motors plying the Union Pacific rails near where I lived. I even caught a couple on camera – old C30-7s the Santa Fe retired, the BN leased, and were briefly on the BNSF roster.

Then came 2004, when I moved to Denver for graduate school. I met Matt Faruolo, now a good friend, who taught me how to paint locomotives and freight cars using an airbrush. Matt was embarking on a concept to model a modern New York Central, and I was determined to start my SPSF fantasy. It has been invaluable having someone like Matt to push and challenge me in the SPSF direction.

## The layout

About seven years ago, my wife and I purchased our first home. It was agreed that I could have a significant portion of the



## SPSF MEADOW SUBDIVISION | 3

basement real estate as long as my trains stayed down there. We found a house that had a decent-size basement with the stairs dropping in the center, the furnace and water heater tucked away in a corner, carpet tiles already laid out, and only one window well along the wall to contend with.

My friend Don Meeker agreed to design a track plan for me. At this time, I was leaning toward a modern Rock Island that would complement the fantasy SPSF, with the plan that the two would eventually merge. So the track plan was based on a segment of the Rock Island southwest of Omaha, on the mainline to Denver.

Before we even looked for houses, I listed my design standards, including layout design elements for each of my towns and major industries, and my givens and druthers. Don took this information and drew out an elaborate plan that was probably a little bigger than my dreams. He suggested that I build a double-deck layout with one section as a mushroom.

It looked very inspirational. I had just finished reading Tony Koester's book *Designing and Building Multi-Deck Model Railroads*, so that whetted my appetite for a double-deck layout. However, reading that book also made me realize there would

1-2. (Right top and bottom) Passenger service on the Meadow Sub is represented by an intercity Amtrak train that runs between Omaha and St. Louis (via Kansas City) with a stop at the Bellevue Station. This is another element that adds credibility to the fantasy SPSF concept by presenting a real railroad. I model actual Amtrak Midwest intercity equipment for the Missouri River Eagle, B32-8WH 505 and a mix of Horizon and Amfleet passenger cars. Amtrak rail passenger service between Omaha and Kansas City has never existed, although it was studied in the 1980s.

# SPSF MEADOW SUBDIVISION | 4



# SPSF MEADOW SUBDIVISION | 5

# SPSF<sup>®</sup> RAILWAY

## Meadow Subdivision

### Layout at a Glance

**Scale:** HO (1:87)  
**Size:** 34'X30' with crew lounge & workshop  
**Theme:** Proto-lanced branchline  
**Prototype:** SPSF Railway (ex-Rock Island)  
**Locale:** Eastern Nebraska  
**Era:** 1998  
**Style:** Linear walk-around  
**Mainline run:** 240 feet  
**Minimum radius:** 18" industries,  
30" mainline  
**Minimum turnouts:** #4 industries,  
#6 mainline  
**Maximum Grade:** 4%  
**Benchwork:** "Meeker" L-Girder  
**Layout Surface:** ½" OSB  
**Height:** 44" – 56"  
**Roadbed:** Cork  
**Track:** Code 70, 83, & 100  
**Backdrop:** Luan plywood  
and concrete walls  
**Control:** Wireless DCC  
**Car forwarding:** JMRI Ops  
Work Orders and  
Track Warrants

HO Scale (1:87.1)  
Scale of plan: 1/3" = 1'-0", 24" grid  
Plan by Eric Miller 4-19-2016

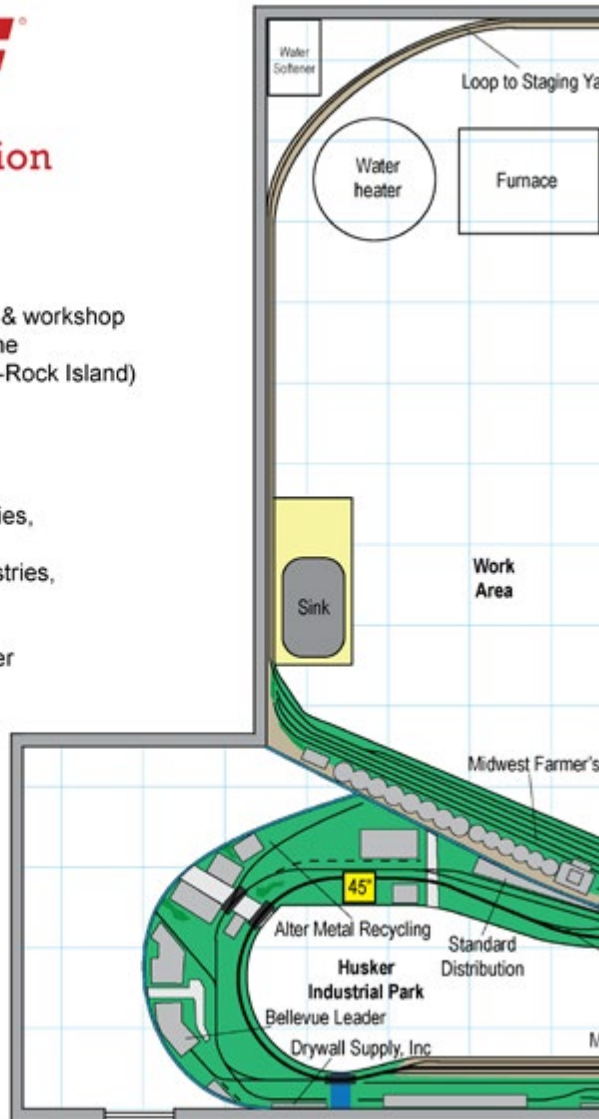

# SPSF MEADOW SUBDIVISION | 6

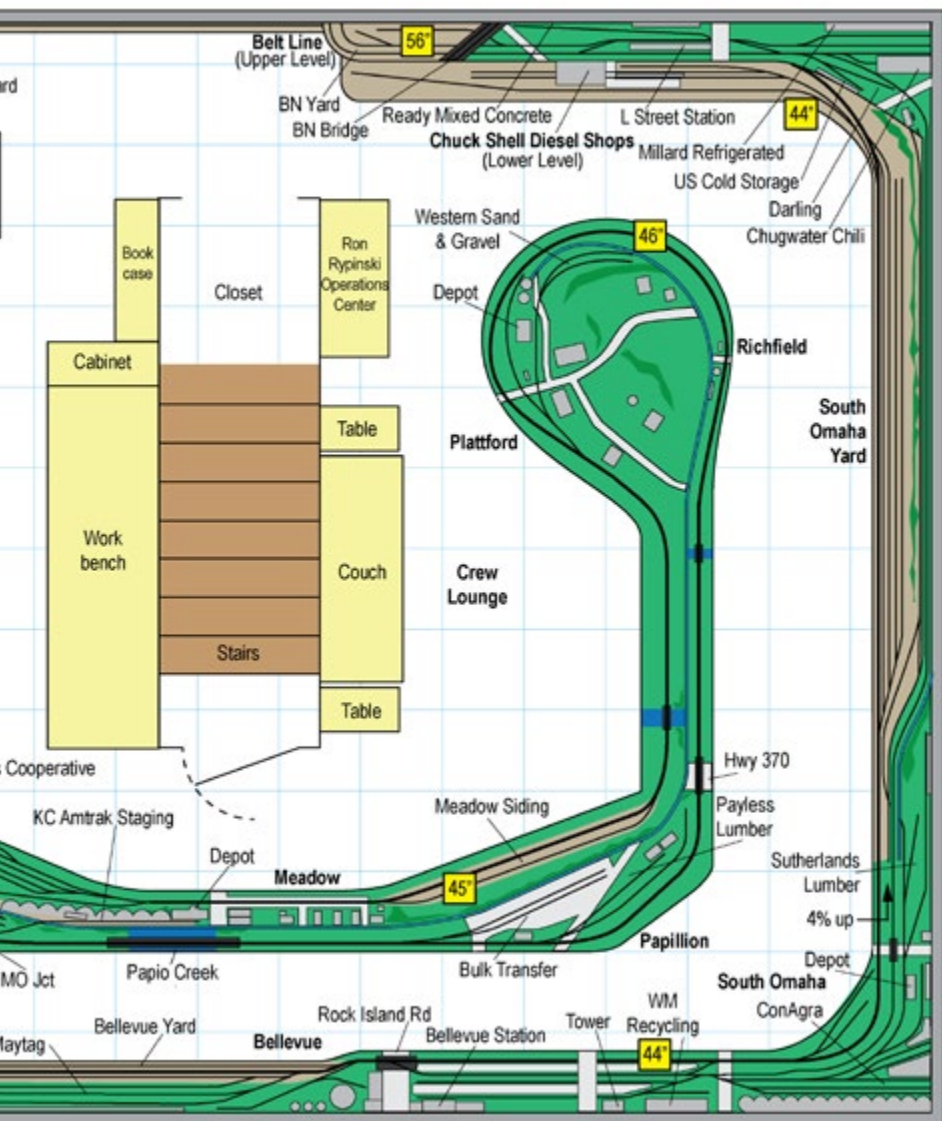

## SPSF MEADOW SUBDIVISION | 7

be an additional time and financial commitment, plus I would have to figure out a plan for lighting the lower level and needed to decide on two layout heights that would work for most operators. As much as I liked Don's double deck layout plan, I decided to simplify it to meet my personal goals.

The result is that I went with Don's overall plan, which had the layout running east on the left and west on the right. I also used the general design of how the benchwork would be arranged. And I put the yard and diesel shop in the place as per his plan.



3. I kitbashed a fantasy B18-7 (a locomotive that was included in the GE Dash 7 catalog but never built) using an InterMountain U18B drive and chassis, and a shortened Atlas B30-7 shell. I later decided to sell this unit and focus on only prototype locomotives for my layout to make the SPSF concept more real. This photo was taken on "Back to the Future Day," October 21, 2015 and posted on the SPSF Railway facebook page.



4. The Meadow Siding is largely used for runaround moves to serve industries in the Meadow and Plattford area on the west end of the layout. Here we have the Meadow Turn shuffling open hoppers loaded with limestone at Western Sand & Gravel. These are Bowser hoppers, and are a mix of predecessor roads like Southern Pacific and Santa Fe, plus some rebadged BNSF hoppers for the modern SPSF look.



[Click here to rate or comment on this article](#)



# SPSF MEADOW SUBDIVISION | 9





# SPSF MEADOW SUBDIVISION | 10



5-7. The SPSF built a new diesel shop and yard office in South Omaha in 1998 after purchasing the Meadow Sub branch, called the Chuck Shell South Omaha Diesel Shops, named after a good friend who helped me with many electrical aspects of the layout. I initially started out with a large diesel yard but later reduced the size when it was apparent I didn't need a fleet of 70-plus locomotives. The trade-off is that I can model a nice facility and have it be part of the layout instead of staging, as I had initially planned.



# SPSF MEADOW SUBDIVISION | 11

My goal with layout construction hinged on my family plans: having kids within a few years. And I wanted to get the hard work of building the layout done before we had any kids so I would have fewer time commitments after that. Going with a single-deck layout really helped save time.

I started construction on the layout benchwork about six months after buying the house, with the help of fellow modelers who met every Tuesday night at other houses. My goal was to drive the final spike before my birthday that summer, which I beat by a week.



8. The south end of the Belt Line area replicates real industries that exist in South Omaha on the South Omaha Terminal: Darling International (rendering plant) and two cold-storage facilities, Millard Refrigerated and US Cold Storage. Additionally, I included a customer for my friend's Chugwater Chili, which is the only fantasy industry on the layout.

Building benchwork and laying track took approximately three months. I had the DCC system up and running as I laid track so I could check sections to make sure they operated well. My benchwork is made of strong and cheap 2x4s, and I have a half-inch OSB (oriented strand board) surface. Most of the layout is level, except for four areas of one percent grade. I added an extension above the diesel shops in 2014 reached by a four percent climb.

I started hosting operating sessions the next year. The sessions helped me figure out my operations and make any changes to the track before really getting into scenery and structures. A year after that, things changed. I started thinking my concept was too complex, and really wanted to settle on the SPSF. Eventually, I did away with the modern Rock Island idea altogether. This diversion cost me a few years of modeling time.

### The distraction

We modelers are met with distractions every step of the way, and the key to a successful layout is focusing on what really matters. We are really fortunate that a lot of models in different eras and a variety of paint schemes are now available, but that makes things harder when it comes time to decide what to model.

This is especially difficult for freelance or proto-freelance modelers, who don't have a specific prototype to follow and have room for creativity. The lesson learned here is to create a concept that is believable, and that modelers don't have to buy into too much.

My good friend Joe Atkinson helped me out with this one, especially as I narrowed my focus and paraphrased Tony Koester's advice: "the less you have to explain about a proto-freelance prototype, the more plausible it will be."

Before I go further into my concept, I will explain one of my biggest mistakes of the layout – what I call my big distraction. Right



# SPSF MEADOW SUBDIVISION | 13



## SPSF MEADOW SUBDIVISION | 14



9. (All left, and above) Part of developing a fantasy concept is having a solid paint scheme in place that is both believable and easy to replicate. For the modern SPSF, I simply reuse BNSF freight cars and rebadge them with decals I designed and are printed by Highball Graphics. They currently offer three of my sets as part of their freelance series. I also developed a history for the SPSF freight car paint scheme that bridges my modern concept with the red and yellow cars Roundhouse produced in the 1980s – the SPSF started out with a “celebration” paint scheme that didn’t last much beyond the merger and transitioned into my modern scheme.

before launching into my layout, I switched gears and started modeling a modern Rock Island.

This is a really cool idea but I had a hard time deciding on a paint scheme and system for the railroad – how it would still exist in today’s world. This is one the most important things when modeling a freelance railroad – coming up with a plausible reason for existence so that other model railroaders understand what you are doing.

I worked on the modern Rock concept for about four years, but I was still enamored with the SPSF, and soon came up with the idea of moving my layout era from 1995 to 1998 and modeling the SPSF as if it just merged with the Rock Island. Eventually I simplified things further and just focused on the SPSF. However,



the Rock Island diversion absorbed a lot of effort I could have funneled into the SPSF concept if I had settled on that earlier.

So I spent some time reworking areas of the layout to enhance operations, which is an essential part of any new layout for me. If I had narrowed down my concept earlier, I could have incorporated that into the initial design. The layout started out as Rock Island mainline between Omaha and Denver and transitioned into a branch line southwest of Omaha.

### The layout concept

The greatest inspiration for my layout is the BN Bayard Subdivision track plan that was in the May 1993 *Model Railroader*. The BN was the closest railroad to my house growing up, and the Bayard Sub was really close to home. What I liked about this concept is that a Class I railroad went bankrupt and another, stronger, Class I railroad took over part of the old main and turned it into a profitable branch.

When I decided to change my layout into a branch line, I used the *MR* track plan as the basis for my layout, and when making a decision about operations or serving customers, I would consult this prototype for an answer. That made it more real. It was another lesson learned, that if you have a freelance railroad, it is really helpful to use a prototype railroad as a guide. It can solve a lot of problems and answer questions that will simplify the concept as you work along.

Any fantasy model railroad needs a great backstory and I enjoy writing fiction, so I put my new concept into a “narrative history.” I included all my thoughts so other modelers could better understand what I am doing. This document is available on my website at [spsfrailway.com](http://spsfrailway.com).

# SPSF MEADOW SUBDIVISION | 16



10. One of the largest industries on the SPSF Meadow Sub is Meadow Co-op, located on the west end of the branchline. This is served by unit grain shuttles that run between South Omaha and Meadow. The cars are blocked at South Omaha to forward to other railroads or to go to Kansas City to be sent across the SPSF system. You can usually see modern six-axle units and covered hoppers on "The Rocket," the unit grain train.



## SPSF MEADOW SUBDIVISION | 17

The struggle with changing to the SPSF but staying in Nebraska is figuring out how the SPSF got that far north. It's not too much of a stretch because the Santa Fe did have a spur into Superior NE, an agricultural hub not unlike my town of Meadow. I read books on the area and consulted with other local folks to get a better idea of its history after the Rock Island went bankrupt in 1980 and abandoned the track. I decided that my branch line would have a similar history to the BN Bayard Sub: a group of shippers bought the track and leased it to a railroad to operate. But how to get the SPSF to the line?

In 1982, with the Union Pacific-Missouri Pacific merger, the Missouri-Kansas-Texas railroad received trackage rights from Kansas City to Omaha/Council Bluffs and Lincoln. I simply altered history so that the Santa Fe received these trackage rights instead. The incentive was the ability to operate the branch line. The Santa Fe also bought the local switching railroad South Omaha Terminal (which really did change ownership in this era), and thus had a major presence in South Omaha.

That was an easy way to get the SPSF into Omaha without having to introduce a complicated story. As an aside, when the MKT merged into the UP in 1989, the ICC directed the UP to choose among KCS, Southern Pacific, and Santa Fe for continuing trackage rights into Omaha. They selected KCS, but the story shows how close Santa Fe came to getting trackage rights to Omaha on the UP.

11-12. (Right top and bottom) A major industry on the Meadow Sub is lumber, and there are two lumber yards. Here is the Payless Cashways facility, located on the edge of the Omaha metro area, and poised to assist with building new communities in the suburbs. Payless was a real company in this part of town, and I created custom decals for their own trucks.



# SPSF MEADOW SUBDIVISION | 18



• [INDEX](#)



[SUBSCRIBE](#)  
(free)

• [TABLE OF CONTENTS](#)

## Focusing on the SPSF

Coming back to my big lesson about focus, I further narrowed my concept in the last year as I prepared to revive operating sessions after I finished track reworking projects.

I have to drop some of the excess weight and focus on what is really important in order to save time and get things up and running. For me, that means modeling the SPSF, which brings me back full circle. As that focus developed, I was really taking off, headed for operating sessions and working on projects that really mattered to me.

Once that concept came together, I was able to set aside projects (like freight cars and locomotives) that didn't matter, and focus on the work that got me to my SPSF layout goal. In the last year, I've slimmed my freight car fleet from over 800 cars to 275. My locomotive fleet shrank from over 70 to the current roster of 14, all with sound.

One piece of advice Joe Atkinson gave me, which I took to heart, is to only have one fantasy thing in my railroad – visitors only have to buy into that, and it makes everything else easy to understand.

13-14. (Right top and bottom) Another real railroad on the Meadow Sub is the Iowa Interstate, which had a transfer to Omaha in my era, and the locomotive that was used really was RS36 no. 900. This is a good opportunity to include a regional railroad, a connection to the old Rock Island to the east, and some Alco sound. The transfer usually brings steel for Maytag, and will haul some scrap from Alter Metal Recycling for a steel mill on the IAIS mainline in Iowa. I had a very hard time finding an IAIS RS36 factory-painted by Atlas, so I built my own using a chopped C424 chassis, RS11 drive I had on hand, and an Atlas Trainman RS36 shell. Then I painted and decaled the locomotive myself.

# SPSF MEADOW SUBDIVISION | 20



Thus, my one fantasy concept became the SP-SF merger, which is close to reality and fairly easy for most people to get. Every publication from 1983 to 1987 made it seem a given that the merger would happen, especially after the Justice Department approved it in 1985. When the ICC turned it down in 1986, it was a complete shock. I surrounded my fictional SPSF layout with real, tangible railroads like the Union Pacific, Amtrak and Iowa Interstate.

### Locomotive paint

Modeling something like the SPSF gives you a railroad system, as well as a diesel and freight car roster. The trick is that I model it 12 years after the merger was completed, so I have to assume certain things that happened after the merger to make the railroad a little more modern. I'll discuss the three major factors: locomotive roster and numbering scheme, system map, and operating philosophy.

The planned SPSF had a locomotive renumbering plan and paint scheme in place, so that was easy. However, a lot of new locomotives were introduced and purchased by Class I railroads in the late 1980s and early 1990s. For this, I simply used what the Southern Pacific and Santa Fe really purchased, such as SD70s, SD75s, C40-8Ws, and C44-9Ws. The SP and the SF actually bought many of the same models, like GP60s and C44-9Ws. I had to

15-16. (Right top and bottom) Warehouse and distribution industries offer a way to include regular 50-foot boxcars on the layout, and I have boxcars that are of SPSF lineage to serve Standard Distribution on the Meadow Sub. This facility loads two tracks by bridging across the first row of boxcars, which is typical for urban industries tight on space.

# SPSF MEADOW SUBDIVISION | 22



# SPSF MEADOW SUBDIVISION | 23



## SPSF MEADOW SUBDIVISION | 24



17. (Left top-bottom, right top and bottom) The Meadow Turn is the primary local job for the Meadow Sub, and is powered by a B23-7 and GP39-2, very common local power on the Santa Fe in this era. The GE-EMD combo offers two very different prime mover sounds and makes the job even more fun to work. One of my motive power techniques is to use dummies along with powered units, since one locomotive is plenty of power for my short trains on relatively small grades. In this case, the B23-7 is powered while the GP39-2 is a gutted dummy, but with DCC and sound. This also makes speed-matching a non-issue, and operations are not negatively affected.

## SPSF MEADOW SUBDIVISION | 25

adjust the numbering system because the proposed renumbering introduced in late 1985 didn't leave much room for expansion.

The Santa Fe numbered its GE locomotives in higher numbers, and this was proposed for the SPSF as well. My solution was to find slots for all the GEs within the EMD numbers and combine them, especially as GE was the dominant locomotive builder right as the SPSF merger activity was happening. This left about 2,500 numbers for new high-horsepower locomotives, and leaves me with a nice numbering plan that makes sense. The lower-horsepower and four-axle locomotives have the lower numbers, and the higher-horsepower and six-axle locomotives have the higher numbers.



18. The crew lounge.





19. The dispatcher desk, which is named in honor of my friend and mentor Ron Rypinski, who modeled the fictional Western Railway. This is before I converted my DCC system to NCE.

A major change after the SPSF merger was the advent of wide-nose locomotives and their effect on paint schemes. For my SPSF, I keep the red-yellow Kodachrome scheme that is immediately recognizable to any visitor.

I also wanted to simplify it a little, similar to the way BNSF modified their paint scheme. My first design change decreased the size of the logo on the hood and added "Railway" to it. I applied this logo to the nose of the locomotive and got rid of the cigar band, which I never liked on wide-noses such as the FP45. Finally, I changed the road number typeface on the cab from Railroad Roman to modern Arial, again matching BNSF practice.

## System map

A major consideration in creating my SPSF system map is that during the 1980s, the Class I railroads spun off a lot of lightly-used lines to short lines and regionals. Also, I had to consider the 1987 appeal to the ICC and proposals to shed some trackage to the Rio Grande and UP. I created a mainline rationalization program for the SPSF based on what the SP and SF (or UP and BNSF) actually spun off, and the result was a much cleaner system map. I added branch line and trackage rights to Omaha on the map, plus the KCS strategic alliance, as well as some trackage and haulage rights that could have come from other railroad mergers.



20. Looking at the diesel shop with the Belt Line above.



21. Looking toward South Omaha with the yard on the left and Richfield on the right.

Reading up on the SPSF merger plans told me things were leaning toward using Santa Fe practices for most things, so I also leaned on the Santa Fe (and subsequently the BNSF) when making decisions about operating practices and philosophy.

Whenever I have a question about what a freight car should look like, the numbering scheme for freight cars, what the track should look like, what signs should look like, what the timetable should be, and so on, I use the Santa Fe or BNSF as a guide. This saves me a lot of time from having to make stuff up on my own, and makes the SPSF look more credible as a result.

## SPSF MEADOW SUBDIVISION | 29

Creating this identity can be tricky because the goal is to make something unique that is also realistic. The goal is to have a concept that other modelers (or even visitors who don't know much about trains) can easily grasp and identify with.

As an additional caveat, I resisted the temptation to play out the histories of other railroads. Many times I'm asked questions like, "what happened to the Rio Grande in your world?" The answer is that I don't really care, as it doesn't pertain to my layout – they could remain independent or they could get merged into the UP – either way, it ultimately doesn't matter to me. This also allows me to include some other fantasy railroads from friends, as long



22. Looking back toward the diesel shop with the yard on the right and Richfield on the left.



**23. Husker Industrial Park is at the aisle's end, with Bellevue on the left and Papillion on the right.**

as they don't overtake too much of the layout. The only railroad that I intentionally exclude from the layout is the BNSF, as well as UP equipment lettered for SP or SSW, for obvious reasons.

The SPSF Meadow Sub is set in a major railroad city like Omaha, so there are other railroads nearby, and I decided to include them on the layout. These real railroads lend credibility to my concept and give visitors a sense of place.

Union Pacific is probably the first railroad people think of when they hear Omaha, so I want that railroad to have a decent presence on the Meadow Sub. The fact that the SPSF has track-age rights on the UP, and the line was the Rock Island's access through Omaha, heightened the need for a UP presence.

## SPSF MEADOW SUBDIVISION | 31

Union Pacific accesses the Meadow Sub via the real CRI&P Junction, and interchanges with the SPSF at the Bellevue Yard. UP also has trackage rights on the Meadow Sub through the Chicago Great Western from the meatpacking days, and serves part of the ConAgra flour mill.

The Iowa Interstate connection with the SPSF at South Omaha Yard adds to the Rock Island history, and is based on a transfer that the IAIS used to run into Omaha during my era. Burlington Northern plays a small role as an interchange partner in South Omaha, up on the Belt Line extension. Finally, Amtrak makes an appearance with its Missouri River Eagle, an intercity train



24. The long aisle toward South Omaha with Bellevue on the right and Papillion on the left.



## 25. Looking toward Meadow with Plattford on the left.

that runs between Omaha and Kansas City with a stop at the Bellevue Station.

## Operating the Meadow Sub

Now that I have figured out the other railroads that my SPSF works with, my operating scenario is much more refined. An operating session proved that some things worked well, but also showed where there is room for improvement. Since that session, I have adjusted my crew positions, changed the track arrangement in South Omaha Yard slightly, and implemented JMRI Operations for my work orders. I can't wait for my next operating session to test these new things!

## SPSF MEADOW SUBDIVISION | 33

Before I hold an operating session, I email the operators a link to my website, where they can download several PDF documents. The most important is a welcome letter that gives a background on the layout, a summary of the jobs, and a track plan. I also have documents that cover all my positions, tell how to operate my DCC and use the throttles, and examples of my track warrant and work order. When I attend a layout for the first time, this is the sort of information I look for, so I know what to expect and which job(s) I want to try to get.

I use about 30 minutes before the official session begins to answer any questions from the crew, go through safety items, mention anything new I am trying, and go through the position



26. This is the end of the branchline with Meadow on the left.





27. This is BulkWest, the bulk transfer facility on the Meadow Sub that serves both liquid and dry bulk. Dry bulk trailers and equipment are hard to find, and these two trailers and the dry bulk transfer auger are all 3D-printed models I bought from Shapeways by baztrains: [shapeways.com/designer/baztrains](https://shapeways.com/designer/baztrains).

signup. My layout requires three to six people – fewer than most layouts in my area. Operators pick cards at random to decide seniority order. These are custom cards I made and laminated, based on a set of SPSF playing cards I found.

The SPSF Meadow Sub operates with three crews: the road crew, the local crew, and the switcher crew. Each of these can be operated with one or two people, although the local really needs two people.

## SPSF MEADOW SUBDIVISION | 35

The road crew has a variety of work during the operating session, and will run the unit grain shuttle from South Omaha to Meadow and back, the IAIS transfer at South Omaha, and the UP transfer to Bellevue. The local crew serves all the customers between Bellevue and Meadow. The switcher crew works at South Omaha Yard, including some classification of cars, and switches the nearby industries in South Omaha. I serve as the dispatcher and industry foreman, and run the Amtrak train – this train could also be run by the road crew, depending on how the day goes.



28. The South Omaha Yard and nearby industries are served by an ex-SP MP15AC, continuing the idea to have easily-identifiable locomotives for the SPSF fantasy roster. This Athearn Genesis locomotive has a SoundTraxx Econami decoder and a CurrentKeeper for reliable operation.

My sessions take four hours to complete an eight-hour work day using a 2:1 fast clock. Track authority is given by track warrant control (TWC), since the branch line is dark territory and the only signal controls the switch at MO Junction for Amtrak to enter and exit the subdivision. Car forwarding is done by switch lists that I call work orders. These are created by JMRI Operations and contain other information such as the locomotive consist and other special instructions for the crew that day. Most industries have blue flags, and the crew needs to check with the industry foreman before removing them and accessing spurs. A caboose is required on the Meadow Turn local, but other trains use an end of train (EOT) device.

### Conclusion

With the Meadow Subdivision, I am able to accomplish my goal of modeling the what-if SPSF Railway, and show how this proposed Class I would look in more modern times. That idea, and the quaintness of a branch line with lots of industrial switching, sets me apart from many other model railroad layouts.

I continue to plan “the next layout” and keep coming back to my Meadow Subdivision. I really like the balance of urban industry with a little rural running because I can run a variety of large and small, old and modern locomotives.

If I were to start over, I would strive to make the track plan even simpler, and take out some of the confusing turnouts and spurs that were in my original plan. I would also consider having no grades at all, even though it is very realistic and fun to see locomotives struggle up a hill in some areas. The grades create a level of complexity that is not really needed for my simple layout.

As far as the size, sometimes I think I have too large a layout, and that a slightly smaller version would be easier to maintain in







29. (Left: top to bottom, and right, top and bottom) When most railfans and modelers think of Omaha, Union Pacific will usually be the railroad that comes to mind first, so I wanted to make sure to include some UP operations. This helps legitimize the concept, and helps visitors orient themselves. It was easy to do for the Meadow Sub, since the UP mainline is nearby, and the Rock Island accessed Omaha via the UP. I have a UP transfer job that enters Bellevue and also serves the ConAgra flour mill on trackage rights. Motive power is represented by UP 2263, ex-Rock Island 4325, which is an Athearn RTR locomotive I repowered with a Kato drive and trucks. I also have two other locomotives I use for the second unit: CNW 4402, an Athearn Genesis GP15-1, and UP 1025, an Athearn SW1500 I painted.

the long run. I like smaller layouts because I can really focus on specific things and create more detail.

One last note about modeling and keeping up a fantasy concept with a busy life: I feel it is important to think of it as a relentless pursuit and to never stop working.

“No days off” is my motto, and my goal is to work on the layout or a project every day, even if it is just five to 10 minutes. That little bit of time really pays off over the long run.

I have a full-time job and a family with two kids, so modeling time can be scarce. However, I can usually get in a few minutes after the kids go to bed to continue a project like building kits or working on structures a little bit at a time. Keep the workbench open for those kind of projects and then take advantage of working on larger projects when bigger chunks of time present themselves. You’ll be surprised at the progress you can make.

In the future, I will add more scenery and structures. I am nearly finished with my locomotive and freight car fleet. I am interested in getting into lighting structures, as I want to add some nighttime operation to my sessions. In addition to eight-foot fluorescent tubes to light the layout, a rope light serves as moonlight for a nighttime session, giving enough light to locate cars and not trip over anything. I can see this layout easily lasting another 10-15 years, and perhaps then I will be ready for the next version of the SPSF Meadow Subdivision.



**Click here to rate or  
comment on this article**

**WIN**  
**\$250**

*New  
Subscriber  
Sweepstakes*



Drawing on  
February 1, 2017

*from MRH*

Become a new MRH  
subscriber in January, and  
get entered into a drawing  
for \$250 cash!

**SUBSCRIBE NOW >>**

*Subscribing is FREE!*



## ERIC MILLER



Eric got into model railroading with a Bachmann HO scale Santa Fe train set just before high school. He started working on a prototype-freelanced concept after that and never looked back.

Following a brief hiatus from modeling during college, Eric started developing the Meadow Sub about 10 years ago with construction starting in 2010 thanks to help from the local Tuesday Night Conspiracy modelers.

Eric lives in the Denver, CO area with his wife Heather and two daughters, Lindsay (4) and Courtney (1). He works at the Regional Transportation District, and does the rail service planning and scheduling for the light rail and commuter rail lines, of which four new lines are opening or have opened this year.



Eric also has a great YouTube channel, make sure you check it out:

[youtube.com/user/emillerz/videos?shelf\\_id=4](https://youtube.com/user/emillerz/videos?shelf_id=4)



**Click here to rate or comment on this article**



# In-depth model railroading how-tos on TrainMasters TV!



- Super-detailing
- Expert tools and tips
- Weathering
- Layout design secrets
- Layout construction
- Realistic scenery tricks
- DCC decoder installs
- Operation insights
- Layout tours
- And much, much more!



Take your hobby to a new  
level with TMTV >>



• [INDEX](#)



SUBSCRIBE  
(free)

• [TABLE OF CONTENTS](#)

# DIGITAL BACKGROUND PAINTING

## *for Model Photography*

BY PETER VASSALLO

## *Spice up your layout photos ...*

**MODEL PHOTOGRAPHY CAN BE AN ARTISTIC** extension of the physical modeling you've done on your layout. Nowadays, even the cheapest digital cameras (as well as smart phones and tablets) can produce nice photos of your model railroad. Image-editing software like Photoshop allows you to enhance your layout photos to present your modeling with even more realism.

• [INDEX](#)

• [TABLE OF CONTENTS](#)



Click here to rate or  
comment on this article

One such enhancement is “painting” a background into your photo. This can be done easily, looks reasonably natural, and yields a nicer overall picture. I will demonstrate the basic techniques using an example photo taken on my home HOn3 layout.

## Step One

First, you need a layout scene to photograph. As seen in [1], I scratchbuilt a mine to fit onto an existing mountainside at one corner of my layout, and placed a short length of track on the ledge below, with ore cars positioned for loading.

I made sure the layout’s lighting was sufficient for this shot, with a look approximating mid-afternoon sunlight. I took the shot with an inexpensive Canon S110 camera, ending up with the JPEG digital image shown. I like the composition, but of course those closet doors in the background leave much to be desired.

I could have painted and installed a real backdrop. I plan to do that in the future – but for now I opted for an alternative approach to see how the scene might look with a sky in place of the door.

## Step Two

The software I used was iPhoto Express, but similar results should be achievable with other packages as well, such as Photoshop Elements.

I filled the background with a sky blue (gray could also be used, depending on the type of sky you want). I wanted a brighter kind of shot, so I chose blue in this case. Painting the sky blue



## DIGITAL BACKGROUND | 3

may sound easy, but it can be tricky to get the right shade of blue. I finally arrived at an acceptable color by entering RGB (red, green, blue) values directly into the software, and experimenting with different values.

[3] shows examples of different shades of blue, from pure blue to light blue to the sky blue I selected, all painted with zero transparency.

The color of the sky can take on different shades, depending on viewing angle, sun quality, time of day, and even the camera set-



tings. One option is to use a picture to evaluate the shade. I recommend experimenting with the RGB settings until you find a color you like. You can also mix shades of blue, using a lighter shade in the lower areas and darker shades higher up.

Once I had a color I liked, I used the paintbrush tool to apply it over the background of my picture file, covering up the closet

1. Before.

## DIGITAL BACKGROUND | 4

doors and back wall, as shown in [4]. I suggest starting with a fine brush and tracing around the borders – in my case the trees, mine, and ore cars. I found it helps to magnify the view before tracing around the more difficult objects. After the tracing was complete with the small brush, I switched to a larger brush to quickly fill in the remaining areas. On to Step 3!

### Step Three

In my case, I needed to add some additional ground to the left

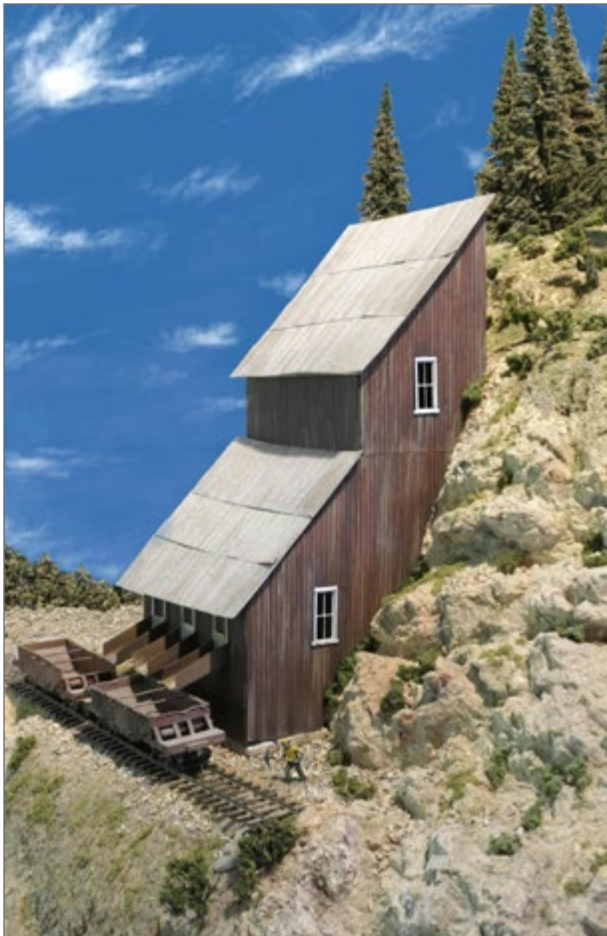

horizon – otherwise, the track would appear to come out of nowhere. Some model photos may have a rising hill or mountainside in the background, and for those model shots, adding a sky background alone would be sufficient.

To paint the horizon, I used the cloning tool in the iPhoto Express software (Photoshop Elements has a similar tool). First, I cloned a portion

2. After.



R = 0  
G = 0  
B = 255



R = 0  
G = 128  
B = 255



R = 39  
G = 94  
B = 148

3. RGB values (top-to-bottom) for pure blue, light blue, and my selected sky blue.

of the dirt base along the lower ledge of the mountainside and extended it as shown in [5]. Then I cloned a tree at the top of the mountain and used it to add in a distant tree line. Time for some clouds!

### Step Four

This step can take a while, depending on how many clouds you want, and how much fiddling you're willing to do. For me it's an enjoyable time to stretch my artistic muscles painting those



realistic airy forms. I find cirrus clouds to be the easiest and most effective to paint, but the larger cumulus clouds can also be done – it just takes time and practice.

I started by selecting white for the paintbrush (RGB = 255) with a high transparency (I used 97% transparency). I added a

4. I used a paintbrush tool and my chosen sky blue color to paint out the door and wall.

## DIGITAL BACKGROUND | 7

few random streaks with a medium-sized brush to break up the monotony of the blue background. I found if the streaks appear too regular, I can go back and break them up by adding more blue here and there.

I used a smaller brush to create each cloud by going over and over the same area to slowly build up more white to get a cloud density that looked good to me. By keeping the paint very transparent, it takes multiple passes over the same spot to become less transparent, and gradually become a denser white. This



looked exactly how cirrus clouds appear in the sky to me.

I experimented with different brush patterns and sizes. As the clouds get larger, you may want to add some transparent gray to the undersides to simulate heft and

5. Using the clone tool, I added some more ground and a line of distant trees on the left above the ore cars. This way, the scene doesn't seem to just "drop off" to the left.



depth. For inspiration and ideas, simply Google “sky” or “clouds.” You can see my final result in [2].

This same technique, by the way, can be used for adding locomotive smoke and other mist-like effects to a photo.

As an alternative approach, you can start with a white background and use blue at 90% transparency to add blue patches among the clouds. I find this method works particularly well for painting a sky with large swaths of white clouds.

### Some final words

A digitally generated photo background can be an aid when painting an actual backdrop. Even if a backdrop exists, this can also allow for different scenes, such as an overcast sky or a looming storm to be depicted. Let your imagination be your guide.

Once you start creating skies, don't be surprised if you find yourself outdoors gazing up and studying shades of blue and infinite varieties of clouds, appreciating their form and beauty in ways you might not have in the past. There are worse ways to spend your time!



**Click here to rate or  
comment on this article**



---

# TAKING SKY BACKDROPS TO THE NEXT LEVEL

BY THE MRH STAFF

Peter's tutorial is a great 101-level introduction to editing the sky in digital photos.



To take this to the next level, you need to look at doing *masking layers* in these various photo editing tools. Google “photo masking layers” to get dozens of how-to pages and many YouTube videos demonstrating this method.

We took Peter's photo and built a

**6. We took Peter's photo and built a masking layer by painting the areas to remove black and the areas to keep white.**

# DIGITAL BACKGROUND | 10

masking layer [6]. To do this, we duplicated Peter's photo into a new layer, and then we used Peter's painting method to paint-out all the parts of the photo we wanted to keep with white, and then painted-out the part we didn't want to keep (the door and wall) with black.

The way we like to think of a photo mask is: black "burns away" the parts we want to make transparent, and white "keeps" the part of the photo we want to leave opaque (and not touch). You can also make an area gray if you want it to be translucent (semi-transparent), but that's getting beyond the scope of this discussion.

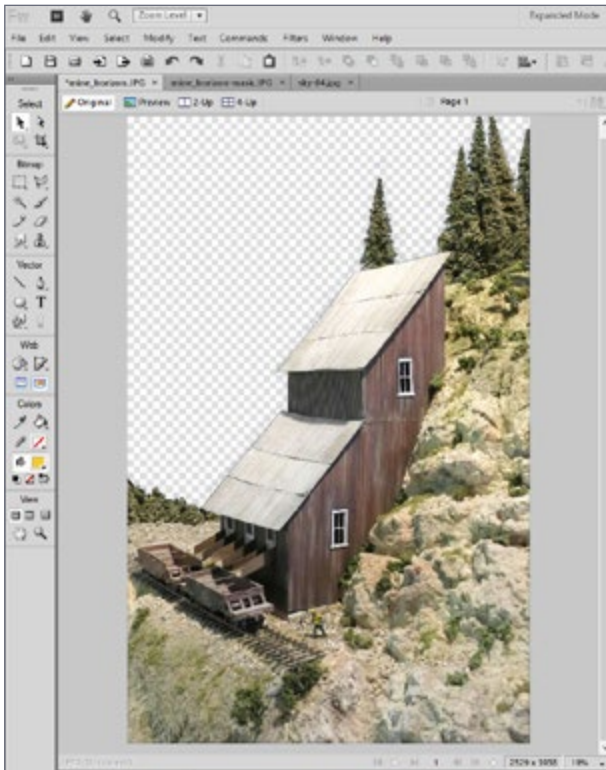

Once you have the mask built, then you apply the mask to turn the sky area transparent.

7. Once we applied our black and white mask [6] to Peter's photo, here's how it looked in the photo editor. The gray checkerboard pattern represents areas in the photo that are now transparent.

## DIGITAL BACKGROUND | 11

---

Most photo editors indicate transparent areas with a light gray checkerboard pattern [7].

With the sky now transparent, we Googled “sky” and picked a sky photo that looked good to us [8], and pasted it into a new layer behind the photo in [7]. As a result, Peter’s photo now has a real sky, using a real photo in the layer behind the transparent part of his photo.

Learning to use transparency masks in the digital photo editing tools opens up all kinds of possibilities for adding interesting backgrounds to your model photos. You can also explore background options for that real layout background before you commit to actually building it! ■

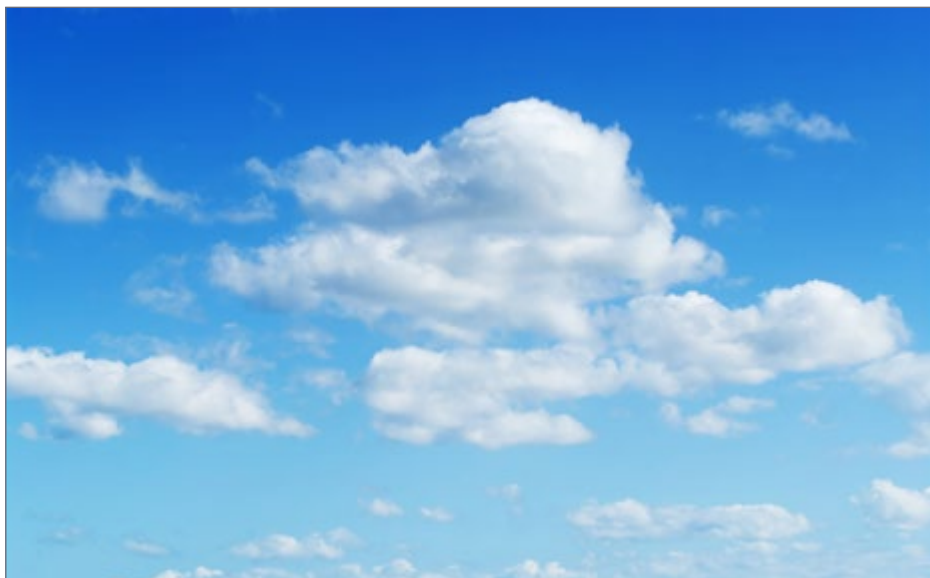

8. We Googled “sky” and selected this sky photo to place behind Peter’s mine photo. See [9] for the result.

---

## DIGITAL BACKGROUND | 12

---



9. Here is the final result, with the sky photo [8] placed behind the masked photo layer [7] having a transparent blue area. Once you learn how to use a masking layer to make part of a photo transparent, you can do most anything with the background: do a sunset, add hills, show a looming storm – literally, the sky's the limit!

---



### PETER VASSALLO



Peter lives in Albany, NY and works as a mechanical engineer. Despite living in New York all his life, he has developed a fondness for western railroads, particularly the old narrow gauge lines of Colorado and California. He enjoys both modeling and photographing these types of scenes. A story on his freelanced HO<sub>n</sub>3 layout, The Alistair Road, is scheduled to appear next spring in the Narrow Gauge and Short Line Gazette.

---



**Click here to rate or  
comment on this article**

# Model Railroad Hobbyist *Store*

**We sell books too!**



Paperbacks



eBooks

**Shop MRH Store Books >>**





# *Return to* **Allagash Cou**

• [INDEX](#)

• [TABLE OF CONTENTS](#)





# ntry

1. On March 6, 1984, my friend Joe Posik and I once again headed north to Maine. It had been four years since we railfanned the Pine Tree State. Much had changed since our last visit in the early spring of 1980. Excitement was high. We were headed back to Alagash country!

• [INDEX](#)



[SUBSCRIBE](#)  
(free)

• [TABLE OF CONTENTS](#)

BY MIKE CONFALONE



[Click here to rate or comment on this article](#)

**IT SEEMED LIKE YOU NEEDED A SCORECARD TO KEEP** up with all of the changes that had taken place in New England rail-roading since 1980. The coming of Guilford meant that things would never be the same. The Maine Central, Boston & Maine, Delaware & Hudson, and most recently the Allagash had been combined into a huge system stretching from central Maine to central Pennsylvania, with connections beyond.

Fortunately in 1984, the identities of the individual railroads were still largely intact, with only a handful of locomotives painted into Guilford's gray and orange industrial-style scheme.

The individual railroads freely mixed locomotives, bringing color and variety to the combined system. D&H Alcos came to Maine, Maine Central, B&M, and Allagash Geeps ran through to New York. The possibilities were endless. It was a great time to be trackside, before all of the labor disputes and other strife that befell the railroad in the late '80s.

After spending a couple of days on the Maine Central around Portland, we decided to head north for the Allagash. It was a largely snowless winter thus far, with the remnants of an early February storm melting away.

Temperatures weren't bad for March. We grabbed a cheap motel room up near New Sharon and hunkered down. We only had a couple of days.

The Allagash still based a switcher at New Sharon. The N1 job worked the yard and local industries and made a run up the New

## RETURN TO ALLAGASH | 4

Portland Branch to serve a couple of important industries on the outskirts of New Sharon at “Allen.” Since we had limited time, we decided to focus on the branch, hoping to catch a few jobs, hopefully with Alco power.

### Wednesday, March 7

We got up before dawn and headed down to the modest engine terminal at New Sharon Yard. There was no switcher present, and we started to get nervous. We headed over to the yard office, and introduced ourselves.

Despite the changes, the Allagash guys at New Sharon were pretty laid back and we had a nice chat with the yardmaster. He informed us that a crew had taxied up to Allen to grab the power, Maine Central Alco RS11 802, which suffered a mechanical failure on the way back yesterday afternoon and was stranded on the branch. The 802 was one of just two RS11s on the Maine Central roster. Sister 801 was already in the deadline. This was a rare catch indeed!

***TrainMasters TV is part of  
the MRH product family.***

***TMTV members not only get great network TV level  
videos, they help pay for MRH and keep it free ...***

• [INDEX](#)



**SUBSCRIBE**  
*(free)*

• [TABLE OF CONTENTS](#)

## RETURN TO ALLAGASH | 5



We thanked our friend for the tip and raced up toward New Portland Junction. MEC 802 was back in business and just approaching the station sign and the junction with the Kennebec Subdivision in the early light. Sandy River Farm & Building Supply was served off the passing siding at New Sharon. A single Bangor & Aroostook 40-foot boxcar was on the customer siding [2].

The 802 returned to the yard at New Sharon and quickly grabbed a pair of covered hoppers loaded with grain for Agway at Allen. Joe nailed a shot of the 802 parked on the New Portland Branch main while the crew went down to the Bear Hill Variety store for a coffee [3].

I positioned myself up near the station sign for Allen and captured a neat image of the 802 on the move again, working against the morning light. Gray storm clouds were giving way to sun [4].

## RETURN TO ALLAGASH | 6



Joe headed up the branch a bit and got an interesting angle of the 802 coming into Allen with the Agway on the right and the still-dark lot of the Ethan Allen plant on the left [5, next page].



## RETURN TO ALLAGASH | 7



With the sun finally up, we took a few shots of the 802 switching Agway and the Ethan Allen plant. The Ethan Allen plant takes in logs (mostly trucked in) and produces furniture panels that are shipped out by rail to various Ethan Allen furniture factories. The 802 is re-spotting an SP double-door boxcar [6] for furniture-panel loading.

Joe and I headed over to the Bear Hill Store to get a snack, and then jumped over the knoll in the back of the store to get in position for the 802 and train as it headed back to New Sharon Yard with a couple of empties from Agway [7]. The Kennebec Sub mainline can be seen in the distance.

The rest of the day was quiet at New Sharon, with lots of sunshine but no action.

# RETURN TO ALLAGASH | 8



• [INDEX](#)



[SUBSCRIBE](#)  
(free)

• [TABLE OF CONTENTS](#)

## RETURN TO ALLAGASH | 9

### Thursday, March 8

We woke to overcast skies on Thursday, our last day in Maine. The N1 would not be leaving the yard limits this day, but the Yardmaster informed us that the New Portland Switcher (P1) was on the move and headed down the branch toward New Sharon.

After a quick breakfast at McDonald's, we headed up toward Allen and found Allagash RS11 703 re-spotting a covered hopper at Clarke's Agway [8]. Its train from New Portland was parked on the mainline just north of the passing siding and he spent a few minutes at Agway before returning to his train.

We quickly recognized that the 703 was the same Alco we saw four years ago as former Penn Central 7605! At that time it was in old PC black paint. Since then, it had been given an Allagash yellow dip and a new number. It was good to see that the old warrior survived the Guilford transition.



8



## RETURN TO ALLAGASH | 10



9

We had a chance to talk to the crew and it became apparent that despite the lousy weather we were going to get lucky today. Apparently a wood extra for Waterville was called earlier that morning at Madrid and was en route. The P1 would head back down the branch to New Portland Jct. and wait for the meet.

I climbed up on a pretty big snowbank near the Bear Hill Store and shot the 703 and train as it crossed Route 134. Clarke's Agway and Tommy's Garage and Gulf station make for a classic New England scene [9].

Joe hustled down toward New Portland Jct. for a different view of the small train as it swung toward the junction [10, next page].

We took advantage of an old 40' boxcar spotted on the siding at Sandy River Farm & Building Supply, carefully climbing up for a killer view of the action. We waited around for quite a while up there, freezing in the raw, March wind.



Soon, we heard a distant horn and the snarl and chug of Alco prime movers as Extra 425 South came into view. Wow, this was a real score! The first and as of yet only Allagash locomotive in Guilford colors, Alco C425 number 425 [10] on the point! The train crested the hill and began to throttle down as he passed us, with a big slug of loaded wood chip hoppers and pulpwood flats. What a way to finish up!

After a little while, the 703 and train came off the branch and entered the Kennebec Sub mainline, passing Sandy River Farm & Building Supply, and headed for New Sharon Yard, where he would tie up for a several hours. Our day was done [11].

Our trip back to Allagash Country, albeit brief, was once again rewarding. On the drive home we were already plotting our return, for a much longer stay later in the spring! ☑





ADVERTISEMENT

# END OF TRAIN DEVICE

**NEW SAFETY GREEN**



**Bright Red  
Flashing Light!**

Installs in minutes!  
No freight car  
modification required!

Patented Technology - US Patent 7,549,609

**Does not affect Load!**

↓ Car without Load ↓

↓ Car with Load ↓



**Click Here to  
Learn More**

**RE RING™  
ENGINEERING**

• INDEX  
.....



**SUBSCRIBE**  
(free)

• TABLE OF CONTENTS  
.....

### MIKE CONFALONE



Mike Confalone grew up in Smithtown, New York, and got into model railroading at age 10 or 11. Like many young teens, he joined the local model railroad club and got his first glimpse of model railroading on a large scale.

College in the mid 1980s took him away from the hobby for a while, but railfanning became a favorite pastime.

Mike publishes a Northeastern prototype railroading magazine called Railroad Explorer ([railroadexplorer.com](http://railroadexplorer.com)), and has published six books on prototype railroading.

Today, Mike's proto-freelanced, under-construction Allagash Railway occupies a 58' x 24' space – his entire basement and the former two-car garage. Mike loves all aspects of model railroading, from benchwork on up, but his specialty is scenery and weathering. He also enjoys the challenge of prototypical operations.

Besides the trains, he and Susan love to garden and landscape their wooded two-acre property in southern New Hampshire. He also plays a mean guitar, but his Fender and Marshall-fueled rock-band gigning days are over, at least for now!

---



**Click here to rate or comment on this article**

# Model Railroad Hobbyist *Store*

## We have more Allagash!

### VIDEOS

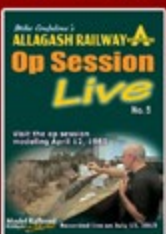
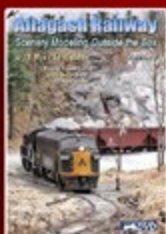

### BOOKS



Shop the MRH Store >>



• INDEX



SUBSCRIBE  
(free)

• TABLE OF CONTENTS



# Southern Digital



**20% Discount  
on most Items!**

*Specializing in DCC Since 1992*



## DCC Conversions, Service & Support

Orders Received by 3:00 pm EST ship the same day

**WWW.SODIGI.COM**

E-mail: [sales@sodigi.com](mailto:sales@sodigi.com)

(770) 929-1888

*(Photo's are from our N-Scale layout)*



# LOOK

column



[Click here to rate or comment on this article](#)

DON HANLEY



1. The entire NCE Power Cab Starter Set comes in a single box.

## AN EASY DCC STARTER KIT

### I RECENTLY ACQUIRED AN NCE POWER CAB

system along with an NCE Cab06 for my switching layout. I had a long hiatus between layouts and confess that although I have operated on many a DCC layout, this is my first foray into DCC on my personal home layout. A fellow modeler came over and helped me with the installation. Once I saw how easy it was, I kicked myself a bit for not jumping in and just doing it.

The Power Cab quick start system is essentially a plug and play setup. The only power tool I needed was a saber or jig saw

▶ NEW PRODUCT FIRST LOOK

• [INDEX](#)



[SUBSCRIBE](#)  
(free)

• [TABLE OF CONTENTS](#)

## FIRST LOOK | 2

to cut a small slot in the layout fascia to insert the Power Cab panel. After that, I just connected the output track wires from the Power Cab to the bus wires on the layout. That was the most complicated part of the installation.

The only other work is simply plugging the proper plugs into their corresponding sockets. You do not have to worry about plugging the wrong plug into the wrong place because no two plugs or their corresponding receptacles are the same.

Once we completed the installation, I turned on the power, the red power-on LED came on, and was up and running.



2. Inside the box is the handheld Power Cab which is the system command station, a “wall wart” power supply, throttle fascia panel, Power Cab coiled tether cable, and a reference manual. The first couple pages of the manual have visual quick-start instructions, but setup is as simple as it gets; two wires to the track bus and plug in the power supply.



# TCS WOWSound

Come meet us at one of the upcoming train shows listed below, bring your engine, and **get WOWSound installed** for the bargain **show price** of **\$97**.

Learn from the best as **we perform your WOWKit installion** 1-on-1 and return home with a tested WOWSound equipped engine ready to go.

[Click here to learn more and register for a spot at an upcoming show](#)



**Amherst Railway Society Railroad Hobby Show**  
 Springfield, MA - Jan. 28th & 29th, 2017  
[Register for an installation at Amherst](#)



WOWKits provide the only true turn-key sound conversion solution.

[www.TCSDCC.com](http://www.TCSDCC.com)

ADVERTISEMENT

Want it on Blu-ray?

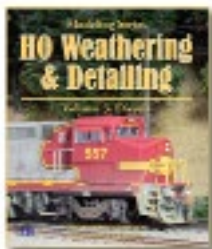

Selected titles are now available on Blu-ray disc in spectacular HD!

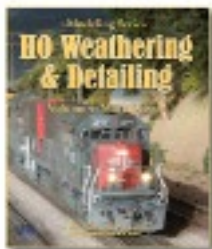

**CLICK FOR BLU-RAY**

**TSG Multimedia**

ADVERTISEMENT

## WAY TO GO, TRAINTEK!

*Already great prices and NOW ...*

**FREE SHIPPING ON ORDERS OF \$79 or more\***

**Start saving now!**



\*some exclusions apply

• **INDEX**



**SUBSCRIBE**  
(free)

• **TABLE OF CONTENTS**

## FIRST LOOK | 3

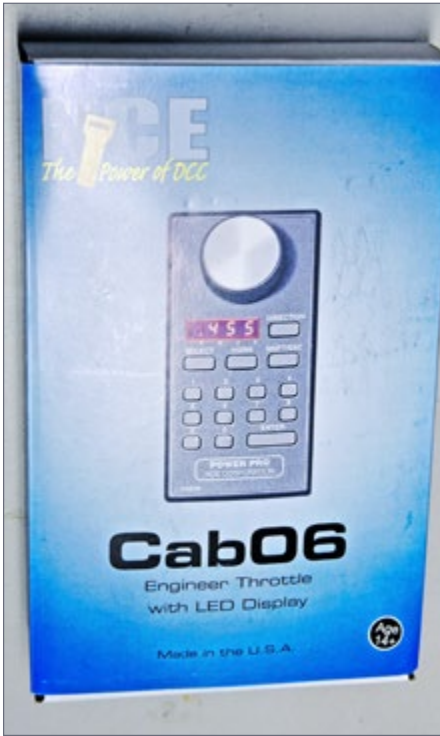

3. The Cab06 comes in a single box as well.



4. Here's what's in the Cab06 box: the handheld throttle, a coiled tether cable, and an instruction sheet.

Because I like to use a smaller throttle for operations, I got the Cab06 and use it as my primary throttle for operations. Its small size makes it very handy for operating my small layout. MSRP for the Power Cab is \$199.95; the Cab06 is \$99.95. NCE's website is at [ncedcc.com](http://ncedcc.com).

This extra throttle is an add-on because the Power Cab throttle is the brains (the command station) for the DCC system. I can also use the larger Power Cab "hammerhead" as a second throttle for running a second train.

**IOWA SCALED  
ENGINEERING**

Infrared  
sensors!



LEARN MORE >

Checked us out lately?

- HO/N and now O scale products too!
- Laser-cut Structures & Bridges.
- Advertising & Storefront Signs.
- Highway Signs, vintage & modern.
- New Detail Items.
- Laser-cut Grade Crossings.
- Billboards, roadside & rooftop.
- Laser-cut Graffiti Decals
- 1000's of satisfied customers.

WHAT'S  
NEW?



Established 1993...

**Blair Line**

ADVERTISEMENT

YD



Yankee Dabbler – Track 33

**FREE SHIPPING  
ON ORDERS OVER  
\$100.00**



**CLICK AND SAVE TODAY!**

**2017**  
SOL

YD installs DCC or RailPro in your engines

Technical Coordination (727) 457-9227 9AM to 9PM EST

• INDEX



SUBSCRIBE  
(free)

• TABLE OF CONTENTS

## FIRST LOOK | 4

The Power Cab is ideal for someone who is building their layout using the MRH TOMA concept. Since most TOMA layouts will likely run with one or two locomotives at first, the NCE Power Cab is a low-cost way to begin DCC operations on a smaller home layout. As your layout expands, then the Power Cab DCC system can be expanded to meet new demands.



[Click here to rate or comment on this article](#)

ADVERTISEMENT



SOUNDTRAXX<sup>®</sup>

## Fun Features for a Fraction of the Cost!

As the most versatile, feature-packed sound decoder, Econami redefines *value*. Starting at \$79.95 and available now!



Hear how you can get more for less!



• [INDEX](#)

• [TABLE OF CONTENTS](#)

# TONY'S TRAIN XCHANGE

*Committed to your DCC support!*

## ESU LokSound DCC Decoders



Accurate, Prototypical Sound  
& Superior Motor Control.  
All Select & V4.0 Decoders  
N Scale through G Scale  
Starting at \$85.95

**Order Yours**

## NCE DCC Systems Super Sale!



Get a great  
price on all  
NCE DCC  
Starter Systems

**Order Yours**

**Find Us At The Amherst  
Train Show, Jan. 28th - 29th**

Call to place your orders now  
for pick up at the Big-E show!

## Athearn Genesis UP Turbines Are Here!



Available with Tsunami Sound  
& DCC, or DCC Ready

Fully Assembled With Impressive  
Prototype Details. Available  
With or Without Tenders.  
Order Yours Now!

Starting at \$189.95

**Order Yours**

**Do you need a Sound or  
DCC Installation done?**

**Get a quote!**



Providing unmatched person to person  
DCC support for more than 25 years, the  
kind of service that has made us #1 in DCC.  
**DCC questions? CALL US! 1-800-978-3472**

*We'll get you on the right track!*

Jan 2017



• INDEX



SUBSCRIBE  
(free)

• TABLE OF CONTENTS



**NEW ALCO 1600-HP  
FREIGHT-PASSENGER LOCOMOTIVE**



**ERIE FA-2**



*Order Deadline  
Valentine's Day  
Click Here*

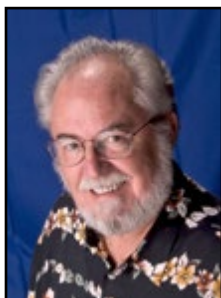

# JANUARY NEWS

column

RICHARD BALE *and* JEFF SHULTZ



[Click here to rate or comment on this article](#)

## Fred Folk (1943-2016)

Noted rail enthusiast Fred Folk passed away at his home in Bayfield, CO on December 10. He was 73 years old. Folk was a dedicated train enthusiast throughout his lifetime, building model trains and helping to restore full-size trains in his home town of Reading, PA and later in Colorado. He was a member of the Reading Society of Model Engineers and co-founder of the Durango Railroad Historical Society. Folk was also a classic car enthusiast with a strong focus on Fords. He is survived by his wife Jennifer and daughter Katrina Walker of Aztec, NM. In lieu of flowers, memorial contributions can be made to Durango Railroad Historical Society, P.O. Box 654, Durango, CO 81302 ...

▶ THE LATEST MODEL RAILROAD PRODUCTS, NEWS & EVENTS

• [INDEX](#)



SUBSCRIBE  
*(free)*

• [TABLE OF CONTENTS](#)

## NEW PRODUCTS FOR ALL SCALES

**Dead Rail Installs** released a 850ma 11.1 Volt Lithium Polymer Battery Pack designed for battery-powered, radio-controlled model trains. The pack has a circuit that protects against short circuits, overcharge, and low voltage. Dimensions are .7 x 1.18 x 1.89-inches. For more details including ordering information visit [deadrailinstalls.com](http://deadrailinstalls.com).

.....



**SoundTraxx** is selling the TSU-2200, a universal 2 amp digital sound decoder suitable for HO and S scale locomotives. It measures 35 x 18 x 6 mm and has a connector to add a CurrentKeeper to maintain performance over dirty tracks and switch gaps. The decoder is available for a variety of steam, diesel, and electric locomotive sounds. For more information contact a dealer or visit [soundtraxx.com](http://soundtraxx.com).

.....

## MULTIPLE SCALE PRODUCT NEWS



**Chooch Enterprises** has announced new Cobblestone Roads

and Cobblestone Detail sheets in HO, N and O scales. Made of flexible vinyl, each sheet includes Chooch's new Peel & Stick Transfer Adhesive, and is 3.75 x 12 inches. The sheets may be easily cut with scissors. For more information see a dealer or go to [choochenterprises.com](http://choochenterprises.com).

.....



# JANUARY NEWS | 3

---



**Woodland Scenics** predicts a January 2017 availability for its H&H Feed Mill, a pre-assembled and painted structure in N (pictured), HO and O scales. Each structure is pre-lit using Woodland Scenics Just Plug

Lighting System and features positionable details and doors, depending on the scale. For more information see your dealer or [woodlandscenics.com](http://woodlandscenics.com).

---

## O SCALE PRODUCT NEWS

**3rd Rail Division of Sunset Models** has announced that it is taking reservations for O scale EMD SD40-2 diesels for release in Fall 2017. The production run will include both high and low short hood examples, and will feature ABS bodies with fixed pilots, ball-bearing axle journals, a horizontal Canon motor, detailed cab interior, and sound in both two rail (QSI Titan) and 3 rail (Railsounds) versions. All wheels will be powered. For more information see [3rdrail.com](http://3rdrail.com).

---



**Atlas O** will begin 2017 with the release of a group of 2016 Ford F-250 XLT pickup trucks. The 1:50 scale die-cast models will be available with a super cab and eight-foot bed, and with a crew

car and six-foot bed. Paint jobs include red, black, grey, dark blue, and white. The trucks will also come in a set of two



# JANUARY NEWS | 4

configured as escort vehicles with tool boxes, high poles, bed racks and light sets. They include engine detail, opening doors, opening tailgate, interior details, correct decorations and labeling, underside details, hoses and clamps, wires and mirrors.



New Master series items coming from Atlas O during the second quarter of this year include newly tooled

53-foot CIMC and Jindo containers and a Gunderson Maxi-IV well car. The three-car set of well cars will be available decorated for AOK-III Transportation, BNSF, TTX Company (Heritage logo), and TTX (ex-BRAN).



Decorating schemes for the Jindo containers will be CSX (How Tomorrow Moves slogan), and North American Container

System. The CIMC containers will be available decorated for Florida East Coast, Hub Group (Norfolk & Western), UMAX (Union Pacific – CSX), and EMP (Union Pacific – Norfolk Southern).



Also coming from Atlas O during the second quarter is another release of its

Trainman series 52-foot 6-inch 70-ton war emergency gondola. Paint schemes will be Grand Trunk Western, Indiana Harbor Belt, Norfolk & Western, Santa Fe, and Pennsylvania Railroad. Atlas O rolling stock is available with appropriate trucks for either 2-rail or 3-rail operation. For additional information on all Atlas O products contact a dealer or visit [atlaso.com](http://atlaso.com).

# JANUARY NEWS | 5



**Smoky Mountain Model Works** is accepting reservations through the end of this month for a kit of an

O scale AAR 70-ton 53-foot 6-inch flat car. Components in the limited edition kit will be produced using 3D printed patterns and pressure-cast industrial-grade urethane. The frame, one-piece deck, and center sill rivet strips/plates will be separate castings to allow room for a concealed steel-bar weight. The unique stake pockets will also be separate castings. Additional detail parts in the kits are from Grandt Line and Tichy. Decals are being prepared by Protocraft. For additional information visit [smokymountainmodelworks.com/O\\_rolling\\_stock.html](http://smokymountainmodelworks.com/O_rolling_stock.html).

.....

## HO SCALE PRODUCT NEWS



**Accurail** has completed the tooling for a series of HO scale 36-foot double-sheathed wood boxcar kits. The initial release includes a Boston & Albany car with corrugated steel ends, and a Buffalo, Rochester & Pittsburgh boxcar with double-sheathed wood ends. Both cars have fish-belly underframes.



Also new from Accurail are HO scale kits for USRA twin-bay hopper cars



# JANUARY NEWS | 6

decorated for New York, New Haven & Hartford; and Boston & Maine.



Additional HO kits recently released by Accurail include a Pullman Standard triple-bay covered hopper car decorated for Great

Northern, and a three-car set of Pennsylvania 40-foot steel boxcars with slightly different paint schemes.



For more information on Accurail products, see a dealer or go to [accurail.com](http://accurail.com).



**Athearn** has scheduled the next release of its Genesis series HO scale Union Pacific FEF 4-8-4 steam locomotive for late October.

Union Pacific took delivery of the initial FEF-2 4-8-4s in 1939. They were built as coal burners with single exhaust stacks, drop coupler pilots and 14-wheel centipede tenders. FEF-3s upgraded with cast pilots and double stacks were delivered during WWII. A few months later they were fitted with large smoke deflectors. After WWII all of UP's FEF 4-8-4s were converted to burn oil. Union Pacific No. 844 received several liveries including two-tone gray (1946-mid-1950s), black

## JANUARY NEWS | 7

(mid-1950s-1987) and back to two-tone gray (1987-1991), and black (1996-present). Roadnumbers in this release include FEF-2 #827, FEF-3 #839, FEF-3 #8444, and FEF-3 #844.



A few of the Genesis models many features include illuminated number boards, adjustable cab windows, detailed boiler back-head, blackened metal wheels, and numerous individually applied detail parts including metal handrails. A DCC decoder with ESU Loksound sound recorded live from the prototype is mounted in the tender. The sound units will operate in both DC and DCC modes. A minimum track radius of 22 inches is required.

Athearn suggests that hobbyists who appreciate the ESU LokSound option should inform their retailer at the time they place a reservation. If ESU LokSound proves to be popular, Athearn will continue to offer it in selected locomotives.



Additional Athearn models set for release in October include a modern 33,900 gallon LPG tank car. The HO scale model will be available in three different body phases: original, flat panel, and late modifications. Three road numbers each will be available for Procormax, ConocoPhillips, Exxon-Mobil (white tank), and three slightly different schemes for UTLX.

Two types of 53-foot stackable domestic containers will be released in October. A CIMC container with horizontal rib fronts will be available decorated for XPO Logistics and COFC Logistics, and Jindo containers with vertical rib fronts will be decorated for COFC Logistics, EMP, UPS, and Yanke. Each



# JANUARY NEWS | 8



container will be individually numbered. Container chassis compatible

with the 53-foot containers will be available decorated for BNSF, CSX, JB Hunt, Norfolk Southern, Pacer, and Union Pacific.



Athearn has listed two versions of a Ford F-850 truck in its October release. The HO scale model is currently available with a grain bed in two colors and will arrive in October 2017

with a long stake bed in several different colors.



**Athearn Roundhouse** brand models coming in October include a General Electric AC4400 diesel locomotive. Road names will be Burlington Northern Santa Fe, CSX, Kansas City Southern, Norfolk Southern, Quebec Cartier Mining, and Southern Pacific.



A Union Pacific-patched faded ex-SP unit is also in the mix. The HO scale DC model will have both 8- and 9-pin connectors to ease installation of an aftermarket DCC decoder (not supplied). Additional Roundhouse HO scale models coming next October

# JANUARY NEWS | 9

are a 40-foot pulpwood bulkhead flat car and a 40-foot single-sheathed wood boxcar with Dreadnaught ends and Superior sliding doors. For additional information on all Athearn products contact a dealer or visit [athearn.com](http://athearn.com).

.....



**Atlas** plans to deliver a new run of GP40-2 diesel locomotives during the second quarter

of 2017. phase II potting features include an 88-inch low nose, corrugated radiator grilles, and notched step wells. Road names will be Alaska, Canadian Pacific, CSX, Guilford Rail System (B&M), Seaboard System, and Union Pacific. An undecorated model will also be available.



A new Master series HO scale Trinity 5660 cu. ft. Pressure Differential covered

hopper car with five discharge bays is planned for release in the second quarter. Twelve road numbers each will be available for ADM, Norfolk Southern, and SCYX-First Union. Three road numbers will be available for two different Conagra decorating schemes. Atlas has pledged to make a donation to the Community Food Bank of New Jersey ([cfbnj.org](http://cfbnj.org)) for every Conagra “Feeding America” car sold.



This Atlas Trainman series twin-bay coal hopper with off-set sides will be



# JANUARY NEWS | 10

available during the second quarter decorated for Canadian Pacific (script), Delaware & Hudson, Louisville & Nashville (Old Reliable slogan), Northern Pacific, and Lehigh & New England. Although shown here with NMRA X2f couplers, the model will be supplied with Accumate knuckle couplers.

Completing Atlas' HO scale releases for the second quarter of 2017 is a 1973 Ford F-100 pickup truck. It will be available in black, white, brown and MOW yellow. Additional choices will be red/white and white/green two-tone paint schemes. For more information on all Atlas products contact a dealer or visit [atlasrr.com](http://atlasrr.com).

.....



**Bachmann** has introduced a DCC sound-equipped EMD E7-A diesel equipped with SoundTraxx 16-bit diesel

sound that includes a prototypical prime mover, bell, and three air horns. DCC sound-equipped models will be available for Baltimore & Ohio, Southern, New York Central, Chicago Burlington & Quincy; and Pennsylvania Railroad ( five stripe scheme). DC models with DCC-ready capability will be available decorated for Union Pacific, Louisville & Nashville, Atlantic Coast Line, Milwaukee Road, and Pennsylvania Railroad (single stripe scheme). Both versions will have all-wheel drive, operating Mars light, illuminated number boards, and a soft-white LED headlight.



Bachmann has added a DCC sound-equipped version to its line of EMD SD40-2 diesel locomotives. Road names are CP Rail, CSX,



# JANUARY NEWS | 11

Kansas City Southern, Norfolk Southern, and Union Pacific. For more information on Bachmann products, visit your dealer or [bachmanntrains.com](http://bachmanntrains.com).



**Bowser** is accepting pre-orders for a new production run of class N8 steel cabooses scheduled for release in May. The ready-to-run HO scale models will have window glazing, separate grab irons, metal wheelsets and PRR Train Phone antenna as appropriate to the prototype being modeled.



Road names will include Conrail and Penn Central, plus twelve different PRR decorating schemes. For additional information contact a dealer or visit [bowser-trains.com](http://bowser-trains.com).



**Broadway Limited** is selling several variations of an HO scale Union Pacific 4-8-8-4 Big Boy steam locomotive. The HO scale model comes with BLI's Paragon3

sound and control system. Options include locomotives with and without a Wilson aftercooler, a choice of coal or oil tender, and decorating schemes that reflect the active life of the giant locomotive from its introduction in 1941.

Broadway Limited has set a March date for the release of Electro Motive Corporation E1 diesels wearing the Santa Fe warbonnet paint scheme. Original (shown), pre-1946, and



# JANUARY NEWS | 12



post-war versions of the iconic paint

scheme will be available. The release will include A units, B units, and A/B sets. All A units will have the Paragon3 Sound/DC/DCC system. Both powered and non-powered versions of B units will be available. For additional information on all Broadway Limited products contact a dealer or visit [broadway-limited.com](http://broadway-limited.com).



**Funaro & Camerlengo** is selling an HO scale resin kit for a Chesapeake & Ohio triple-bay hopper car with offset sides. F&C kits include cast resin detail parts, a one-piece cast resin body, wire

for air lines, Tichy grab irons, cast styrene brake components, and appropriate decals. Trucks and couplers are not included. For additional information including a list of stocking dealers visit [fandckits.com](http://fandckits.com).



**InterMountain** has completed tooling on an HO Trinity 5161 cu. ft. triple-bay covered hopper car. The initial

production run, scheduled for release this summer, will include ready-to-run models decorated for Dakota, Minnesota & Eastern; CSX, AGP, Norfolk Southern, ADM (leaf logo), Potash, BNSF, Union Pacific/CMO, Canadian Pacific/SOO, and Kansas

# JANUARY NEWS | 13

City Southern. Features include etched metal roof walks, metal wheelsets, and Kadee couplers. An undecorated kit with plastic wheels and no couplers will be available.



Also scheduled for release this summer is a group of HO scale models based on an AAR Alternate Standard twin-bay hopper car. In addition to the

Nickel Plate car shown here, road names will include Santa Fe, Baltimore & Ohio, Erie, Cambria & Indiana, Northern Pacific, Wheeling & Lake Erie, Clinchfield, and Chesapeake & Ohio. For additional information on all InterMountain Railway products contact a dealer or visit [intermountain-railway.com](http://intermountain-railway.com).



**ITLA Scale Models** is selling Cooper's Alley, a group of three HO scale shallow relief industrial structures. The three buildings are identified as Cooper's Manufacturing, the Annex, and Brewer's Ale. The sidewalls of each structure are fully detailed which allows them to be arranged in any sequence desired. The

rear walls are blank. When assembled as shown the complex of three structures measure about 14.5 wide x 1.5-inches deep. The tallest building is 10.5 inches high ([itlascalemodels.com/buildings/ho4165-cooper-s-alley-3-way-industrial-building-kit.html](http://itlascalemodels.com/buildings/ho4165-cooper-s-alley-3-way-industrial-building-kit.html)).



Construction of the wood structure is tab and slot with numerous add-on details including cornice and pilaster brick trim strips, entry doors with security bars, 3D etched interior backdrops, assorted rooftop items including service



# JANUARY NEWS | 14

staircase structures, chimneys and ducting; three rooftop water tanks, a billboard sign kit, fire escape, and dock details including crates, boxes, pallets, and bottle cartons. The full color instruction booklet includes construction tips and painting suggestions. For additional information visit [itlascalemmodels.com](http://itlascalemmodels.com).

.....



**Rapido Trains** is developing an HO scale 40-foot Northern Pacific 10000-series wood

boxcar. The model is based on the 4,000 prototypes built by Western Steel Foundry during the 1920s. Spotting features of the double-sheathed wood car include a radial roof, National sliding side doors, steel side sills, an unusual lever hand brake, and 7/8 Murphy ends fitted with a lumber door.



The project, which is being coordinated with the Northern Pacific Railroad Historical Association, includes developing all-new U-channel trucks with in-line brake shoes and blackened machined metal wheelsets. Additional details include formed wire grab irons, full underframe detail with riveted center

sill, separate brake rods and piping, AB or K brakes as appropriate, and formed wire grab irons. Release dates are pending.

Rapido has announced details on the initial release of their New Look bus. The HO scale model faithfully replicates the nearly 50,000 prototypes in service throughout North America in the second half of the 20th century. The initial release is based on a T6H-5307N prototype with double-stream rear exit

# JANUARY NEWS | 15



doors. Rivets, interior stanchions, separately-molded seats, and steerable front wheels are standard on all models. A deluxe version of the bus includes painted seatback handrails and a

full lighting package.



Details appropriate to specific transit companies being modeled include three kinds of bumper (steel, water jug and rubber), standee windows or sheet metal panel, air conditioning housing with etched-metal fan cover, rear window air intakes and high level

exhaust, roof hatches, and various antennas. In addition to specific road names with multiple route/destination decals, painted but unlettered models will be available in several color schemes for hobbyists who want to create their own transit companies. Unpainted kits will also be available.



Deluxe editions of the New Look bus will have interior lighting, working headlights and tail lights, illuminated front destination sign, painted seatback handrails, and two-tone seats.

A 12V DC power supply is required to power the lighting (not included). Reservations will close in early May with delivery planned for this fall. Visit [rapidotrains.com](http://rapidotrains.com) for reservation information including a list of transit companies on the initial release.

The **Toronto Transit Commission (TTC)** has commissioned Rapido to produce an exclusive model of the rebuilt New Look



# JANUARY NEWS | 16



buses that served the Toronto area from 1995 to 2012. Both standard and deluxe versions of the model will be avail-

able in five different numbers. The modern Toronto New Look buses are available only from the TTC. For more information visit [ttcshop.ca](http://ttcshop.ca).

---



**Tangent Scale Models** has released its 40-foot PS-1 Mini-HyCube boxcar in several new road names. In addition to Milwaukee Road, Burlington, D&RGW and IC schemes issued

last August, the paper and appliance hauler is now available decorated for Northern Pacific (1967 Loewy green scheme with large NP and monad), and Burlington Northern (1982 Cascade green). The Milwaukee “DFB” scheme is a variation on the original “DF2” scheme. The fourth new paint scheme is the CB&Q “Chinese Red 11-67” scheme the cars were originally painted in.



The HO scale ready-to-run model features a flat panel roof with a very slight peak, separate underframe brake components with wire piping, narrow ladders and sill steps, and see-through crossover platforms. The near-scale draft gear that has become standard on all recent Tangent

releases includes the side-key detail with Kadee all-metal couplers and detailed uncoupling lift bars, and Barber S-2-A 70-ton roller bearing trucks fitted with 33-inch machined wheelsets. Semi-scale

# JANUARY NEWS | 17

replacement wheelsets are available separately. For additional details and ordering information visit [tangentscalemodels.com](http://tangentscalemodels.com).



**Walthers** mid-winter plans include the release of this 40-foot AAR modified 1937 boxcar. The HO scale Mainline series ready-to-run model will

be available decorated for New York, New Haven & Hartford; Chicago & North Western, Lehigh Valley, Soo Line, Southern Railway, and Union Pacific.



Also scheduled for release by Walthers next month are 20-foot tank containers decorated for Santa Fe, Hoyer, Tiphook, Union Pacific, and Vanhool.



Additional intermodal equipment coming in February is a group of 48-foot smooth side containers. The HO scale containers will be decorated for Burlington Northern, Canadian National, EMP, Genstar, and Con-Quest. For information on all Walthers products contact a dealer or visit [walthers.com](http://walthers.com).



**Yarmouth Model Works** has introduced a resin kit for a Santa Fe class Bx steel boxcar. Bx-48, Bx-53, and Bx-63 versions of the car are available. The kit features a one-piece cast resin body with



# JANUARY NEWS | 18

a separate roof (diagonal or square panel roofs) to facilitate painting. Additional features include an etched metal running board, etched detail parts, special etched ladders with etched rungs, custom decals from Speedwitch Media, and Kato ASF A-3 trucks. For additional information visit [yarmouthmodelworks.com/index.php/ResinModelKits/Index](http://yarmouthmodelworks.com/index.php/ResinModelKits/Index).

.....

## N SCALE PRODUCT NEWS



New N scale models coming from **Athearn** next October include a

53-foot GSC bulkhead flat car. Road names will be Chicago, Burlington & Quincy; Burlington Northern, Great Northern, Northern Pacific, SOO Line, and Trailer-Train. An undecorated version will also be available.



Athearn's October schedule includes a

33,900 gallon LPG tank car decorated for ConocoPhillips, Procor, Exxon-Mobil (white tank), Chevron Phillips, and five different Union Tank schemes including one white tank. Also coming next October is an 89-foot BSC F89F TOFC flat car with hitches that fit Athearn N scale trailers. It will be available decorated for both yellow and brown versions of TTX. For additional information on all Athearn products contact a dealer or visit [athearn.com](http://athearn.com).

.....

**Atlas** is scheduled to release its GP7 and GP9 diesels in new road paint schemes and numbers during the second quarter of this year.



## JANUARY NEWS | 19



GP7 locomotives will be available decorated for Burlington (CB&Q), Lackawanna,

Southern Railway, and Denver & Rio Grande Western. GP9 versions will be decorated for Pennsylvania Railroad, Union Pacific, and three Chessie System schemes – B&O, C&O, and WM.



Also scheduled for release during the second quarter are two versions of an FMC 5077 double-door boxcar. The release includes cars with both centered and

offset doors. Spotting features of the N scale modern-era car include an X-panel roof, double sliding doors, and non-terminating box corrugated ends. Cars with offset doors will be available decorated for Texas, Oklahoma & Eastern and City of Prineville Railway. Cars with centered doors will be available for Western Pacific and McCloud River.



Atlas' second quarter schedule includes this newly tooled N scale Trinity 5660 cu. ft.

Pressure Differential covered hopper car. Note the five discharge bays. Twelve road numbers each will be available for ADM, Norfolk Southern, and SCYX-First Union. Three road numbers will be available for two different Conagra decorating schemes. Atlas has pledged to make a donation to the Community Food

# JANUARY NEWS | 20

Bank of New Jersey ([cfbnj.org](http://cfbnj.org)) for every Conagra “Feeding America” car sold.



Completing Atlas’ second quarter production schedule is a new class NE-5 steel cabooses. The N scale ready-to-run model is based on a group of 33-foot

steel cabooses built by Pullman Standard for the New York, New Haven & Hartford Railroad. Many of the cabooses were later acquired by other railroads. The NE-5 had unusual sides fabricated from overlapping steel panels that gave the appearance of board & battens. Road names for Atlas’s new cabooses will be New Haven, Boston & Maine, Chicago Great Western, Conrail, and Penn Central. For additional information on all Atlas products contact a dealer or visit [atlasrr.com](http://atlasrr.com).

.....



**Bachmann** has announced several N scale smooth-side passenger cars, including

a 72’ baggage car, an 85’ coach with interior lighting, and an 85’ observation car with interior lighting. All cars are available in the following road names: PRR, Norfolk & Western, B&O, Union Pacific, and NYC. For more information see your dealer or [bachmanntrains.com](http://bachmanntrains.com).

.....

**Centralia Car Shops** expects to release a run of western-road diners late next summer. Features on the N scale ready-to-run models include wire grab irons, interior details and lighting, and

## JANUARY NEWS | 21

truck mounted couplers with operating knuckles. Road names include Great Northern in both orange/brown and Big Sky blue.

The model will also be available decorated for Burlington Northern, Canadian National, Northern Pacific, Amtrak, Chicago & North Western, and four Southern Pacific schemes: Overland grey, COSF yellow, Golden State red and grey, and Sunset Limited grey. For additional information contact a dealer or visit [intermountain-railway.com](http://intermountain-railway.com).

.....



**Digitrax** has released new drop-in mobile sound decoders for Kato N scale locomotives. The SDXN146K4 is for the Kato FEF 4-8-4 and similar locomotives, the SDXN146K1E (pictured) is for Kato N scale SD40-2 and similar locomotives, and the

SDXN146K2 is for the Kato SD80MAC and similar locomotives. All decoders have 4 FX3 Functions with a 200 ma output, an 8 ohm 10 mm x 18 mm oval speaker, a 100uF capacitor, and operate at 1 amp/ 2 amp peak. The decoders feature 8 selectable steam & diesel sound schemes, Series 6 decoder features, customizable 16, 12 or 8 bit sound, 4 simultaneous voices, and 16 megabits of onboard sound memory. The decoders will work with SoundFX 8 and 16 bit sound projects and sounds can be downloaded to them with the Digitrax PR3 and SoundLoader 2.0 software. For more information see your dealer or [digitrax.com](http://digitrax.com).

.....

**InterMountain** plans to release another run of its N scale Trinity 5161 cu. ft. triple-bay covered hopper in July or August. The N scale ready-to-run model features an etched metal roof walk





and turned metal wheelsets. Road names will be Potash, CSX, AGP, Norfolk Southern, ADM leaf logo, BNSF, Union

Pacific/CMO, Canadian Pacific/SOO, Kansas City Southern, and Dakota, Minnesota & Eastern. For additional information on all InterMountain products contact a dealer or visit [intermountain-railway.com](http://intermountain-railway.com).

.....



**Kato USA** is accepting reservations for the Milwaukee Road Olympian Hiawatha, the latest in its series of classic name train sets. The consist on the nine-car Olympian Hiawatha will be a baggage-dormi-

tory car, two 48-seat coaches, a super dome lounge, diner, three sleepers, and a Skytop lounge-observation car. The cars will be decorated in the post-1952 scheme after CMSt.P&P acquired the full-length super dome cars.

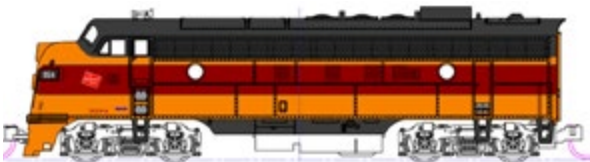

To lead its new Olympian Hiawatha, Kato will release EMD FP7A and a retooled F7B decorated in

Milwaukee Road's orange and red scheme. Although just two road

# JANUARY NEWS | 23

names are planned, alternate number boards will be available separately. The train set is scheduled for release in mid-2017. For additional information contact a dealer or visit [katousa.com](http://katousa.com).

.....



New releases from **Micro-Trains Line** include this BNSF twin-bay 50-foot Airslide covered hopper with closed

ends. The N scale ready-to-run model comes with 100-ton roller bearing trucks.



Also new from M-T is this 39-foot single dome tank car decorated for WRNX-Gulf. The model is shown here with orange lettering. It is also available

with yellow lettering.



Micro-Trains is selling a 31-foot bay window caboose decorated to mark the 175th anniversary of the Baltimore & Ohio – America's first organized railroad company.



Also new from Micro-Trains is a paired-window

coach decorated in the gray post-war scheme of the New York Central. Contact a dealer for additional information on Micro-Trains Line products or visit [micro-trains.com](http://micro-trains.com).

.....

## NEW DECALS, SIGNS AND FINISHING PRODUCTS



**Highball Graphics** has released three new decal sets for the Central Maine & Quebec. The three new decals cover 1) standard EMD hood units, 2) EMD SD40-2f series, and 3) BAR #9017 Heritage unit. Also new from Highball is a screen printed set of decals for the New Brunswick Southern/Maine Northern Hood Units. All of the items mentioned are available in both HO and N scale. For additional information visit [highballgraphics.com](http://highballgraphics.com).

.....



**Microscale Industries** latest releases include N, HO, and O scale decals for 20 and 40 foot Orient Overseas Container Line (OOCL) containers from the 1970s to 1985. Also available in N and HO scale are decals of colorful Train and Street Graffiti. For

additional information contact a dealer or visit [microscale.com](http://microscale.com).

.....



## SEND US YOUR PRODUCT ANNOUNCEMENTS

If you are a hobby manufacturer with a product announcement, just [click here](#) and submit your announcement to us. Our web site and free magazine reach continues to grow, so get on board this new media train! ■

---

### DISCLAIMER .....

The opinions expressed in this column are those of the writer and do not necessarily reflect the opinion of *Model Railroad Hobbyist* or its sponsors. Every effort is made to provide our readers with accurate and responsible news and information, however, neither *Model Railroad Hobbyist* or the writer of this column can be held responsible for any inaccuracies or typographical errors that may inadvertently appear in this column.



**Click here to rate or  
comment on this article**





BRIEFLY NOTED AT PRESS TIME ...



**Mount Vernon Shops** has released a set of HO scale decals for the Chessie System “Moonshine Hoppers,” cars in the late 1970s that were still in service on the Chessie System but were banned from interchange service. The hoppers received yellow ends and three large yellow “X’s” on their sides. They also received modern data stenciling but no

ACI labels. Each set will decal two cars, and is appropriate for the Train-Miniature/Walthers 8-panel 2-bay hopper car. For more information go to [mountvernonshops.com/products/ho-chessie-system-moonshine-hopper-decals](http://mountvernonshops.com/products/ho-chessie-system-moonshine-hopper-decals).

**Want to help keep  
MRH free?**

**Then *click* on ads!**



# Model Railroad Hobbyist *Store*

## We sell videos too!



DVDs



Downloads

[Shop MRH Store Videos >>](#)





# SELECTED EVENTS

## January 2017

*(Please note that many events charge a fee. Check individual info website for details.)*

**CALIFORNIA, SANTA CLARA**, January 27-29, Bay Area Layout Design & Operations Weekend, Sponsored by NMRA Pacific Coast Region Layout Design and Operations Special Interest Groups. Info [pcrnmra.org/pcr/calendar/calendar.shtml](http://pcrnmra.org/pcr/calendar/calendar.shtml).

**MARYLAND, BALTIMORE**, January 1,8,15,22,29, Baltimore Society of Model Engineers Open House, 225W Saratoga St. (3rd floor walkup). More info at [modelengineers.com](http://modelengineers.com) or 410-837-BSME.

**MASSACHUSETTS, WEST SPRINGFIELD**, January 28-29, Railroad Hobby Show, sponsored by Amherst Railway Society, at Eastern States Exposition Fairgrounds. Info at [railroadhobby-show.com](http://railroadhobby-show.com).

**MINNESOTA, WOODBURY**, January 14, Model Railroad Flea Market, at Woodbury High School, 2665 Woodlane Drive, sponsored by Newport Model Railroad Club. Request info from Ed Petry at [sierraed@usfamily.net](mailto:sierraed@usfamily.net).

**MICHIGAN, WYOMING**, January 7, Riverbend Model Train Show, Home School Building, 5625 Burlingame Ave, SW. More information at [rmrrc.org](http://rmrrc.org).

**WISCONSIN, STEVENS POINT**, January 21-22, 20th Annual Arctic Run Model Railroad Show, Holiday Inn Convention Center Hotel, 1001 Amber Avenue. Info at [thecitypages.com/events/20th-annual-arctic-run-model-railroad-show--sale](http://thecitypages.com/events/20th-annual-arctic-run-model-railroad-show--sale).

### Future 2017, by location

**AUSTRALIA, CANBERRA, KALEEN ACT**, March 25-26, 29th Annual Model Railway Expo, hosted by the Canberra Model Railway Club, at University of Canberra High School. Info at [cmrci.info](http://cmrci.info).

**AUSTRALIA, VICTORIA, GEELONG**, April 14-16, 13th Annual Australian Narrow Gauge Convention. Info at [austnarrowgaugeconvention.com](http://austnarrowgaugeconvention.com).

**CANADA, ONTARIO, BOWMANVILLE**, March 11, 8th Annual Bowmanville Model Railroad Flea Market, hosted by Soper Valley Model Railroad Association. New location at Clarinton Central Secondary, 200 Clarington Blvd. Send information request to [sopervalley@gmail.com](mailto:sopervalley@gmail.com).

**CANADA, ONTARIO, KINGSTON**, March 11-12, 28th Annual Rail O Rama model train show. Ambassador Hotel, 1550 Princess St., [kingstonrailorama.wix.com/show](http://kingstonrailorama.wix.com/show).

**CANADA, ONTARIO, LINDSAY**, April 8-9, 210 Lindsay & District 43rd Annual Model Train Show at the Victoria Park Armoury. For more information send inquiry to [waynelamb@sympatico.ca](mailto:waynelamb@sympatico.ca).

**CANADA, ONTARIO, TORONTO**, March 18, Toronto Railway Prototype Modellers Meet, Humber College, 205 Humber College Blvd. Info at [torontoprototypemodellers.wordpress.com](http://torontoprototypemodellers.wordpress.com).

**CALIFORNIA, RIVERSIDE-SAN BERNARDINO AREA**, February 25, Self Guided Layout Tour and Swap Meet. Request info from coordinator Bob Chaparro at [chiefbobbb@verizon.net](mailto:chiefbobbb@verizon.net).

**COLORADO, DENVER**, August 30-September 2, National Narrow Gauge Convention, at Marriott Denver Tech Center Hotel. Info at [37nngc.com](http://37nngc.com).



## SELECTED EVENTS | 3

**FLORIDA, FORT MYERS**, February 4-5, Annual Train Show, sponsored by Scale Rails of Southwest Florida, at Araba Temple, 2010 Hanson Street. Request info from Jim Overman at 239-272-6396.

**FLORIDA, ORLANDO**, July 30-Aug 6, NMRA National Convention and National Train Show. Info at [nmra2017.org](http://nmra2017.org).

**IDAHO, LEWISTON**, March 26, 6th Annual Lewis-Clark Train Club and Collectables Swap Meet, Nez Perce County Fairgrounds, 1229 Burrell Ave. Contact Dan Wise at 208-816-0845/[wrails@cablone.net](mailto:wrails@cablone.net) or Mike McGee at 208-816-6072.

**INDIANA, NAPPANEE**, March 18, 13th Annual Train Show at Dutch Village Market. Info at [trainweb.org/ew](http://trainweb.org/ew).

**KANSAS, WICHITA**, February 4-5, Train Show & Swap Meet, sponsored by NMRA Chisholm Trail Division, at Cessna Activity Center, 2744 George Washington Blvd, Request info from Larry Gulick at [legdag@cox.net](mailto:legdag@cox.net).

**MARYLAND, TIMONIUM**, February 4-5, The Great Scale Model Train & Railroad Collectors Shows at Maryland State Fair, 2200 York Road. Info at [gsmts.com](http://gsmts.com).

**MISSOURI, ST. LOUIS**, April 6-8, 32nd Annual Sn3 Symposium, at St. Louis Airport Marriott, 10700 Pear Tree Lane. Info at [2017sn3symposium.com](http://2017sn3symposium.com).

**OHIO, GREENVILLE**, March 5, Swap Meet, sponsored by Darke County Model Railroad Club, at Youth Building, Darke County Fairgrounds, 800 Sweitzer Street. Request info from Joe Worz at [josephbw@embarqmail.com](mailto:josephbw@embarqmail.com).

**OKLAHOMA, TULSA**, June 21-25, Annual Convention of the Santa Fe Railway Historical & Modeling Society. Info from Marc Montray at [m.montray@sbcglobal.net](mailto:m.montray@sbcglobal.net) or visit [atsfrr.com/convention/index.htm](http://atsfrr.com/convention/index.htm).

## SELECTED EVENTS | 4

**OREGON, PORTLAND**, March 25, Model Railroad Swap Meet by the Willamette Model Railroad Club. W.D. Jackson Armory, 6255 NE Cornfoot Rd Request info from Brigg Franklin (360)-241-5908. [wmrswapmeet@yahoo.com](mailto:wmrswapmeet@yahoo.com).

**PENNSYLVANIA, GREENSBURG**, March 24-25, RPM-East at Ramada Greensburg Hotel & Conference Center, Info at [hansmanns.org/rpm\\_east/index.htm](http://hansmanns.org/rpm_east/index.htm).

**SOUTH CAROLINA, EASLEY**, February 10-11, Annual Train Show, sponsored by Central Railway Model & Historical Association at (new location) Impact Center, Rock Springs Church 207 Rock Springs Road. Info at [crmha.org](http://crmha.org).

**TEXAS, STAFFORD**, February 18, Greater Houston Train Show, at Stafford Center, 10505 Cash Road, sponsored by San Jacinto Model Railroad Club. Info at [sanjacmodeltrains.org/GHTS/GHTS.html](http://sanjacmodeltrains.org/GHTS/GHTS.html).

**WASHINGTON, MONROE**, February 25-26, 26th Annual Washington State Train Show and Marketplace, at Evergreen State Fairgrounds. Event sponsored by United Northwest Model Railroad Club. Info at [unwclub.org](http://unwclub.org).

**WEST VIRGINIA, CHARLESTON**, February 18-19, 12th Annual Train Show at Lodge in Coonskin Park, sponsored by Kanawha Valley railroad Association. Info at [kvrailroad.org](http://kvrailroad.org).

**WISCONSIN, MADISON**, February 5, NMRA South Central Wisconsin Division, will meet at Zor Shrine Center, 575 Zor Shrine Place, Madison, WI 53719. For more info visit [nmra-scwd.org](http://nmra-scwd.org).

**WISCONSIN, MADISON**, February 18-19, Mad City Model Railroad Show & Sale, sponsored by NMRA South Central Wisconsin Division, at Alliant Energy Center, Exhibition Hall. Info at [nmra-scwd.org](http://nmra-scwd.org).



## Future 2018, and beyond

**MISSOURI, KANSAS CITY**, August 5-12, 2018, NMRA National Convention. Info at [kc2018.org](http://kc2018.org).

**UTAH, SALT LAKE CITY**, July 7-13, 2019, NMRA National Convention. Info at [northernutahnmra.org/2019-nmra-national-convention](http://northernutahnmra.org/2019-nmra-national-convention). ■



Click here to rate or comment on this article

ADVERTISEMENT



GLXSCALEMODELS.COM

3D PRINTED MODEL

OIL LANTERN KIT

1/48 SCALE!!!

\$19.99 + S&H

12 VOLT POWERED LED LIGHT



**WIN**  
**\$250**

*New  
Subscriber  
Sweepstakes*



Drawing on  
February 1, 2017

*from MRH*

Become a new MRH  
subscriber in January, and  
get entered into a drawing  
for \$250 cash!

**SUBSCRIBE NOW >>**

*Subscribing is FREE!*



# Clickable advertiser index – 1

[Accu-Lites](#)

[American Ltd \(San Juan\)](#)

[Amherst Railway Society](#)

[ANE Models](#)

[Archer Fine Transfers](#)

[Athearn](#)

[Atlas Model Railroad Co.](#)

[Bachmann](#)

[Backdrop Junction](#)

[Banta Modelworks](#)

[Berrett Hill Trains](#)

[Black Cat Publishing](#)

[Blair Line](#)

[Bowser](#)

[Canyon Creek Scenics](#)

[Clever Models](#)

[Coastmans Scenic Products](#)

[Coffman Graphics](#)

[Con-Cor International](#)

[Credit Valley Railway](#)

[Crow River Products](#)

[Digitrax \(2 page spread\)](#)

[ESU LokSound](#)

[Fast Tracks](#)

[Fox Valley Models](#)

[Good Deals DCC](#)

[GLX Scale Models](#)

[Great Decals](#)

[HO Diesel Supply](#)

[Iowa Scaled Engineering](#)

[ITLA Scale Models](#)

[Ken Patterson.com](#)

[Lights 4 Models](#)

[Litchfield Station](#)

[Logic Rail Technologies](#)

[Main Street Heritage Models](#)

[Model Railroad Benchwork \(1\)](#)

[Model Railroad Benchwork \(2\)](#)

[Monster Modelworks](#)

[Motrak Models](#)

[Mountain Subdivision Hobbies](#)

[Model Railroad Control Systems](#)

[MRH Store \(1\)](#)

[MRH Store \(2\)](#)

[MRH Store \(3\)](#)

[MRH Store \(4\)](#)

[Mt. Albert Scale Lumber](#)

[NCE \(2 page spread\)](#)

[Nick & Nora Design](#)

[Norfolk & Western Hist. Society](#)

[North American Railcar Co.](#)

[North Texas Council of Railroad Clubs](#)

[Oak Hill MRR Track Supply](#)

[Pre-Size Model Specialities](#)

[Precision Design Co.](#)

[Rapido \(1\)](#)

[Rapido \(2\)](#)

[Ring Engineering \(1\)](#)

[Ring Engineering \(2\)](#)

[Rulers-of-the-World](#)

[Rusty Stumps](#)

[Scale Trains](#)

[Scotty Mason Show](#)

[Select Model Railroads](#)



# Clickable advertiser index – 2

[Streamlined Backshop Services](#)

[Soundtraxx \(Blackstone\)](#)

[Southern Digital](#)

[TAM Industries](#)

[TAM Valley Depot](#)

[Tony's Train Exchange](#)

[Train Control Systems](#)

[TrainMasters TV \(1\)](#)

[TrainMasters TV \(2\)](#)

[TrainMasters TV \(3\)](#)

[TrainMasters TV \(4\)](#)

[Traintek](#)

[TSG Multimedia](#)

[Westerfield Models](#)

[Yankee Dabbler](#)

[Yarmouth Model Works](#)

# Clickable “other” index

---

[Other – Cover](#)

[Other – Derailments](#)

[Other – Hobby Marketplace](#)

[Other – MRH Sponsors](#)

[Other – Contents](#)

## DOWNLOAD ISSUE



DOWNLOAD PORTRAIT



DOWNLOAD LANDSCAPE

• INDEX



SUBSCRIBE  
(free)

• TABLE OF CONTENTS



# REVERSE RUNNING

commentary

JOE BRUGGER  
.....



[Click here to rate or comment on this article](#)

## A MATTER OF PERSPECTIVE



**GETTING AWAY FROM** the home layout and mixing with other modelers – and their railroads – can be pretty darn educational.

Back in September, I went to the Great Basin Getaway in Utah. This was my third visit to this operating weekend and I have gotten to know some of the regulars.

My expectations were kind of mixed. Four of the layouts were known quantities, and I knew a little about some of the three layouts added to the line-up this year. The way it works: send in your name and the organizers assign you to a different operating layout on each of the three days – their choices are based on who-knows-what factors. A late-developing opportunity let friends and I run a fourth session one evening at another layout.

What did I learn?

▶ **STEPPING OUTSIDE THE BOX WITH A CONTRARY VIEW**

**Eye opener #1:** It's possible to run serious operations on an N scale layout and enjoy them. Not all HO people know this. Our evening session was on a very well scenicked Milwaukee Road layout set in North Idaho's timber country, with lots of nice mainline running and a couple of well-designed switching areas. The engines ran smoothly, the couplers worked fairly well, and it was a new experience handling a much longer train than my club's 30x60 layout runs.

Me: "We sure have been up here knocking cars around for a while."

Rick: "Well, there's 37 of them in the train."

**Eye opener #2:** After a night working with N scale, we rolled into a nice HO layout the following morning. Boy, everything looked huge, as if we'd wandered into an S scale operation by mistake. Trains seemed too short. Towns were too close together. Buildings looked too small, with a couple of freight cars spanning the length of the buildings. Trees seemed stubby. Hmmmm.

**Eye opener #3:** My third assignment was to a Cajon Pass layout that I've operated on twice before. It's a TT&TO layout with absolutely perfect scenery. The owner is a former military and commercial pilot – now a professional photographer – and this shows in his grasp of California scenery. But how excited can you get about running trains up and down a hill? Isn't operating about switching cars?

So, instead of taking a pool assignment, I raised my hand for one of two jobs on the west side of San Bernardino, at the bottom of the hill. My work partner had run the job before, and quickly got me lined up on the routine of anticipating traffic on the line-up. We made pulls, added some blocks, moved reefers from icing and cooling tracks into the ready tracks, switched some local spots, added and pulled helpers ... a day I had been kind of dreading went by pretty quickly and was a lot of fun.

The next time you have a chance to get out of your own little box – to experience a different scale, a different way of operating, a prototype that's been kind of off your radar, or work with different people – just jump right in!





# DERAILMENTS

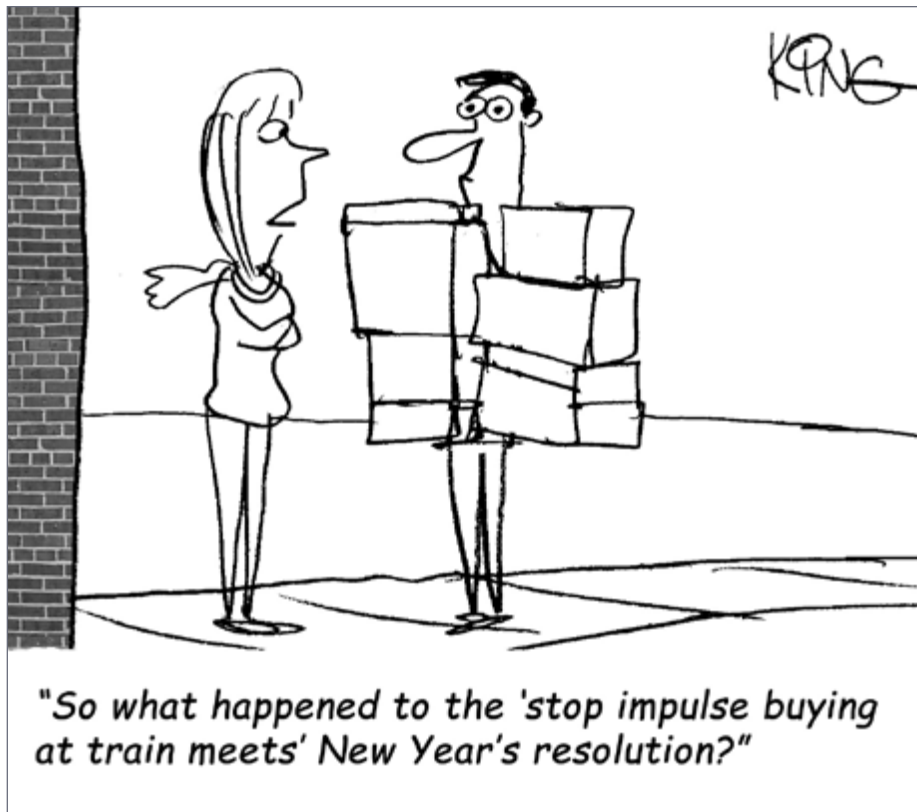

Jerry King

“What can be more palpably absurd than the prospect held out of locomotives travelling twice as fast as stagecoaches?”

*The Quarterly Review, England, 1825*

► BIZARRE FACTS AND HUMOR (SUPPOSEDLY)

# A SERIOUS MODEL RAILROAD CUSTOMER

The owner of a local hobby shop was awakened by one of his best customers phoning about what time the store opened.

“Ten AM,” he replied, “But why are you calling me in the middle of the night?”

“Not until ten AM?” the customer echoed, clearly disappointed.

“Why, what time would you like to get in?” The owner asked.

“I don’t want to get in,” the customer moaned, “I want to get out!” ■

.....

 **GET PAID ...**

If you're the first to submit a bit of good humor or bizarre facts and we use it, it's worth \$25! Just send to [derailments@mrhmag.com](mailto:derailments@mrhmag.com) ■

.....

## Coming next issue ...

- Modeling realistic weeds along the right-of-way
- Turnout building tips
- DCC with Arduino
- Working ditch lights!
- Modeling N scale in modular
- And lots, *lots* more!

 **Click here to rate or comment on this article**

