

# MRH

MODEL RAILROAD HOBBYIST

**ALSO:**

- Freight car roofs of the 20th century
- Build a coal tipple craftsman kit
- Modeling a Missouri town
- Ultra-tiny lights with fiber optics
- Tortoise mounting made easy

*... and lots more inside!*

**Geoff Bunza's**

**Arduino tutorial for  
model railroaders » [READ NOW](#)**





# GOT TRACK?

*(Don't let your fun get stopped short...)*

## ATLAS HAS PLENTY!

### N SCALE TRACK



N Code 80



N Code 55

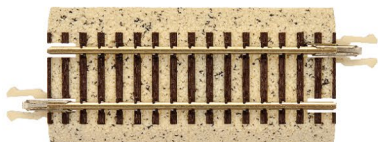

N True-Track®

### H0 SCALE TRACK



H0 True-Track®



H0 Code 83



H0 Code 100

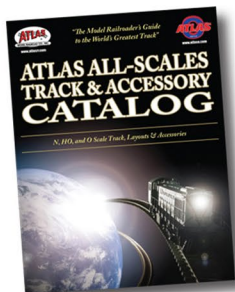

**FIND A  
DEALER NOW!**

For more information visit  
[www.atlasrr.com](http://www.atlasrr.com), or call  
 1-800-872-2521 and request an  
 Atlas All Scales Track and  
 Accessory Catalog.





# STAFF CREDITS

**Front cover:** This time Dr. Geoff Bunza provides us non-techie model railroaders with a practical introduction to all the cool stuff you can do on your layout with an Arduino.



ISSN 2152-7423

## Editorial Staff

Joe D. Fugate, Publisher and Editor  
Don Hanley, Assistant Editor

## Production

Patty Fugate, Pasteup and Layout  
Joe Brugger, Copy Editing  
Mike Dodd, Copy Editing

## Technical Assistant

Jeff Shultz

## Advertising

Les Halmos, Account Manager  
Daniel Nava, Advertising Assistant  
Jean-François Delisle, Marketing Assistant

## Columnists

Richard Bale, News and events  
Jeff Shultz, News and events  
Les Halmos, Modular railroading  
Larry Smith, Narrow Gauge/Shortlines  
Bruce Petrarca, DCC  
Ken Patterson, Reporter at large

## Special Correspondents

Joe Brugger, Questions & answers  
Charlie Comstock, Contributing editor

Issue password: Dec2016

Published for the glory of God. [What's this?](#)



# MRH SPONSORS

## A - E



[acculites.com](http://acculites.com)



[americanlimitedmodels.com](http://americanlimitedmodels.com)



[railroadhobbyshow.com](http://railroadhobbyshow.com)



[anemodel.com](http://anemodel.com)



[archertransfers.com](http://archertransfers.com)



[athearn.com](http://athearn.com)



[www.atlasrr.com](http://www.atlasrr.com)



[bachmanntrains.com](http://bachmanntrains.com)



[bachrus.com](http://bachrus.com)



[backdropjunction.com](http://backdropjunction.com)

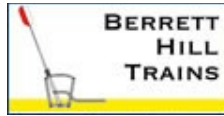

[berrethill.com/trains](http://berrethill.com/trains)



[blairline.com](http://blairline.com)



[bowser-trains.com](http://bowser-trains.com)



[coffmaneng.com](http://coffmaneng.com)



[cvrco.com](http://cvrco.com)



[www.digitrax.com](http://www.digitrax.com)



[esu.eu/en](http://esu.eu/en)

[Vendors: Get your clickable logo here ...](#)

# MRH SPONSORS | 2

## F - R



[www.handlaidtrack.com](http://www.handlaidtrack.com)



[foxvalleymodels.com](http://foxvalleymodels.com)



[glxscalemodels.com](http://glxscalemodels.com)



[www.iascaled.com](http://www.iascaled.com)



[litchfieldstation.com](http://litchfieldstation.com)



[moloco.biz](http://moloco.biz)



[model-trains-video.com](http://model-trains-video.com)



[modelrectifier.com](http://modelrectifier.com)



[monstermodelworks.com](http://monstermodelworks.com)



[stores.ebay.com/Motrak-Models](http://stores.ebay.com/Motrak-Models)



[mtalbert.com](http://mtalbert.com)



[ncedcc.com](http://ncedcc.com)



[nickandnoradesigns.com](http://nickandnoradesigns.com)



[nwhs.org](http://nwhs.org)



[www.pwrs.ca/main.php](http://www.pwrs.ca/main.php)



[railmasterhobbies.com](http://railmasterhobbies.com)



[rapidotrains.com](http://rapidotrains.com)



[ringengineering.com](http://ringengineering.com)



[rustystumps.com](http://rustystumps.com)

[Vendors: Get your clickable logo here ...](#)

# MRH SPONSORS | 3

## S - Z



[sanjuancarco.com](http://sanjuancarco.com)



[scaletrains.com](http://scaletrains.com)



[selectmodelrailroads.com](http://selectmodelrailroads.com)



[signaturepress.com](http://signaturepress.com)



[soundtraxx.com](http://soundtraxx.com)



[sodigi.com](http://sodigi.com)



[sbs4dcc.com](http://sbs4dcc.com)



[tamvalleydepot.com](http://tamvalleydepot.com)



[sbs4dcc.com](http://sbs4dcc.com)



[tonystrains.com](http://tonystrains.com)



[trainmastermodels.com](http://trainmastermodels.com)



[traintekllc.com](http://traintekllc.com)



[tsgmultimedia.com](http://tsgmultimedia.com)



[tsgmultimedia.com](http://tsgmultimedia.com)



[yankeedabblers.com](http://yankeedabblers.com)

[Vendors: Get your clickable logo here ...](#)

Looking for something? Check the MRH Marketplace!

Take me there!

**FILL**  
**YOUR STOCKING**

**KIT CLASSICS**

**HO BOXCARS**

**\$9.99**

In Stock Only



Order Now at [www.ScaleTrains.com](http://www.ScaleTrains.com) and at Participating Select Retailers

\*In stock only. Available at [www.ScaleTrains.com](http://www.ScaleTrains.com) and participating Select Retailers. Offer ends 12/31/16 or while supplies last. Not applicable to prior sales. Visit our website for complete details.

www.ScaleTrains.com  
Not actual size. Product is HO Scale

**RIVET COUNTER**

**HO TANK CARS AT**

**OPERATOR PRICES!**



Order Now at [www.ScaleTrains.com](http://www.ScaleTrains.com) and at Participating Select Retailers

Scene and photography by Ken J Johnson  
First test model shown

\*In stock only. Available at [www.ScaleTrains.com](http://www.ScaleTrains.com) and participating Select Retailers. Offer ends 12/31/16 or while supplies last. Not applicable to prior sales. Visit our website for complete details.

www.ScaleTrains.com

© 2016 ScaleTrains.com, Inc. ScaleTrains.com Kit Classics, Rivet Counter and respective logos are trademarks of ScaleTrains.com, Inc. ScaleTrains.com, Inc. 7598 Highway 411 Benton, TN 37307 844-9TRAINS 844-987-2467 International 423-299-3689

• INDEX

• TABLE OF CONTENTS



# TABLE OF CONTENTS

## FEATURES

### Modeler's introduction to Arduinos

*DR. GEOFF BUNZA*

Add lights, sound, and movement to your scenery

---



### Building the BTS coal tippie

*WALT KAHRES*

Follow along on this craftsman kit build

---



### Freight car roofs of the 20th century

*RICHARD BALE*

Railcar designers pursue the perfect car top

---



### Modeling crushed rock gravel loads

*JOE BRUGGER*

How to make better gravel loads for your layout

---



### Ultra-tiny lights with fiber optics

*WAGNER CIONGOLI*

Using inexpensive fiber optics for super-small lights

---

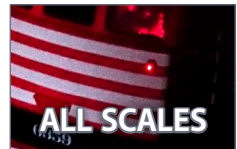

**ALSO:** MRH Marketplace | Subscriber extras



## TABLE OF CONTENTS | 2

### COLUMNS

**MRH Q-A-T: Cleaning track, mounting Tortoises**

*compiled by JOE BRUGGER*

**DCC Impulses: Digitrax Evolution first look**

*BRUCE PETRARCA*

**Getting Real: Modeling Grandview, Missouri**

*NICK MUFF*

**What's Neat: Christmas pictures, car loads, ...**

*KEN PATTERSON*

**Photo feature: Merry Christmas from MRH**

*compiled by DON HANLEY*

**First Look: Firecat Designs log cars**

*JEFF SHULTZ*

**Derailments: Bizarre facts & humor**

*compiled by the MRH STAFF*

### NEWS and EDITORIAL

**Publisher's Musings: Submitted your layout design?**

*JOE FUGATE*

**News & Events: December 2016**

*RICHARD BALE & JEFF SHULTZ*

**Reverse Running: Who needs models?**

*DON HANLEY*

# MRH SECOND ANNUAL "ONE MODULE" CHALLENGE CONTEST

**ENTRY DEADLINE: January 31, 2017**

**Goal: Design the first "module section" for a sectional home layout design.**

Hypothetical room is 10' x 14' – 2'x8' closet can be used; window can be covered.

*Note: This is a sectional home layout design, no modular standard required.*

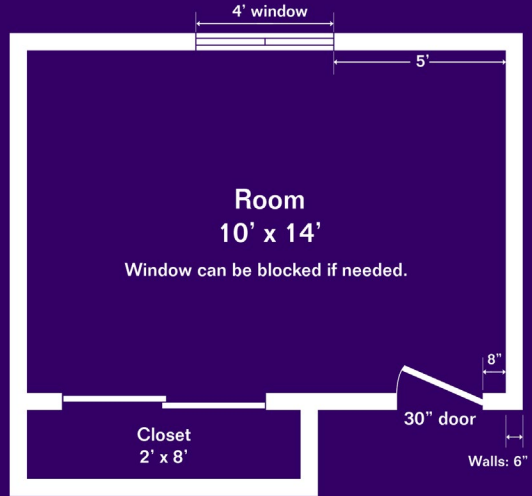

## CONTEST RULES

- Modules can be any size or shape but must fit through the room door (7'-6" tall and 30" wide) without damage or pinching your fingers. Plan can have any number of modules.
- Scale: From Z to O, using any track gauge combination.
- Module section must connect to a temporary staging yard module on at least one end. A staging yard must have at least three yard tracks.
- Rough in the outlines of any other layout module sections to be built for the entire room. No track plan required, just an outline of the modules in the room is sufficient. Bonus points awarded for [showing a module construction progress plan](#).
- Modules can follow a standard or not. Custom sections are okay.
- Module support method / height up to you, but please describe.
- Innovative approaches get extra points: please describe and illustrate if possible.
- Include a cost estimate for the module. There is no need to actually build anything, this is a design contest only. Do be as comprehensive as possible in the cost estimate: the hypothetical goal is a completely finished, operational module.
- The best submissions will be published, so extra points are awarded for quality text, illustrations, photos and captions. Winners get a bonus payment rate.

**SUBMIT ENTRY (Choose "Contest Entry")**



# PUBLISHER'S MUSINGS

editorial

JOE FUGATE



[Click here for  
reader comments](#)

## SUBMITTED YOUR LAYOUT DESIGN ENTRY?

**WE HAVE DONE LAYOUT DESIGN CONTESTS** now for the last several years, with the latest being our second annual “One module challenge contest.” Just so you don’t miss the contest, we’ve posted the rules and deadline to the left of this editorial!

One big reason we do these contests is to get good layout designs for smaller layouts. A common complaint about model railroading publishers is that we focus mainly on basement empires and don’t give small layouts much air time.

Well, as we often say, we can only publish what gets submitted. You can’t rely on the MRH Staff to research and write everything. We need you, our readers, to help fill these pages!

If you truly feel we need to publish more small layout plans, here is your chance to actually prove you mean it. Participate in this contest by sending in a design. You only have a couple months left ...

Winners get their entry published and are paid a premium payment rate, plus a bonus. Winners can expect \$500 - \$1000 for each winning entry! Does *that* motivate you? Could your hobby finances use a good shot in the arm? Sharpen your pencil and enter the contest!

## Win \$250 in our new subscriber sweepstakes

Are you an MRH Subscriber yet?

During the months of December and January, we're placing all new subscriber emails in a hat and doing a sweepstakes drawing. The winner gets \$250. That's right two hundred fifty smackers.

Subscribing benefits both you and us. For you, you get a weekly email with tips, new product announcements, reminders about each MRH issue, and links to some great reader-posted content.

Some of these reader posts rival magazine articles as to the quality of the insight given, so it's almost like getting a weekly mini-magazine from us. All completely free: [subscribe now](#).

ADVERTISEMENT

*Imaginehat!*  
Laser Art Products

## ITLA Scale Models

*Precision Laser  
Cut Wood Products*

*Cooper's Alley  
HO Scale Laser  
Cut Wood Kit*

CLICK HERE FOR MORE INFORMATION  
[www.itlascalemodels.com](http://www.itlascalemodels.com)

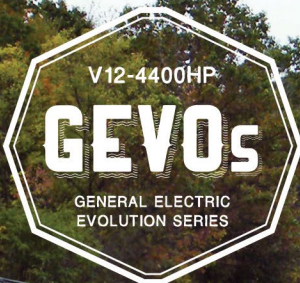

©Matt Gentry Photo

## THE NEXT STEP IN THE EVOLUTION

### NEW MODEL ES44DC DEBUTING AT MILWAUKEE TRAINFEST 2016

The ES44DC and ES44AC, commonly called GEVOs for General Electric Evolution series, were designed to meet the strict diesel locomotive emissions standards imposed by the EPA Tier II regulations. The ES44DC and ES44AC external details have changed with almost every year's new orders. These models are of the early version produced in 2005 and 2006. Athearn® brings the ES44DC to life in Genesis®, "As close to real as it gets" with Tsunami2 sound by SoundTraxx.

- Era: 2005 to present day
- New and Updated tooling
- Separately installed wire handrails and wire grab irons
- Fully assembled
- Etched metal fan grille
- Razor-sharp printing and painting
- McHenry® scale knuckle spring couplers
- Machined metal wheels
- Minimum radius: 18" recommended; 22"



DC style dynamic brake grilles spaced apart.



High headlight variant with optional PTC antenna array or antenna dome.



Separately-applied plumbing and traction motor cables.

VISIT [ATHEARN.COM](http://ATHEARN.COM) FOR COMPLETE LISTING OF ROADNAMES AND PRICING

**HORIZON**  
H O B B Y

VISIT  
Your Local Retailer

CLICK  
Athearn.com

CALL  
1.800.338.4639

SERIOUS FUN™

©2016 Horizon Hobby, LLC. Athearn, Genesis and McHenry are registered trademarks of Horizon Hobby, LLC. All other trademarks, service marks and logos are property of their respective owners. Final models may vary slightly from photos shown. 54364



**CRAFTSMAN  
KITS**



Our instruction manuals are second to none!  
**CHECK IT ALL OUT AT**  
**WWW.RUSTYSTUMPS.COM**  
 THE QUALITY IS INSIDE BECAUSE OUR NAME IS OUTSIDE

## *Select* MODEL RAILROADS

**Design & Build Services  
For Discriminating Modelers**



**CLICK HERE FOR OUR WEBSITE**  
[www.SelectModelRailroads.com](http://www.SelectModelRailroads.com)

**(844) 872-4670**

## **PUBLISHER'S MUSINGS | 3**

Do remember we're ad-supported, so you will also get a couple extra emails from us with product announcements. These emails always come from us. We never ever give out your email to anyone.

Three or four times per year we also run a multi-day sale and during those times we send daily emails for three or four days straight. But for those special cases, we now give you the option to opt out and tell us "no more emails please" on this particular sale.

Subscribing is a big benefit to MRH, because potential advertisers look at that number to determine if they're going to advertise with us. The more subscribers, the more likely they are to become an advertiser and help fund MRH for you.

If you've ever wanted to say thanks to us for all the great free model railroading info in MRH, then **become a subscriber**. And right now, there may be \$250 in it for you as well!

# THE STAR OF YOUR CHRISTMAS GIFT LIST

## Our First Train Set with an E-Z App®-Equipped Steam Locomotive!

Enjoy wireless touch-screen control of the E-Z App®-equipped *Blue Star* train set through your smart device.\* The *Blue Star* features an E-Z App®-equipped Alco 2-6-0 steam locomotive, three old-time cars, and 56" x 38" oval of snap-fit nickel silver E-Z Track®. This is one star you will want to find *under* your tree this Christmas!



**NEW**

*Blue Star* Train Set with E-Z App® Train Control  
Item No. 01502 • MSRP \$349.00  
Shipping Soon!

Click to  
learn more.

Features of E-Z App® Touch-Screen Train Control include:

- \* wireless control with any Android™ device (running Android™ 4.3 or newer) or Bluetooth® 4-supported iPhone®, iPad®, or iOS device (includes iPhone® 4s, 5, 5c, 5s, 6, and 6 Plus; iPad Air® and iPad mini™, 3rd and 4th generations; and iPod touch® 5 or newer)
- operates from up to 100 feet away with Bluetooth® Smart technology
- realistic, dynamic engine sound broadcast through your smart device
- requires 16 volt DC or DCC track power for operation
- ready to launch and use instantly after downloading the FREE Bachmann E-Z App® from the Apple App Store™ or Google Play™ store.
- no configuration or additional equipment required



Click to  
watch video.



**FREE CHRISTMAS E-Z APP® BONUS:**  
**SYNCHRONIZED TRAIN SEQUENCES WITH THREE HOLIDAY SONGS!**

Available with the free E-Z App® download is special-edition programming that allows your E-Z App®-equipped trains to operate in time to classic holiday songs. Just touch the Christmas tree icon and enjoy the holiday magic!



Click to  
learn more.

*Blue Lightning* Train Set with E-Z App® Train Control  
Item No. 01501 • MSRP \$299.00  
Shipping Now!

The *Blue Lightning* train set features an E-Z App®-equipped diesel and three freight cars.



Bachmann Industries, Inc. • 1400 East Eric Avenue • Philadelphia, PA 19124 USA • [www.bachmanntrains.com](http://www.bachmanntrains.com)

Click to learn more.

• INDEX

• TABLE OF CONTENTS



## Walt Disney and his love of trains

Here's a fun holiday tidbit about Walt Disney and his trains.

The Walt Disney Family Museum is excited to introduce its newest holiday tradition: *Home for the Holidays at Carolwood*, an immersive seasonal installation celebrating Walt's family and love of trains, on view from November 17, 2016 to January 9, 2017.

The installation includes an elaborate three-dimensional model of the Disney Family home on Carolwood Drive in Holmby Hills, Los Angeles – including Walt's personal steam locomotive, the *Lilly Belle*, chugging along his Carolwood Pacific Fair Weather Route.

The intricate scale model will be on view for the entire duration of the installation, however it will be decorated with seasonal lights ceremonially ignited on Walt's birthday, December 5. Beginning December 7, the museum will invite one lucky family to be the first to flip the switch each morning following.

For more, see: [waltdisney.com/HomeHolidays](http://waltdisney.com/HomeHolidays)

Looks like a lot of holiday fun!



[Click here for reader comments](#)

*Publisher's Musings continue on the next page with some additional notes ...*



# SO. MANY. DETAILS!



# ERIE FA-2

## MRH 2016 Survey, favorite era

Here is the favorite era of our readers from our recently concluded 2016 reader survey. The statistical validity is +/- 2.5% with a 95% certainty.

### MRH 2016 Reader Survey: What is your favorite era?

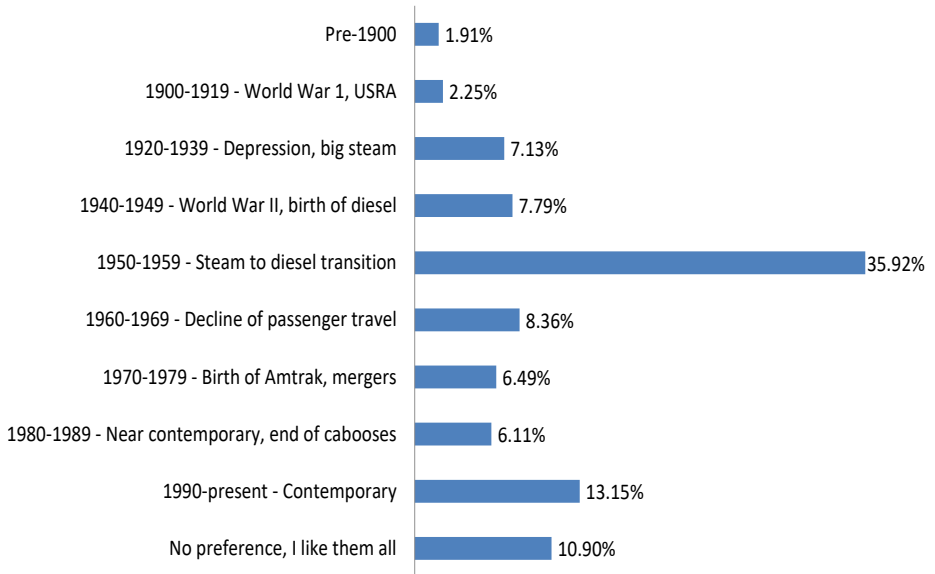

From this feedback, we can draw some interesting conclusions about what era of material our readers like. Keep in mind the *no preference* category means we can add that number to any era in the list! For example, 46.8% of our readers (almost half) like steam-to-diesel era articles and videos.

But from this we can also see:

- Readers who like articles on diesels ( from 1950 on): 81%
- Readers who like articles on steamers ( from 1959 back): 66%
- Readers who like non-roofwalk car modeling ( from 1980 on): 30%

Steam-to-diesel continues to be the single most popular era, by a long shot. especially when you include the “I like them all” group too. ■

# YOU DON'T HAVE TO BUILD IT...

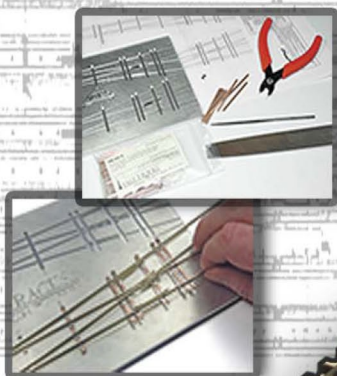

# YOU GET TO BUILD IT!

With track building tools  
and supplies from...



Visit [HANDLAIDTRACK.COM](http://HANDLAIDTRACK.COM) and start today!

• INDEX

• TABLE OF CONTENTS



# LAST ISSUE'S RATINGS

The five top-rated articles in the [November 2016 issue](#) of *Model Railroad Hobbyist* are:

- 4.8 Getting Real: Building Bagby Hotel
- 4.8 Special supplement: Easy Real Railroads how-to
- 4.7 Kitbash a Southern Pacific SW900E switcher
- 4.7 2016 National Narrow Gauge Convention highlights
- 4.6 What's Neat: Michael Gross interview, shaking paint ...

Issue overall: **4.6**

**Please rate the articles!** Click the reader comments button on each article and select the star rating you think each article deserves. Thanks! ■

## ADVERTISEMENT

### Checked us out lately?

- ✓ HO/N and now O scale products too!
- ✓ Laser-cut Structures & Bridges.
- ✓ Advertising & Storefront Signs.
- ✓ Highway Signs, vintage & modern.
- ✓ New Detail Items.
- ✓ Laser-cut Grade Crossings.
- ✓ Billboards, roadside & rooftop.
- ✓ Laser-cut Graffiti Decals
- ✓ 1000's of satisfied customers.



Established 1993...  
**Blair Line**

## ADVERTISEMENT



Con-Cor is re-running all the "HO" Steam era P-54 Penny Cars in Early 2017 (last run was 2010), Limited Quantities!

HO - P-54 Penny Cars - Pre-Order NOW!



So place your Pre-Order today for full selection. Also other road names that owned P-54 cars. New Paint Schemes!

2016 Donner Reindeer Car (Thunder)



"HO" 0001-00016H \$28.98 + S/H  
Kit with working Knuckle Couplers

"N" 0001-00016N \$28.98 + S/H  
R.T.R with Micro-Trains Couplers

Order at  
www.Con-Cor.com/Website  
or by eMail at Orders@con-cor.com

Make your reservations for the **WALTHERS** MAKING RAILROAD HISTORY **PROTO.**

**SANTA FE 1956**

**SUPER CHIEF**

*Now with Blunt-End Vista series Observation!*

Click here  
to see the  
complete  
train!

No other train could match Santa Fe's *Super Chief* for speed and luxury. Roaring between Chicago and Los Angeles daily its exclusive clientele enjoyed every amenity of a fine hotel, from spacious, private sleeping rooms, to cooked-to-order gourmet dining. Make your HO layout part of the legend with this authentic Walther's Proto 8-car consist – including the never-before available Blunt-End *Vista* series 4-1 Sleeper-Lounge-Observation – and matching 300-Class F7s in traditional Warbonnet® colors.

### Santa Fe 300-Class F7 Diesels



### Santa Fe 1956 *Super Chief* Passenger Cars



**First car arrives in June 2017 - reserve now!**

**WALTHERS**

Support your local hobby shop • visit [walthers.com](http://walthers.com) • call 1-800-4-TRAINS

Prices and delivery dates shown were accurate at press time, for updates please visit [walthers.com](http://walthers.com). Photos show preproduction models for illustration purposes only, some colors and details may vary. ©2016 Wm. K. Walther's, Inc.

• INDEX

• TABLE OF CONTENTS

Make it run like a

# Dream TRACKWORK BOOK

104 pages

By Joe Fugate

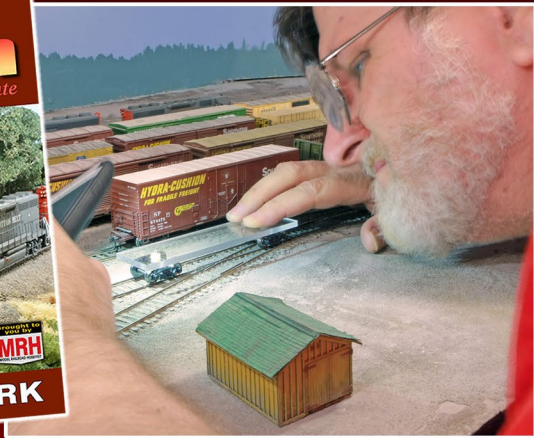
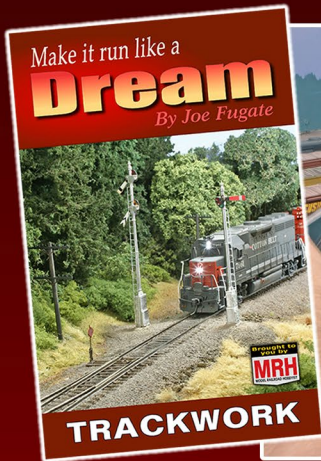

"The new bible of track laying." - *L.T.*

"Chapter 3 alone is worth the cover price." - *B.M.*

"A *lot* of info ... copiously illustrated.." - *J.A.*

Click me to  
**GET eBook NOW >>**

~~\$12.99~~ **\$11.99**

Click me to  
**ORDER PAPERBACK >>**

~~\$29.99~~ **\$27.99 + S&H**

Available from the MRH Store: [store.mrhmag.com](http://store.mrhmag.com)

Other books coming in this series: *ROLLING STOCK* (Mar 2017) and *LOCOS* (Sep 2017)

• INDEX

• TABLE OF CONTENTS



# MRH Q-A-T

column

*compiled by*  
**JOE BRUGGER**  
.....



[Click here for  
reader comments](#)

## QUESTIONS AND ANSWERS

### Cleaning track – again

**Q.** I don't run my trains on a regular basis as I would like. When I do get out to the HO layout in my garage, I spend a lot of time cleaning my track, and then must clean the wheels on my locos just so I can get them to run. After about 30 minutes of frustration, because my loco stalls constantly, I usually give up. Cleaning with alcohol seems temporary, and mineral spirits seem a little better. I do have graphite sticks but have not used them much because I can never keep my track clean enough for it to be effective. I sure could use some advice. Thank you.

—Chuck

**A.** Getting track clean isn't that difficult. Keeping it clean can be a horribly frustrating chore. Various track cleaning cars on the market are real timesavers. A proven approach is to use a cleaning train consisting of a Masonite slider car [1] to knock

▶ MRH QUESTIONS, ANSWERS, AND TIPS

## MRH Q-A-T | 2

dust off the rails, a “wet” cleaner like the CMX Clean Machine, and a Centerline roller car to pick up solvent residue. CMX and Centerline products are made for several modeling scales.

Keeping a train-room dust-free and minimizing temperature and humidity swings can also make big difference. Rig up a cover for a layout in a dirty environment like a garage so it’s protected when not being used.

Treatments to keep track clean are either wet or dry, and which is best seems to vary with the situation.



1. Masonite sliders do a good job of knocking dust and oxidation off railheads, but manual touch-up work is often needed on frogs, switch frogs, rerailers, and at grade crossings. *Joe Brugger photo*



## MRH Q-A-T | 3

Graphite is gaining popularity as an efficient dry treatment – clean the track with a solvent, wipe it dry, and apply short streaks of graphite at intervals. Use a washed lint-free cotton cloth or a commercial track cleaning car to clean the rail. Take care to not snag switch points and lineside scenery.

Not much graphite is needed, maybe a two-inch streak on each rail every 20 or 30 feet. Trains will spread the graphite film around.

Art supply stores sell pure graphite pencils for less than \$2 each. One will last a long time, and they are also handy for lubricating rail car trucks and couplers. Cretacolor and General are two good brands. Look for pencils with a lacquered core – they won't shed graphite all over your fingers. 4H is a good hardness to try first. Graphite pencils do not contain clay or other binders used in school and carpenter's pencils.

### ADVERTISEMENT



**1<sup>st</sup> choice for model railway supplies and service.**

**Expedited mail service available across North America.**

Click to visit:  
**WWW.CVRCO.COM**  
**1 800 464 1730**



## MRH Q-A-T | 4

People also report good results with No-Ox, an anti-oxidant paste that is wiped onto the rail with a cloth and then buffed.

Straight-sided cylindrical bottle corks are good cheap tools for rubbing away black gunk, and won't scratch the rails. Walthers, Cratex, Micro Engineering, Peco and other companies sell rubbery blocks for cleaning rails by hand.

Wet treatments include mineral spirits, Wahl Clipper Oil, CRC 2-26 contact cleaner, and Rail-Zip. The CMX brass tank car cleaner should be set to a slow drip rate, just enough to keep the cleaning pad damp. Comprehensive instructions are included with the car. In a dusty environment, "wet" track will collect dust and grit.



2. An N scale tram system is a major test of track maintenance – rails are buried in pavement, and the lightweight rolling stock has short wheelbases and small wheels.  
*Metrolink photo*

## MRH Q-A-T | 5

Here are some reader experiences:

**traintalk (Bill):** If you put 10 model railroaders in a room and ask them for the best way to clean track, you will get 20+ different answers.

Everyone has their own recipe. Here is mine: Our large club is in a dusty commercial basement. We use the CMX Clean Machine tank car with artists Turpenoid. Turpenoid is odorless. It is a quick cleaner, does not leave a residue, and evaporates quickly.

We put some Turpenoid in the CMX tank car and adjust to a slow drip on the pad and push the car around the layout at a slow speed.

**Metrolink:** I have a Kato Unitram layout [2]. My layout is in the garage also. My Unitrack seems to get full of carbon even though I run my Kato Portrams on it regularly. I've been cleaning my track with 70% isopropyl alcohol swabs from CVS. Tonight, after

### Combo Right Clamp™

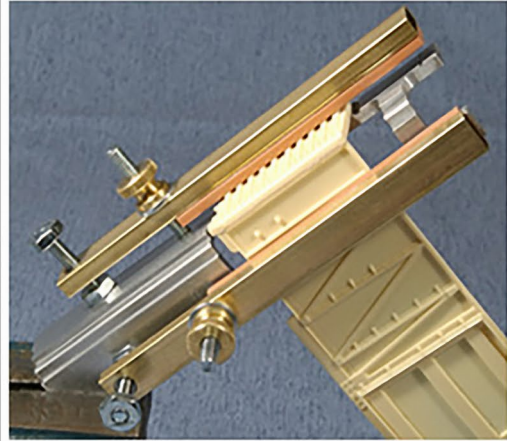

Combo Right Clamp™  
with cast resin boxcar

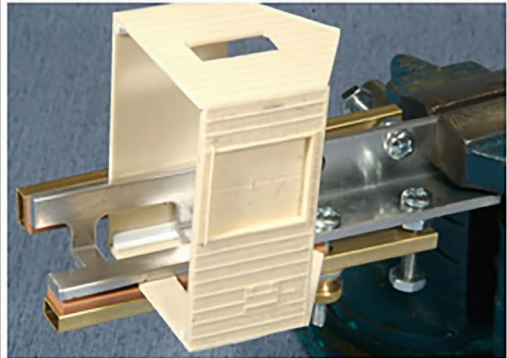

Combo Right Clamp™  
with Wolf Design Pump House

[Click here for  
all our products ...](#)

**Tools for Modelers**

Coffman Graphic Solutions Co.  
1500 River Circle, Richmond,  
KY 40475-7907

about a week of non-operation, I turned on my train and it ran slowly. So I cleaned the track with an alcohol swab – still slow. I ran a carpenter’s pencil down the track – voila!

I mention this because I have this track-cleaning problem with my Unitram track that I never had with my standard Kato Unitrack. I live near the beach so there’s often a heavy marine layer at night contributing to high humidity. My Portrams are especially sensitive to dirty track because they have very small wheels and are very light. I may try to apply an anti-oxidizing agent to the track to prevent this from occurring so frequently.

**Jim at BSME:** If oxidation is your problem, I would recommend cleaning with a Bright Boy, using a cloth and alcohol to remove any particulates, and then try graphite to inhibit oxidation. I’ll admit I have not used graphite to see if it helps. I like CRC 2-26 electronics cleaner/lubricant, but too much will cause wheel slip. Another product that prevents oxidation is No-Ox. There is a thread at [mrhmag.com/node/7169](http://mrhmag.com/node/7169). No-Ox is wiped onto the rail and then polished.

**Rich S.:** Can your layout be covered with a piece of plastic when not in use, to help keep off dust and dirt? In conditions like yours, I would thoroughly clean the rails with a Bright Boy or Cratex cleaning block, then place a drop of Rail Zip on each rail and run the train around the layout to distribute the Rail Zip. The next time you run your trains, you should not have to clean the rails.

If you have a track cleaning car, place it in your train and let it do the work. Before shutting down for the day, remove the track cleaning car from your train, add a drop of Rail Zip to each rail and run the train for a few more laps. Then cover the layout if you can.

Read more and share your track-cleaning tips at [mrhmag.com/node/28098](http://mrhmag.com/node/28098). See the cleaning car at: [centerline-products.com/news.html](http://centerline-products.com/news.html).

CRC 2-26 at [crcindustries.com/ei/product\\_detail.aspx?id=02005](http://crcindustries.com/ei/product_detail.aspx?id=02005) at Home Depot and hardware stores.

No-Ox [sanchem.com/electrical-contact-lubricant.html](http://sanchem.com/electrical-contact-lubricant.html) at model railroad shops and electrical supply houses.

## TIPS

### Mount and align Tortoise switch machines

I use extruded foam insulation board for my layout sub-roadbed, and Tortoise by Circuitron switch machines to throw my switch points. I

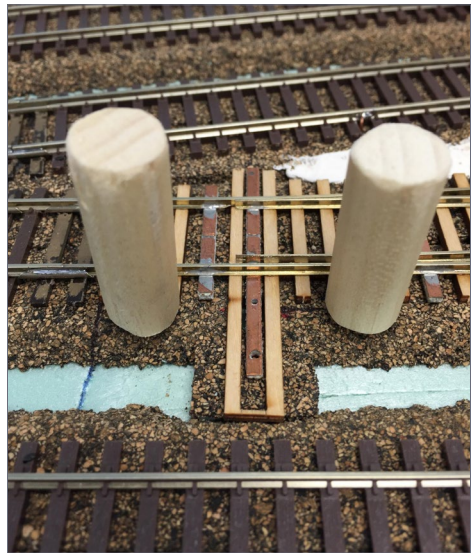
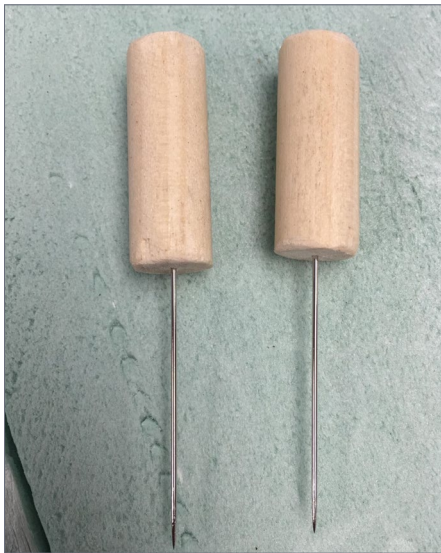

3-4. A pair of simple tools properly align a hardboard mounting pad under the nsulation foam layout. The tools are made by drilling a small hole in a pair of dowel rods and gluing a long needle in each. *Michael Anteau photos*

# MRH Q-A-T | 7

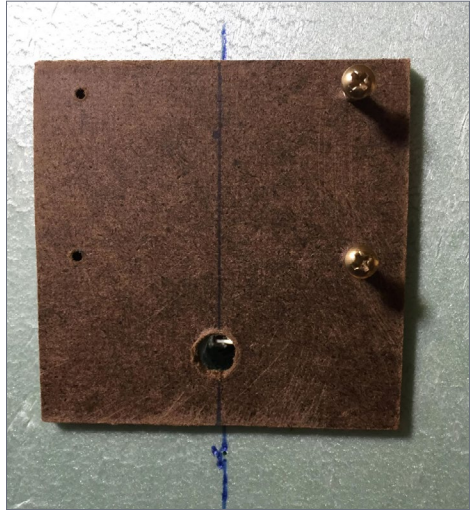
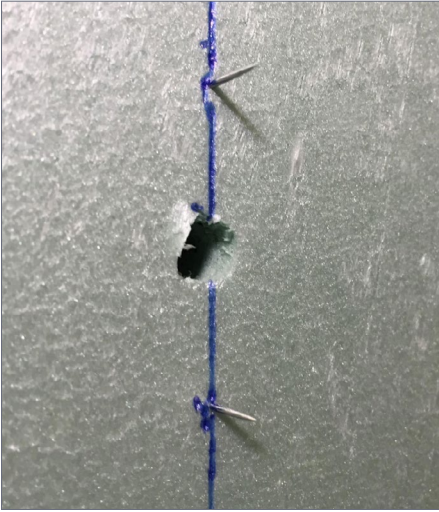

5-6. The needles must protrude through the bottom of the sub-roadbed. Place a small ruler against the needles under the layout and use a marker to draw the center line. Line up the mounting pad and hot-glue it in place.

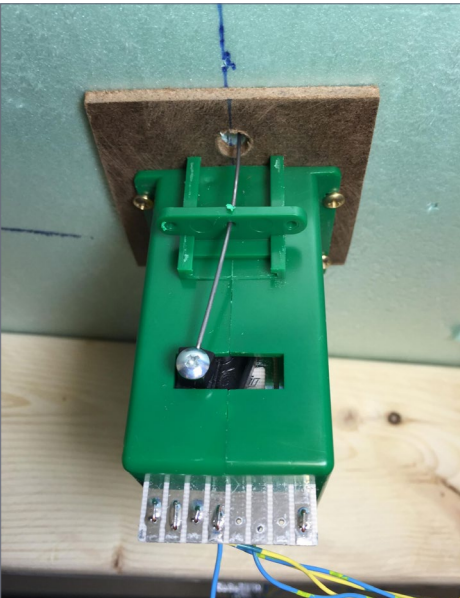

7. Pop the Tortoise in place, be sure the vertical throw bar goes through the switch rod hole, screw it down, and wire it up.

faced two challenges. How do I mount the machines on foam, and how do I properly align the machines under the layout?

To solve the first challenge, I cut small hardboard squares based on the drilling template that comes with the switch machines. I marked a center line on the square, then marked and drilled holes for the throw rod and the mounting screws.

To properly align this pad under the layout I made a pair of simple alignment tools. I drill a small hole in a pair of dowel rods and glue a long needle in each. The needles must be long enough to go completely through the foam panel.

To use them, I center the switch points and align the needles to the left and right of the switch throw bar in line with the hole through the sub-roadbed and parallel to the straight route of the switch. Push the needles down so they protruded through the bottom of the sub-roadbed. Then, place a small ruler against the needles under the layout and draw the center line with a marker.

To finish up the installation, hot-glove the mounting pad to the layout underside, aligning the hole for the actuating wire with the hole in the sub-roadbed, and the centerline on the pad with the center line on the layout. After the pad is fastened in place, I screw the switch machine to the pad.

I have used this method for several years and have yet to have an installation fail.

—Michael Anteau



[Click here for reader comments](#)



## GET PAID FOR YOUR TIP

We pay \$25 per tip we publish, or \$40 each if the tip also includes a photo or finished drawing. [Click here and select article type TIP.](#) ■



[Click here for reader comments](#)

### ADVERTISEMENT

## A great collection of insights on industrial switching!



Bill Kaufman's history of San Francisco's waterfront railroad, the State Belt, contains a rich collection of industrial information and photos. It's now back in print. How can I learn more about this book? How can I buy it?

[Click here for the answer ...](#)

*SIGNATURE PRESS*



HO GP60M, GP60B AND GP60 Locos



Now Available!



DC or DCC with Sound!



www.foxvalleymodels.com

**NICK & NORA DESIGNS**  
Uniquely inspired craftsman kits



Craftsman Structure Kits,  
Detail Parts, Shingles & More!  
www.nickandnoradesigns.com

# Great control in a tiny package



**Original  
Touch Toggles**

- Touch Toggle™ plug in controls
- Bright clear indication
- Easy setup
- Flexible system

Stall Motors, Twin-coils,  
Power, and Servos

Now for Tam Valley Depot  
and MRservo too!



**BERRETT  
HILL  
TRAINS**

Made in the USA



What will they think of next?

www.berrethillshop.com



# Introducing

Complete Train Control

## *The next Evolution in* Complete Train Control®

- Premium Advanced 5/8 Amp Starter Sets.
- Starter sets are available as standard tethered or duplex radio.
- The system features a DCS210 Advanced Command Station, DT500 series throttle, and includes a power supply to make getting started easier than ever.
- The DT500 series throttles can be purchased separately from the new Starter Set.

Find out more @ [www.digitrax.com](http://www.digitrax.com)



E  
St  
DT  
PS  
  
E  
D  
DT  
PS

# the **EVOLUTION**™



## **Evolution (shown) | \$450 MSRP**

**Standard Set Includes: DCS210 Advanced Command Station, T500 Advanced Super Throttle, UP5 Universal Panel, 6615 power supply, and a LT1 LocoNet Tester.**

## **Evolution Duplex | \$660 MSRP**

**Duplex Set Includes: DCS210 Advanced Command Station, T500D Advanced Duplex Throttle, UR92 Universal Panel, 6615 power supply, and a LT1 LocoNet Tester.**

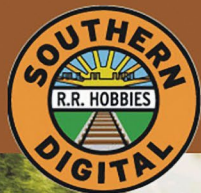

# Southern Digital



**20% Discount  
on most items!**

*Specializing in DCC Since 1992*



## DCC Conversions, Service & Support

Orders Received by 3:00 pm EST ship the same day

**WWW.SODIGI.COM**

E-mail: [sales@sodigi.com](mailto:sales@sodigi.com)

(770) 929-1888

*(Photo's are from our N-Scale layout)*



# DCC IMPULSES

column

BRUCE PETRARCA MMR  
.....



[Click here for  
reader comments](#)

## FIRST LOOK AT THE DIGITRAX EVOLUTION DCC SYSTEM

**WELL, I'M BACK. AFTER LOSING MY FATHER** in October, family issues took priority over my column, so I missed writing for the November issue. Here we are heading into December and I'm back at the keyboard.

This year Digitrax made some fundamental changes in its flagship cabs and its DCC systems.

I reviewed the new top-of-the-line (DCS240) system box briefly in my September 2016 ([mrhmag.com/magazine/mrh2016-09-sep/dcc-impulses](http://mrhmag.com/magazine/mrh2016-09-sep/dcc-impulses)) column. This pricey box has a lot for big layouts: 400 cab capacity and a built-in computer USB interface.

In October, Digitrax announced a realignment of the Digitrax systems. The Zephyr Xtra (DCS51) system remains unchanged. The Empire Builder series of systems is discontinued, an event that I've been championing for about 15 years. Digitrax announced a new entry level 5-amp system, the Evolution [1], with a new

► DCC TIPS, TRICKS, AND TECHNIQUES

# DCC IMPULSES | 2

DT500 cab [2], and a new DCS210 system box for it [3].

The Evolution has an amazing MSRP of \$450 with a wired cab, or \$660 for the duplex radio version. These are currently translating to street prices of \$350 and \$500, respectively.

The series of new high-end DT500 cabs will replace the DT400 series. The latest versions of the DT402 (rev 2) can be upgraded in your own home to the functionality of the DT500.

These new products have newer microprocessors and other updated components compared to their predecessors. In addition to allowing new features and controlling prices, updated components help with the availability of repair parts.

Simplex radio items are gone from the new Digitrax sales brochure. Digitrax systems are now only available with duplex radio. Infrared wireless is offered for countries where the duplex radio format is not authorized.



1. Digitrax Evolution starter system was announced in October 2016. *Digitrax photo*

# TONY'S TRAIN XCHANGE

Committed to your DCC support!

Erik Claus  
and his trusty  
Tony's Reindeer



## ESU LokSound DCC Decoders

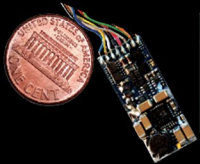

Use these two products together for awesome sound and incredible motor control in even the smallest HO and many N Scale Locomotives.

Accurate, Prototypical Sound & Superior Motor Control. Full Range of Select & V4.0 for N Scale through G Scale Starting at \$85.95

[Order Yours](#)

## TDS SuperSonic Mini Speakers



Incredibly Big, High Quality Sound, From Incredibly Small, High Quality Speakers. Don't Forget Enclosures!

\$5.95

[Order Yours](#)

## CMX Cleaner Car



Superior, All-Brass Build Quality, Super Easy To Use & Cleans Exceptionally Well!

N, HO, S, O, & G Scales

Starting at \$149.95

[View Videos](#)

Do you need a Sound or DCC Installation done?

[Get a quote!](#)



Providing unmatched person to person DCC support for more than 20 years, the kind of service that has made us #1 in DCC. **DCC questions? CALL US! 1-800-978-3472**

*We'll get you on the right track!*

Dec 2016



# DCC IMPULSES | 3



Digitrax supplied a new Evolution system for my evaluation. This column will be a quick look at the system. The hardware will then migrate to the Great Lakes Western ([mrh-mag.com/magazine/mrh2016-10-oct/great-lakes-western](http://mrh-mag.com/magazine/mrh2016-10-oct/great-lakes-western)) club layout for an extended evaluation. Fodder for a future column.

## Opening the box

At first look, the major difference between the Evolution and the predecessor Super Chief Xtra

2. The DT500 cab is part of the new Digitrax Evolution system.

ADVERTISEMENT

# TCS WOWSound

Come meet us at one of the upcoming train shows listed below, bring your engine, and **get WOWSound installed** for the bargain **show price of \$97**.

Learn from the best as **we perform your WOWKit installion** 1-on-1 and return home with a tested WOWSound equipped engine ready to go.

[Click here to learn more and register for a spot at an upcoming show](#)



The Great Scale Model Train Show  
Oct. 29th & 30th, 2016

**Trainfest**® Trainfest  
Nov. 12th & 13th, 2016

**OkTrain** Show Oklahoma City Train Show  
Dec. 3rd & 4th, 2016

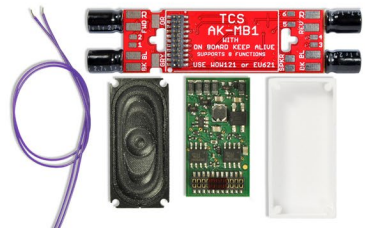

WOWKits provide the only true turn-key sound conversion solution.  
[www.TCSDCC.com](http://www.TCSDCC.com)

• INDEX

• TABLE OF CONTENTS



# DCC IMPULSES | 4



3. The new DCS210 system box is the basis of the Digitrax Evolution system.

is the inclusion of a power supply. This makes the Evolution a complete “out of the box” 5-amp system.

The included parts and pieces will be familiar to Digitrax users:

- DCS210 system box (command station/booster)
- PS615 DC power supply
- DT500 cab
- UP5 LocoNet universal panel
- 2-foot LocoNet cable

# DCC IMPULSES | 5

- LT1 LocoNet test kit
- Evolution manual
- Digitrax Decoder manual
- Digitrax system sales brochure

The DCS210 resembles past Digitrax system boxes. The new box is sleek at 5.4 (w) x 4.6 (d) x 2.9 (h) inches. The unit is shorter and wider [4] than the predecessor products, like the DCS100, which was 4.4 (w) x 4.6 (d) x 3.3 (h) inches.

The only readily apparent external difference between the DT400 series and the DT500 [2] series cabs is the number between the knobs. The keyboard is labeled identically on both.

The PS615 power supply, only available as a part of the Evolution system, has a detachable line cord. The one supplied with my

## ADVERTISEMENT



**RailPro™** Power ON Main Page  
Handheld Controller Model # HC-2

Control Locomotive (🔗) 🔋  
17.6% Link Forward

UP 5714 Info

Frnt Light Dim Dilch Pop Off Next Page 1  
Horn Bell Engine Back Light Exit Page

**RailPro™** Model # LM-3S  
RING ENGINEERING

**NEW Starter Kit**  
**\$399.99 MSRP**

- Includes Wireless Color Touch Screen Handheld Controller and 56 Watt Power Supply
- Expandable to Virtually any Size Layout

**NEW Locomotive Module**  
LM-3 & LM-3S

- Direct Radio RF
- Sound and Non-Sound
- New Tiny Size
- 6 Light Outputs

**NEW TECHNOLOGY**

**DIRECT™ RADIO**

Click Here to Learn More

For more information visit our Internet site: [www.RingEngineering.com](http://www.RingEngineering.com)

# DCC IMPULSES | 6



4. The new DCS210 beside the predecessor DCS100.

ADVERTISEMENT



## Fun Features for a Fraction of the Cost!

As the most versatile, feature-packed sound decoder, Econami redefines *value*. Starting at \$79.95 and available now!



Hear how you can get more for less!

SOUNDTRAXX®

• INDEX

• TABLE OF CONTENTS

# DCC IMPULSES | 7

system was for the North American standard socket. The input requirements for the PS615 are 100 to 240 volts AC, 50 to 60 Hz, making it compatible with power mains around the world with at most a change of line cord to support the local sockets.

With the PS615, the DCS210 in the HO mode will put about 14.7 volts DCC on the track. The PS615 plugs into the barrel connector on the front of the DCS210, for a quick plug-and-play 5-amp N or HO system.

## What's new in the DCS210?

Let's look at the new or changed features.

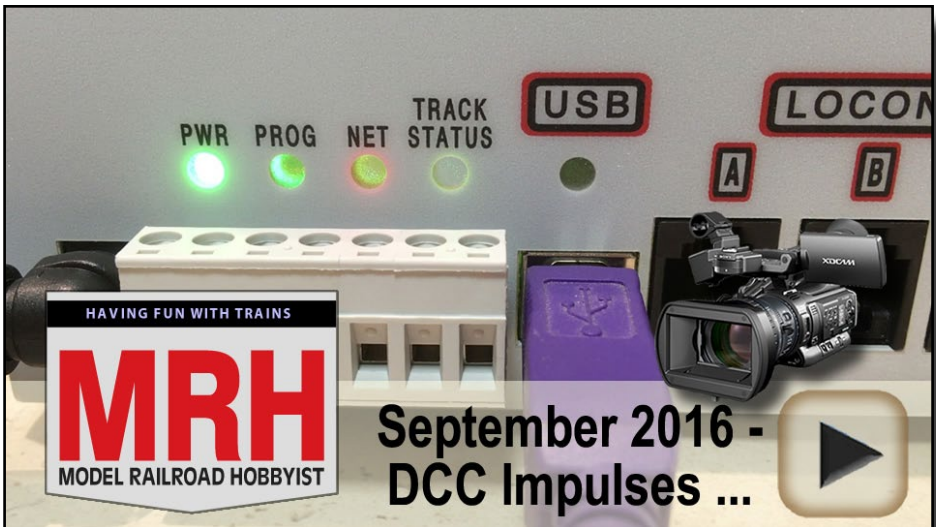

Playback problems? [Click here ...](#)

5. The DCS240 system box has the same lights as the DCS210, except that the DCS210 doesn't have the USB connector or (blue) light. Here is a video I shot of the lights on the DCS240. It is equally descriptive for the Evolution, just ignore the blue USB light.

# Get Better Sound from your Locomotives

Can't get a good sound from your sound decoder?  
Give our speakers a test drive with your ears.



**RAILMASTER HOBBIES**  
**9812 BELMONT**  
**BELLFLOWER, CA 90706**

Bass Reflex  
Speakers



High Bass  
Speakers



When it comes to speakers we have high quality speakers to fit many different applications.

We are also a full line hobby shop. Need anything? We are an authorized dealer for Soundtraxx, Digitrax, Athearn, Walthers and many others. We provide quality speakers for your DCC sound systems and quality service.

**Click here for  
the answer ...**

# DCC IMPULSES | 8

**Manual** - The manual has been rewritten and is easier to understand than the Super Chief manual. It is not yet “Digitrax for Dummies,” though. A lot of items that I believe should be indexed are not covered in the back of the manual. There is plenty of room in the margin to add your own comments on the index pages.

**Track voltage adjustment** - The three-position track voltage switch is still on the front panel. The voltage selected by each of the three positions is adjustable, giving a complete range of track voltages from 9 to 24 volts. For track voltages above 15 volts or currents above 5 amps, the user must provide a separate DC power supply. The ideal voltage for this supply is about a volt above the desired track voltage. Default track voltages are: N = 12.4 V; HO = 14.7 V; O/G = 20.4 V.

**8-amp system** - No longer must we buy a different product to get the higher current booster. To unleash the 8-amp rating, rather than using the PS615 supply, just connect an appropriately sized DC power supply to the “8 A” connections on the 7-pin gray plug (observing polarity). Digitrax recommends their PS2012. See page 37 of the DCS210 manual for details.

**Slots** - The DCS210 will handle 100 cabs of any Digitrax vintage, controlling 100 locos. For comparison, the Super Chief series could work with a maximum of 120 if you changed an OpSw setting and the Empire Builder could only support 22.

**No need to open the box** - There is no internal battery for the user to replace. There is no need to open the box to change the internal computer code; it can be updated through the LocoNet.

**Cab capabilities** - The new DT500 series cabs will be needed to take full advantage of the DCS210 or DCS240 system boxes.

# DCC IMPULSES | 9

Digitrax has stated that some of the new features will be accessible using older cabs, but haven't elaborated as to what and how.

**Loco Reset button** - The DCS210 and DCS240 both have a "Loco Reset" button. As delivered, the button clears loco data, routes and consists out of the database, similarly to closing OpSw 39. A change of OpSw (OpSw 38 = c) will change the function of this button to setting the speed of the cleared locos to zero and shutting off all functions.

**Easy Route (EZ RTS) button** - This button makes it easy to set up the 64 internal routes (each with up to 16 turnouts).

ADVERTISEMENT

## WAY TO GO, TRAINTEK!

Already great prices  
and NOW ...

**FREE SHIPPING  
ON ORDERS OF  
\$79 or more\***

Start saving now!



\*some exclusions apply

ADVERTISEMENT

## TamValleyDepot.com

Great Electronics for Great Model Railroads



We are loading up the boxcars with  
Frog Juicers ready for your layout!

• INDEX

• TABLE OF CONTENTS

# DCC IMPULSES | 10

**All NMRA functions are refreshed** - The DCS210 and DCS240 will refresh all 30 functions periodically. Older Digitrax systems only refreshed F0 through F8. “Refresh” means resending the status, for example “F12 on.” Without refreshing, it is possible for something to get turned off while running, necessitating manually turning a function off and then back on just to have it on.

**“StealZap” feature** - With the newer cabs (DT402 R2 or DT500) there is no need to dispatch locos to move them from one cab to another. When they are selected on a second cab, they are automatically removed from the first.

## What’s new in the DT500 cab?

The DT500 has an on/off switch capability built into the keyboard. Users don’t need to flip batteries around anymore.

The DT500 has a longer battery life than the DT4xx series, due to an “advanced power save mode.”

The DT500 series cabs can talk to the DCS240 system box on up to 400 slots when connected by cable or duplex radio.

## While some things change, others remain the same

Short addresses are in the range of 01 to 127. Long addresses are limited to 128 through 9983, with a caveat. Page 113 of the manual says: “Not all 4 digit addresses in this range are actually available for use.”

Support for non-decoder equipped locos is still available, where allowed by patent agreements. The DCS210 ships in the USA with this feature enabled. If desired, the user can disable the feature by setting OpSw 20 to “c.”



# DCC IMPULSES | 11

I still disagree on the wiring diagram for the programming track in the manual (on page 30) -- there is no isolation section. I discussed how I believe the programming track should be wired in my May 2014 column ([mrhmag.com/magazine/mrh-2014-05-may/di\\_programming-track-tricks](http://mrhmag.com/magazine/mrh-2014-05-may/di_programming-track-tricks)).

## How does it play?

I spent a few hours with the Evolution before I wrote this mis-sive. Here's what I found.

The default settings bring the system box up with the power on and ready to run a loco, unlike prior units. Thank you, Digitrax.

ADVERTISEMENT

[www.SBS4DCC.com](http://www.SBS4DCC.com)

ESU TCS WOW Sound OSI Solutions ZIMO SOUNDTRAXX NCE The Power of DCC Digitrax DCC Specialties INNOVATION FOR DCC MRC Model Rectifier Corporation ACCUTRACK II SPEEDOMETER SPROG DCC the DCC Programmer and Control Family Digital plus by Lenz TAM VALLEY DEPOT Great Electronics for Great Model Railroads TEAM DIGITAL, LLC Improving the world of DCC

ADVERTISEMENT

Your Dream,  
Our Ambition!

YD0A  
www.anemodell.com

• INDEX

• TABLE OF CONTENTS

# DCC IMPULSES | 12

The command beeps are quieter and less obnoxious than previously. Be aware that there are now short and long beeps and the messages being communicated may be different than what you are used to with prior Digitrax systems. You may want to copy the table on page 41 from the manual and post it in a conspicuous place near the command station until you become more familiar with the sounds coming out of it.

The colorful lights on the front of the DCS210 will tell you a lot about what's going on inside. The video I shot this summer [5] will help you understand. The table on page 42 defines their functions..

ADVERTISEMENT

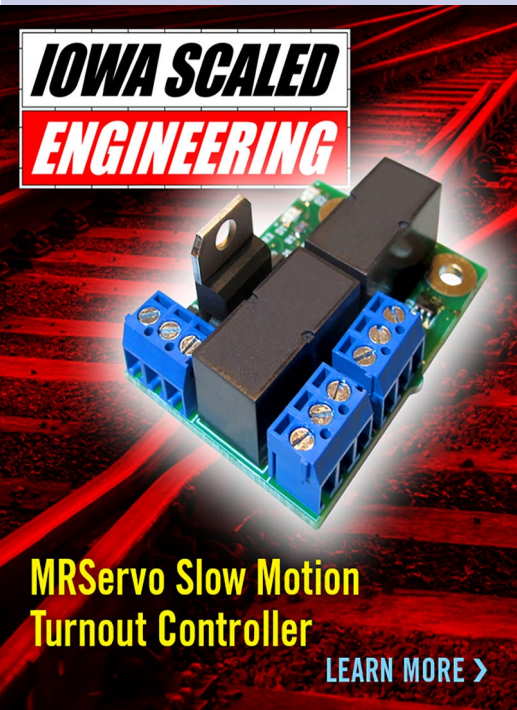

**IOWA SCALED**  
**ENGINEERING**

**MRServo Slow Motion Turnout Controller**

[LEARN MORE >](#)

ADVERTISEMENT



**WOW!**  
**What scale is this?**

[Click for the answer ...](#)

MISSOURI LOCOMOTIVE COMPANY

# DCC IMPULSES | 13

If you want to interface a computer with the DCS210, you will need an interface module, such as the Digitrax PR3 or a third-party box, like the RR-CirKits LocoBuffer-USB.

With a limited selection of resistors, I tested the power delivery capabilities of the DCS210 and the PS615. There was a slight drop in voltage as the current increased. I didn't have the capability of pushing the DCS210 any closer to its limit to see how the shut-down works.

The HO setting is closer to the maximum voltage of the PS615. Thus, the voltage drop is larger than with the N setting, as would be expected.

HO setting		N setting	
Volts	Amps	Volts	Amps
14.6	0.00	12.4	0.00
14.4	0.68	12.4	0.58
13.6	3.31	12.1	2.93
13.5	3.90	12.0	3.47

6. Table of track voltage drop as current delivered increases. DCS210 with PS615 power supply.

## Who should buy an Evolution system?

The Evolution system is stylish and has nice features. If you have a functional Super Chief system I see no reason to change unless you just gotta have the latest and greatest. However, if you are moving up to a 5-amp system or starting out in the Digitrax realm, the Evolution is a price-competitive system in the bulls-eye of the 5-amp system space.

If you are needing the full 8-amp capability or track voltages above 14.7 volts, then you will need an external DC power supply. In these cases, you may want to consider purchasing a DCS240 separately, rather than buying the Evolution set which includes a PS615 power supply that you won't be using. This is especially true if you will be using the computer USB interface functionality that is built into the DCS240.

## What now?

The Evolution will take the place of the DCS100 that we are using on the PebbleCreek club layout. I'll report back along the way on what we see as we get to be better friends.

Please share your experiences and ideas. Just click on the Reader Feedback icon at the beginning or the end of the column. While you are there, I encourage you to rate the column. "Awesome" is always appreciated. Thanks.

Until next month, I wish you green boards in all your endeavors.



[Click here for  
reader comments](#)



ESU

**Why settle for sound that is close enough when you can have the exact sound for your locomotives?**



[Click here for a complete listing of sound files and samples.](#) 

**One size does NOT fit all!**  
**Shown above are seven ALCO 12 cylinder 251's, all with slightly different sounds!**

ESU LLC

23 Howard Street, Montoursville Pennsylvania 17754

Phone +1 570-980-1980, Fax +1 866-591-6440

(Office hours: Monday through Friday, 8AM to 4PM (EST))

[WWW.LOKSOUND.COM](http://WWW.LOKSOUND.COM)

# From first train set to railroad empire...

*Our complete line of DCC products  
grows with you. Discover the fun!*

- Designed and manufactured in the U.S.A.
- Preferred for ease of use and ergonomic design
- Unlimited scalability for any size model railroad
- Plug-and-play means more time running trains
- Great customer service and excellent support



## See your dealer



## Visit our new and improved web site for all your DCC needs!

- Get the latest new product announcements
- Watch our detailed how-to videos
- Browse the all-new Information Station
- Enjoy secure online sales, day or night!

Visit **ncedcc.com**



# Bowser

## New Product Announcement HO N8 Caboose

Ready to Run and Assembled.

Window glass, separate grab railing, metal wheels, and where indicated Train Phone antenna (designed using the PRR drawings).

MSRP: with Antenna \$35.95 each  
Without Antenna \$27.95 each



Road Names:  
Conrail,  
Penn Central,  
PRR



## HO U-25b Locomotives

Ready To Run and Fully Detailed. New Upgraded Handrails (correct for all Phases), New 9'4" AAR B Trucks and Gearbox, Metal MU Hoses, air hoses, windshield wipers, grab irons, coupler lift bars, operating headlight, window glass, can motor, flywheels, nickel silver wheels with RP25 flanges, knuckle couplers. Available with sound and DCC or just DC. Analog (DC) version features NMRA 21 pin plug for DCC, DCC/Sound version features LokSound Select decoder. (Stanchion Colors used for visual purposes only to show differences)

DC Version: \$199.95    Sound Version: \$299.95

Road Names: Erie Lackawanna, Great Northern, Milwaukee Road, NYC, P&LE, PRR, SP, & UP



Click here to check out the details for these and other great  
**Bowser Products**

• INDEX

• TABLE OF CONTENTS





NICK MUFF  
.....

# GETTING REAL

column



[Click here for  
reader comments](#)

## MODELING THE KANSAS CITY SOUTHERN RAILWAY | MAINLINE SOUTH – GRANDVIEW, MISSOURI

### **AFTER MODELING 45 FEET OF DOWNTOWN**

Kansas City it is a pleasant change to be modeling Grandview, Missouri, the first stop for the Southern Belle on its southbound journey. Grandview is approximately 20 miles from Kansas City Union Station. The population in 1950 was 1,556.

With any of our model projects the first challenge is usually that of selective compression. I do not have room to model all of Grandview so the first step is to decide how to create the impression of small-town America in a space 30” wide and 25” deep. The focal point of this scene will be the Kansas City Southern’s Grandview Depot.

I had previously created the depot using a 1/16” laser-cut plywood sub shell with laser-cut 1/64” plywood windows, asbestos siding and asphalt shingle roofing. The asbestos shingle siding for the station was a pale green color – in fact, the same siding

▶ **MODELING REAL RAILROADS AND WHAT THEY DO**

## GETTING REAL | 2

my grandparents had used on their farm house. The asphalt shingle roof was gray. A unique feature of the station was two track inspection lights mounted low on the front of the operator's bay.

### Land forms and scenery base

With the plywood benchwork previously completed, I chose next to complete the ground forms in front of the town. As previously noted, I used Joel Bragdon's geodesic foam material to avoid a plaster mess in the layout room. Additionally, the right-hand section of ground needed to be removable to allow access to the upper level of the helix which passes beneath it. The foam scenery was perfect for this application – lightweight and rigid.



1. Foam scenery panel in front of track.

## GETTING REAL | 3



2. Wadded towels supported the right scenery panel until it cooled and hardened.

ADVERTISEMENT



**GLXSCALEMODELS.COM**



# OIL LANTERN KIT

**1/48  
SCALE!!!**

**\$19.99**  
+ S&H



**12 VOLT POWERED LED LIGHT**

• INDEX

• TABLE OF CONTENTS

## GETTING REAL | 4



3. Right scenery panel fitted in place.



4. Right scenery removed to show helix tracks.

## GETTING REAL | 5

The next challenge was to raise downtown to the correct level. The point of reference I used is the railhead. The top of the 0.020" laser-cut/engraved acrylic platform should match the top of the railhead. Using paper patterns I cut 1/4" black foam core to fit the paved portions of town and glued these in place with white glue. The right end was tapered down to match the highway passing through town and the left hand end was tapered down to match the parking lot of the Ford Stamping Plant.

Using the reverse pattern I cut pieces of 1/2" foam board to fit all of the areas around the roadways raising the town 1/2". The 1/4" difference between the roadways and the rest of town minus the 0.040" road base, the 0.040" roadway and a 3-mm asphalt surface provided just the right lip for a curb at the edge of the sidewalks.

*The* Get the Latest Model Railroading News, Tips, Reviews & Opinions

# SCOTTY MASON

S H O W

*The Original Model Railroad Podcast*

## -Monthly Interviews

- Modeler's Spotlight: Top Modeler's Talk
- Narrow Gauge Modeling w/Chris Lane
- Contemporary Modeling w/ Mike Rose

## -More Product Announcements & Reviews



Our feed has changed! To get the latest shows, please search Scotty Mason and subscribe to the new feed!

[www.TheModelRailroadPodcast.com](http://www.TheModelRailroadPodcast.com)

Scott Mason Jimmy Simmons Mike Rose Joe Duckworth

• INDEX

• TABLE OF CONTENTS

## GETTING REAL | 6

Finally, an additional ¼” section of foam was added under the station area to bring its platform to the correct height. Outside the station area, the edge of the foam was tapered off with a hobby knife to blend into the layer below it. The foam board turned out to be a great way to raise the roads, town and platform to the correct level. It was easy to cut and easy to install.

### Asphalt roads

Next it was time to deal with Arkansas Highway 71 which runs from the front of the layout to the backdrop. In order to pass under the tracks and still climb up to street level at Grandview, the upgrade is steeper than the real world would probably allow.

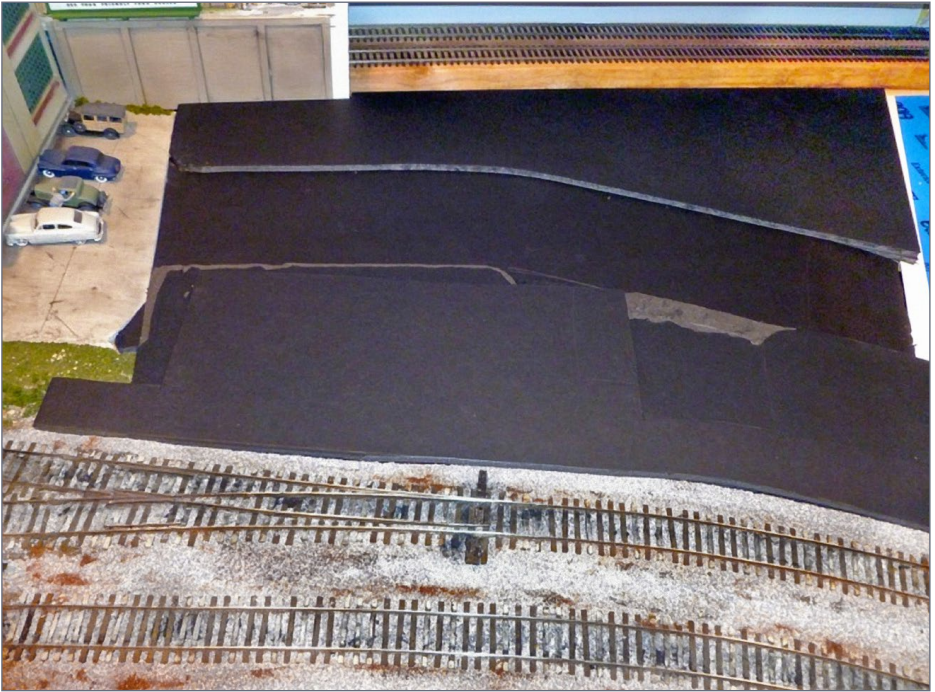

5. I used black foamcore to build up the town area.



### 6. Curved support for the up-grade highway.

It works in this location because of the forced viewing perspective. You can only see it from the front, not from the sides.

To support the road in this forced curve, I cut and installed bracing pieces from 1" x 4" pine to maintain the proper contour of the styrene base for the road. I used paper patterns to cut a 0.040" styrene base for the road, and glued it in place using plastic-compatible Liquid Nails. I think the appearance of model is greatly enhanced by "crowning" the road surface just as prototype roads do.

To accomplish this I used MEK to glue a 0.100" x 0.125" styrene strip to the center of the road flat side down to elevate the center of the roadway. Down the center of each roadway I laid a thinner strip of 0.060" x 0.080" strip styrene, flat side down. This supports



### 7. Styrene road surface glued in place.

the crowned styrene roadway as it tapers off to glue down to the styrene base at the left and right edges. I then cut the upper roadway from 0.040" sheet styrene and used super glue (CA) to glue it at the edges only, holding down the edges with masking tape until they dried. I did not use MEK, to avoid distorting the road surface from a solvent-based glue.

The final layer of sheet styrene serves as the base for creating the asphalt roadway. This is the first time I have had to model an asphalt road. All the roads in downtown Kansas City are jointed and concrete. I chose to use a method described previously in *Model Railroad Hobbyist* magazine. The next step was to use the same paper patterns to cut out pieces of 3-mm self-adhesive



# GETTING REAL | 9

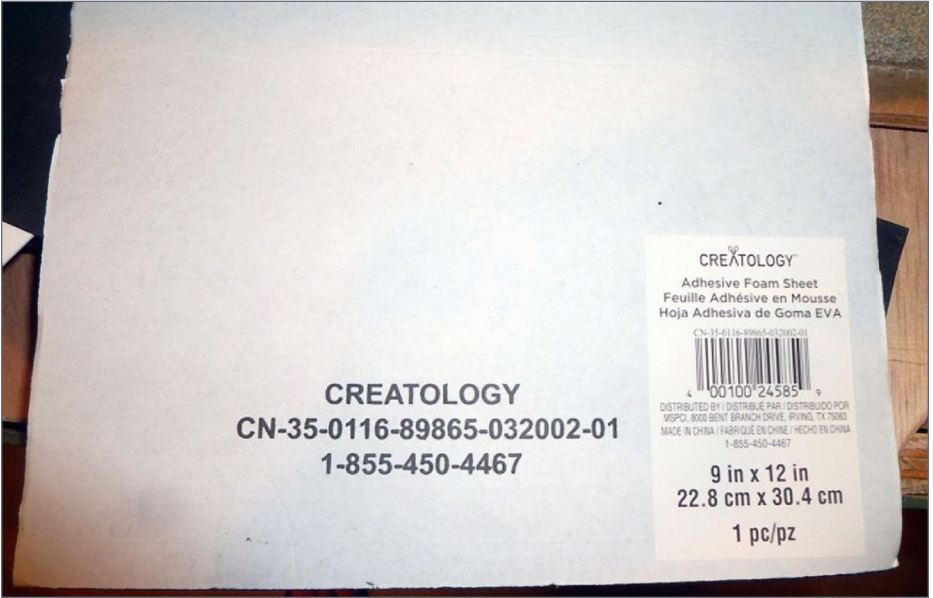

8. 3mm self-adhesive craft foam.



9. Peel backing and apply one-half at a time.

## GETTING REAL | 10

black craft foam. I peeled the backing from the foam and fitted it in place on the styrene roadway. I used Creatology brand foam sheet purchased from Michaels.

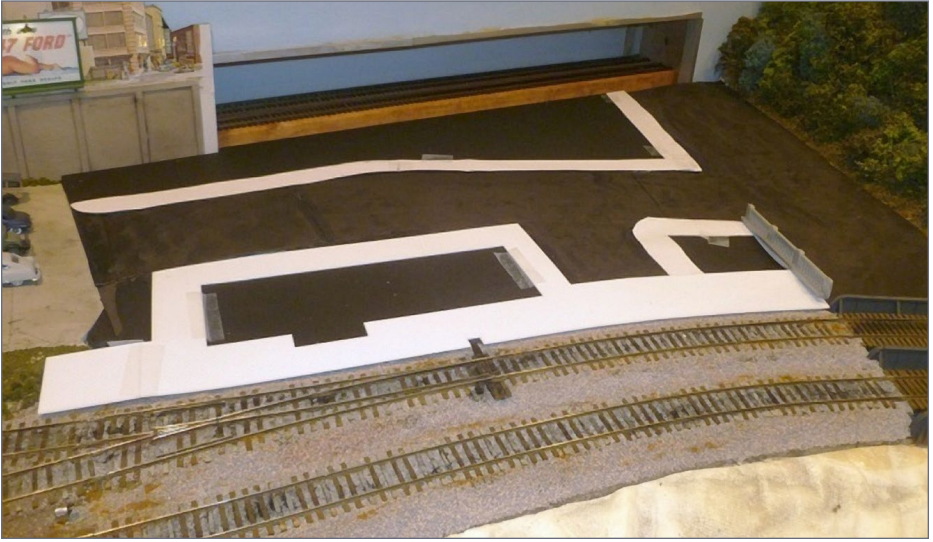

10. Black craft foam in place, sidewalk patterns created from paper.



11. Asphalt areas painted medium gray.

## GETTING REAL | 11

For the roads, I used three shades of gray by Folkart – 2561 “Steel Gray” for light gray, Folkart 425, “medium gray” for medium gray, and Folkart 925 “wrought iron” for dark gray. I first painted the craft foam roadway medium gray using a foam brush.

The next step is to apply the striping. In the real world typical striping is 6 to 8 inches wide, and 10 feet long with a 15-foot space between stripes. But for the model railroad, selective compression is needed again. I used 5-foot stripes with a 10-foot spacing. This looks right and makes the road seem longer when viewed along its length.

To make it easy to stripe the roads, especially where it passes under the railroad, I used blue masking tape. Okay, I cheated and



12. Folkart colors for painting asphalt roads.



### 13. Apple Barrel No. 20585 Satin Cream.

used my laser cutter to cut masking for the stripes and also for the stenciled word “Stop.” It turned out to be a very slick way to accomplish this. The masking was then applied to the roads, and the stripes painted using off-white paint ( Apple Barrel 20585 Satin Cream) and a “dry” foam brush technique. With a brush almost dry, patting the masking tape creates mottled stripes that appear worn rather than crisp and freshly painted. When the paint dried, I removed the masking tape.

To create patches in the road, I scored sections with a knife and removed them , or I simply tore out sections to create irregularly shaped patches. I then stuck the removed pieces to a sheet of cardboard for painting. I tried to maintain a consistent

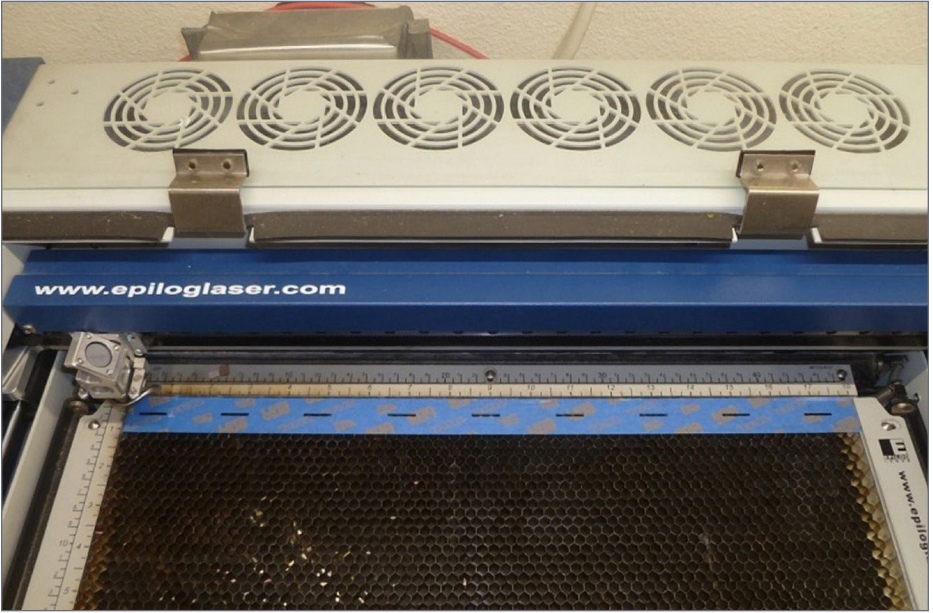

14. Cutting masking for the stripes using the laser cutter.

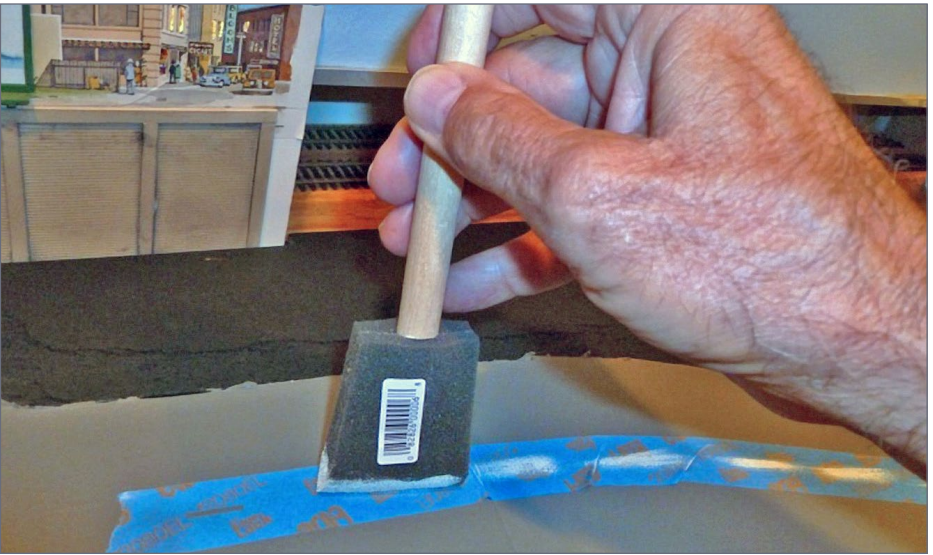

15. Painting the stripes with a dry-brush technique.

## GETTING REAL | 14

orientation to make the patches easier to place back in the same position. I painted some of the patches with darker gray paint, and some lighter gray for contrast. Once the patches were dry, I glued them back in place with Walters Goo.

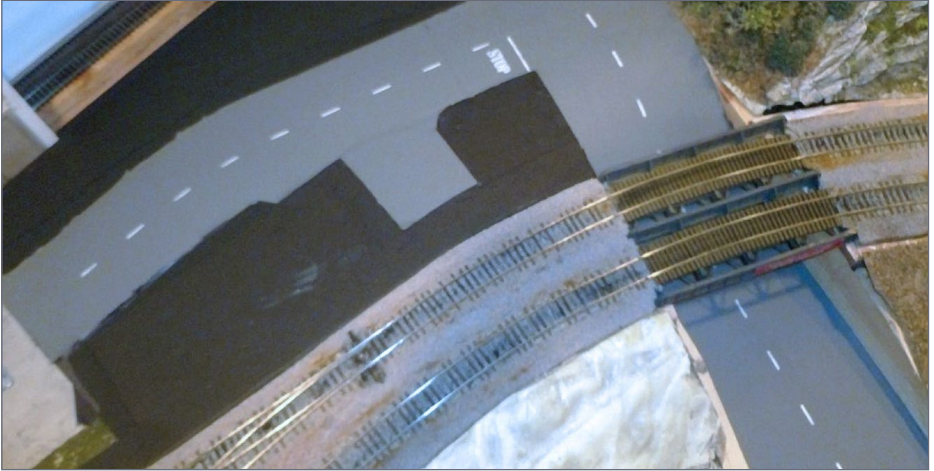

16. Striping completed.



17. Tear or cut out sections of asphalt to create patched areas.

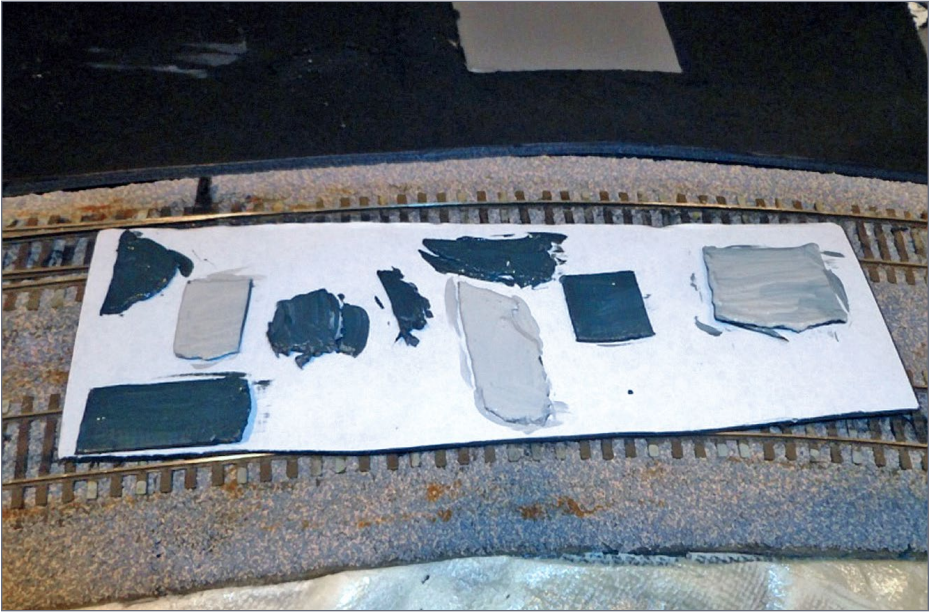

18. Patches stuck to cardboard and painted.



19. Glue patches back on to road with Goo.

## GETTING REAL | 16

Next comes the real magic, creating cracks. In the part of the Midwest I model, the asphalt had a lot of cracks. That's the reason for using black foam painted gray instead of gray foam. Chuck the pointed end of a straight pin in a Dremel motor tool and clip off the opposite end at an angle. This creates a small cheap drill bit. Turn the tool on low-speed and draw the rotating pin through the foam to create "cracks." Make as many as you like, wherever you want – it's that easy to do. A few days later as the foam relaxes, the cracks will be more prominent, so take it easy on the first pass.

The final touch is to weather the completed asphalt roads with chalk dust. I use "grimy black" to simulate oil drippings up the center of the roadway and "dustbowl brown" at the sides to simulate mud and dirt that have accumulated there.



20. A section of the Old Hwy. 59, Siloam Springs, AR.





21. A pin chucked in a Dremel tool creates cracks.

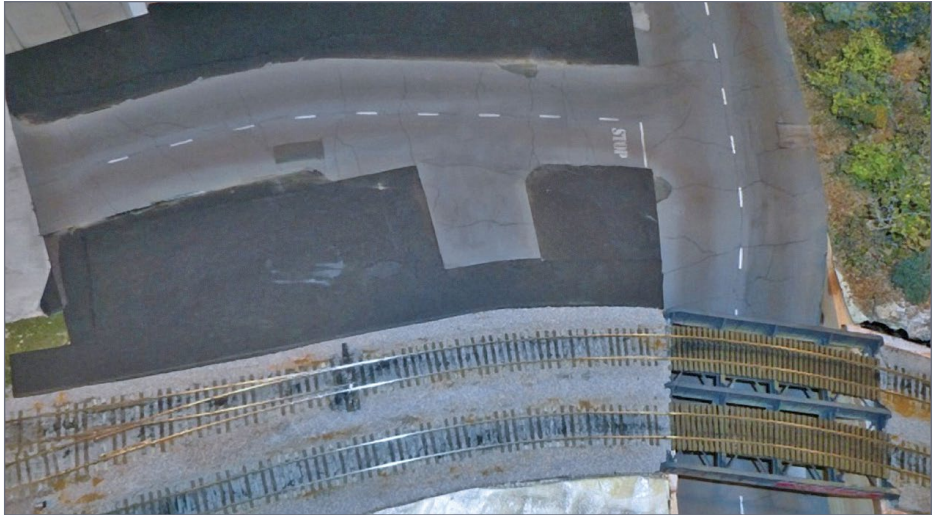

22. Asphalt after chalk weathering.

## Sidewalks

Using the paper patterns that I created, I laid out the sidewalks on 0.040" sheet styrene. I scored expansion joints 1" apart. Next I scored the edges of the sidewalks with a hobby knife and snapped away the excess. I used MEK and glued 0.060" x 0.080" strip styrene edgewise to the outer edge of the sidewalk to create a curb.

To finish the sidewalks I used my standard technique and sprayed them with Testors Camouflage Gray. When dry, I weathered them with dilute India ink and when that was dry, with grimy black chalk overall and dustbowl brown chalk along the edge against the buildings where dirt collects. I glued the completed sidewalks to the foam core base with the curb strip overlapping the front edge of the foam core and resting on the asphalt roadway.

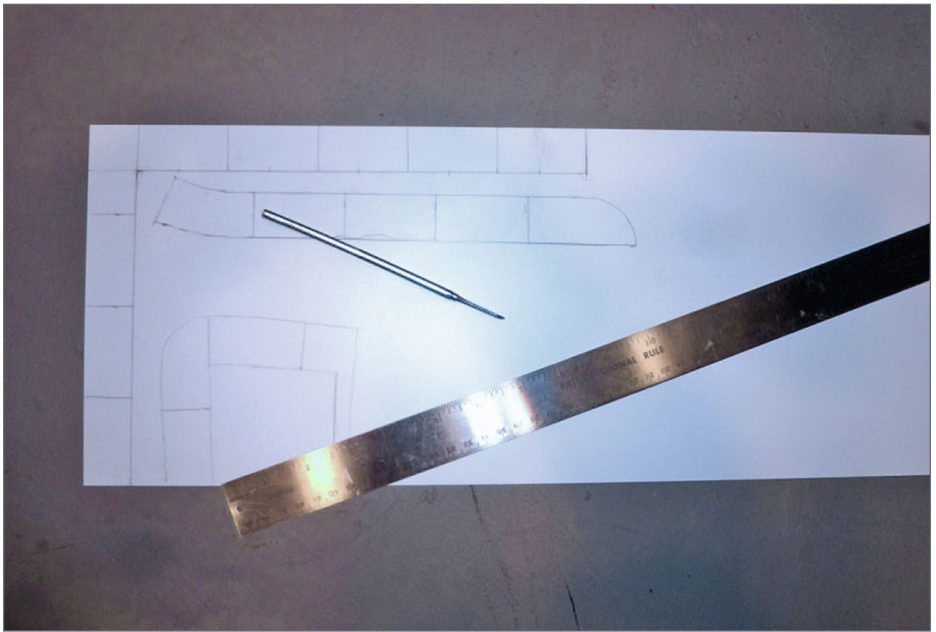

23. Laying out the sidewalks on sheet styrene.

## GETTING REAL | 19

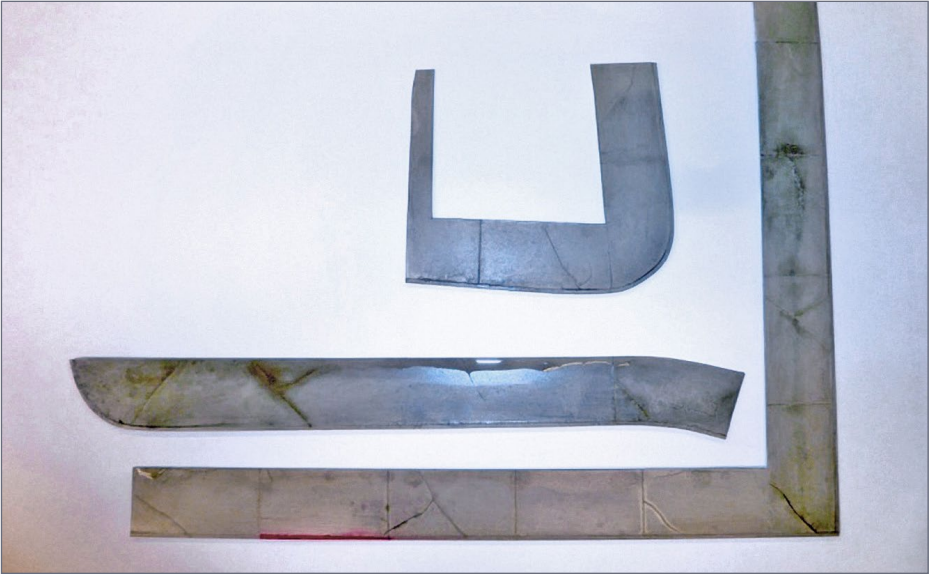

24. Sidewalks complete and weathered and ready to install.

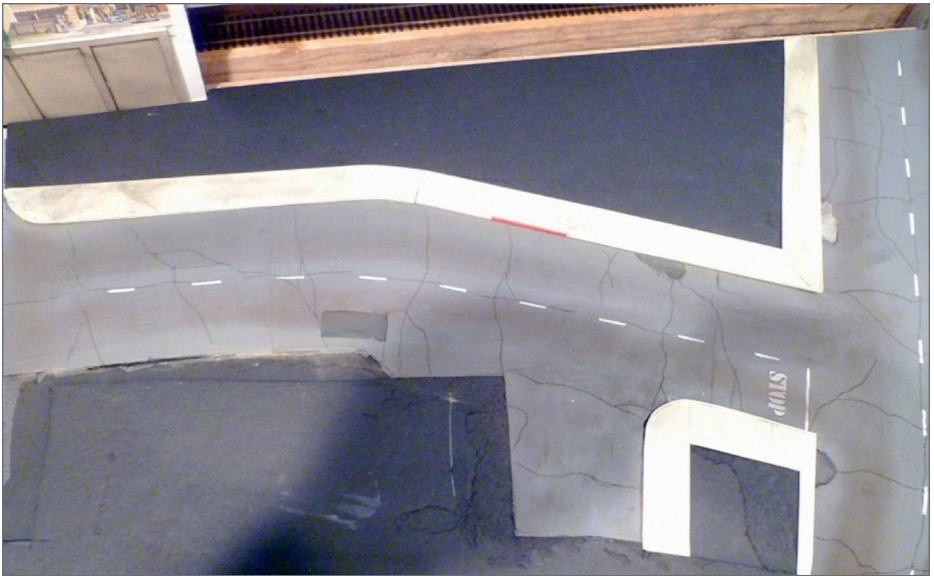

25. Grandview with asphalt roads and sidewalks complete.

## GETTING REAL | 20

One advantage of making sidewalks this way is that structures sit behind the 0.040" thickness of the sidewalk, concealing any gap between the bottom of the structure and the foam core base. I think nothing spoils a model railroad scene more than buildings that don't actually seem to be sitting on the ground!

### Backdrop

Grandview posed a special challenge. Two stub-end staging tracks run inside the wall at the back of town. This area needs to be accessible for maintenance, which means the city backdrop across the back of town needs to be removable. For the left 2/3 of the backdrop, I cut a piece of 1/4" foam core to fit in the opening in the wall. Then I glued this to a larger piece of blue colored cardstock. For the right third I used a piece of cardstock attached to the wall



26. Hidden staging tracks.

## GETTING REAL | 21



27. Grandview street level view, Google maps.

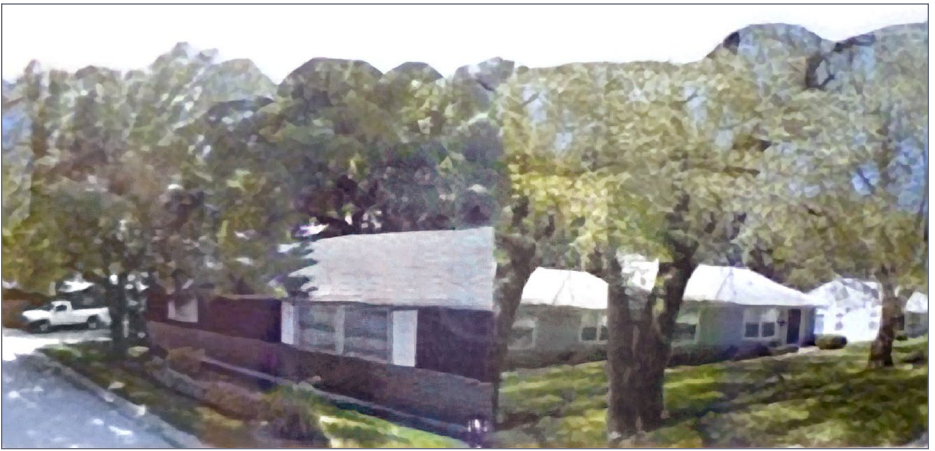

28. Left backdrop, front side.

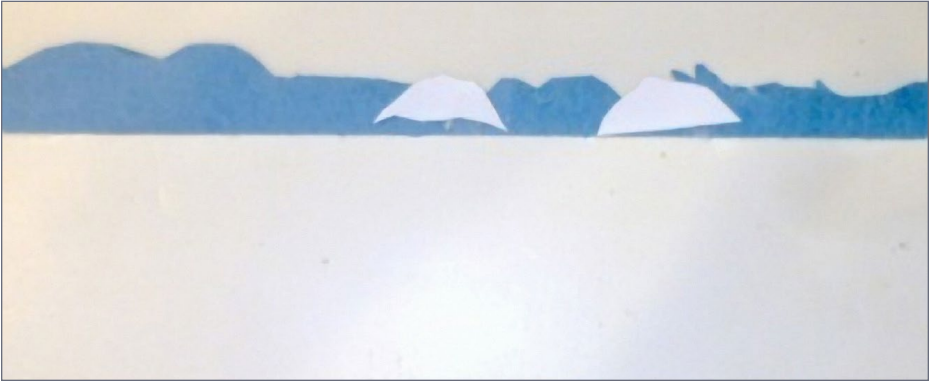

29. Left backdrop, back side.



30. Right backdrop, the original image.

## GETTING REAL | 23

with double stick Velcro pieces.

The artwork for the right portion of the backdrop is taken directly from a photograph I took when visiting Grandview. I used a graphics program to add the word “Grandview” to the water tower. The



31. Backdrop installed on the layout.



32. Blair Feeds, the prototype.



33. Blair Feeds, the model.



34. Hobby store, the prototype.



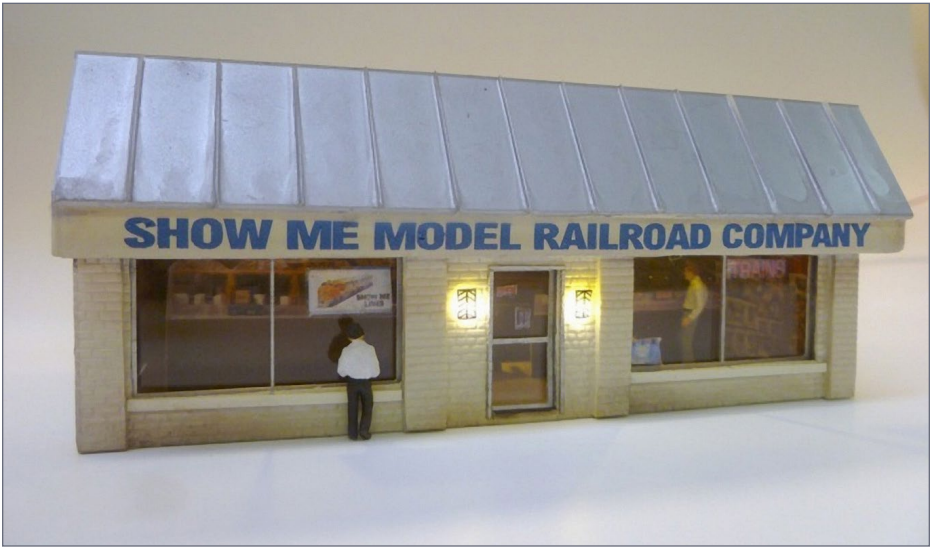

## 35. Hobby store, the model.

“4 Acre Motel” is a landmark in the area. I found a photograph of the sign online and re-created it in the CAD program. Last, I added a Miniatronics flasher to the top of the water tower. I substituted a small surface-mount red LED for the red 3 mm LED that came with the flasher.

For the left two-thirds of the backdrop, I needed street-level photographs of Grandview I hadn't taken when I was there. Fortunately, I was able to find images I needed on Google maps street-level view. Last, I glued clumps of Super Sage tree material over the trees on the backdrop to add dimension and realism. This greatly improved the overall appearance.

## Structures

I had previously chosen and constructed the buildings for downtown Grandview. They are all based on prototype structures in the area adjacent to the depot.

## GETTING REAL | 26

I love putting lighted interiors in my structures. It greatly enhances the realism. Recently I came up with a simple and cost-effective way to create them. Of course, the model hobby shop should have lots of shelves with little Athearn blue boxes on them. Even if I had the time and energy to do this, the end result

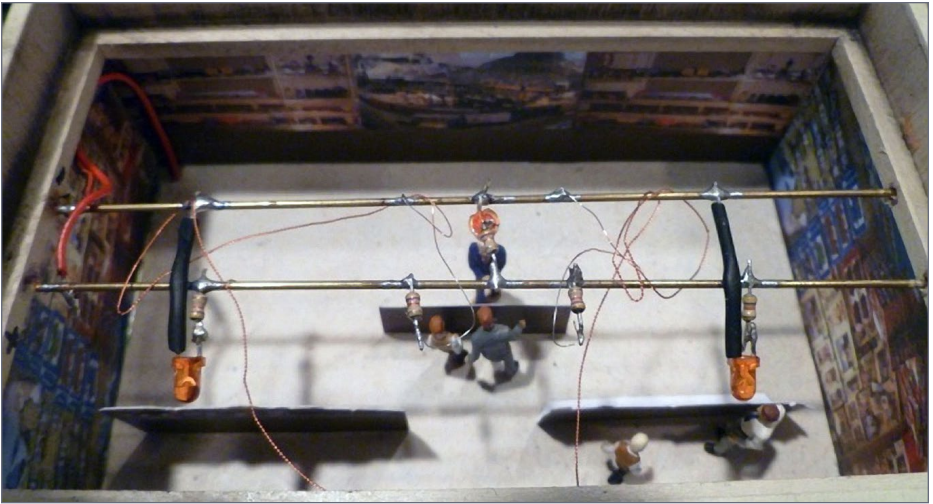

36. Hobby cardstock interior.



37. Barber Shop, Shoe Repair.



38. Jeannie's Corner Café, the prototype.



39. Jeannie's Corner Café, reversed, the model.

would not have little boxes with labels on them! So I turned to Google and searched for hobby store interiors. I scaled these images, printed them on cardstock, and glued them around the side and back walls of the model.

I used stick glue to glue a strip of brown cardstock across the back of the lower wall to simulate a cabinet beneath the display shelves. Then I used another strip of brown cardstock to simulate a checkout counter in the middle of the room. I used my photograph of the hobby store display windows in Photoshop to create the two display cases for the front of the store. Lastly, I made the signs for the windows of the store.

This creates four levels of detail – the windows, the front display cases, the checkout counter, and the back wall shelves. When lighted and viewed from the front, the effect is very impressive. Lots of detail for very little time and cost. I used this technique for all of the downtown Grandview structures.

Lighted at nighttime, the overall effect is very convincing. It makes the model town come alive.

My wife noticed there is quite a bit of a red color in the road at the lower edge of the backdrop, so she suggested I use a reddish chalk on the back portion of the road on the layout. I also used a small brush to carry the center stripe of the road in a curve up and onto the backdrop, with the stripes getting shorter and closer together as they continued into the distance.

### Retaining wall, ground cover, and trees

The final step was to complete the underpass area by adding a concrete retaining wall, ground cover, and trees. Again I created paper patterns. Then I used the laser cutter to engrave 8” form board lines on a sheet of 0.040” styrene. I transferred the paper pattern outline to the plastic sheet, scored the outline with a knife, and snapped away the excess. I added strip styrene to the top edge to

## GETTING REAL | 29

create a curb on the top edge of the retaining walls. Next I sprayed the retaining walls with Testors Camouflage Gray, followed by weathering with dilute alcohol/India ink and chalk dust. I glued the walls in place with Walters Goo. Whenever possible, I prefer to create, finish, and weather items off the layout, and install them as the last step. It's easier to access them and it reduces dust and the chance of damage to the layout.



40. Grandview at dusk.

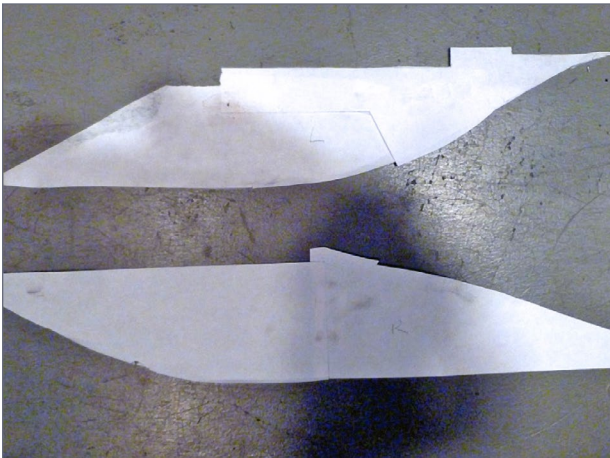

41. Paper patterns for underpass retaining walls.

## GETTING REAL | 30

I painted the herringbone brick platform for the station a dark red brick color. I painted the curbs around the platform edge Camouflage Gray, and then weathered with diluted alcohol/India ink mix and Bragdon chalk dust I glued the platform to the foam core base using Walters Goo. Next I used ballast on the track side and sifted contractors sand around left and back side of the station to blend the platform into the surrounding scenery. I sprayed these areas with wet water, and fixed them in place with dilute white glue.



42 Retaining wall in place.

## GETTING REAL | 31

I added scale grass and two SuperTrees to the small area to the right of the station to create a small city park. I painted and finished a portion of Rix concrete railing to prevent the tiny passengers from tumbling off the end of the platform into the Highway 71 underpass. Then I painted the sloping bank at the front of the layout with earth brown paint sifted on dirt and grass and finally finished with SuperTree brush and trees.





43. Grandview Depot in place.







44. Blair Feed.





45. Main Street.





46. Grandview Avenue.





47. The Southern Belle makes a station stop.





# DC Railroaders...

## UNTIL NOW, THESE FEATURES WERE BEYOND YOUR WILDEST DREAMS.

- Run multiple locos simultaneously
- More Realism: DIESEL... control 22 horns, 8 bells and assorted prime mover sounds. STEAM: 17 different whistles plus steam chuffs. Turn lights on and off and change lighting effects; manage variable momentum
- Wireless control of light, sound, direction & speed. 90' Range
- No complex programming or addressing. No DCC system to buy\*



## Introducing MRC's Loco Genie™

Experience these features on your layout for an MSRP of just \$79.98

To watch the Loco Genie video [CLICK HERE](http://www.modelrectifier.com/locogenie) or visit us at: [www.modelrectifier.com/locogenie](http://www.modelrectifier.com/locogenie)

\*If you already run DCC, or at a later date you decide to go DCC, Loco Genie's receiver-decoder works like a regular DCC decoder, and gives you the added advantage of wireless control.



MODEL RECTIFIER CORPORATION  
80 Newfield Ave. ■ Edison, NJ 08837 ■ Phone: 732 225 6360 [www.modelrectifier.com](http://www.modelrectifier.com)

TECHNOLOGY. PERFECTED.

Model railroads  Plastic model kits  Battery chargers  Radio control  Scenery  Die cast

• INDEX

• TABLE OF CONTENTS



# WHAT'S NEAT WITH KEN PATTERSON

KEN PATTERSON

column



[Click here for  
reader comments](#)

## CHRISTMAS PICTURES AND A STUDIO TOUR ...

### **THIS MONTH WE INTERVIEW MOVIE PRODUCER**

and author Neil Enock, who tells us about his new book *Doc Christmas, The Magic of Trains*, which plays out in part in the miniature world of model railroading. For layout construction this month, we experiment with five different sub-bases using liquid foam to make scenery on open-grid benchwork.

For modeling tips, we look at freight car loads and scenery from waste shavings of various types. In model photography, this month for Blackstone Models we model a narrow-gauge snow scene with a Christmas theme. Add to that a few modeled runbys and we have a pretty good video show this month.

I missed going to the Brass Expo show in Chicago this past fall but James Wright provides us with some video of all the

▶ **PHOTOS AND VIDEO OF SUPERB MODELS**

## WHAT'S NEAT | 2

wonderful models on display on a custom-built set that gave the feel of visiting a museum. Sept. 30 and October 1 2017 are the dates for next year's show. See [brassexpo.com](http://brassexpo.com) for more information.



1. If you have been following me on Facebook, you will know that I have made a major push to get the garden railroad running after two years of deferred maintenance.



**Click here for  
reader comments**

## WHAT'S NEAT | 3



2. This process included replacing some damaged plastic ties with fresh new ones. With the help of a handmade wooden jig, the ties slide on to the rails.



HAVING FUN WITH TRAINS

**MRH**  
MODEL RAILROAD HOBBYIST

December 2016 -  
What's neat ...



Playback problems? [Click here ...](#)

• INDEX

• TABLE OF CONTENTS

## WHAT'S NEAT | 4

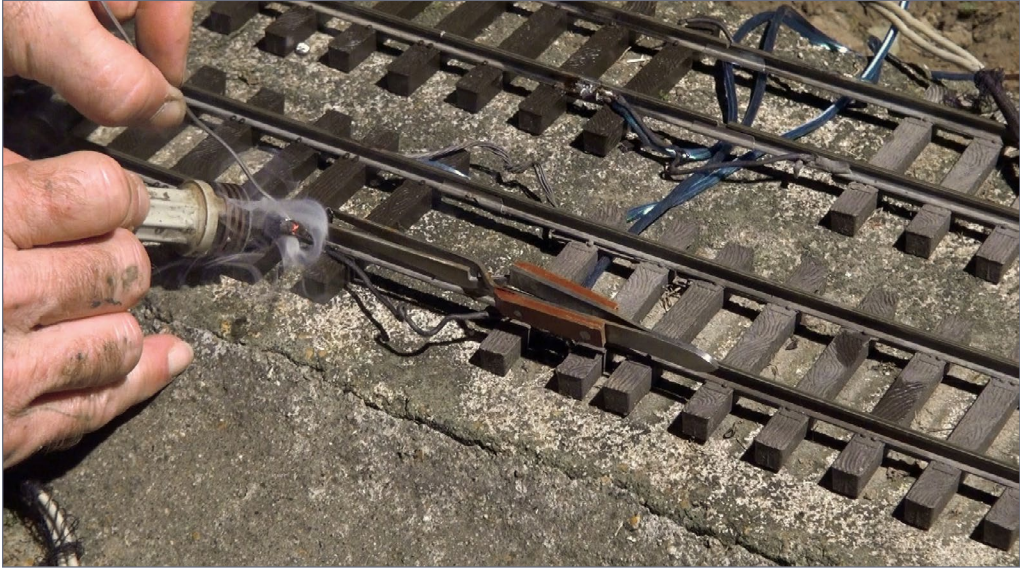

3. I added new power feed wires in eight spots on the 400-foot main line by using a resistance soldering rig to heat the large rail fast and minimize damage to the plastic ties.



4. I dug up, reset, and leveled some of the cement roadbed that settled in the hill near the trestle.

# WHAT'S NEAT | 5



5. I repaired and leveled the trestle using a red laser level once it got dark.

## ADVERTISEMENT

Want it on Blu-ray?

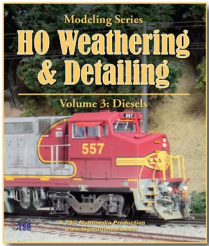

Selected titles are now available on Blu-ray disc in spectacular HD!

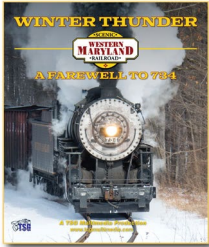
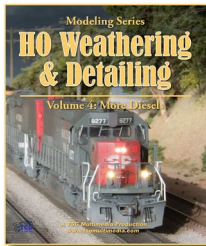

CLICK FOR  
BLU-RAY

 TSG Multimedia

• INDEX

## ADVERTISEMENT

New HO Scale Kit Release  
**GIBSON BODY CO.**



Background  
Flat Kit!

**MONSTER**  
modelworks

[www.monstermodelworks.com](http://www.monstermodelworks.com)

• TABLE OF CONTENTS



6. The next day, using an eight-foot and a six-foot level, I rechecked my work to make sure the trestle was level end-to-end and level from side to side. The train needs to run perfectly here to avoid a four-foot crash to the ground. Wind is the worst problem here. Anything over 14 mph will blow a train off domino-style. I have seen it happen many times.



[Click here for  
reader comments](#)





7. I sanded the train deck where the dogbone layout loops back – sanded it down to the bare wood with a six-inch orbital sander and 60 grit paper.

**Want to help keep  
MRH free?**

**Then *click* on ads!**

## WHAT'S NEAT | 8



8. I applied a fresh coat of semi-transparent green stain to the deck. I stained the stair trim pieces with brown stain, and reattached accent wood to the deck.



9. I built a waterproof box of wood on a pole, with a hip roof, to house the electronics and power supply. This was hidden under the deck before but I erected it on a pole for better radio reception with the hand-held radio controller.

*Have you seen this?*

**CHECK IT  
OUT!**



**kenpatterson.com**

*click here to ...*

**Visit Ken's website**

**Ken Patterson  
reveals his modeling  
secrets on video!**



10. I chose to install a powerful Bridgewater power supply with a radio control key fob-size hand-held throttle. With the built-in fan and 20 amps of power, this unit will have no problem handling three Aristo-Craft Dash 9 engines with 12 motors in the trucks drawing seven amps.



[Click here for reader comments](#)

# WHAT'S NEAT | 10



11. After cleaning the track with a drywall pole sander with a green stripping pad attached, I was finally able to run a train with no problems. Now I have an operating platform to film runbys and product reviews in large scale for the What's Neat video show.

121,000 have seen this MRH video - *have you?*

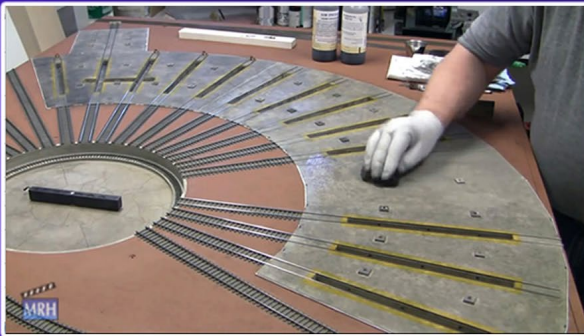

**Watch the  
video now**



# WHAT'S NEAT | 11

## Layout construction



12. This month we experiment with Great Stuff Foam Pro, testing various subbases for holding the foam in place on open-grid benchwork. Here you see a 60 x 14 inch module with the track uprights in place and roadbed running the length of the scene. I glued precut pink foam to form the rear hill behind the track. The scenery on the hill in front of the module will be made up of various materials to hold the foam in place for our experiment.



[Click here for reader comments](#)

## WHAT'S NEAT | 12



13. I started by stapling fiber window screen to a one-foot-wide segment of the hill. This screen will allow the foam to penetrate just a little, making for very strong foam hardshell scenery.



14. In this photo, you see all five sections of the layout with various sub-bases in place: window screen, masking tape, black duct tape, simple paper towels, and blue microfiber cloth. The cloth and wire screen are stapled. The tape sections and paper towels are held in place with tape.

## WHAT'S NEAT | 13

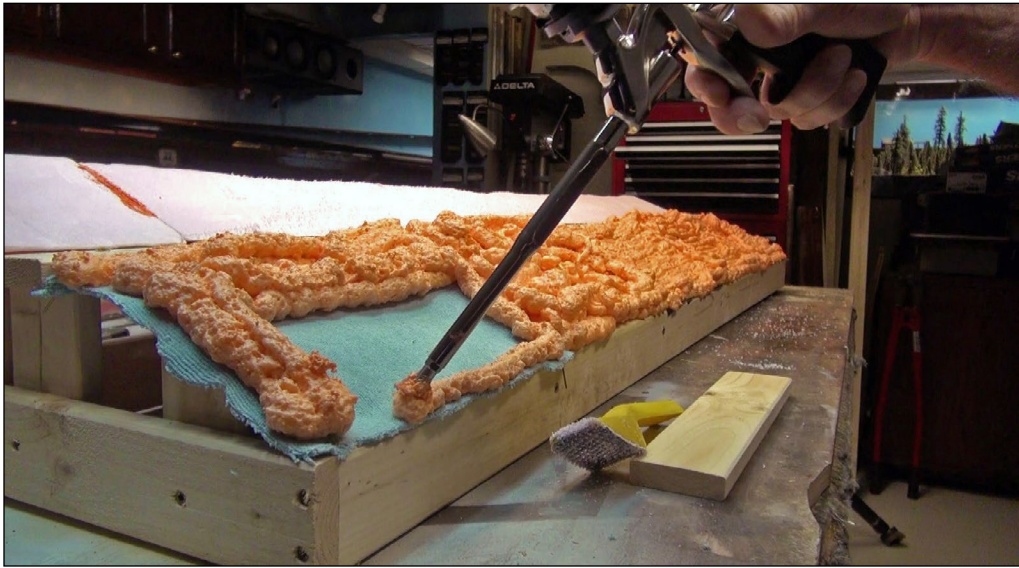

15. I covered the five sections with the Great Stuff foam and let this rise and cure for an hour. In the video, I set up a clock – more like a fan – so you can watch the foam rise in a time-lapse video that plays for 20 seconds and covers one hour of real cure time.



[Click here for reader comments](#)





16. After the foam cured, I placed a 10-pound dumbbell to weight each section to see if it would hold up and could be used as a viable way to make scenery. All five sections held the weight without cracking.

***TrainMasters TV is part of  
the MRH product family.***

***TMTV members not only get great network TV level  
videos, they help pay for MRH and keep it free ...***



17. Here you see me carving the foam scenery into shape to blend the scene. Although the scenery was now thinner due to the carving, it still was strong enough. Even the simple paper towel scenery held up.

**Did you know  
there's an  
MRH index  
available?**

[CLICK TO FIND OUT MORE](#)

## WHAT'S NEAT | 16



18. I wanted to try to make a mountain tunnel for a three-rail train display so I formed a ball of newspaper and covered this with window screen.



19. I then applied the foam to the window screen mountain.

## WHAT'S NEAT | 17



20. After the foam cured, I pulled the paper from under the turtle shell mountain. It was strong and held its shape.



21. I covered the hill with paint and dirt to form this perfect train display tunnel in O gauge for a Christmas display layout. It works. Try it. You will be satisfied with the results.

## Modeling tips



22. This month we look at metal scrap from a machine shop as a medium for making model gondola loads. Wash the metal in water, let it rust and glue it into your freight cars as a nice scrap load. Also look at the shavings from a pencil sharpener. This makes good sawmill and tie shavings, and scrap for a realistic looking scene.



[Click here for reader comments](#)

## Model photography



23. This month we make a Christmas card photo in HO scale for Blackstone Models. The inspiration for the photo we are going to model comes from a wonderful narrow gauge photo by Yvonne Lashmett. Note the snow in the trees and shades of gray and brown with textures that need to be duplicated. The wreath on the front of the locomotive also needs to be made.



[Click here for reader comments](#)

## WHAT'S NEAT | 20



24. I started the scene on a two-inch-thick piece of foam. I carved the track shoulders to match the photo, then glued down Code 55 Micro Engineering HOn3 track to match the curve in the photo. I used the length of the passenger cars as a guide to make the curve look correct. I painted the scene with white latex house paint.



25. I glued fake fur on both sides of the track to represent wild field grass. I also sprayed shades of brown into this grass to further add varied color tones as in the prototype photo.

## WHAT'S NEAT | 21



26. I filled the scene with pine trees, wire trees, and Super Tree armatures painted brown. I wanted the trees to fill the scene and block out most of the sky. I also added grass tufts on both sides of the track to blend with the fake fur.



27. Using a screen to sift plaster even and light, I covered the scene to represent snow.



## WHAT'S NEAT | 22



28. I set the scene up outside and shot photos in various lights -- sunrise, cloudy day, and full sun. Then I shot a photo under tungsten floodlights. After reviewing these four photos, Blackstone Models chose the cloudy day shot. Lucky for me, I shot a photo of a wreath at a shopping center about one hour after shooting the cloudy day model photo. This meant the lighting would match if I Photoshopped the wreath onto the front of the HO scale K-27 model locomotive. It worked!



[Click here for  
reader comments](#)



29. This is the final finished model photo. It captures the original photo with the flavor of wilderness surrounding the train and the snow and colors in the wreath creating the sense of Christmas. In the video this month, you can watch the whole process from start to finish as I work through the model photo design process in real time.



**Click here for  
reader comments**

## Neil Enock interview



30. This month we meet Neil Enock, movie producer, prop builder, and author. In the video, he takes us through his studio workshop where he builds props for TV shows and movies. He was involved in the production of the “Hell on Wheels” TV series covering the American history of the building of the Union Pacific end of the transcontinental railroad. Neil shows us his new Christmas book, *Doc Christmas, The Magic of Trains*. The story plays out in the miniature world of model trains. During the interview, Neil points out that he is sitting inside a full-scale model of the plastic Atlas train station kit all of us are familiar with. You can see the part numbers and the mold injection lines on the full-size mockup interior. Neil shows us movie props he is working on, and tells us more about his fascinating career, in this month’s video. See [neilenock.com](http://neilenock.com) for more on Neil’s work and to find links to his Christmas book.

# WHAT'S NEAT | 26

With that, let me wish you a happy holiday season and a very prosperous new year. Don't forget to rate the column using the reader comments link.



**Click here for  
reader comments**

## ADVERTISEMENT



**COMING SOON  
IN HO SCALE!**



**We plan to produce an HO Scale version of our very popular Mt. Albert Lumber Yard kit later this year. Please watch our website and Facebook page for more details.**

## ADVERTISEMENT

**Backdrop Junction**  
Your Stop for Railroad Backdrops

**Click Here** →

**For the Finest in Custom  
Designed backdrop**



[www.backdropjunction.com](http://www.backdropjunction.com)

• INDEX

• TABLE OF CONTENTS



# MRH MARKETPLACE

FEATURING  
**America's Historic  
Main Street Architecture**



O-Scale model shown (HO available)

**MAINSTREET  
HERITAGE**

[www.mainstreet-heritage.com](http://www.mainstreet-heritage.com)

**When talking  
to hobby  
vendors,  
please  
remember  
to mention  
MRH.**

## CROW RIVER PRODUCTS

HO Scale Kit 214 Stiff Leg Derrick  
Shown With Kit 215 Hoisting Shed



**HO & O Scale Machinery, Derricks,  
Engines, Hardware & Waterfront Models**  
Pawtucket, RI 02861 Tel 401-723-0065  
[www.crowriverproducts.com](http://www.crowriverproducts.com)  
We Accept Visa Master Card- Discover and PayPal

The B BUILDING & STRUCTURE Co.  
**banta modelworks**



**Chama Depot**

in HO scale all laser cut wood  
#2098 \$148

421 Hopkins Road, Dummerston, VT 05301

800-653-8214

see all of our fine products from HO to F/G scales at:

[www.bantamodelworks.com](http://www.bantamodelworks.com)

**LIGHTS 4 MODELS**



NEW PRODUCTS  
ADDED MONTHLY

LED lights, Animated Signs, & Sounds  
[www.lights4models.com](http://www.lights4models.com) 614-296-8691

**BELIEVE!**

ADD SOME  
HOLIDAY  
DECOR TO  
YOUR LAYOUT

**Shop Now**

[Click here for our website](#)

**LOOK**  
at what's new at  
Black Cat this month

**ACL# 24165**  
**box car**



**Black Cat Publishing**  
(204)489-5005  
[ajfergus@mymts.net](mailto:ajfergus@mymts.net)  
[blackcatdecals.com](http://blackcatdecals.com)



**PRE-SIZE**  
MODEL SPECIALTIES

Cast resin items for All Scales.  
Tunnel portals, bridge piers, abutments, culverts, and retaining walls.  
Trackside details and sage brush tree armatures.  
"FREE SHIPPING see website for details"

P.O. Box 6 Paonia, CO 81428  
Ph. 970 527 4586  
Made in The USA

Trees



HO

[coastmans.com](http://coastmans.com)



KC's  
Workshop

Craftsman Model Kits  
[www.keworkshop.com](http://www.keworkshop.com)  
[www.facebook.com/keworkshop](http://www.facebook.com/keworkshop)

MODEL RAILROAD

BenchWork



Affordable Modular (domino)  
Benchwork in 200+ sizes  
Custom built to order benchwork also available!



*TAM Industries*

"Preserving the Romance"

The highest quality in Display Cases for sharing your excitement of Model Railroading. We manufacture Display Cases for all gauges of Model Railroading, from "G" to "N". Custom Sizes are available for some styles.



Visit us today at: [www.TAM-IndustriesOnline.com](http://www.TAM-IndustriesOnline.com)

NEW!

Fusee Pro/M

The /M means it's **Mobile!** Track-powered, move it wherever you need it!

LOGIC RAIL™  
TECHNOLOGIES



"Sophisticated  
Model Railroad  
Electronics"

Please visit our website and online store!

21175 Tomball Pkwy  
Suite 287  
Houston, TX 77070

Phone: (281)251-5813  
<http://www.logicrailtech.com>  
[info@logicrailtech.com](mailto:info@logicrailtech.com)



**JEFF OTTO**  
TURNIN' it OUT  
414-915-4671  
ohrtracksupply.com  
jeff@ohrtracksupply.com  
N36W23431 Oak Hill Ln.  
Pewaukee, WI 53072

CLICK HERE



**CANYON CREEK**  
SCENICS



THE LAND OF PERFECT SCALE SCENERY AND TREES



ATSF 271020  
The Grand Canyon Line

**Yarmouth Model Works**  
HO scale resin kits and detail parts

U.S.A. MAILING ADDRESS  
3560 Pine Grove Ave., Unit 617  
Port Huron, MI 48060

CANADIAN MAILING ADDRESS  
85 Hiawatha St.  
St. Thomas, ON N5P 2T5

Tel. 519-633-7574  
pierre.oliver@start.ca  
www.yarmouthmodelworks.com



DID YOU KNOW  
MRH SUBSCRIBERS  
GET FREE BONUSES?  
CLICK TO SUBSCRIBE  
NOW - IT'S FREE!

**HOBBY  
MARKETPLACE**  
ads are  
economical and  
effective.  
Click HERE to learn more.



PRECISION DESIGN CO

Chains  
Flat Car loads  
Joint Bars  
Signs & Posts

FREE SHIPPING

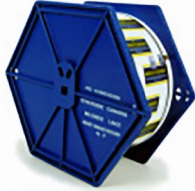

## HO DIESEL SUPPLY

KATO EMD SD SPECIALIST-REPAIRS-UPGRADES  
New and Rebuilt Locomotives  
Powered Chassis-Trucks-Motors  
Bodies and Parts-Handrails-Electronics

[www.hodieselsupply.com](http://www.hodieselsupply.com)

email:kato@hodieselsupply.com

## GOODDEALSdcc

[WWW.GOODDEALSdcc.COM](http://WWW.GOODDEALSdcc.COM)



HOME OF THE  
PROGRAMMER TEST TRACK SYSTEMS

DC & DCC COMPATIBLE  
ALL SCALES AVAILABLE  
CUSTOM ORDERS  
DEALER INQUIRIES WELCOME

GARY COHN  
106 CENTER STREET  
FOX RIVER GROVE, IL 60021  
GARY@GOODDEALSdcc.COM

## Model Railroad Control Systems

Geoff Bunza Project Boards  
DCC Occupancy Detectors  
CMRInet Compatible Nodes  
Layout Telephone Systems  
RFID Switchlist Generator  
Switch Machines and Drivers



## MOUNTAIN SUBDIVISION HOBBIES

[www.modelrrsupply.com](http://www.modelrrsupply.com)

FREE USA SHIPPING OVER \$29.00

NCE - SOUNDTRAXX - DIGITRAX - PECO - CIRCUITRON  
DCC SPECIALTIES - INTERMOUNTAIN - CMX - ATLAS  
BAR MILLS - BOWSER - KATO - MRC - TOMAR - RIX -  
PIKESTUFF - LOGICRAIL - CENTRAL VALLEY AND MORE!

## RULERS-of-the-WORLD

Scale Rulers \$4 each

Over 200+ scales!

Metric or Imperial

[www.rulers-of-the-world.com](http://www.rulers-of-the-world.com)

## Great Decals!™

FEC, Interstate, Virginian  
Railway, & L&N Titles

After Hours Graphics Line

Coupler Gages and More

In O, S, HO, and N Scales



## 2017 Trolley Calendar

Color cover, 13 B&W photos with  
descriptive captions from mid-  
Atlantic area:

PTC, PST, LVT, D.C., NY, PSCT and  
others.

\$10 +\$2 S&H

To order the calendar by check or  
money order (payable to East Penn  
Traction Club), please send to:

East Penn Traction Club

c/o Charles Long

227 Locust Road

Fort Washington, PA 19034-1425

[click HERE to learn more](#)

Your ad could be in  
this space for as low  
as \$28 a month.

[Click to learn more ...](#)

Have you seen these popular blogs on the MRH website?



**Tom Johnson's L&N**

305,000 reads

[CLICK TO READ IT NOW](#)



**Ken Glover's Shelf Layout**

102,000 reads

[CLICK TO READ IT NOW](#)



**New Kits Available:  
S-40-1 Pressed Steel U/F  
Stock, LA&SL, OSL,UP**



[westerfieldmodels.com](http://westerfieldmodels.com)

**BENCHWORK.COM**

Affordable built to order Benchwork starting at only \$20 a Sq Ft.

**CLEVER models LLC**

Cardstock models & materials

Try one today!

[www.clevermodels.net](http://www.clevermodels.net)

**WIN**  
**\$250**

***from MRH***

***New  
Subscriber  
Sweepstakes***



Drawing on  
January 1, 2017

Become a new MRH  
subscriber in December,  
and get entered into a  
drawing for \$250 cash!

**SUBSCRIBE NOW >>**

***Subscribing is FREE!***



# A modeler's introduction to the **Arduino**

BY DR. GEOFF BUNZA

*Photos by the author*

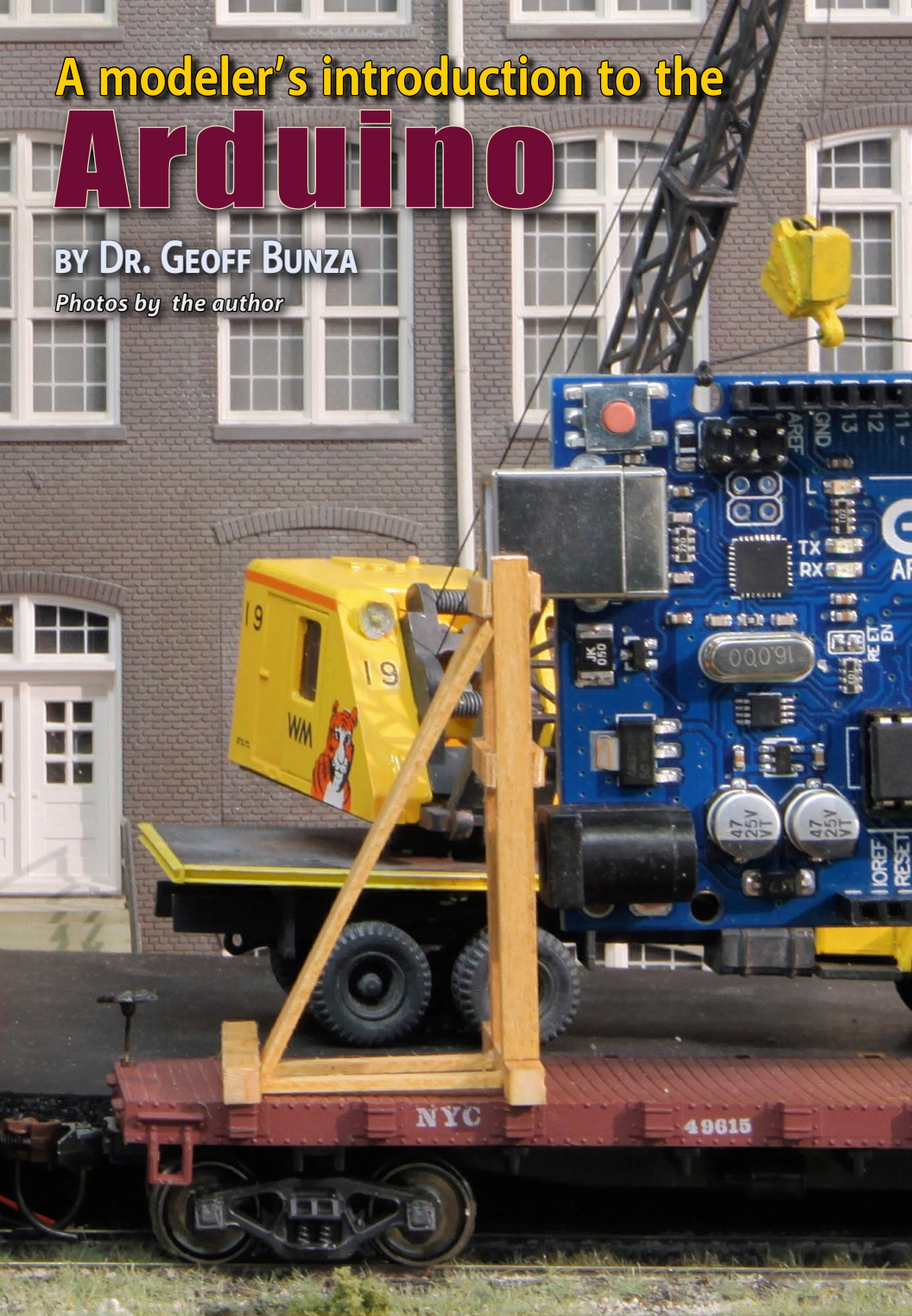

• INDEX

• TABLE OF CONTENTS

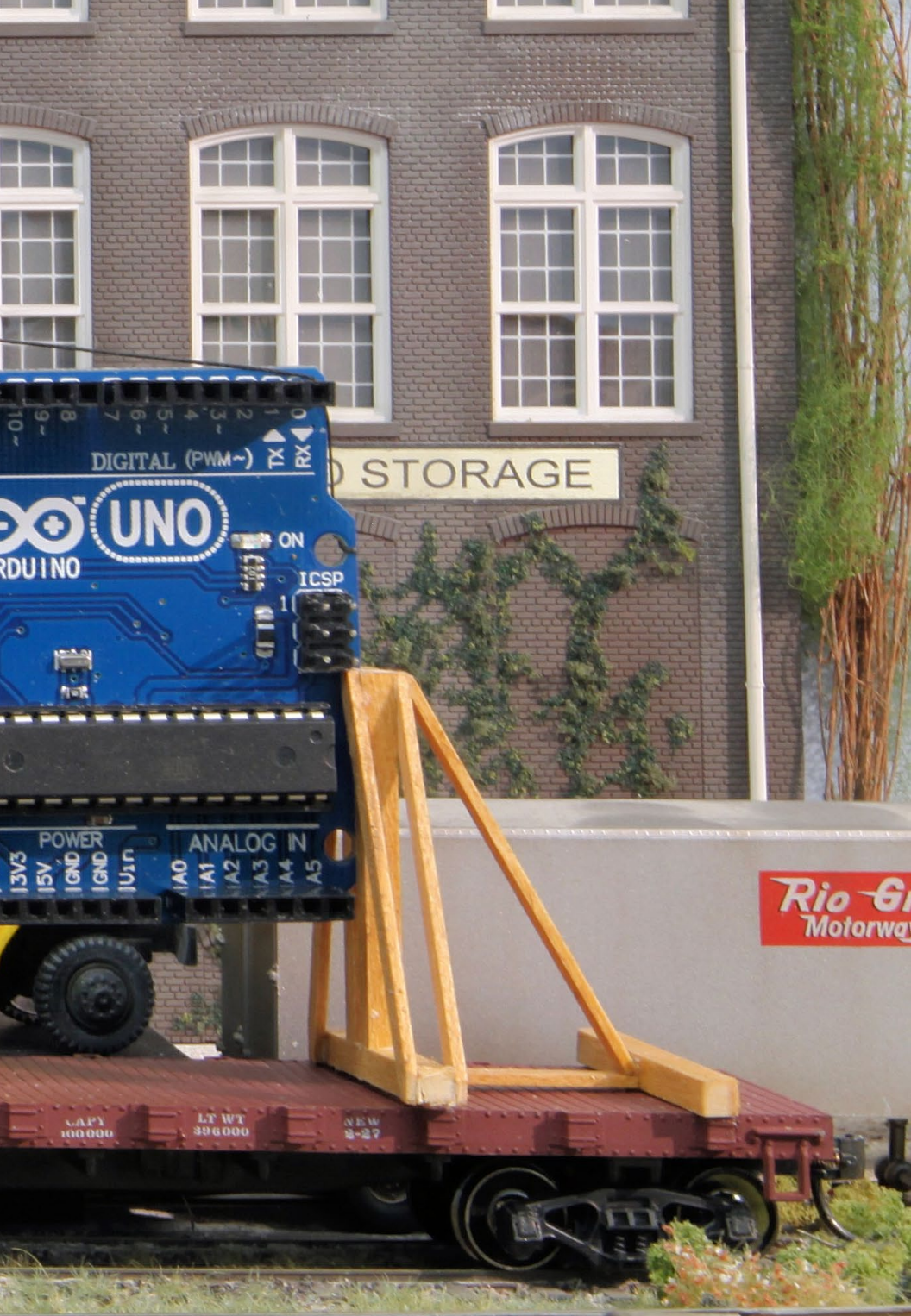



[Click here for  
reader comments](#)

## **MODEL RAILROADERS THROW SWITCHES ALL**

the time – to turn on the power, to switch a track, to blow a whistle, to turn a light on or off, and more. But what if you had a little automated help?

Suppose you want to easily set up a route through a yard, or display a sequence of lights on a movie marquee? Maybe you would like to model a welder in action, or to simulate a thunderstorm?

My approach here is to introduce non-technical modelers to some easy but useful projects like these without getting buried in the technical jargon. I'm focusing more on the do-it-yourself basics, and I'm not diving into all the technical details of how it works.

For the purposes of this article, just know it works, let's not be overly concerned with the details of why.

Anyone can put these projects together, some with little or no soldering. You will not need to read a schematic or program a computer. However, you may need some imagination to envision all the possibilities available to enhance your modeling!

## **Introducing the Arduino**

The Arduino is a user-friendly board family for building electronics projects. While physically different, the various boards in the Arduino family all perform many of the same basic functions, controlled by a very small but powerful microcomputer chip.



**Arduino Uno**

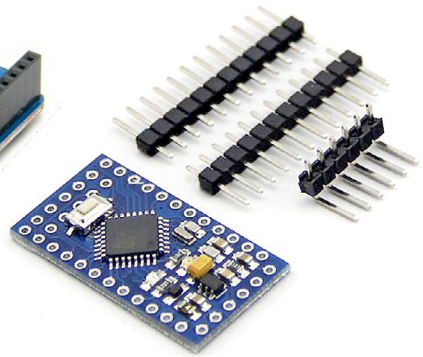

**Arduino Pro Mini**

2. Here is the Arduino Uno board and the Arduino Pro Mini board with “header pins” that fit into the board holes. As you can see, connecting to the Uno is easier than with the Pro Mini, but the Mini is far more compact and costs less. Both function the same.

## What is the Arduino?

“Arduino” is an Italian name for a group of electronic control boards that are low cost, small, and remarkably useful. While physically different, they all perform many of the same basic functions.

In this article, I use two small boards in the family, the Uno and the Pro Mini [2]. The Uno is easier for a novice to use, but is larger and costs more. At the time of this writing, the Uno costs between \$8 and \$20, depending on where you purchase it.

The smaller Pro Mini will substitute for the Uno without modifying the project instructions and can be found for as low as \$2. The Uno is easier to connect to, so we start with it. ■

# MODELER'S INTRO TO THE ARDUINO | 5

Originally, the Arduinos were created for use as a digital electronics and software teaching tool. All aspects of their design and construction are totally open and available for public use rather than being proprietary. In this article, I use two small processor boards in the family, the Uno and the Pro Mini [2].

An Arduino project consists of both the programmable board and some instructions called “sketches” in the Arduino world. To provide the sketch instructions to the board, you use an app on your home computer called an IDE (Integrated Development Environment) to edit and load the instructions into the board’s memory. See the [bonus downloads](#) for IDE instructions.

The instructions tell the Arduino what “switchable connection points” to turn on or off, and in what order and at what time.

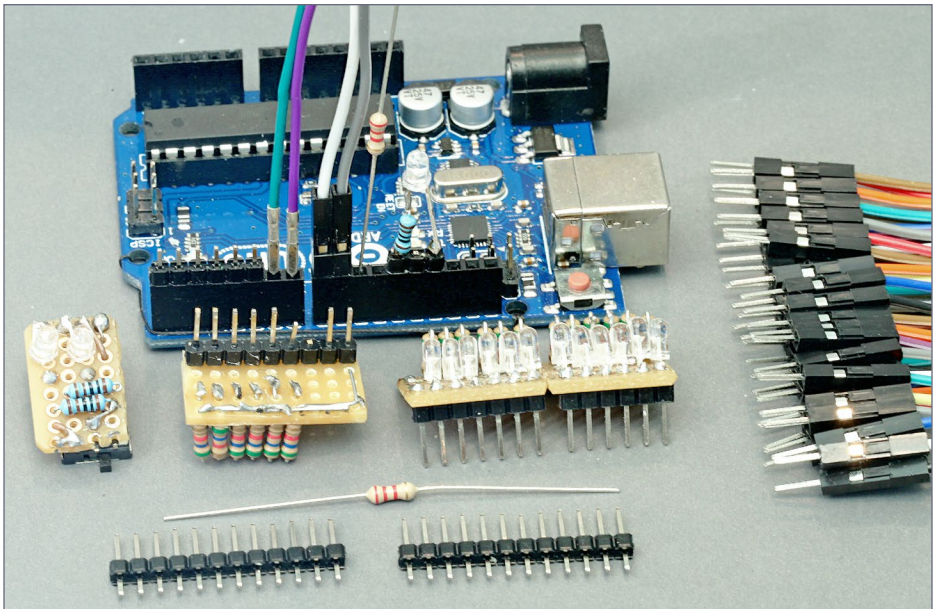

3. The larger Uno board has “header pin sockets” that easily allow plugging in wires and components like resistors to the board. Here I built some other pluggable boards too using LEDs and resistors.



## What this article is and is not

Normally, an article on a technical subject like this would start with basic concepts and terminology, and then move on to describing the tools, the process and usage. And of course, there would be plenty of very technical footnotes all along the way.

But this article is for modelers *and we want to have some fun!*

I'm focusing here on interesting projects that take a minimum of effort. Project categories include lighting, servo control, and sound generation. Any project can be just a one-time effort, or together these projects may start you on a new sub-hobby.

For the more technically savvy, Arduino development includes a fully Integrated Development Environment (IDE) that incorporates a GNU GCC optimizing compiler. The IDE is automatically configured for a family of dissimilar microprocessor modules via background scripts and file descriptors. This is all enabled by freely available libraries covering a wide range of drivers and sensors. This platform directly supports C, C++, and object oriented programming.

Are you lost yet?

Rather, this article takes the simpler route of whetting your appetite by showing how to easily use a \$2 device (the Arduino Pro Mini) to align various routes through a yard, ring bells, sequence lights, model a welder, create a thunderstorm, and maybe perhaps bring things to life on your layout that could even impress non-modelers!

Indeed, a tech savvy modeler should appreciate this too. ■

---

# MODELER'S INTRO TO THE ARDUINO | 7

Both the Uno and the Pro Mini can be loaded with the same sketch instructions. Both boards have the same number of switchable connection points (pins) that are consistently labeled the same [4].

It often is easier to test out a project on the larger Uno, and then load the same instructions into the smaller and cheaper Pro Mini for final use.

Let's start by getting familiar with the Uno. The Uno is the larger of the two boards and was designed for ease of use and simple interconnection with other companion boards called "shields."

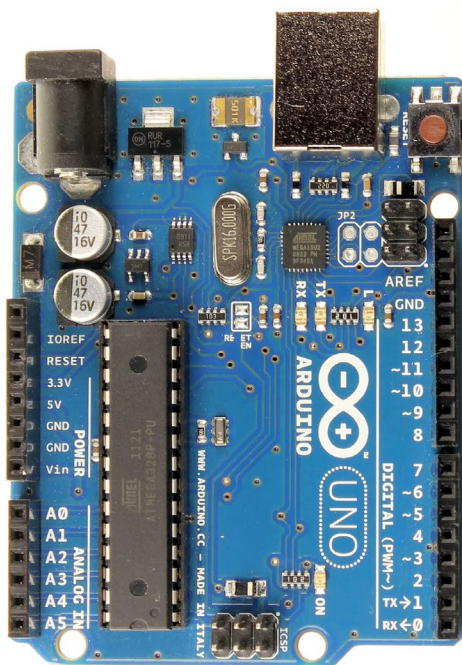

D13  
D12  
D11  
D10  
D9  
D8  
D7  
D6  
D5  
D4  
D3  
D2

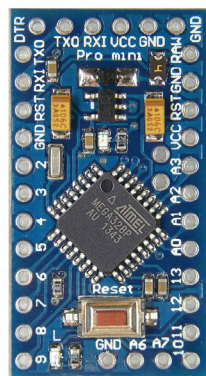

D2  
D3  
D4  
D5  
D6  
D7  
D8  
D9  
D13  
D12  
D11  
D10

**Pro Mini**

**Uno**

4. The Uno and the Pro Mini have the same digital pin numbers, as you can see here. This allows starting a project using the easier-to-test-with Uno and then copying the final tested instructions into the Mini for deploying the finished project.

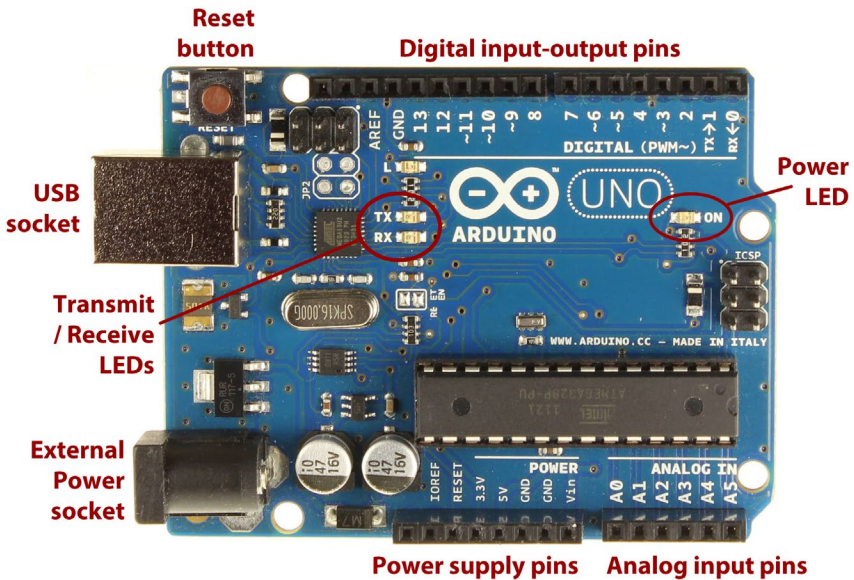

## Arduino Uno board “basic layout”

Version R3

5. The Uno has this basic layout: a USB socket, external power socket, reset button, some LEDs on the board, and a number of connection points using header pins (digital, analog, and power).

## The Arduino Uno

Notice the Arduino Uno has connection points around the edge as female pin sockets [3, 5] into which you can plug wires, components like LEDs and resistors, and special “shield” board pins to form a stack [6, 7].

Shield boards neatly enhance the capabilities of the Uno. Two common shield boards are a motor control shield and a sensor shield.

The motor control shield allows the Uno to power high current devices: I will provide an example of its use later in a sample project.

The sensor shield actually has no sensors itself. Instead, it provides a connection to all the switchable pins on the Arduino Uno

# MODELER'S INTRO TO THE ARDUINO | 9

side by side with 5 Volt and Ground (GND) pins, allowing easy connection to a number of special sensor modules. But it also turns out, this is precisely the right arrangement for easily connecting with servo motors too!

You can insert wires and component leads directly into the Uno sockets or use “header pins” and solder connecting wires to the pins. The header pins allow disconnecting or changing your wiring fairly easily. Using header pins is quite reliable and I heartily recommend their use [3].

The website Pololu.com ([pololu.com/category/71/wires-with-pre-crimped-terminals](http://pololu.com/category/71/wires-with-pre-crimped-terminals)) offers a wide selection of wires with the appropriate pins already attached. Or you can search for “jumper wire” to find other sources.

6. Here are some of the the add-on “shield” boards that you can plug into the header pin sockets on the Uno board. See text for details.

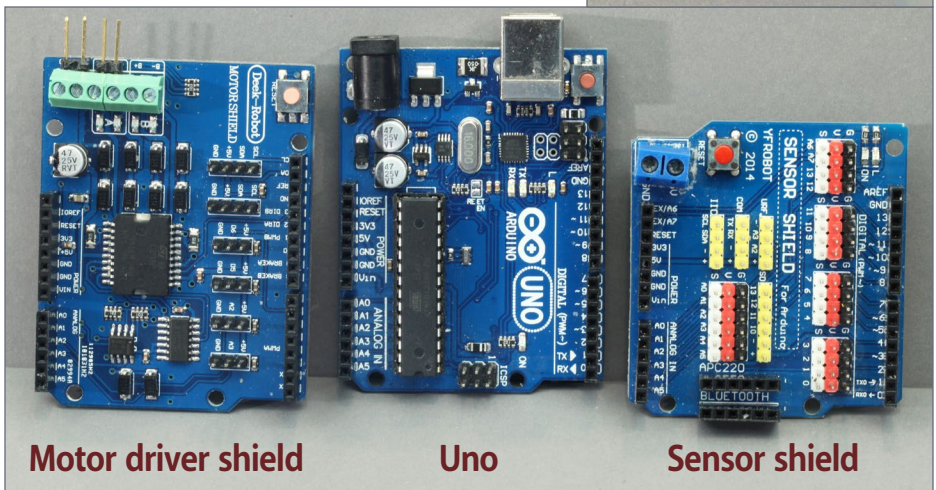
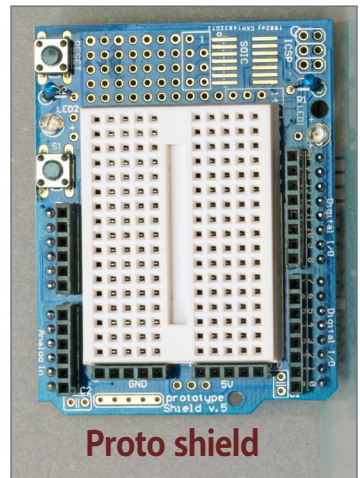

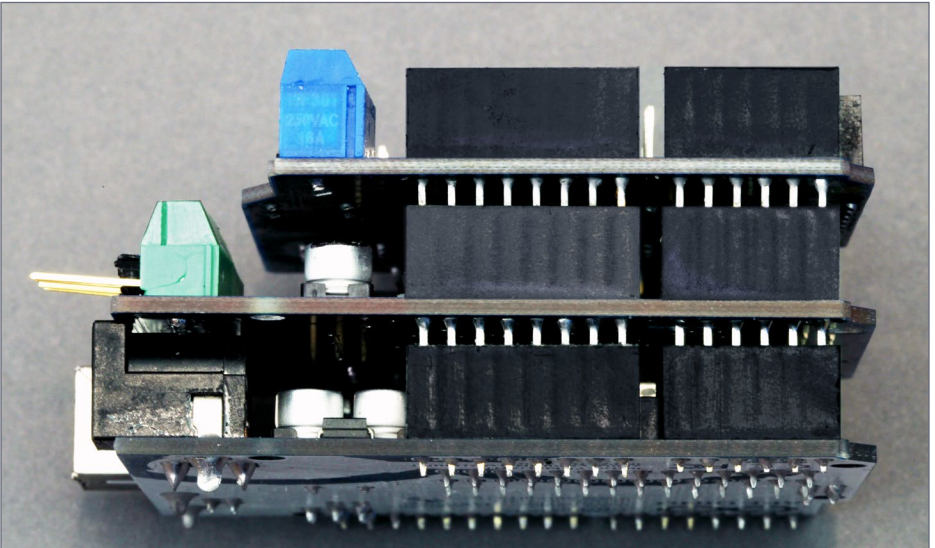
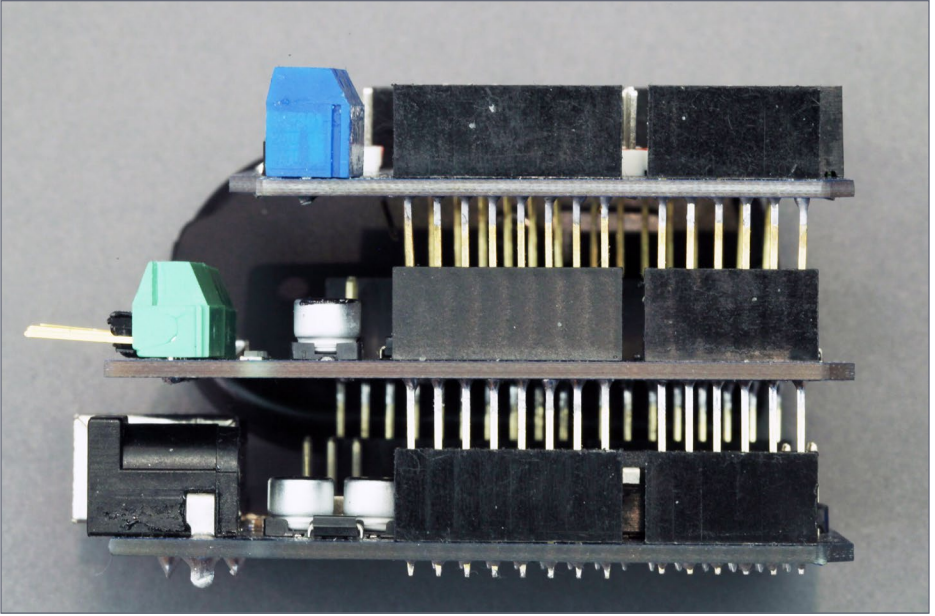

7. In this photo, you can see how the shield boards “stack” onto the Uno. In the top photo, I’ve aligned the pins, and in the bottom photo, I’ve pushed the boards all the way together. The Uno is on the bottom, the motor and sensor shields above.

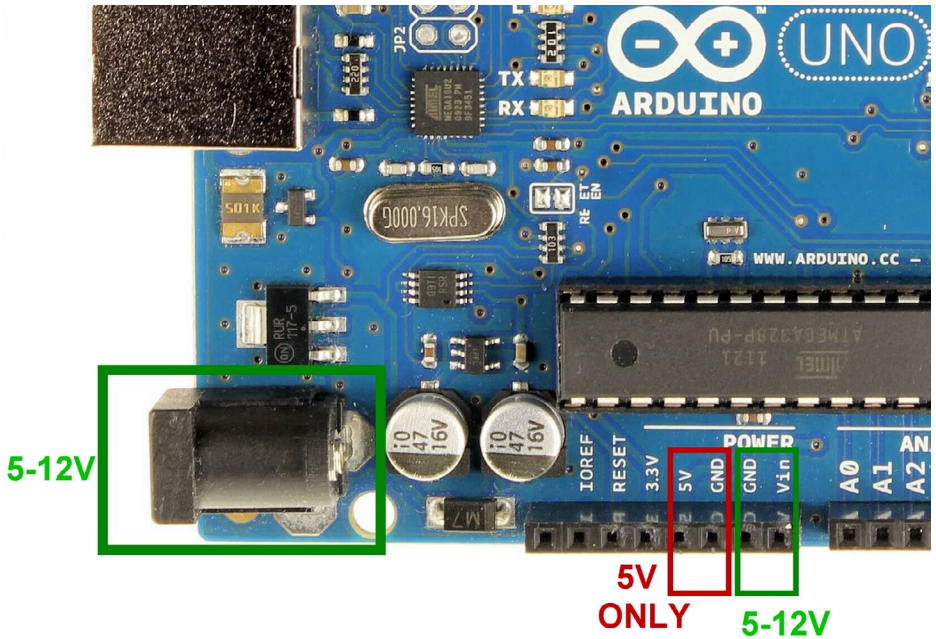

8. Here are the different options for getting power to the Uno.

MRH has already published a guide to the Arduino **Pro Mini** in the November, 2014 issue, see: [mrhpub.com/2014-11-nov/land/#99](http://mrhpub.com/2014-11-nov/land/#99).

## Powering your Arduino board

You can power the Uno with 5-12 volts DC power, including DC power supplies, batteries and small power adapters with a 2.5mm barrel connector (center positive with 5-12 Volts DC) either through the power socket or by feeding wires directly to the GND and VIN pin sockets on the Uno [8].

Or you can also feed 4.5-5.2 volts directly to the GND and 5V pin sockets on the Uno [8].

Finally, these boards can also get power just from the USB cable.

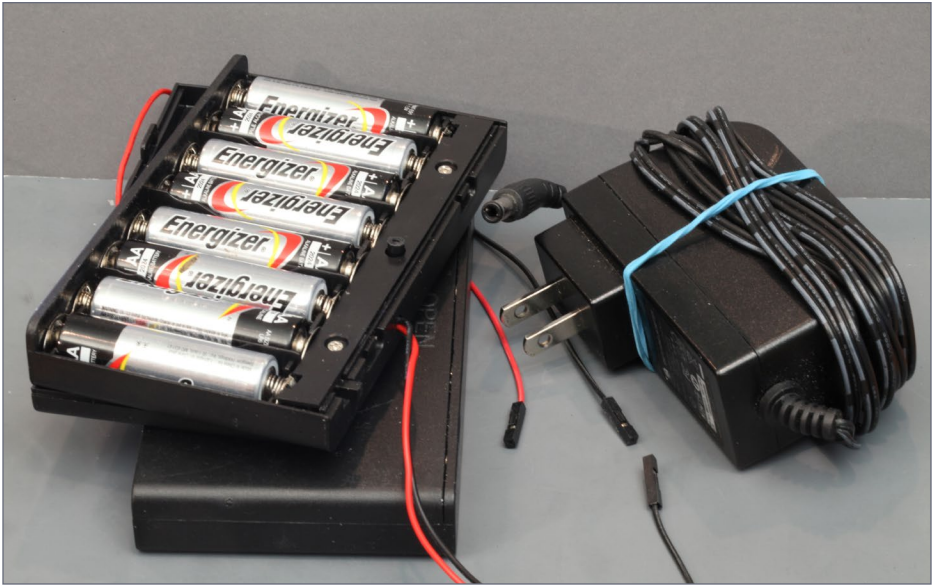

9. To source the power for your board, you can use either an eight AA battery pack (on left, 12V), or a 9V wall wart power adapter (on right) with an Arduino 5.5x2.5mm barrel plug.

Any of these power feed methods works, just pick one.

By itself an Arduino consumes very little power. I have built a Pro Mini controlled DCC board that operated an animation with a motor, lights and sound for more than 24 hours total just on eight AA batteries!

When it comes to the board's current limits (amperage), any one pin on the Uno can handle a max of 40 milliamps, with the total current through all the pins not exceeding a total of 200 milliamps (ma). However, keep in mind it's the total current actually being drawn that we're talking about, not the rated current.

To see how this works, read about a real-life example I did using eighteen LEDs in the sidebar: LEDs and Arduinos.

## LEDs and Arduinos

An output pin of an Arduino can switch back and forth from 0.0-0.5 volts (LOW) to 4.5-5.0 volts (HIGH), and can handle currents up to 20ma per pin. However the total current handled by all pins must not exceed 200ma.

So if we want to light up eighteen LEDs at the same time [12], then we must limit the current to each LED down to 10 ma or lower, or light up fewer LEDs simultaneously. Fortunately, this is easy to do.

Each LED we use in these projects has its own “limiting” device called a resistor. These are quite cheap and readily available from many sources, including the ubiquitous Radio Shack.

Resistors are rated by a value of resistance stated in Ohms, and an associated power rating in Watts (w) – like a light bulb. Resistors in the range from 1,000 to 10,000 Ohms and any of either 1/4w, 1/8w, or 1/6w (available from China) will do fine here.

The higher the value (in Ohms) resistor the more dim the LED will glow. I recommend getting and keeping a range of values in your collection, like 470, 680, 1000, 2200, 4700, 5600, 6800, and 10,000. This way you can run tests to determine what an acceptable value will be for you to use in your electronic modeling projects.

LED manufacturers have dramatically improved the



10. LED examples.



efficiency of LEDs over the last 20 years. The red LED pictured [10] was manufactured in 1981 and can barely be seen when powered with 18 ma. The small LED (second from the right) is so bright at 20 ma it hurts your eye to look into it for more than a fleeting glance.

The small green LEDs I use [11] light up very brightly at less than 0.2 ma. These are modern examples of what's currently being made.

This efficiency difference is what is missing from most modeler discussions of LEDs and why I avoid formulas and equations in suggesting what resistor values to use.

Just keep a collection of various resistance values on hand and try several using the LEDs you will actually use in your project. Start with the highest value resistors (dimpest LED) and work down, until you get a pleasing brightness.

The vast majority of modelers' LEDs have metal leads similar to those pictured. Note that four of the five LEDs have a long and a shorter metal lead. The longer lead goes to the positive voltage if you want the LED to light up. The shorter lead is the negative side and is usually connected to GND or Ground (as labeled on the Arduino).

In additional reading, you may find the positive LED lead called the "anode" and the negative LED lead called the "cathode."

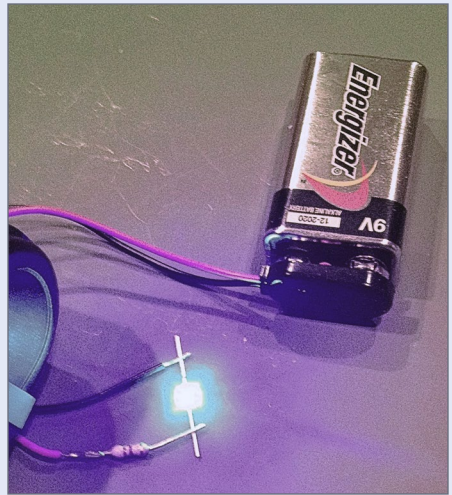

11. This blue LED is being checked with a simple 9 volt battery and 470 Ohm resistor.

# MODELER'S INTRO TO THE ARDUINO | 15

Also note the red LED on the left [10] has 2 leads of the same length. There is an easy way to identify the positive and negative leads on this type of LED – and test it at the same time! Get a 9 volt battery and a battery connector (Radio Shack #2700325) along with a 470 Ohm ¼ Watt resistor (Radio Shack #2711317).

Connect one side of the resistor to the Red wire of the 9 volt battery connector (solder it or just twist it on). Touch the free end of the resistor to one leg of the ‘unknown” LED and touch the black lead from the battery connector to the other leg of the LED. If the LED does not light, reverse the connections to the LED.

When the LED lights, you will know that the black lead is connected to the negative side of the LED. It will also indicate whether or not you have a working LED. For the vast majority of LEDs you will use in modeling, this test will work fine. ■



11. I wired all 18 LEDs shown here with 10k resistors, resulting in a total combined current draw for all the LEDs of less than 20ma – well below the Uno's 200ma board limit.

## Let's look at some projects

Let's look at a range of easy projects that can enhance your layout. I have divided them into lighting control, servo control, and sound generation. These projects do not require any complex computer interfacing but are simple stand-alone projects using just the Arduino and some electronic components, which is why I chose them.

**Controlling these projects:** Okay, let's say you build one of these projects. So where is the on/off button?

For most of these projects, the "on/off button" is pin 14 (A0). On the Arduino, this is a master control pin that when set LOW (connected to Ground or dropped to zero Volts) turns off the project's function(s). When set to HIGH (a voltage greater than 3.5 volts or more), the board turns on.

One fun way to control this pin is with a special sensor that senses heat using infrared light called a PIR Sensor [12].

After setting up a project, you make three connections to the PIR sensor. Make one connection to 5 Volts, another to Ground, and finally to pin 14 (the master control pin) and point the sensor away from you.

When you put your hand or body in the field of view of the PIR sensor, the project you are controlling will turn on. When you move out of view to the side, the project continues to function briefly and then stops.

If you put a piece of wood, cardboard or plastic in front of the PIR sensor – it will not respond! It's only activated by your body heat. If you want to create an animation or turn something on

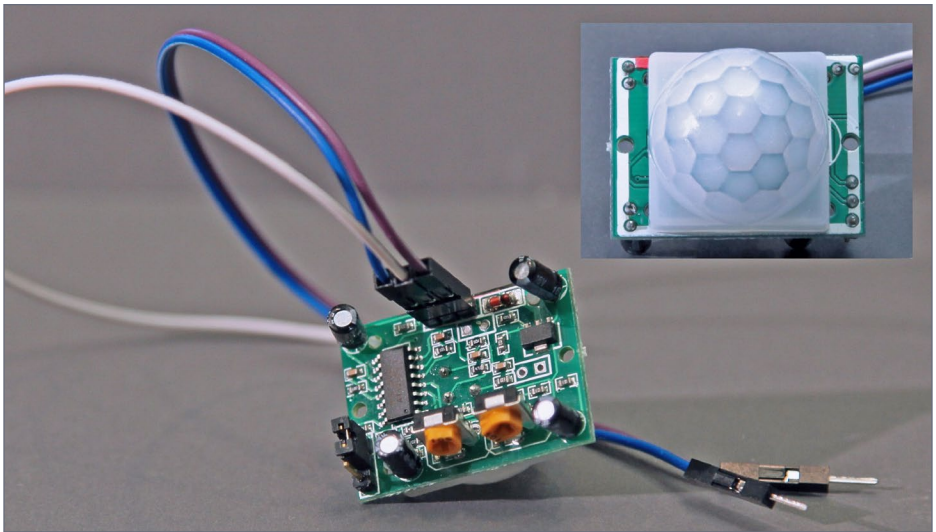

12. Here is a PIR sensor. Use the jumper on the lower left to set to retrigger each time, and adjust the yellow variable resistors to set the time delay and sensitivity.

when a person is in front of your model, put this sensor where it can “see” them come by. How cool is that?

This is great for clubs and public shows as an “attention getter.” You do need to learn how to set the PIR sensor to “retriggerable” (done with a jumper), and then make an adjustment to the two yellow variable resistors [12] to set the “time on delay” and the “sensitivity.”

## Project setup

The following projects all list the sketch file which needs to be loaded onto your Arduino (see the subscriber bonus downloads). I describe the sketch loading process a special how-to supplement in [this issue's bonus downloads](#).

# MODELER'S INTRO TO THE ARDUINO | 18

Projects that include the control notation “Control: pin 14 (A0)” indicate using control pin 14 (A0) as the master control pin for turning the function on and off. If you just leave this pin unconnected, then the project starts to function as soon as you apply power to the Arduino board.

The “Setup:” reference in the project points to the specific pictured pin connections needed.

In the project descriptions I highlight key settings (with names used in the sketch) that affect operation and results you see and/or hear. You can use these as is, with no modification. If you like, you can easily edit them and experiment to see what you might prefer for your situation.

Whatever changes you make can be saved for future use. You do not need to understand programming to use any of these, but you can learn if you want!

I am not a proponent of asking modelers to learn how to program – all you need to do is learn how to use this new IDE app – and if you can use a word editor you can use this app. You can take using the IDE as far as you want, but I will say learning to use the IDE can add a great deal to your modeling enjoyment!

In the projects, I use a notation for led\_pins to show which Uno or Pro Mini pins to make the appropriate connections. I use pictures rather than diagrams to give you setup details.

To get the sketches, see this issue’s subscriber bonuses. A step-by-step procedure showing how to setup and load a sketch into your Arduino is [in this issue’s bonus downloads](#).

These projects give you some idea of the capability and versatility of the Arduino for modeling. And they’re just a start!

# MODELER'S INTRO TO THE ARDUINO | 19

Once you decide which project you would like to use:

1. Set up IDE editor on your computer (see [bonus downloads](#)).
2. From the bonus downloads this issue, copy all the files in the **MRH** folder to your Arduino sketches folder – usually: `...\Documents\Arduino\` on a Windows machine.
3. From the bonus downloads, copy all the files in **MRH\_libraries** folder to your Arduino libraries folder – usually: `...\Documents\Arduino\libraries\` on a Windows machine.
4. Wire your Arduino according to the pictures or diagrams.
5. Download the specific sketch to your Arduino using the instructions in the [bonus downloads](#) and enjoy!

## Lighting projects

Watch the video below to see what the lighting projects do.

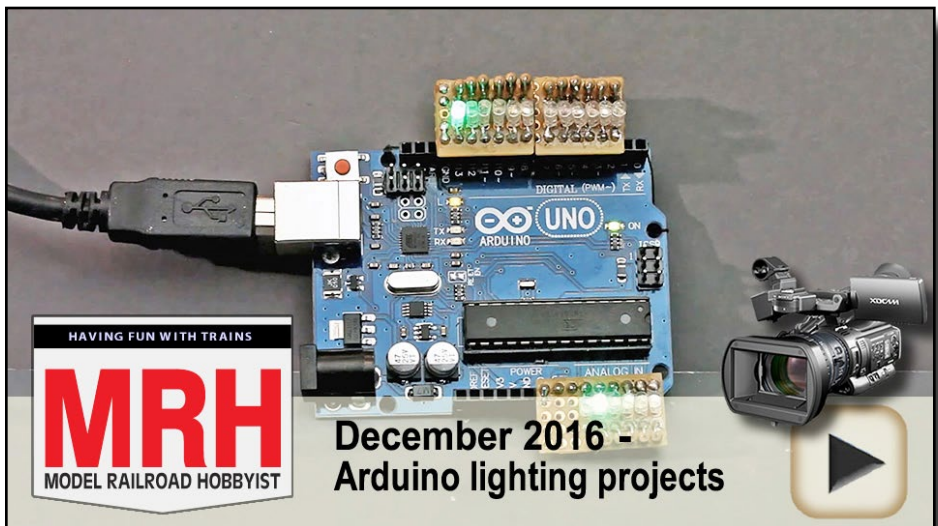

Playback problems? [Click here ...](#)

## BARRIER DIRECTION LIGHTS

**Sketch folder:** Barrier\_Lights

**Setup:** Lights in a row [photo 14]

**Control:** pin 14 (A0)

**Connected pins:** led\_pins - 2,3,4,5,6,7,8,9,10,11,12,13

This project blinks a row of LEDs from the middle out with the timing determined by sketch setting `delta`. The sketch defaults to 300 for `delta`.

For each LED, you can connect the positive leg of the LED to a resistor and then insert the resistor end into any Uno pin. The negative end of the LED needs to connect to Ground. Since Ground is literally the common wire, then all the LED negative connections can be wired together and only a single wire would run back to Uno Ground [13].

I mounted the LEDs and resistors in sets of six with header pins on a small piece of perfboard ([a.co/hWSnKzQ](http://a.co/hWSnKzQ)), see below.

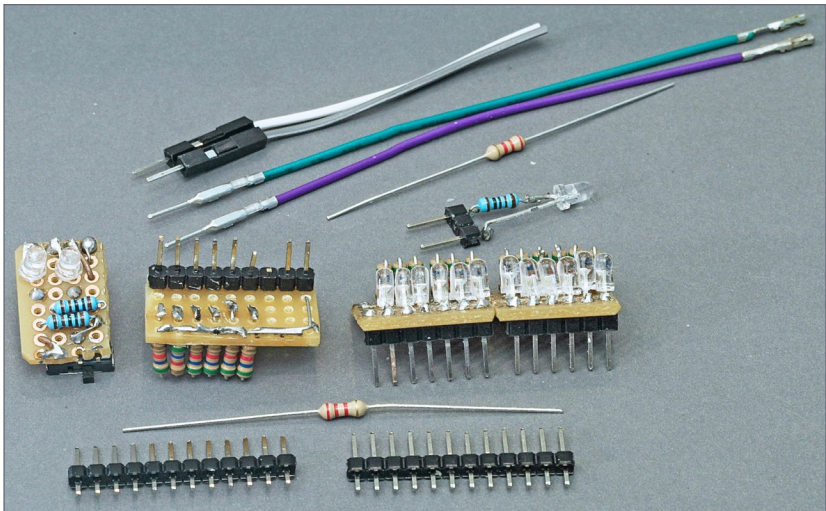

13. Here are the LED wiring components used for many of the lighting projects.

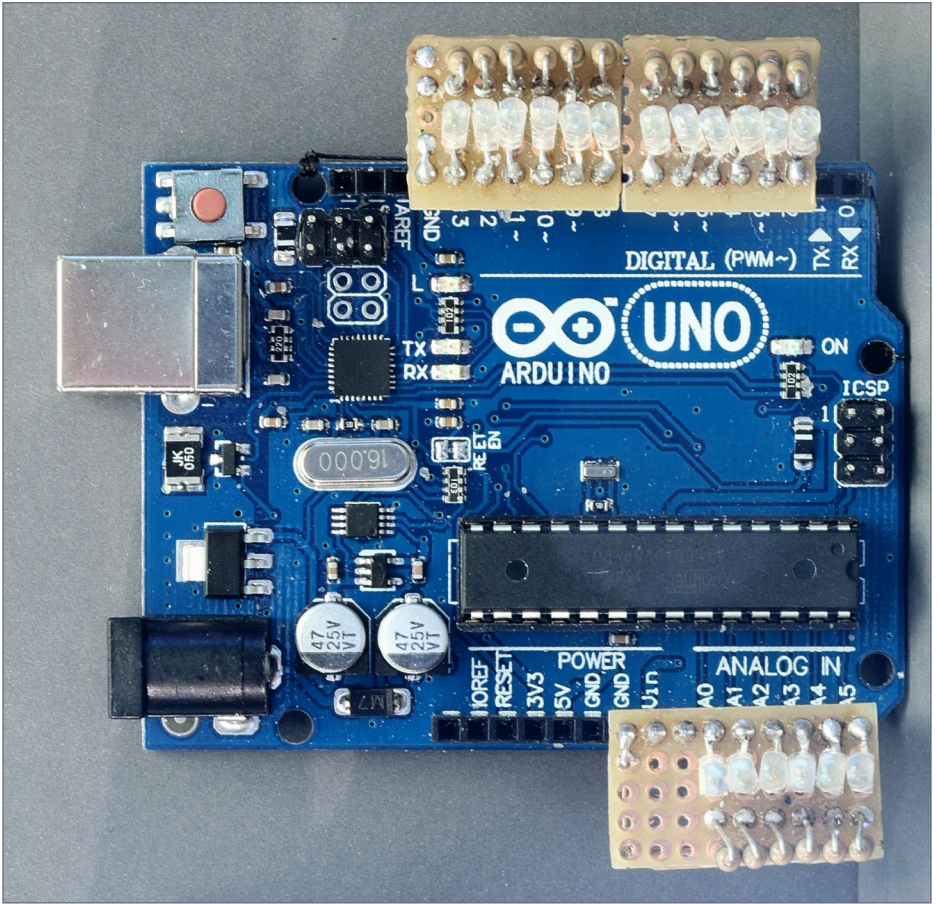

14. Lights in a row setup.



[Click here for reader comments](#)



## BLINK SINGLE LED A NUMBER OF TIMES

**Sketch folder:** Blink\_Single

**Setup:** Single LED [photo 15]

**Control:** pin 14 (A0)

**Connected pins:** led\_pin - 12

This project repeatedly blinks a single LED a **blink\_number** number of times with the timing determined by sketch setting **delta**. The sketch defaults to 6 for **blink\_number** and 95 for **delta**.

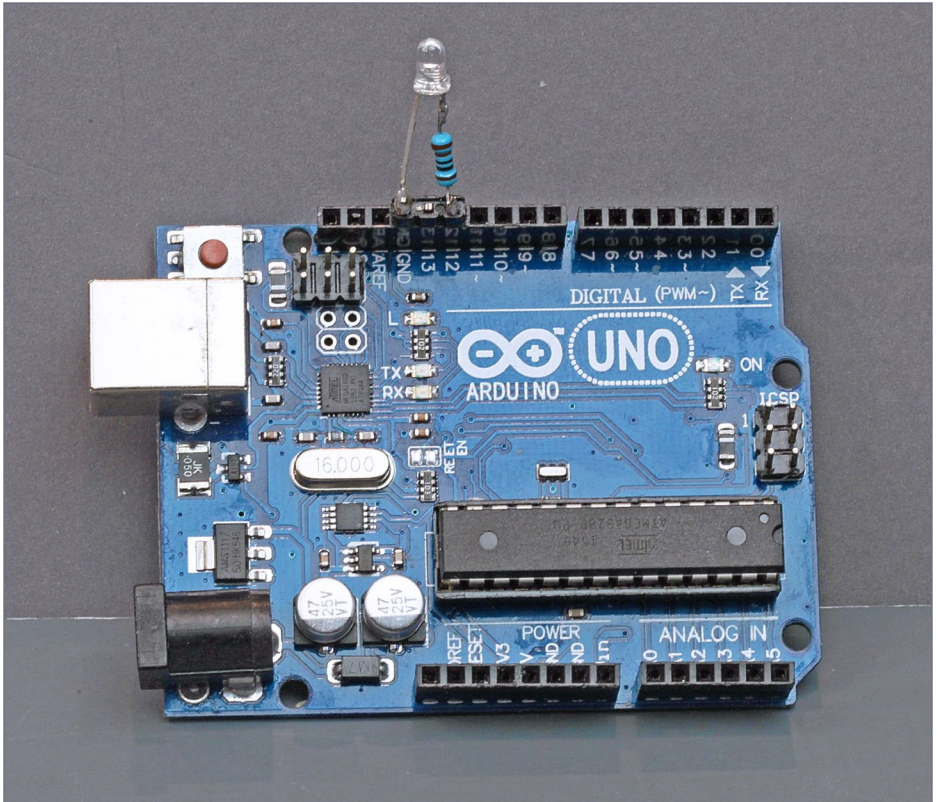

15. Single LED setup.

## RANDOM BUILDING LIGHTING

**Sketch folder:** Building\_Lights

**Setup:** Lights in a row [photo 14]

**Control:** pin 14 (A0)

**Connected pins:** led\_pins - 2, 3, 4, 5, 6, 7, 8, 9, 10, 11, 12, 13, 15 (A1), 16 (A2), 17 (A3), 18 (A4), 19 (A5)

This project randomly blinks 17 LEDs in a random pattern allowing a 60% "ON" time. Timing determined by sketch setting `tim_delay`, which defaults to 1100. People enter a room, turn on lights, stay for some time, and then leave turning off the lights. This sketch tries to account for such behavior with a pseudo-randomness that looks convincing to the casual observer.



16. Random building lights in action on the layout.

## MONOCHROME TELEVISION

**Sketch folder:** BW\_TV

**Setup:** Monochrome TV [photo 17]

**Control:** pin 14 (A0)

**Connected pins:** TV - 12

This project randomly blinks a blue LED in a random pattern simulating a flickering monochrome TV screen. Timing determined by sketch setting `change_delay`, which defaults to 100.

I used was a 3mm white LED that was tinted blue with a permanent marker, and placed it about ¼ inch back from a paper screen I pasted to a scaled down TV cabinet picture.

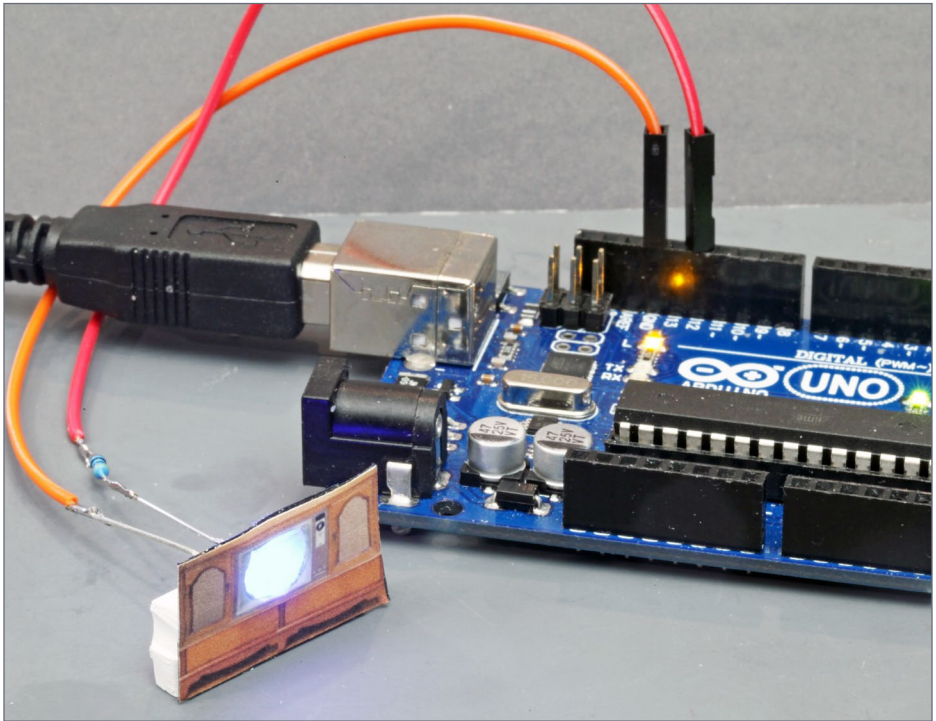

17. Monochrome TV setup.

## CHASE PATTERN FOR THEATER MARQUEE

**Sketch folder:** Chase\_Lights

**Setup:** Lights in a row [photo 14]

**Control:** pin 14 (A0)

**Connected pins:** led\_pins - 2, 3, 4, 5, 6, 7, 8, 9, 10, 11, 12, 13, 15 (A1), 16 (A2), 17 (A3), 18 (A4), 19 (A5)

This project blinks a row of LEDs with a specific pattern defined by sketch setting `chase_pattern`. Default pattern is: 0,1,1,1,1,0,1,1,1,1,0,1,1,1.

Timing determined by sketch setting `delta`, which defaults to 46.

## CHASE PATTERN-2 FOR THEATER MARQUEE

**Sketch folder:** Chase\_Lights2

**Setup:** Lights in a row [photo 14]

**Control:** pin 14 (A0)

**Connected pins:** led\_pins - 2, 3, 4, 5, 6, 7, 8, 9, 10, 11, 12, 13, 15 (A1), 16 (A2), 17 (A3), 18 (A4), 19 (A5)

This project blinks a row of LEDs with a specific pattern defined by sketch setting `chase_pattern`. Default pattern is: 0,1,1,1,0,1,1,1,0,1,1,0,1,1,0.

Timing determined by sketch setting `delta`, which defaults to 76.

This uses a different pattern and different timing to demonstrate what else can be done.

## CHRISTMAS TREE

**Sketch folder:** Christmas\_Lights

**Setup:** Lights in a row [photo 14]

**Control:** pin 14 (A0)

**Connected pins:** led\_pins - 2, 3, 4, 5, 6, 7, 8, 9, 10, 11, 12, 13, 15 (A1), 16 (A2), 17 (A3), 18 (A4), 19 (A5)

This project randomly blinks 17 LEDs in a true random pattern. Timing determined by sketch setting `delta`, which defaults to 300.

This is an example of using the same sketch developed on the Uno, but loaded into an Arduino Pro Mini. Look closely: the Christmas tree is actually mounted on the Pro Mini in the photo below [17].

I used a small bristle brush tree, added some beads, glitter, and “snow” from Woodland Scenics. I used white LEDs colored with permanent ink markers, Tamiya clear acrylics, dyes, and so on.



18. Christmas tree project on the layout (somewhat whimsically.)

## COLOR TELEVISION

**Sketch folder:** Color\_TV

**Setup:** Color TV [photo 18]

**Control:** pin 14 (A0)

**Connected pins:** TVRED - 12, TVGRN - 11, TVBLU - 10

This project randomly blinks red, blue and green LEDs in a weighted random pattern simulating a flickering color TV screen. Timing is determined by sketch setting `change_delay`, which defaults to 150.

I used 0602 prewired LEDs colored red, green, and blue set back ¼ inch from a paper screen glued to a cutout scale TV paper picture. I placed the resistors on a small perf board as a connection strip for the LED connections, and held the jumpers to the Uno.

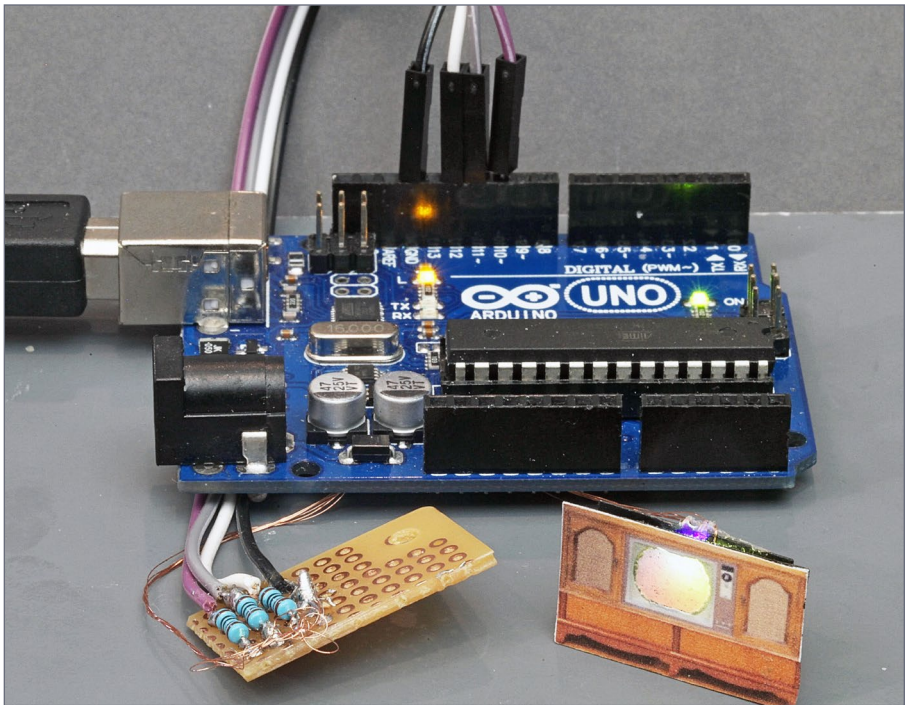

19. Color TV setup.

## FIRE LIGHT

**Sketch folder:** Fire\_Light

**Setup:** Fire light [photo 19]

**Control:** pin 14 (A0)

**Connected pins:** TVRED - 12, TVYEL - 11, TVWHT - 10

This project randomly blinks red, yellow and white LEDs in a weighted random pattern simulating a flickering fire. Timing is determined by sketch setting `change_delay`, which defaults to 100.

This is actually similar to the color TV. Here the I colored the 0602 LEDs red, yellow, and white. The timing is different for each so the order is important – the white is fired intermittently as an exploding coal. The LEDs stick 1/8 inch up into the wood pile of the “fire.”

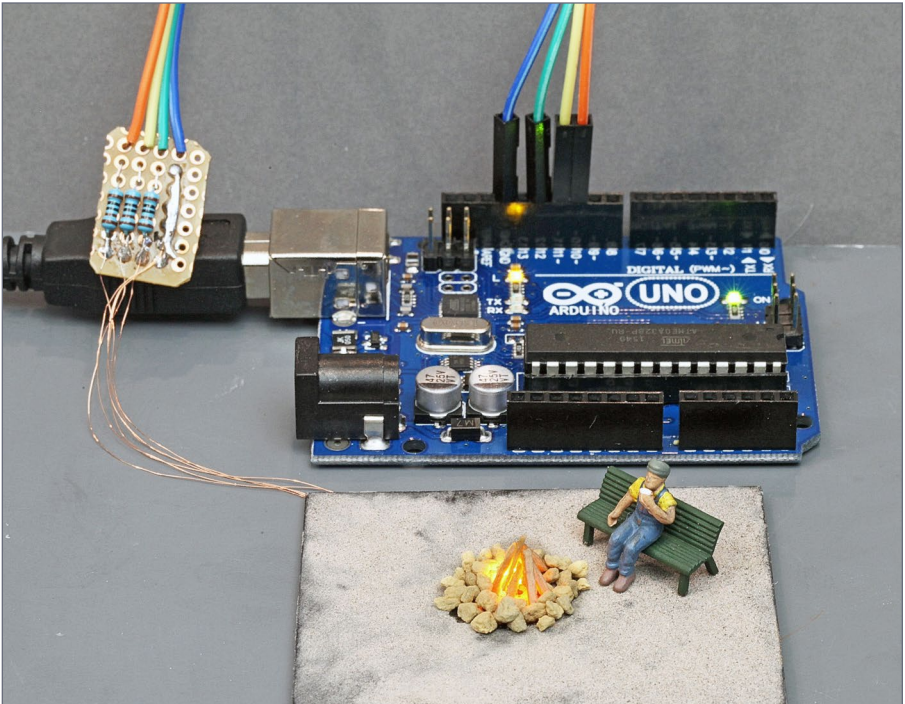

20. Fire light setup.

## ROTATING BEACON OR SEARCH LIGHT

**Sketch folder:** Rotating\_Beacons

**Setup:** Lights in a row [photo 14] or Single LED [photo 15]

**Control:** pin 14 (A0)

**Connected pins:** led\_pin1 - 12 and led\_pin2 - 10

This project repeatedly blinks 2 LEDs with a gradual fade on and fade off. Timing is determined by sketch settings `del-tatime1` (default 700) and `deltatime2` (default 300).

### ADVERTISEMENT

Make LocoNet wiring extremely simple!

**ACCU-LITES, inc**  
Your DCC Center!

Suitcases belong in your baggage cars,  
not under you layout!

Introducing the DCC Vampire II ...  
this guy does the job of two suitcase  
connectors!  
And really holds the connection good  
too!

CLICK NOW TO DISCOVER THE AMAZING VALUE!

Dealer Inquiries Accepted





## AIRPORT RUNWAY LIGHTS

**Sketch folder:** Runway\_Lights

**Setup:** Lights in a row [photo 14]

**Control:** pin 14 (A0)

**Connected pins:** led\_pins - 2, 3, 4, 5, 6, 7, 8, 9, 10, 11, 12, 13, 15 (A1), 16 (A2), 17 (A3), 18 (A4), 19 (A5)

This project blinks a row of LEDs from start to finish with one LED on at a time like airport runway lights. Timing determined by sketch setting `delta`, which defaults to 46.

## STROBE LIGHTS

**Sketch folder:** Strobes

**Setup:** Lights in a row [photo 14]

**Control:** pin 14 (A0)

**Connected pins:** led\_pin1 - 11 and led\_pin2 - 12

This project repeatedly blinks 2 LEDs simulating 2 strobe lights.

Timing determined by sketch settings `ON_TIME1` & `OFF_TIME1` as well as `ON_TIME2` & `OFF_TIME2` respectively.

## WELDER IN ACTION (INDIRECT VIEW)

**Sketch folder:** Welder\_Indirect

**Setup:** Dual LED connections [photo 20]

**Control:** pin 14 (A0)

**Connected pins:** welderpinWH-12 and welderpinBL-11

This project controls two white LEDs: one tinted blue with a marker, to simulate a welding operation with the material being welded not in direct view. By the way, Tamiya clear acrylics also work well for color-tinting white LEDs.

## Servo Motor projects

Watch the video below to see what the servo motor projects do.



Playback problems? [Click here ...](#)

A servo is a motor-driven rotary mechanism that is electronically controlled to allow precise angular positioning and speed control.

Rather than get mired in a lot of details about servos here, let me simply point you at the wealth of info on the MRH site in Peter Randerson's *Servos 101* thread: [mrhmag.com/node/25958](http://mrhmag.com/node/25958).

Low-cost servos are available from many radio control (R/C) hobby sources. Besides driving LEDs, Arduinos can easily drive servo motors directly from each pin.

What may not be obvious is that while a single servo motor can be controlled with one Uno pin, it is not a simple on/off switch. Rather, the Uno is switching the servo control pin on and off about 50 times a second!

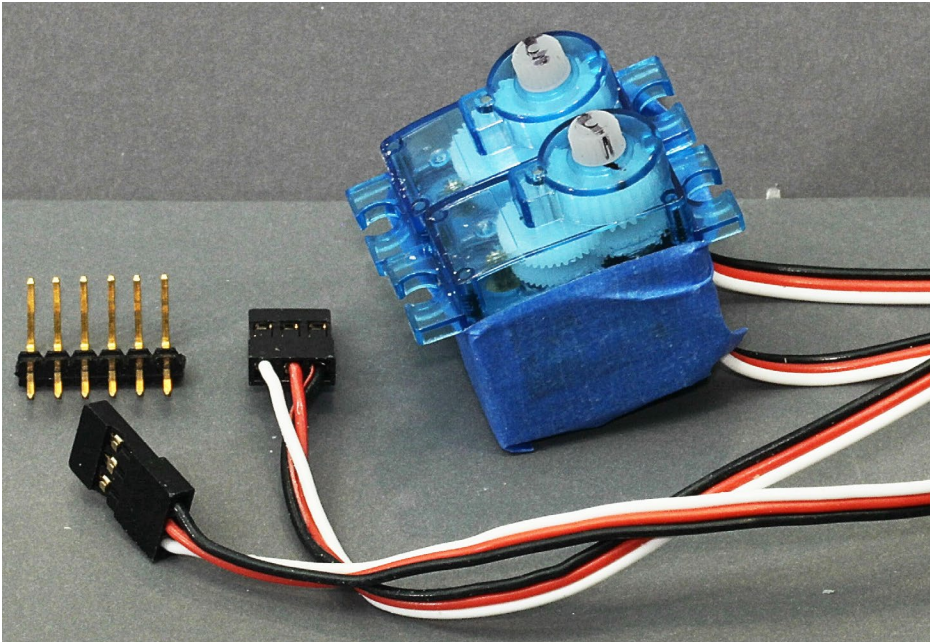

## 22. Two 9G sub-micro sized servos.

This is just a bit faster than most of us can toggle a panel switch! The Arduino also has to control the “on time” of the switch to consistently set the servo position.

For these projects, we install a Sensor Shield into the Arduino Uno board pins to make a “stack”. The Sensor shield has conveniently replicated the Arduino pins sockets side by side with 5V and Ground pin sockets – perfect for operating servos.

Be aware these servo projects get a bit more involved than the LED examples, especially as we work our way through the project examples. We delve more into editing the sketch files, so you will want to check out the last section of this article on using the Arduino IDE to edit a sketch file.

Let’s see what we can do with some low cost servos and an Arduino stack with a Sensor Shield!

## SERVO MOVING END TO END CONTINUOUSLY

**Sketch folder:** Servo\_Back\_and\_Forth

**Setup:** Single servo with switch [photo 22]

**Control:** pin 14 (A0)

**Connected pins:** servo\_pin - 3

This project moves the servo arm back and forth repeatedly. The starting point is determined by `servo_start` (default 20) while `servo_stop` (default 168) sets the stopping point.

This motion can move a pump, figures, and other items with a repetitive motion. A servo needs +5 Volts (red wire), ground (black wire), and control (usually a white or yellow wire) which connects through the Sensor Shield to an Uno pin.

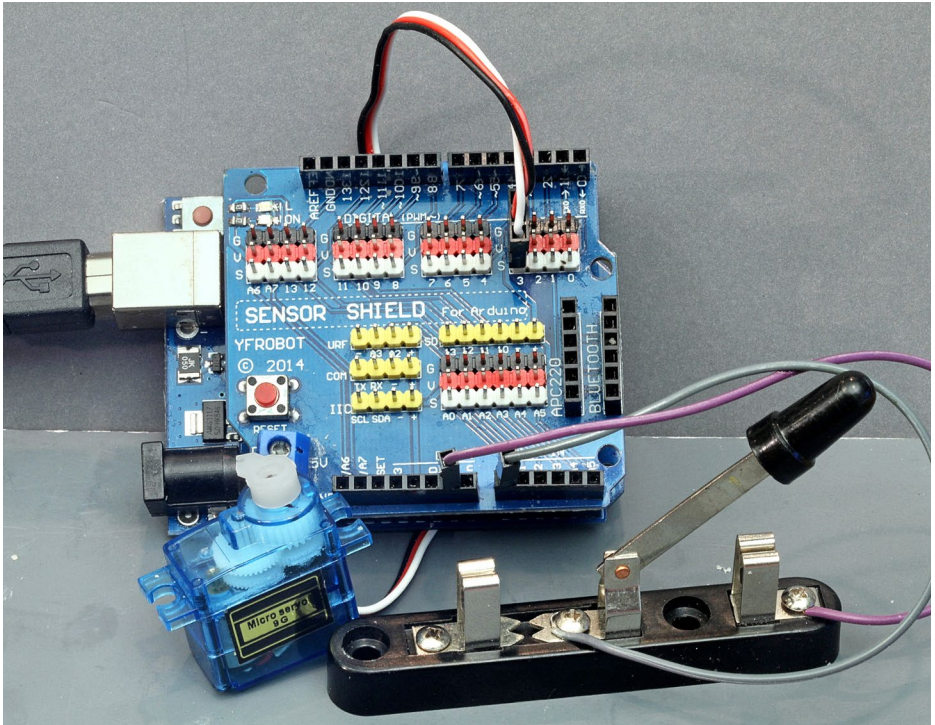

23. Single servo with switch.

## SERVO MOVING SLOWLY END TO END CONTINUOUSLY

**Sketch folder:** Servo\_Slow\_Back\_and\_Forth

**Setup:** Single servo with switch [photo 22]

**Control:** pin 14 (A0)

**Connected pins:** servo\_pin - 3

This project moves the servo arm slowly back and forth repeatedly. The movement speed is set by `servo_delay` (default 5) while the end points are set by `servo_start` (default 20) and `servo_stop` (default 168).

## ONE SERVO CONTROLLED BY SIMPLE SWITCH

**Sketch folder:** Servo\_One\_Switched

**Setup:** Single servo with switch [photo 22]

**Control:** pin 14 (A0)

**Connected pins:** servo\_pin - 3

This project moves the servo arm from end to end, triggered by a simple on/off switch connected to pin 14 (A0). The starting point is determined by `servo_start` (default 20) while `servo_stop` (default 168) sets the stopping point.

You need one Uno pin for the servo control and one Uno pin to attach the switch. This is a simple on/off switch with two connections, one to Uno pin 14 (A0) and the other connected to Ground. Any kind of simple switch will work.

If you look at this sketch in the IDE editor, lines 8 and 9 say:

```
#define servo_start 20           // Servo start position
#define servo_stop 168          // Servo stop position
```

If you change either of these numbers, you will change the traverse of the servo arm. These represent positions from 0 to 180 degrees in an arc. For cheap generic 9G servos, you will likely not be able to go completely from 0 to 180 degrees.

# MODELER'S INTRO TO THE ARDUINO | 36

## 6 PUSHBUTTON CONTROLLED SERVOS WITH LED INDICATOR

**Sketch folder:** Switched\_6\_Servos

**Setup:** Servo setup 2 [photo 24, next page]

**Control:** pin 14 (A0)

**Connected pins:** servos - spins - 2, 3, 4, 5, 6, 7;

pushbuttons - pins - 14 (A0), 15 (A1), 16 (A2), 17 (A3), 18 (A4), 19 (A5)

This project controls 6 servos with corresponding start and stop positions using push buttons. The starting positions are determined by `sstart-25,25,25,25,25,25` and the stop positions by `sstop-160,160,160,160,160,160`.

Each push of the corresponding button causes the servo to seek the opposite position and changes the state of the corresponding LED, using the pushbutton/LED connections shown below [23].

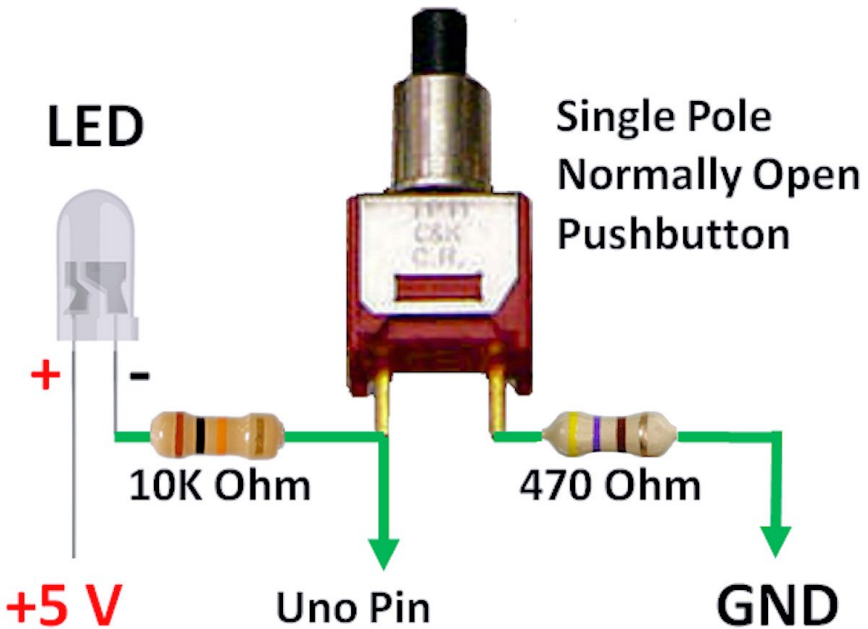

24. Push button and LED wiring diagram.

# MODELER'S INTRO TO THE ARDUINO | 37

## 8 PUSHBUTTON CONTROLLED SERVOS WITH LED INDICATOR

**Sketch folder:** Switched\_8\_Servos

**Setup:** Servo setup 2 with eight servos and buttons [photo 24]

**Control:** pin 14 (A0)

**Connected pins:** servos - pins - 2, 3, 4, 5, 6, 7, 8, 9;

pushbuttons - pins - 11, 12, 14 (A0), 15 (A1), 16 (A2), 17 (A3), 18 (A4), 19 (A5)

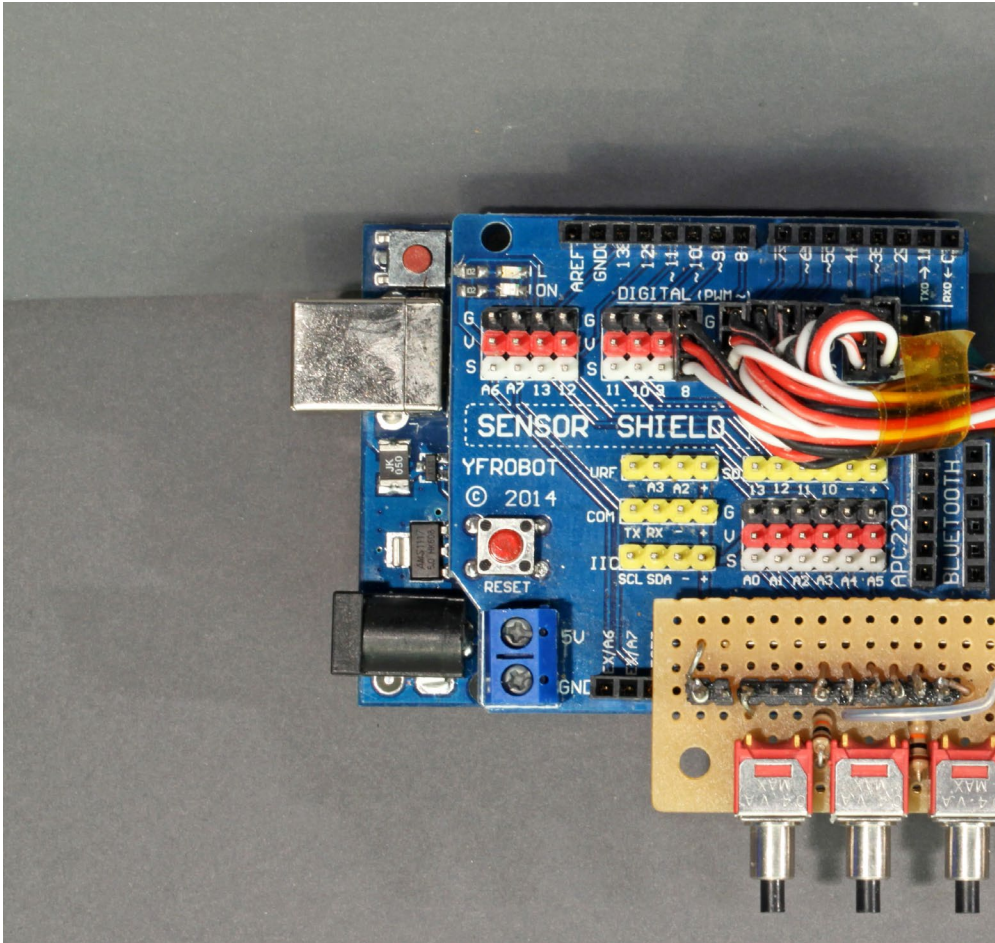

25. Servo setup 2, using an Uno and a Sensor Shield.



## MODELER'S INTRO TO THE ARDUINO | 38

This project controls 8 servos with corresponding start and stop positions using push buttons. The starting positions are determined by `sstart-25,25,25,25,25,25,25,25` and the stop positions by `sstop-160,160,160,160,160,160,160,160`. Each push of the corresponding button causes the servo to seek the opposite position and changes the state of the corresponding LED, using the pushbutton/LED connections pictured [23].

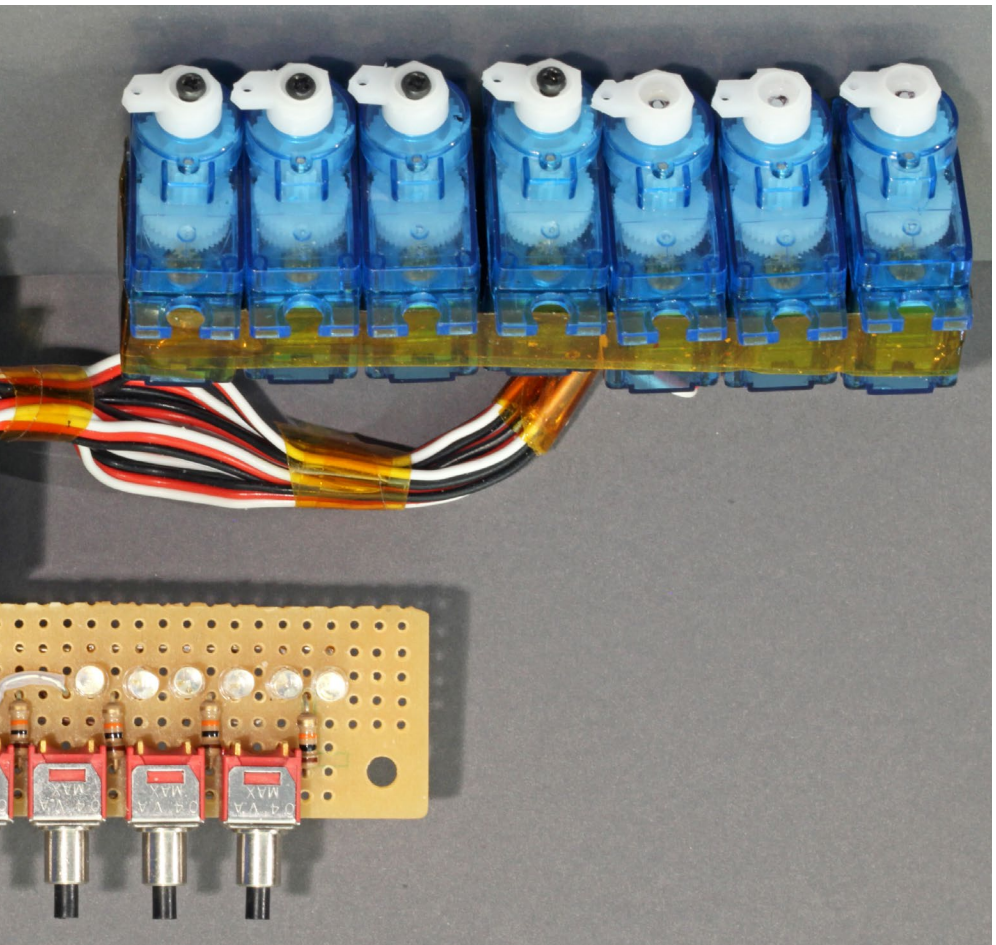

## 8 PUSHBUTTON CONTROLLED ROUTES USING SERVOS WITH LED INDICATOR

**Sketch folder:** Switched\_8\_Routes

**Setup:** Servo setup 2 with eight servos and buttons [photo 24]

**Control:** pin 14 (A0)

**Connected pins:** servos - spins - 2, 3, 4, 5, 6, 7, 8, 9;

pushbuttons - pins - 11, 12, 14 (A0), 15 (A1), 16 (A2), 17 (A3), 18 (A4), 19 (A5)

This project controls 8 routes. A route is simply a defined set of track switch positions, often in a yard, that collectively defines a single path through the yard. To form this route, the 8 servos each need to be set to a given start or stop position (think turnouts with two directions).

Each push of a corresponding button sets a route. A route is a collection of servo settings in this table found in this project's sketch:

```
routes [8][8] = { // ROUTE TABLE Definition for each route & servo
  {0,0,1,1,0,0,0,0}, // route 0 pushbutton 0
  {0,0,0,0,1,1,0,0}, // route 1 pushbutton 1
  {0,0,0,0,0,0,0,0}, // route 2 pushbutton 2
  {1,1,1,1,1,1,1,1}, // route 3 pushbutton 3
  {1,1,1,0,0,0,0,0}, // route 4 pushbutton 4
  {0,0,0,1,1,1,0,0}, // route 5 pushbutton 5
  {0,0,0,0,0,1,1,1}, // route 6 pushbutton 6
  {1,0,1,0,1,0,1,0} // route 7 pushbutton 7
```

This is a useful way to throw track switches controlled by servos. For each route 0-7, a “0” in the routes table row sets the corresponding servo to its saved **sstart** position and a “1” sets the corresponding servo to its saved **sstop** position. It also changes the state of the corresponding route LED.

You can set the routes (each table row) up any way you want!

# MODELER'S INTRO TO THE ARDUINO | 40

**Final note:** For all the 6 and 8 servo pushbutton-controlled projects, the 5 volt power to the servos should be a *separate power source*. Neither the Uno nor the Pro Mini can provide enough power via the on board regulator. Low cost 9G servos can have a peak current draw of over 1 amp!

## Sound projects

Watch the video below to see what the sound projects do.

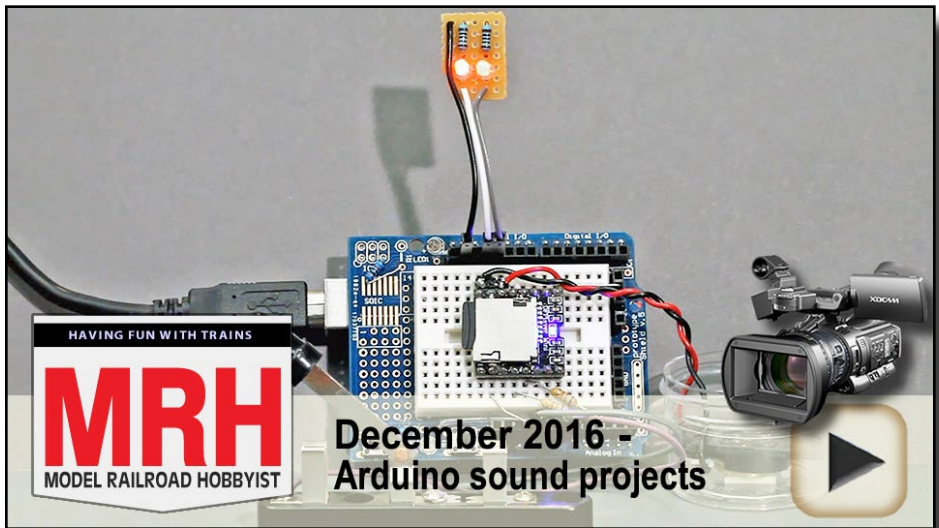

Playback problems? [Click here ...](#)

**Note:** All the sound projects use a small, low-cost module called a DFPlayer. This is available from [dfrobot.com](http://dfrobot.com) ([dfrobot.com/wiki/index.php/DFPlayer\\_Mini\\_SKU:DFR0299](http://dfrobot.com/wiki/index.php/DFPlayer_Mini_SKU:DFR0299)) or from eBay.com ([ebay.com/itm/19194725444](http://ebay.com/itm/19194725444)). You can also Google for DF-Player and find still more sources.

More detailed documentation on the DFPlayer is included in this month's [subscriber bonus downloads](#).

## CROSSING LIGHTS & BELL SYNCHRONIZED TOGETHER

**Sketch folder:** RR\_Crossing\_Bell\_Synched

**Setup:** Sound setup 1 [photo 25]

**Control:** pin 14 (A0)

**Connected pins:** led\_pin1-11, led\_pin2-12, bell\_pin-15

This project alternates the flashing of two LEDs synchronized with the “gong” sound of the crossing bell. This is an older style of prototype crossing signal. Flash rate depends on setting `delta`, which defaults to 540.

This project is a good example illustrating simple synchronization of each crossing lamp with the single strike of the bell. Using an Arduino, the lights and sound can all be synchronized to a very good degree of accuracy to convincingly simulate such older crossing signals.

## CROSSING LIGHTS & BELL FREE RUNNING

**Sketch folder:** RR\_Crossing\_Bell\_FreeRun\_PB

**Setup:** Sound setup 1 [photo 25]

**Control:** pin 14 (A0)

**Connected pins:** led\_pin1-11, led\_pin2-12, bell\_pin-15 (A1), silence\_pin-16 (A2), control\_pin-14 (A0)

This project alternates the flashing of two LEDs. Flash rate depends on setting `delta`, which defaults to 745.

A pushbutton is connected to control\_pin- 14 (A0). Each press switches the project on – off – on – etc.

The crossing bell runs at an independent rate, determined in the prototype by the bell mechanism itself. This is a more modern style of prototype crossing signal.

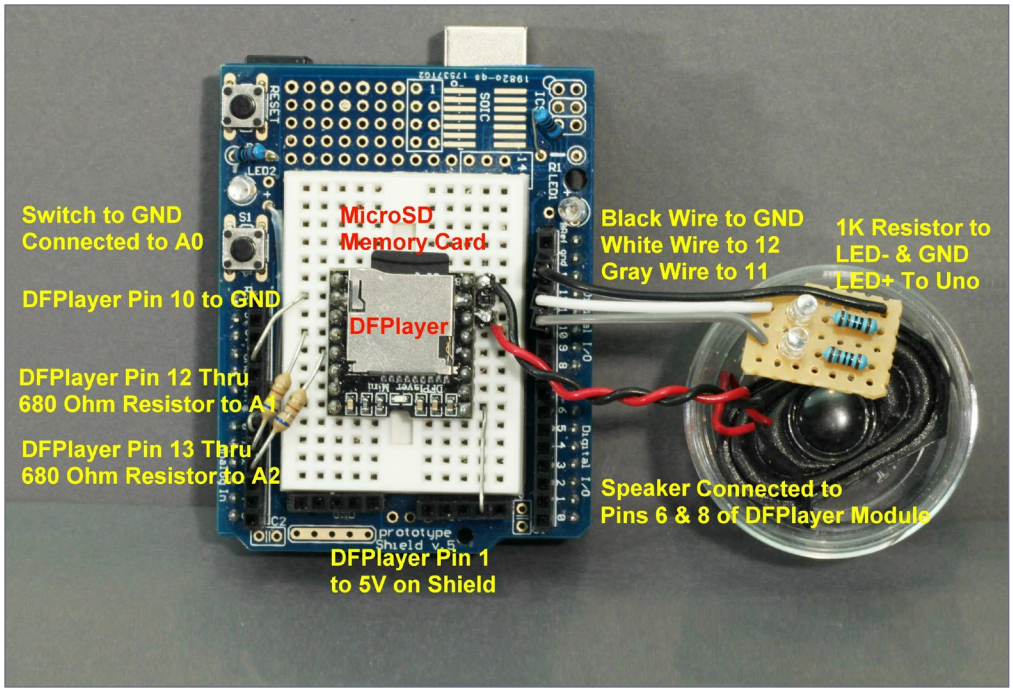

## 26. Sound setup 1: Uno and DFPlayer module connections on a Prototype Shield using a small speaker.

The speaker [25] is a small oval speaker that I obtained from a discarded computer laptop although you can find a very similar speaker on Amazon at this link: [a.co/3TkbYbp](https://a.co/3TkbYbp). I placed the speaker in an open plastic box about 2 inches deep to improve its sound.

The resistors in series with the LEDs are 1000 Ohm.

The sound files are included in the [subscriber bonus downloads](#), and they must be loaded onto a micro SD memory card for use with the DFPlayer [25].

You can get a USB to SD card reader and a micro SD Card to standard SD Card adapter, then load the files onto the micro SD card from your computer [26].

## CROSSING LIGHTS & BELL FREE RUNNING ACTIVE HIGH

**Sketch folder:** RR\_Crossing\_Bell\_SW\_HIGH

**Setup:** Sound setup 1 [photo 25]

**Control:** pin 14 (A0)

**Connected pins:** led\_pin1-11, led\_pin2-12, bell\_pin-15 (A1), silence\_pin-16 (A2), control\_pin-14 (A0)

This project alternates the flashing of two LEDs. Flash rate depends on setting `delta`, which defaults to 745.

A simple on/off switch is connected to control\_pin- 14 (A0). The project switches ON when the control\_pin is HIGH.

The crossing bell runs at an independent rate, simulating a more modern style of prototype crossing signal.

**Note:** The only difference between RR\_Crossing\_Bell\_SW\_HIGH and RR\_Crossing\_Bell\_SW\_LOW is whether the enabling switch is HIGH or LOW. The choice is often dictated by the sensor, mechanism, or switch you use. These are provided to demonstrate the ease of customizing activation as needed.

## CROSSING LIGHTS & BELL FREE RUNNING ACTIVE LOW

**Sketch folder:** RR\_Crossing\_Bell\_SW\_LOW

**Setup:** Sound setup 1 [photo 25]

**Control:** pin 14 (A0)

**Connected pins:** led\_pin1-11, led\_pin2-12, bell\_pin-15 (A1), silence\_pin-16 (A2), control\_pin-14 (A0)

This project alternates the flashing of two LEDs. Flash rate depends on setting `delta`, which defaults to 745.

A simple on/off switch is connected to control\_pin- 14 (A0). The project switches ON when the control\_pin is LOW.

The crossing bell runs at an independent rate, simulating a more modern style of prototype crossing signal.

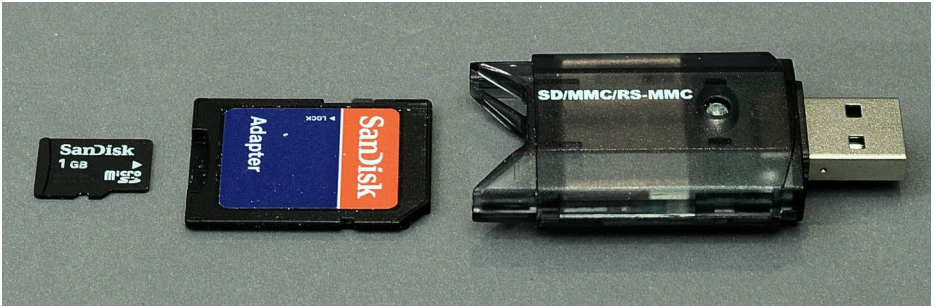

## 27. Micro SD memory card adapters to USB.

Place the sounds clips on the micro SD memory card “in the root,” which means do not put the sound files into any folders.

First, re-format your micro SD memory card, then load the files in order, one at a time, from the SoundSetup1 folder in the bonus downloads for this article.

## What do HIGH and LOW really mean?

In the world of digital electronics, HIGH means 5.00 volts exactly and is interpreted as one (1). LOW means 0.00 volts exactly and is interpreted as zero (0).

In practical terms, however, an Arduino interprets any voltage level above 3.5 Volts (3.5-5.0) as HIGH and any voltage below 1.5 volts (0.0-1.5) as LOW. Ground is always considered LOW.

In all the sketches presented in this article, care was taken to enable an internal Arduino circuit to set all unconnected, open inputs to the board so they default to HIGH. If this action were not taken, a disconnected open input could not reliably be read as either HIGH or LOW. ■

## PLAY RANDOM SOUND TRACKS

**Sketch folder:** Random\_Sound\_Clips

**Setup:** Sound setup 2 [photo 27]

**Control:** pin 14 (A0)

**Connected pins:** (no other pins needed)

This project plays a set of mp3 sound tracks stored on a micro SD Memory Card in random order. A simple on/off switch connected to pin 14 (A0) will enable playing.

Place the sound clips on a micro SD card in a folder labeled mp3. Name them 0001.mp3, 0002.mp3, 0003.mp4, 0004.mp3, etc.

The sketch has two values you can set: `num_clips` (default 9) sets the total number of sound clips to select from on the SD memory card, and `sound_start_delay` (default 0) sets how many minutes to delay before starting to play after turn on.

## PLAY SELECTED SOUND TRACKS

**Sketch folder:** Selected\_Sound\_Clips

**Setup:** Sound setup 2 [photo 27]

**Control:** pin 14 (A0)

**Connected pins:** select\_pins-2, 3, 4, 5, 6, 7, 8, 9, 10, 11, 12

This project plays one of a set of pre-recorder mp3 sound clips stored on a micro SD Memory Card by pulling a chosen pin LOW to ground. A simple on/off switch connected to pin 14 (A0) enables playing.

Place the sound clips on the micro SD card in a folder labeled mp3 and named 0001.mp3, 0002.mp3, 0003.mp4, 0004.mp3, etc. corresponding to the order of the pins defined by select\_pins.

Pulling pin 3 LOW plays clip 0002.mp3. Sketch value `num_clips` (default 9) sets the total number of sound clips/tracks on the SD card, and `sound_start_delay` (default 0) sets the number of minutes to delay before starting to play after turn on.



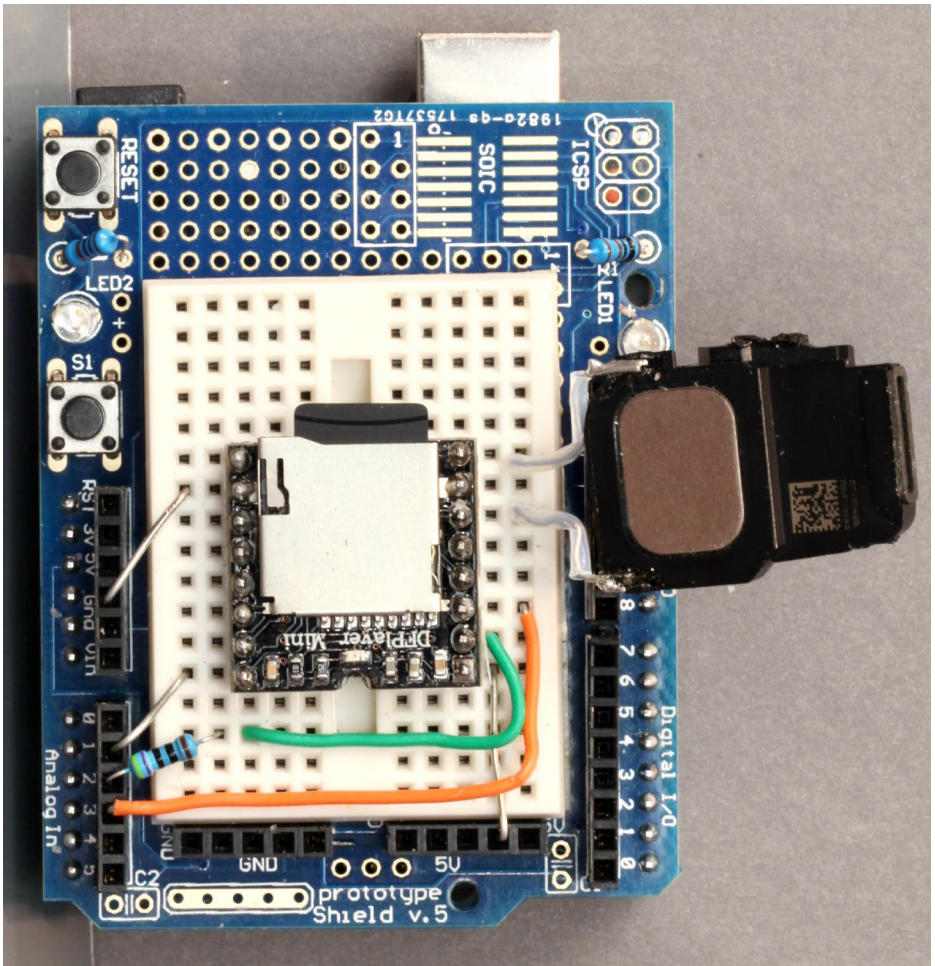

28. Sound setup 2, using an iPhone cell phone speaker. You can get an iPhone speaker for a few dollars on Amazon at this link: [a.co/564x5AP](https://www.amazon.com/dp/B000000000). Cut off the plastic housing extension and seal the small hole left with some epoxy or putty, leaving the rest of the speaker as shown here. These tiny speakers produce excellent sound.



**Click here for  
reader comments**

## PLANNED SOUND: CREATE A THUNDERSTORM

**Sketch folder:** Thunderstorm

**Setup:** Sound setup 2 [photo 27]

**Control:** pin 14 (A0)

**Connected pins:** lightning\_pin - 3, lightning\_pin2 - 4

This project plays a set of mp3 sound tracks stored on a micro SD Memory Card to simulate a thunderstorm approaching and then passing.

A simple on/off switch connected to pin 14 (A0) enables playing.

You can set up a start delay by changing `lightning_delay` in the sketch to the number of minutes you want to pass after the initial turn on.

You can also set `next_storm_delay` to the number of minutes before the next storm arrives!

**Note:** While you can use this as a sound-only sketch, it does include synchronized switching for firing two independent slave strobe lights. These are activated with a relay connected to pin 3 and pin 4.

The entire sketch with sound and lights simulates a thunderstorm approaching and passing by. Two strobes are needed to account for the long re-charging time of the strobes. You will notice closely timed lightning bolts in your area!

Load all the sound files onto your micro SD Memory card and try to stay out of the rain! When I have given clinics on modeling with sound, I often will stage things so the thunderstorm will arrive and pass somewhat unannounced in the middle of the clinic!

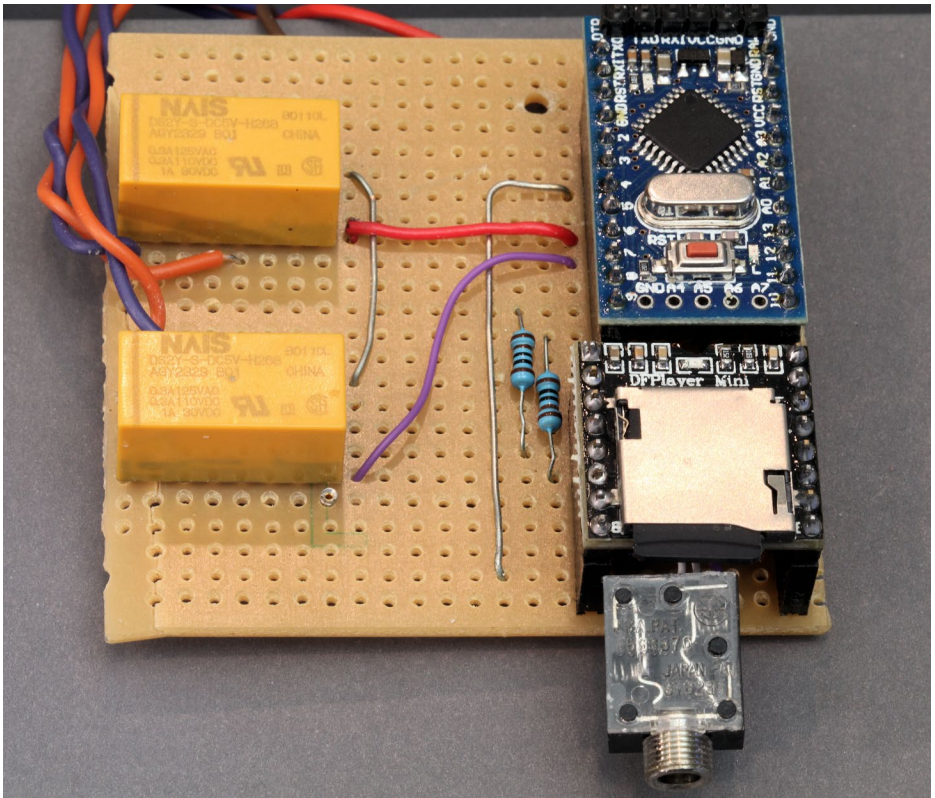

29↑ and 30↓. Thunderstorm components all wired and ready to create a storm above. Relay wiring diagram shown below.

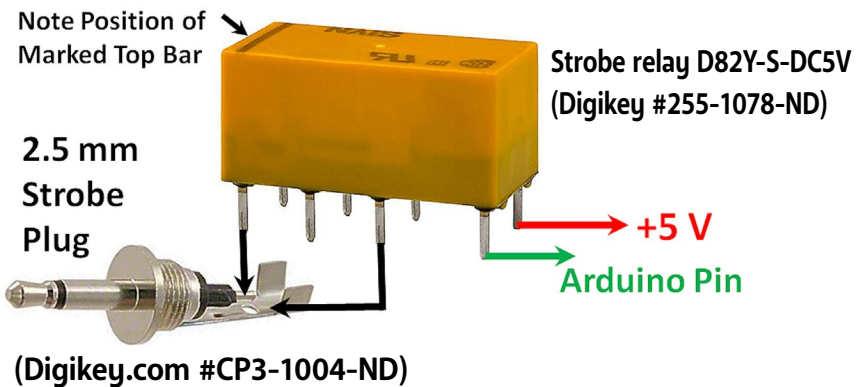

31. Self-contained strobe for lightning/thunderstorm.

Amazon link:  
[a.co/ba5G273](https://a.co/ba5G273)

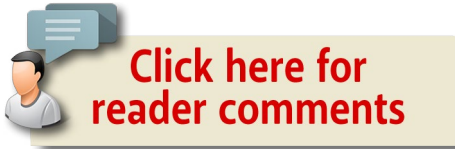

Be sure to check the [subscriber bonus downloads](#) for this month's issue. There's a lot of supplemental material in there to go along with this article. Have fun! ☑

A button with a speech bubble icon and a person icon, containing the text "Click here for reader comments" in red.

[Click here for reader comments](#)

---

## GEOFF BUNZA



Geoff Bunza started as a model railroader when he received a Mantua train set for Christmas, at age 6. He fed his interests through college, becoming a member of the Tech Model Railroad Club (TMRC) at MIT while getting his doctorate and three other degrees in electrical engineering. He has collected Lionel HO trains for many years, which spawned his interest in realistic model animation and lighting. Primarily, he models the New York Central Railroad.

Geoff is a member of the New York Central System Historical Society, a life member of the NMRA, and holds an Extra Class amateur radio license. ■

Brought to you by  
**MRH**  
MODEL RAILROAD HOBBYIST

# TRAINMASTERS.TV

## WHAT'S NEW!



**TRAINMASTERS**

*click for more*

Mike Eyten's  
**KAW VALLEY RAILROAD**

**NOTCH 8**

3D printing at home

**THE BACKSHOP CLINIC**

The narrow gauge niche

**DCC DECODED**

Using JMRI to improve DCC

**THE BACKSHOP CLINIC**

Handlaying curved turnouts

Non-members: Watch most episodes for \$1.49; become a member for unlimited access

*Our videos are in-depth like MRH articles, except without ads*

*Joe B*

*Larry*

*Jeff*

*Bruce*

*Mike*

*Richard*

*Merry  
Christmas  
from MRH!*

*Ken*

*Chris*

*Les*

*Patty*

*Joe F*

*Jean-François*

*Paul*

*Jim L*

*Daniel*

*Don*

YES, IT'S A MODEL

Photo by Jürg Rüedi



[Click here for  
reader comments](#)

# Building the BTS COAL TIPPLE

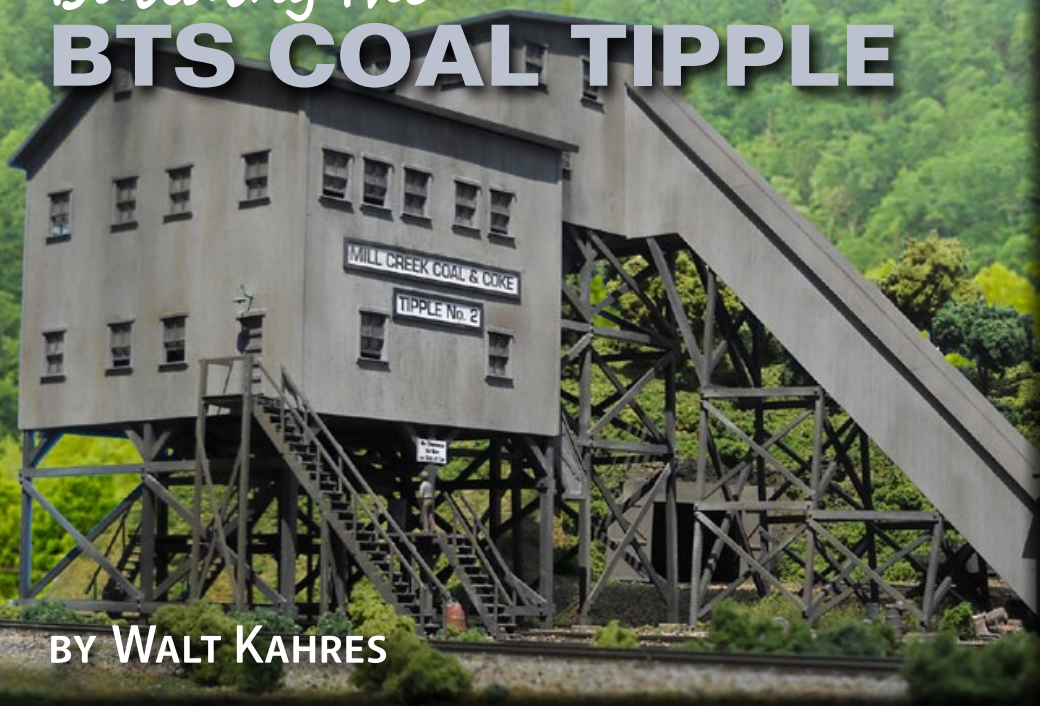

BY WALT KAHRES

## *Tips and techniques for squaring, gluing and painting ...*

**I RECENTLY FINISHED WITH LOCO REPAIRS AND** article upgrades on my fleet, so began concentrating on building the tippie for my coal mine.

I really like laser kits and have purchased several from BTS at [btsrr.com](https://www.btsrr.com). I have several builds under my belt, but this is the most complex kit that I've tackled. This is BTS kit Mill Creek No. 2. Their literature says that it's based on various coal operations and not on a specific prototype.

1. (top) This is the photo BTS supplies. When I am finished the kit should turn out something like this. *BTS photo*





[Click here for reader comments](#)

BTS is my personal favorite laser kit maker so far. Their craftsman kits are NOT for beginners and take some time to build. I expected this one to keep me busy for a while but they are well-designed with a lot of detail. Their smaller kits are available through distributors but most of the larger kits can only be purchased direct from BTS. What does BTS mean? “Better Than Scratch.”

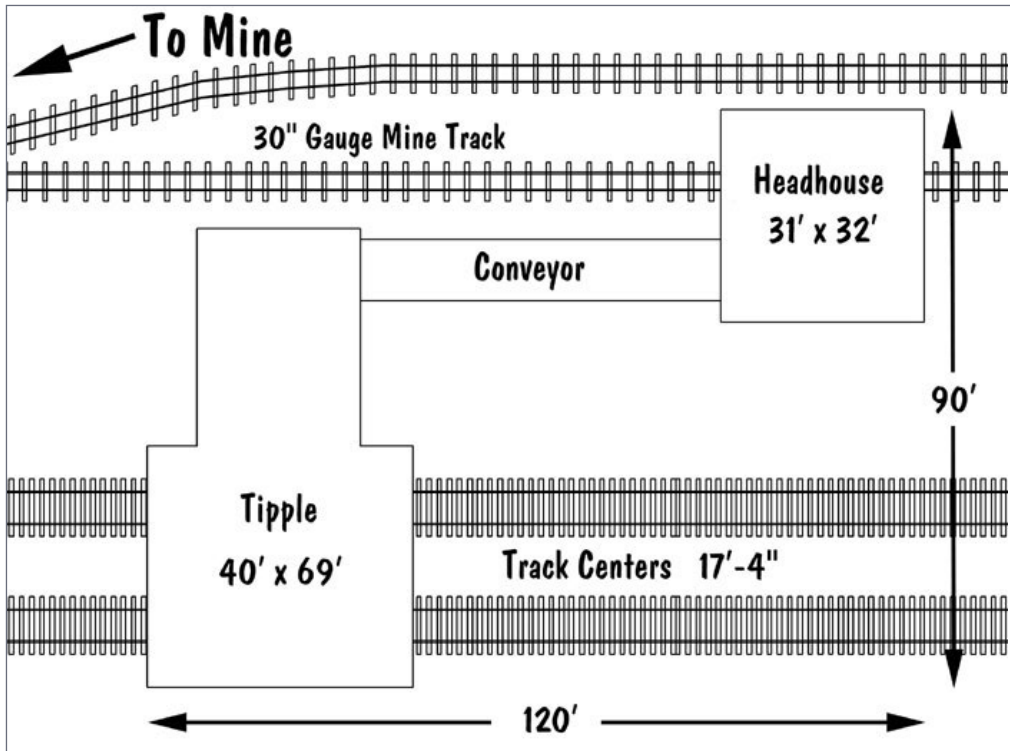

2. BTS supplies a suggested track plan with the kit.

## BUILD A BTS COAL TIPPLE | 3

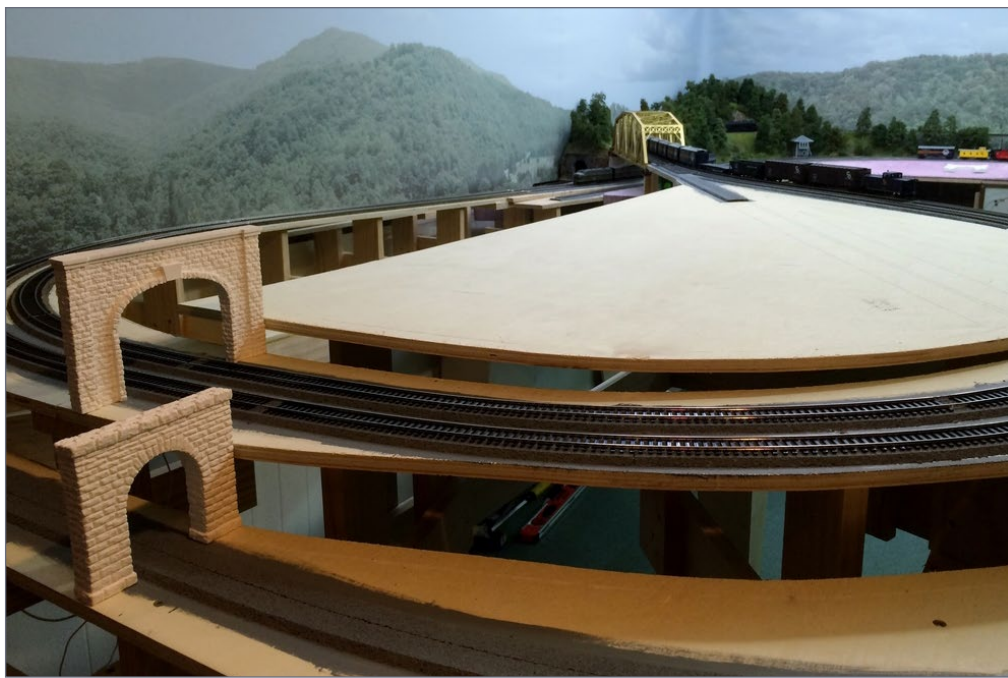

### 3. My tipple site is a blank canvas at this point.

Some *MRH* modelers are real artists when it comes to weathering and finishing. While I am confident in my ability to build a nice structure, I'm not so solid on the artsy part. My goal is to make the tipple look well-used but also reasonably maintained. So, a few broken or missing boards are OK, and everything will have paint on it. We will see how it turns out when I get to the weathering at the end.

### Paint and colors

I am using Tamiya acrylics for this kit since it requires a lot of paint. These paints are reasonably inexpensive and go on nicely with an airbrush. Color selection is always a challenge. I chose a bluish-gray for the main structure.

## BUILD A BTS COAL TIPPLE | 4

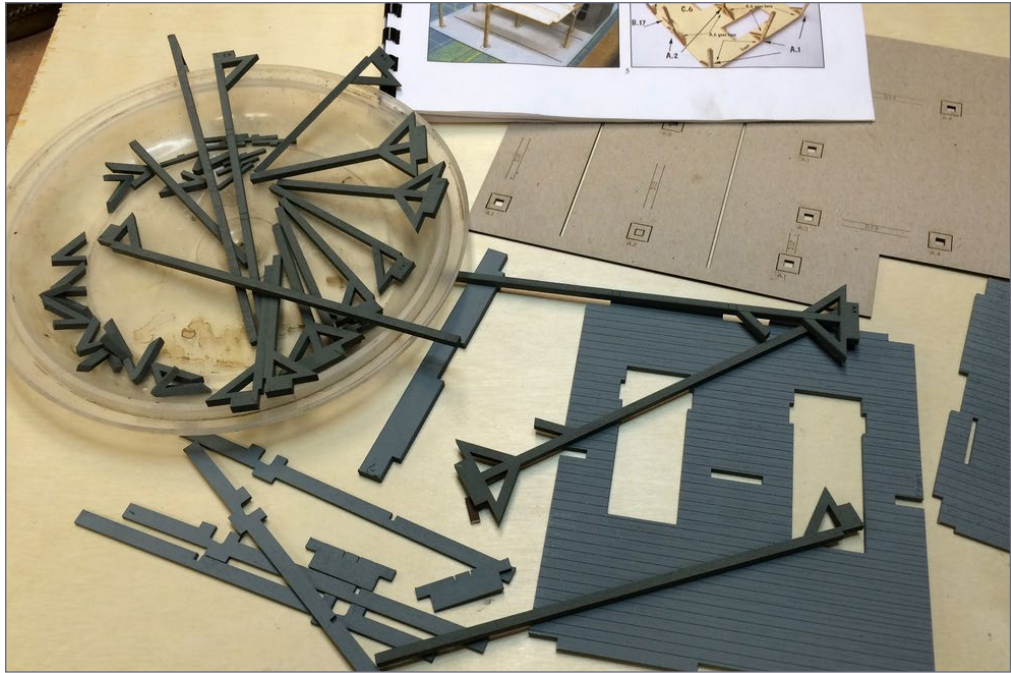

4. Paint all parts and panels with an airbrush before assembling

**Want to help keep  
MRH free?**

**Then *click* on ads!**

## BUILD A BTS COAL TIPPLE | 5

Always check the colors under the layout room lighting. The bright fluorescent magnifier light on my work bench really highlights blue and green shades. In my layout room I use LEDs, so a color can look different there. I've tried many painting methods, and airbrushing with acrylics before assembly wins hands-down for me. Sprayed acrylics go on thinly and evenly, and really show the detail.

Warping can be a problem with this type of kit. I prime big interior structural parts like floors with Dupli-Color Primer-Sealer before airbrushing and that helps stabilize them. I prefer not to prime exterior walls and small parts, but even when painting both sides you have to watch out for warping and be ready to deal with it.



5. I use a pill organizer to keep track of all the window detail parts, and to separate and store them.

## BUILD A BTS COAL TIPPLE | 6

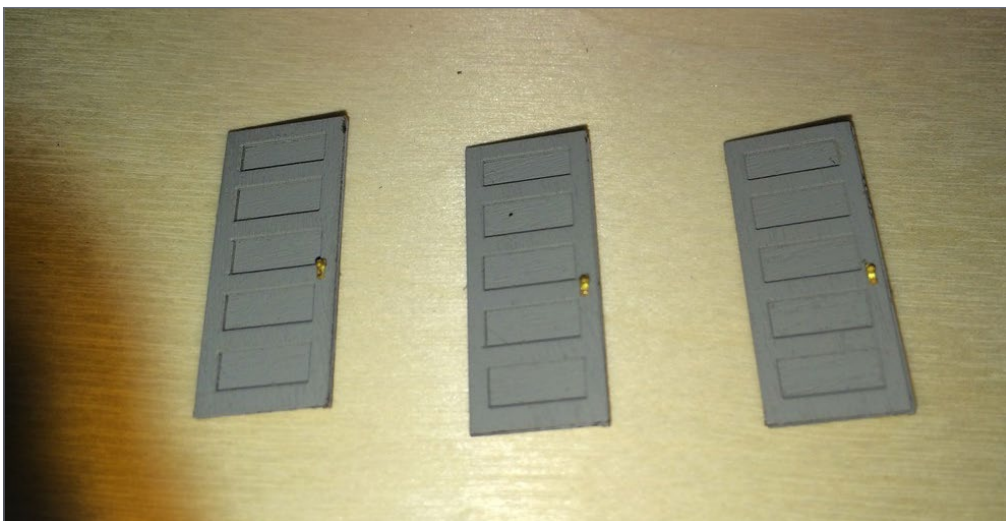

### 6. The brass doorknobs and plates.

One final note: BTS kits come with a lot of tiny details so be careful. Check out the brass doorknobs and plates [6]. A lighted magnifier is mandatory for this sort of work.



### Time to get started

I score the exterior wood

7. A panel with the windows, door, and trim glued in place.

## BUILD A BTS COAL TIPPLE | 7

with a knife between coats of paint to give it a bit of a rough woodgrain look. Paint both sides of panels with an airbrush, then sandwich them between sheets of wax paper and weigh them down with old textbooks. The paint does not stick to the wax paper and the panels dry nice and flat.

Glue the windows in the wall panels using canopy glue, and the doors and trim using white glue. These adhesives dry clear so a bit of excess will not be very visible. Next glue the walls together. Make sure the first two glue joints are square. I use Titebond wood glue for structural joints, and white glue for all non-structural joints like the window trim. When they are dry, add the fourth panel, keeping the new glue joints square using similar methods to those shown [8]. Using this method, the warps will pull right out. To prevent future warping, I'll add some extra bracing once the walls are glued to the floor.

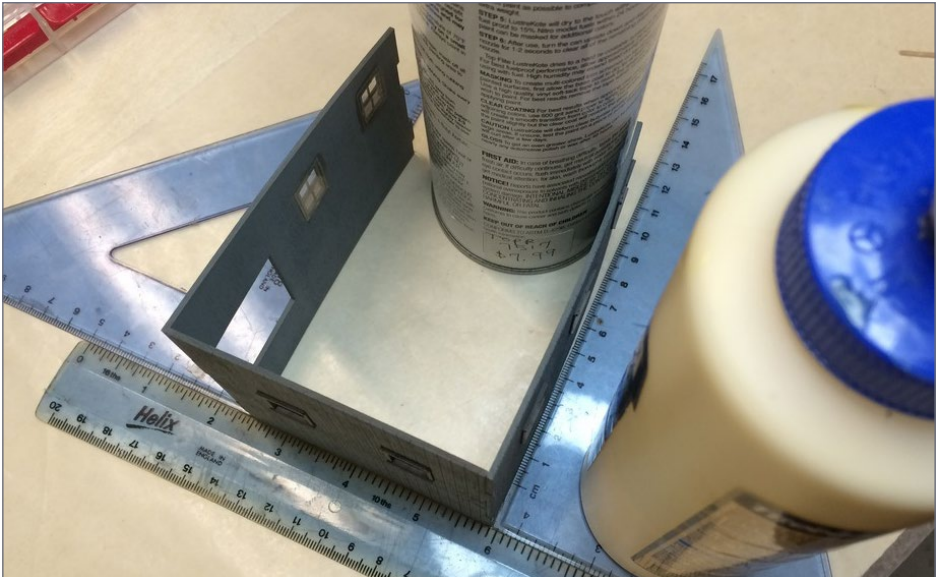

8. I use an assortment of rulers and triangles to keep my build square.

## BUILD A BTS COAL TIPPLE | 8

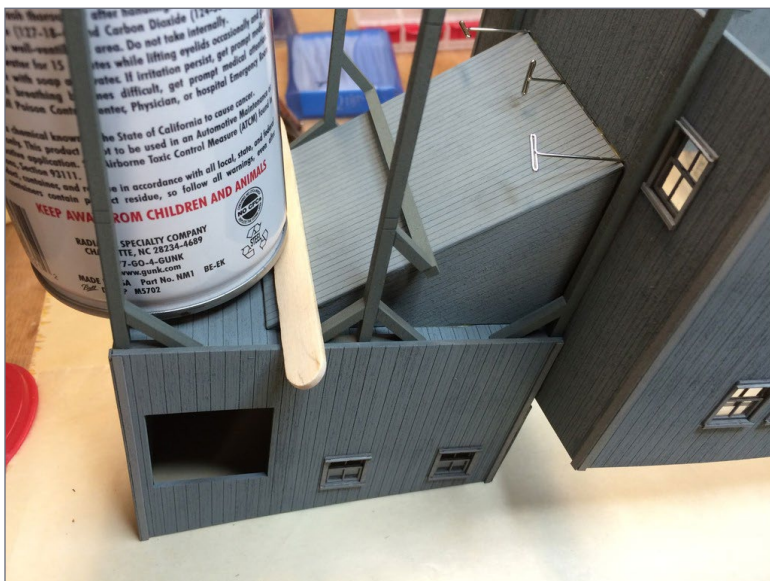

9-10. Some of my other tools used to clamp pieces together while the glue dries.

## BUILD A BTS COAL TIPPLE | 9

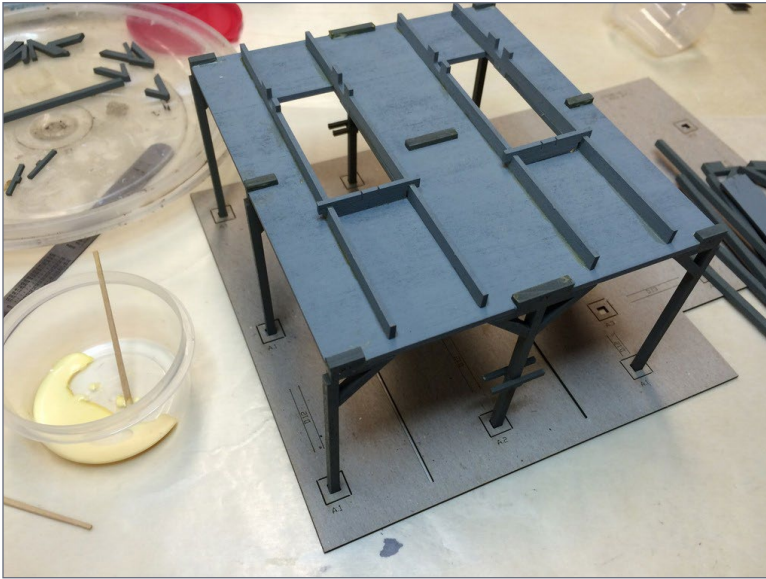

11. Here is the main building floor assembly.



12. After gluing the main building walls together with Titebond, I sat it on the base to check the fit.



## BUILD A BTS COAL TIPPLE | 10

The two buildings and floor assemblies are just dry-fitted at this point. Sometimes the tabs and such need a bit of sanding or cutting to get the fit just right. Check the join lines and squareness before opening up the glue bottle.

I have to admit, at this point I am pretty pumped since every-

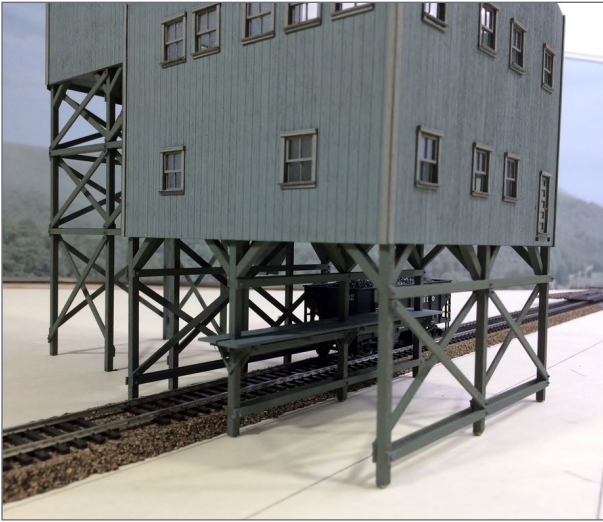

thing is going together nicely and the finish has the “look” that I was aiming for[13-14]. Once the assemblies are glued together, start adding all the detail. The floor is well braced but the walls will probably need bracing to keep them square and prevent warping. After gluing the main building walls together with Titebond, sit it on the base to check the fit. So far so good.

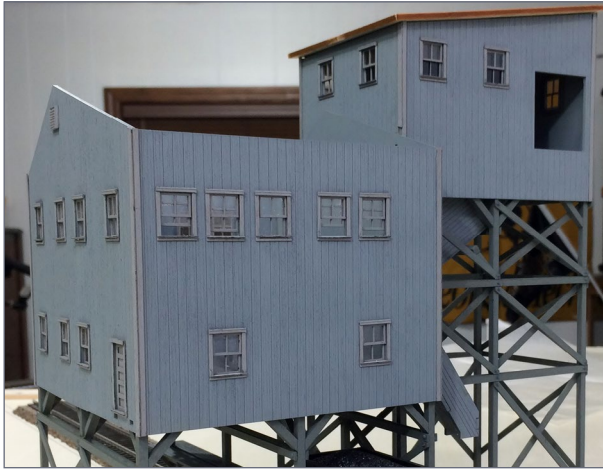

Many modelers use Legos to make sure that the corners are straight on their

13-14. I had to take the tippie and try it out in its future home.



15. This is my BTS C&O tower kit. Notice the window shades made with tissue paper.

structures. I don't have any Legos but I do have rulers and triangles [8] that I've used since my RC airplane building days. The important thing is to have methods worked out to keep things square and tight when gluing. This is the kind of skill you can learn on small kits before trying to build big, expensive ones. Sometimes it takes creativity: I also use rubber bands, pushpins, clothespins, plastic clamps, and a variety of random objects as weights. Whatever works.

## Windows

The windows, while you are adding them to the basic "box," can be raised by cutting some of the top off the rear window panel

## BUILD A BTS COAL TIPPLE | 12

before gluing them in place. BTS includes a note on how to do this. Tissue paper is included to make window shades and curtains. I made shades this way for the BTS switch tower that I completed a few months ago [15].

Touch up the edges of the trim with a fine-point brush after the building is complete.

### Base platform

Once the main building structure is glued together and the corner trim attached, install the platform underneath. I began working on the leg braces. There are over 75 leg braces in the kit. All of them have bolt holes bored through them and they need plastic bolts glued in place.

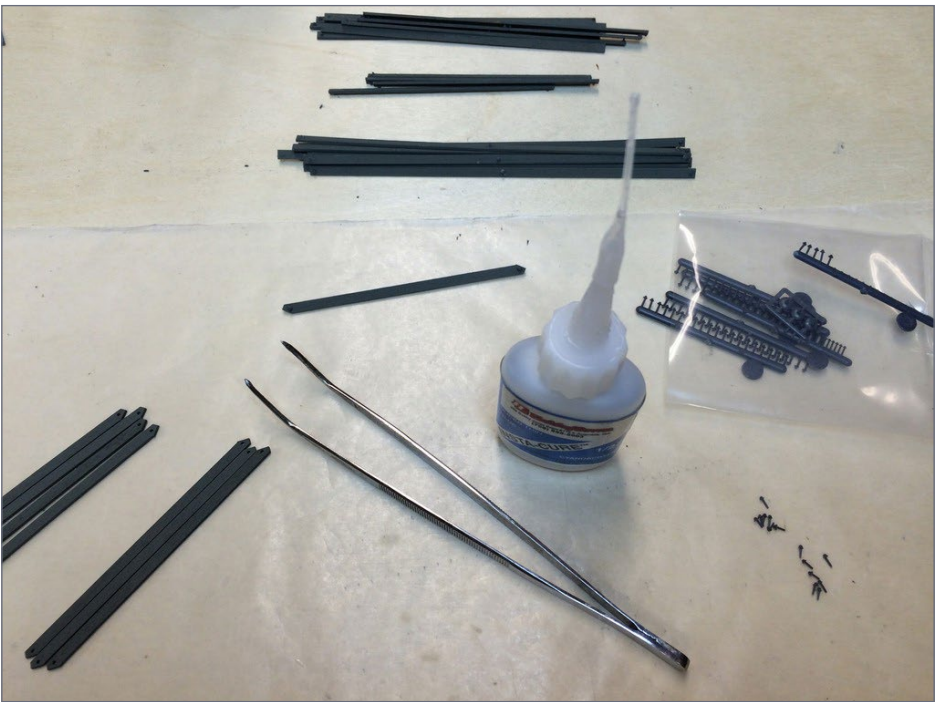

16. My tools for adding NBW details to the cross braces.

To glue plastic to wood, I use thin CA, applying the glue from the rear. The glue wicks right in and the bolt is placed in the hole. A fine tip attached to the bottle is essential for controlling the flow, not making a mess, and not leaving shiny blobs. It's tedious, but not too bad once I work out an "assembly line" to do it. The biggest challenge is keeping the braces all sorted and separated because there are so many of them.

Next, glue all the leg cross braces onto the main structure. Again, this is slow work. Glue on two or three, then wait until the glue cures enough to handle the building. Then, add a few more, and wait again. Now move on to the roofs for these two buildings, and the loading chutes.

Take a moment to position the structure. This is one of those projects where the whole structure really needs to be complete before the terrain and track, to fit everything together and create the scene.

### Up on the roof

The kit comes with roll roofing. I have never been very fond of roll roofing. I took some time to look at old photos again to see the roofing material used on the early tipples. Only a very few show roofing detail, and even fewer are in color. From the photos, it looks like tin roofing was common, even on the early structures. For now I am going to build the roof structures, and leave the roofing for later. But I think nice rust-washed tin roofs would set the buildings off nicely.

Once the roof parts are dry-fitted and adjusted, prime both sides of the wood with Dupli-Color primer sealer to stabilize them. Then, assemble. The roofs must be removable and need to stay perfectly flat.



17. I use this tool a bunch – a needle glued into the end of a length of wooden round stock. The photo was taken looking through another essential tool, my illuminated magnifier.

Coal tipples vary in design from place to place. The area I am interested in is the West Virginia Appalachians. Until recently, the roofing on most tipples was corrugated metal. The sides may or may not have been corrugated, but the roof almost always was. This model is not based on a specific prototype. It's a composite of several different tipples located in West Virginia, so I am free to use the roof material of my choice.

The roofs are built and ready for the corrugated tin to be added. I have enough corrugated metal on hand for two roofs but possibly not enough to complete everything. I may go with tar paper or something else for the inclined conveyor roof, just to have a different look.

### Add the 'chutes'

I spent a few days building the two hopper loading conveyors that hang under the main building. Old photos suggest this arrangement was pretty typical.

As for the conveyors, I found it interesting that the instructions call them "chutes" even though they are obviously cleated conveyors. The hanging conveyors are very detailed, and building them took a lot of time. The conveyor belt is paper stock with small pieces of styrene cut to length for cleats. The side plates are made from laminated paper stock. It's delicate work and the conveyors are actually shorter than a toothpick.

The instructions are very good but they don't go into detail on tools, methods and glues to use for each step. So part of the



18. The coal conveyor under construction. It is less than a toothpick long.

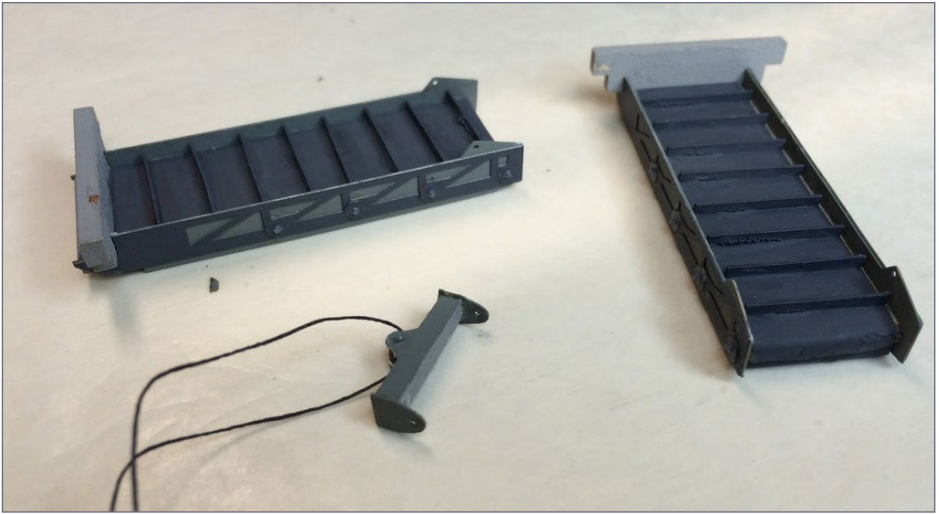

## 19. Conveyors finished and ready for installation.

journey is working construction methods out. The loaders were by far most challenging part to build and the home-made needle holder turned out to be key to success.

I used CA to glue the cleats on since it was plastic to paper. The rest of the assembly is glued with Titebond or white glue depending on whether the bond is structural or just for trim. I did not exactly follow the construction sequence in the instructions. I built the entire side plate assemblies, including the NBWs and then glued them on after the conveyor belt was completed and painted. If I had it to do over again, I would do it exactly the same way.

The sides of the conveyors and the ends of the pulley side plates have a bunch of tiny plastic bolt head details. The beam connects to the end of the conveyor using two NBWs. Melt the inside ends with a soldering iron to keep them in place. Very little of this detail is visible once the conveyors are installed – except

in close-up views, which is typical for BTS. Taken as a whole, all the detail should add realism to the finished model. With a little paint touch-up, the conveyors are ready to install.

### Engineering the headhouse base

The headhouse walls and roof are simple, but the floor is rather complex, with mine track and an unloader pit as part of the build.

The main buildings are intended to be installed at track level, without any roadbed under the track. The pit level of the headhouse is  $\frac{1}{2}$ " higher, and the mine track is also elevated as it passes through the headhouse. I decided to use  $\frac{1}{2}$ " sheet foam to create the head-house and mine track elevation differences. I also decided to use  $\frac{3}{16}$ " sheet cork as the base under the main tracks and tipple structure so that it meets up evenly with mainline track. This means that I will also need  $\frac{3}{16}$ " cork on top of the foam under the mine track to get the full  $\frac{1}{2}$ " elevation and a seamless transition from the mine track as it enters and exits the headhouse.

Once I am ready to begin positioning the structure on its base, my plan is to remove the plywood base. The base can be moved to a shop table to do all the land forming, track laying, and most of the scenery as a module. Then, I'll put it back in place and connect the tipple track to the main line.

### Mine railroad

The mine cars are designed to use HOn30 track (9mm gauge). HOn3 track is wider (10.5mm). I am just now figuring out all the different narrow gauge naming conventions and what they mean. Here is the Wikipedia summary:

*The terms HOn30 and HOn2½ are generally used when modeling American prototypes while HOe is used for European prototypes. All these terms refer to models of narrow gauge railroads*



# BUILD A BTS COAL TIPPLE | 18



20-21. Conveyors added to the tippie floor and the tippie set in place for another fitting. The conveyors are a neat detail and it's too bad they are pretty much hidden from view.

*built to the world's most popular model railway scale of HO (1:87) to run on a track gauge of 9 mm (0.354 in), the gauge used for N scale models of standard gauge railways. In Great Britain, the term OO9 is used. OO9 refers to OO scale, 1:76.2 models on 9mm gauge track. Although the track gauge is 9mm, sometimes N scale track per se is not used because the crossties are too narrow and too close together. HOn30/HOe track and switches are available.*

The BTS instructions say that the example model uses Peco HOn30 code 80 track. So the Peco SL-400 or the mainline SL-404 track that has clean looking ties should work.

Templates that are available for the mine track turnouts are very helpful for planning the mine track routing. I don't know if I will ever power the mine track and purchase a loco to run on it, but I want to do it right so that it is possible without a lot of re-working.

I ordered a sheet of 3/16" cork from Bangor Cork and it matches the thickness of the cork roadbed under the mainline track perfectly. I will lay the tracks and set the tippie on top of the cork. Since I did not place cork where the 1/2" foam board spacer will sit, I will put some 3/16" cork on top of the foam to get the full 1/2" elevation change for the mine track.

### Build the head house

While waiting for my track and cork to arrive, I began assembly of the head house. This structure is tricky because there are two levels. The mine track goes through it, and the interior is visible.

I didn't want to go too far with building the head house and the inclined conveyor until I had all of the materials needed to make the base. Building the walls was the same as before. The doors,



### 22. The four walls of the head house painted and the doors and windows installed.

windows and trim are glued in place after painting. Then, it's back to the straightedge and triangles to keep the walls square when gluing them together. This time there were no warps to deal with.

For the base assembly, spray the part with primer-sealer on both sides to stabilize the wood before removing all the pieces. Tape off areas where the floorboards will go on top of the base. Paint these brown before gluing them down.

Airbrush the base with dark gray and assemble the structure. There is more to do to complete the assembly and the floorboards will be added after the rails are glued down. I want the gaps between the floorboards and rails to be gray. The gray color also makes sense for the pit and the chutes as these will be covered with coal.

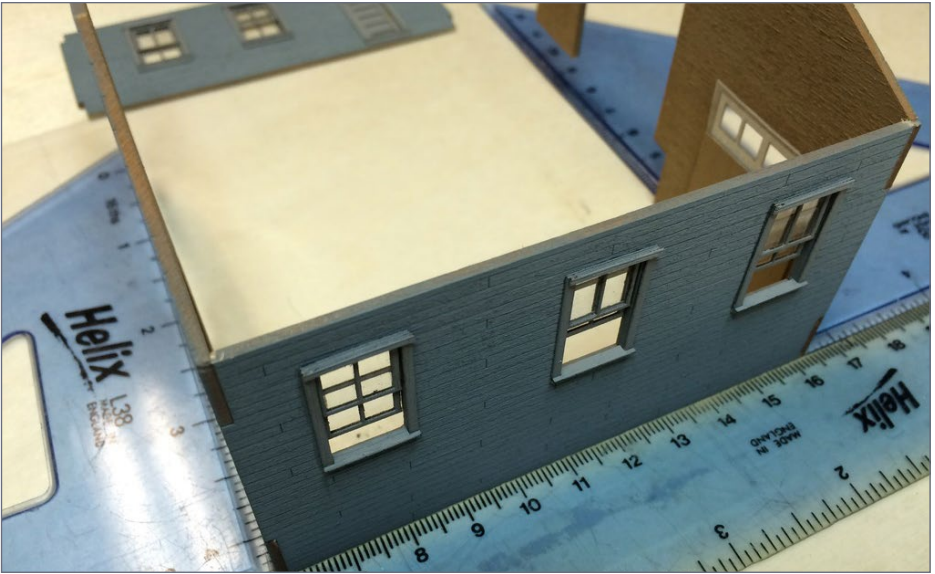

23. The head house is put together the same way as the main tippie building, using a straightedge and triangles to keep everything square.

Dry-fit the walls and base assembly [23] to make sure everything is square. Once they are adjusted to fit properly, hold them in place while the glue dries. I painted the interior of the walls a sand color to give them a raw wood look.

After the mine track and cork sheet for the base arrived, I placed it and the head-house on the 1/2" foam and checked elevations. The headhouse walls are not glued to the base at this point and the track and center boards are just set in place loose. The elevations looked good.

I added detail to the interior of the headhouse. The car unloader is just set in place here. Some minor tweaks with a knife are needed to get everything to fit perfectly. All in all, it goes together nicely. Weathering will blend the colors.

## BUILD A BTS COAL TIPPLE | 22

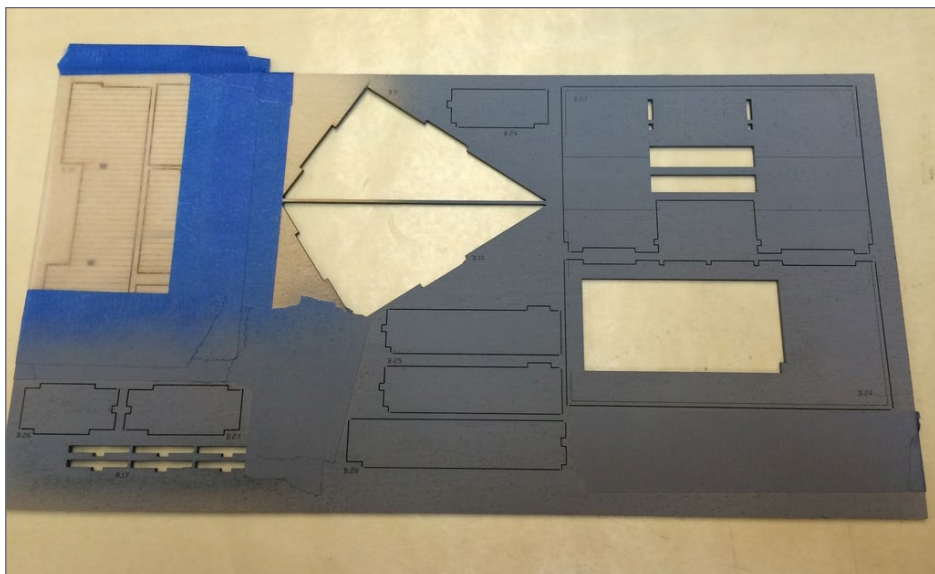

24. I masked interior parts of the head house so they can be painted sand color later to represent raw wood.

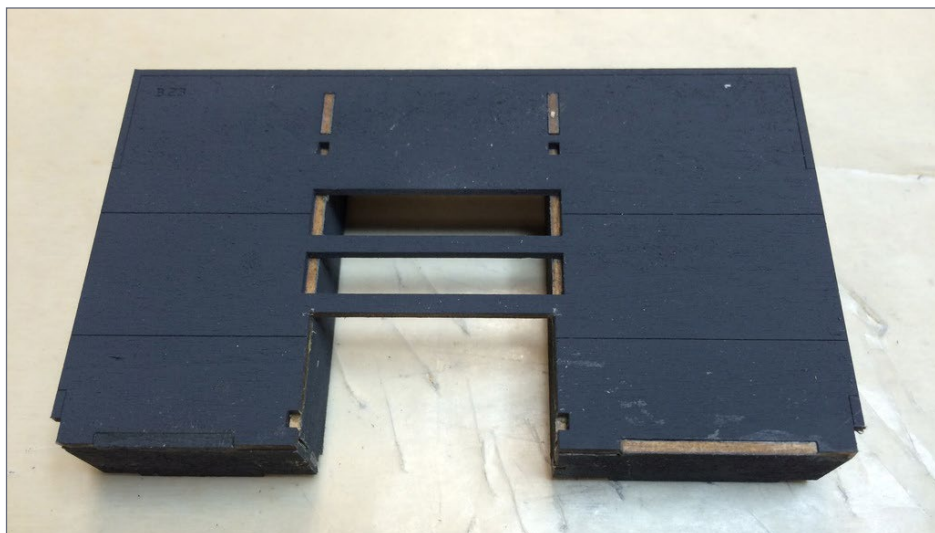

25. This is the raised base that houses the dumper. The mine rails go on this piece.

## BUILD A BTS COAL TIPPLE | 23



26. Test-fit the dumper base inside the head house.



27. The kit pieces fit very well, and the details like the door hardware add a nice touch.

## BUILD A BTS COAL TIPPLE | 24

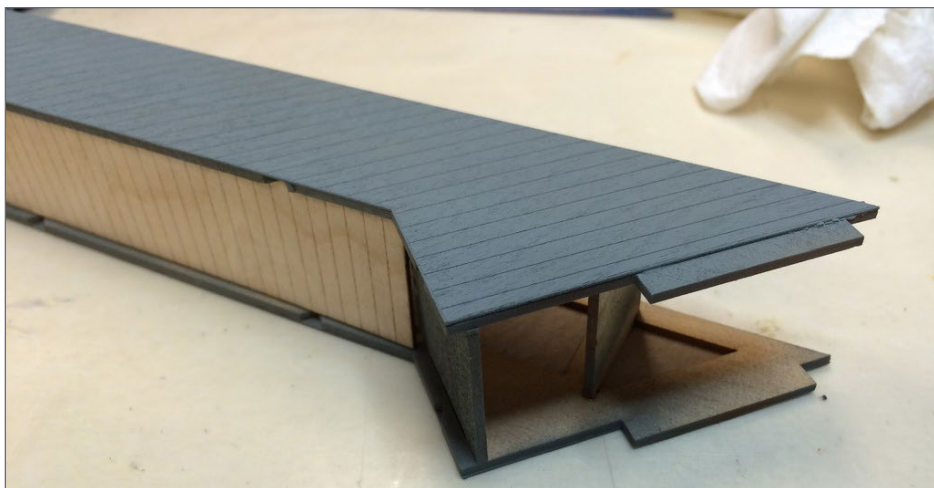

28. The inclined conveyor body is very simple to build.

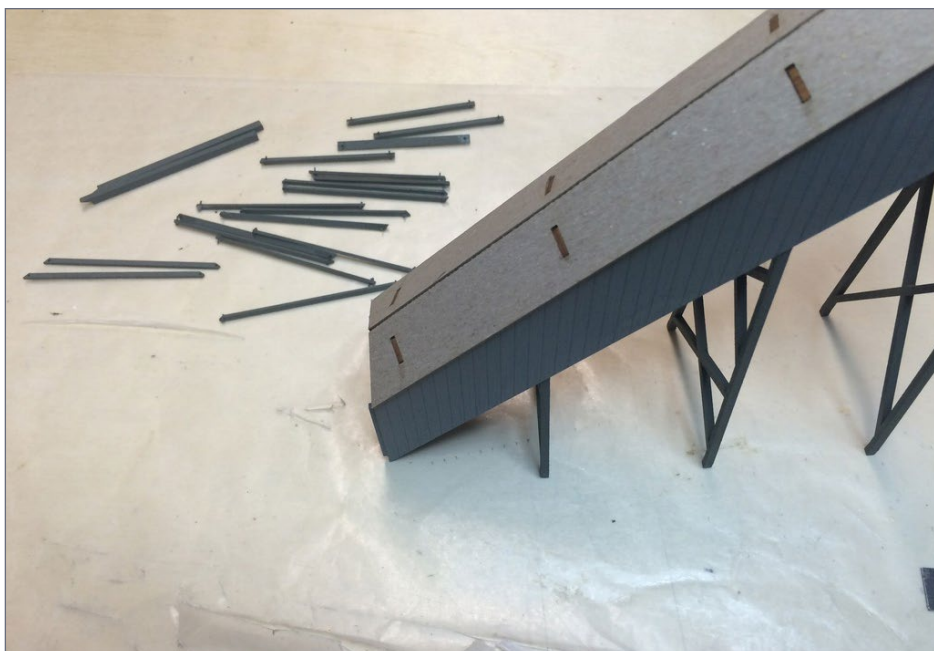

29. Cross bracing for the inclined conveyor uses the same assembly procedures as on the tippie.

## BUILD A BTS COAL TIPPLE | 25

The inclined conveyor between the head house and tippie is an easy build. The sides are laminated to a support frame, so the finished assembly is very strong and straight.

### Final assembly

Now it's time to put everything together and work on positioning the tippie on the layout. I printed out the "final" Xtrackcad track plan to help with this. The mine car track isn't final but I am getting a feel for where it will go.

I cut the sheet of 1/2" foam to match up against the cork forming the raised area under the rear of the head house.

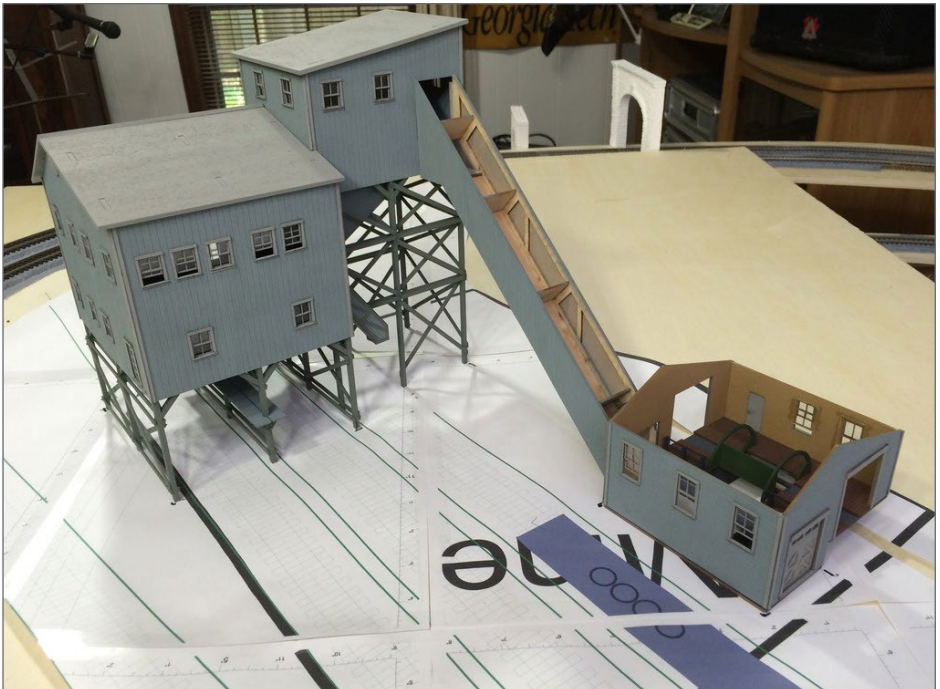

30. I drew the site plan on Xtrackcad and tested the buildings in place. So far everything lines up.



## BUILD A BTS COAL TIPPLE | 26



31. The headhouse is built on two elevations, with the dumper and mine track level  $\frac{1}{2}$ " above the main level.



32. A close-up of the dumper in the head house.

## BUILD A BTS COAL TIPPLE | 27

Cut out the foam to form the unloader pit on the elevated side. Once the cork and foam are glued down, paint these areas black. Add some coal later. All of this is inside the building so it only be visible through the windows and mine track doors.

Before getting carried away with the placement of the different parts, add the legs and bracing to the inclined conveyor, complete the headhouse, build all the stairs, and add details to the buildings. Then mark the base to show the position of all of the legs and landings before starting landscape work.

All the cross braces have holes for NBWs, just like the cross braces on the main building legs, so another session of gluing

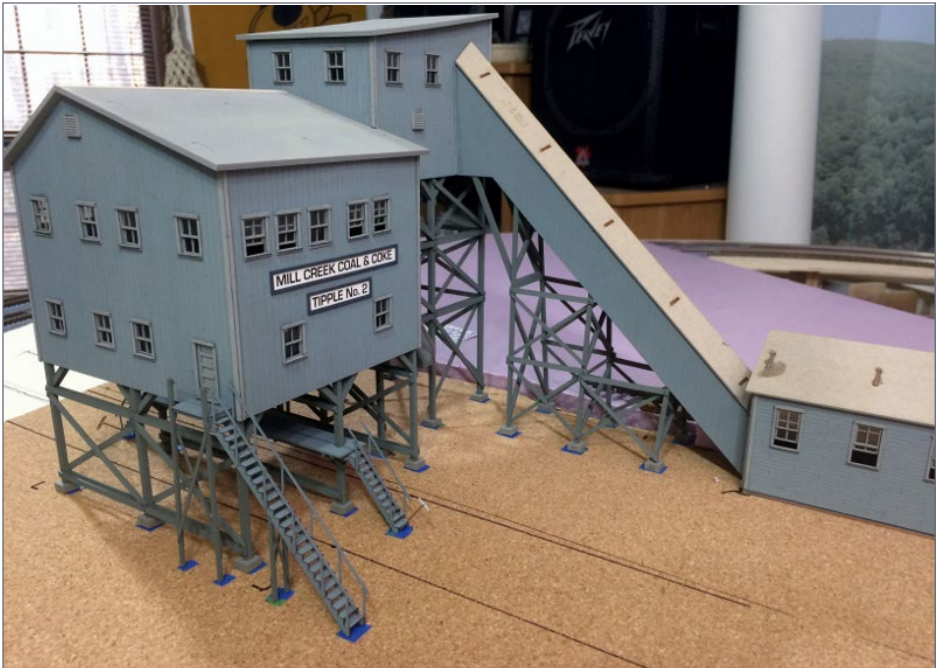

33. The foam and the cork are glued down. The tippie, inclined conveyor, and headhouse are all placed in position but not glued together yet. Everything is lining up horizontally and vertically.

## BUILD A BTS COAL TIPPLE | 28



34-35. The tippie in its home on the layout. The kit is essentially complete and it's time to build the scenery around it.

NBW's in place is needed. I was four pieces short of NBWs. Evidently not enough extras are included to make up for the ones that squirted out from my tweezers. The braces missing NBWs will go on the rear where they won't be seen.

The braces for the conveyor legs seem to be too long, so are not as perfect a fit as the ones on the main buildings. I doubt that anyone will notice.

Once the leg braces are glued on, test-fit everything one more time, and check for issues before gluing the cork and foam.

From this point forward, the order of progress will be important. Remember to paint the mine track before gluing it to the headhouse floor. Do not glue the unloader in place, so you can access the pit later to add coal, etc. The headhouse roof needs to be removable to work in there. Go slow, be very careful now, and try not to mess up and make things more difficult for yourself down the road.

I am still slowly working on my mine scene. The cork and 1/2" foam are glued down now. The elevations work out perfectly with 3/16" cork under the upper level of the headhouse extending to form a roadbed of sorts for the mine track. I am almost at a point where I can fix the positions of the buildings and begin landforming.

There is still a whole lot of work left to do to get this area of the layout to look finished but the building of the mine is essentially complete. Building structures is an area that I feel very comfortable with, but I welcome anyone to comment and share their "tricks" for building these sorts of structures.



[Click here for reader comments](#)

## WALT KAHRES

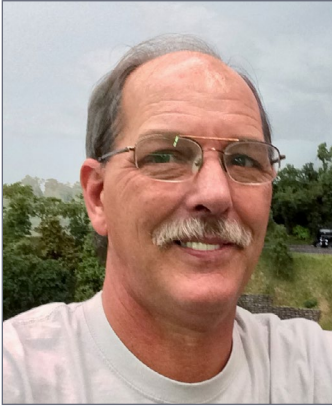

Model railroading has been one of Walt's hobbies since his dad built a basic HO layout for him when he was growing up. In his twenties, Walt built a 4x8 layout and spent several years working on it.

Walt started construction of his Huntington Junction four years ago and it currently takes up a 13x14 foot area in his basement. Walt's layout is a freelance based on the C&O and B&O lines running through Appalachia during the transition era. Big steam pulling coal drags was a major consideration in his choice of design.

To Walt, the hobby is more about a modeling journey and not so much about running trains. Even so, trouble-free operation is a top priority for him.

Walt is also an avid '60s Pontiac muscle car enthusiast and has several full restorations under his belt. He also has spent many years building R/C airplanes, focusing on large scale multi-engine WWII warbirds. Walt's other pastimes include playing guitar, fishing, and spending time with his wife, children and grandchildren. Walt recently retired from a corporate role in the pharmaceutical industry.

**MICRO-TRAINS®  
LINE**

Announcing our next Limited Run  
**PWRS / Micro-Trains® Car!!!**

**PWRS** 

**Montana Rail Link ex-BN (MRL) 4-pack**

**3 Bay ACF Center Flow® Covered Hopper, w/ Elongated Hatches**

- Blue w/Rail Link lettering & herald
- weathered to reveal ex-BN green color underneath



PACIFIC WESTERN RAIL SYSTEMS  
**SPECIAL RUN CAR**



CLICK HERE FOR  
**MRL ex-BN**

**COMING**  
June 2017

 **NORTH AMERICAN RAILCAR CORPORATION**



Agrium NAHX - 6 panel, long sill



Potash Corp (POTX) - 9 panel, long sill, 3000 series

CLICK HERE FOR  
**HO-NARC Potash**

Announcing our next release of  
**NSC Potash Service 4300 cf  
3-Bay Covered Hoppers**

CLICK HERE FOR  
**N-NARC Potash**



Canpotex (CNPX) - 9 panel, short sill, 1000 series

**WHITE  
FLEET**



Canpotex (CNPX) - 9 panel, long sill, 150000 series

**NARC Cars are sold  
exclusively through**

**Pacific Western Rail Systems**

• INDEX

• TABLE OF CONTENTS



# Freight Car Roofs

Of the  
Twentieth  
Century

BY RICHARD BALE

*Car builders faced a long learning curve in making roofs long-lived and tight against weather ...*

**ROOFS TURNED OUT TO BE ONE OF THE MOST** challenging issues to face car builders. In addition to the obvious

• [INDEX](#)

• [TABLE OF CONTENTS](#)



[Click here for  
reader comments](#)

requirement of protecting lading from theft and from the weather, including sun, rain, sleet, and snow; a car roof needed to be sturdy enough to support one or more trainmen as they moved from car to car setting or releasing mechanical brakes. The roof needed to provide these functions on an all-wood car that vibrated, twisted, and flexed as it traversed less-than-perfect track work. It was indeed a challenge.

The earliest car roofs were constructed of a layer of tongue-and-groove wood. This proved inadequate as the twisting car body caused the wood roof to buckle and part. Some success was achieved with the application of various water-resistant materials such as treated canvas. The material worked well on passenger cars but was less successful on freight cars on which trainmen were required to walk.

Sheets of water-resistant material spread between two layers of wood [1-2] met with some success but the shifting of the two wood layers soon rubbed holes in the inner membrane.

### **Flexible metal roofs**

New cars built beginning in the 1880s and 1890s began to receive metal roofs over wood frames. To accommodate twisting of the car body, the metal roof panels were not rigidly connected to one another, but rather overlapped or nested together to allow some adjustment as the car body shifted and twisted. A variety of metal-wrapped battens were developed to join the metal panels and still allow some movement.



## FREIGHT CAR ROOFS | 3

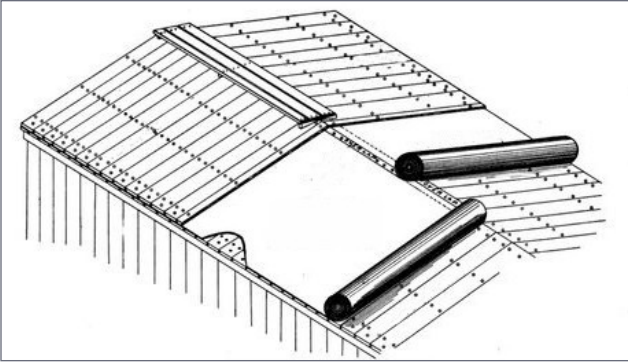

1. Hutchins plastic roof circa 1880.

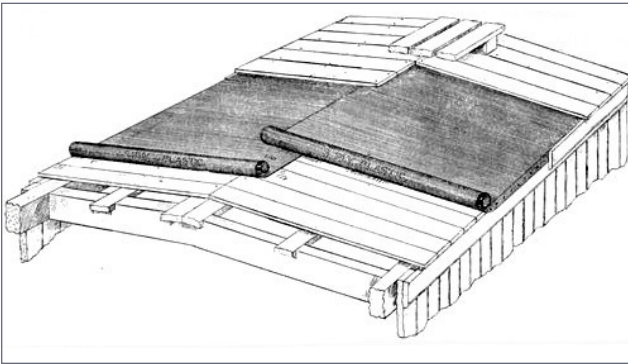

2. Drake Weirs roof circa 1880.

In the 1890s, the P.H. Murphy Manufacturing Co. of East St. Louis, IL developed an inexpensive galvanized metal roof that could be applied over a deteriorated wood roof [3]. Much of the success of the Murphy roof related to the special fixtures that held the metal roof panels in position while still allowing them to move as the car body shifted and twisted. Murphy made a similar metal roof under the Excelsior [5] brand name.

By the beginning of the 20th century, there were four general types of freight car roofs in use. They included:

- Double layer of wood boards
- Inside layer of boards covered with sheet metal panels

## FREIGHT CAR ROOFS | 4

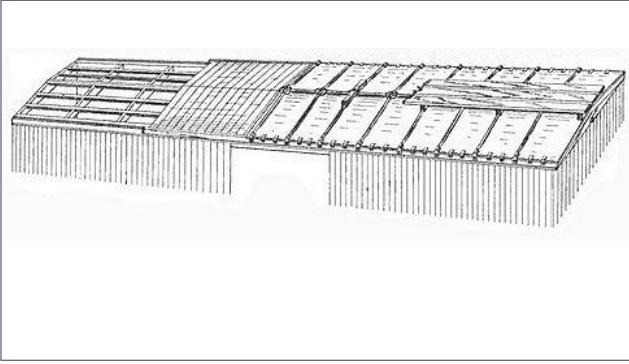

3. Murphy galvanized iron car roof manufactured by P. H. Murphy Co. East St. Louis, Illinois, circa 1890.

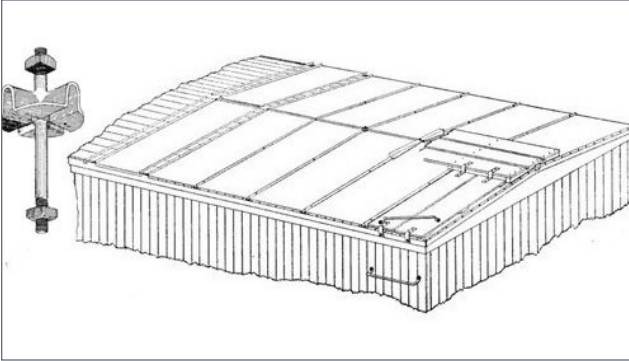

4. Excelsior car roof manufactured by Excelsior Car Roof Company, St. Louis, Missouri (an affiliate of P. H. Murphy Co.. Circa 1890s.

- Sheet metal panels protected with an outside layer of boards
- Inside wood roof covered with felt, tarpaper or asphalted canvas, topped by an outside roof of wood

In each type mentioned, the wood is fitted tongue-and-groove, and the metal panels are free to move as the car body twists and flexes.

Wood generally withstood wear from trainmen's boots better than thin sheet metal, so what may appear to be a plain wood roof is often an outer layer of wood over an inner metal roof.

At the turn of the century, dozens of companies were promoting roofs of similar design. Some were sold as kits with all the

## FREIGHT CAR ROOFS | 5

wood and metal fixtures needed to install a new roof on a boxcar. H.P. Murphy acquired several small companies. One example is a double-sheathed wood roof sold by the Winslow Car Roof Co. It was inexpensive but lacked any sort of effective moisture barrier. P. H. Murphy acquired the company in the late 1880s and reintroduced the roof as the Improved Winslow Car Roof [5] with flexible metal panels beneath the wood exterior.

In the early 1900s P. H. Murphy was itself acquired by Standard Railway Equipment Co. (Stanray) which continued to promote and sell a variety of metal roofs using the Murphy brand name. One of the most successful was the American Outside Roof [6].

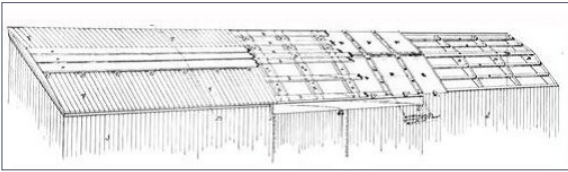

5. Murphy's Improved Winslow car roof, circa 1890s.

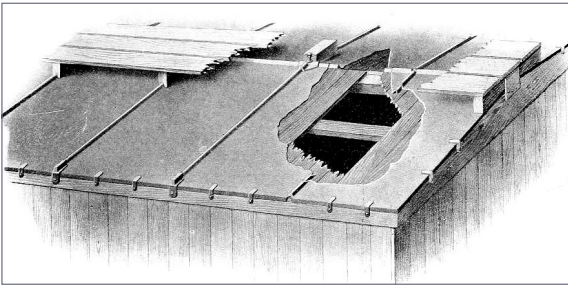

6. Murphy American Outside Roof, circa 1890.

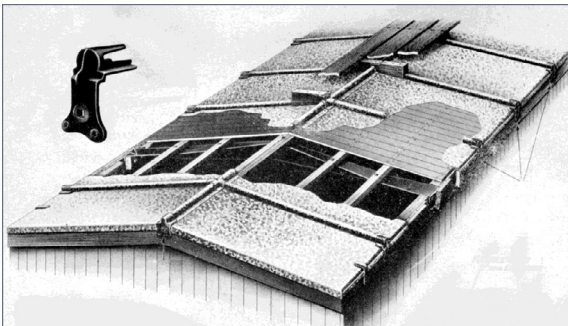

7. Superior flexible outside roof. Circa 1910.

## FREIGHT CAR ROOFS | 6

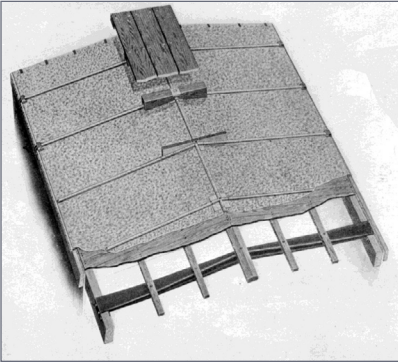

8. Chicago flexible outside roof Model 20. Circa 1915.

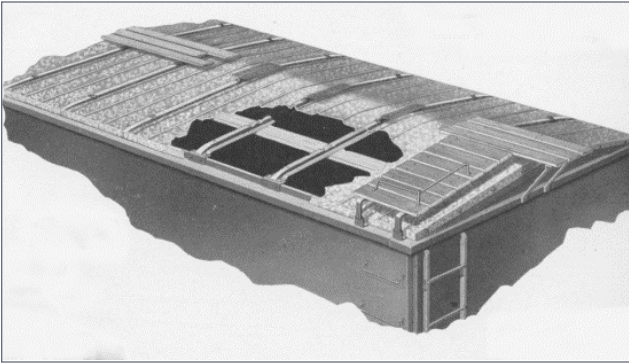

9. Viking all-steel rigid roof. 1910 through the 1930s.

The design claimed to lower the height of the roof and reduce overall car weight some 1200 pounds.

Another major manufacturer of freight car roofs was the Chicago-Cleveland Roofing Company which sold products under a variety of brand names including Superior and National. In the teens, the Chicago-Cleveland Co. promoted the Superior Flexible Outside Metal Roof [7] that used special cast clips to limit the movement of the metal roof panels. During the same period the firm introduced the Chicago Flexible Outside Roof Model 20. It was supported by stamped metal carlines and had thinner battens than the Superior version [8].

## FREIGHT CAR ROOFS | 7

By 1910 more freight cars were being built with steel under-frames which greatly reduced twisting and flexing of the car body. Chicago-Cleveland promoted the Viking rigid metal roof [9] for steel-framed cars and cataloged it through the 1930s.

Just prior to WWI, the Union Railway Equipment Company got into the roof business with a flexible metal roof it sold as the Ureco Type A freight car roof. It can be identified by the series of small ribs in each metal panel [10].

Certain dry products could sweat and begin to ferment if not provided with some ventilation. To solve the problem, the Hutchins Car Roof Company developed a roof that kept rain out but allowed some ventilation under the eaves where the roofing

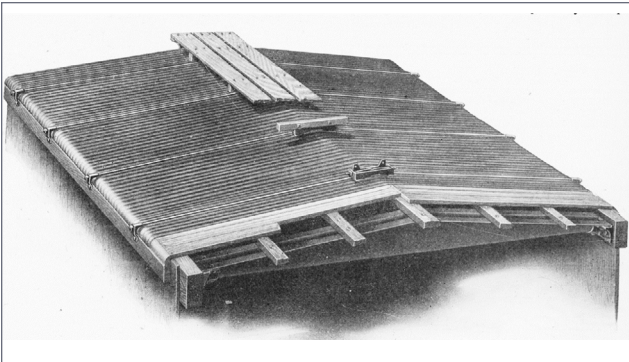

10. The Ureco Type A flexible metal roof from 1914.

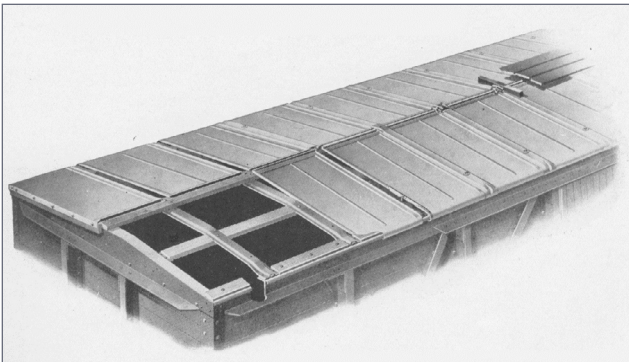

11. Hutchins dry-lading roof circa 1920.

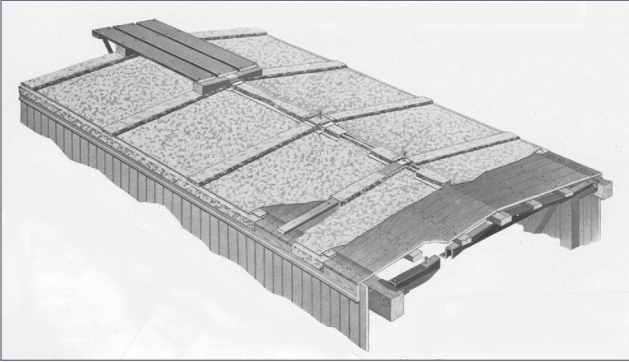

12. Murphy Improved model XLA, circa 1918.

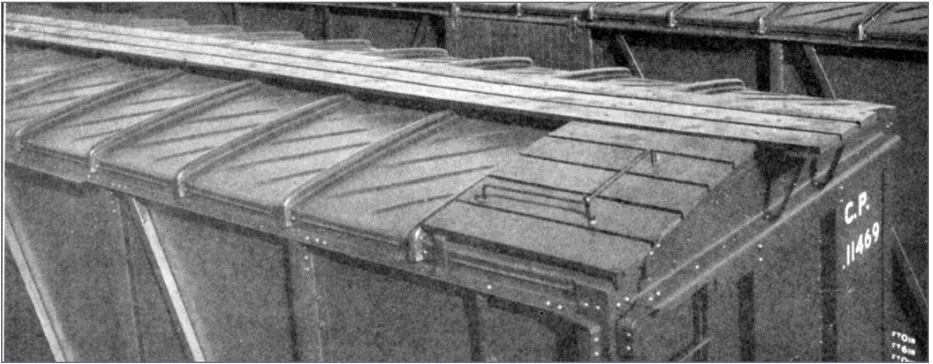

13. Hutchins radial roof from the WW-I era.

sheets were offset from the fascia. The spotting feature of the early Hutchins dry lading roof is a single small crease in the center of each roof panel [11]. Hutchins roofs gained considerable popularity in the early 1920s. The Murphy model XLA galvanized roof Stanray introduced in the teens had flat panels and plain flat seam caps [12]. The straight wood battens were encased with metal that nested into a fold at the edge of each roof panel. The XLA was inexpensive, and damaged panels and battens were relatively easy to replace. On a 40-foot car the XLA had 12 battens. A similar appearing Hutchins roof had sixteen seam caps narrower than the XLA battens.

## Radial roofs

Some railroads favored radial roofs which they considered stronger than traditional peaked roofs. Most peaked roofs consisted of metal panels or sections that joined under the running board. Radial roofs were less prone to leak because the curved roof panels extended the full width of the car without a seam in the middle.

Among the popular radial roofs that can be readily identified is the Hutchins roof that had three ribs pressed diagonally into each panel [13]. Chicago-Cleveland's two most commonly seen radial roofs were its Chicago "Common Sense" model 100-A [14], and the Climax roof that had two small ribs in the center of each panel [15]. In the late 1920s Stanray introduced an all-steel radial roof under the Murphy brand name [16]. It remained in common use through WWII.

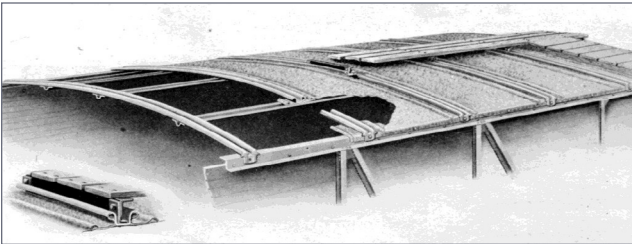

14. Common-Sense roof model 100-A from Chicago-Cleveland Co.

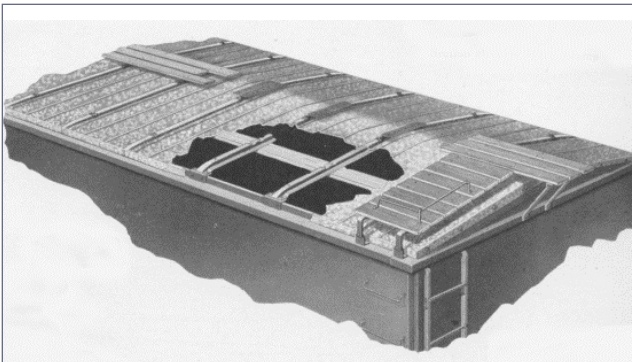

15. Climax radial roof introduced by Chicago-Cleveland Co. in the early 1920s.



16. Murphy all-steel radial roof manufactured by Stanray circa early 1930s.

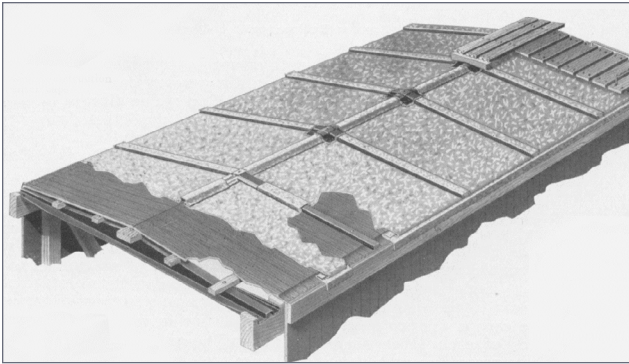

17. National flexible roof by CCRC late 1920s through the steam era.

Money for capital expenditures was scarce during the Depression years of the 1930s and many railroads elected to repair rather than replace aging equipment. Master mechanics had a wide assortment of replacement roofs from which to choose. The Chicago-Cleveland Co. offered several all-steel roofs including a flexible National [17] roof aimed primarily at older equipment, and the Zenith all-steel roof that used no rivets [18]. Both roofs utilized stamped metal carlines.

Stanray applied the Murphy brand name to several types of roofs. One of the most readily identified had panels with turned up edges that were held together with horizontal rivets [19]. A galvanized steel roof with welded double panels [20] was introduced in the late 1920s as a “new and improved” Murphy roof.



# FREIGHT CAR ROOFS | 11

One notable new design that appeared during the Depression was the wagon-top concept Baltimore & Ohio utilized for cabooses, covered hoppers and boxcars built in its own shops [21]. The inverted U shape resulted in a strong car body with a roof that couldn't leak.

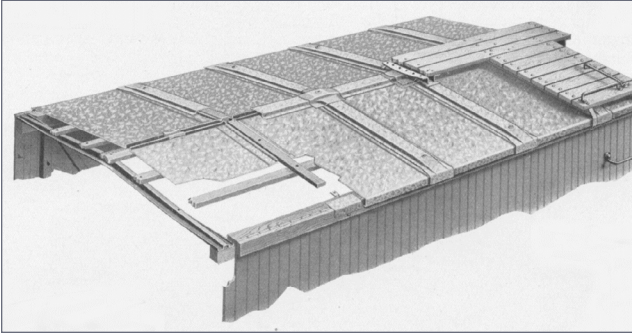

18. Zenith all metal.

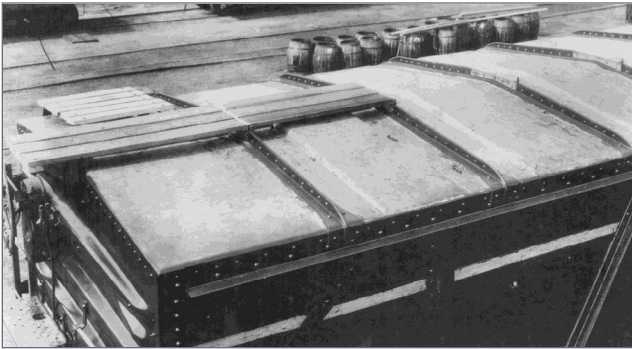

19. Murphy "solid steel" roof.



20. Milwaukee Road ribbed-side boxcar built in 1940 with unpainted galvanized steel Murphy double panel welded roof.



21. Wagon top roof with a Blaw-Knox Steel running board.

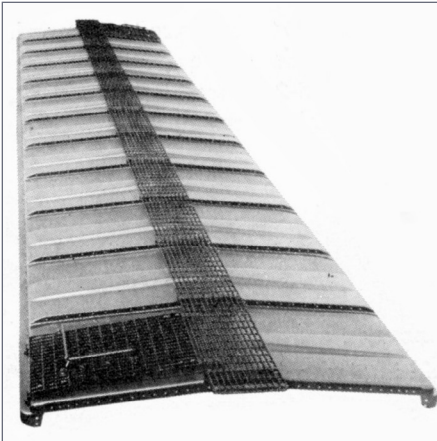

22. Pullman Standard riveted roof on a PS-1 boxcar.

## Post-WWII construction

The building boom after WWII saw the development of several new roof designs. The Pullman-Standard Car Manufacturing Co. used both riveted [22] and welded [23] roofs in building their ubiquitous PS-1 boxcar. The PS-1 roof is easily mistaken for a Murphy roof, which has slightly wider panels and therefore fewer panels and seams on a car of the same length.

Stanray's diagonal panel roof of the 1950s was available in both welded [25] and riveted [26] versions. They are virtually identical

# FREIGHT CAR ROOFS | 13

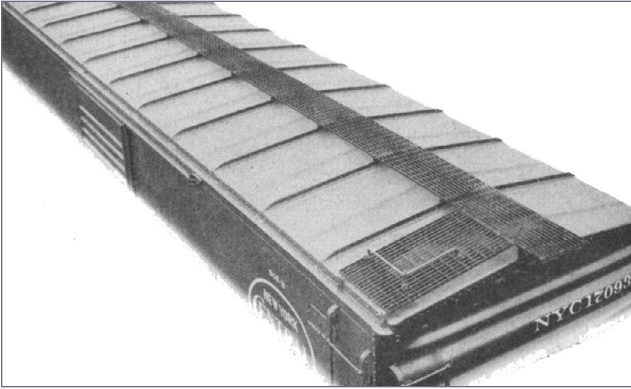

23. Pullman standard welded roof on a PS-1 boxcar.

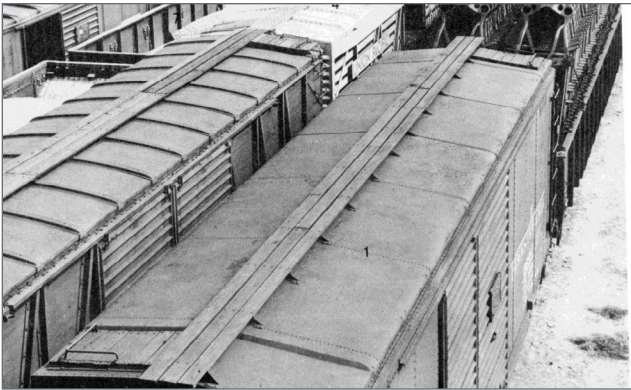

24. Pennsy boxcar built in 1941 with riveted roof with notched end panels to accommodate longitudinals and grab irons. Without notch car would exceed AAR clearance limits.

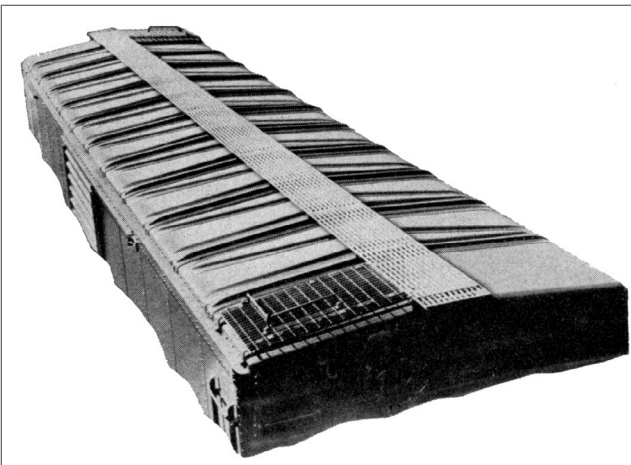

25. Standard diagonal welded panel roof from Stanray circa 1950.

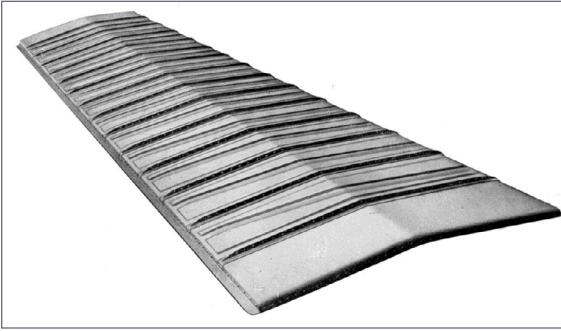

26. Stanray riveted diagonal panel roof circa 1970.

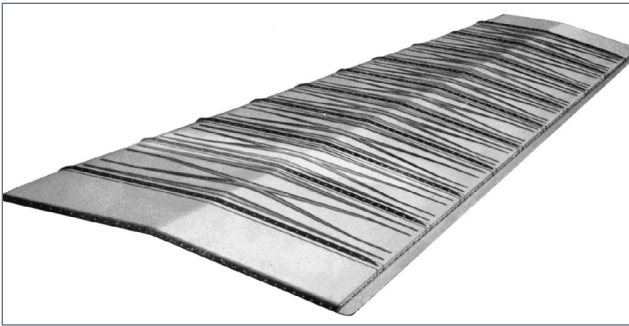

27. Stanray X-panel roof circa 1970.

and difficult to tell apart. All the Stanray panels extended the full width of the car body. All of them were impressed with a diagonal pattern except the end panels, which were left flat to facilitate installation of the latitudinals.

Stanray's X-panel roof [27] was introduced in the late 1970s. The X design was well accepted and became a signature product for Stanray. It is still used in contemporary flat roofs. Pullman-Standard's answer to Stanray's X-panel was the roof shown in figure 28.

# FREIGHT CAR ROOFS | 15

## RUNNING BOARDS, LATITUDINALS, AND BRAKE STEPS

### Wood running boards

Until the late 1960s, freight cars were required to have a longitudinal running board on the car roof. The Master Car Builders Association and later the AAR specified that the width of the



28. Modern Pullman-Standard roof from the 1970s.



29. Wood running board, latitudinal, and brake step.

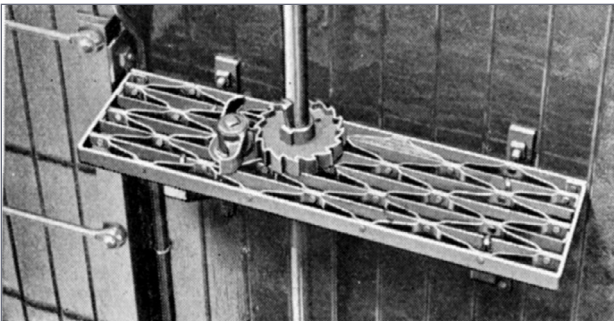

30. Safkar brake step.

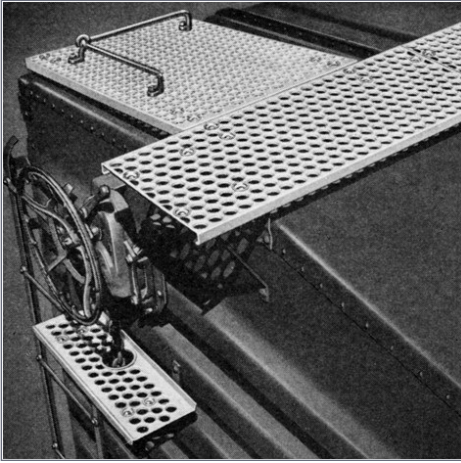

31. Morton metal running board.

running board be a minimum of 18 inches and a maximum of 20 inches. The running board was required to extend beyond the end of the car a minimum of 6 inches and not more than 10 inches, from a vertical plane measured from the inside face of the car's coupler.

Latitudinal extensions of the running board at the right-hand corner of the roof must be a minimum of 24 inches wide. A brake step, if used, must be a minimum of 28 inches long. Although there were sporadic efforts to produce metal versions of these components, through the first three decades of the 20th century the vast majority were made of wood [29].

### **Metal running boards**

Records reveal that one of the earliest uses of metal running boards was on an all-steel boxcar that Canadian Car & Foundry built during WWI. It was similar in appearance to Morton's punched hole design [31].

**Safkar:** The Safkar brand of steel running boards [30] were among the first to be available as a standard off-the-shelf

## FREIGHT CAR ROOFS | 17

product. Manufactured by the Irving Iron Works of New York, Safkar products were first shown in the 1931 edition of the Car Builders Cyclopedia. The design consisted of formed iron straps riveted together in a diamond pattern. The riveted assembly was held in place by an outer frame of heavier steel stock. The

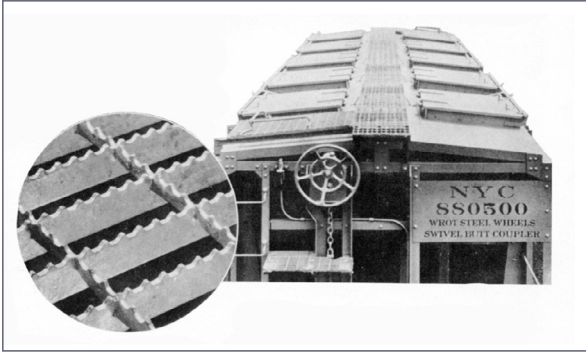

32. Apex Tri-Lok metal running board.

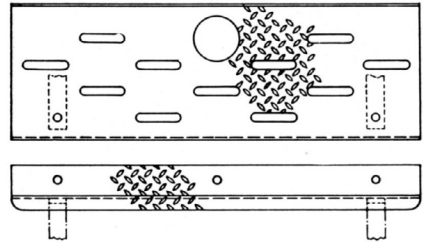
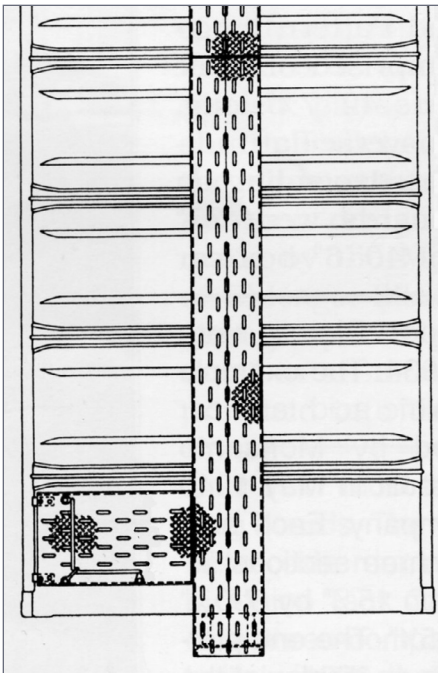

33. Alan Wood metal running board and brake step.

introduction came during the depth of the Depression and met with limited success.

**Morton:** In the late 1930s Morton Manufacturing Co. introduced a line of metal running boards, latitudinals, and brake steps using steel safety tread developed earlier by Kass Co. Morton products are readily identified by the distinctive 1.5-inch holes stamped in the steel plate [31].

**Alan Wood:** A Pennsylvania-based company named Alan Wood Steel introduced metal running boards and brake steps about 1937. The design used a series of slots punched into diamond safety tread steel plate [33].

**Tri-Lok:** Apex Railway Products Co. introduced its Tri-Lok brand products in 1937 [32]. The design consisted of serrated metal bars held in position by smaller serrated cross bars pressed into notches during the manufacturing process. Advertising material for Tri-Lok said that the open design was self-cleaning and quickly shed water, ice, and snow.

**Blaw-Knox:** Open grid running boards sold by Blaw-Knox [34] were similar in appearance to Apex Tri-Lok except that the cross pieces were made of quarter-inch spiraled rod rather than flat stock. Blaw-Knox steel latitudinals advertised in 1953 measured 40 by 24 inches.

**U.S. Gypsum:** About 1940 the United States Gypsum Co. introduced running boards, latitudinals and brake steps made of lightweight expanded metal [35]. An open diamond pattern was formed by stamping and stretching 12-gauge steel. USG running boards and associated components cost about 20 percent less than comparable items from Tri-Lok, the leading supplier at the time. Per USG advertising, by 1953 more than 75 railroads were using USG expanded metal running boards.



## FREIGHT CAR ROOFS | 19

**Kerrigan:** In 1950 the Kerrigan Iron Works of Nashville, TN, introduced a line of metal running boards and brake steps. The Kerrigan design was visually like Blaw-Knox products except that

they used a spiral rod to hold the serrated metal strips in position [36]. The Kerrigan, Blaw-Knox and Tri-Lok running boards were all composed of 12 rows of edge-mounted serrated steel. It is difficult to distinguish among the three.

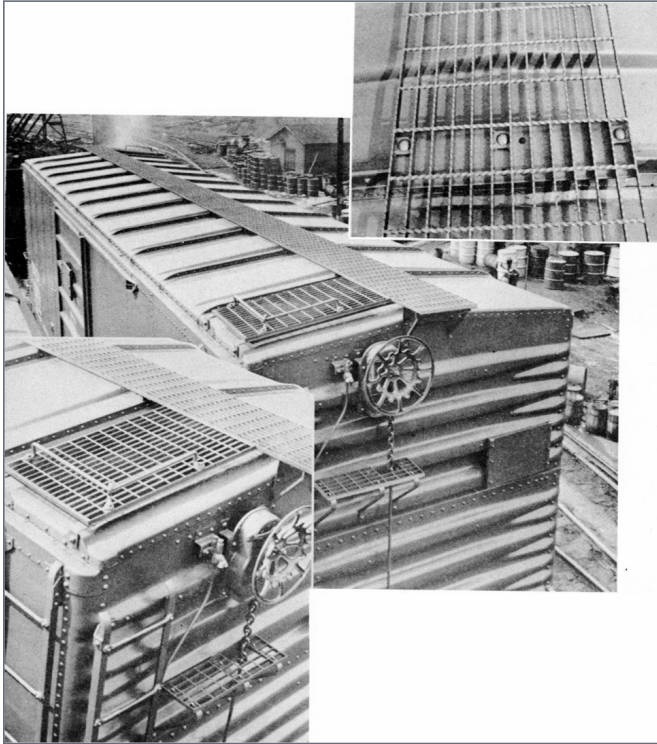

34. Blaw-Knox metal running board.

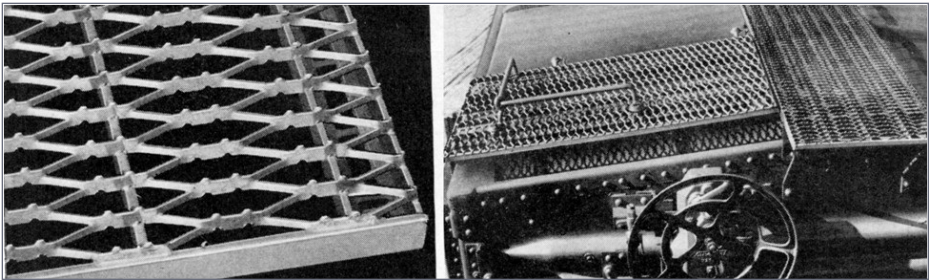

35. U. S. Gypsum Co. stretched metal running board and latitudinal.

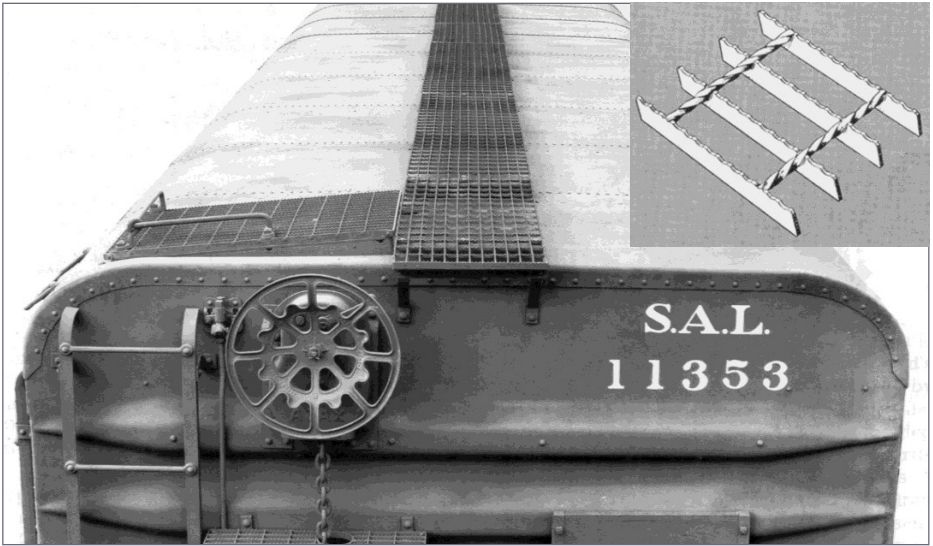

### 36. Kerrigan metal running board.

**Stanray:** The Standard Railway Equipment Co. offered a steel brake step with half-round punctures pressed upward to engage the soles of a trainman's boot [37].

**Parish:** Parish Pressed Steel Co. cataloged a steel brake step with a series of round holes in the 1940 edition of the Car Builders Cyclopedia. The edge of the holes was slightly ragged, creating a non-slip surface on the brake step [38].

**Vilco:** The Vilco Railway Equipment Co. steel brake step [39] is similar in appearance to the type sold by Stanray [37].

Metal running boards and latitudinals were required on all new cars built after 1945. As of 1966, running boards were no longer required on new cars. In 1974 the ARA issued a directive to remove all running boards on house cars. As the deadline approached, the effective date of the order was extended to 1979.

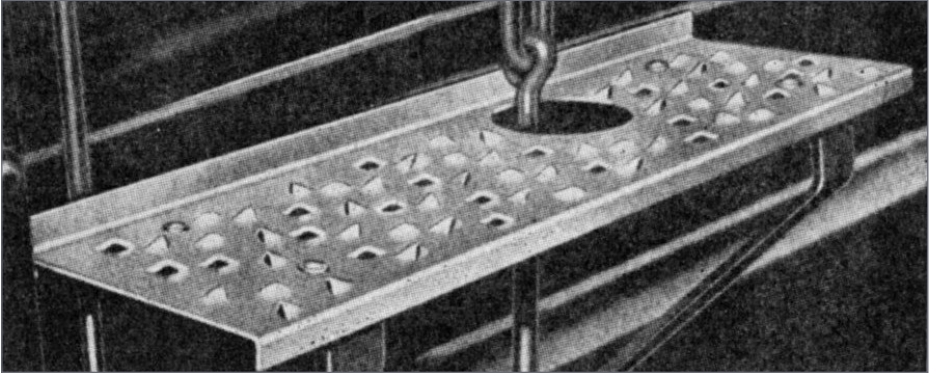

37. Stanray pressed steel brake step.

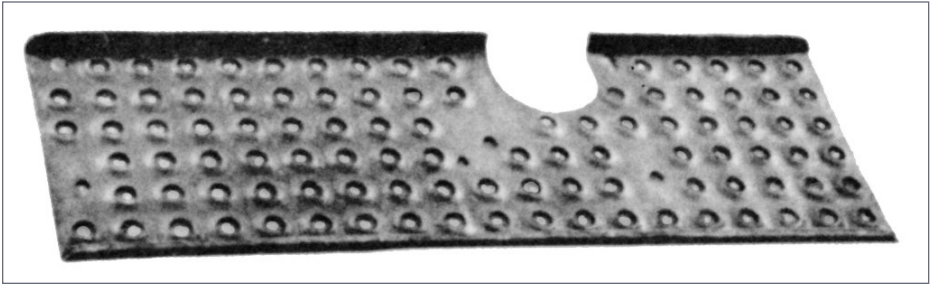

38. Parish non-skid steel brake step,

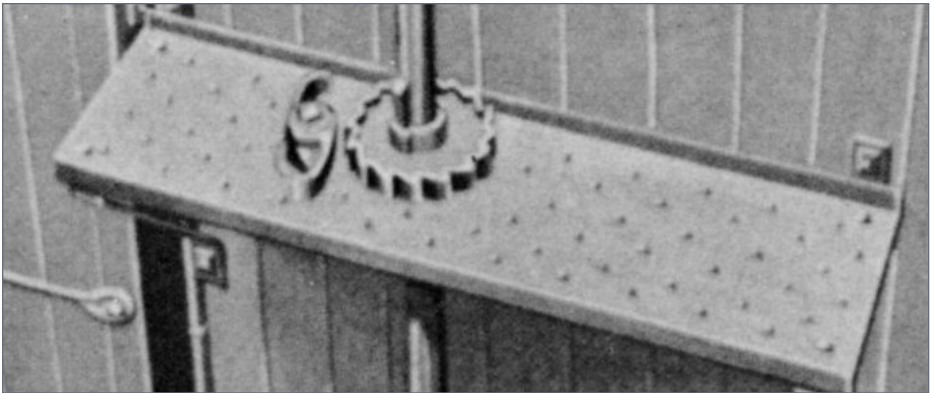

39. Wilco steel brake step circa 1939.

To facilitate loading and unloading, covered hoppers and tank cars continue to be equipped with walkways.



[Click here for reader comments](#)

---

## RICHARD BALE

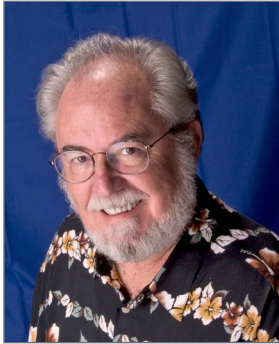

Richard Bale writes the monthly news column in MRH. He has been writing about model railroading since the 1960s. His articles have appeared in several publications including *Rail Line News* which he published in the 1990s. Bale enjoys all aspects of the hobby including researching the prototype. He currently serves on the board of the North County Model Railroad

Society in Oceanside, CA.

---

**Want to help keep  
MRH free?  
Then *click* on ads!**



S T A T I O N

Model Railroad Technologies  
Accutrack Speedometer 2

**NCE**  
The Power of DCC

**Digitrax**  
Complete Train Control

**Tsunami 2**

**LOKSOUND**  
SELECT

**TRAIN CONTROL**  
SYSTEMS



- Click here to visit our website -

[www.LitchfieldStation.com](http://www.LitchfieldStation.com)  
623-298-7355

# CHANGE COAL INTO CRUSHED ROCK

BY JOSEF BRUGGER

PHOTOS COURTESY OF THE  
COLUMBIA CASCADE & WESTERN

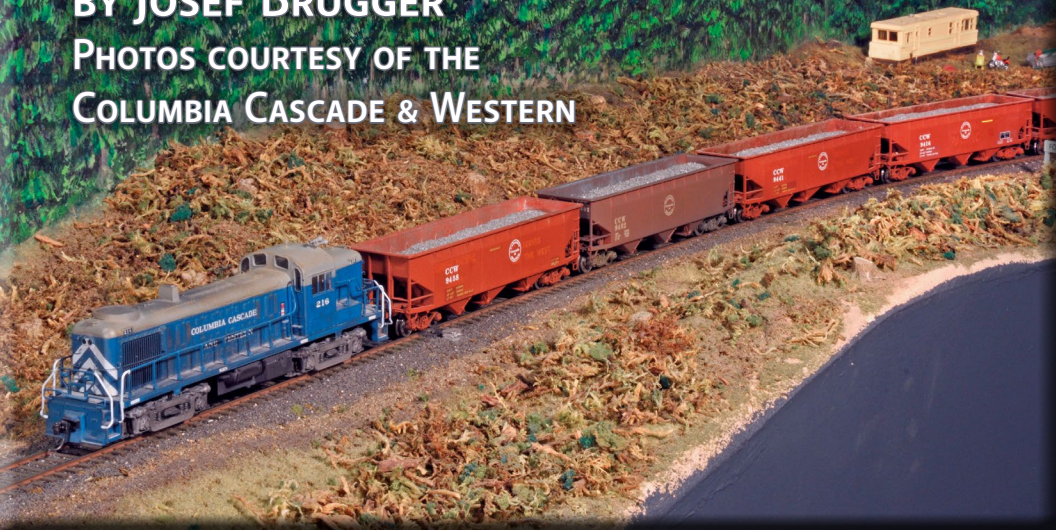

## *Modify Accurail offset-side hopper car loads for new traffic ...*

**WE RUN ONE “PAIRED INDUSTRY” ON OUR CLUB** layout – a quarry and rock crusher up in the Oregon Cascades at Detroit, and a concrete batch plant down in the Willamette Valley at Brooks.

The trip is barely 60 miles in the real world but our eight-car shuttle operation moves 560 tons of aggregate every run it makes. The operation is modeled on the Portland and Western’s “Rock Trains” [youtube.com/watch?v=NDQ4msyEWu8](https://www.youtube.com/watch?v=NDQ4msyEWu8) that run from the Reed pit near Brooks to online customers in the Hillsboro and Scappoose areas.



**Click here for  
reader comments**

Our club's AM operations schedule includes a run up the hill with empties from Brooks to Detroit – one that is assigned from the crew pool and is pretty popular. It involves about 90 real-time minutes on duty by the time the train runs up the long branch line to Woodburn Junction, then reverses direction and goes east on the Columbia Cascade & Western mainline. When the R98 gets to Detroit, it sets out its string of empty rock cars before continuing up the line to work the Green Veneer mill at Idanha. Once that is done, it heads back to Detroit to tie up.

The PM crew, called mid-afternoon for R99, goes on duty at Detroit, picks up loaded aggregate cars and outbound Idanha traffic, and switches empties into the loading track. It then runs west to the branch junction, places the outbound Idanha cars for pickup, and heads down the branch to Brooks with its loads.

Shuffling loaded and empty cars around at Viesko Quality Concrete at Brooks is handled by a local switch job based in Woodburn. Viesko also gets sand and cement loads that come onto the railroad via a Southern Pacific connection at Woodburn. The usual ratio is three cars of cement, six of sand, and eight of aggregate.

All of this is a long way of explaining that our club layout (see the February 2013 MRH for more information, at [mrhpub.com/2013-02-feb/land/#69](http://mrhpub.com/2013-02-feb/land/#69)) needs a fleet of hopper cars and several loads of aggregate.

## COAL INTO CRUSHED ROCK | 3

We met the car needs by scouring area hobby shops for Accurail offset-side triple-dump hoppers. The cars are inexpensive, nicely detailed, and have clever unbreakable stirrup steps at the corners. The prototype cars would have been available on the second-hand market in our late-1970s time frame.

Our search turned up a mix of Milwaukee, Southern Pacific and Union Pacific cars. These went through the company shops (Rick Andrews and me) for a quick re-spray and new lettering. The cars' heritage shows through the economically applied new paint.

The loads are a different matter. We proposed loose loads but the operating foreman and his minions rejected the idea. We tried gluing loads of gray ballast on panels of .060" styrene but the drying white glue made the panels curl up.

Abandoning that idea, we found Accurail #303 coal loads [accurail.com/accurail/coalload.htm](http://accurail.com/accurail/coalload.htm) hanging on a peg at the local hobby shop. A poly bag of 12 has an MSRP of \$14.98 and the shop gives a discount to clubs. Steel ball bearings snap into pockets on the underside of the load, and the loads can be removed using a magnet. The molded plastic loads come in several sizes to fit the Accurail range of open hoppers.

The raw material costs less than a dollar a load. There are eight cars in each shuttle train, with one set being loaded at Detroit, one being unloaded at Brooks, and another in transit either up or down the hill. The CCW has a couple of spare cars to cover maintenance and repair down time.

Here's how we change a load of plastic coal to look like aggregate.

*See the following pictures ...*



# COAL INTO CRUSHED ROCK | 4



1. The CCW acquired its 26 rock cars on the secondhand market. Some cars got a light spray job with Krylon #1317 ruddy brown primer, and some are Southern Pacific freight car brown. The yellow lines indicate the maximum fill level for crushed rock and gravel. The models are Accurail 7500-series three-bay 70-ton offset hoppers, with Kadee #5 couplers and InterMountain 33-inch wheelsets.



[Click here for reader comments](#)

# COAL INTO CRUSHED ROCK | 5



2. The stock plastic Accurail coal load fills the full length and width of the car, with its top rising above the top chord of the hopper car.



3. Rock is more dense than coal, so a smaller volume makes up a full load in a 70-ton car, and tops out several feet below the top chord. Cars assigned to aggregate loading are marked with a lettered notice or a 4-foot-long yellow line.

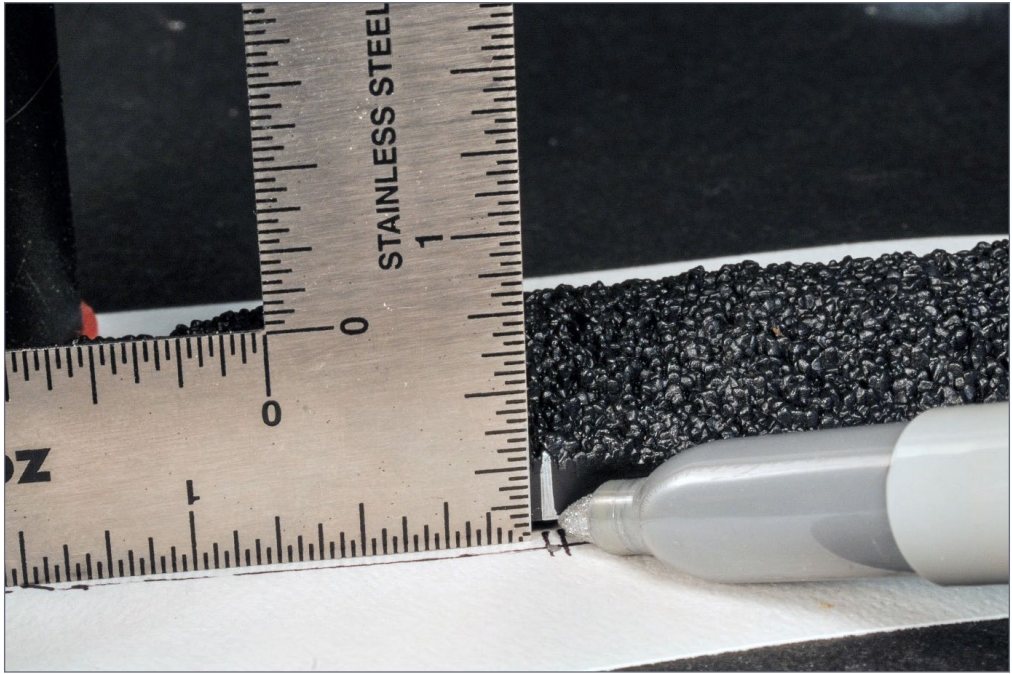

4. The loads must be trimmed to sit lower in the car. Locate the side brace positions and cut 1/8" deep slots into the side of the load. The slots will allow the dropped load to clear the car's internal bracing. Use a razor saw or cutting disc to reduce the depth of the loads sides to eliminate interference. Cut just below the top of the flat edge. Clean up the edge with sandpaper or a flat file.



[Click here for  
reader comments](#)

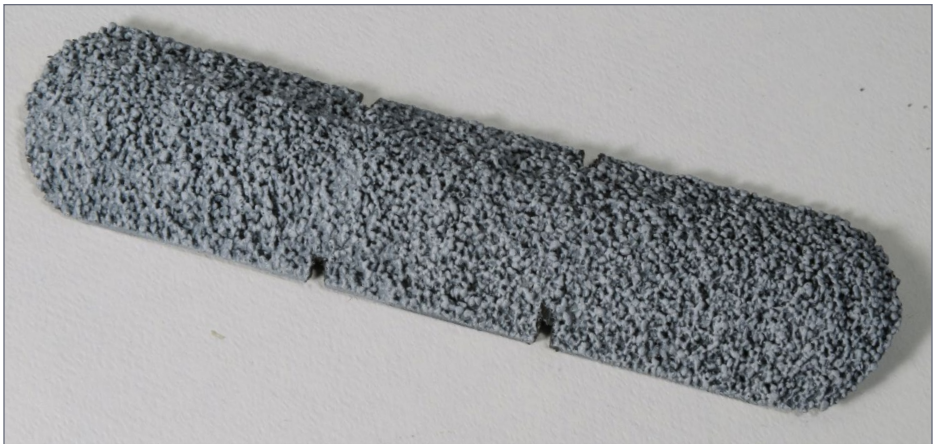

5. Here is how the four clearance slots look from above. The load sits well down in the car and the slots are almost invisible.

## ADVERTISEMENT



# Archer

**FINE TRANSFERS**  
PROUDLY SERVING MODEL BUILDERS SINCE 1989

**THE ORIGINAL**  
**SURFACE DETAILS™**

**WE NOW HAVE MORE THAN 130 SHEETS OF RIVETS, LOUVERS, TREADPLATE, WELD SEAMS AND MORE CAST ONTO MICROSCALE CLEAR DECAL FILM**

**LOW SHIPPING:**  
DOMESTIC USA ORDERS \$2.80  
INTERNATIONAL ORDERS \$9.95

▶ **CLICK HERE TO VISIT OUR WEBSITE!** ◀

Archer Fine Transfers • PO Box 1277 • Youngsville, NC 27596 • USA  
(919) 570-1026 • info@archertransfers.com • archertransfers.com

*"Archer Fine Transfers 3D decals have revolutionized kitbashing and scratchbuilding. Putting rivets or other low-relief details like louvers or weld seams on your models is now as easy as applying decals."*

Joe Fugate, Publisher/Editor Model Railroad Hobbyist

## ADVERTISEMENT

# TRINITY 3281

## IN STORES NOW



Norfolk Southern -- 12 #s



ICE-GATX -- 8 #s



Winchester & Western -- 12 #s



NRLX Ciment Quebec -- 12 #s

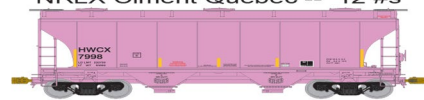

HWCX -- 7 #s



[www.americanlimitedmodels.com](http://www.americanlimitedmodels.com)



6. To make the load sit naturally in the car at the load line, taper the ends to match the angle of the slope sheets. A cutting tool with a disc, medium grit sandpaper, or a small belt sander will work. The precise modeler with a lot of loads to modify could build a jig and use a saw to cut or grind the angle.



[Click here for  
reader comments](#)



7. Create the first load through trial and error. Sand or grind away the plastic a little bit at a time, and test-fit it in a hopper car. Sand the sides lightly so the magnetic load will be easy to drop in and remove. The modified load at the bottom is dry-brushed to look like crushed granite. It looks OK from a distance, far better than an empty car. But crushed rock for concrete has smaller particles than the plastic coal load. More on that later.



[Click here for  
reader comments](#)

# COAL INTO CRUSHED ROCK | 10

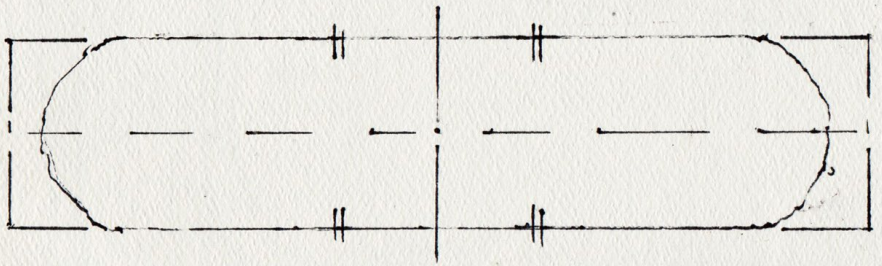

8. When the test load fits correctly and is easy to add and remove, trace a pattern on heavy paper to show the correct modified length. Because the load sits so deep in the car, matching the exact slope sheet angle isn't critical, but the curved ends should rest on the slope sheet. The end-to-end length of the car's interior is 40 feet, shown by the rectangular lines. The curved lines show the trimmed load, and the hash marks on the side are the positions of the internal braces.

## ADVERTISEMENT



Announces their purchase of  
BEST's  
Laser-cut Structure Kits

CHECK  
IT OUT!

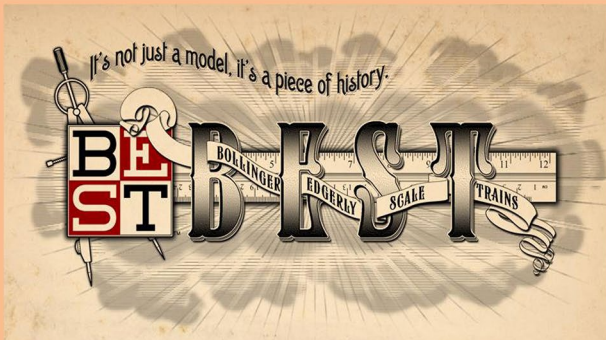

To order or get more information, please email Jeff at:  
[motrakmodels@centurylink.net](mailto:motrakmodels@centurylink.net)

## COAL INTO CRUSHED ROCK | 11



9. After painting, it is painfully obvious that Accurail coal lumps are much bigger than the aggregate mixed with water, sand, and cement to make concrete. Paint a generous layer of matte medium or thinned white glue over the plastic load and sprinkle on a layer of fine rock. This is Highball Products HO dark gray limestone. N scale ballast would represent a finer grade of aggregate. If not wanted, the rock's sparkle could be muted with a Dullcote overspray. These rock loads are more delicate to handle than the original plastic molding.



## COAL INTO CRUSHED ROCK | 12



10. In the car at right, Rub-N-Buff Pewter gives the car interior the look of paint worn by repeated loading with of crushed rock. Rub-N-Buff is applied with a cotton swab, and the car color dry-brushed on top of it. The brown car at left has dry-brushed PollyScale aluminum inside. Some of the cars are weighted with flat lead and others have hopper wells filled with lead shot held in place with thinned white glue.



[Click here for  
reader comments](#)

# COAL INTO CRUSHED ROCK | 13



11. The finished product. Adjust the size and color of the rock as needed.



12. A Columbia, Cascade & Western Alco RS2 hauls R99, the loaded westbound rock train, through Fox Valley on the CC&W club layout. ✓

## TOOLS

- Razor saw
- or, cutting disc and motor tool
- or, belt or disc sander
- Sanding block with medium grit paper
- Hobby knife

## MATERIALS

- Accurail magnetic coal loads
- Highball Ballast dark gray limestone
- or, Arizona Rock & Mineral #1301 Northern Pacific Gray Ballast, [store.rrscenery.com](http://store.rrscenery.com)
- or, appropriately sized, scaled, and colored crushed rock



**Click here for  
reader comments**

### JOSEF BRUGGER



Joe remembers standing on a country road bridge near his childhood home in Ohio, waiting for coal-burning New York Central steam engines to pass beneath – while wearing the starchy light blue shirt his parochial school required. Mother was not amused.

He never received a Lionel or other train set as a Christmas gift. Joe is involved in researching the Union Pacific as it was in Idaho in the 1970s and is a long-time supporting member of the Union Pacific Historical Society. He also dabbles in Swiss/Austrian HOe. Due to a miscommunication, he was formerly listed in Mountain Bell's Pocatello, Idaho telephone directory as Jose F. Brugger.

Joe edits the Questions, Answers & Tips column for *Model Railroad Hobbyist*.



[Click here for reader comments](#)

# A message from Joe Fugate

Founder, MRH and TMTV



## What topics does TMTV have?



TMTV has 400-some videos in nine categories, & we're adding 1-2 new videos per week ...



### LAYOUTS



### PLANNING



### BUILDING



### ELECTRICAL



### MODELING



### OPERATING



### TOOLS/TIPS



### PROTOTYPE



### VENDORS/EVENTS

**LOOKS GOOD, SIGN ME UP >>**



# ULTRA-TINY LIGHTS

*with fiber optics*

BY WAGNER CIONGOLI

## *Material from toys and lampshades solves a tough lighting problem ...*

### **RAILROAD MODELING IS A FASCINATING HOBBY.**

It does not provide us with financial gains, but with pleasure, relaxation and new friends. Those who like modeling railroads often face limitations in attempting to reproduce certain real characteristics. Lighting locomotives, freight cars and structures can be very difficult. The smaller the modeling scale, the tougher the job.

• INDEX

• TABLE OF CONTENTS



[Click here for  
reader comments](#)

With the advent of light-emitting diodes (LEDs), and now microLEDs, the hobby has experienced a major breakthrough in lighting. The drastic reduction in the size of the light sources gives modelers greater opportunities for realism.

LEDs are available in the market in sizes ranging from 2.5 mm to 16.8 mm, but those which interest us are the smallest, now at 2.5 mm. These tiny lights haven't completely solved the problem. Some lamps that are very small in the real world, when reduced to the working scale, need to have diameters of tenths of a millimeter. This is most evident to modelers who work with N or Z scale.

Our project involves an HO GE 5200 electric model locomotive by Frateschi. The major challenge is representing the two red rear signal lights. These lights, in HO scale, should be between 3 and 4 tenths of millimeter. The lamps are positioned half a centimeter below the windows of the engineer's cabins and light up in red to indicate the rear of the locomotive.

*Photos on the following pages ...*

1. (Lead photo) Optical fiber can be found in some decorative items and toys, like these fibers, that can be purchased in stores or on the internet.



2. So far, lighting descriptions by other modelers have usually referred only to the lights that illuminate the front of the locomotive. Modelers use white or yellow microLEDs for these but have ignored these small rear red lamps, for understandable reasons. The technique presented here uses optic fibers and considerably expands the arsenal of tactics for modelers, as it dramatically reduces the size of the light source.



[Click here for  
reader comments](#)





3. In 1870, the English physicist John Tyndall demonstrated the principle of guiding of light by means of a simple experiment. Using a leaky container with water, a bucket and a light source, Tyndall observed that the beam was illuminated through the hole in the container.

## ULTRA-TINY LIGHTS | 5

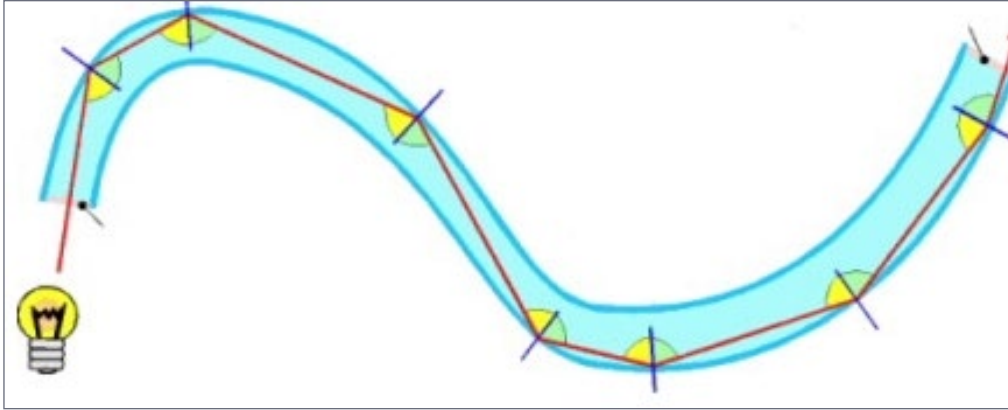

4. The optical fiber is glass or plastic polymer. Optical fibers have a transparent core surrounded by cladding with a lower refractive index. Light is contained in the core by the phenomenon of total internal reflection.

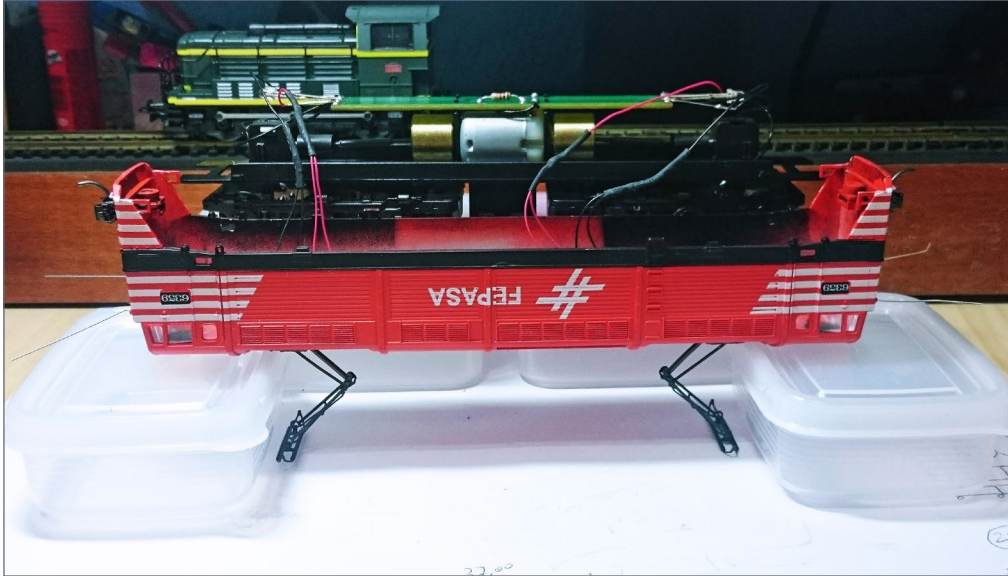

5. Start by disassembling the locomotive or rail car according to the manufacturer's instructions.

## ULTRA-TINY LIGHTS | 6

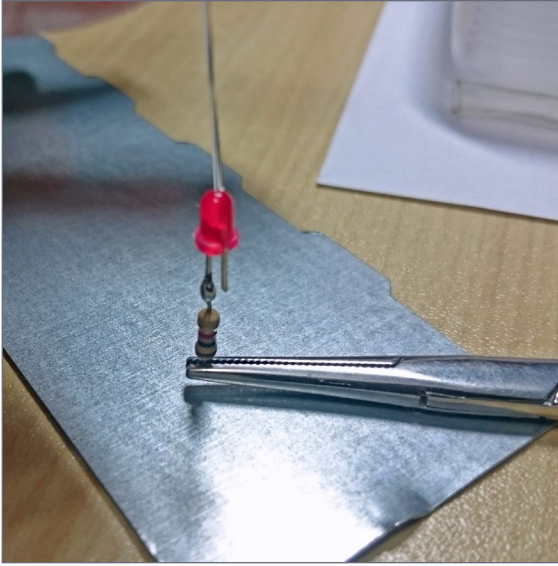

6. This procedure is very important and delicate. The ends of the optical fibers should touch the LED surface to ensure good uptake of light. Before gluing the fibers in place, do a couple of test fittings with a lighted LED to check the ideal position for bonding of fibers.



7. We will install two 2.8mm red LEDs, one in each cabin, to serve as the light sources. Solder a resistor to the positive pole of each LED to limit the in-flow voltage. Cut two 100mm (about four inches) pieces of optical fiber and attach them to the LED housings with a drop of hot glue or superglue. Keep the soldering iron away from optical

fiber – heat will make it shrivel up and you will need to start over with a new piece.

## ULTRA-TINY LIGHTS | 7

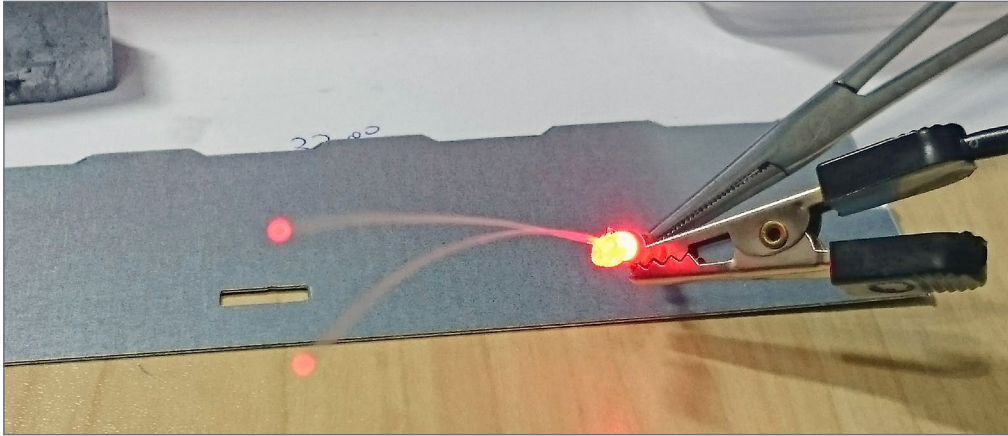

8. The system can be tested by turning the LED on and checking the tiny red lamp that will glow at the tip.

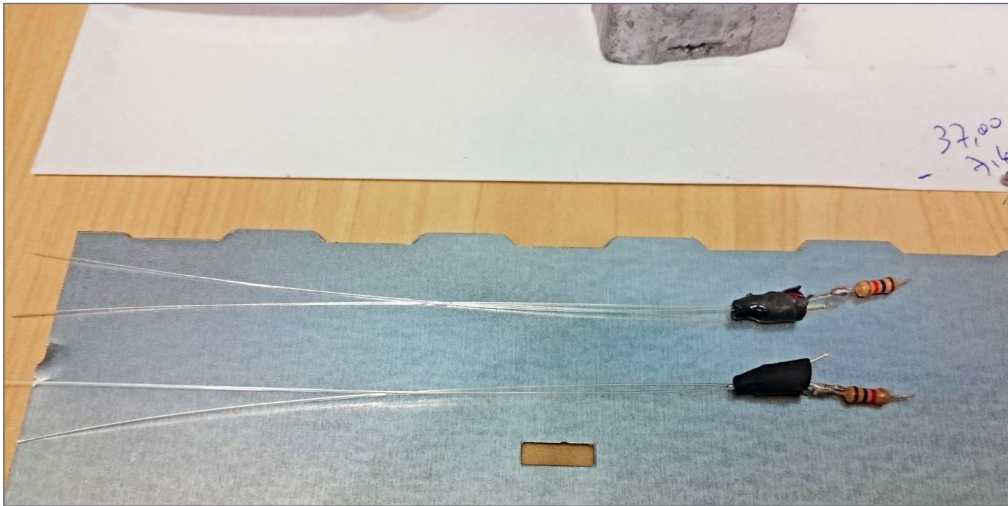

9. The next step is to block the red light that will propagate from the source LED and make the driver's cabin light up red. Use black heat-shrink tubing from electronics suppliers. Choose a size to match the LED and carefully warm it with the soldering iron. It will shrink and wrap around the LED to block the passage of light.



10. To install the optical fiber, we must make a hole in the cab metal weights. Mark the center of the hole location with a very fine pointer. My optical fiber is four-tenths of a millimeter. That converts to .016 inches, requiring a #78 drill. To keep from breaking these tiny bits, hold the part steady in a vise or clamp. Drill slowly and with very light pressure. Let the bit do the cutting. Clean any stray bits of plastic or metal so the optic fiber can slide smoothly into the hole. It may help to chamfer the hole in the inside with a sharp knife tip or a larger drill.



[Click here for  
reader comments](#)

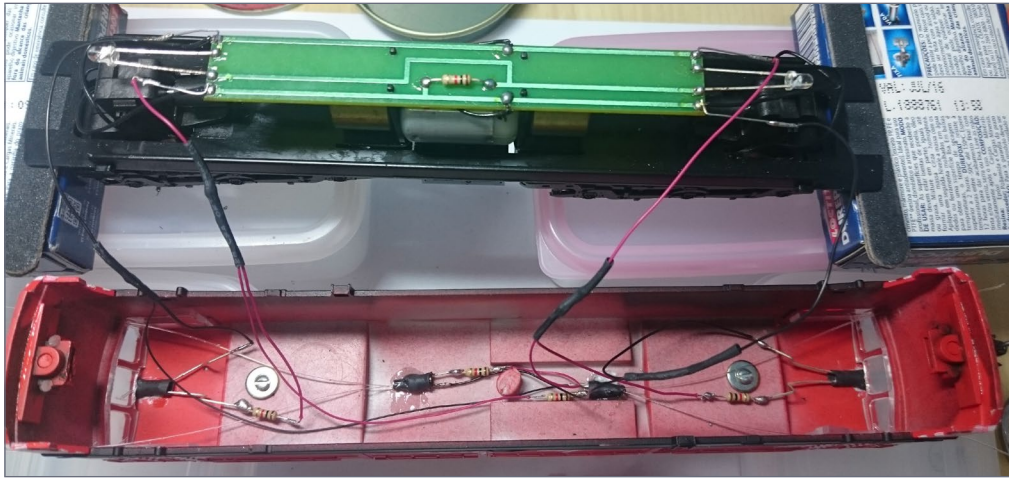

11-12. Finally, glue the optic fiber into the housing with hot glue or clear parts cement.

ADVERTISEMENT

# END OF TRAIN DEVICE

**NEW ORANGE CASE!**

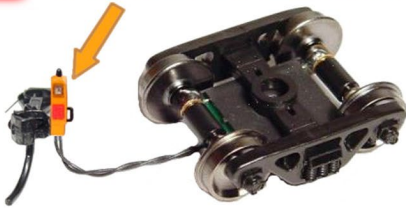

Patented Technology - US Patent 7,549,609

**Bright Red  
Flashing Light!**

Installs in minutes!  
No freight car  
modification required!

**RE RING**  
ENGINEERING

[Click Here to  
Learn More](#)

**Does not affect Load!**

↓ Car without Load ↓



↓ Car with Load ↓



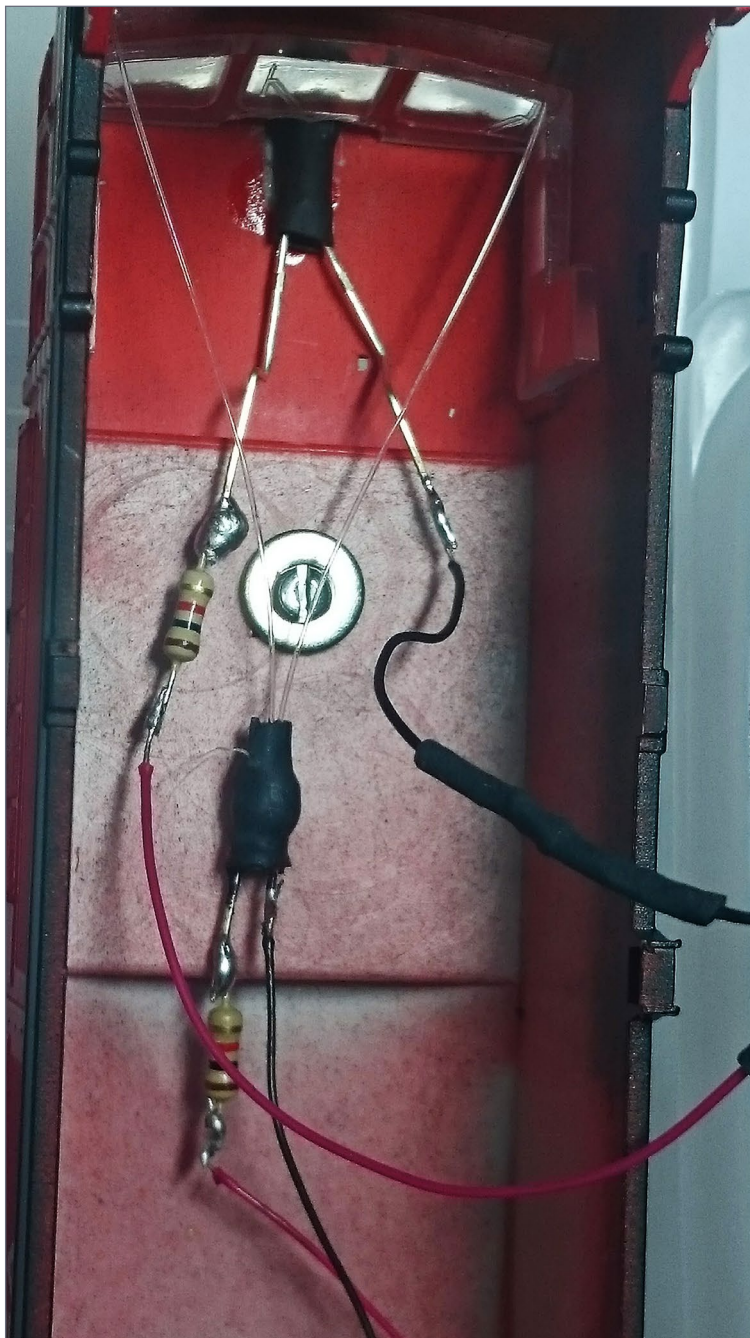

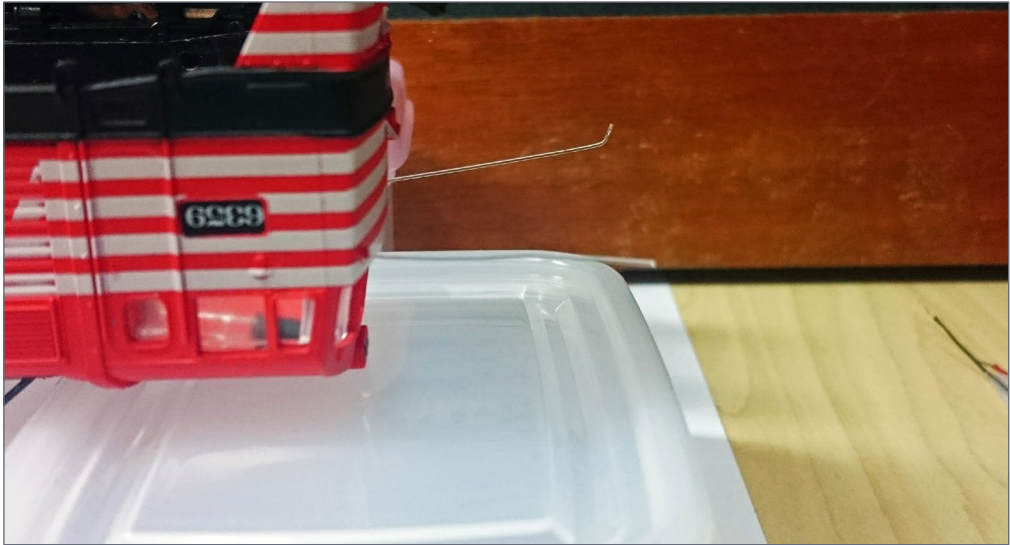
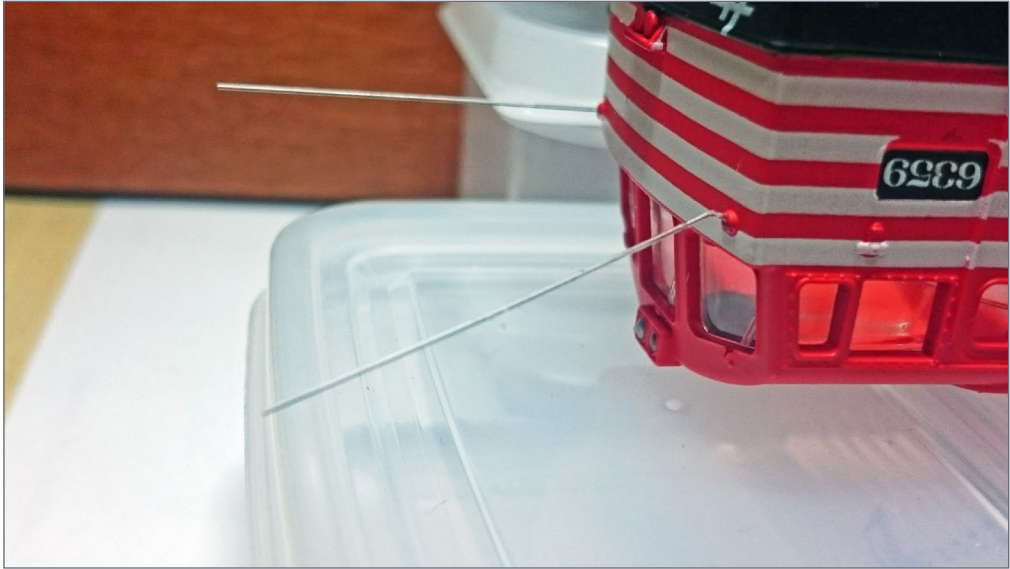

13-16. Remember that these micro lamps are intended to light up at the rear of the locomotive when it is moving forward. Test the lights for proper operation in both directions. After you verify that everything works, use a nail clipper or flush-



## ULTRA-TINY LIGHTS | 12

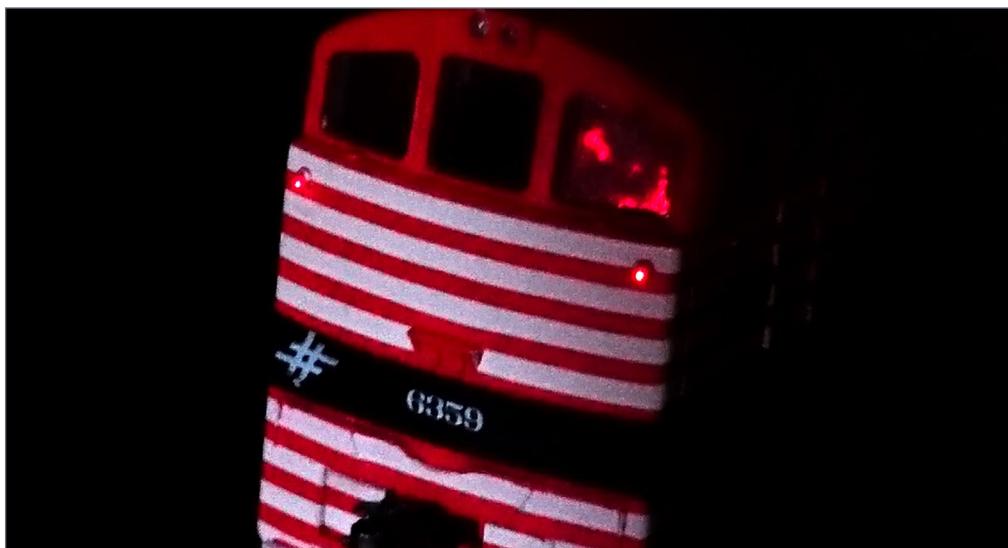

cutting pliers to trim the optical fiber flush with the outer face of the housing. Then, replace the body on the chassis and it is ready to run! The smallest lamp of the world, in its locomotive in HO scale!

## WAGNER CIONGOLI



Wagner has liked model trains since he was a child, but it's only been since he became an adult that he's really been very active in the hobby.

He got serious about his model railroad-ing passion in 1994, working in HO. His passion is to model things as faithfully as possible, both the models themselves and the scenery. Wagner also likes to explore new methods and techniques so

he can share them with his fellow modelers.

He models Brazilian prototypes from his native country, Brazil. His latest interest has been improving the lighting of his models, as this article demonstrates.

Wagner is a doctor specializing in cardiovascular surgery. “My woman” (as Wagner calls her in English) participates actively with him in both his professional and hobby activities. Wagner says doing the hobby is a daily activity in his household!



[Click here for reader comments](#)

ADVERTISEMENT

# BUS!



# HO SCALE CLICK HERE

• INDEX

• TABLE OF CONTENTS

# *A holiday feast for you ...*

One year membership ...

60+ *new* all-original videos coming in 2017 ...

***But THAT'S not ALL!***

ALSO get unlimited access to ~200 videos from three prior seasons of TMTV ...

AND unlimited access to dozens of MRH Store videos in high definition too.

***Talk about a feast!***

**\$55 - 1 yr** (~17 cents a video)

~~MONTHLY \$83.88~~ MRH Subscriber? Save another 10% using the [coupon code here](#). WOW!

Get this deal now 



## TrainMasters TV Winter Promotion

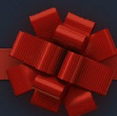



# LOOK

column



[Click here for reader comments](#)

JEFF SHULTZ, MRH STAFF



1. National Steel Car model decorated for Portland and Western log car service.

## FIRECAT DESIGNS MODERN LOG CARS

**FIRECAT DESIGNS IS A NEW RESIN AND 3D** printed model company located in the Portland, OR area. It was started when its founder, Dunstan Fandel, needed some modern skeleton log cars, and could not find any manufactured in HO scale.

▶ **NEW PRODUCT FIRST LOOK**

## FIRST LOOK | 2

He designed the cars with CAD software and had them printed by Shapeways – which resulted in each car costing around \$80, far too expensive for a fleet of them. So he used his 3D printed models as masters and learned how to cast models in resin using silicon molds. The results were good enough that his friends encouraged him to turn them into kits for others to build as well.

Currently, Firecat Designs offers three different 100-ton log car kits. Each consists of cast resin parts, brass bar stock, and high resolution 3D printed detail parts. Decals are included, but trucks and couplers are not. Kadee #513 100-Ton Roller Bearing Trucks are recommended, and add some needed weight to the model. My models weigh between 1.7 oz and 1.9 oz, depending on the model and the trucks. At 9.625 inches, NMRA RP 20.1 states that the car should weigh about 5.5 oz. Adding the load of logs in the photograph brings it up to 3.8 oz. Firecat Designs recommends the Kadee #148 whisker coupler, which will need to be assembled in its own draft gear box and then glued or otherwise secured to the model.

The log cars modeled are the 1960s to current-era NSC (National Steel Car) log car with four log bunks, which includes decals for current users Portland & Western (WPRR, ex British Columbia Ry. BCOL) and Albany and Eastern RR (AERC).

Firecat also offers the Portec (JLTX) and Evans Products Co. (FURX) log cars with six log bunks. Both of the six-bunk car types



2. Evans Products Co. model decorated for FURX.

## FIRST LOOK | 3

started in pulpwood service in the 1980s, and are now used to carry timber, pulpwood and utility poles throughout the US.

The most recent Firecat Designs kit converts a Walthers TOFC flatcar into a LTTX 89-foot utility pole car. It includes a 3D printed body from Shapeways and laser-cut parts. The customer provides the donor flatcar chassis and Evergreen styrene H beams for the log bunks. This car was detailed in several blog posts on the MRH website. They can be found here:

[mrhmag.com/node/26079](http://mrhmag.com/node/26079)

[mrhmag.com/node/26169](http://mrhmag.com/node/26169)

Upcoming models will include log cars built by Greenville Steel Car (Hammermill Paper) and Ortner Railcar (AERC, Georgia Pacific & Norfolk Southern).

### ADVERTISEMENT



# Don't get caught speeding

**ROLLING ROADS**

**SPEEDOMETER** For Speed in Real Time!



Analogue  
or digital

# we have a speedometer for that



**CLICK HERE**

**Bachrus** inc  
RUNNING ON QUALITY

[www.bachrus.com](http://www.bachrus.com)  
Hannon, ON Canada

• INDEX

• TABLE OF CONTENTS

# FIRST LOOK | 4

Prototype photos of all the cars can be found on the Firecat Designs website at [firecatdesigns.com](http://firecatdesigns.com). Kits can be purchased from the website directly and can be found at Portland, OR area train stores. ✓



**Click here for  
reader comments**

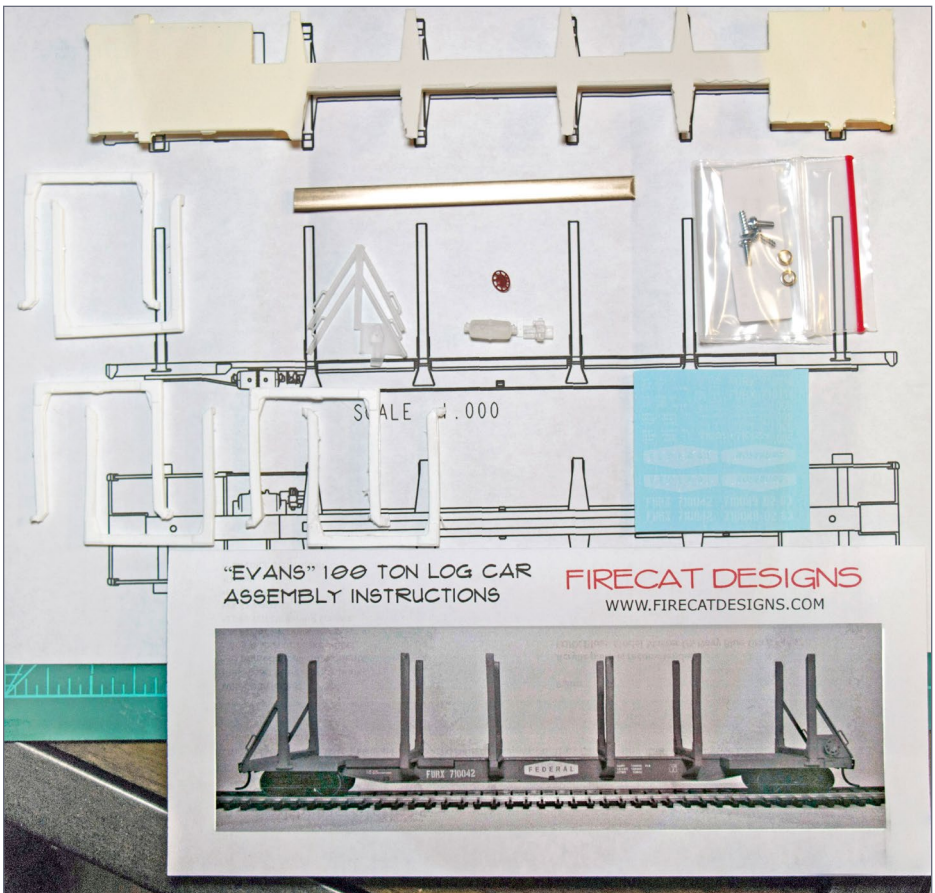

## 3. Unassembled Evans Products Co. kit.



# Norfolk and Western Historical Society

**Brand New  
Video!**

**Feature  
length DVD  
or Blu-Ray.  
The official  
story of  
611's 2015  
restoration**

**to operating condition.**

**How can I add this great disc  
to my collection?**



**Click Here!**



# The Amherst Railway Society Railroad Hobby Show

Our 2017 Show will be

## January 28 & 29, 2017

Save the dates!

**Click  
to learn  
more ...**



## About The Show

Every year late in January or early in February, the Amherst Railway Society holds its Railroad Hobby Show at the Eastern States Exposition Fairgrounds (The home of The Big E) in West Springfield, Massachusetts. More than 25,000 railfans and public attended the Show each of the past three years.

The event features real life railroads and scale model railroads, historical societies, travel agencies, art shows, flea market dealers, importers, manufacturers and photographers. You have to see it to believe it!

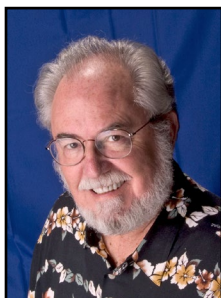

# DECEMBER NEWS

column

RICHARD BALE *and* JEFF SHULTZ



[Click here for  
reader comments](#)

## Horst Preiser (1934-2016)



Horst Preiser, leader of one of the world's best known manufacturers of model figures, has passed away at the age of 82. Since 1970, Horst has headed the Paul M. Preiser GmbH founded by his father in Germany in 1949. Horst was known as a hands-on modeler who personally sketched new figures and worked with sculptors and production people to produce the firm's vast selection of model figures. Preiser's sons, Volker and Jürgen, have been involved in the business since 1990 and will continue to run the family company that produces figures, vehicles, and architectural models in 13 different scales ...

▶ THE LATEST MODEL RAILROAD PRODUCTS, NEWS & EVENTS

## **Jerry Williams (1937-2016)**

Jerry M. Williams, founder of Williams Reproductions, passed away in November. He was 79 years old, Williams was inducted into the Hobby Manufacturers Association Hall of Fame earlier this year. In 1969 Williams co-founded Classic Models Corporation with Fred Mill. The product line focused on standard gauge trains. Williams later established Williams Reproductions Limited to make tinplate copies of popular Lionel and Ives toy trains. Williams entered the O gauge field in the 1970s with replicas of Lionel passenger cars, Fairbanks-Morse's Train Master, and the iconic GG1 electric. Bachmann Industries purchased Williams Reproductions Limited in 2007. The product line is now marketed under the brand name of Williams by Bachmann ...

## **San Juan Car Returning to California**

John Engstrom, general manager of San Juan Car Company, has announced that the firm will be relocated from Durango, CO, to the Southern California community of Garden Grove. The building currently leased by SJCC has been sold and Engstrom will use the opportunity to relocate to the west coast where his family resides. The move is scheduled for completion this month. SJCC is expected to be open for business the first week of January, 2017. San Juan Car Company was founded in 1978 by the late John Parker in Union City, CA. SJCC developed a reputation for producing high-quality narrow gauge kits and ready-to-roll On3 and On30 models. Parker moved the business to Durango in 1998. During his battle against cancer, Parker made arrangements for the business to continue after his passing. Engstrom, who had previously been a senior executive with Athearn, was named general manager of SJCC in 2011.



## NEW CLUB CARS



The **Buckeye Division of the NMRA's Mid-Central Region** is selling a kit for an HO scale

41-foot gondola decorated for Buckeye Steel Castings Company. The custom model was produced by Accurail and is available in two road numbers. For additional information visit [div6-mcr-nmra.org/StoreFold/StoreCarFold/BuckeyeCastCar.html](http://div6-mcr-nmra.org/StoreFold/StoreCarFold/BuckeyeCastCar.html).

.....



The **New Haven Railroad Historical & Technical Society** is accepting reservations for a special production run of Osgood-Bradley postwar American Flyer parlor cars. The cars will be decorated in the McGinnis scheme with skirts. The program includes four-parlor-lounge cars and nine named parlor cars. The HO scale cars are being produced by Rapido Trains using original prints and data from NHRH&TS archives. For more information visit [nhrhta.org/pdf/Parlor Parlor-Lounges Order Form.pdf](http://nhrhta.org/pdf/Parlor%20Parlor-Lounges%20Order%20Form.pdf).

.....

## NEW PRODUCTS FOR ALL SCALES

Among the newest soft cover publications from **Morning Sun Books** is *GG1, The World's Greatest Electric Locomotive, Volume 1*, by Robert Yanosey. Additional recent soft-cover releases include *Southern California Rails 1941-1971*, by Dick Donat;

## DECEMBER NEWS | 4

*Erie Railroad Official Photography Volume 1: A to C*, edited by Daniel Biernacki; and *Canadian Pacific Through the Rockies*, by Robert Yanosey. New hard-cover books include *Southern Pacific Power, Volume 1, Switchers, Slugs and Passenger Hood Units*, by Ed Mackinson; *Erie Western in Color*, by John T. Eagan, Jr.; and *Western Canada in Color*, by Dean Freimund. Morning Sun Books has released a digital reprint of *Duluth, Missabe & Iron Range Railway in Color*. For more information on items available from Morning Sun Books visit [morningsunbooks.com](http://morningsunbooks.com).

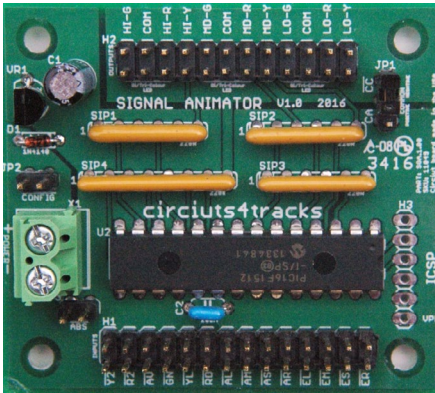

**Circuits4Tracks** has released a new product called the Signal Animator. It works in conjunction with their Quad Occupancy Detector. The product drives LEDs wired either common anode or cathode and implements speed restriction indications from switch machine inputs. It can be driven by an

external signaling system or operated using its internal ABS-mode that implements logic directly from any occupancy detectors for a basic signaling system. For additional information visit [circuit-s4tracks.daxack.ca/Products.php](http://circuit-s4tracks.daxack.ca/Products.php).

**Arduino Model Railroad Animation** is a new book for model railroad hobbyists interested in animating various systems on their layouts. Authors Paul and David Bradt focus on using the Arduino micro-controller to power and control many different items such as a jib crane, water tank spout, track scale, semaphore

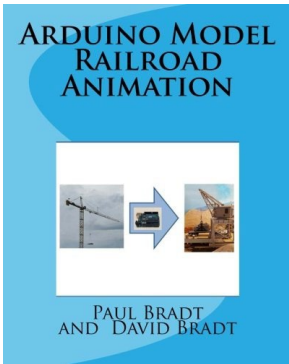

signal, and a gantry crane. Alternate control schemes such as a motor shield and a servo trigger are highlighted in the book. Published by CreateSpace Independent Publishing, the 135 page 8 x 10-inch soft-cover book is available at amazon.com. A Kindle digital edition is also available.

## O SCALE PRODUCT NEWS



**Atlas O** plans to release a 40-foot wagon top boxcar during the second quarter of 2017. The new O scale Master series model will be produced

from tooling Atlas acquired late last year from Weaver Models. Road names on the ready-to-run model will be Baltimore & Ohio, B&O Express, and Pennsylvania Railroad.



Also planned for release sometime during the second quarter of next year is a group of 60-foot

passenger cars. The O scale models will be based on C&NW prototypes. Car types in the Trainman series will be a baggage car, an RPO car, a coach, a combination coach-baggage car, and an observation car with an open platform. Road names will be Baltimore & Ohio (blue, gray, black), Grand Trunk Western, Lackawanna, Monon, and Seaboard. The observation car will also be available for Milwaukee Road and New York Central.

## DECEMBER NEWS | 6



Atlas O is selling 4-wheel passenger trucks with optional couplers, for either 2-rail or 3-rail operation. These are the

same well-detailed trucks used on the Atlas O California Zephyr models. All Atlas O rolling stock is available for 2-rail or 3-rail operation. For additional information on all Atlas O products contact a dealer or go to [atlaso.com](http://atlaso.com).

.....



**Pre-Size Model Specialties** has introduced a Blasted Rock Tunnel Portal, suitable for use with O scale narrow gauge or S scale. The tunnel portal is made of tough cast resin. More information on all Pre-Size Model Specialties products can be

found at [pre-size.com](http://pre-size.com).

.....



**San Juan Car Company** is selling ready-to-run models of iconic Colorado narrow gauge drop-

bottom gondolas. The On3/On30 scale models are available in eight new road numbers as well as in four decorating schemes without numbers. The authentically detailed models come with SJCC Evolution couplers and 3-foot 7-inch arch bar trucks fitted with On3 wheelsets. On30 wheelsets are also included. For more information go to [sanjuancarco.com/search.php?search\\_query=1061&Search](http://sanjuancarco.com/search.php?search_query=1061&Search).

.....



## HO SCALE PRODUCT NEWS



**Accurail** has announced new HO scale kits for several new freight car models including this

50-foot Santa Fe boxcar with riveted steel sides and double Youngstown doors.

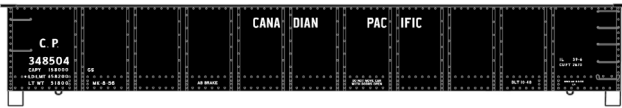

Also available now is a kit for this 41-foot AAR

11-panel steel gondola decorated for Canadian Pacific. The kit is available individually or in a 3-pack with different road numbers.

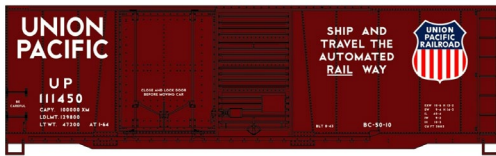

Accurail has released an HO scale kit for this 40-foot Union Pacific steel boxcar with a combination of a Youngstown plug door and

Youngstown corrugated steel sliding door. The model represents a prototype car rebuilt in 1964. Additional new kits include a 40-foot AAR steel boxcar with a Youngstown sliding door as built for Chicago & North Western in 1945, and Virginian USRA class H-15 twin-bay hopper cars in a 3-pack with different numbers and slight variations in the position of the lettering. All Accurail HO scale kits come with Accumate couplers and appropriate trucks. For more information contact a dealer or visit [accurail.com](http://accurail.com).

**Athearn** has released their production schedule for September 2017. Heading the list is a Genesis series ES44DC locomotive. The prototype is one part of General Electric's eco-friendly 12-cylinder GEVO locomotives. Athearn's HO scale version will

# DECEMBER NEWS | 8

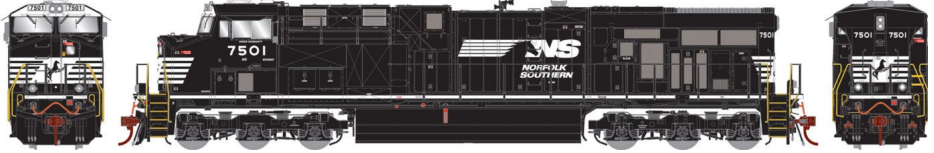

be available decorated for Norfolk Southern, Norfolk Southern (primer grey), CSX, CSX (primer grey), BNSF, BNSF (Heritage scheme), and BNSF (Heritage III wedge scheme).



A Genesis series SDP45 is also set for release next September. The prototype SDP45 is five feet longer than the SD45 to accommodate a steam generator to provide heat for the passenger equipment. Some roads simply used the extra space for increased fuel capacity. Athearn's HO scale SDP45 will be available decorated for Wisconsin Central, Conrail (ex-Erie Lackawanna), Conrail (Bicentennial scheme), Morrison Knudsen, National Railway Leasing, Burlington Northern (ex-Great Northern green scheme), and in Southern Pacific's Kodachrome scheme.



Ready-to-Roll equipment coming from Athearn next September includes an SD39 diesel locomotive. EMD built about 60 of the 2,000 hp prototypes between 1968 and late

1972. Athearn will offer their HO scale version decorated for Minneapolis, Northfield & Southern (ex-Soo); Santa Fe (yellow

## DECEMBER NEWS | 9

& blue), Guilford (B&M), Progressive Rail, Rio Grande, and Southern Pacific. All Athearn locomotives listed here are available for DC or DCC operation. DCC models have a factory installed DCC decoder with SoundTraxx Tsunami2 sound. DC models are DCC-ready using Quick Plug technology that includes both 8- and 9-pin connector to ease installation of an aftermarket decoder.



Additional HO models due from Athearn next fall include a 50-foot P-S 5277 cu. ft. boxcar. It models a prototype with outside posts and non-terminating corrugated box ends. Road names will be Railbox, Burlington Northern, Canadian National, Canadian Pacific, Southern Railway, and Norfolk Southern.



A 40-foot triple-bay hopper with offset sides is also scheduled for release next September. The hopper cars come with a coal load and feature factory applied wire grab irons, ladders, and stirrup steps. Road names will be Chesapeake & Ohio, Boston & Maine, Chessie System (B&O), Canadian National, Illinois Central, and Rock Island. The models will be available singly and in two 4-packs for a total of nine road numbers.

Athearn is currently preparing new tooling for a UPS 40-foot drop-sill parcel trailer. The introductory release is planned for

# DECEMBER NEWS | 10



next September and will include five unique United Parcel Service schemes.

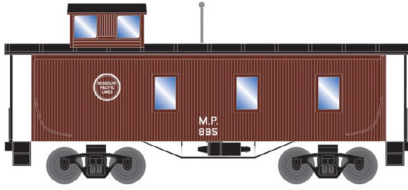

**Athearn Roundhouse** branded models due in September include this 30-foot three-window wood caboose. It will be available for Duluth, Winnipeg & Pacific (Bicentennial scheme); Spokane, Portland & Seattle; Burlington Northern, Canadian Pacific, Northern Pacific, Soo Line, and Missouri Pacific. The cars will all have Bettendorf trucks except the Soo Line version, which will come with arch bar trucks.

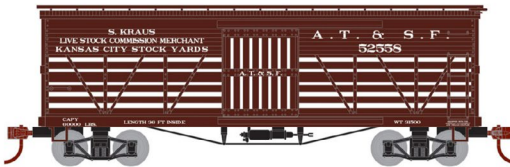

Also planned for release next fall is a 36-foot stock car. The wood car will have truss rods and arch bar trucks. In addition to the interesting Santa Fe scheme shown here, road names will be Kansas City, Mexico & Orient; Great Northern, Northern Pacific, Soo Line, and Pennsylvania Railroad. For additional information on all Athearn and Athearn-Roundhouse products contact a dealer or visit [athearn.com](http://athearn.com).

# DECEMBER NEWS | 11

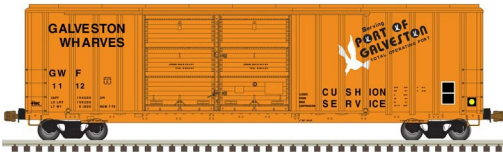

**Atlas** has scheduled a 2017 second quarter release for a new HO scale FMC 5347 cu. ft. Plate C boxcar. The Master series model will have double Youngstown doors, individual wire grab irons, and etched metal detail parts. Four road numbers each will be available for Oregon, Pacific & Eastern; Texas, Oklahoma & Eastern; East St. Louis Junction, Port of Tillamook Bay, Sabine River & Northern, and Port of Galveston.



Also due in the second quarter of next year is an Atlas Master series C-424/425 diesel in new

paint and new numbers. Features include separate ladders, drop steps, and wire grab irons; individual marker lenses, and two painted engine crew members. New road names and paint schemes for the C424 locomotive include Western New York & Pennsylvania, and West Chester Railroad. Previously released road names scheduled to be issued with new numbers include Delaware & Hudson, Reading, and Belt Railway of Chicago. The C425 Phase 2 models will have redesigned AAR style truck side frames and cabs with either horizontal or vertical headlights per the prototype being modeled. Road names will be Chicago & North Western, Delaware-Lackawanna, and Spokane, Portland & Seattle. Both DC and DCC versions of the HO scale locomotive will be available.



Atlas plans to release its Trainman series PS-2 twin-bay covered hopper with new road names and numbers during the first quarter of next year. The

# DECEMBER NEWS | 12

.....

HO scale ready-to-run model will be available decorated for Chicago & North Western, Lancaster & Chester, Maine Central, U.S. Borax & Chemical-NADX, Western Pacific, Southern Railway, and Pennsylvania Railroad.



Atlas's 85-foot HO scale plate girder bridge will be released early in 2017 in ten paint schemes. Bridges decorated with Missouri Pacific (Route of the Eagles), CSX Transportation, Lehigh & New England, Frisco (Shortest Line to Memphis-Birmingham-Pensacola), Penn Central, Providence & Worcester, Susquehanna, Canadian National (Courtesy & Service), Southern Pacific, and Union Pacific will all be available. The ready to use bridge comes with code 100 rail. For additional information on all Atlas products contact a dealer or visit [atlas.com](http://atlas.com).

.....



**Bowser Trains** is developing 15 variations of an HO scale Alco RS-3 Phase 3 diesel. In addition to such features as air hoses, windshield wipers, individual

grab irons, uncoupling bars, and operating headlights, the models will offer numerous road specific details as noted below.

Road names will be Erie Lackawanna (with MU receptacles, steam generator stack), Boston & Maine (with train lighting box, flags, and cab signal control box), Central Vermont (with front



and rear number boards, marker lights, horn on cab, winterization hatch, MU receptacles), Delaware & Hudson (with MU receptacles, generator stack), and Grand Trunk (with

front and rear number boards, marker lights, horn on cab, winterization hatch, MU receptacles). Also, Green Bay & Western (red & grey scheme with marker lights, horn on cab, MU receptacles), Louisville & Nashville (black & tan, correct head and rear light, number boards, Gyalight, MU receptacles), and Milwaukee Road (handrails on hood curve, side number boards, passenger fuel tank, all weather cab, MU receptacles).

Additional road names include Pennsylvania (train phone, long hood, fireman's side ladder, train control box, short handrails on engineer side, dynamic brake), Nickel Plate (marker lights, number boards, fireman's side ladder, high mount head and rear light), Northern Pacific (canoe scheme, dynamic brake, all weather cab, bell rope pull), Norfolk & Western ( seven-foot cab, cab mount horn, body side number boards, dynamic brakes), Spokane, Portland & Seattle (radiator intake screen, operating beacon, all weather cab), BN (merger scheme, SP&S features), and Western Maryland (number boards, dynamic brake). One version of the WM model will be sold exclusively by the Western Maryland Historical Society to raise money to repair their museum station building.

Both DC analog and sound/DCC equipped versions of the Bowser model will be available. Reservations are due by May 1

# DECEMBER NEWS | 14

with delivery expected in late 2017. For more information on all Bowser products contact a dealer or visit [bowser-trains.com](http://bowser-trains.com).

**Broadway Limited** has announced that orders are being taken for the HO scale 1950 Wabash Bluebird streamlined passenger train. Featuring Budd dome cars, the regional streamliner traveled between Chicago and St. Louis and remained in service on the Norfolk & Western until Amtrak took over rail passenger service in 1971. Six cars are currently available for pre-order, #650 Baggage car, #200 Dome Coach, #201 Dome Coach, #202 Dome Coach, #51 Dining car, and #1601 Dome Observation. For more information visit [broadway-limited.com/wasbashbluebirdtrain.aspx](http://broadway-limited.com/wasbashbluebirdtrain.aspx).

1301 Bookstore Fits most buildings 3" - 3 1/2" wide

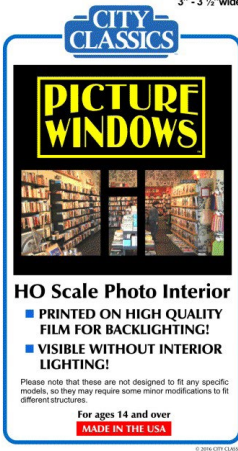

**CITY CLASSICS**

**PICTURE WINDOWS**

**HO Scale Photo Interior**

- PRINTED ON HIGH QUALITY FILM FOR BACKLIGHTING!
- VISIBLE WITHOUT INTERIOR LIGHTING!

Please note that these are not designed to fit any specific models, so they may require some minor modifications to fit different structures.

For ages 14 and over  
**MADE IN THE USA**

© 2014 CITY CLASSICS



**City Classics** has introduced a line of picture window film that cleverly portrays a realistic interior for HO scale structures. Scenes include a bookstore (left), restaurant (right), pharmacy, hardware store, bakery, record store, barber shop, and café. Each scene is printed on white film so the images look brilliant in ordinary light and surprisingly realistic when backlit. Each kit comes with the



# DECEMBER NEWS | 15

.....

filmed scene, cardstock strips for forming a shadow box behind the photo interior to contain light, and instructions. Twelve different scenes are available for buildings 3 to 3 1/2-inches wide, and six scenes for buildings four inches wide. For additional information contact a dealer or visit [cityclassics.biz](http://cityclassics.biz).

.....



ARMN phase 1 car, above, is available in 12 new road numbers.



Also new is a UP-ARMN patch scheme. About two years ago Union Pacific began relocating the reporting marks and car numbers higher on car sides - presumably in an effort to keep them from being hidden by graffiti. ExactRail's HO version will be available in 12 numbers. The Platinum series ready-to-run models feature photo-etched stainless steel brake platforms, Kadee #156 couplers, and 100-ton ASF Ride Control trucks with machined metal wheelsets. For additional information on all ExactRail products visit [exactrail.com](http://exactrail.com).

.....



**Fine Scale Miniatures** has set a late February release date for a line-side coal yard called I. M. Dunn Co. The new HO scale craftsman kit includes all of the details shown here except the

## DECEMBER NEWS | 16

.....

figures, truck, and trackwork. The assembled complex occupies 11 x 13-inches. In announcing his latest kit, George Sellios said that production will be limited to just 600 kits. For additional information visit [finescaleminiatures.com](http://finescaleminiatures.com).

.....



**Fos Scale Models** is selling a new waterfront structure named Department of Docks, Part 2. The HO scale craftsman kit is a sequel to a kit of the same name released in 2006. The structure, including the distinctive clock tower, is laser-cut

clapboard. Pre-cut standing seam roofing sections on the tower simplify assembly. Additional components include laser-cut and plastic doors and windows, metal detail parts, signage, and a 28-foot utility barge. The pier includes a laser-cut base with pre-cut holes for pilings. For those without a waterfront, the pier can be eliminated and the structure built as freight house or aging factory. The assembled model has a footprint of 3 x 12 inches. The figures, vehicles, and seawall are not included.



Also new from Fos is a Shakey's Pool Hall & Bar. The kit includes laser-cut walls, plastic windows and doors, metal detail parts, and color signage. The HO scale model has a footprint of approximately 5 x 7 inches. Vehicles, figures and scenery not included.

## DECEMBER NEWS | 17

.....

Fos Scale has also announced the availability of new “Go Scratch” HO scale large wall sections, and corresponding windows will be available. For additional information on all Fos kits visit [fosscalemodels.com](http://fosscalemodels.com).

.....



Shown here is one of five Illinois Central paint schemes that will be available on InterMountain

Railway's soon-to-be released GP10 diesel locomotives. The HO scale ready-to-run model is based on the numerous worn out EMD GP7 and GP9 locomotives Illinois Central rebuilt in their Paducah shops during the 1970s. Other road names will be Chicago, Central & Pacific; Midsouth, Conrail, Iowa Interstate, ADMX, Arkansas-Oklahoma, Precision, Twin Cities & Western, Farmrail, Paducah & Louisville, and U.S. Army.



InterMountain showed preliminary samples of the GP10 at Trainfest in Milwaukee. Company representatives said the Paducah-built

GP10 will offer numerous road specific details such as Horst air filters, horizontal nose headlight, extended front tool boxes, and engine access roof hatches. Both sound and non-sound versions of the HO scale ready-to-run model will be available.

InterMountain Railway is quoting a June/July release date for a group of EMD F3A and matching F3B diesels. The HO scale ready-to-run models feature wire grab irons and etched metal

## DECEMBER NEWS | 18



details. They will be factory equipped with an ESU sound decoder. An optional DC plug will be available on request. Road names will be Denver & Rio Grande Western (Bumblebee scheme, above), D&RGW (standard yellow, see N scale listing), New York, Ontario & Western; Chicago & North Western, Reading, Lehigh Valley, and Erie. F3A units only will be available for Grand Trunk Western and Atlanta & St. Andrews Bay.



Also due from InterMountain this summer is a rerun of cylindrical hoppers with round hatches. The HO scale models feature wire grab irons, etched metal roof walks and Kadee couplers. Road names will be Potash, Canadian National, Procor, Andersons, Inland Cement, CNLX, and four Canadian Pacific schemes. An undecorated kit will be available.

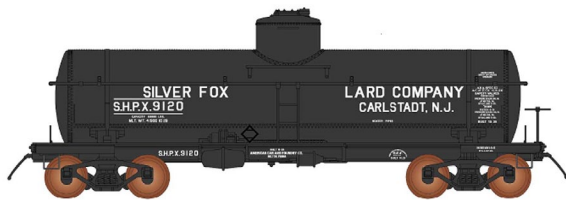

The final item on InterMountain's June/July release schedule is an ACF Type 27 8,000 gallon riveted tank car. The HO scale model will have metal wheelsets and Kadee couplers. It will be available decorated for Silver Fox Lard Co., Robeson Process, Woburn Degreasing, Hercules Powder, King Taste Products, Bell Oil & Gas, Gulf States Creosoting, Wolf's Head Oil, A.E. Staley Manufacturing Co., Everett Distilling, UTOCO, and Mobilgas in a bright red body. Also and Mobilgas in a bright red body. For

## DECEMBER NEWS | 19

additional information on all InterMountain Railway products contact a dealer or visit [intermountain-railway.com](http://intermountain-railway.com).

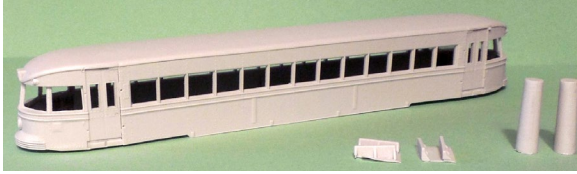

**Imperial Hobby Productions** is selling a resin body kit for a Brill Bullet. The HO scale model

is based on transit cars that operated on the Philadelphia & Western (Norristown High Speed Line) from 1931 until 1995. 3D printed parts for the underframe, and truck side frames are available from Shapeways. For additional information visit [ihphobby.tripod.com](http://ihphobby.tripod.com).



**Kadee** will release a new Central of Georgia box-car next month. The HO scale ready-to-run model is based on a 40-foot

PS-1 car with an 8-foot Youngstown sliding door. The prototype was built in 1952. The model will be painted in as-new red oxide. It will come with Kadee self-centering Bettendorf trucks and Kadee couplers. for additional information contact a dealer or visit [kadee.com](http://kadee.com).

**Monster Model Works** has released a kit for an HO scale brick industrial building. Called Gibson Body Co. the structure is reminiscent of automobile repair shops surrounded by cars in various states of repair. The kit's components include 3D engraved and aged American Bond brick walls, and columns. The garage doors and windows are laser-cut with peel and stick



backing. Additional details include terra cotta coping, a brick chimney, a large side wall sign and a stencil for the front sign. The assembled model has a footprint of 11.375 x 3.5 inches. For additional information on all Monster Model products visit [monstermodelworks.com](http://monstermodelworks.com).

.....

**NJ International** has introduced several specialized circuit boards that control LEDs in simulating a variety of lighting effects. They include Random Lighting Circuit #8200 that simulates random lights turning on and off in a house or commercial building, Antenna System #8201 that drives a dual function day and night strobe and red beacon, and Traffic Light Circuit #8202 that operates a typical red, yellow, and green traffic light sequence. Completing the group is Burning Fire Circuit #8203 that simulates a campfire or burning fire inside a building. Each circuit requires a 9 to 12 volt AC or DC 100ma maximum power source (not supplied). For additional details visit [njinternational.com](http://njinternational.com).

.....

**Nick and Nora Designs** is selling a new kit that makes into a small home called The Company House. The model represents structures built by various industries, including mining

## DECEMBER NEWS | 21

.....

companies and railroads, to provide Spartan yet affordable housing for their workers. The HO scale laser-cut kit features Tichy doors & windows, cast resin steps, and laser-cut porch railings. The assembled model has a footprint of 2.375 x 4 inches. For additional information visit [nickandnoradesigns.com](http://nickandnoradesigns.com).

.....



**Rapido Trains** is accepting reservations for HO scale models of Alco/MLW FA-2 freight and FPA-2 passenger locomotives. Reservations will close February 14, 2017 with delivery planned for mid-summer. Canadian decorating schemes will be Canadian National (as delivered), Canadian National (new herald), Canadian Pacific (block letters), and Canadian Pacific (script lettering). American road names will be Baltimore & Ohio, Great Northern, Lehigh Valley, New York Central, and Pennsylvania Railroad. An Erie version, shown below with road specific details installed prior to painting, will also be available.

Rapido has pledged to incorporate numerous road specific details into the model locomotives such as etched-metal chicken wire or Farr side grilles, dynamic brakes, variations in the battery box louvers, underbody piping and conduit, nose louvers (on B&O models), and Trainphone antenna (PRR models). According to Rapido, getting the water/fuel tank combination correct for all road names has required four different sets of tooling.



ERIE FA-2 SAMPLE WITH OPTIONAL DETAIL PARTS INSTALLED

Features that will appear on all versions of the model include operating number boards, headlights and two-color classification lights; separate grab irons and handrails; full cab interior, and

factory-installed Macdonald-Cartier couplers mounted at the correct height. Of the many prototype features replicated in the HO scale model, Rapido seems most proud of the locomotive's nose which is based on a 3D scan of a full size FA-2 preserved at Canada's national train museum. For additional information including making a reservation, contact a dealer or visit [rapido trains.com](http://rapido trains.com).

Rapido has also announced that it is working with the New Haven Railroad Historical and Technical Association to design an HO scale New Haven EP-5 "Jet" electric locomotive. Designs are expected to be finished in March with samples to follow in summer or early fall. While few details are available, Rapido is planning on having functioning pantographs with overhead power collection and the model will have "the full Rapido super detail treatment."

.....



**Resin Car Works** used the opportunity of the recent Chicagoland RPM meet (formerly known as the Naperville Meet) to



## DECEMBER NEWS | 23

.....

introduce two new HO scale resin freight car kits. Available now is a kit for a UTLX Class X-3 10,000-gallon tank car. The model is based on a series of prototype cars Union Tank Line built in 1923. Key components include a cast resin underframe, tank body, and detail parts; and PSC brass stanchions, air hoses and plumbing tee.



The second new HO scale kit represents the Missouri Pacific 50-foot 6-inch 50-ton all-steel automobile and class Bx express boxcars ACF built for MoPac in late 1941. Patterns for the one-piece

body used to produce this kit represent some of the final work done by resin-kit pioneer Martin Lofton. Additional patterns were crafted by Charlie Slater. Details in this kit include A-Line stirrups and a Plano Models etched running board. Both kits have Elgin Car Shops photo-etched stirrups and eyebolts; a Tichy AB brake set; assorted wire sizes and grabs; and appropriate decals. Trucks and couplers are not included. Readers should be advised that these are extremely limited run kits. For additional information visit [resincarworks.com](http://resincarworks.com).

.....



**Scale Trains** is developing an HO model of a Thrall triple-bay 5750 cu. ft. carbon black covered hopper with

closed ends. The ready-to-run Rivet Counter series model will be available decorated for Columbian Chemical S/CCX (above), Cabot/CABX, GACX, J.M. Huber/JHMX, Sid

# DECEMBER NEWS | 24

Richardson/SRCX, and WITCO/WITX. A tentative release date has been set for July 2017.



The July production run will include Thrall 4727 cu. ft. triple-bay carbon black covered hoppers with traditional

open ends. Road names will be Equa-Chlor/EQCX (above), Columbian Chemicals, Degussa/DCBX, Sid Richardson/SRCX. For additional information visit [scaletrains.com](http://scaletrains.com).



**Tangent Scale Models** has introduced an HO scale General American 8,000 gallon 1917-era radial-course tank car. The model

replicates a radial course prototype in which the steel panels that make up the tank overlap each other. The radial design is identified by the circumferential rivets that surrounded the tank body, with notably different heights between the courses. The radial-course tank cars utilized steel bolster plates that rise up vertically to hold the tank in place. This is the first plastic model of a radial course tank car offered in HO scale.



Decorating schemes on the initial release of the ready-to-run model are GATX Globe Soap 1920 scheme (above), UTLX original 1920 scheme,

UTLX 1958 repaint, AESX-STALEY 1952 scheme, and DRX Deep

## DECEMBER NEWS | 25

Rock 1940 scheme (below). Multiple road numbers are available for each road name. Undecorated kits are also available.



As with all Tangent models, these new radial-course tank cars are loaded with details including accurate dome appliances,

separately applied tank handrail and tank strap detail, wire grab irons and uncoupling bars, see-through cast knee above the bolsters, Kadee couplers, ASF cast steel spring-plank trucks with separate brake beams, and machined wheelsets. For additional information visit [tangentscalemodels.com](http://tangentscalemodels.com).

.....



**Walthers** plans to release a new run of HO scale SD70ACe diesels late this month. Road names for the

Proto series model will be BNSF, Montana Rail Link, Ontario Northland, Union Pacific (Armour yellow), Union Pacific (Western Pacific heritage scheme), and Union Pacific in the Missouri Pacific heritage scheme shown here. The ready-to-run locomotive will be available for standard DC operation and with factory installed SoundTraxx Sound and DCC.

Also due from Walthers in December is a new group of 45-foot CIMC ribbed containers. The HO scale models will be available decorated for Antillean Line, China Shipping, CMA, Evergreen, Hapag-Lloyd, Maersk, NYK Logistics, and P&O.

Photo Courtesy of the Arizona Railway Museum



The blunt-end observation car being tooled for Walthers 1956 Santa Fe Super Chief train set will be available separately. The HO scale model replicates an 85-foot 4-1 sleeper-lounge-observation car Pullman Standard built specifically for the

Super Chief. Delivery is expected in late January.

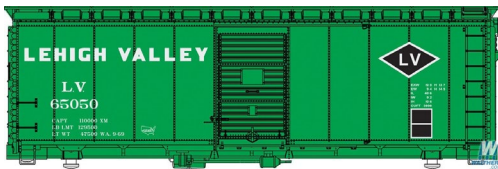

Walthers has two versions of a standard 40-foot steel boxcar set for release late next month. The cars share

10-panel riveted steel sides and six-foot Youngstown steel doors. The 1937 AAR car has 5/5 Dreadnaught ends and a Murphy panel roof with a wood running board. Road names will be Chicago & North Western, New Haven, Soo Line, and Lehigh Valley. The 1948 AAR boxcar has 4/4 Improved Dreadnaught ends, an Ajax hand brake wheel, an etched metal Apex running board, and a diagonal panel roof. Road names will be Erie, Chicago, Burlington & Quincy; Detroit, Toledo & Ironton; Grand Trunk Western, and Pennsylvania Railroad. Both cars ride on Bettendorf-style trucks.

In January, Walthers will release 40-foot hi-cube smooth side containers. They will be decorated for Yang Ming, Hapag-Lloyd, Horizon Lines, Burlington Northern, Canadian National, Con-Quest, EMP, Genstar, JB Hunt, Santa Fe, and Southern Pacific.

Walthers production scheduled includes a new run of Gunderson 48-foot well-cars for release in March.

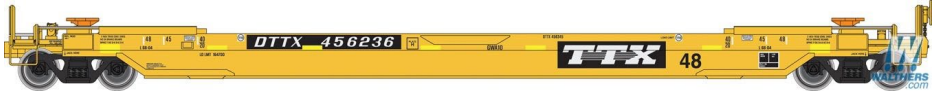

The HO scale intermodal car will have etched metal walkways, wire grabs, and wire brake gear piping. A trailer hitch is included for modelers to install if desired. Road names will be Burlington Northern, Burlington Northern Santa Fe, Coe Rail, and TTX-DTTX. For additional information on all Walthers products contact a dealer or visit [walthers.com](http://walthers.com).

## N SCALE PRODUCT NEWS



**Athearn's** production schedule for next September includes three new N scale items. They include a 30-foot three-window wood caboose with truss-rods. In addition to the Burlington Northern scheme shown here, road names will be Duluth, Winnipeg & Pacific (Bicentennial scheme); Canadian Pacific, Missouri Pacific, Northern Pacific, Soo Line, and Spokane, Portland & Seattle.

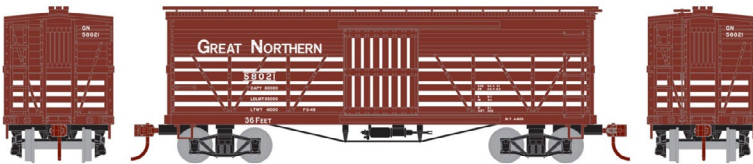

Also coming in September is an N scale 35-foot wood truss-rod stock car. Road names will be Santa Fe, Kansas City, Mexico & Orient;

# DECEMBER NEWS | 28

Northern Pacific, Pennsylvania Railroad, Soo Line, and Great Northern (HO version shown).



Completing the list of new Athearn models scheduled for release in September 2017 is a newly tooled 40-foot United Parcel Service drop-sill parcel trailer. The model will have painted wheels and rubber tires. It will be available in five different UPS schemes. For additional information on all Athearn products contact a dealer or visit [athearn.com](http://athearn.com).



**Atlas** will release a Master series N scale Alco RS-1 diesel with new paint schemes and road numbers during

the second quarter of 2017. Road names will be Akron, Canton & Youngstown; Spokane, Portland & Seattle; Minneapolis & St. Louis, and Susquehanna. Previously released roads with new road numbers include Chicago & Eastern Illinois, Long Island, Northern Pacific, and Rutland. The ready-to-run locomotive will be available for standard DC operation only.

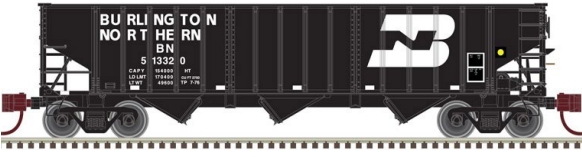

This PS-2750 triple-bay hopper car is scheduled for release during the second

quarter of next year. The Atlas Master series N scale ready-to-run

# DECEMBER NEWS | 29

model will come with optional heap shields. Four road numbers each will be available for Burlington Northern, Boston & Maine, and Rock Island. A Utah Railway car will be decorated with a PS-2960 paint scheme.



Also listed in Atlas's second quarter release is this Trainman series 50-foot 6-inch boxcar with a Youngstown cor-

rugated steel door. Road names on the N scale ready-to-run model will be Susquehanna, Burlington Northern, Canadian National, CSXT, Railbox, and St. Mary's Railroad. For additional information on all Atlas products visit [atlasrr.com](http://atlasrr.com).



**Eastern Seaboard Models** is selling N scale class XIH boxcars with plug doors decorated for BAR-State of Maine, New Haven, and CP Rail in four schemes including the colorful Mandarin Orange Express.

The models will have body-mounted couplers, separate grab irons, and etched-metal brake step and end platforms. The ready-to-run model will come with ASF A-3 Ride-Control trucks with Fox Valley metal wheelsets. For additional information about Eastern Seaboard Models contact a dealer or visit [esmc.com](http://esmc.com).

**InterMountain Railway** has announced a June/July date for the release of a group of EMD F3A and matching F3B diesels. In addition to Denver & Rio Grande Western, decorating schemes will be D&RGW (Bumblebee scheme, see HO listing), New York, Ontario &



Western; Chicago & North Western, Reading, Lehigh Valley, and Erie. F3A units only will be available

for Grand Trunk Western, and Atlanta & St. Andrews Bay. The N scale ready-to-run models feature wire grab irons and etched metal details. They will be factory equipped with an ESU sound decoder. Units for standard DC operation will be available by request.



Also due from InterMountain this summer is a rerun of cylindrical hoppers

with round roof hatches. The N scale ready-to-run model will have wire grab irons, etched metal roof walks, and InterMountain's well-regarded metal wheelsets. Road names will be Potash, Canadian National, Procor, Andersons, Inland Cement, CNLX, NS, Canadian Pacific in four different schemes.



The final item on InterMountain's June/July release schedule is an ACF 8,000 gallon Type 27 riveted tank car. The model will be avail-

able in four new decorating schemes. In addition to the Mobilgas scheme shown here, road names will be Silver Fox Lard Co., Robeson Process, Woburn Degreasing, Hercules Powder, King Taste Products, Bell Oil & Gas, Gulf States Creosoting, Wolf's Head Oil, A.E. Staley Manufacturing Co., Everett Distilling, and UTOCO. For more information on all InterMountain Railway products contact a dealer or visit [intermountain-railway.com](http://intermountain-railway.com).

.....



# DECEMBER NEWS | 31

.....

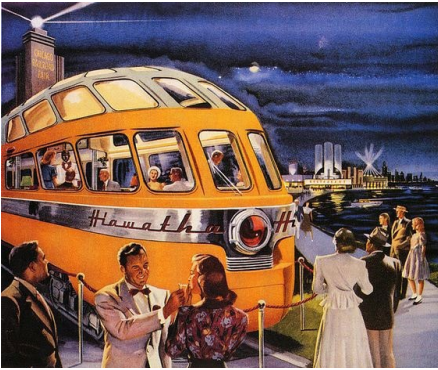

The next release in **Kato's** N scale series of Classic Named Trains will be the Milwaukee Road Olympian Hiawatha. Hiroshi Kato, president of KatoUSA, announced the future train set at Trainfest in Milwaukee. According to the Kato executive, the release is planned for

some time in 2017. Additional details on this project are pending. For information on other Kato products contact a dealer or visit [katousa.com](http://katousa.com).

.....



**Micro-Trains Line** has released three new US Army cars. In addition to the troop sleeper shown here,

a kitchen car and Army hospital car are also available. Like the WWII prototype, the M-T models ride on Allied Full cushion trucks. Other new releases from Micro-Trains are an 89-foot tri-level closed autorack decorated with Kansas City Southern's 125th Anniversary logo, and a 50-foot twin-bay Airslide covered hopper decorated for CSX.

.....



In the late 1950s SSW applied this experimental red and grey paint job to 25 of its 40-foot compartmentalized plug-door boxcars. The scheme was

reminiscent of diesels operated by SSW and parent company

Southern Pacific. Expanded use of the scheme was vetoed but the red and grey scheme remained on the original 25 cars for many years.

Completing this month's list of new Micro-Trains Line models is a 50-foot rib side boxcar with double Youngstown sliding doors. The model features box corrugated non-terminating ends, no running board, and modern roller bearing trucks. For additional information on all Micro-Trains Line products contact a dealer or visit [micro-trains.com](http://micro-trains.com).

.....

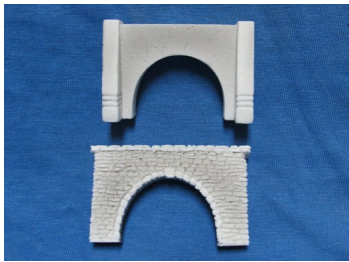

**Pre-Size Model Specialties** has introduced two new auto tunnel portals in N scale, one concrete, the other random stone. Each is cast in resin. Information on Pre-Size products can be found at [pre-size.com](http://pre-size.com).

.....



**Rapido Trains** has teamed with the **Prairie Shadows Model Railway Co.** to produce a set of FPA-4 and FPB-4 diesels. The models will be available exclusively from Prairie Shadows of Winnipeg,

Manitoba. The N scale diesels replicate prototypes built by the Montreal Locomotive Works. The authenticity of the unique A unit nose seems assured since Rapido previously produced an HO version using a 3D scan of prototype locomotive #6765 at Canada's national train museum. Before they were retired in 1989, the FPs

worked for some 40 years on North American mainlines. Many continue in service on tourist railroads across the US.

Features of the N scale locomotives include etched metal roof grille, metal wire handrails and grab irons, operational head and back-up lights, cab interior on the A unit, sunshades, MU hoses, and Micro-Trains couplers. DCC units will have decoders loaded with sound recorded from a real FPA-4. Analog DC units will have a 6-pin plug to simplify installation of an aftermarket DCC decoder. Delivery is planned for the summer of 2017. For reservation information visit [prairieshadows.com](http://prairieshadows.com).



Rapido is also announcing the re-launch of their N scale 73'6" Express-Baggage car, including new road names and paint schemes. The models feature Rapido's highly detailed underbody,

body-mounted Micro-Trains couplers, all air, steam, and electrical lines, road name-appropriate trucks, and factory painted and applied grab irons. Road names include Canadian Pacific (maroon), three versions of CN Noodle, Ontario Northland (chevron & green), Amtrak (Phase 3), Baltimore & Ohio, Burlington (silver shadow-lined), Canadian National (1954 scheme), Central of Georgia, Erie, Great Northern, Milwaukee Road (1950 scheme), Missouri Pacific (Jenks Blue), New York Central, Northern Pacific, Southern Pacific, Via Rail Canada, and Undecorated. Models are forecasted for a Summer 2017 delivery. For more information see Rapido's website at [rapidotrains.com](http://rapidotrains.com).

.....

**Showcase Miniatures** has released the first in a new series of N scale light-duty trucks. The initial selection includes kits for 1950s-era half-ton and 1-ton Chevrolet flatbed trucks. The kits are



composed of lead-free metal castings, vacuum-formed windshield, and laser-cut components for the stake body. Also new is a kit for a 1980s GMC dump truck (above right). This model can be assembled with a single or tandem axle. For additional information on all Showcase Miniature products visit [showcaseminiatures.net](http://showcaseminiatures.net).

.....

## NEW DECALS, SIGNS AND FINISHING PRODUCTS



**Microscale** has released N and HO scale decals for authentically decorating SP switchers and hood diesels in the short-lived SP-SF Kodachrome merger scheme. For additional information contact a dealer or visit [microscale.com](http://microscale.com).

.....

**Mask Island Decals** is selling HO scale decals for Southern TOFC flat car rebuilds, Rock Island 50-foot insulated boxcars, and Southern Railway cars for brick service. Each set has sufficient material to letter two cars. For more information including ordering details visit [maskislanddecals.com](http://maskislanddecals.com).

.....

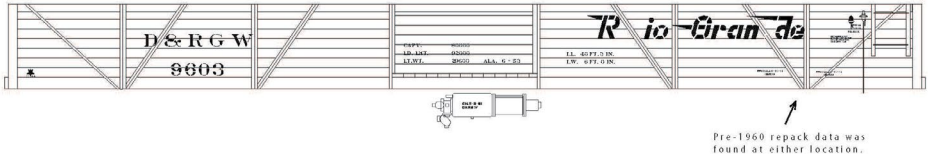

**San Juan Decals** has released a new lettering set for Denver & Rio Grande Western pipe gondolas. The decals are available for HOn3, Sn3, and On3. For additional information visit [sanjuandecals.com](http://sanjuandecals.com).

**Tichy Train Group** continues to expand its selection of decals for model railroad hobbyists. More than 30 new N, HO, S, and O scale decals sets for a variety of cars were announced last month. Road names include Chicago, Milwaukee & St. Paul Pacific; Atlantic Coast Line, Seaboard Air Line, Piedmont & Northern, Southern Pacific, and Union Pacific. A printed catalog is now available for Tichy HO scale products including decals. Catalogs covering other scales are under development. For more information visit [tichytraingroup.com](http://tichytraingroup.com).

## **i** SEND US YOUR PRODUCT ANNOUNCEMENTS

If you are a hobby manufacturer with a product announcement, just [click here](#) and submit your announcement to us. Our web site and free magazine reach continues to grow, so get on board this new media train! ■

### DISCLAIMER .....

The opinions expressed in this column are those of the writer and do not necessarily reflect the opinion of *Model Railroad Hobbyist* or its sponsors. Every effort is made to provide our readers with accurate and responsible news and information, however, neither *Model Railroad Hobbyist* or the writer of this column can be held responsible for any inaccuracies or typographical errors that may inadvertently appear in this column.



## BRIEFLY NOTED AT PRESS TIME ...

New HO scale items expected to be announced by **Athearn** this month include another release of its Genesis FEF 4-8-4 steam locomotive and a Roundhouse GE AC4400 diesel. We'll have complete details including road names and release dates next month ...

**Mike Brock**, host of next month's Prototype Rails meet in Coco Beach, Florida, has assembled an impressive list of knowledgeable clinicians for the event. Among the list of modelers sharing their skills are Jack Burgess, Jeff Cauthen, Paul Dolkos, George Eichelberger, Stuart Forsyth, Jared Harper, Steve Hile, Joe Oates, David Orr, Frank Peacock, Mont Switzer, Tony Thompson, Bill Welch, Fenton Wells, and Craig Zeni. Several manufacturer's representatives will also be on hand. Check our Selected Events section for more details.

The new owner of **Caboose Hobbies** plans to reopen the business later this month. The new store will be at 10800 West Alameda Avenue, Lakewood, Colorado. The location is approximately nine miles due west of the old Denver store ...

**Mask Island** has released new HO scale decals for Sanderesville Railroad open-top, multi-gate, wood chip hopper cars. Set #87-330 will decorate two of the 73-foot cars. More info at [maskislanddecals.com](http://maskislanddecals.com).

**Kato USA** has shipped its new N scale SDP40F to dealers. Road names are Santa Fe and the unique Maersk scheme. Check with your dealer for details and availability or visit [katousa.com](http://katousa.com).

**Westerfield Scale Models** has released a new resin kit for a Union Pacific 36-foot 6-inch pressed steel stock car. The HO

scale craftsman-style kit replicates class S-40-1 Harriman Standard stock cars built for UP and its subsidiaries Los Angeles & Salt Lake, and Oregon Short Line. Kits for both single and double deck cars are available in their original 1905 configuration as well as subsequent rebuilt and modernized versions. For information visit [westerfieldmodels.com](http://westerfieldmodels.com).  
.....

 [Click here for reader comments](#)

ADVERTISEMENT

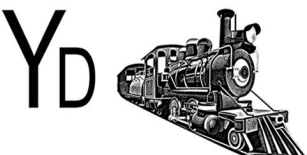

Yankee Dabbling – Track 33

**YD Specializes in DCC  
Sales-Service-Installation**  
**YD provides the BEST for LESS**

**FREE SHIPPING  
ON ORDERS OVER  
\$100.00**



**CLICK AND SAVE TODAY!**



YD installs DCC or RailPro in your engines  
Technical Coordination (727) 457-9227 9AM to 9PM EST  
Locations in NJ and FL / Visit our Web Site for Train Show Schedules



# SELECTED EVENTS

## December 2016

*(Please note that many events charge a fee. Check individual info website for details.)*

**CALIFORNIA, CROCKETT**, December 3-4, Open House at Carquinez Model Railroad Society, 645 Loring Avenue. Info at [cmrstrainclub.org](http://cmrstrainclub.org).

**CALIFORNIA, SAN DIEGO**, December 16, Ales n' Rails Ugly Christmas Sweater Party & Beer Tasting, fund raiser for San Diego Model Railroad Museum, at 1649 El Prado. Tickets are \$30 in advance or \$35 at event. Ages 21 and up only. Info at [sdmrm.org/AlesnRails](http://sdmrm.org/AlesnRails).

**COLORADO, LONGMONT**, December 9-11, Model Railroad Exposition, sponsored by Boulder Model Railroad Club at County Fairgrounds, Nelson Road at Hover Road. Info at [bouldermodel-railroadclub.org](http://bouldermodel-railroadclub.org).

**FLORIDA, THE VILLAGES**, December 15-18, Christmas Train Show, at Colony Cottage Recreation Center, 510 Colony Boulevard, hosted by The Villages Railroad Historical Society.

**INDIANA, JASPER**, December 3, Model Train Show, at Dubois County Museum, 2704 Newton Street. Info at [duboiscountymuseum.org](http://duboiscountymuseum.org).

**MARYLAND, BALTIMORE**, December 11 and 18, Open House at Baltimore Society of Model Engineers (BSME) celebrating its 84th year. Info at [modelengineers.com](http://modelengineers.com).



## SELECTED EVENTS | 2

**MARYLAND, DELMAR**, December 3-4, January 7-8, 14-15, 31st Annual Holiday Open House, sponsored by the Delmarva Model Railroad Club. Camelot Hall, 2nd floor, 103 E State Street, Delmar (on the Delaware side of the road). Info at [delmarvamodelrailroadclub.org](http://delmarvamodelrailroadclub.org).

**MASSACHUSETTS, ROSINDALE**, December 3-4, Holiday Open House, sponsored by Bay State Model Railroad Museum, 760 South Street. Info at [bsmrm.org](http://bsmrm.org).

**NEW JERSEY, OCEAN CITY**, December 3-4, Train Show at Ocean City Sports & Civic Center, 6th and Boardwalk. Info at [oceancityvacation.com/details/2036-train-show.html](http://oceancityvacation.com/details/2036-train-show.html).

**OHIO, LIMA**, December 17, Train Town Train Show & Swap Meet, at Allen County Fairgrounds, Merchants Building, State Route 309 East. Info from Chuck White at [railcarman@frontier.com](mailto:railcarman@frontier.com).

**OHIO, SANDUSKY**, December 3, Open House at Erie & Mad River Model Railroad, 1309 North Depot Street. Request info from Robert Butler at [robertbutler@bex.net](mailto:robertbutler@bex.net).

**OKLAHOMA, OKLAHOMA CITY**, December 1-4, 21st Southern Plains N-Scale Convention, at Oklahoma State Fairgrounds. Convention hotel is Wingate Oklahoma City Airport, 2001 South Meridian Avenue. Info at [oknrail.org/convention](http://oknrail.org/convention).

**OHIO, SPRINGFIELD**, December 4, Model Train Show, at Clark County Fairgrounds, 4401 S. Charleston Pike. Info at [daytontrainshow.com](http://daytontrainshow.com).

**OREGON, RICKREAL**, December 3, Train Show & Swap Meet, at Polk County Fairgrounds sponsored by Willamette Valley Model Railroad Museum. Info at [co.polk.or.us/fair/railroad-show-0](http://co.polk.or.us/fair/railroad-show-0).

## SELECTED EVENTS | 3

**VIRGINIA, FREDERICKSBURG**, December 10-11, 19th Annual Christmas Train Show at Eagles Lodge, 21 Cool Spring Road, sponsored by Rappahannock Model Railroaders. Info at [rmrailroaders.com](http://rmrailroaders.com).

### January 2017

**CALIFORNIA, SANTA CLARA**, January 27-29, Bay Area Layout Design & Operations Weekend, Sponsored by NMRA Pacific Coast Region Layout Design and Operations Special Interest Groups. Info [pcrnmra.org/pcr/calendar/calendar.shtml](http://pcrnmra.org/pcr/calendar/calendar.shtml).

**FLORIDA, COCOA BEACH**, January 5-7, Prototype Rails 2017 RPM Meet, Cocoa Beach Hilton Oceanfront, 1550 N. Atlantic Ave. (Hwy A1A). Info at [prototyperrails.com](http://prototyperrails.com).

**MASSACHUSETTS, WEST SPRINGFIELD**, January 28-29, Railroad Hobby Show, sponsored by Amherst Railway Society, at Eastern States Exposition Fairgrounds. Info at [railroadhobby-show.com](http://railroadhobby-show.com).

**MINNESOTA, WOODBURY**, January 14, Model Railroad Flea Market, at Woodbury High School, 2665 Woodlane Drive, sponsored by Newport Model Railroad Club. Request info from Ed Petry at [sierraed@usfamily.net](mailto:sierraed@usfamily.net).

**WISCONSIN, STEVENS POINT**, January 21-22, 20th Annual Arctic Run Model Railroad Show, Holiday Inn Convention Center Hotel, 1001 Amber Avenue. Info at [thecitypages.com/events/20th-annual-arctic-run-model-railroad-show--sale](http://thecitypages.com/events/20th-annual-arctic-run-model-railroad-show--sale).

### Future 2017, by location

**AUSTRALIA, CANBERRA, KALEEN ACT**, March 25-26, 29th Annual Model Railway Expo, hosted by the Canberra Model Railway Club, at University of Canberra High School. Info at [cmrci.info](http://cmrci.info).

## SELECTED EVENTS | 4

**AUSTRALIA, VICTORIA, GEELONG**, April 14-16, 2017, 13th Annual Australian Narrow Gauge Convention. Info at [austnarrowgaugeconvention.com](http://austnarrowgaugeconvention.com).

**CANADA, ONTARIO, BOWMANVILLE**, March 11, 8th Annual Bowmanville Model Railroad Flea Market, hosted by Soper Valley Model Railroad Association. New location at Clarinton Central Secondary, 200 Clarington Blvd. Send information request to [sopervalley@gmail.com](mailto:sopervalley@gmail.com).

**CALIFORNIA, RIVERSIDE-SAN BERNARDINO AREA**, February 25, 2017, Self Guided Layout Tour and Swap Meet. Request info from coordinator Bob Chaparro at [chiefbobbb@verizon.net](mailto:chiefbobbb@verizon.net).

**COLORADO, DENVER**, August 30-September 2, 2017, National Narrow Gauge Convention, at Marriott Denver Tech Center Hotel. Info at [37nngc.com](http://37nngc.com).

**FLORIDA, FORT MYERS**, February 4-5, Annual Train Show, sponsored by Scale Rails of Southwest Florida, at Araba Temple, 2010 Hanson Street. Request info from Jim Overman at 239-272-6396.

**FLORIDA, ORLANDO**, July 30-Aug 5, 2017, NMRA National Convention. Info at [nmra2017.org](http://nmra2017.org).

**KANSAS, WICHITA**, February 4-5, Train Show & Swap Meet, sponsored by NMRA Chisolm Trail Division, at Cessna Activity Center, 2744 George Washington Blvd, Request info from Larry Gulick at [legdag@cox.net](mailto:legdag@cox.net).

**MARYLAND, TIMONIUM**, February 4-5, The Great Scale Model Train & Railroad Collectors Shows at Maryland State Fair, 2200 York Road. Info at [gsmts.com](http://gsmts.com).

## SELECTED EVENTS | 5

**MISSOURI, KANSAS CITY**, August 5-12, 2018, NMRA National Convention. Info at [kc2018.org](http://kc2018.org).

**MISSOURI, ST. LOUIS**, April 6-8, 32nd Annual Sn3 Symposium, at St. Louis Airport Marriott, 10700 Pear Tree Lane. Info [2017sn3symposium.com](http://2017sn3symposium.com).

**OHIO, GREENVILLE**, March 5, Swap Meet, sponsored by Darke County Model Railroad Club, at Youth Building, Darke County Fairgrounds, 800 Sweitzer Street. Request info from Joe Worz at [josephbw@imbarqmail.com](mailto:josephbw@imbarqmail.com).

**OKLAHOMA, TULSA**, June 21-25, Annual Convention of the Santa Fe Railway Historical & Modeling Society. Info from Marc Montray at [m.montray@sbcglobal.net](mailto:m.montray@sbcglobal.net) or visit [sfrhms.org/conventions](http://sfrhms.org/conventions). ■



**Click here for  
reader comments**

# Do ALL your model railroading friends know about MRH?

WE CONTINUE TO BE SURPRISED BY HOW MANY  
MODELERS STILL HAVE NEVER HEARD OF US –  
SO SPREAD THE GOOD WORD ABOUT MRH!

**NEW!**

# TMTV Season 2 DVDs and downloads



PREORDER

DVD

**\$39.99**

~~\$59.99~~



6 disks

Est. delivery:  
Early Dec.

GET THEM  
BOTH FOR ...

DVD

**\$67.77**

~~\$119.98~~



12 disks

All of season 2 ...  
30 min / day: will  
take 46 days to  
watch it all



PREORDER

DVD

**\$39.99**

~~\$59.99~~



6 disks

Est. delivery:  
Early Dec.

**SHOP NOW >>**

**Model Railroad  
Hobbyist Store**

[store.mrhmag.com](http://store.mrhmag.com)

# Clickable advertiser index – 1

[Accu-Lites](#)

[American Ltd \(San Juan\)](#)

[Amherst Railway Society](#)

[ANE Models](#)

[AQ Hobbies](#)

[Archer Fine Transfers](#)

[Athearn](#)

[Atlas Model Railroad Co.](#)

[Bachmann](#)

[Bachrus](#)

[Backdrop Junction](#)

[Banta Modelworks](#)

[Berrett Hill Trains](#)

[Black Cat Publishing](#)

[Blair Line](#)

[Bowser](#)

[Canyon Creek Scenics](#)

[Clever Models](#)

[Coastmans Scenic Products](#)

[Coffman Graphics](#)

[Con-Cor International](#)

[Credit Valley Railway](#)

[Crow River Products](#)

[Digitrax \(2 page spread\)](#)

[East Penn Traction Club](#)

[ESU LokSound](#)

[Fast Tracks](#)

[Fox Valley Models](#)

[Good Deals DCC](#)

[GLX Scale Models](#)

[Great Decals](#)

[HO Diesel Supply](#)

[Iowa Scaled Engineering](#)

[ITLA Scale Models](#)

[KC's Workshop](#)

[Ken Patterson.com](#)

[Lights 4 Models](#)

[Litchfield Station](#)

[Logic Rail Technologies](#)

[Main Street Heritage Models](#)

[Missouri Locomotive Company](#)

[Model Railroad Benchwork \(1\)](#)

[Model Railroad Benchwork \(2\)](#)

[Model Rectifier Corporation](#)

[Monster Modelworks](#)

[Motrak Models](#)

[Mountain Subdivision Hobbies](#)

[Model Railroad Control Systems](#)

[MRH Magazine](#)

[MRH Store \(1\)](#)

[MRH Store \(2\)](#)

[Mt. Albert Scale Lumber](#)

[NCE \(2 page spread\)](#)

[Nick & Nora Design](#)

[Norfolk & Western Hist. Society](#)

[North American Railcar Co.](#)

[Oak Hill MRR Track Supply](#)

[Pre-Size Model Specialities](#)

[Precision Design Co.](#)

[RailMaster Hobbies](#)

[Rapido \(1\)](#)

[Rapido \(2\)](#)

[Ring Engineering \(1\)](#)

[Ring Engineering \(2\)](#)

# Clickable advertiser index – 2

[Rulers-of-the-World](#)

[Rusty Stumps](#)

[Scale Trains](#)

[Scotty Mason Show](#)

[Select Model Railroads](#)

[Signature Press](#)

[Streamlined Backshop Services](#)

[Soundtraxx \(Blackstone\)](#)

[Southern Digital](#)

[TAM Industries](#)

[TAM Valley Depot](#)

[Tony's Train Exchange](#)

[Train Control Systems](#)

[TrainMasters TV \(1\)](#)

[TrainMasters TV \(2\)](#)

[TrainMasters TV \(3\)](#)

[Traintek](#)

[TSG Multimedia](#)

[Walthers](#)

[Westerfield Models](#)

[Yankee Dabbler](#)

[Yarmouth Model Works](#)

# Clickable “other” index

---

[Other – Cover](#)

[Other – Derailments](#)

[Other – Hobby Marketplace](#)

[Other – MRH Sponsors](#)

[Other – Contents](#)

## DOWNLOAD ISSUE



DOWNLOAD PORTRAIT



DOWNLOAD LANDSCAPE

• INDEX

• TABLE OF CONTENTS



# REVERSE RUNNING

commentary

DON HANLEY  
.....



[Click here for  
reader comments](#)

## WHO NEEDS MODELS?

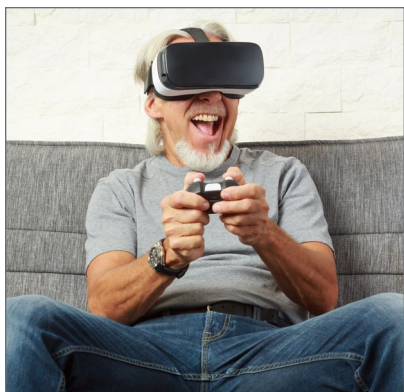

**WITH THE ADVENT OF** new 3D video technology and virtual reality, who needs to build an operating layout?

For a mere \$80 to \$120 you can get a set of virtual reality goggles. The new technology allows you to hook up the goggles to your smart phone and view videos and, I assume by extension, games also.

There have been several posts on the forum about different railroad video games, so as the games and the technology improve, soon we will be doing away with the need for layouts.

Think about it. Just sit down in your favorite recliner and immerse yourself in a world of railroad fantasy. You won't have to spend untold hundreds and thousands of hours building a small to medium size layout. No more splinters in your fingers from building the benchwork. For less than the cost of a DCC locomotive with sound, you can have entire railroad at your fingertips.

▶ **STEPPING OUTSIDE THE BOX WITH A CONTRARY VIEW**



With this new technology we won't have to worry about glue getting in places we don't want it, or the fogging of window glazing because of excess glue. We won't have to develop the skills to glue pieces together neatly. While the new technology is more expensive than glue or some beginner kits, in the long run it will be much cheaper than all of the glue and kits required for even a small layout.

How about those pesky electrical gremlins that show up at the most inopportune time – generally operating sessions or open houses? No longer will you need to hunt them down so the show can go on. You will no longer need to learn how to solder or understand the basics of wiring a layout. It's just plug and play. You will have your empire with the click of a mouse. How much simpler can it be?

Once you have your virtual empire, you won't need to waste time reading *Railroad Model Craftsman*, *Model Railroader*, or even our favorite magazine, *Model Railroad Hobbyist*. We don't need new products and techniques – in fact, model railroad publications will no longer be needed. With no physical layout there will no longer be a need for manufacturers and we won't have to worry about funds to purchase those limited-run items for our layout. Yep, the hobby is going to die out, just as many of the naysayers have been predicting!

Wait a minute: the growing [Maker Movement](#) is all about unplugging to build with your hands. True maker-style modeling is not virtual – it's hands-on. It's getting glue in the wrong places, finding splinters in your hands, having paint bleed under tape, fighting electrical issues: the list goes on and on. Join the movement, become a Maker – unplug, get a train set for the kids, and put it under the Christmas tree!

As the adult, you will have to show maker thinking to your kids with a layout. It's preparation for life! It's time to get glue in the wrong place, to find splinters in your hands, to have paint bleeding under tape, and to start fighting those electrical gremlins. But of course, there's great fun, too. What are you waiting for, Mr. Maker? ☑



# DERAILMENTS



## BRITISH RAILROAD HUMOR

Leave it to the Brits to pull off some great railroad humor. In this YouTube video, a fellow is trying to explain a new rail line proposal to a government official who doesn't quite "get it." ■

▶ BIZARRE FACTS AND HUMOR (SUPPOSEDLY)

# THAT LIGHT AT THE END OF THE TUNNEL

The *pessimist* sees the darkness of the tunnel ...

The *optimist* sees the light at the end ...

The *realist* sees the train ...

And the engineer sees three out-to-lunch guys standing on the tracks about to get hit! ■

## 💰 GET PAID ...

If you're the first to submit a bit of good humor or bizarre facts and we use it, it's worth \$25! Just send to [derailments@mrhmag.com](mailto:derailments@mrhmag.com) ■

## Coming next issue ...

- Actor Michael Gross shares his realistic rolling stock weathering methods
- Return to Allagash country!
- Spicing up model photos
- Modeling potash cars
- Using SMD LEDs in signals
- And lots, *lots* more!



**Click here for  
reader comments**

