

OCTOBER 2016 | FREE

# MRH

MODEL RAILROAD HOBBYIST

## ALSO:

- Great Lakes Western club layout
  - Airside hopper repaint
  - Easier track cleaning
  - SMD LED headlight tricks
  - Case for only ONE peninsula
- ... and lots more inside!*

## Kurt Matthey and his Cleveland Flats module

» **READ NOW**



STANDARD EDITION | PORTRAIT



DOWNLOAD



# IT'S NOT TOO LATE TO GET ON BOARD! ATLAS HO MODERN COMMUTER CARS



**CLICK HERE!**



Multi-Level Trailer



Multi-Level Cab Car



Multi-Level Trailer with Safety Slogan



Multi-Level Trailer with Toilet

\*Products bearing NJ TRANSIT marks are made under trademark license from NJ TRANSIT.

• INDEX

• TABLE OF CONTENTS



# STAFF CREDITS

**Front cover:** In our October cover story, Kurt Matthey tells us about his Cleveland Flats switching module – a lot of layout in a small space!



ISSN 2152-7423

## Editorial Staff

Joe D. Fugate, Publisher and Editor  
Don Hanley, Assistant Editor

## Production

Patty Fugate, Pasteup and Layout  
Joe Brugger, Copy Editing  
Mike Dodd, Copy Editing

## Technical Assistant

Jeff Shultz

## Advertising

Les Halmos, Account Manager  
Daniel Nava, Advertising Assistant  
Jean-François Delisle, Marketing Assistant

## Columnists

Richard Bale, News and events  
Jeff Shultz, News and events  
Les Halmos, Modular railroading  
Larry Smith, Narrow Gauge/Shortlines  
Bruce Petrarca, DCC  
Ken Patterson, Reporter at large

## Special Correspondents

Joe Brugger, Questions & answers  
Charlie Comstock, Contributing editor

Issue password: Oct2016

Published for the glory of God. [What's this?](#)



# MRH SPONSORS

## A - E



[acculites.com](http://acculites.com)



[americanlimitedmodels.com](http://americanlimitedmodels.com)



[railroadhobbyshow.com](http://railroadhobbyshow.com)



[anemodel.com](http://anemodel.com)



[archertransfers.com](http://archertransfers.com)



[athearn.com](http://athearn.com)



[www.atlasrr.com](http://www.atlasrr.com)



[bachmanntrains.com](http://bachmanntrains.com)



[bachrus.com](http://bachrus.com)



[backdropjunction.com](http://backdropjunction.com)

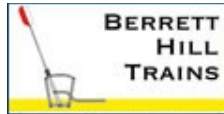

[berrethill.com/trains](http://berrethill.com/trains)



[blairline.com](http://blairline.com)



[bowser-trains.com](http://bowser-trains.com)



[coffmaneng.com](http://coffmaneng.com)



[cvrco.com](http://cvrco.com)



[coastmans.com](http://coastmans.com)



[www.digitrax.com](http://www.digitrax.com)



[esu.eu/en](http://esu.eu/en)

[Vendors: Get your clickable logo here ...](#)

# MRH SPONSORS | 2

## F - R



[www.handlaidtrack.com](http://www.handlaidtrack.com)



[foxvalleymodels.com](http://foxvalleymodels.com)



[glxscalemodels.com](http://glxscalemodels.com)



[www.iascaled.com](http://www.iascaled.com)



[iwata-medea.com](http://iwata-medea.com)



[litchfieldstation.com](http://litchfieldstation.com)



[micromark.com](http://micromark.com)



[moloco.biz](http://moloco.biz)



[model-trains-video.com](http://model-trains-video.com)



[modelrectifier.com](http://modelrectifier.com)



[monstermodelworks.com](http://monstermodelworks.com)



[stores.ebay.com/Motrak-Models](http://stores.ebay.com/Motrak-Models)



[mtalbert.com](http://mtalbert.com)



[ncedcc.com](http://ncedcc.com)



[nickandnora.com](http://nickandnora.com)



[nwhs.org](http://nwhs.org)



[www.pwrs.ca/main.php](http://www.pwrs.ca/main.php)



[railmasterhobbies.com](http://railmasterhobbies.com)



[rapidotrains.com](http://rapidotrains.com)



[ringengineering.com](http://ringengineering.com)



[rustystumps.com](http://rustystumps.com)

[Vendors: Get your clickable logo here ...](#)

# MRH SPONSORS | 3

## S - Z



[sanjuancarco.com](http://sanjuancarco.com)



[scaletrains.com](http://scaletrains.com)



[selectmodelrailroads.com](http://selectmodelrailroads.com)



[signaturepress.com](http://signaturepress.com)



[soundtraxx.com](http://soundtraxx.com)



[sodigi.com](http://sodigi.com)



[sbs4dcc.com](http://sbs4dcc.com)



[tamvalleydepot.com](http://tamvalleydepot.com)



[sbs4dcc.com](http://sbs4dcc.com)



[tonystrains.com](http://tonystrains.com)



[trainmastermodels.com](http://trainmastermodels.com)



[traintekllc.com](http://traintekllc.com)



[tsgmultimedia.com](http://tsgmultimedia.com)



[tsgmultimedia.com](http://tsgmultimedia.com)



[yankeedabblers.com](http://yankeedabblers.com)

[Vendors: Get your clickable logo here ...](#)

Looking for something? Check the MRH Marketplace!

Take me there!



# EMD 39 SERIES

## DIESELS

ELECTRO MOTIVE V 12 LA GRANGE ILLINOIS



## ALL IN THE FAMILY BRAND NEW ATHEARN® RTR SD39 AND GENESIS® GP39-2 DIESELS ARRIVING

**DCC-READY: \$134.98**  
**RTR-SOUND: \$184.98**

Both the Athearn® RTR SD39 and the Genesis® GP39-2 share a level of detail never delivered in HO scale before. Our new RTR SD39 shares the same proven new mechanism from the popular SD38/40/45 and is available DCC and sound ready. The optional Genesis motor upgrade kit makes speed matching a breeze.

The right phase for the right road name...specifically! The brand new GP39-2 incorporates several body phases and many separately applied details that are specific to each road name. Built upon our popular GP38-2, GP40-2, GP50 Genesis mechanism, these models achieve an entirely new level of "as close to real as it gets!"



ATH640978 - HO GP39-2 Phase IIB  
with DCC & Sound, BN #2702

| DCC-Ready | RTR-Sound |                          |
|-----------|-----------|--------------------------|
| ATH98773  | ATH98873  | HO RTR SD39, Undecorated |
| ATH98774  | ATH98874  | HO RTR SD39, SF #4001    |
| ATH98775  | ATH98875  | HO RTR SD39, SF #4004    |
| ATH98776  | ATH98876  | HO RTR SD39, SF #4005    |
| ATH98777  | ATH98877  | HO RTR SD39, SF #4011    |
| ATH98778  | ATH98878  | HO RTR SD39, IT #2302    |
| ATH98779  | ATH98879  | HO RTR SD39, IT #2303    |
| ATH98780  | ATH98880  | HO RTR SD39, IT #2304    |
| ATH98781  | ATH98881  | HO RTR SD39, MN&S #40    |
| ATH98782  | ATH98882  | HO RTR SD39, MN&S #41    |
| ATH98783  | ATH98883  | HO RTR SD39, N&W #2961   |
| ATH98784  | ATH98884  | HO RTR SD39, N&W #2963   |
| ATH98785  | ATH98885  | HO RTR SD39, N&W #2965   |
| ATH98786  | ATH98886  | HO RTR SD39, N&W #2966   |
| ATH98787  | ATH98887  | HO RTR SD39, SP #5302    |
| ATH98788  | ATH98888  | HO RTR SD39, SP #5306    |
| ATH98789  | ATH98889  | HO RTR SD39, SP #5310    |
| ATH98790  | ATH98890  | HO RTR SD39, SP #5314    |

**HO GENESIS EMD GP39-2**  
**DCC-READY: \$169.98**  
**TSUNAMI SOUND: \$269.98**



**HORIZON**  
HOBBY

**VISIT**  
Your Local Retailer

**CLICK**  
Athearn.com

**CALL**  
1.800.338.4639

**SERIOUS FUN™**

©2016 Horizon Hobby, LLC. Athearn, Genesis and McHenry are registered trademarks of Horizon Hobby, LLC. All other trademarks, service marks and logos are property of their respective owners. Final models may vary slightly from photos shown. 53141

• INDEX

• TABLE OF CONTENTS



# TABLE OF CONTENTS

## FEATURES

### Cleveland Flats switching module

*KURT MATTHEY*

Small switching layout with big possibilities

---



### Railfanning the Great Lakes Western

*BRUCE PETRARCA*

Tour this club layout in Phoenix, Arizona

---



### Athearn Airslide hopper repaint

*BOB RIVARD*

Give these hopper cars a whole new look

---



### Track cleaning the easy way

*MARK GILGER*

How to keep your track constantly being cleaned

---

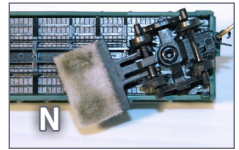

### Tricks with SMD LED headlights

*BILL BEVERLY*

Getting loco headlights that look like incandescents

---



**ALSO:** MRH Marketplace | Subscriber extras



## TABLE OF CONTENTS | 2

### COLUMNS

**MRH Q-A-T: Uncoupling skewers, diesel fueling, ...**

*compiled by JOE BRUGGER*

**DCC Impulses: Five years of DCC Impulses**

*BRUCE PETRARCA*

**Getting Real: Hot boxes**

*JACK BURGESS*

**Lite & Narrow: Twin Mountain & Potomac**

*LARRY SMITH*

**What's Neat: St. Louis Rail Prototype Modelers meet**

*KEN PATTERSON*

**Photo feature: Yes, it's a model**

*compiled by DON HANLEY*

**Derailments: Bizarre facts & humor**

*compiled by the MRH STAFF*

### NEWS and EDITORIAL

**Asst. Editor's thoughts: Playing or creating?**

*DON HANLEY*

**News & Events: October 2016**

*RICHARD BALE & JEFF SHULTZ*

**Reverse Running: Case for only ONE peninsula**

*LANCE MINDHEIM*

# Just Try & CONTAIN YOURSELF



**HO & N Scale Dry Containers**  
**HO & N Scale Reefer Containers w/ Sound**

**Buy Now**



**HO** **N**  
#87 SCALE #160 SCALE

© 2016 ScaleTrains.com, Inc.  
ScaleTrains.com, Operator, and respective logos are trademarks of  
ScaleTrains.com, Inc. • ScaleTrains.com, Inc. 7598 Highway 411 Benton, TN 37307  
844-9TRAINS 844-987-2467 International 423-299-3689

[WWW.SCALETRAINS.COM](http://WWW.SCALETRAINS.COM)

Scene and photography  
by Ken Johnson.  
First test models shown.

• INDEX

• TABLE OF CONTENTS



# ASSISTANT EDITOR

editorial

DON HANLEY  
.....



[Click here for  
reader comments](#)

## PLAYING OR CREATING?

### IN THE PAST FEW MONTHS I HAVE HAD TWO

conversations that, while in no way related by topic, were very related to our hobby and the supposed impending demise of the hobby. The first was with Les Halmos, our advertising manager, regarding playing with trains. The other with my brother-in-law, about working and the sense of satisfaction in building or accomplishing something.

Many of us are hesitant to mention our passion for model railroading because, for a lot of non-hobbyists, it conjures up the idea of someone who never grew up. Still playing with trains, what they did in their adolescence. Athletes play sports and compete, but because some are paid large sums of money, it is taken very seriously.

If model railroading were a paid profession, would it be taken more seriously? Maybe. The hard fact is that the perception of many is what it is – trains are for *adolescents*, not for *grownups*. We are unlikely to change that perception, so we need to work around it instead.

## ASSISTANT EDITOR'S THOUGHTS | 2

This brings me to my conversation with my brother-in-law. We discussed the sense of satisfaction when building or accomplishing something. It's something important in everyone's life, yet my brother-in-law believes it is missing for most. While having this discussion around the dinner table, I immediately thought of my many years of model railroading experience. Yes, there have been frustrations, but I also derive a deep sense of satisfaction from the hobby.

I have come to believe that when talking to non-hobbyists, the approach to take is focusing on what the hobby does for us: that sense of deep satisfaction after having accomplished something.

When asked if I have any hobbies, I am now trying to pique the interest of non-hobbyists by saying something like "I create scenes, my hobby is creative, or it's artistic," or something along those

### ADVERTISEMENT

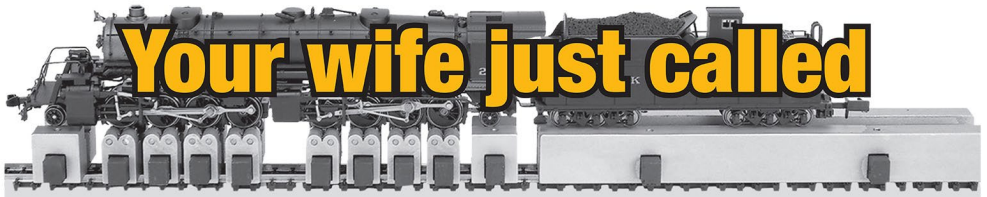

**ROLLING ROADS**

**SPEEDOMETER** For Speed in Real Time!



Analogue  
or digital

**She said it's okay**  
*(Go ahead and click)*

**Bachrus** inc  
RUNNING ON QUALITY

[www.bachrus.com](http://www.bachrus.com)  
Hannon, ON Canada

# MRH SECOND ANNUAL "ONE MODULE" CHALLENGE CONTEST

**ENTRY DEADLINE: January 31, 2017**

**Goal: Design the first "module section" for a sectional home layout design.**

Hypothetical room is 10' x 14' – 2'x8' closet can be used; window can be covered.

*Note: This is a sectional home layout design, no modular standard required.*

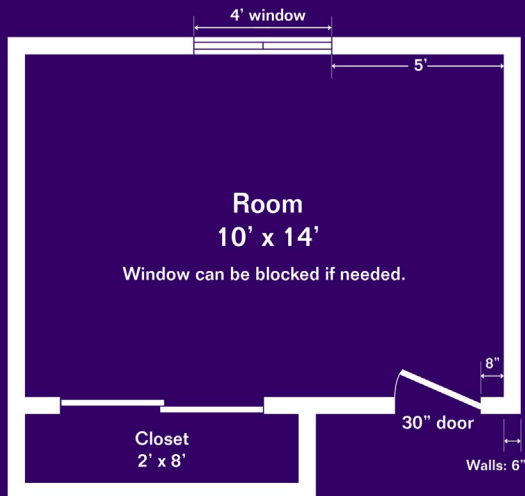

## CONTEST RULES

- Modules can be any size or shape but must fit through the room door (7'-6" tall and 30" wide) without damage or pinching your fingers.
- Scale: From Z to O, using any track gauge combination.
- Module section must connect to a temporary staging yard module at each end. Staging yard must have at least three yard tracks.
- Rough in the outlines of the other layout module sections to be built for the entire room. No track plan required, just an outline of the modules in the room is sufficient. Bonus points awarded for [showing a module construction progress plan](#).
- Modules can follow a standard or not. Custom sections are okay.
- Module support method / height up to you, but please describe.
- Innovative approaches get extra points: please describe and illustrate if possible.
- Include a cost estimate for the module. There is no need to actually build anything, this is a design contest only. Do be as comprehensive as possible in the cost estimate: the hypothetical goal is a completely finished, operational module.
- The best submissions will be published, so extra points are awarded for quality text, illustrations, photos and captions. Winners get a bonus payment rate.

**SUBMIT ENTRY (Choose "Contest Entry")**

# Select MODEL RAILROADS

## Design & Build Services For Discriminating Modelers



**WE WILL:**  
**Complete Unfinished Railroads**  
**Fix or Rebuild Bad Railroads**  
**OR**  
**Design & Build A Custom**  
**Railroad Of Your Dreams**

**CLICK HERE FOR OUR WEBSITE**  
[www.SelectModelRailroads.com](http://www.SelectModelRailroads.com)

**(844) 872-4670**

## DCC and Sound in N Scale?

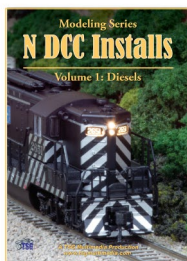

**We'll show you how!**

*N DCC Installs*

Examples with and without sound!

CLICK FOR  
DCC

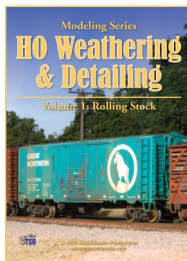

**Want it now?**

Our titles are now available in digital download format!

CLICK FOR  
DIGITAL



**TSG Multimedia**

## ASSISTANT EDITOR'S THOUGHTS | 3

lines. Most individuals get curious about the creative aspect of the statements. I let them ask questions about what I'm creating. Once they ask the questions, that allows me to discuss more about the hobby with them. If not, then I drop it.

However, just because they ask for information, I don't blurt out, "I am a model railroader." I draw them into the conversation. I let them know that I look for ways to create in scale what I see in the real world or have seen in historical photographs. I explain the sense of accomplishment I have when I achieve my goal. Having photos on my smart phone of scenery or structures is helpful. I know when I show non-hobbyists photos of my work, the most common responses are "WOW." They are amazed that something like that can be done, and often admit they do not have the talent to do anything like that.

This is our bus.



Like, we're a  
bus company now.



Click here for more info.

## ASSISTANT EDITOR'S THOUGHTS | 4

I let the individual know that I am attempting to recreate a scene, at point in time, of something that really existed, or exists in my imagination. Only near the end do I let them know that it is a part of my model railroading hobby. Once they understand the skills required and what I am attempting to create, the hobby moves from belonging to those in adolescence, to become a pursuit where skills and talents much more advanced than what kids have are needed.

I explain the sense of satisfaction I have when a scene or structure is finished, or when I have improved my skills and developed new ones. I ask them to tell me what they do to get that sense of achievement or satisfaction. I don't let work be the answer, since we are talking about hobbies.

Much has been written and said about attracting new blood to the hobby. I believe we can best attract new blood by avoiding the old stereotypes and instead intriguing those not in the hobby. We're all a lot more likely to explore the possibilities of doing something if we perceive it as interesting and neat rather than being boring and weird.

What would happen, when asked about are our hobbies, if we said something different than "I model railroads and have a layout in my basement." How would you say it?



[Click here for reader comments](#)

*Assistant Editor's Thoughts continue on the next page with some additional notes ...*



# BACHMANN INTRODUCES NEW ACCESSORIES FOR EASIER MODELING!



HO SCALE BALLAST SPREADER  
with SHUTOFF • MSRP \$35.00  
Item No. 39015

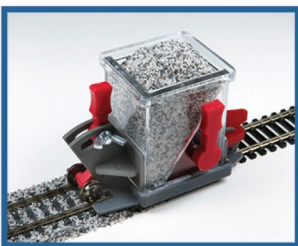

HO SCALE BALLAST SPREADER  
CAR with SHUTOFF &  
HEIGHT ADJUSTMENT • MSRP \$59.00  
Item No. 39016

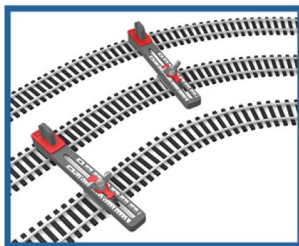

HO SCALE ADJUSTABLE PARALLEL  
TRACK TOOL (2 per pack) • MSRP \$35.00  
Item No. 39017

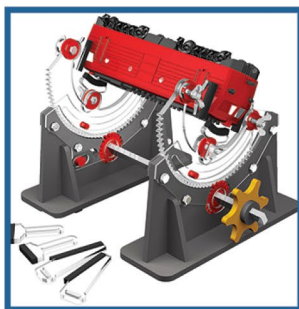

MULTI-ANGLE ROTATING LOCO CRADLE  
(adjusts to fit from N to most O scale models)  
MSRP \$99.00  
Item No. 39018

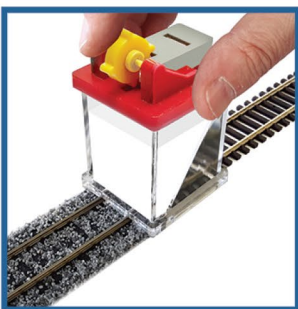

N SCALE BALLAST  
GLUE FIXER • MSRP \$49.00  
Item No. 39019



O SCALE BILLBOARD KIT  
(2 per pack) • MSRP \$25.00  
Item No. 39111

Bachmann has expanded its accessories line with new Proses products for the HO, N, and O scale modeler. From specialized HO ballast spreaders that allow you to customize ballast flow to a handy rotating cradle that adjusts to hold from N to most O scale models at a comfortable working angle, Bachmann has just what you need to tackle essential modeling projects. Visit your favorite hobby dealer to see these new products plus our full line of Proses accessories and start enjoying easier modeling today!



Click on links above  
for more info



Bachmann Industries, Inc. • 1400 East Eric Avenue • Philadelphia, PA 19124 USA • [www.bachmanntrains.com](http://www.bachmanntrains.com)

Click to learn more.

## Other notes - MRH 2016 Survey, reader age results

We concluded our 2016 reader survey this summer – here is the age of our readers. The statistical validity is +/- 2.5% with a 95% certainty.

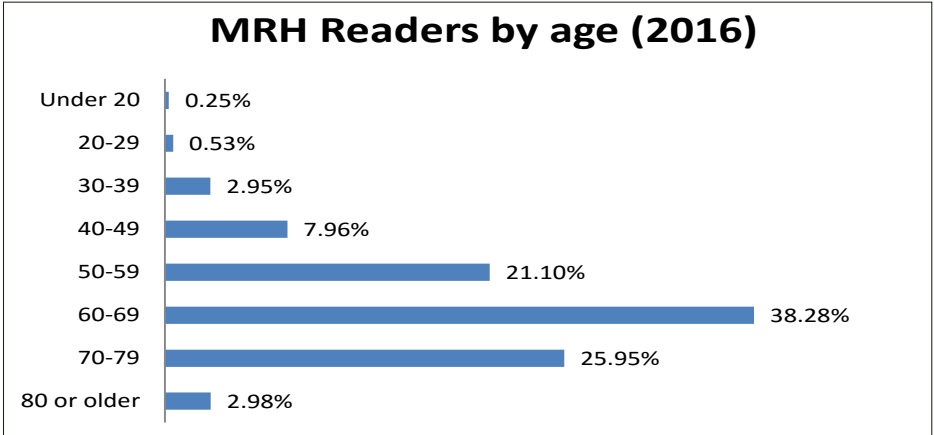

Why are these numbers important? With 88% of MRH readers being over 49, eyesight can become an issue.



TrainMasters TV is doing a two-part story on model railroaders and how to deal with eyesight issues. We felt this video needed to be done, but we're still surprised by the reception:

- “Truly inspirational and some useful tips for those of that can see fairly well.”
- “I’m 52 and been leagally blind for 5 years now. I started in the hobby 2 years ago, this video is such a help. I have some of the tools mentioned but didn’t know of others. Thanks TMTV for this segment keep up the great videos.”
- “This video is truly a gift to those of us with sub-par vision. The seriousness of TMTV is greatly appreciated, thank you.”

Head on over to TMTV and [check out this story for yourself!](#)

# Trainfest®

NEW  
**2 DAY  
TICKETS**

AVAILABLE JULY 1  
THROUGH NOV. 11

AMERICA'S LARGEST  
OPERATING MODEL  
RAILROAD SHOW

Saturday & Sunday  
Nov. 12 - 13, 2016

9:00am-  
5:00pm

WI State  
Fair Park  
Milwaukee (West Allis), WI

Ticket discounts and show details at **Trainfest.com**

## EXPANDED TRAINFEST CLINICS

**FREE**

Join us for **2 full days** of clinics presented by expert modelers and model railroading manufacturers. Choose from a wide range of modeling topics at any of our **56 total clinics!** Space is limited, register for clinics today at [www.Trainfest.com](http://www.Trainfest.com).



## 60 MODEL RAILROADING MANUFACTURERS

Come to see all **major model railroading manufacturers** at Trainfest and many **cottage industry** businesses offering unique and interesting products for your layout. Don't miss any of the exciting announcements scheduled to be unveiled at Trainfest!

**NEW PRODUCT ANNOUNCEMENTS**

**OPERATE  
THE  
TRAINS!**

## 70 OPERATING LAYOUTS

Make Trainfest your annual destination to meet with other modelers and find inspiration for your own layout at more than **70 operating model railroads**. Experience the camaraderie of the model railroading hobby and even **operate the trains** on participating layouts!

CELEBRATE  
A  
RAILROAD



## CELEBRATING THE MILWAUKEE ROAD

In 2016 Trainfest will partner with the Milwaukee Road Historical Association to celebrate the Milwaukee Road. Look for the Milwaukee Road throughout the show and don't miss the museum quality historical photo display, Celebrate-a-Railroad clinic series, and much more!

**FREE  
RIDE THE  
MLES  
TRAIN!**

Sponsored by the Wisconsin Southeastern Division, Inc.  
of the National Model Railroad Association



# LAST ISSUE'S RATINGS

The five top-rated articles in the [September 2016 issue](#) of *Model Railroad Hobbyist* are:

- 4.8 Getting Real: More accurate railcar truck modeling
- 4.7 DCC Impulses: Traveling with DCC
- 4.7 Imagineering: Hiding a helix
- 4.7 What's Neat: Quick switches, cement roads, and more ...
- 4.5 Toolshed: Pliers and cutters

Issue overall: 4.7

**Please rate the articles!** Click the reader comments button on each article and select the star rating you think each article deserves. Thanks! ■

## ADVERTISEMENT



**Archer**  
FINE TRANSFERS  
PROUDLY SERVING MODEL BUILDERS SINCE 1989

**THE ORIGINAL  
SURFACE DETAILS™**

**WE NOW HAVE MORE THAN 100 SHEETS OF RIVETS, LOUVERS, TREADPLATE AND MORE CAST ONTO MICROSCALE CLEAR DECAL FILM**

**FREE SHIPPING:**

- DOMESTIC USA ORDERS \$50 OR MORE
- INTERNATIONAL ORDERS \$100 OR MORE

**CLICK HERE TO VISIT OUR WEBSITE!**

Tony Thompson, Model Railroad Author/Historian

MADE IN THE USA

Archer Fine Transfers • PO Box 1277 • Youngsville, NC 27596 • USA  
(919) 570-1026 • info@archertransfers.com • archertransfers.com

## ADVERTISEMENT

**TRINITY 3281  
SUMMER 2016**



Norfolk Southern -- 12 #s



ICE-GATX -- 8 #s



Winchester & Western -- 12 #s



NRLX Ciment Quebec -- 12 #s



HWCX -- 7 #s

**American Limited**

[www.americanlimitedmodels.com](http://www.americanlimitedmodels.com)

# Bowser

## New Product Announcement: U-25b Locomotives

Ready To Run and Fully Detailed. New Upgraded Handrails (correct for all Phases), New 9'4" AAR B Trucks and Gearbox, Metal MU Hoses, air hoses, windshield wipers, grab irons, coupler lift bars, operating headlight, window glass, can motor, flywheels, nickel silver wheels with RP25 flanges, knuckle couplers. Available with sound and DCC or just DC. Analog (DC) version features NMRA 21 pin plug for DCC, DCC/Sound version features LokSound Select decoder. (Stanchion Colors used for visual purposes only to show differences)

DC Version: \$199.95    Sound Version: \$299.95

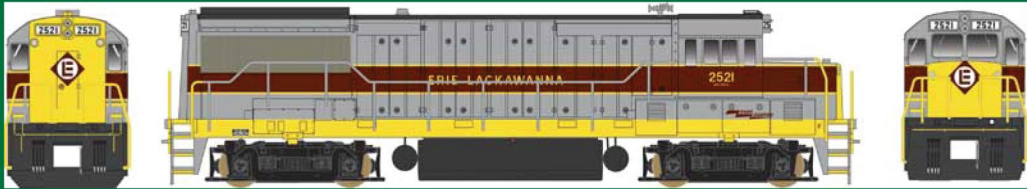

Click here to check out the details for these and other great Bowser Products

• INDEX

• TABLE OF CONTENTS

**ARE ZERO DERAILMENTS POSSIBLE?  
YES!** It starts with great trackwork.

Make it run like a

# **Dream TRACKWORK BOOK**

104 pages

*By Joe Fugate*

**Available NOW!**

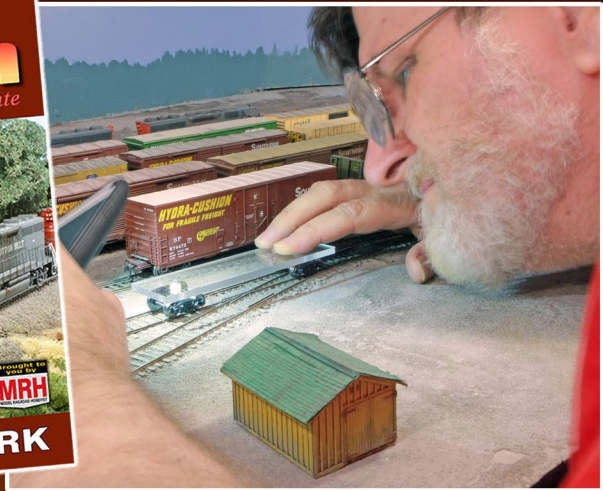
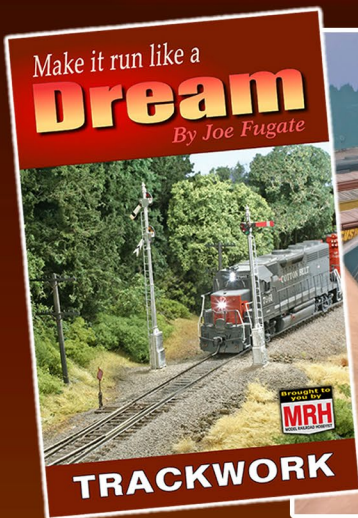

*Click me to*  
**GET eBook NOW >>**  
**\$11.49**

Format: Landscape and  
Portrait PDF

*Click me to*  
**ORDER PAPERBACK >>**  
**\$27.49 + S&H**

Paperback includes  
complimentary eBook too!

• INDEX

• TABLE OF CONTENTS



# Eyesight and model railroading

ON TRAINMASTERS.TV



Part 1 now available

Part 2 coming in October

[click to watch](#)

Non-members: Watch an episode for \$1.49  
or become a member for unlimited access

*“Lots of practical advice  
I can use in **this** video!”*

*- Mark Z.*

*These videos are in-depth like  
MRH articles, except without ads*

Brought to  
you by

**MRH**  
MODEL RAILROAD HOBBYIST





# MRH Q-A-T

column

compiled by  
**JOE BRUGGER**  
.....



[Click here for  
reader comments](#)

## QUESTIONS AND ANSWERS

### A place for uncoupling skewers

**Q.** I use bamboo skewers for uncoupling on my On30 layout because they're extremely inexpensive and work very well. Just insert the sharp end between the knuckles and rotate. But I have never found a good way to store them. People stick them into the car card boxes, but the boxes are short and the skewers often fall out. I'd love a tube, about the size of a cigar tube, with wings to the back end that would allow them to be mounted vertically onto the fascia. Does anyone know of a commercial product I might be able to use?

—Lee



**A.** Something compact that fits close to the fascia will solve your problem. Here are some suggestions:

1. Think pen holder. Pretty easy to make something yourself using PVC pipe too.

—Randy Seiler

▶ MRH QUESTIONS, ANSWERS, AND TIPS



2. Bill Brillinger shortens the skewers so they are less cumbersome and keeps a selection of lengths for operators to choose from. He places laser-cut holders around the layout. To protect your operators, store pencils and picks point-down. A strip of soft foam in the bottom can protect the points.



3. Jeff Shultz has several New Rail Models cup holders, complete with red cups, mounted in strategic spots. This is not on his layout, he says, but the idea is the same. He puts little yellow dry-wall anchors on the ends of the bamboo skewers. Makes them easier to find, harder to lose.

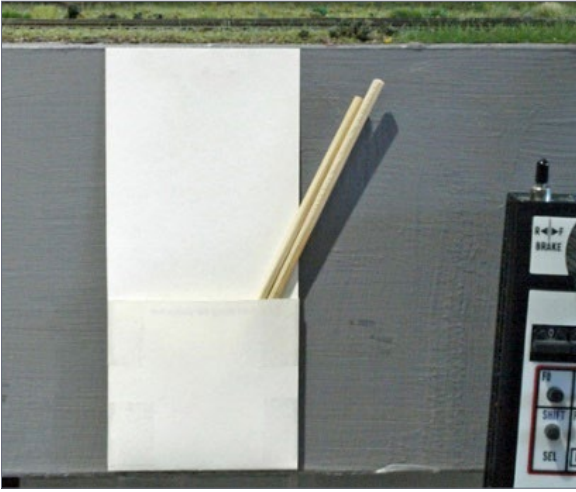

4. Being both cheap and not wanting significant protrusions from the fascia, Ken Glover uses 67 lb. cover stock (heavy paper) for car card holders and coupler picks.

**Rob Spangler:** I have L-shaped shelf things attached to the fascia at every switching location. The tall part of the L is toward the outside. Crews can leave uncoupling picks in them, and also use them to sort car cards.

**Lee:** Sure would be neat to find something like [1] that's deep enough. I spent half an hour walking around Hobby Lobby trying to find anything I could use, with no success. Heck, even a Google search turned up nothing. Just a good hard plastic tube, about five inches or so, with a bottom to it would be great. I could use PVC with a cap on the end, then hold it to the fascia with those half-pipe-shaped metal pieces that hold pipes to walls. I was really hoping there was a commercial product that wouldn't look like I went to the hardware store and made my own.

**Jeff Shultz:** Not craft stores ... office supply stores. Something set up to hold pens would probably hold skewers with no issues. Although frankly, from a price point I doubt you could beat a couple inches of 1x1 with some holes drilled in it and glued to the fascia.

**Brodie Washburn:** I did the pine thing with two holes three inches deep and glued the piece of pine to the side of a 2x2 leg. Easy and out of the way.

**chris.mincemoyer:** I operated on a layout that used a piece of Velcro around the skewer that attached to the fascia.

**Robert:** One half of my layout has plenty of headroom and a bit of a reach so I use long skewers. These are stored horizontally using small open cup hooks. For the other half I have limited height and the skewers are shorter. The skewers there can be stored upright using closed eye-hooks. These are the same eyes I use to keep wiring tidy under the layout.

**Pelsea:** I had just been tossing cable clamps on a nearby shelf, but after reading this tread I made a home for my spudger with one.

**Mark Dance:** I put in drilled wood blocks after I saw the idea in one of Tony Koester's "Trains of Thought" columns. No more hunting for picks! I painted the blocks black to match the fascia and attached them with double-sided tape, but they blended in too well to find them easily. I took them all off and ran over the top of them with some gray paint on a roller to make the tops noticeable.

Lee's solution, more ideas, and some recipes are at [mrhmag.com/node/27364](http://mrhmag.com/node/27364).

## Walthers diesel fueling facility

**Q.** The instructions with this kit refer to installing a complete section of track and not using the walkways for a modern facility. On the prototype, would the track be ballasted in that situation or are the ties fixed to the base?

—Bill B.

## MRH Q-A-T | 5

**A. Jeff Shultz:** You don't see the ties on a modern facility. The rail may be fixed to anchors set in the concrete pad and there will be a recessed catch area. Railroad suppliers like Century Group offer metal pan systems [5]. Modern facilities have hard surfaces for spill containment and cleanup.

**MRH:** With the implementation of SPCC (Spill Prevention Control & Countermeasures) regulations by the EPA, all regulated facilities with railroad tank car loading/unloading racks

handling oil products must have a collection system which can contain the volume of the largest tank or compartment.

The rules were enacted in 2002 and

5. Century Group Inc. supplies railroads and industry with railroad spill collection systems to meet environmental regulations mandated by EPA, state, and local regulatory agencies.



are at [centurygrp.com/products/RailroadSpillCollectionContainmentPanSystem/SPCC-Regulations](http://centurygrp.com/products/RailroadSpillCollectionContainmentPanSystem/SPCC-Regulations).

and [osha.gov/pls/oshaweb/owadisp.show\\_document?p\\_table=STANDARDS&p\\_id=10420](http://osha.gov/pls/oshaweb/owadisp.show_document?p_table=STANDARDS&p_id=10420).

In earlier years, some oil refueling facilities had concrete aprons and walkways, but they were also found with open metal gratings alongside ordinary graded and ballasted track, or just packed earth or crushed rock along the tracks.

## Solder all rail joints?

**Q. Do I solder my track joints for my layout?**

—Spiritbear770

Let's put the question another, wordier, way. What do you do to make sure that track stays in gauge, has no derailment-causing kinks, and electricity reaches every piece of rail? There are two schools of thought on the answer, and the solutions are often weather-related.

—MRH

**A. Leo Johansen:** I solder all rail joints while straight before installing track on curves. I make sure to remove a couple of ties at each joint before soldering, and I connect the sliding rail to sliding rail to give it room to slide when it curves. (Some brands of flex track have a sliding rail on one side.) When forming the curve I make sure the sliding rail is on the inside of the curve, or it's a sure bet Murphy will come after you.

**Jgraffi:** I have not soldered any of the rail joints on my 12x8-foot HO layout. My benchwork is old-school 1/2" plywood with 2x4 framing. The humidity here varies from 90% in the summer to 35% in winter. With outside temps from 105 degrees to

0 degrees (F), everything changes size and shape! Doors stick and windows get tight or loose as the weather changes. Soldered rail joints would be a disaster! I do not have any “loss of power” sections in the track because I make sure the rail joiners fit very tightly on the rails before I nail them down. Every joint has at least a 1/16” gap for expansion. So far, after five years, no issues!

**Rob Spangler:** I like to have solid rail joints, especially on curves and around turnouts. I do leave expansion gaps on straight-aways. My layout is in a climate-controlled space, so what I do is attuned to that environment.

A few thoughts:

- Moving rails back and forth, and pre-soldering before curving flex track, are ideas that don't work well with Micro Engineering or Shinohara track. They don't have a sliding rail.
- Getting smooth joints on curves seems to be a major source of consternation in the hobby, and for the life of me I don't see the mystery. Objects like files can be held against the rail to align a joint while soldering, and are safe to use without burning your fingers. Flow some solder into the joint. Get the metal tool ready and place it against the outside of the rail. Heat the joint again and hold it in alignment until the solder cools. Perfect joints every time, and you can place them wherever you want. Any place a section of rail ends, just add the next piece and keep going.
- Well-chosen rail joiners help a lot. Atlas code 100/83 HO joiners are too big for my tastes outside of the code 100 I use in staging, and Shinohara/Walthers have awkward shapes and don't fit that well. If you're using Micro Engineering rail, their joiners go a long way toward helping everything stay put. Atlas N scale code 80 joiners work great on most code

83 rail, including Atlas 83 if you chamfer the base a little first. They also work on code 70, and disappear readily after the track is weathered. Tight joiners keep the rail where it should be even if the joint isn't soldered.

- If you have to remove a turnout, heating the joiner and using the tip of a jeweler's file to shove it onto the adjacent rail is usually pretty simple. I'm fine with that as the cost of having soldered connections around the layout's most critical trackwork.
- Forget carving up plastic ties to go under joiners. Use stripwood that approximates dimensions of the surrounding track. In HO, 6"X8" material is a close match for Micro Engineering, Shinohara. It's slightly thinner so it slips under joiners without leaving a bump. It won't melt while soldering a joiner or feeder

**Michael A.:** If you have large temperature/humidity changes, solder your joints, and use Atlas flex track, alternate the loose rail. Atlas rail has one rail fixed tightly in the ties, and the other one slides easily. If you solder three sections together to form a nine-foot section and you solder all the fixed portions to each other, it is much more likely that track will kink. The rail can't move well even with expansion joints. If you solder a fixed section to a sliding section, the sliding rail can take up the expansion and prevent the kink.

When my layout was in a garage I found that if you lay your rail in hot weather, when the cold comes some expansion gaps may open so much they cause derailments. There's no substitute for good temperature control in a layout room. My layout is now in a (mostly) temperature-controlled basement, and the bench top is foam with cork roadbed. This has basically eliminated



expansion/contraction problems. But I still solder feeders to nearly every track section.

Read the whole discussion at [mrhmag.com/node/6783](http://mrhmag.com/node/6783).

## TIPS

### The Circuit Diagram

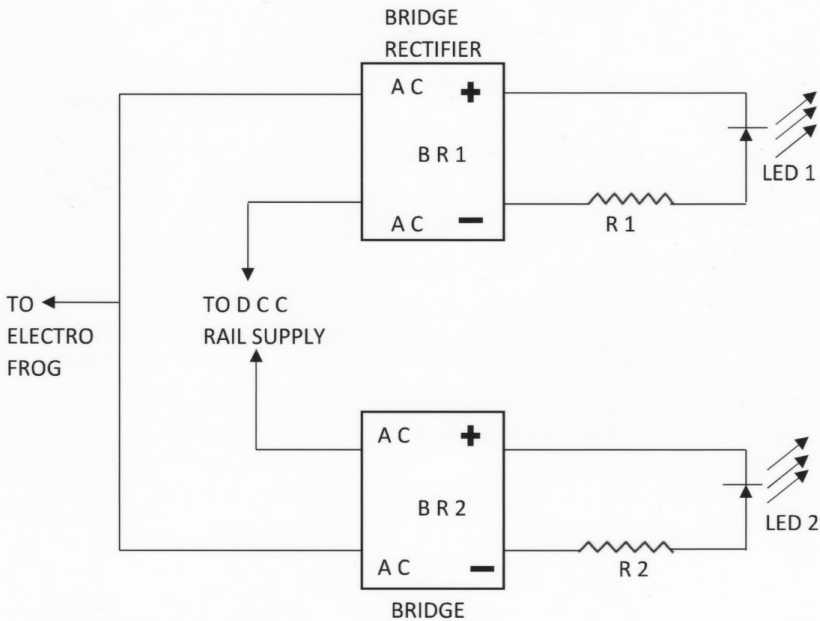

## Electrofrog turnout position indicator

Electrofrog switches change their electrical polarity to match the route through the frog by the contact of the moving point rail against the fixed stock rail.

Taking advantage the above polarity change of the Electrofrog, I designed a very simple electronic circuit to indicate the actual

position of the moving point rails. If the changeover is not complete (the moving point rail is not in contact with the fixed rail) the faulty condition will be indicated as well.

As you can see from the circuit diagram, I am not using transistors or micro switches. I soldered a wire to the Electrofrog, the same way you would solder the DCC supply wires to the tracks.

BR1 and BR2 are two low-power bridge rectifiers such as Digi-Key part no. DF005-ND [digikey.com/product-search/en?keywords=DF005M-ND](https://www.digikey.com/product-search/en?keywords=DF005M-ND). R1 and R2 are 1K resistors.

One of the LEDs will light up to indicate the selected route. During the transit (moving from one position to the other) both LED1 and LED2 will light up and will remain lit until the moving point rail comes in contact with a stock rail. If the moving point rail does not come in contact with the stock rail, both of the LEDs will remain lit, indicating a faulty situation.

Connect the wires from the DCC track supply and from the Electrofrog as shown in the circuit diagram. No extra power source is needed. This is a very simple and 100% reliable method of detecting the Electrofrog turnout functions.

—Sunil Fernando

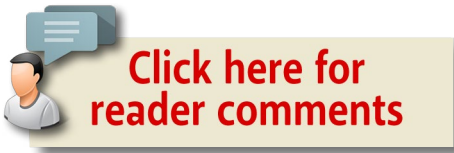

## 💰 GET PAID FOR YOUR TIP

We pay \$25 per tip we publish, or \$40 each if the tip also includes a photo or finished drawing. [Click here and select article type TIP.](#) ■



# NEW CORNERSTONE TURNTABLES- COMING IN OCTOBER!



- New interface for easier control
- One-touch 180-degree bridge rotation
- Programmable indexing up to 99 different tracks

[Click here for more information](#)

[Click here to watch the turntable in action!](#)

## **NEW** Cornerstone Motorized Turntable - \$349.98 each

HO Scale 130' - 933-2859

HO Scale 110' - 933-2851

HO Scale 90' - 933-2860

N Scale 130' - 933-2618

**WALTHERS**

Delivery and prices shown were accurate at press time, for updates visit [walthers.com](http://walthers.com).  
Preproduction models shown, some details and colors may vary. ©2016 Wm. K. Walther, Inc.

• INDEX

• TABLE OF CONTENTS

# From first train set to railroad empire...

*Our complete line of DCC products  
grows with you. Discover the fun!*

- Designed and manufactured in the U.S.A.
- Preferred for ease of use and ergonomic design
- Unlimited scalability for any size model railroad
- Plug-and-play means more time running trains
- Great customer service and excellent support



## See your dealer



## Visit our new and improved web site for all your DCC needs!

- Get the latest new product announcements
- Watch our detailed how-to videos
- Browse the all-new Information Station
- Enjoy secure online sales, day or night!

Visit **ncedcc.com**



# DC Railroaders...

## UNTIL NOW, THESE FEATURES WERE BEYOND YOUR WILDEST DREAMS.

- Run multiple locos simultaneously
- Choose from multiple sounds
- Wireless control of light, sound, direction & speed. 90' Range
- No complex programming or addressing. No DCC system to buy\*



## Introducing MRC's Loco Genie™

Experience these features on your layout for an MSRP of just \$79.98

To watch the Loco Genie video [CLICK HERE](http://www.modelrectifier.com/locogenie) or visit us at: [www.modelrectifier.com/locogenie](http://www.modelrectifier.com/locogenie)

\*If you already run DCC, or at a later date you decide to go DCC, Loco Genie's receiver-decoder works like a regular DCC decoder, and gives you the added advantage of wireless control.



MODEL RECTIFIER CORPORATION  
80 Newfield Ave. ■ Edison, NJ 08837 ■ Phone: 732 225 6360 [www.modelrectifier.com](http://www.modelrectifier.com)

TECHNOLOGY. PERFECTED.

- Model railroads
- Plastic model kits
- Battery chargers
- Radio control
- Scenery
- Die cast

• INDEX

• TABLE OF CONTENTS



# DCC IMPULSES

column

BRUCE PETRARCA MMR  
.....



[Click here for  
reader comments](#)

## FIVE YEARS OF *DCC IMPULSES*

**TIME FLIES WHEN YOU ARE HAVING FUN.**

*DCC Impulses* was born in October 2011. So this is a special anniversary edition – five years.

It will be a shorter column than it is in most months. That way, the time that you might normally spend reading this column will be available to read the story about “my club” elsewhere in this issue. *Railfanning the Great Lakes Western* gives a railfan’s view of operations on the layout I’ve been involved with for almost two decades now.

In July 2016, I was in northern Utah for a few weeks. I got to spend some time with the model railroaders there on a couple of Saturdays. The first event was a monthly division meet of the Northern Utah division of the NMRA ([northernutahnmra.org](http://northernutahnmra.org)). They asked me to discuss DCC at the meet. I chose to take questions from the floor, as opposed to making a canned presentation. One question was, “Where do you see DCC going in the next five years?”

▶ DCC TIPS, TRICKS, AND TECHNIQUES

# DCC IMPULSES | 2

Answering that on the fly was interesting and started me thinking that changes in the DCC industry would make a good topic for my fifth-anniversary column. By the way, I emailed many of the major players at DCC manufacturers, offering them a chance to share their ideas. None even replied. Guess they don't want to be pinned down.

I know that there will be areas of the sport, so to speak, that I won't cover in this column. Feel free to bring them up on the MRH forum. Just click the link at the beginning or the end of this column to be taken there.

### What's New

**Digitrax DT402D Throttle Firmware Revision 1.4 and RF24 Duplex Radio Transceiver Firmware Revision 1.0.**

This update improves the DT402D login sequences and overall performance on large installations using multiple UR92s and DT402Ds. This update is optional for users that are not experiencing any issues with their Duplex throttles. DT402Ds with any version of firmware will work together.

Follow the instructions provided to update your DT402D & their RF24s to the latest firmware. **DT402 and RF24 need to be downloaded for the installation to be successful!**

1. [Download Instructions Here](#) (PDF)
2. [Download the DigiIPL109 Utility Software](#). (Right-Click and Save As)
3. [Download DT402D R14 Firmware](#). (Right-Click and Save As)
4. [Download RF24 1.0 Firmware](#). (Right-Click and Save As)

**Zephyr Xtra Firmware Update, R2** Routine Update. We recommend that all Zephyr Xtras be updated with this code. '[Right Click' here](#) to download the .DMF file. (right-click and choose 'Save-As' or 'Save link/target As' to save to your hard drive.) *To update the firmware please use the DigiIPL109 utility that can be downloaded [here](#).*

**Zephyr Xtra Starter Set** DCS51 Command Station/Booster/Throttle  
Easy to Use All-In-One Unit.

**UR92 Firmware Update, R5** This code improves multi UR92 name sharing and operation. We recommend that all UR 92s be updated with this code. '[Right Click' here](#) to download the .DMF file. (right-click and choose 'Save-As' or 'Save link/target As' to save to your hard drive.) *To update the firmware please use the DigiIPL109 utility that can be downloaded [here](#).*

 **NO WORRIES WARRANTY**

**1 WARRANTY & REPAIR POLICY**

**2 RETURN PROCEDURES**

**3 WARRANTY & REPAIR FORM**

**4 NON-WARRANTY REPAIR PRICING**

**RADIO THROTTLE CONVERSIONS**

Please select your area for the proper conversion form.

**US/Canada/Aus/NZ**

**Europe**

**Everyone's Curious**  
What forms of block/train detection

1. In the fall of 2011, Digitrax was fine-tuning their new duplex radio system, as shown on their website at [digitrax.com](http://digitrax.com).



## DCC IMPULSES | 3

Here are some of my ideas, with apologies up front for errors and omissions. Before we look forward, let's look back.

### Remember five years ago?

In the spirit of The Earls' 1962 doo-wop hit, *Remember Then*, let's take a look back at where DCC was five years ago, when I started writing this column. Just to set the scene, I've been using the WayBack Machine ([archive.org](http://archive.org)) to look at manufacturers' websites in the fall of 2011. Let's see what memories they bring back.

Digitrax [1] was entrenched in their second versions of systems they had released earlier in the millennium, with their DT402 series of cabs and the Zephyr Xtra (DCS51), as well as the duplex radio system.

ADVERTISEMENT



## Fun Features for a Fraction of the Cost!

As the most versatile, feature-packed sound decoder, Econami redefines *value*. Starting at \$79.95 and available now!



Hear how you can get more for less!

SOUNDTRAXX®

# DCC IMPULSES | 4

ESU was transitioning their LokSound line from being a secondary USA-loco sound decoder to being a major force in DCC sound worldwide. They had recently released their flagship ECoS DCC system. I don't have a webpage image to share from the Wayback Machine. I can find some German pages, but the English version is incomplete there.

**HOME**  
**News** ›  
**Products** ›  
**Tech Info** ›  
**Manuals** ›  
**Dealer Contacts** ›  
**Support** ›  
**XpressNet**

New  
Lenz DIN Panel  
Option



This Express Net fascia panel can be used in conjunction with the LA152 or by itself. Like the LA152, the Lenz Din Panel can be connected by

**Welcome to Lenz USA**

**Digital plus<sup>®</sup>**  
**by Lenz**

**Unleashing the Power of DCC**

[Introduction to Lenz GmbH](#)      [Quality, Value, Performance and True Compatibility](#)

**News!**

- [New LZV200 and Ver. 4 Software](#)
- [Whats New 2011](#)
- [LI-USB Windows 7 Software and Drivers](#)
- [Controlling your layout with an iPhone/iPod](#)
- [New decoder SILVER PluX12](#)
- [Comming Soon! USB and Ethernet Interface](#)

2. Lenz ([lenzusa.com](http://lenzusa.com)) had moved from their long term importer (The Lenz Agency) to using American Hobby Distributors by late 2011.

# DCC IMPULSES | 5

Lenz [2] had introduced the Ver-4 software for their systems. This had them owning the first 5-amp system to embrace the revised NMRA standard (S 9.2.3), which had been approved a few months earlier. This allowed programming of any decoder with their system without a programming track booster.

As a precursor of things to come, Lenz was, I believe, the first major DCC manufacturer to encourage iPhone cab control.

My (Mr. DCC) website [3] featured an in-cab photo to showcase the realism of running your layout with DCC. This SD9 photo had been taken about a year earlier while making up a train in southern California.

ADVERTISEMENT

[www.SBS4DCC.com](http://www.SBS4DCC.com)

ESU TCS WOW Sound  
OSI Solutions ZIMO  
SOUNDTRAXX®  
NCE The Power of DCC DIGITRAX®  
DCC Specialties INNOVATION FOR DCC MRC Model Rectifier Corporation  
ACCUTRACK II SPEEDOMETER SPROG DCC the DCC Programmer and Control Family Digital plus by Lenz  
TAM VALLEY DEPOT Great Electronics for Great Model Railroads TEAM DIGITAL, LLC Improving the world of DCC

N - HO - HO<sub>N3</sub> Scale Trains

ADVERTISEMENT

IOWA SCALED  
ENGINEERING

Infrared sensors!

open source hardware

LEARN MORE >

• INDEX

• TABLE OF CONTENTS

# DCC IMPULSES | 6

Within a year and a half, my site design and appearance would change with a minor change in content.

NCE's Cab06 family was released in 2011. It has since become very popular, a favorite user cab.

Their PowerCab was on its way to becoming one of the most popular DCC sets ever. Rumor has it that NCE has by now sold over 70,000 units.

The DCC University!

Phone: 623-640-4060  
Bruce@MrDCCU.com

DCC Puts You in the Engineer's Seat

Photographed at Pacific Southwest Railway Museum  
Copyright 2010 Bruce Petrarca

### The DCC UNIVERSITY . . .

. . . arose out of the questions raised through 9 years of operating Litchfield Station and developing it from a small installation business to the second largest DCC specialty shop in the world.

In April 2010, Bruce sold the DCC dealership Litchfield Station, LLC. **The DCC University is no longer associated with that commercial enterprise and they are solely responsible for running their business.** However, there is still a cooperative relationship between us. Links have been provided from here to the Litchfield Station web site, for the convenience of folks who browse the DCC University!

Bruce is still available for DCC installations and consulting.  
[CLICK HERE](#) for more data.

**Understand, Bruce makes no profit on Litchfield Station sales.**

[CLICK HERE to be redirected to the Litchfield Station web site.](#)

Bruce and Linda took a vacation in Mexico just after we sold Litchfield Station - [CLICK HERE](#) to view the BLOG of that trip.

3. My website ([mrdccu.com](http://mrdccu.com)) was settling in with the intellectual property moved from the Litchfield Station ([litchfieldstation.com](http://litchfieldstation.com)) site.

# DCC IMPULSES | 7

NCE [4] also had a really fun video visit on their website. It was interesting to see the folks that we had only talked to, working in their native environment.

SoundTraxx [5] had the preeminent sound decoder line in its Tsunami. The Tsunami release had been delayed a couple of years while the industry sat out the results from the MTH vs. QSI legal wrangling. By 2011, that was behind us and the Tsunami was setting a standard for sound decoders that others were preparing to challenge.

Train Control Systems (TCS), in their first decade of business, built a reputation as a manufacturer of price-competitive decoders with good motor control. Five years ago, they were expanding

## ADVERTISEMENT

# Great control in a tiny package



- Touch Toggle™ plug in controls
- Bright clear indication
- Easy setup
- Flexible system

Stall Motors, Twin-coils,  
Power, and Servos

Now for Tam Valley Depot  
and MRservo too!

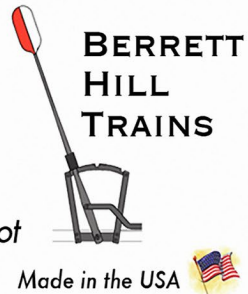

What will they think of next?

[www.berretthillshop.com](http://www.berretthillshop.com)

# DCC IMPULSES | 8

their loco-specific N decoders [6]. The WOW Sound decoders from TCS were to be a thing of the future.

## The plateau – coming of age

In the 1990s, DCC was not widely accepted and was used mostly in the realm of the electronic-experimenter modelers.

In the first decade of this millennium, DCC moved into the mainstream of modeling. Manufacturers went from ignoring DCC to including it in their locos. The average modeler became aware of DCC, even if they didn't personally embrace it.

The webpages presented earlier showed a glimpse of what was going on as the industry matured.

**NCE**  
The Power of DCC

Username    Remember Me  
Forgot your password?  
Password  [Create an account](#)

Home About Us Dealers FAQs Customer Care search...

**Main Menu**

- Home
- About Us
- FAQs
- Dealers
- Trade Shows
- Tips & Tricks
- Document Archives
- Customer Care

**NCE: The Power of DCC**

**How about a [video visit to NCE?](#)**

**The backlog of CAB06 and CAB06r orders has been filled to dealers and distributors** (21 Sept 2011) [manual here](#)

The CAB06 (tethered version) has already shipped.

[White Rose Hobbies](#) has done a video product review of the CAB06 [Click here to see it](#)

4. In fall of 2011, NCE ([ncedcc.com](http://ncedcc.com)) had just released their Cab06 family.

## SOUNDTRAXX

[Home](#) | [Company](#) | [Products](#) | [Dealers](#) | [Shows](#) | [Blackstone](#) | [Contact](#) | [Manuals](#) | [Support](#) | [Blog](#)

### Welcome to SoundTraxx!

SoundTraxx brings new dimensions in digital sound technology to your model railroad. Regardless of your scale or prototype, we have a sound system for you! SoundTraxx has been designing and manufacturing the latest in state-of-the-art sound systems for the discriminating model railroader since 1990.

This site contains information about and where to buy our products, upcoming shows and clinics where you can see us, accessories available to enhance your sound systems, and technical information. Be sure to bookmark our site to keep abreast of the latest developments at SoundTraxx.

If you are unfamiliar with our products, we recommend you visit Choosing the Right Sound System or our Company Overview. If you are already a SoundTraxx customer, visit our Products section or take a look at the Latest News.

Whether you are a seasoned customer or a newcomer to SoundTraxx, we're sure you'll find something to make your railroad sing!

#### ★ Dealer Training Week

The week of August 3 - 6 was dealer training week. Many of our dealers, featured in the photo below, came to Durango to attend classes taught by SoundTraxx staff, learn how to install our decoders into various models, and much more.

We want to thank everybody who took time out of their busy schedule to attend, both last week and in past years. Factory trained dealers are represented on our dealer page with a gold star.

### Latest News

**New! Accessory Lighting Decoder for Blackstone Models Long Caboose!**

**NEW! Sound Samples-EMD 567D Turbo, Dual EMD 567 (E Units), GE FDL-16 (Modern), and the ALCO 251C Supercharged**

**New! Gevo and SD70Ac Sound Samples!**

**New Decoder Selector!**

#### Products

*Tsunami TSU-750  
Tsunami TSU-1000  
Tsunami TSU-AT1000  
Tsunami TSU-GN1000  
Tsunami TSU-KT1000  
Tsunami TSU-BW1000  
Tsunami TSU-4664N  
PTB-100  
SurroundTraxx DSP-80  
DCC Mobile Decoder*

5. In late 2011, SoundTraxx ([soundtraxx.com](http://soundtraxx.com)) was in the middle of the product life cycle for their Tsunami series decoders and really coming up to speed on their Blackstone HOn3 product line.

## What's happened in the last five years?

In the sound decoder realm, the LokSound from ESU and the WOW Sound from TCS have risen up to challenge the Tsunami from SoundTraxx. QSI has become a player in the premium sound arena, too.

SoundTraxx responded with a new Econami line and a new flagship decoder line: the Tsunami2.

# DCC IMPULSES | 10

No new players have become household names in the DCC field.

Lenz' share of the market (at least in the USA) has diminished and MRC has come up to the point where "the big three" systems manufacturers in the USA are Digitrax, MRC and NCE.

Many of the earlier "major" announcements have not been the commercial success that the developers envisioned, such as "playable" whistles or SurroundTraxx.

The use of smart phones and tablets to control locos and layouts has moved into the mainstream.

## Where to from here?

It has been a long time since we have seen a major new product introduction in the DCC realm.

ADVERTISEMENT

### WAY TO GO, TRAINTEK!

*Already great prices  
and NOW ...*

**FREE SHIPPING  
ON ORDERS OF  
\$79 or more\***



**Start saving now**



\*some exclusions apply

ADVERTISEMENT

### TamValleyDepot.com

Great Electronics for Great Model Railroads



We are loading up the boxcars with Frog Juicers ready for your layout!

• INDEX

• TABLE OF CONTENTS



# TONY'S TRAIN XCHANGE

*Committed to your DCC support!*

## Intermountain HO GE ES44AC GEVO



BNSF, NS, & UP Now In Stock!

Excellent Detail & Smooth  
Operation. Available with  
ESU Lokpilot DCC  
or ESU LokSound

Starting at \$149.95

**Order Yours**

## DCC Specialties PSX-AR

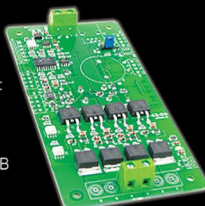

Available  
in 5 Versions:  
PSX-AR  
PSX-ARFB  
PSX-ARSC  
PSX-ARSCFB  
PSX-AR-AC

Integrated Circuit Breaker  
and Auto-Reverser

Starting at \$53.95

**Order Yours**

## NCE DCC Systems Super Sale!



Get a great sale price on all  
the impressive NCE DCC  
Starter Systems

**Order Yours**

**Do you need a Sound or  
DCC Installation done?**

**Get a quote!**



Providing unmatched person to person  
DCC support for more than 25 years, the  
kind of service that has made us #1 in DCC.

**DCC questions? CALL US! 1-800-978-3472**

*We'll get you on the right track!*

Oct 2016



# Get Better Sound from your Locomotives

Can't get a good sound from your sound decoder?  
Give our speakers a test drive with your ears.



**RAILMASTER HOBBIES**  
**9812 BELMONT**  
**BELLFLOWER, CA 90706**

Bass Reflex  
Speakers



High Bass  
Speakers



When it comes to speakers we have high quality speakers to fit many different applications.

We are also a full line hobby shop. Need anything? We are an authorized dealer for Soundtraxx, Digitrax, Athearn, Walthers and many others. We provide quality speakers for your DCC sound systems and quality service.

**Click here for  
the answer ...**

# DCC IMPULSES | 11



**TCS** Train Control Systems is the leader in DCC Decoder Design.

Welcome To TCS

Manufacturers of high quality DCC decoders.

Check out our Installation Pictures section for hundreds of DCC decoder installations in tons of HO-Scale, N-Scale, and Z-Scale locomotives!

**New Decoder For the Upcoming Kato N-Scale MP36ph Metra!**



We are excited to announce the release of a new decoder: The K4D6. The K4D6 is a Six Function, Drop-In decoder for the N-Scale, Kato MP36ph Metra.

Place your pre-order [HERE](#) and receive yours as soon as they begin shipping.

- What's New
- Product Line
- Order Page
- Warranty
- Installation Pictures
- Videos
- Manuals
- DCC Help
- TCS

6. TCS ([tcsdcc.com](http://tcsdcc.com)) was becoming firmly entrenched as a non-sound decoder manufacturer, as can be seen on their October 2011 web page.

Yes, newer and better and smaller decoders with better sound get announced with regularity. Mostly, they come out at about the same price as their predecessors. The “new decoder with fantastic features at half the price of the one it replaced” was part of the first decade of DCC.

Similarly, in the DCC system area, prices have been stable to increasing slightly. In DCC, a big run is a thousand units or so. Apple builds about 100 million iPhones a year. The DCC industry just doesn't have the volumes to pay back development costs and reduce prices year over year.

These are all markers of a plateaued industry. Sometimes industries come off the plateau and move to new heights. Sometimes they begin a decline. Other times, such as the auto industry, they bounce along for decades at that plateaued level.

What would drive the DCC industry to new heights? I believe it would be something that finally takes all the geekiness out

of DCC. Getting rid of terms like “CV” and “programming” and “bits” are necessary to increase the user base. A system that could interface all decoders and throttles and not require the (sometimes steep) learning curve would be nice.

Is this possible within the NMRA definitions of DCC? I don't know. If I did, I'd be doing it.

After 30-plus years of personal computers, we still have the PC vs. Apple fight. And that is with hundreds of millions of units sold. What are we, in the DCC world, going to do with a few thousand units being a big run?

### **Aging principals and succession plans**

There are very few players in the DCC world that are affiliated with large corporations. Most are headed by an engineer or an entrepreneur for whom DCC is a passion. Most of these companies have been the primary focus of these principals for a quarter-century or so. I'm seeing these players become more and more interested in spending time with their families and friends.

Some firms are working on succession plans. It was announced that Evan Rimmel has come into Digitrax as director of operations and a shareholder in the company. JD Forsythe, son of TCS founder John Forsythe, has come into the business there.

Other firms seem to have no succession plans. Absent these plans, I see some of the businesses who currently are major players having a diminished presence over the next five years. Perhaps, even out of the business entirely.

### **New technology may change DCC**

Last year (2015) the NMRA finalized the specifications for Layout Command Control (LCC). LCC is a new format for the bus to

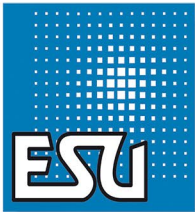

***Tired of tearing apart valuable locomotives every time a new decoder is released?***

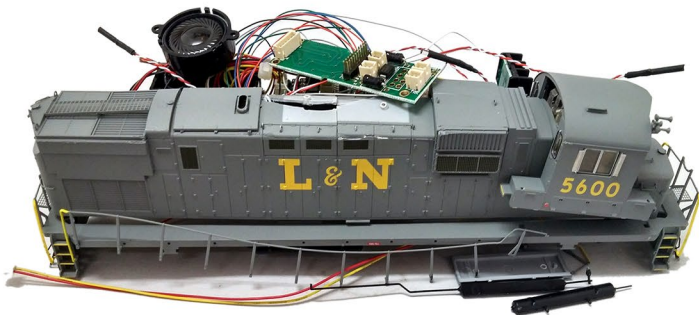

**ESU decoders are re-programmable!**

ESU LLC

23 Howard Street, Montoursville Pennsylvania 17754

Phone +1 570-980-1980, Fax +1 866-591-6440

(Office hours: Monday through Friday, 8AM to 4PM (EST))

[WWW.LOKSOUND.COM](http://WWW.LOKSOUND.COM)

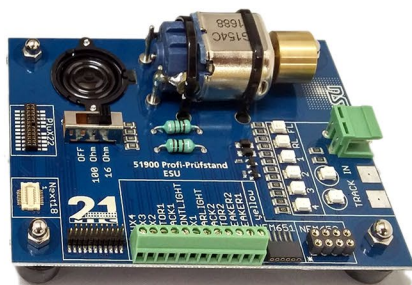

(June 1st - August 31st)

**#53452 LokProgrammer - **SUMMER SALE** \$150 list!**

**#51900 - Decoder Tester - \$57.90 list**

***BUY IT ONCE & UPDATE IT FOR LIFE!***



S T A T I O N

Model Railroad Technologies  
Accutrack Speedometer 2

NCE  
The Power of DCC

DiGiTrax  
Complete Train Control

Tsunami 2

LOKSOUND  
SELECT

TRAIN CONTROL  
SYSTEMS

Wow!  
Only \$64.95



ACCUTRACK II  
SPEEDOMETER

MRT  
Model Railroad  
Technologies

Off On

SETUP  
MPH  
KPH

- Click here to visit our website -

[www.LitchfieldStation.com](http://www.LitchfieldStation.com)  
623-298-7355

## DCC IMPULSES | 13

control all the things within your layout: turnouts, signaling, audio (telephone), video, etc. LCC doesn't require or compete with DCC. It coexists with DCC (or whatever locomotive control system you choose). The concept is to improve DCC bus response by providing an alternative path for things that are taking up bandwidth on the DCC bus.

How the DCC manufacturers respond to LCC has yet to be seen. There may be some major synergy here that folks have yet to explore. For more information, see my November 2015 column, "*What's up with LCC?*" ([mrhmag.com/magazine/mrh-2015-11-nov/di\\_whats-up-with-lcc](http://mrhmag.com/magazine/mrh-2015-11-nov/di_whats-up-with-lcc)).

Dead track, on-board power, and dead rails are all names for a concept where the train carries its own power. It is controlled more like an RC car or plane than the way we are used to controlling our trains, namely through the track. Many forms of this can coexist with DCC, sometimes charging the batteries onboard from the DCC power in the track and sometimes using an existing DCC system for the operational commands. This technology may eventually replace DCC. See my March 2016 column, "*Is DCC dead?*" ([mrhmag.com/magazine/mrh2016-03-mar/dcc-impulses](http://mrhmag.com/magazine/mrh2016-03-mar/dcc-impulses)).

### Doom and gloom?

Not at all. I'm continuing to build my indoor HO layout with DCC and convert DC locos to run on it. I fully expect to run this layout with DCC for the rest of my modeling lifetime.

I *am* experimenting with dead track in the garden. But I was only driven in that direction due to the extremely high costs of nickel silver rail for the garden track. I have almost 300 feet of brass track and over 20 turnouts down. But right now, dead track is about where DCC was in the 1990s. It is mostly electronic experimenters who are working with it. I'm one of those experimenters.

# DCC IMPULSES | 14

Folks always seem to have additional ideas to share. I hope this column stirs some creative juices. Just click on the Reader Feedback icon at the beginning or the end of the column to go to the MRH forum about this column. While you are there, I encourage you to rate the column. “Awesome” is always appreciated. Thanks.

Until next month, I wish you green boards in all your endeavors. ✓



**Click here for  
reader comments**

## ADVERTISEMENT



**NEW TECHNOLOGY**



**RE RING™**  
ENGINEERING  
RailPro™  
Power ON  
Main Page  
Handheld Controller Model # HC-2

Control Locomotive (C) Link Forward

17.6%

UP 5714

Info

Next Page 1

Exit Page

Front Light Ditch Ditch Pop Off

Horn Bell Engine Back Light



**NEW Starter Kit**  
**\$399.99 MSRP**

- Includes Wireless Color Touch Screen Handheld Controller and 56 Watt Power Supply
- Expandable to Virtually any Size Layout

**NEW Locomotive Module**  
LM-2 & LM-2S

- Direct Radio RF
- Sound and Non-Sound
- New Tiny Size
- 6 Light Outputs

**Click Here to Learn More**

For more information visit our Internet site: [www.RingEngineering.com](http://www.RingEngineering.com)





# Southern Digital



**20% Discount  
on most Items!**

*Specializing in DCC Since 1992*



## DCC Conversions, Service & Support

Orders Received by 3:00 pm EST ship the same day

**WWW.SODIGI.COM**

E-mail: [sales@sodigi.com](mailto:sales@sodigi.com)

(770) 929-1888

*(Photo's are from our N-Scale layout)*

# Digitrax



**\$375.00 MSRP**

- **400 Loco Addresses**
- **5 or 8 Amps of Power**



Introducing

# DCS240

LocoNet® Advanced  
Command Station



- **400 Throttle Support**
- **For Serious Operation!**

Find out more at:

[www.digitrax.com](http://www.digitrax.com)

# END OF TRAIN DEVICE

**NEW ORANGE CASE!**



**Patented Technology - US Patent 7,549,609**

**Bright Red  
Flashing Light!**

**Installs in minutes!  
No freight car  
modification required!**

**RE RING  
ENGINEERING**

**Click Here to  
Learn More**

**Does not affect Load!**

↓ **Car without Load** ↓



↓ **Car with Load** ↓



**Make LocoNet wiring extremely simple!**

**ACCU-LITES, inc**  
Your DCC Center!



**Suitcases belong in your baggage cars,  
not under you layout!**

**Introducing the DCC Vampire II ...  
this guy does the job of two suitcase  
connectors!  
And really holds the connection good  
too!**



**CLICK NOW TO DISCOVER THE AMAZING VALUE!**

Dealer Inquiries Accepted

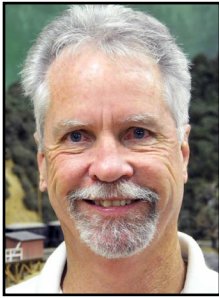

# GETTING REAL

column

JACK BURGESS  
.....



[Click here for  
reader comments](#)

## HOT BOXES

**WHEN I DESIGNED MY YOSEMITE VALLEY RAILROAD** layout 35 years ago I assumed that some day I would finish building the layout and then begin formal layout operations. Therefore, one of my design goals was to make sure that the layout would be fun to operate. Toward that goal, all of the yards and sidings duplicate the prototype YV yards and sidings as closely as possible, and passing tracks are spaced far enough apart that trains could actually travel from station to station without having the caboose still short of the last station stop.

However, I will readily admit that I enjoy building models more than operating my layout. I don't have a dedicated train crew and the modelers who do get to operate the layout are most often first-timers.

When layouts are operated by the same operators on a regular schedule, discussions sometimes center on how to deal with boredom from the constant repetition. One solution often mentioned is to add situation cards which add delays

▶ [MODELING REAL RAILROADS AND WHAT THEY DO](#)

## GETTING REAL | 2

such as maintenance of way issues, accidents, and special car movements.

Prior to the general adoption of freight car trucks with roller bearings, hot boxes were a common occurrence which could cause delays. A situation card could specify that a certain car needed to be set out at the next siding. But how many of us know what a hot box was, what caused it, and how it was handled?

### Basic freight car truck design

To understand hot boxes, we first need to understand freight car truck design. The early arch bar and Andrews trucks had separate journal boxes which bolted to the truck side frames.



1. A prototype wheel and axle. The larger diameter section on the end of the axle is the “journal collar” while the portion of the axle next to the wheel with the same diameter is the “wheel seat.” The axle bearing surface is the portion of the axle between the journal collar and the wheel seat. A

“dust guard” slides over the journal collar and wheel seat to fit up tight to the wheel. Note that the rust on the bearing surface between the journal collar and wheel seat is not a problem and will be removed with fine sandpaper before the wheelset is placed in service. These are narrow gauge wheelsets but their design is identical to standard gauge wheelsets.

The ends of the axles rode below plain brass or bronze bearings in journal boxes, which is why these trucks were called “plain bearing” trucks. Cast steel trucks were eventually developed with integral journal boxes cast into the side frames but retained the same basic journal box design.

The journal boxes held oil to lubricate the axle bearing surfaces [1]. The back of the journal boxes extended up just short of the axles and the lubricating oil level in the journal boxes was kept below the bottom of the axles in minimize leakage. There were “dust guards” at the back of the journal box around the axle which were designed to keep dust out of the journal box. These dust guards were typically made of a thin piece of wood with leather, felt, or another material in contact with the axle.

### ADVERTISEMENT



# Rusty Stumps

Scale Models

WE ONLY SELL WHAT WE MANUFACTURE

## DETAILS

IN HO, O, S  
& N SCALES

LASER CUT SHINGLES, DOORS & WINDOWS,  
FENCES, SIDING, CRATES. Also RESIN and  
WHITE METAL DETAILING CASTINGS.

## CRAFTSMAN KITS

IN HO, O & S SCALES

CHECK IT ALL OUT AT  
[WWW.RUSTYSTUMPS.COM](http://WWW.RUSTYSTUMPS.COM)

Send \$3.50 for Catalog - Specify Scale

### RUSTY STUMPS SCALE MODELS

6785 Cherry Blossom W. Dr., Fishers IN 46038

Phone (317) 595-9489

## GETTING REAL | 4



2. Looking into a narrow gauge arch bar truck journal box with the journal box lid raised. The oily waste below the axle bearing surface is visible, as is the axle journal collar. Directly above the axle is the plain bearing.

The lubrication system relied on the oil in the waste to migrate along the entire surface of the axle bearing surface, and that the waste itself not be caught up. As shown, the waste needs to be in contact with the lower portion of the axle in order for oil to coat the axle.



3. Looking up in the journal box toward the bearing. The actual contact surface between the bearing and the axle can seem small, but it covers the entire top surface of the axle and transfers the weight of the

freight car to the axle. Bearings are made of bronze with a thin, smooth layer of Babbitt metal on the curved underside. This particular bearing is cast in Babbitt rather than machined from brass or bronze due to the none-demanding service for this car. Babbitt is an alloy made up of small hard crystals dispersed in a softer metal. As the bearing wears, the softer metal erodes somewhat, which creates paths for lubricants to migrate between the hard high spots that provide the actual bearing surface. Babbitt was originally composed of tin, antimony and copper.



# iwata

by ANEST IWATA

## Be Realistic

From weathering broad areas to painting concentrated details, an Iwata airbrush gives you precision and reliable performance for a natural, smooth finish.



Iwata Eclipse CS



NEO for Iwata TRN1



**iwata**  
**MEDEA**  
ANEST IWATA-MEDEA Inc

PRODUCTS  
**ARTOOL**  
COMPANY, INC.

*Locomotive from Alan Houtz, North American Prototype Modelers*

*Click to see the entire line of Iwata Airbrush and Artool Products*

• INDEX

• TABLE OF CONTENTS

Lubrication of the contact surfaces of the axles and the bearings was accomplished by adding “waste” in the bottom of the journal boxes [2, 3]. Waste was a fibrous cotton material which would soak up the lubricating oil. The proper amount of waste in a journal box was when the waste was about even with the middle of the axle. Capillary action (such as when a paper towel will wick a water spill by just touching it slightly) would result in oil saturating all of the waste, thus directly coating half of the axle and lubricating the entire bearing surface [4, 5].

According to early industry publications, hot boxes could result from the type of lubricating oil, lack of adequate lubricating oil, or even too much dust and metal particles in the lubricating oil due to wear on the bearing surfaces — a problem which could be minimized by replacing both the waste and lubricating oil often. The oil level in journal boxes was regularly inspected and topped off when needed. A July 1890 issue of the *Railroad and Engineering Journal* outlined the problem as follows:

“Perhaps no subject connected with the operation of railroads causes more annoyance, not only to the public but also to the operating officers, than what are known popularly as hot boxes. In reality it is the journal and bearing which get hot, and not the box which encloses them, and carries the waste and lubricant. Much delay of trains and annoyance in every way is occasioned by these failures of the journal and bearing to run cool, and many speculations have been indulged in as to what the cause of hot boxes, using the technical term, is and what is the best cure.”

Those speculations resulted in a number of “best remedies.” Some suggested adding special lubricants in the journal boxes such as tallow in the form of candle wax or special greases. Lacking a solution to eliminate the problem (except for more inspections

## GETTING REAL | 6

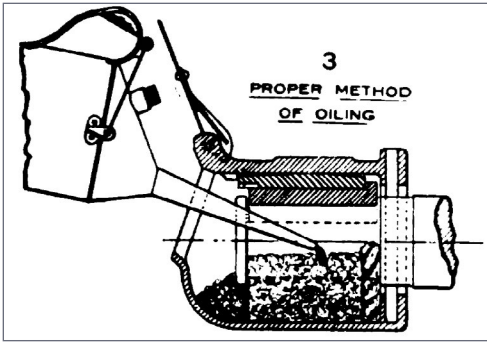

4. This illustration is from the July 1907 issue of *Railroad Men* and accompanied an article on journal box lubrication. It shows a cross-section view of an open journal box, the axle, waste, and an oil can being used to add oil. A caption on the

illustration reads “When using the oil can, oil should be placed on side of the journal. When saturated packing is used, it should be placed in contact with the journal.”



5. Not only oily lubricants but also waste are leaking out of the back side of this journal box. The leaking oil has also covered the area adjacent to the rim of the wheel. This freight car, in service on the narrow gauge South Pacific Coast RR at Ardenwood Historic Farm in Fremont, CA, only runs about 6-8 mph. It is easy to see how standard gauge freight cars in service in the 1920s and beyond could have the entire face of the wheel covered with lubricating oil.

## GETTING REAL | 7

and maintenance) ultimately lead to special devices to address hot boxes after the problem occurred. One was patented in March 1912 [6] and was reported in the December 1913 issue of *Popular Mechanics* as follows:

“Several railroads have recently adopted a new safety device for cooling hot journals on railway cars without crystallizing the metal. Ordinarily when a car develops a “hot box,” the train crew puts out the fire and cools the journal by throwing cold water on it. This usually crystallizes the metal and sooner or later the journal “burns off” and perhaps causes a wreck. But the real cause of the hot box is a rough place in the journal or the brass above it and the best way to treat it is to cool it slowly until the journal runs down to a proper bearing. The new device accomplishes

this by dripping water on the hot journal while the train is running. It is hung on the car in such a way that the heat of the journal and the motion of the train keeps it from freezing [during cold weather].”

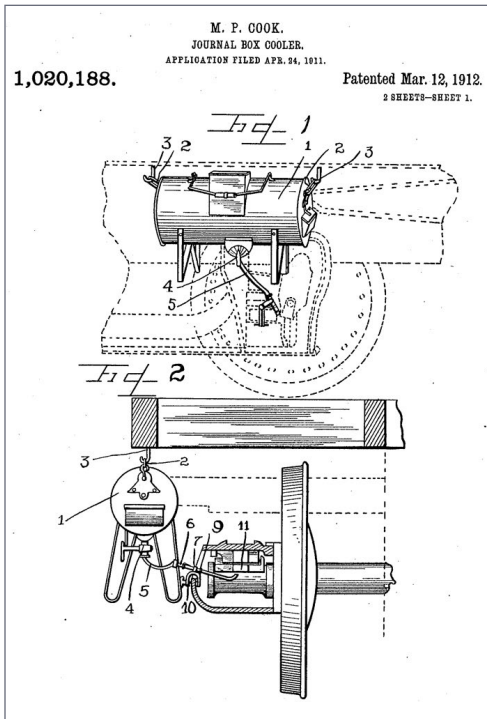

6. M.B. Cook patented this Journal Box Cooler in March 1912. The device had a tank for the water (1), hooks to allow it to be attached to a grab iron (2), and a hose and clamp which allowed the nozzle to apply water directly on the underside of the axle.

## The Keeley

That “journal box cooler” eventually became known as a Keeley. A brakeman friend who worked on the YVRR in 1942 once explained the problem in an interview many years ago and how the device became to be known as a Keeley:

“The YV had plain bearings in all of the cars and when you’d have a hot box or one that is warming up, you’d hang what you’d call a Keeley on the car. This was a tank with water in it and it had a hose and you’d just open the journal box lid and fasten the hose in there and it would just kind of drip in there and keep that sucker cool enough so that you could get to some place to set it out or take it into Merced Falls that way.

ADVERTISEMENT

### Checked us out lately?

- ☑ HO/N and now O scale products too!
- ☑ Laser-cut Structures & Bridges.
- ☑ Advertising & Storefront Signs.
- ☑ Highway Signs, vintage & modern.
- ☑ New Detail Items.
- ☑ Laser-cut Grade Crossings.
- ☑ Billboards, roadside & rooftop.
- ☑ Laser-cut Graffiti Decals
- ☑ 1000's of satisfied customers.

WHAT'S  
NEW?



Established 1993...

**Blair Line**

ADVERTISEMENT

NICK & NORA DESIGNS  
Uniquely inspired craftsman kits



Craftsman Structure Kits,  
Detail Parts, Shingles & More!  
[www.nickandnoradesigns.com](http://www.nickandnoradesigns.com)

“It looked like one of these tanks that you carry air in for airing up tires when you are far from an air pump. It was hung right off of a grab iron and I suppose that it was 2 to 3 foot-long and 10 inches in diameter and it had this rubber hose on it. You’d just hang that thing in there and keep things cool.

“I just figured that the Keeley was made by the Keeley Company some place. After the war [WW2], I had to go and take a physical after I was discharged. They sent me to Dwight, Illinois. I went there and, by gosh, there was the Keeley Institute. I wondered, what in the hell is this?

It turned out that the Keeley Institute was a ‘drip’ rehabilitation deal back in the early days! There was a water cure and so I think that this tank got the name Keeley because that was the popular way to cure somebody [of addiction]. I don’t think that it was made by the Keeley Company at all. I think that it was just a clever name they hung on it.

“I remember one time they burned an axle so bad that we had to change the wheels. That is hard to do on a boxcar with cast trucks. With arch bar trucks it’s not too bad — you can just drop the bolts and pull the journal boxes and the whole works out. With a car with cast trucks, you can’t do that out in the field — you’d have to go out with a wrecker and put a new truck on it.”

My friend’s reference to Keeley was somewhat close to the actual facts, although it didn’t actually involve a “water drip regimen.” In 1880 Dr. Leslie E. Keeley opened a sanatorium in Dwight IL for persons addicted to alcohol or opium. The “Keeley Cure” was a bottled concoction which became known as the “gold cure” which was taken with volumes of water. Although Keeley was regarded as a quack, he eventually opened nearly 100 franchises



7. A journal box cooler, or Keeley, on display in the Lomita Railroad Museum behind a collection of tie date nails. The opening on the top is the fill spout. The filler is two inches in diameter and the legs are six inches long. There are simple handles on both ends for carrying the Keeley along with chains to hang the Keeley from a grab iron.

throughout the United States. He also became the subject of vaudeville jokes about the cure which had somehow morphed into dripping water on someone who was addicted. That is likely how the name was appropriated for many “curative” processes for other than addiction — including railroad car journals.

The Lomita Railroad Museum in southern California has a Keeley (although labeled as a Keeler Cooler) on display. [7 and 8] It is 24 inches long and 10 inches in diameter which matches dimensions of a Southern Pacific Railroad drawing of a “Journal Box Cooler.” That drawing is in Tony Thompson’s *Southern Pacific Freight Cars Volume 2: Caboose*.



8. The red delivery hose tank on one end of the Keeley is connected to the outlet pipe and valve at the bottom of the tank. The hose is 30 inches long and terminates at the long nozzle and clamp which is hanging on the handle. The clamp let a brakeman attach the nozzle to the front lip of the open journal box and aim the cooling water directly on the hot axle.





9. Southern Pacific caboose No. 78 has a Keeley hanging on hooks near the front truck, ready to be taken off and carried to a car with a hot box. *Tony Thompson Collection*

Although I have no photos of Keeleys hung on hooks on YV cabooses, many SP cabooses were fitted with hooks for just this purpose. A photo of SP caboose 78 taken at Santa Cruz, California in 1935 shows a Keeley hanging above the front truck [9]. Many SP tenders also had hooks to hang Keeleys.

So how did the YV respond to hot boxes? They did have Keeleys in their cabooses. A dispatcher sheet from August 2, 1939 lists a hot box incident on the westbound El Portal Local, running as an extra. The hot box was noticed at around 9:15 p.m. as shown on the dispatcher sheet [10]. The entry reads “MP 43 915P 935P hot box yv 1209”. That translates to “Delay at mile post 43 from 9:15 p.m. until 9:35 p.m. on account of a hot box on rock car YV 1209.”

YV 1209 was one of 51 ex-Northern Pacific Railway hopper cars (called rock cars on the YV) purchased by the YV in 1924.

# GETTING REAL | 13

| El Portal Local |                                          |
|-----------------|------------------------------------------|
| Ro              | 515P 540P yard                           |
| By              | 545P 555P Plu                            |
| Mc              | 6p 610p water turn                       |
| En              | 615P 625P Plu                            |
| Em              | 650P 705P Plu + mase                     |
| B               | 825P 856p No3 water <sup>inspect</sup>   |
| MP43            | 915P 935P hot box yr 1209                |
| Det             | 945P 10p Comm <sup>water</sup>           |
| B               | 1025P 1110p lunch <sup>inspect plu</sup> |
| Em              | 1215a 1240a water slo mase               |
| En              | 105a 130a slo mase                       |
| Mc              | 135a 140a water                          |
| By              | 145a 155a slo plu                        |
| Ro              | 2a 230a yard                             |

10. The Yosemite Valley dispatcher sheet log entry for August 2, 1939 for the westbound El Portal Local shows a "hot box" at MP (Mile Post) 43, which was between the first listing of Bagby (B) and Detwiler (D). As mentioned in my article on dispatcher sheets in the April 2014 "Getting Real," YV locals traded crews at their meeting point so the dispatcher reported actions based on the crew and not the train number. That delay started at 9:15 p.m. and lasted until 9:35 p.m. The next trailing point spur west of the mile post 43 was at mile post 39.1 (Jasper).



11. YV 1216 was one of 51 ex-Northern Pacific hopper cars purchased in 1924. It was identical to YV 1209. Rock car 1209 would have been loaded with 40 tons of limestone when the hot box was noticed.

[11] These cars hauled limestone from a quarry 67 miles east of Merced to a Portland cement plant a couple of miles east of Merced. As such these cars were rarely moved beyond these two locations and may have not received timely journal box lubricant maintenance. That lack might have been the cause of this hot box.

During the 20-minute delay listed by the dispatcher, the brakeman hung a Keeley on the car to cool the hot box. Based on the dispatcher sheet for that day, the hot box was on one of nine loaded rock cars picked up that night along with 17 loaded log cars and seven other freight cars. The short rock cars would have been placed in front of the cabooses. But it would have taken time to find the hot box and take the Keeley to it and set it in place — hence the 20-minute delay. Once the Keeley was in

place and the brakeman back in the caboose, the extra continued west and met the eastbound Merced Local at the passing track at Detwiler just a mile away. After that meet, YV 1209 was set out at the next trailing-point spur at mile post 39.1 at Jasper.

From the entry shown on the dispatcher sheet for the following day, August 3, [12] YV 1209 was picked up that day by the eastbound Merced Local. There are no entries on the dispatcher sheet for that day listing an extra train dispatched to change out the journal box on the car so the crew may have simply added lubricating oil to the journal box, filled up the Keeley hung on it the previous night, and brought it in for inspection and repairs if needed.

Years ago, I thought that hot boxes were only caused by a piece of waste being pulled up from the journal cellar box only to be caught between the axle bearing surface and the bearing. But, from period literature, it seems that poor maintenance was the primary cause of hot boxes.

## Detection

One final question ...how did the crew notice a hot box?

Smoke might be visible during daylight hours,. There was also the smell. Warren McGee, a Northern Pacific Railway conductor, talked about hot boxes in an issue of the Northern Pacific Railway Historical Association *Mainstreeter* magazine and mentioned:

“At night you opened the window [in the caboose] in every cut and every narrow channel, between cars, anything, you got your head out the window and you smelled for that hotbox up there, ‘cause it was a different smell. You had your nose and

## GETTING REAL | 16

.....

|         |                      |
|---------|----------------------|
|         | Merced Local         |
| CS      | 6p 610p yard         |
| In      | 655p 705p 10         |
| m 7     | 725p 815p yard       |
| Barnett | 905p 925p no 3 lunch |
| Let     | 945p 950p connection |
| Jasper  | 10p 1010p flu        |
| m 7     | 1120p 1240a yard     |
| In      | 1a 115a pu + andre   |
| CS      | 210a 235a spot road  |
|         | 240a 4a yard         |

12. The dispatcher sheet log entry for the following day, August 3, 1939, for the westbound El Portal Local shows the pickup (p/u) at Jasper between 10:00 p.m. and 10:10 p.m. That would have been YV 1209.

your eyes going all the time. When it's dark you had nothing but that. Usually, maybe 15 cars ahead of the caboose was all you could smell, but I once smelled a car 43 cars ahead, coming west against the wind.”

To reduce the occurrence of hot boxes, there were car inspectors at division points to check the lubricating oil level in all of the journal boxes of trains headed out. But one early report mentioned that, when there were too many arriving and departing trains for inspections, that practice wasn't always followed. On the YV, foreign cars might travel only 150 miles before being returned to

either the SP or ATSF so hot boxes on cars from interchange railroads might not have been that much of a problem for the YV. But the majority of YV cars, both rock cars and log cars, continually ran between intermediate stations on the railroad so hot boxes from those cars might have been more frequent.

For other railroads, especially those which handled mostly interchange traffic, hot boxes were a real and costly problem until the wholesale conversion to roller bearings eliminated the problem. ✓



[Click here for  
reader comments](#)

**Want to help keep  
MRH free?**

**Then *click* on ads!**



**ONE HUSKY STACK**  
***TWO CONTAINERS***  
**50 BUCKS**

**HO SCALE**  
**CLICK HERE FOR INFO**

# INTRODUCING FAST TRACKS

AWESOME NEW WEBSITE  
HANDLAIDTRACK.COM

Over 5000 tools,  
ties, templates, fixtures,  
supplies, and more.

Easy ordering

Live online support



Earn Waypoints

with every purchase

shop online 24/7

[handlaidtrack.com](http://handlaidtrack.com)



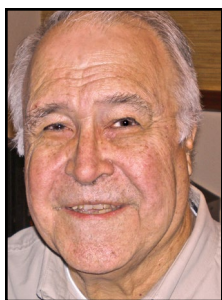

# LITE AND NARROW

column

LARRY SMITH  
.....



[Click here for  
reader comments](#)

## THE TWIN MOUNTAIN AND POTOMAC. RAMBLINGS ON NARROW GAUGE, SHORTLINE, AND BRANCHLINE MODELING | A VERY SHORT-LIVED EASTERN NARROW GAUGE

**IT ALL BEGAN WITH DUMPSTER DIVING. WHAT** began with dumpster diving, you ask? My interest in The Twin Mountain and Potomac, a little-known narrow gauge railroad that existed in Eastern West Virginia.

The story starts in the mid-1970s when my former brother-in-law, Richard Booth, was working in the American Car and Foundry car shops in Huntington, WV. The company he was working for had been contracted to do some plumbing work at the plant. While going between buildings, Richard noticed a bunch of old portfolios lying on the ground next to a dumpster. Curious, he opened them and found builder's photos and spec sheets for numerous freight cars. Grabbing as many as he could,

▶ [RAMBLINGS ON THE NARROW GAUGE](#)

## LITE AND NARROW | 2

he carried them to his truck, left them there and returned to work. Later he gave them to me.

When I started through the portfolios, I discovered a vast amount of information. In addition to the builder's photos, there were spec sheets with all of the measurements of the cars including the various components used in building the cars. There was also a color chip of the original paint used on the cars. Most were black, but others were red. The latest built date was for C&O hopper cars in the 1930s. In addition to the hopper cars were Russel log cars (also known as skeletons), sugar cane cars, and boxcars. Among the portfolios were two for the Twin Mountain



1. Construction train on the TM&P showing the 0-4-0 Potomac Construction locomotive #1. The "dinky" and crew were photographed between Barksdale and high trestle. Note the homemade number on the locomotive. *Philip Miltenberger collection, published in the March 1987 Light Iron and Short Ties*

## LITE AND NARROW | 3

and Potomac Railroad, one for boxcars and one for gondolas. Having never heard of the railroad, I began my search for more information on the line, only to be interrupted by a job change and moving 500 miles.

Let's look at what I discovered about the railroad and see why it would make an interesting model railroad, even today using small diesels and secondhand equipment.

### Birth, life, and death

The Eastern panhandle of West Virginia is noted for its fruit orchards, namely apples and peaches. Legend has it that Johnny Appleseed (John Chapman, September 26, 1774 – March 18, 1845,) was the one who started all of the apple orchards in West

ADVERTISEMENT



**GLXSCALEMODELS.COM**



# OIL LANTERN KIT

**1/48  
SCALE!!!**

**\$19.99  
+ S&H**

**12 VOLT POWERED LED LIGHT**



• INDEX

• TABLE OF CONTENTS

## LITE AND NARROW | 4



2. Construction of trestles on the TM&P and workers. *From the internet, source unknown.*

## LITE AND NARROW | 5

Virginia. While no one knows if this is true, there are many varieties grown throughout the state. It was this desire to get the fruit to market that drove the building of the Twin Mountain and Potomac Railroad.

Keyser, West Virginia is the county seat for Mineral County and is located along the South branch of the Potomac River and the border of Maryland. The area was first settled in 1736 but remained remote, with access to the area very difficult. The town's first name was Paddytown, more-or-less honoring Patrick McCarty, who, with his associates, operated an iron furnace and foundry near the mouth of Wild Cat Run. With the deposits of iron ore found in the region, other iron furnaces were established. The ruins of these furnaces can be found today around

### ADVERTISEMENT

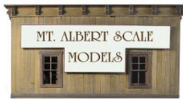

**COMING SOON  
IN HO SCALE!**



**We plan to produce an HO Scale version of our very popular Mt. Albert Lumber Yard kit later this year. Please watch our website and Facebook page for more details.**

**Please include  
a phone  
number when  
contacting  
MRH  
(in case your spam  
filters eat our  
email response)**

## LITE AND NARROW | 6

Keyser. However, with the coming of the railroad, the town's name was changed to New Creek.

The B&O had pushed as far east as Cumberland, Maryland by Nov. 5, 1842. The Commonwealth of Pennsylvania had denied the B&O the right to build within its borders, so the directors in 1843 ordered a reconnaissance of the areas of Maryland and (West) Virginia in order that the best non-Pennsylvania route to the Ohio River be determined. Surveys were started in 1846, and work resumed in 1849. In June 1851, the railroad from Cumberland was completed through Keyser to Piedmont, a distance of 28 miles.

There were many battles and skirmishes during the Civil War in the northern part of the Shenandoah Valley, especially for control

*Layout tours - Trackwork - Structures - New*  
*Plann*  
*- Humor - Contrarian Opinions - News*  
*DCC*  
*Ballast - Multi-deck designs - Small layout*  
*ering - First looks - Rolling stock -*  
*guidelines - Clickable ad links - Video - Operatio*  
*Prototype modeling - Lighting - MRH forum - In*  
*active reader feedback - Questions Answers and*  
*- Upcoming events - Model liners - Bu*  
*ing signs*  
*Scenery*  
*tuning - The Tool Shed - Layout owner interview*

# Model Railroad Hobbyist magazine™

**YES, subscribing MATTERS!**  
**(even though it's free)**

**It helps MRH get more  
advertisers**

**Click here to subscribe!**



### 3. Employees clearing the right of way on the TM&P. *From the internet source unknown*

of the Baltimore and Ohio. The railroad being a vital link in the transportation of troops and equipment along the northern border of the Confederate States. This led to the creation of the State of West Virginia when it seceded from the Confederate state, rejoining the Union in 1863. The irregular shape of West Virginia, especially the Eastern panhandle, was to keep the B&O within the boundaries of a Union state and prevent the Confederate states from getting control.

With the end of the Civil War, Mineral County was formed from the northeast section of Hampshire in 1866, and New Creek became the county seat.

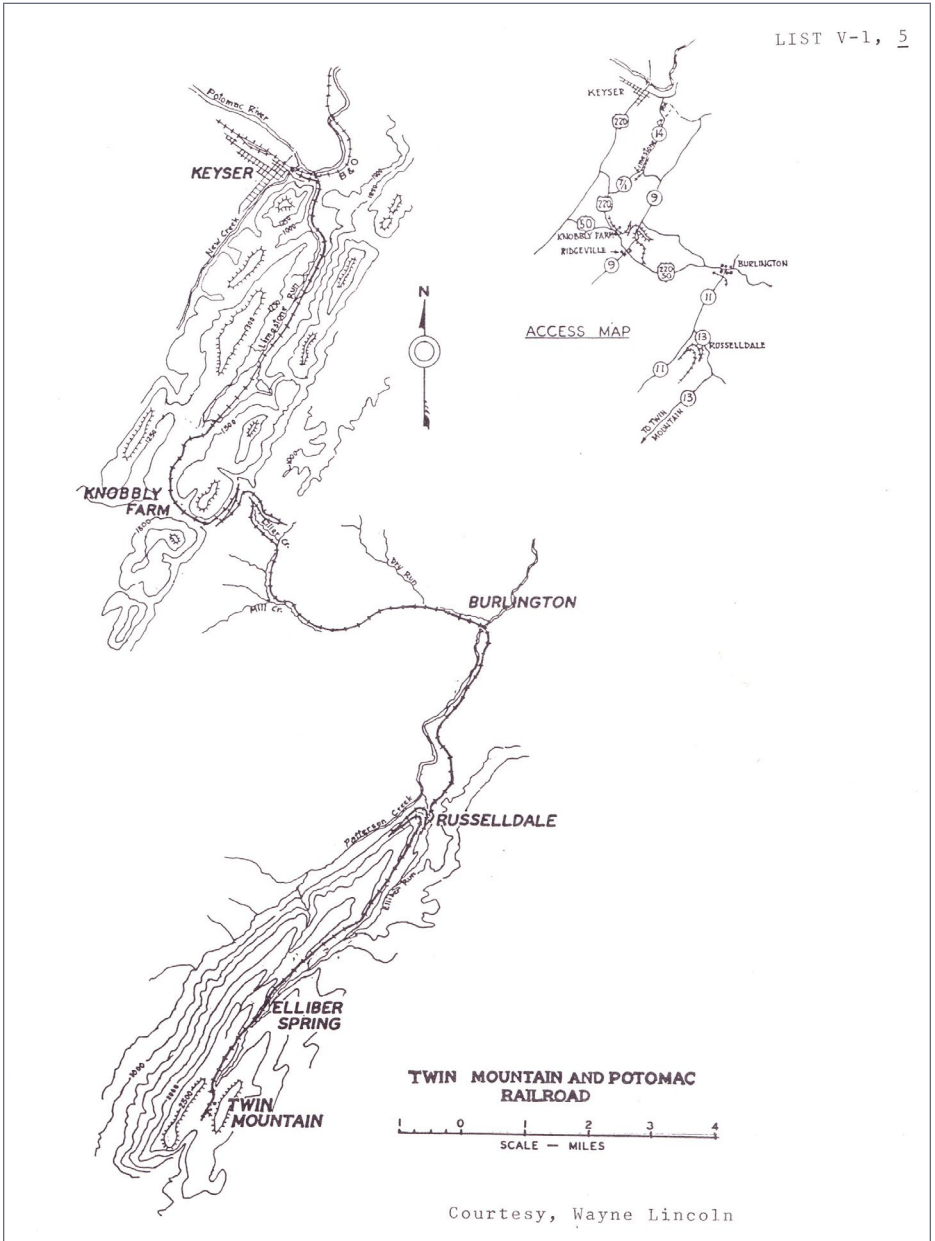

Courtesy, Wayne Lincoln

4. Map of the TM&P drawn by Wayne Lincoln. Published in the March 1987 Light Iron and Short Ties



## LITE AND NARROW | 9

In 1851 the B&O had reached the Ohio River and the railroad shops were located in Piedmont at the bottom of 17-mile grade. In 1874, the shops were moved to Keyser, and that same year the town incorporated and changed the name from New Creek to Keyser. The town's name was derived from the Baltimore and Ohio's William Keyser, a second vice-president of the company, in order to influence the railroad to place facilities at the location.

These shops were described in the B&O Annual Report issued Sept. 30, 1875. "In order to increase facilities and conveniences in the vicinity of the great coal regions, the company acquired at Keyser, five and one-quarter miles east of Piedmont, 75 acres of land, on which it has constructed excellent and valuable improvements.

Almost 40,000 have read this MRH forum thread -  
**HAVE YOU?**

Share your weathered rolling stock, Please!

Sat, 2012-03-24 12:34 — Bluessman Locos and rolling stock Locos - Rolling stock (general)

 ShareThis

I am hoping some of you will share some pictures of your weathered rolling stock. I always love to see other peoples work and of course learn something new

Gary



Athearn Blue Box

Thu, 2012-03-29 04:56 — Tom Patterson

Here's a boxcar that I built in 1965 based upon a small photo in MR.



**Read  
now**



## LITE AND NARROW | 10

An engine house has been built of brick and iron, with stone foundation, of the best character, 305 feet in diameter, with 44 stalls for engines, and with a 60 foot turntable. It contains seven tracks, with pits for engines, and is lighted by a ridge skylight 16 feet wide, covered with hammered plate glass, and provided with side ventilators. A machine shop, dimensions 103 feet by 164 feet, is rapidly approaching completion. A substantial station building, with accommodations for passengers, the requisite offices, etc. has been erected. A freight warehouse, built of brick and covered with slat, 46 feet by 102 feet has been finished.”

“New and extensive stockyards have been completed. These accommodations embrace one hay and sheep house, 80 feet by 130 feet, 6 hog houses, capacity 1,800 hogs and yards and sheds for 2,000 cattle. Forty-eight coal chutes, holding six tons each, with storage capacity of 888 tons, have been completed at this point.”

“Between Piedmont and Keyser, two tracks have been added, making four tracks, thus increasing greatly the facilities and economies of making up and dispatching trains.”



5. Employees and handcar on trestle on TM&P. Photo courtesy of Patricia and Charles Bonar, Larry Smith collection

# LITE AND NARROW | 11

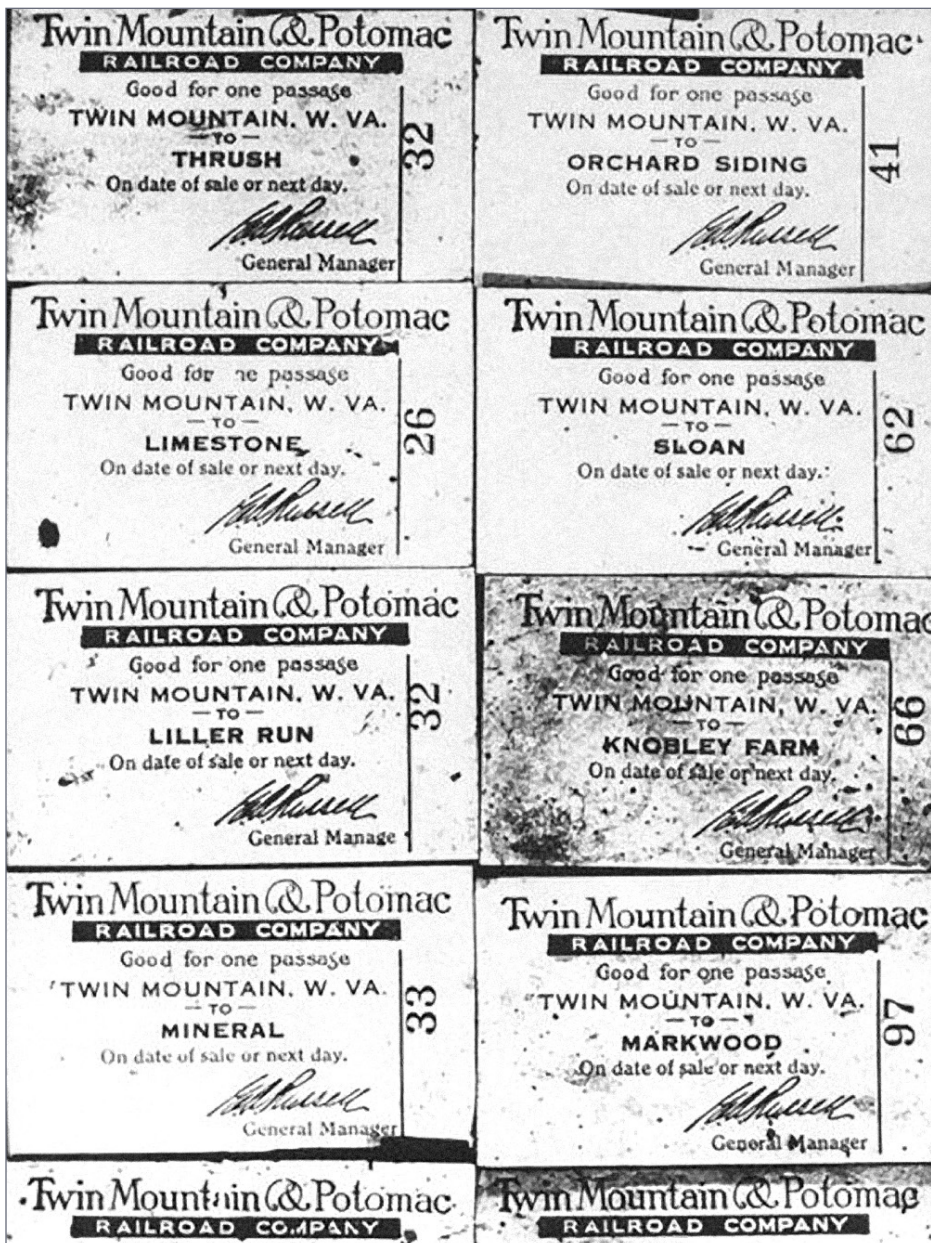

6. Tickets to the various stops on the TM&P. Photo courtesy of Patricia and Charles Bonar, Larry Smith collection

## LITE AND NARROW | 12

### Enter the Twin Mountain and Potomac

In the early 1900s, large apple orchards were planted in the Patterson Creek Mountains, south of Burlington, West Virginia, after discovering that the soil and climate conditions were ideal for growing fruit. Some were owned by Will and Allen Russell, while others were owned or managed by the Leatherman family. E.A. Leatherman managed Chert Orchard, one of the larger farms. After the farms began to produce fruit, it became necessary to find ways to transport the harvest to market.

Roads at the time were crude or almost non-existent, making it difficult to get the harvest to the railroad at Keyser, a distance of sixteen miles. This was an all-day trip by horse and

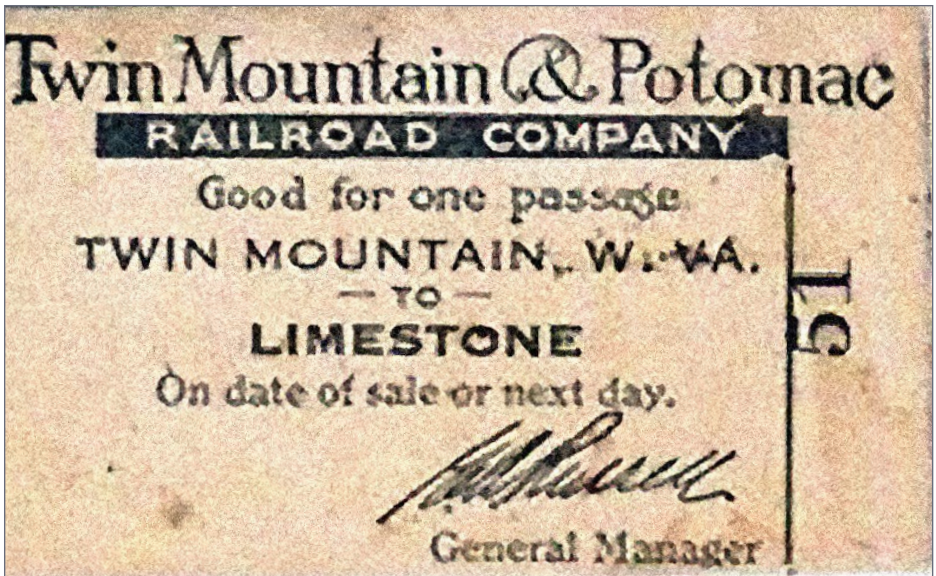

7. Single ticket to Limestone, WV. Photo courtesy of Patricia and Charles Bonar, Larry Smith collection

## LITE AND NARROW | 13

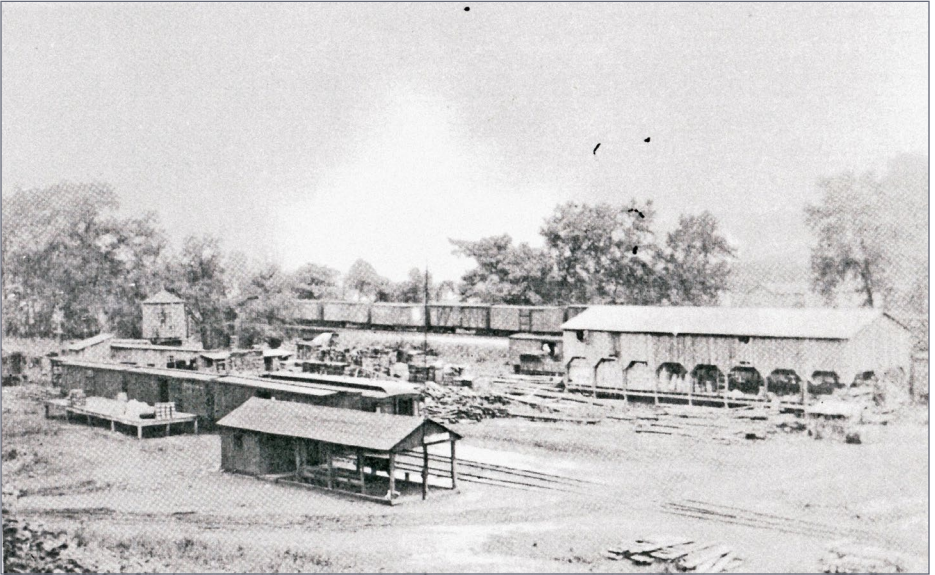

8. East end of Keyser yard. There are lots of interesting buildings in the shot that show opportunities for modeling. Look at the water tower in the background. *Philip Miltenberger collection, published in the March 1987 Light Iron and Short Ties*

wagon just to deliver a small amount of fruit to the railroad shed for packing.

Frustration with the lack of transportation caused local businessmen to hold meetings to explore the possibility of building a railroad to handle the flourishing fruit business. The final result of these meetings was the granting of a charter to the Twin Mountain and Potomac Railroad (TM&P) on May 24, 1911, issued in perpetuity to build a three-foot gauge railroad.

Why a three-foot gauge railroad? After an evaluation, it was determined that due to the mountainous terrain and the

## LITE AND NARROW | 14

differences in elevations, it would be more economical to build. It was also determined that switchbacks at Knobbly and Liller Run would eliminate the need for tunneling, and would be more efficient as well as less costly to maintain.

The original debt for the railroad was funded by \$400,000.00 (\$9.7M today) in preferred stock and \$100,000.00 (\$2.4M today) in common stock with each share valued at \$100. The president of the railroad was H.L. Heintzelman of Fairmont, WV. Corporate offices were located in both Fairmont and Keyser. Something was omitted from the charter that would end up plaguing the railroad for its existence, that being exempt from property taxes. This along with other factors lead to the railroad's ultimate demise.



9. West end of Keyser yard with one of the 4-6-0s in the foreground. *Photo courtesy of Patricia and Charles Bonar, Larry Smith collection*

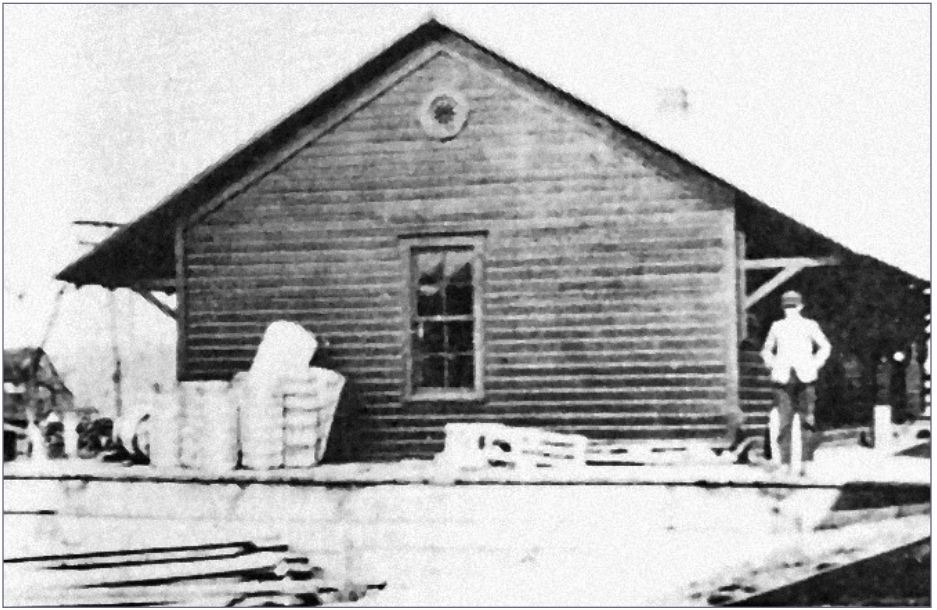

10. Burlington station in 1911. *Photo courtesy of Patricia and Charles Bonar, Larry Smith collection*

The contract to build the railroad was awarded to the Potomac Construction Company, with work to begin sometime after July, 1911. There were problems from the start with acquiring the right of way as land owners wanted more for the land than the railroad was willing to pay, and construction was suspended. The impasse was finally settled when the county court was authorized by a vote of the district residents in a special election to issue construction bonds for an amount sufficient to purchase the right of way.

Construction resumed, and was completed between Keyser and Burlington, a distance of 15.6 miles, on August 16, 1912. Trains began operating between the two towns while construction continued on to Twin Mountain. The last segment of the railroad

# LITE AND NARROW | 16

was completed on March 13, 1913, making the railroad a total of 26.6 miles in length.

## Equipment

With the railroad starting from scratch, it was easier to purchase new equipment rather than finding castoffs from the established narrow gauge lines. So, confident the railroad would be successful, everything from the spikes to the locomotives was purchased new.

The locomotives were purchased from Baldwin, and were stock-design ten-wheelers (4-6-0) used by many narrow gauge railroads. They were Baldwin 10-24-D designs, meaning they had 10 wheels, 15" cylinders and six drivers. A full specification for the two locomotives is in the chart below.

Data from *Baldwin Locomotive Works Specification for Engines* as digitized by the DeGolyer Library of Southern Methodist University, Volume 39, p. 91 (see following pages).

One other locomotive saw service on the railroad during construction. It was a Baldwin 0-4-0T, construction number 21554. The locomotive had been built in 1903 for the Potomac Construction Company as their No. 1. The locomotive was tiny, only having 8½" cylinders.

The freight equipment was built by ACF in Huntington, WV in 1912. There were seven boxcars and 10 gondolas. ACF did build one-car lots, so it is possible the single flat car owned by the railroad was built by them as well. I do have a photograph in a portfolio of a flat car that was built for the Elk and Little Kanawha just two years later of similar construction. Based on the builder's portfolios, the cars were 38' 2" long with an inside length of 36'. All of the cars had steel underframes with fish belly center sills.



# LITE AND NARROW | 17

Specifications by Steve Llanso of Sweat House Media

|                        |                         |
|------------------------|-------------------------|
| <b>Class</b>           | <b>1</b>                |
| <b>Locobase ID</b>     | 13836                   |
| <b>Railroad</b>        | Twin Mountain & Potomac |
| <b>Country</b>         | USA                     |
| <b>Whyte</b>           | 4/6/2000                |
| <b>Number in Class</b> | 2                       |
| <b>Road Numbers</b>    | 2-Jan                   |
| <b>Gauge</b>           | 3'                      |
| <b>Number Built</b>    | 2                       |
| <b>Builder</b>         | Baldwin                 |
| <b>Year</b>            | 1911                    |
| <b>Valve Gear</b>      | Walschaert              |

## Locomotive Length and Weight

|                                                               |        |
|---------------------------------------------------------------|--------|
| <b>Driver Wheelbase</b>                                       | 9'     |
| <b>Engine Wheelbase</b>                                       | 18.50' |
| <b>Ratio of driving wheelbase to overall engine wheelbase</b> | 0.49   |

## Overall Wheelbase (engine & tender)

### Axle Loading (Maximum Weight per Axle)

|                                            |             |
|--------------------------------------------|-------------|
| <b>Weight on Drivers</b>                   | 70500 lbs.  |
| <b>Engine Weight</b>                       | 88500 lbs.  |
| <b>Tender Light Weight</b>                 | 60000 lbs.  |
| <b>Total Engine and Tender Weight</b>      | 148500 lbs. |
| <b>Tender Water Capacity</b>               | 3000 gals   |
| <b>Tender Fuel Capacity (oil/coal)</b>     | 6 tons      |
| <b>Minimum weight of rail (calculated)</b> | 39 lb./yard |

## Geometry Relating to Tractive Effort

|                                                               |            |
|---------------------------------------------------------------|------------|
| <b>Driver Diameter</b>                                        | 45"        |
| <b>Boiler Pressure</b>                                        | 180 psi    |
| <b>Cylinders (dia x stroke)</b>                               | 15" x 22"  |
| <b>Tractive Effort</b>                                        | 16830 lbs. |
| <b>Factor of Adhesion (Weight on Drivers/Tractive Effort)</b> | 4.19       |

## Heating Ability

|                                                    |               |
|----------------------------------------------------|---------------|
| <b>Firebox Area</b>                                | 100 sq. ft.   |
| <b>Grate Area</b>                                  | 14.60 sq. ft. |
| <b>Evaporative Heating Surface</b>                 | 1238 sq. ft.  |
| <b>Superheating Surface</b>                        |               |
| <b>Combined Heating Surface</b>                    | 1238 sq. ft.  |
| <b>Evaporative Heating Surface/Cylinder Volume</b> | 275.13        |

## Robert LeMassena's Power Computation

|                                                                 |        |
|-----------------------------------------------------------------|--------|
|                                                                 | 2628   |
| <b>Same as above plus superheater percentage</b>                | 2628   |
| <b>Same as above but substitute firebox area for grate area</b> | 18000  |
| <b>Power L1</b>                                                 | 5214   |
| <b>Power MT</b>                                                 | 489.14 |

## LITE AND NARROW | 18

There is no indication of where the two ballast cars on the roster came from. The best guess was that they were left there by the Potomac Construction Company when the work was finished.

The railroad never owned any cabooses but ran mixed trains using two passenger cars purchased new and built by Niles, a famous interurban manufacturer. There was a combine and a coach. As indicated in the drawings, the cars came with interurban-style arched windows in the car ends and interurban-style trucks. The reason for the cars being purchased from Niles was due to influence of Sylvanus Watson, a Grafton multimillionaire, who in addition to his massive coal holding, owned several electric lines, and provided the money for the cars to the TM&P.

To the best of anyone's knowledge, research has never turned up a published timetable, although schedules were published in the



11. Burlington station today as part of the Mineral County Library. *From the internet source unknown*

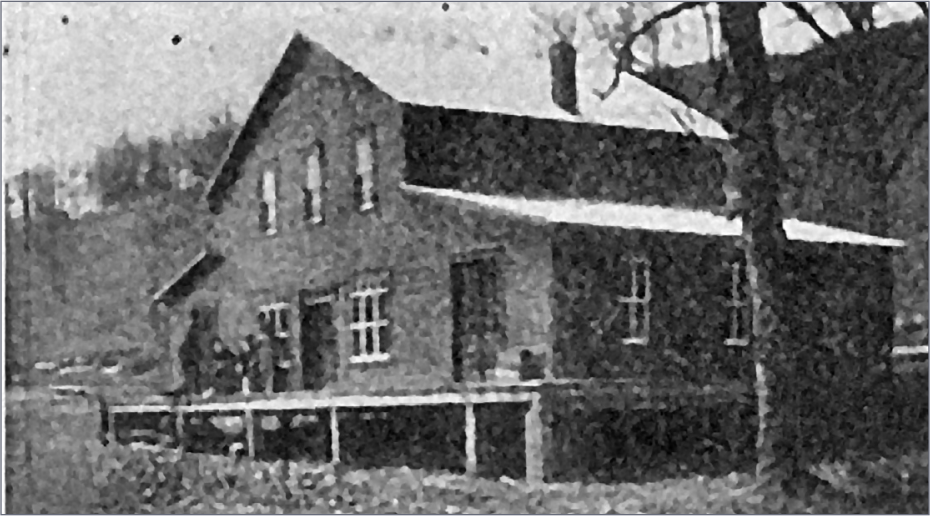

12. Barksdale store that served as the station at Russelldale. *Photo courtesy of Patricia and Charles Bonar, Larry Smith collection*

June, 1916, *Official Guide*. The time over the road was listed as 2 hours and 20 minutes in each direction. This was an admirable time considering the time needed to negotiate two switchbacks, switch cars, handle the less-than-carload freight, and handle the Wells Fargo Express, which had the express contract. The only year U.S. Mail was handled was 1915, for which the railroad received \$1,154.00. While the railroad never operated any passenger trains, per se, they did operate specials for church meetings.

From Keyser, heading generally south, the line passed through the settlements of Mineral, Limestone, Reservoir, Orchard Siding, Knobley Farm, Liller Run, Markwood, Dry Run, Burlington, Thrush, Sloan, Russelldale, Eliber Siding, and Twin Mountain.

As with most single-commodity-focused railroads, the TM&P was doomed to failure from the start. Not only was it dependent on a single commodity, but a seasonal one at that. There was only one

## LITE AND NARROW | 20

other industry located at Russelldale, a factory that produced insulator pins for utility poles on the railroad. Most of the freight on the railroad was coming into the area, not originating on the line

Beginning almost immediately, the railroad lost money. A peach blight in 1918 destroyed most of that crop, worsening an already bad situation. Then with the entry of the United States into World War I, the shortage of manpower in the area and a cutback in farm crops placed even more strain on the railroad. With declining revenues, insufficient funds were the primary cause of the railroad folding, and on February 28, 1919 the last revenue train operated over the line. Foreclosure came quickly as property taxes hadn't been paid for a number of years.

An attempt was made by the West Virginia legislature to get the Baltimore and Ohio to take over the railroad. However this went



13. Russelldale station as restored to a private residence in 1993. *Photo courtesy of Patricia and Charles Bonar, Larry Smith collection*

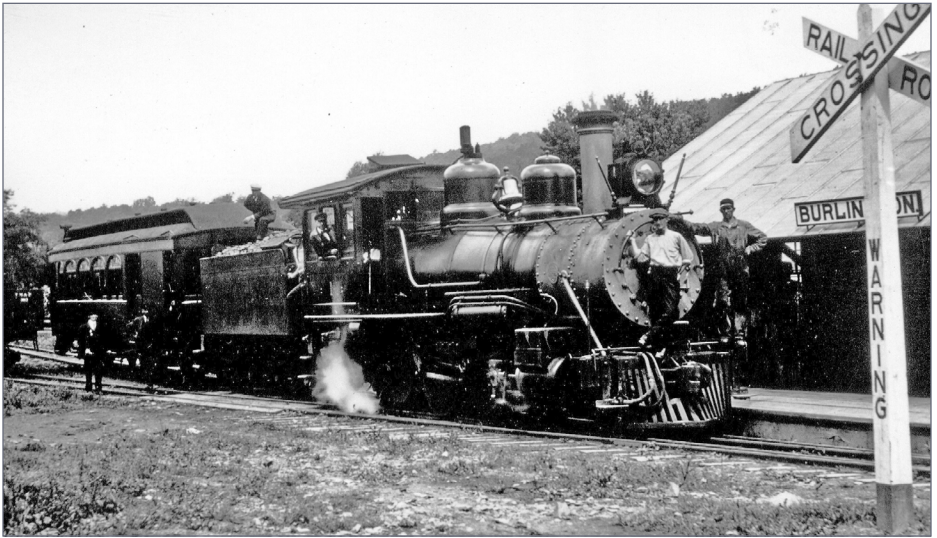

**14. Locomotive and combine at Burlington station in 1913.**  
*Photo courtesy of Patricia and Charles Bonar, Larry Smith collection*

nowhere, and on June 12, 1920, the entire assets (locomotives, cars, ties, and rail) of the TM&P were sold to the West Virginia Tie and Timber Company (Rapidan Railroad) and moved to Orange, Virginia.

Of the two locomotives, the #1 (BLW C/N 36326) lasted the shortest time on the railroad. It was replaced by a Shay after less than a year on the property. It was sold to H.M. Foster (a locomotive dealer), and then to Southern Iron and Equipment Company in Atlanta, GA. On 4-30-1921, The Zimmerman, Leesville & Southwestern Ry., owned by J. A. Bentley Lumber Co., purchased TM&P #1, moving it to Zimmerman, LA. The #2 (BLW C/N 36327) stayed at Orange, VA until the end of logging operations in the area, when the Rapidan was abandoned, at least in Virginia, in 1926. The locomotive was purchased by the ET&WNC where it was renumbered, becoming their second #8. It saw service until 1936 when it was scrapped.

## LITE AND NARROW | 22

The two passenger cars also went to the ET&WNC, becoming their numbers 25 and 26. They were assigned to the Linville River Railroad, and operated for many years before being scrapped.

The freight cars are a guess, as there is no record of them being sold. Best guess has them going to the West Virginia Tie and Timber operations on the newly formed Rapidan Railroad in West Virginia. There is a record of the railroad operating in West Virginia, but very little is known about it. It is surmised that the gondolas were turned into logging flats, and the boxcars became either supply cars or bunk cars.

### Modeling the Twin Mountain and Potomac

If you want to try your hand a narrow gauge modeling, the TM&P might be a good choice. It would give you an opportunity to model something other than a logging or a mining railroad, and with the amount of locomotives and cars, it

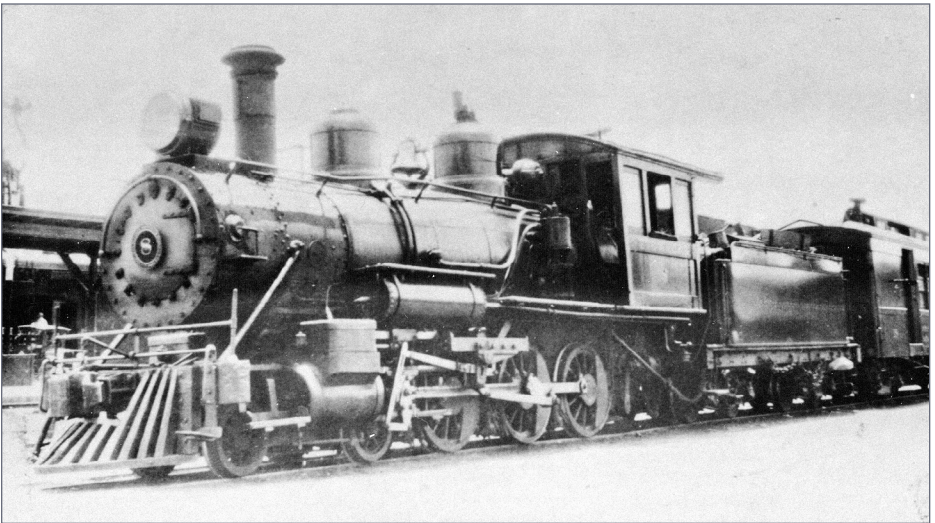

15. ET&WNC second #8 formally TM&P #2 in service. *Photo courtesy Johnny Greybeal*

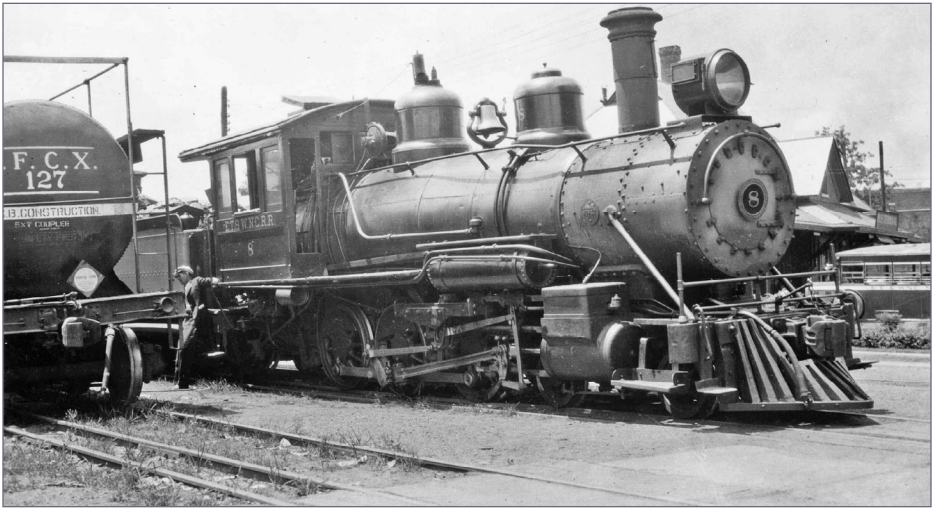

16. ET second #8 in Johnson City, TN *Photo courtesy Johnny Greybeal*

wouldn't break the bank either. Even if you don't want to go narrow gauge, you have many choices in cars and locomotives to represent a nice shortline.

For the HO<sub>n3</sub> modeler, a pair of Blackstone C-19s could be your choice in motive power. The only 4-6-0s on the market are D&RG T-12s, brass and very hard to find, and Train and Trooper's ET&WNC 4-6-0, also brass, very expensive, and scarce. For freight cars, use either F&C's EBT wood-sheathed boxcars and replace the center sill with a fish belly one. For the gondolas, Mt. Blue Models produces a very nice kit for the ET&WNC gondolas. These too could be modified with a fish belly underframe to represent the TM&P cars.

For the On<sub>30</sub> group, Bachmann makes a beautiful 4-6-0 that would be perfect for this railroad. Just add their passenger cars, boxcars, and gondolas, and you are in business. There are also lots of cars from other manufacturers you can add.

## LITE AND NARROW | 24

Even doing the railroad in standard gauge, you have options with inexpensive 4-6-0s available as well as a vast number of cars.

### Layout components

#### Keyser

Keyser is a simple design. Based on photographs, there was a two-track yard. Across from the yard is a packing shed that serves as the interchange with the B&O. Fruit is brought into the shed by the TM&P, packed into shipping containers, and loaded onto B&O boxcars for shipment to market. Just behind the packing shed is a track leading to the single-stall engine house, water tank, and coal loader. A small turntable serves the engine house. The station is south of the packing shed and serves only the TM&P. The B&O is located across New



17. Second #8 with train in the Doe River George. Note the second car in the train is the coach from the TM&P. *Photo courtesy Johnny Greybeal*



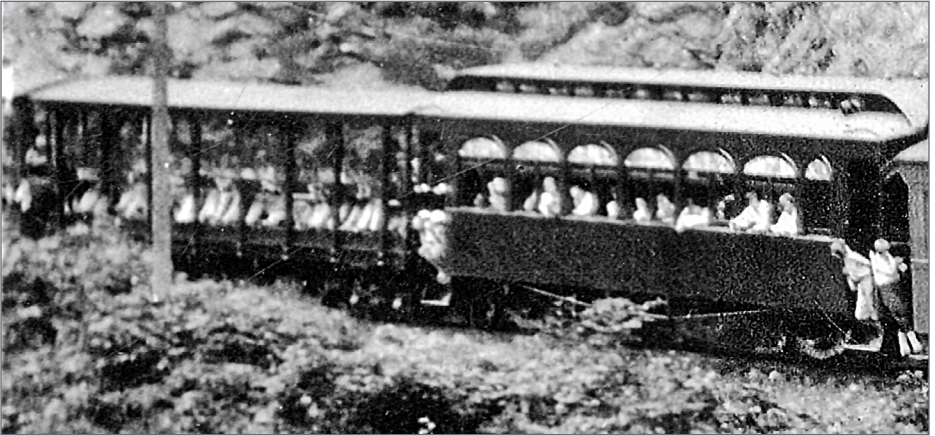

18. Close up of the second coach in the train. *Photo courtesy Johnny Greybeal*

Creek that runs next to the TM&P facilities and serves the railroad as if it were another industry. There is a storage yard next to the engine house where lumber is off loaded for shipment to Twin Mountain.

### Knobbley Farm

Knobbley Farm is a very important flag stop between Keyser and Burlington. There is a large orchard at this location, and the railroad has a siding to serve its packing shed.

### Burlington

Besides Keyser, there are only three stations with buildings on the TM&P, and Burlington is one of them. The station is one of two buildings still standing that served the railroad, and has been incorporated into the Mineral County library. Locating a station at this point was unusual, as there was nothing there to justify one. The only other structure at Burlington was a water tank.



19. TM&P locomotive #2. Photo courtesy Johnny Greybeal



20. TM&P combine in Linville River lettering. *Photo courtesy Johnny Greybeal*

## Russelldale

Russelldale was the second town to have a station. This was the location for only non-farm industry on the railroad, a plant that manufactured insulator pins for utility poles. The factory had a siding where the TM&P spotted cars for loading. There was also a passing siding that was often used by the railroad to double the hill to Eliber Spring, because the ruling grade at this point changed from 2% to 4%.

## Eliber Spring

Eliber Spring is the location of the largest farm in the area, the Chert Orchard. The farm had a packing shed and a siding that was served by the railroad.

## Twin Mountain

Twin Mountain was the largest shipping point on the railroad. The town was isolated from the rest of the valley, and could only be reached by the railroad. There are several packing sheds with sidings to serve them, and a lumberyard with its

## LITE AND NARROW | 28

own siding. All of the structures in the town were constructed of wood brought in by the railroad. There is a wye so that the whole train can be turned for its return trip to Keyser.

### Operation

Operation is that of the typical shortline. The railroad would deliver empty cars to the packing sheds along the way, as well as the lumberyard and pin factory, picking them up later. Express would be handled by the combine and delivered to the two stations. An unusual aspect of the operation was how the flag stops worked. A farmer would pull his wagon up to the flag stop and park it to wait for the train. When the train arrived, the crew would load the produce into the empty boxcar and then go on their way. This would make for an



21. TM&P coach in Linville River lettering. *Photo courtesy Johnny Greybeal*

# LITE AND NARROW | 29

interesting scenario on a model railroad, as you could place a wagon at different flag stops. Just imagine what this would do to an operating schedule.

This railroad makes for an interesting TOMA layout. Each of these elements could be built one module at a time until you get the whole railroad done.

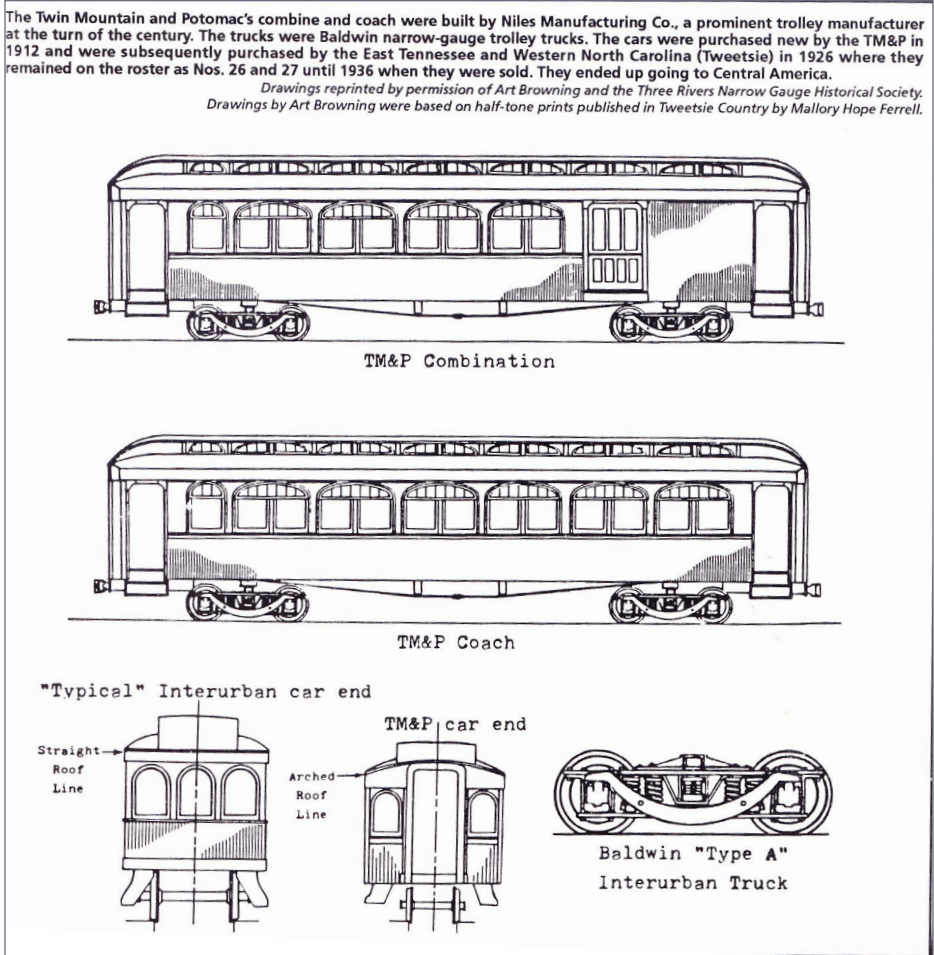

22. Drawing of the two passenger cars by Art Browning. Published in the March 1987 Light Iron and Short Ties

# LITE AND NARROW | 30

No matter what scale, narrow gauge or standard, I hope you will share your work with *MRH* and show us how you have implemented these ideas.



**Click here for reader comments**



Builder's photo of boxcar #100, one of seven (#100-106) built for the TM&P by ACF in 1912. *ACF photo, author's collection*

|                         |                     |                         |                             |                      |                                  |
|-------------------------|---------------------|-------------------------|-----------------------------|----------------------|----------------------------------|
| <b>LENGTH OVER</b>      | End Sills 37' 2"    | Buffers 38' 2½"         | Inside 36' 0"               |                      |                                  |
| <b>WIDTH OVER</b>       | Sidesills 7' 6½"    | Eaves 8' 7"             | All 9' ¾"                   | Floor 8' ½"          | Inside 7' 6"                     |
| <b>HEIGHT</b>           | Inside 6' 7"        | Sill to Plate 6' 4¾"    | Rail to top of Floor 3' 4¼" |                      | Rail to Center of Draw Bar 2' 2" |
| <b>DISTANCE BETWEEN</b> | Center Sills 12' ¾" | Truck Wheel Base 4' 10" |                             |                      |                                  |
| <b>WEIGHT OF</b>        | Body 20,180 lbs.    | Trucks 8,040 lbs.       | Total Weight 28,220 lbs.    | Capacity 50,000 lbs. |                                  |

23. The photo that started it all. The TM&P builder's photo of the boxcar. *ACF photo Larry Smith collection*

# LITE AND NARROW | 31

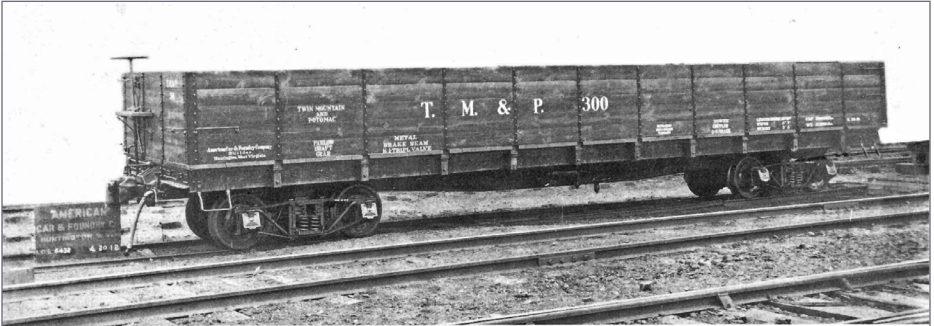

Builder's photo of gondola #300, one of ten (#300-309) built for the TM&P by ACF in 1912. ACF photo, author's collection

|                  |                     |                             |                                                  |
|------------------|---------------------|-----------------------------|--------------------------------------------------|
| LENGTH OVER      | End Sills 37' 2"    | Buffers 38' 2½"             | Inside 36' 9½"                                   |
| WIDTH OVER       | Sidesills 7' 6½"    | All 9' ¼"                   | Floor 8' 6½"    Inside 8' 2½"                    |
| HEIGHT           | Inside 3' 3"        | Rail to top of Floor 3' 4¼" | Rail to Center of Draw Bar 2' 2"                 |
| DISTANCE BETWEEN | Center Sills 12' ¾" | Truck Wheel Base 4' 10"     |                                                  |
| WEIGHT OF        | Body 14,760 lbs.    | Trucks 8,040 lbs.           | Total Weight 22,800 lbs.    Capacity 50,000 lbs. |

24. The TM&P gondolas builder's photo. *ACF photo Larry Smith collection*

**Use our custom  
 Google search on the  
 MRH website to find  
 topics of interest**

**CLICK TO FIND OUT MORE**



# Announcing our next Limited Run PWRS / Micro-Trains® Cars!!!

**PWRS** 

## Canadian Pacific (CP) • 3-Packs

### 57' 6" Converted TOFC Flat Car w/40' Trailer

Pack #1 - red trailer, white Canadian Pacific script lettering



**COMING**  
April 2017

CP Flat Cars: Black, white lettering, light weathering

Pack #2 - aluminum trailer, red Canadian Pacific script lettering



CLICK HERE FOR  
**CP TOFC** 

PACIFIC WESTERN RAIL SYSTEMS  
**SPECIAL RUN CAR**



## **Pacific Western Rail Systems**

• INDEX

• TABLE OF CONTENTS





# WHAT'S NEAT WITH KEN PATTERSON

KEN PATTERSON  
.....

column

## ST. LOUIS RAILROAD PROTOTYPE MODELERS MEET ...

**THIS MONTH IS YOUR TICKET TO RIDE TO THE**



St. Louis Railroad Prototype Modelers meet, where there were more than 1800 models on display, many modular layouts, manufacturer displays, and

visitors from around the world. Add to that a few video runbys and bonus photoshoots that fit the July 4th theme, and we have a pretty good What's Neat in Model Railroading presentation this month.

Many of the manufacturers are small companies that don't get much air time and may not be known to you. Many of them make products that fill very specific niches. The variety of the models and scales on display was overwhelming. Even after two days, I had not seen everything until I watched the video in editing.

► **PHOTOS AND VIDEO OF SUPERB MODELS**

## WHAT'S NEAT | 2



2-3. Dave Hussey from Cannon and Co. showed off new laser-manufactured flat car loads, along with his line of laser cut freight cars that are not available by any other manufacturer. He has put a lot of thought, research and design into this line of products. [cannonandco.net](http://cannonandco.net) is worth checking out.

## WHAT'S NEAT | 3



4. Shane Wilson and Paul Ellis, from ScaleTrains.com, set up this nice trade show booth to display their Museum Quality and Rivet Counter product lines that appeal to the specific audience that is the attendee of the RPM meet.



Playback problems? [Click here ...](#)

# WHAT'S NEAT | 4



5-6. Chris Palomarez from Athearn set up a booth at the show complete with a switching layout to demo the Tsunami sound that comes in Athearn units. In the interview Chris points out that a lot of the research used to produce fine accurate models comes from meeting like-minded modelers who have that information on hand at RPM meets.



7. The one product that really caught my attention was this handheld radio control throttle that Scott Thornton was showing. It had a great feel to it. Its called the Proto Throttle and is designed like a control stand of a locomotive complete with notching, spring-loaded whistle, brake, and so on. The system works with any DCC system and they are working on compatibility with garden railroads. I look forward to getting my hand on a production model to feature on a future What's Neat show.

“Clarification on the ProtoThrottle: I spoke too soon about two points in the interview:

1. We're not yet sure about compatibility with garden railroad systems;
2. Full development of the product is requiring more time and we are hoping to have a workable unit available at the St. Louis RPM Meet in June 2017.

Thanks for your understanding.”

– Scott Thornton



8. I met John O'Donnell, the owner of Moon Dog Railcars at [moondograilcars.com](http://moondograilcars.com). He handbuilds freight car loads and sells them complete with a flat car, ready to run. A lot of time and work goes into building realistic models like John's company does. Add to that his dry humor and it made for a good interview.



## WHAT'S NEAT | 7



(Coils available for purchase from Tangent separately!)



9-11. David Lehlbach from Tangent Scale Models introduced four new models this past year, bringing his company's total freight car lineup to 15 models. In the video he talks about and shows many of his models. Here are two that I really like: the corrugated gondola in Conrail paint comes with racks to hold steel coil loads that Tangent also produces. Also notice the amazing-looking "paint out" BNSF buffer cars for running behind the locomotives in oil train consists. All the cars have very impressive paint work and are detailed to match the prototypes exactly.



12. Keith Hapes from Plano Model Products set up a display spanning four tables with hundreds of etched metal details and roof walks for detailing freight cars and structures.

**Want to help keep  
MRH free?**

**Then *click* on ads!**



*Have you seen this?*

**CHECK IT  
OUT!**



**kenpatterson.com**

*click here to ...*

**Visit Ken's website**

**Ken Patterson  
reveals his modeling  
secrets on video!**





13-15. Nick Molo, owner of Moloco Trains has been making detail parts for 20 years, but for the past six years he has been designing and selling freight cars ready to run that can only be described as contest-winning models. The paint and detail work is second to none. Mike Budde purchased a Moloco Rock Island General American box car at the show and allowed me to photograph it in a modeled scene in sunlight for the two photos you see here.



[Click here for reader comments](#)

# WHAT'S NEAT | 11



[Click here for  
reader comments](#)

## WHAT'S NEAT | 12

16-17. In the video I interview Andy Harman, who describes his effort in modeling passenger cars of the last heavyweight New York Central 20th Century Limited just before it went streamlined. He describes how he pretty much scratchbuilt the windows, car sides, bottom details and interior details – complete with passengers. His trick to hide the wires to the constant lighting system is to add extended brass stock atop the trucks, making power feed extenders that support the car's wiring high in the car and out of sight to the viewer during a runby. Andy is a wealth of information on modeling in all eras and his personality really comes through in the interview.

### ADVERTISEMENT

## A fine new history from Signature Press!

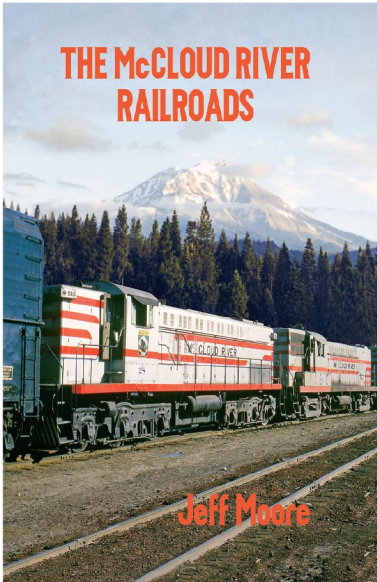

The *McCloud River Railroads* presents history and many photos from 1894 down to the present, of lumber rail-roading and a dinner train late in life. How can I learn more about this book? How can I buy it?

**Click here for  
the answer ...**

SIGNATURE PRESS

• INDEX

• TABLE OF CONTENTS



18. Jeff Adam, owner of Motrak Models, had his line of laser-cut craftsman structures on display and announced his purchase of the BEST Trains line of structure kits. This will make 126 models that he plans to make available in S, HO, O, and N scales.



19. The Badger Airbrush Company provided freight cars, paint and airbrush stations to teach individual modelers, one-on-one, how to successfully paint a model with an airbrush. It was a very well thought-out presentation.

# Tell your friends about MRH!

We depend on word-of-mouth to grow  
... if you don't share us, we don't grow

ADVERTISEMENT



Announces their purchase of  
BEST's  
Laser-cut Structure Kits

CHECK  
IT OUT!

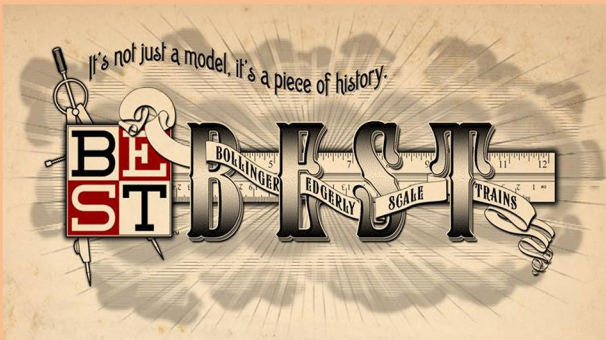

To order or get more information, please email Jeff at:  
[motrakmodels@centurylink.net](mailto:motrakmodels@centurylink.net)



20. The Midwest Mod-U-Trak N scale modular club set up their layout in a configuration measuring 20 X 65 feet with a walk-in design eliminating the need to duck under for access. In the video, Mike Skibbe and Matt Gaudinski discuss a new interchange module set up for the first time: Powerton is an electrified branch to supply coal to the Milwaukee Electric Light Company. The layout is known for realistic Midwest scenery that flows from module to module in a believable manner, a goal for any prototype looking modular layout.



[Click here for reader comments](#)



## WHAT'S NEAT | 16



21. The only narrow gauge modular layout set up at the show was the Mudhens HOn3 layout. With well-designed and painted backdrops, professional lighting and scenery that matches the prototype, this eight-year-old layout was a joy to see. They set up a 12-module loop with a staging yard that seemed very functional from an operating and switching standpoint. The Blackstone full-sound locomotives pulling freight were fantastic. In the video we interview Chuck Graham and go into more detail about the 35-year-old club. They plan to set up their layout at the Narrow Gauge National in 2017 in Denver CO.

## WHAT'S NEAT | 17



22-23. David Ward, owner of Protoloads, had an amazing display of freight cars with loads that are contest-winning quality. You can purchase these, ready to run on your layout, at [protoloads.com](http://protoloads.com). The Boeing airplane load was fantastic. The 17-foot-long rail transport train is available with your choice of flat cars as a base.

## WHAT'S NEAT | 18

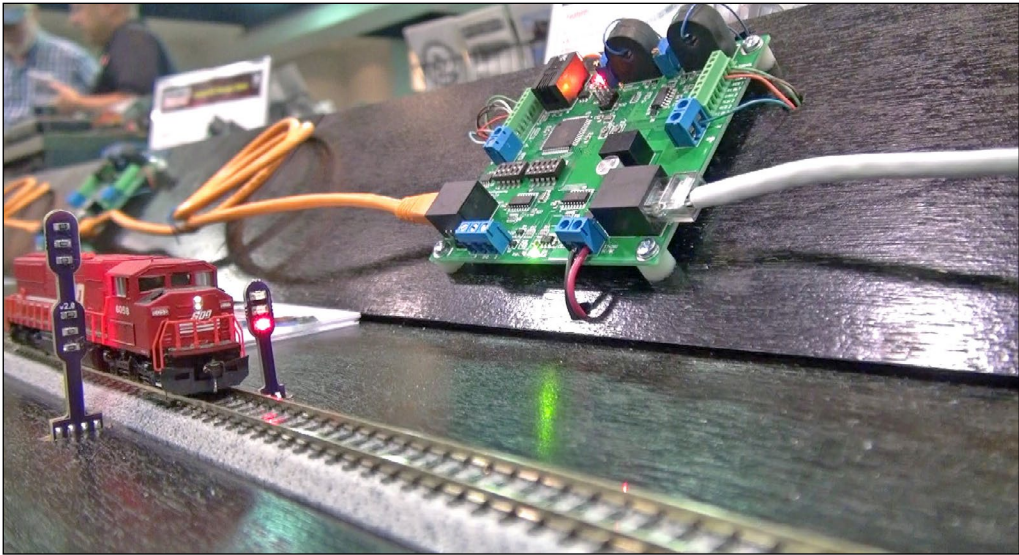

24. Iowa Scaled Engineering has a new signal block control board designed for the modular layout modeler or club. A stand-alone system, it can be joined with additional block signal boards on a modular layout to control a set of block signals. Chris Palomarez explains the system in detail in the ISE video segment. He was involved in the development of this new exciting product. I plan to purchase a few of these and install them on my modular home layout. I will show the process in an upcoming video segment for What's Neat next year.



[Click here for  
reader comments](#)



# MRH MARKETPLACE

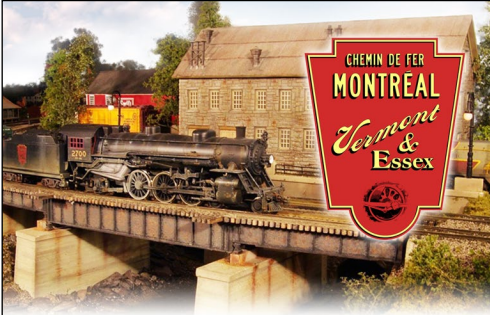

## OPEN HOUSE PORTES OUVERTES

November 26 & 27  
26 et 27 Novembre

[CLICK FOR DETAILS](#)

Your ad  
could be in  
this space  
for as low  
as \$112 a  
month.

[Click to learn more ...](#)

## JIM'S TRACK PLANS



New Designs Every Tuesday!



P.O. Box 6 Paonia, CO 81428

Ph. 970 527 4586

Made in The USA

Cast resin items for All Scales.

Tunnel portals, bridge piers, abutments, culverts, and retaining walls.

Trackside details and sage brush tree armatures.

"FREE SHIPPING see website for details"



**NEW !!!**  
SOUNDS FOR  
YOUR LAYOUT  
CHECK OUT OUR  
WIDE VARIETY OF  
SOUNDS

FREE SPEAKER & SWITCH WITH  
PURCHASE OF SOUND BOARD

LED lights & Animated Signs  
[www.lights4models.com](http://www.lights4models.com) 614-296-8691

[Click Here](#)



**KC's Workshop**  
 Craftsman Model Kits  
[www.kcworkshop.com](http://www.kcworkshop.com)  
[www.facebook.com/kcworkshop](http://www.facebook.com/kcworkshop)



**JEFF OTTO**  
 TURNIN' IT OUT  
 414-915-4671  
[ohrtracksupply.com](http://ohrtracksupply.com)  
[jeff@ohrtracksupply.com](mailto:jeff@ohrtracksupply.com)  
 N36W23431 Oak Hill Ln.  
 Pewaukee, WI 53072

LOOK at what's new at Black Cat this month

Click here for our website

**BAR box car**



**DT&I box car**



Black Cat Publishing  
 (204)489-5005  
[ajfergus@mymts.net](mailto:ajfergus@mymts.net)  
[blackcatdecals.com](http://blackcatdecals.com)



FEATURING

**America's Historic Main Street Architecture**



O-Scale model shown (HO available)

**MAIN STREET HERITAGE**

[www.mainstreet-heritage.com](http://www.mainstreet-heritage.com)

MODEL RAILROAD

**BenchWork.com**



Affordable built to order Benchwork starting at only \$20 a Sq Ft.

Don't settle for lifeless signals!  
 We've got signaling circuits!



**LOGIC RAIL™** "Sophisticated Model Railroad Electronics"

**LOGIC RAIL TECHNOLOGIES**

Please visit our website and online store!

21175 Tomball Pkwy Suite 287 Houston, TX 77070 Phone: (281)251-6813  
<http://www.logicrailtech.com>  
[info@logicrailtech.com](mailto:info@logicrailtech.com)

**clever models LLC**

Cardstock models & materials



Try one today!

[www.clevermodels.net](http://www.clevermodels.net)



**MODEL RAILROAD**  
**BenchWork**.com

**Affordable Modular (domino) Benchwork in 200+ sizes**  
Custom built to order benchwork also available!



**Yarmouth Model Works**  
HO scale resin kits and detail parts

..... U.S.A. MAILING ADDRESS  
3560 Pine Grove Ave. Unit 617  
Port Huron, MI 48060

Tel. 519-633-7574  
pierre.oliver@start.ca

..... CANADIAN MAILING ADDRESS  
85 Hiawatha St.  
St. Thomas, ON N5P 2T5

[www.yarmouthmodelworks.com](http://www.yarmouthmodelworks.com)

**CLICK HERE**

**CANYON CREEK SCENICS**



**North Texas Council of Railroad Clubs**  
dntwtrainshow.com

**2nd Annual Fall Plano Train Show**  
**October 1-2, 2016**

Two full days of clinics, home layout tours, art, dealer tables, railroadiana, door prize drawings, a switching layout plus over 10 modular layouts on display representing, G, O, S, HO and N scales as well as American Flyer, LGB, and Lionel.



Plano Centre, 2000 E. Spring Creek Pkwy., Plano, TX 75074  
Saturday 10 a.m. to 5 p.m. and Sunday 10 a.m. to 4 p.m.  
Admission \$8 per person (12 & under free with paid adult), Scouts in uniform FREE

**FREE PARKING!**

**W** GOLDEN AGE LINE  
**WESTERFIELD**  
MODELS, LLC

**Now Available Again**  
**KIT #5761/5762 PRR GLA**  
**Modernized Hopper**

**Check our Website For**  
**List of Closeout Kits.**  
**westerfieldmodels.com**

**P R E C I S I O N   D E S I G N   C O**

**Chains**  
**Flat Car loads**  
**Joint Bars**  
**Signs & Posts**

**FREE SHIPPING**



**MP** THE LAND OF PERFECT SCALE SCENERY AND TREES



## **RULERS-of-the-WORLD**

Scale Rulers \$4 each

Over 200+ scales!

Metric or Imperial

[www.rulers-of-the-world.com](http://www.rulers-of-the-world.com)

## **MOUNTAIN SUBDIVISION HOBBIES**

[www.modelrrsupply.com](http://www.modelrrsupply.com)

FREE USA SHIPPING OVER \$29.00

NCE - SOUNDTRAXX - DIGITRAX - PECO - CIRCUITRON  
DCC SPECIALTIES - INTERMOUNTAIN - CMX - ATLAS  
BAR MILLS - BOWSER - KATO - MRC - TOMAR - RIX -  
PIKESTUFF - LOGICRAIL - CENTRAL VALLEY AND MORE!

## **HO DIESEL SUPPLY**

KATO EMD SD SPECIALIST-REPAIRS-UPGRADES

New and Rebuilt Locomotives

Powered Chassis-Trucks-Motors

Bodies and Parts-Handrails-Electronics

[www.hodieselsupply.com](http://www.hodieselsupply.com)

email:kato@hodieselsupply.com

The **B** BUILDING &  
& STRUCTURE Co.

## **banta modelworks**



### **Chama Depot**

in HO scale all laser cut wood

#2098 \$148

421 Hopkins Road, Dummerston, VT 05301

800-653-8214

see all of our fine products from HO to F/G scales at:

[www.bantamodelworks.com](http://www.bantamodelworks.com)

## **Great Decals!**<sup>TM</sup>

FEC, Interstate, Virginian  
Railway, & L&N Titles

After Hours Graphics Line

Coupler Gages and More

In O, S, HO, and N Scales



## **2017 Trolley Calendar**

Color cover, 13 B&W photos with  
descriptive captions from mid-

Atlantic area:

PTC, PST, LVT, D.C., NY, PSCT and  
others.

\$10 +\$2 S&H

To order the calendar by check or  
money order (payable to East Penn  
Traction Club), please send to:

East Penn Traction Club

c/o Charles Long

227 Locust Road

Fort Washington, PA 19034-1425

[click HERE to learn more](#)

# Your ad could be in this space for as low as \$88 a month.

*Click to learn more ...*

# Cleveland

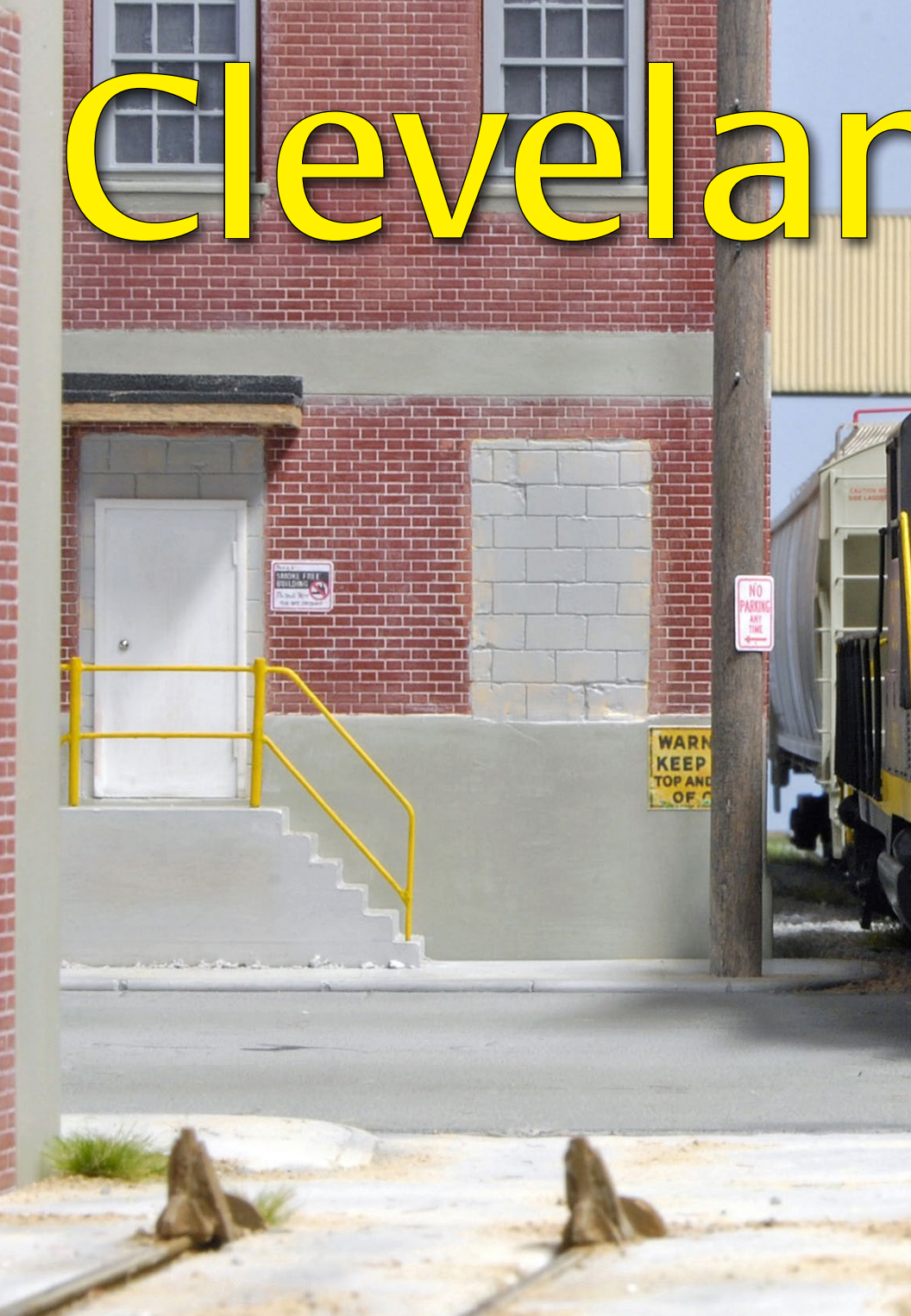

• INDEX

• TABLE OF CONTENTS



# nd Flats



*A small switching layout  
with big possibilities ...*

• INDEX

• TABLE OF CONTENTS

BY KURT MATTHEY



[Click here for reader comments](#)

## A 11'-6" LONG, NARROW SHELF IS ALL THE SPACE

I have available for a layout. I have built several HO switching layouts in the space since I started the hobby about 15 years ago and learned how to make the best use of it. However, I would not have thought that I could squeeze in an O scale 2 rail layout.

It helps that while I enjoy operating trains, but my main interest is the construction side of the hobby. I do not crave long operation sessions, and a small switching layout satisfies my needs. But still,



1. Overall view of the O scale Cleveland Flats switching module.

# CLEVELAND FLATS | 4



2. My Red Caboose GP9, the engine that started my adventure into O scale.

• INDEX

• TABLE OF CONTENTS

## CLEVELAND FLATS | 5

designing an O scale layout in such a small space that is visually appealing and fun to operate is a challenge.

My passion for O scale started about two years ago with a Red Caboose GP9 body kit. At that time I was still modeling solely in HO and I only wanted to build the O scale Geep to put it on a shelf for display. But when I finished, it was equipped with a scratchbuilt brass chassis, a strong P&D drive, a DCC sound decoder, and a high-quality speaker. Just putting it on a shelf was out of the question.

Within a few days I dismantled my half-finished HO switching layout and laid some O scale track. When I saw the GP9 on this simple layout, I was mesmerized by the visual impact of this big engine. I had never enjoyed running an engine so much before. I was hooked.



3. The track is a mix of Atlas code 148 flex track and hand-built turnouts. Turnout control is with Caboose Industries HO ground throws.

## CLEVELAND FLATS | 6



4. The warehouse and adjacent garage were built from styrene and cardstock.

This first O scale layout didn't last long, since I hadn't put much thought in it in my haste to get track down and my new engine running on it. Since then I have been toying with ideas for an O scale switching layout and I even started to build a few, but with little success. All the while I was building a small roster of O scale engines and freight cars.

Modern short lines and urban scenes are what I am most interested in. Looking for pictures, I came upon the Flats Industrial Railroad. The FIR is a small short line that provides switching service in the Flats District of Cleveland, OH. It operates four miles of track acquired from former Conrail, and presently FIR's only



## 5. HS 30445 is a Pullman Standard 5344 boxcar I scratchbuilt.

customer is Cereal Food Processors. This customer receives carloads of grain in covered hoppers. The moment I saw this location, the idea for my new layout was born.

Though I am not a prototype modeler, I like my layouts to be based on real locations, especially the track design. The track plan of my Cleveland Flats layout is closely based on the real location. To draw the plan, I took an aerial shot from Google Maps and scaled it down to 1:48 to take measurements. The dimensions of the layout are 11'-6" x 17'-19" with a 6' removable extension on the left for operation.

## Construction

Cleveland Flats is a sectional shelf layout, built on three sheets of 2" foam. Benchwork simply consists of shelf brackets and 3/4"

plywood. A 1” high frame along the edges of the plywood holds the three foam sheets in place. Each section is wired individually and can be plugged into the bus on the benchwork.

## Scenery and structures

The area I am modeling is flat, so no topography landscaping is needed – just add ground cover and vegetation. To do so, I use sifted dirt, HO and N scale ballast, and static grass. The track on my layout is not cleanly ballasted, because I want to achieve the look of old, badly maintained industrial trackage.

The structures are all scratchbuilt, except for the warehouse on the left, and are based on prototype buildings. I had to make a few changes to the big mill building, because I wanted to use windows

### ADVERTISEMENT

HO GP60M, GP60B AND GP60 Locos



Now Available !



DC OR DCC WITH SOUND!



www.foxvalleymodels.com



DID YOU KNOW  
MRH SUBSCRIBERS  
GET FREE BONUSES?

CLICK TO SUBSCRIBE  
NOW - IT'S FREE!

## CLEVELAND FLATS | 9

from Tichy Train Group, and without omitting the upper two stories, it would have been taller than my backdrop. So it is not a perfect representation of the original mill building. But I am not trying to achieve prototypical accuracy anyway; I am merely striving to capture the overall look of the scene.

When scratchbuilding, the measuring tool of Google Maps is a great help to get the dimensions of the building footprint. To determine the height can be a little more complicated sometimes, but with the red brick structures on my layout, it was easy. I could simply count the rows of bricks and then calculate the height of windows, stories or the entire structure.

I am building my structures from plain styrene, 1/8" thick cardstock, and styrene brick sheets. I like to work with these materials because



6. This is my Baldwin S12 with Atlas trucks, Faulhaber 2842 coreless motor, and HO LokSound decoder. I scratchbuilt this locomotive – see my blog for more details.





7. PREX 907 is preparing to leave after setting out a covered hopper at the mill.

they are inexpensive and easy to work with. My most important tools are a straightedge, a utility knife, and sanding paper.

## Operations

Quite a few short line railroads have just one customer, and they operate only two or three times a week or just as needed. They set out and pick up only a few cars at a time. This is the scenario my Cleveland Flats layout is based on. With its prototypical track design and structures, it sets the scene for short but realistic operation sessions.

To make operating more interesting, I am straying from the prototype. While Cereal Food Processors only receives grain in

# CLEVELAND FLATS | 11

covered hoppers, its counterpart on my layout sees a more varied assortment of freight cars. It receives grain in covered hoppers, corn syrup in tank cars, and bagged goods like raisins and sugar in boxcars.

There are five spots for cars to be unloaded. Two for tank cars and boxcars at the freight house in the middle of the layout, two for covered hoppers at the mill building, and one at the silos adjacent to the mill. The middle spur of the three tracks in front of the mill building is used for storing inbound cars that can't be spotted because the designated spot is still occupied. These cars will be spotted during the next operation session.



8. SMS 312 is pulling empty corn syrup tank cars from the warehouse.



9. SMS 312 getting ready to cross the roadway between the buildings to switch the mill.

I use switch lists to operate my layout, starting with the cars placed on the layout where they were left from the previous session. Depending on the number and positions of cars, incoming trains usually consists of two to four cars.

It is amazing how long it takes to switch a few cars if you run at low prototypical speeds and allow for a few seconds' break after each move to simulate the switchman doing his job when coupling or uncoupling cars or throwing a switch.

## Rolling stock

Compared to HO, offerings of O scale rolling stock are rather limited in number and variety. Finding freight cars for my modern-era layout often turns into a treasure hunt, and living in Germany doesn't make it any easier. Fortunately, I don't need many cars, and the 14 cars I have now are sufficient to operate the layout. So I am in no hurry to expand my roster and can wait for good occasional finds.

A good alternative to purchasing is to scratchbuild cars not offered by any manufacturer. The size of O scale makes scratchbuilding and fabricating detail parts relatively easy. I have built a PS 5344 boxcar so far and thoroughly enjoyed it, so that it will definitely not remain the only scratchbuilt car on my roster.



10. PREX 907 switching the mill.

## CLEVELAND FLATS | 14

The same as with freight cars applies to O scale engines. Compared to HO, offerings are scarce, especially if you are looking for engines for a switching layout and your main focus is on perfect slow-speed operation. Unfortunately, the modern twin-motor (China drive) engines don't fit that bill. My three engines – my GP9, an old Weaver RS-3, and a scratch-built Baldwin S12 – see my blog at [mrhmag.com/node/20966](http://mrhmag.com/node/20966) – all have single-motor horizontal drives. I equipped them with Faulhaber 2842 and 3042 coreless motors to enhance running characteristics and to reduce current draw. These powerful motors run extremely smoothly and have a stall current of less than 1.1 amp. Now I can make my engines crawl at only ¼ scale mile per hour, which makes for very smooth starts.

Though there is still some work to be done and most of my freight cars have to be weathered, I am getting close to finishing this layout. I am

### Combo Right Clamp™

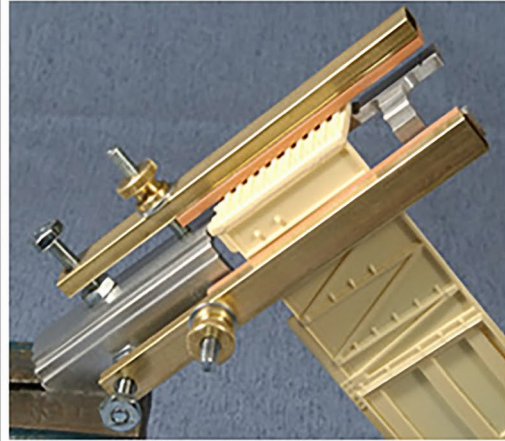

Combo Right Clamp™  
with cast resin boxcar

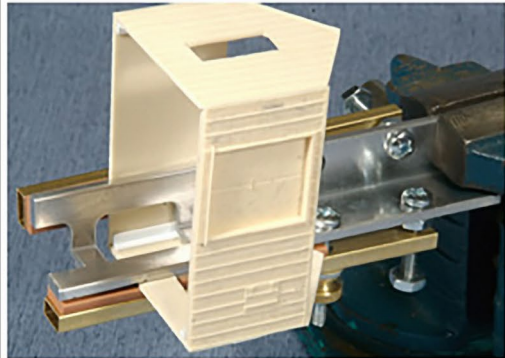

Combo Right Clamp™  
with Wolf Design Pump House

**Click here for  
all our products ...**

### Tools for Modelers

Coffman Graphic Solutions Co.  
1500 River Circle, Richmond,  
KY 40475-7907

## CLEVELAND FLATS | 15

glad I built it as a sectional layout. Once it is done, I will not have to dismantle it if I need the space it occupies to build something new. It only takes a few minutes to take it apart and store it or to set it up again when I want to run some trains.

To be honest, I would not mind having a little more space available to build a layout, but I also see the merits of such a small layout. To build and even finish it doesn't take ages, it can easily be moved and stored, and the costs are manageable. The best thing, though, is that you can have a lot of fun on a small shelf, even with big O scale trains.



[Click here for reader comments](#)



11. PREX 907 delivering two covered hoppers to the mill.



12. SMS 312 switching the warehouse.



13. Another view of SMS 312 switching the warehouse.

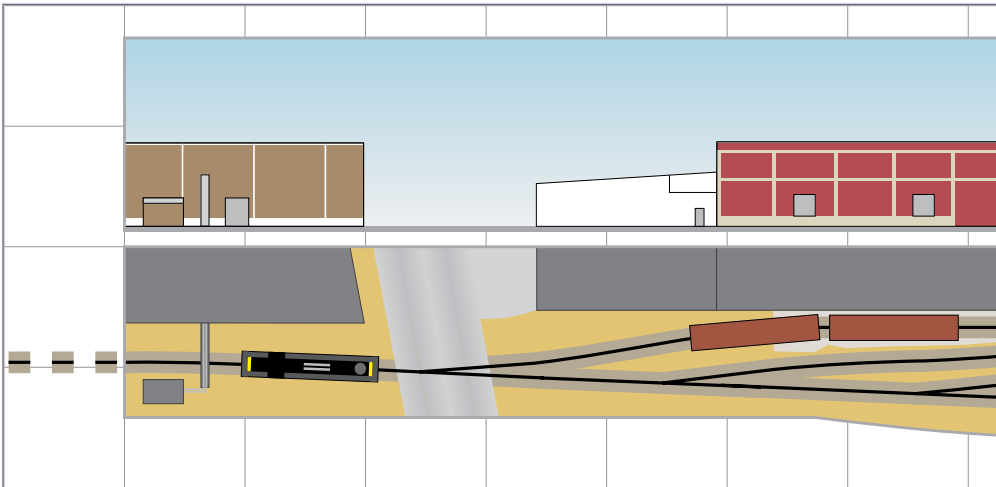



## KURT MATTHEY



Kurt started model railroading about 15 years ago to have a little pastime to keep him entertained on long winter evenings. It soon developed into a full-scale hobby for all seasons, but when the weather is fine, you will most likely find him riding his bike or motorcycle rather than running trains.

Kurt models both HO and O scale with his main focus on building switching layouts based on modern-era short lines. Scratchbuilding structures and rolling stock, and all the necessary research, planning, and problem-solving is the most enjoyable aspect of the hobby for him.

Kurt is a graphic designer and lives in Germany with his wife Petra, and Flo the cat.

---

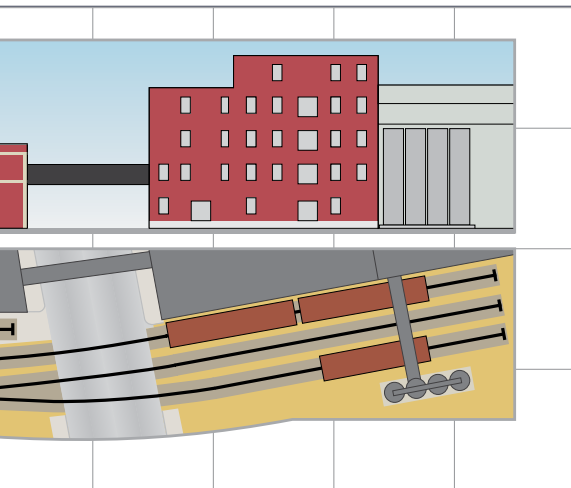

## LAYOUT PLAN

*See further info on following page ...*

# CLEVELAND FLATS | 19

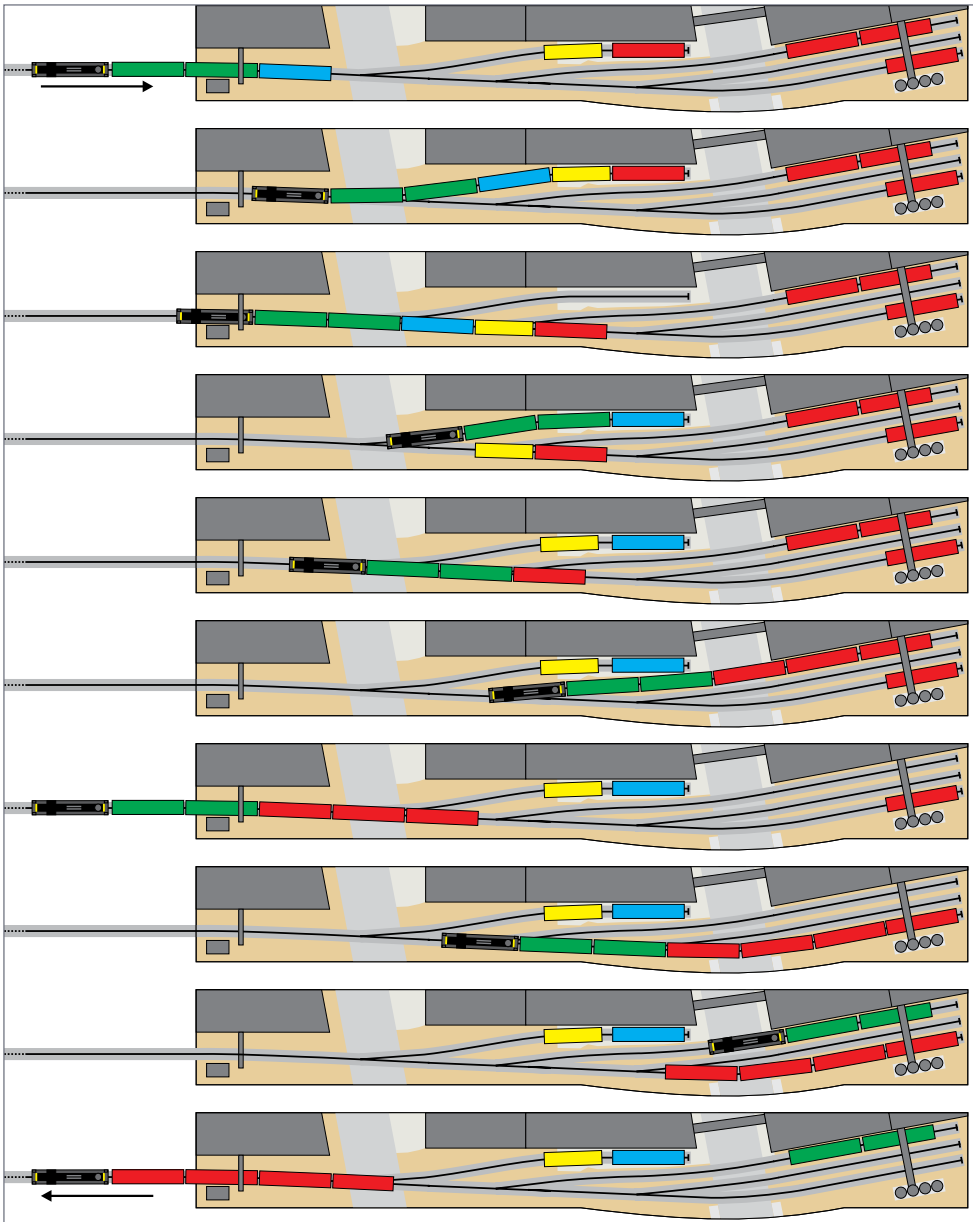

(See caption on top of page 20.)

# CLEVELAND FLATS | 20

14. An operating session begins with an inbound train with three cars to be set out. Two covered hoppers (green) are to be spotted at the mill building, a boxcar (blue) needs to be spotted at the right loading door of the warehouse in the middle. Four cars (red) are to be picked up, and a tank car (yellow) will need to be re-spotted to finish unloading.



**Click here for  
reader comments**

## ADVERTISEMENT

**Backdrop Junction**  
Your Stop for Railroad Backdrops

**Click Here** →

**For the Finest in Custom  
Designed backdrop**



[www.backdropjunction.com](http://www.backdropjunction.com)

## ADVERTISEMENT

**New Product Release**  
**OLD COBBLESTONE SHEETS**



**MONSTER**  
modelworks

**HO & N SCALES  
AVAILABLE**

[www.monstermodelworks.com](http://www.monstermodelworks.com)

# Message #2 from Joe Fugate

Founder, MRH and TMTV



## What topics does TMTV have?

TMTV has 400-some videos in nine categories, & we're adding 1-2 new videos per week ...



LAYOUTS



PLANNING



BUILDING



ELECTRICAL



MODELING



OPERATING



TOOLS/TIPS



PROTOTYPE



VENDORS/EVENTS

LOOKS GOOD, SIGN ME UP >>





# YES, IT'S A MODEL

*compiled by*  
**DON HANLEY**  
.....



[Click here for  
reader comments](#)

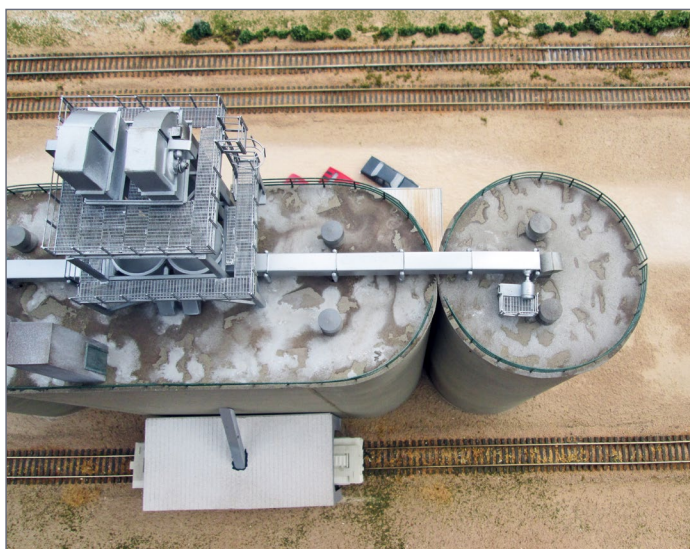

1. With the advent of cameras on drones, shots as this are no longer hard to get, nor as expensive as renting an air-plane for a few hours. Eugen Guerroero scratchbuilt this grain elevator. The

structure was modeled along the lines of many modern grain elevators. Unlike elevators built prior to the 1980s, most modern elevators no longer include an enclosed head house and gallery. Equipment such as legs, conveyors, etc., are outside an enclosed structure. The basic operations remain the same. The silos are weathered to replicate aging concrete.

► **MRH'S MONTHLY PHOTO ALBUM**

## YES, IT'S A MODEL | 2



2. Something a little different to begin with. Steve Hurt recreated a scene from the Frisco's Cherokee yard in 1978. GP35 #723 collided with two runaway carloads of sand. Luckily the crew was not hurt but 723 was destroyed. This is the unit just before it was scrapped.

Steve began with an old blue-box GP35, cutting off the body Dremel motor tool. The 567 prime mover started with a Walter's kit, but was sanded smooth so correct details could be added. He tapered the sills on the locomotive, added A-line steps along Details West pilots, fuel and air tank details, and traction motor lines. Steve scratchbuilt a sub-frame under the motor, then added the remains of the plumbing and wiring for the motor, along with scratch battery boxes. The truck side frames are from Stewart, but the rest of the trucks and bolsters were scratchbuilt so Keystone traction motors could be added, as well as brake hardware and sand lines.



The locomotive was photographed outdoors on a specially built diorama that includes the background cars and engine shop from the original prototype photo.

.....

## GET PAID FOR YOUR PHOTO

We pay \$40 per photo we publish. If you'd like to get your modeling in our photo feature, just start posting your photos on the MRH website, especially in the Weekly Photo Fun thread created each weekend.

See [mrhmag.com/help](http://mrhmag.com/help) for more on how to post an image. You need to be an MRH subscriber to post photos to our website, and becoming a subscriber is free, [just fill out this form here](#). ■

.....



3. D&H #805 is leaving Rutland, VT, with a single car and caboose destined for the D&H yard in Whitehall, NY. A Rutland freight passes by on the main heading for Burlington, VT. Gregory Wiggins "scratchbashed" the Camelback 2-8-0. He began with a Bachmann Spectrum 2-8-0, then reworked the boiler and tender using styrene, brass castings and custom-made resin parts. All the structures are scratchbuilt to match the prototype. The



# YES, IT'S A MODEL | 5



coal tower is by Model Power, reworked to look like one found in Bellows Falls, VT.

Gregory is better known as skiwiggy on the forum, and more of his work can be seen on his blog [mrhmag.com/blog/12730](http://mrhmag.com/blog/12730).



4. The peace and serenity of the Yakima River is interrupted by flange squeal and shaking ground, as BNSF 4177, under light dynamics, leads another empty grain train east from Auburn towards Pasco, WA. It's late summer, and grain exports are booming. This is just one of several grain drags that will slide through this canyon today. Each one will be heading east with empty cars, taking them back to wherever they came from, for fresh loads and many more miles.

Kevin Packard posted this photo on the forum thread Weekly Photo Fun. He highly modified and detailed an Athearn ready-to-run locomotive following pictures of BNSF 4177.

## YES, IT'S A MODEL | 7



5. The shop crews will have some work to do repainting in the necessary reporting marks after taggers made their marks on this Cedar Rapids and Iowa City 8007, a former Seattle & North Coast car.

John Day altered an MDC/Roundhouse FMC prototype kit. The graffiti on the model is an approximation for what is on the prototype. Decals are from Weathering Solutions (rust), Blair Line (graffiti), Smokebox Graphics (reflective tape), and home-printed CIC patch-out numbers including prototypically correct crooked stenciling.



6 and 7 [right]. GMTX 5000 and 425 have eased out of the roundhouse to get a little sun. TrainMasters TV producer Barry Silverthorn built the models that are part of the new TOMA (The “One Module” Approach) series that will begin airing in 2017 on TrainMasters TV. While Barry was taking the photo, he was rudely interrupted by a prototype freight train running through his scene [right].



[Click here for reader comments](#)



ADVERTISEMENT

# TCS *WOWSound*

Come meet us at one of the upcoming train shows listed below, bring your engine, and **get WOWSound installed** for the bargain **show price of \$97**.

Learn from the best as **we perform your WOWKit installion** 1-on-1 and return home with a tested WOWSound equipped engine ready to go.

[Click here to learn more and register for a spot at an upcoming show](#)



**The Great Scale Model Train Show**  
**Oct. 29th & 30th, 2016**

**Trainfest®** Trainfest  
**Nov. 12th & 13th, 2016**

**OkTrain**  
**Oc Show** Oklahoma City Train Show  
**Dec. 3rd & 4th, 2016**



WOWKits provide the only true turn-key sound conversion solution.  
[www.TCSDCC.com](http://www.TCSDCC.com)



# Railfanning the **GREAT LAKES WESTERN**

BY BRUCE PETRARCA, MMR

***A look at the PebbleCreek  
Model Railroad Club in  
Goodyear, AZ ...***

• INDEX

• TABLE OF CONTENTS



1. The BRC Clearing Yard in west-central Chicago.

**IT IS AN EARLY MORNING IN THE 1960S AND A** freight is headed to the BRC (Belt Railway of Chicago) Clearing Yard west of Chicago [1]. Meanwhile, a BRC engineer switches cars [2] bound for one of the many of the railroads that co-own the BRC: the Soo, EJ&E, IC, IHB or the Milwaukee.



[Click here for reader comments](#)

At the Great Lakes Western's (GLW) main yard in Hammond, IN [3], the yard crew is putting the finishing touches on the turn that will soon depart to Rockford, IL [4] and return. It will service the Rockford industries and exchange cars with the Chicago & North Western [5]. During the day, freights will come through Hammond Yard, dropping cars and picking up cars bound to points east (Toledo, OH and Fort Wayne, IN) and west (Kansas City, MO and St. Paul, MN).

Meanwhile, coal, byproducts, and coke are being loaded in Carbondale, IL [6]. They will be distributed to customers via the



2. Switching BRC Clearing Yard in west-central Chicago.



# GREAT LAKES WESTERN | 4



3. GLW's Hammond Yard is the central switching point and includes a passenger terminal. The Rockford turn has been built on the passenger siding and is ready to depart for Rockford. *Mark Pelletier photo*



4. Rockford, IL is the westernmost point modeled on the GLW. *Mark Pelletier photo*



5. C&NW interchange with the GLW is a (slightly) hidden track in Rockford, IL. The mainline to the right heads into westbound hidden staging.



6. Overview of Carbondale, IL.



7. Materials for the Inland Steel plant (coal, coke, and limestone) in Calumet City come by train to the Furnace siding near the backdrop. Ore is delivered by boat on the Calumet River in the foreground.

Hammond yard and by direct deliveries to Inland Steel on the Furnace siding [7].

In Aurora, IL, Bjorn Limestone [8] has loaded crushed and block limestone for the CB&Q to deliver along with interchange cars in a run to the GLW yard in Hammond. After the CB&Q leaves Aurora, a grain freight will probably arrive and exchange a dozen or so cars at Commander Elevator [9]. Later in the day, a GLW Aurora turn will arrive from Hammond to service the local industries, including Fox Valley Brewery [10].

Blue Island reefers are being iced in preparation for transfer to Diamond Meat Packers [11] for loading. This is the start of a busy day which can see the crew servicing the nine local industries and the car-float marine operation [12]. Local industries served include the Pullman Standard car facility, American Can, a

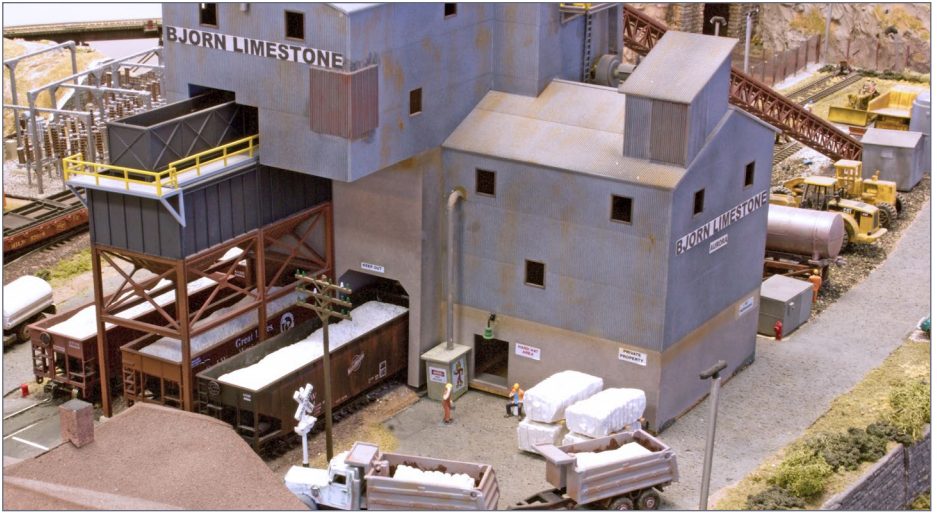

8. Bjorn Limestone in Aurora loads out crushed and block limestone.



9. Commander Elevator receives the unit grain freight. In the foreground is the arriving CB&Q turn.



10. Fox Valley Brewery is busy with inbound grain, coal, and other commodities along with outbound beer.



11. Diamond Meat Packers (red building) processes live-stock into sides and cut meat, as well as sausage. They also ship rendered oil and consume coal. Behind Diamond Meat is the Pullman Standard car shop.

## GREAT LAKES WESTERN | 9

machine shop, and a scrap yard. This crew is very likely to have cars going to and from the GLW locomotive service facility [13] accessed through the Hammond Yard. These deliveries can include coal, sand, ties, wheels, and diesel fuel.

Pickups from the industries in Calumet City [14] start the day for the crew operating in the shadow of the Inland Steel plant. Later the crew will move ingots and slabs between the Inland Steel basic oxygen furnace (BOF) [15] and the rolling mill [16] a few (scale) miles away. Local industries serviced include Standard Oil [17], Peterson Plastics, and a power plant.

It is specifically late 1963 or early 1964 in South Bend, IN, as evidenced by the billboard [18] atop the Studebaker receiving building featuring the 1964 model. The South Bend Turn of the GLW will be spotting cars at Bainbridge Cattle [19] to move livestock to Diamond Meat Packers [11] in Blue Island as well as other



12. The GLW Marine operation runs six-car (green) barges on the Great Lakes from this terminal in Blue Island.



13. A busy railroad has a well-stocked service facility, such as the GLW's.



14. Calumet City overview, looking away from the Inland Steel Basic Oxygen Furnace (BOF). The Furnace unloading crane is in the foreground [15]. The Inland Steel Basic Oxygen Furnace uses materials from the Furnace siding [7] and ore barges. The crane in the foreground unloads both.



15. Inland Steel's Basic Oxygen Furnace (BOF) and yard. The ore and commodities crane is in the foreground.

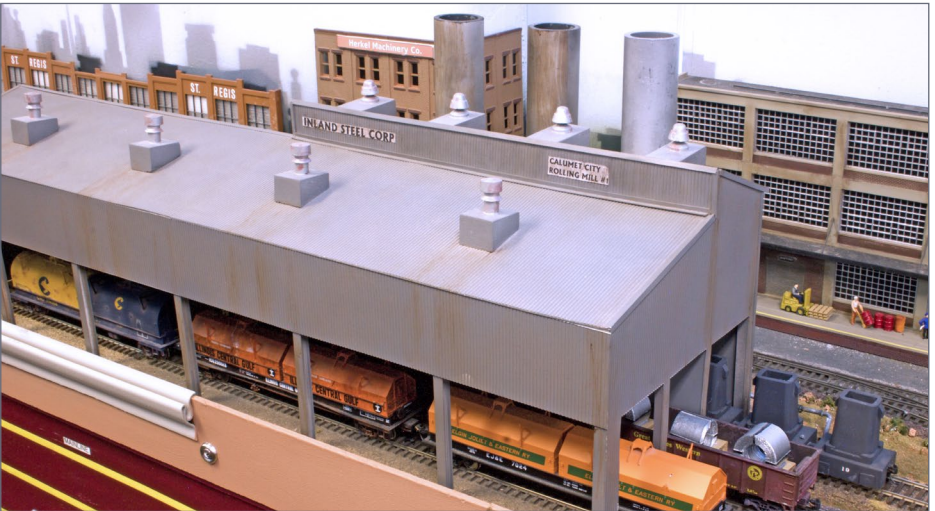

16. Inland Steel rolling mill.





17. Standard Oil in Calumet City has places to spot up to eight tank cars - there are even two off-spot in this photo. *Mark Pelletier photo*



18. Studebaker's assembly building in South Bend shows little warning of the impending move to Canada but it does advertise the 1964 Studebaker.

## GREAT LAKES WESTERN | 13

locations on and off the GLW. In addition to the GLW freight house [20] and Studebaker, local industries served include Bortz Feed, CTS Electronics and AristoKraft Cabinets. An early morning milk run heads into Hammond from the west [21].

Passenger operations, in the form of a C&NW RDC or full-fledged passenger trains, are occasionally added for operational variety and added complexity.

This is one variant of the scenario that the club works during twice-monthly member operating sessions. PCMRC also hosts guest operating sessions for local folks and has participated in the OpSig weekends in Arizona, called Desert Ops ([DesertOps.org](http://DesertOps.org)). This month (October 2016), PCMRC will be participating one more time.



19. Bainbridge Cattle ships livestock to Diamond Meat Packers, as well as other consumers.



20. A thriving business in LCL freight is handled by the South Bend GLW freight House. The passenger platform roof is in the foreground.



21. Early Indiana morning milk run headed into Hammond from South Bend.



22. PCMRC's garden layout circa 2002.

## Club history

In 1998, a few of the model railroaders living in the PebbleCreek development decided to start a club. I was not a modeler, but interested in model trains, so I attended the organizational meeting and came away as the founding secretary of the PebbleCreek Model Railroad Club ([pcmrc.org](http://pcmrc.org)). We worked on an HO sectional layout for a few years, storing it in cabinets in the woodworker's room.

PebbleCreek is a Robson community ([robson.com/communities/pebblecreek](http://robson.com/communities/pebblecreek)) in the western suburbs of Phoenix. Conceived as a golf-based “active adult resort community,” PC, as we call it, has grown steadily since its inception in 1993. It currently has about 4500 homes and about 7500 residents. Since we are supported by the homeowner's association, PCMRC members must be PebbleCreek residents.

Our first big break came in 2001 when we were asked if we would like to take some of the ground that was part of the Arts and Crafts Center and build a garden railroad. The developer even offered a few dollars toward the cost. This way, the Garden Division ([pcmrc.org/garden.html](http://pcmrc.org/garden.html)) [22] was the first permanent layout we had. But this story is about the Great Lakes Western, so let's get back on track.

Growth in PC necessitated a larger creative arts center. In the planning for the new building and deciding the use of the older facility, the PCMRC was offered the 19 x 41 foot former painting club room for a permanent layout. We waited almost a full year from the time we were offered the room until we got access to it in January, 2006.

During this year of planning, we discussed the scale, type of railroad, type of operation, and all the little nits and bits required for a layout. What came out of this process was a set of standards and

# GREAT LAKES WESTERN | 17

a benchwork and track plan [23]. We agreed on HO scale ([pcmrc.org/glwestern.html](http://pcmrc.org/glwestern.html)) with the ability to run in circles for those folks who want to watch trains run, as well as for open houses.

We decided to create a fictitious railroad, the Great Lakes Western [24], operating in the Chicago area during the late 1950s and early 1960s. The prototypically shorter freight cars of that era make for more switching action in our limited space.

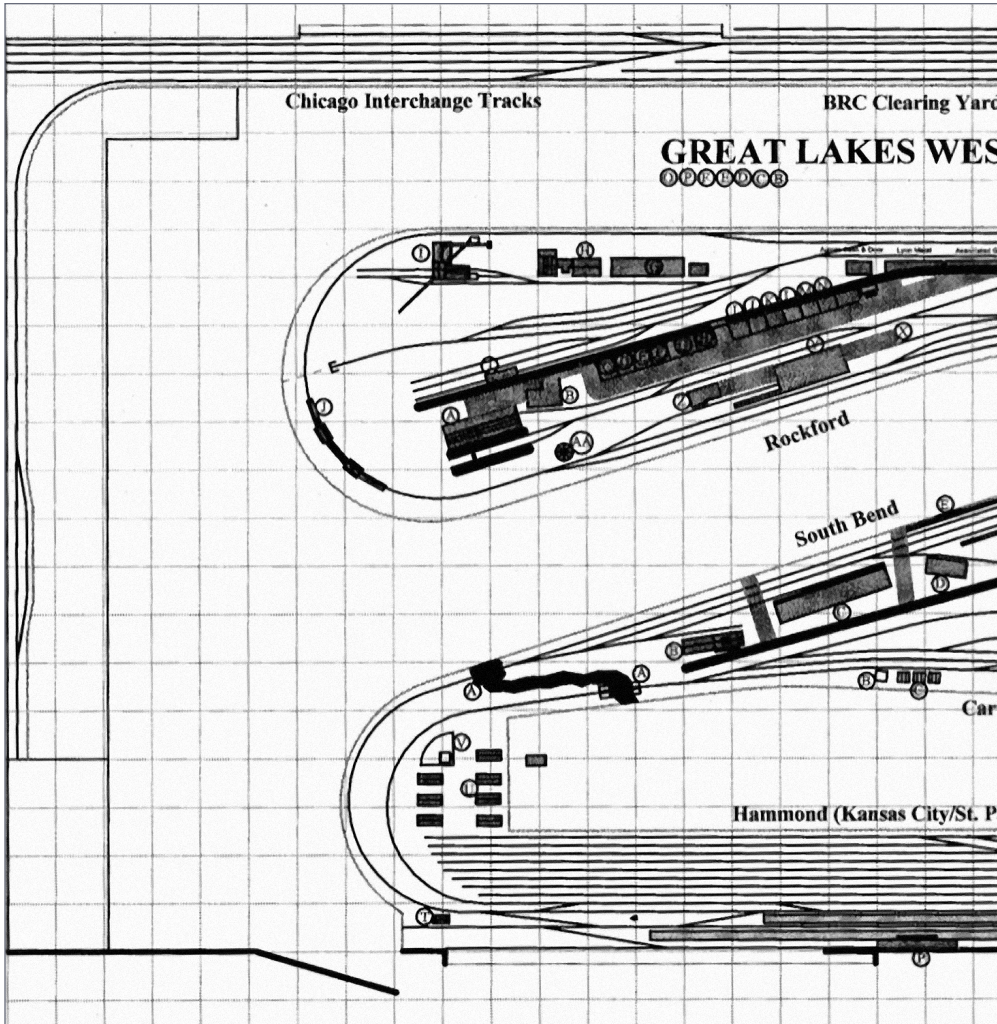

## GREAT LAKES WESTERN | 18

Chicago was selected for the number of different lines to interchange with, as well as the fact that almost any livery would not be too far out of place. A member can bring in a Pennsy consist to run.

The club layout, plus two home layouts belonging to members Gary Gelzer and Dick Vogler, who were a major part of the GLW planning process, were three of the 10 layouts participating in the inaugural Desert Ops weekend in 2012.

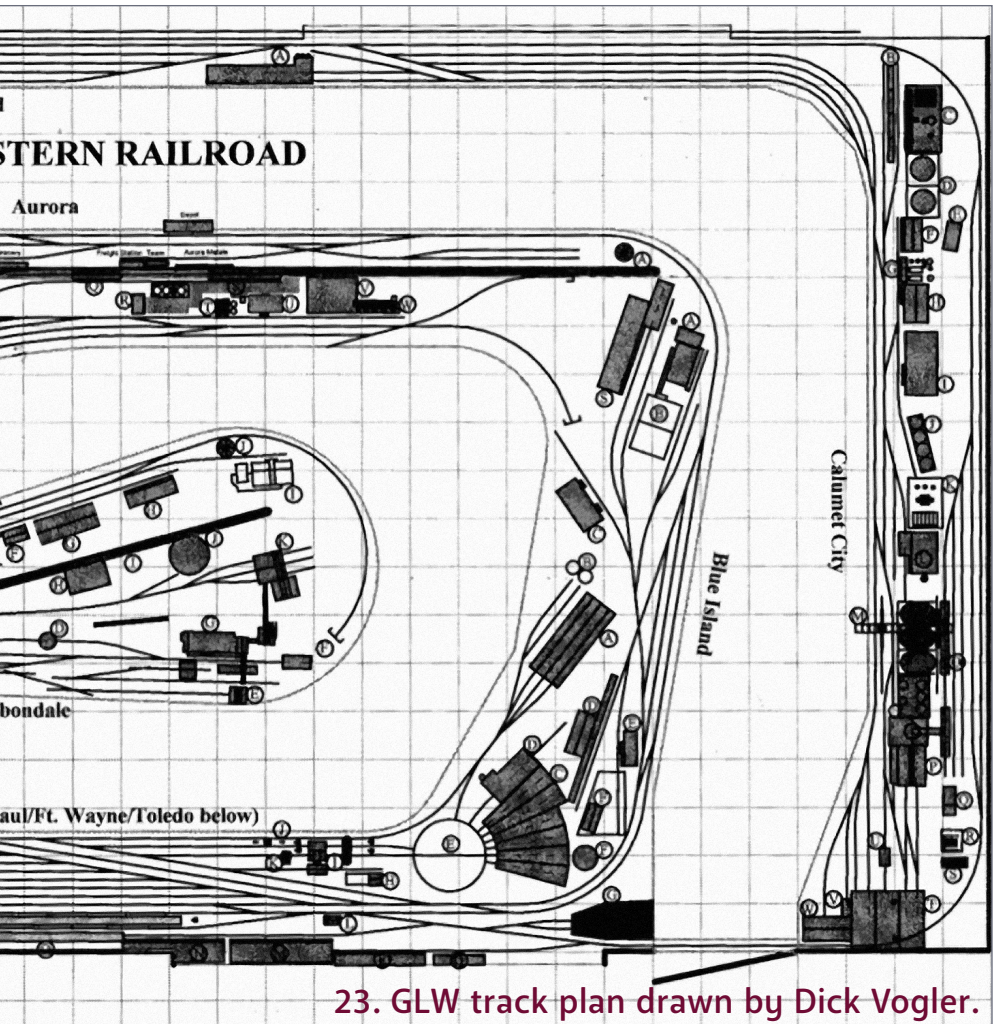

## GREAT LAKES WESTERN | 19

A group of about a half-dozen operators from the San Francisco Bay area came to Desert Ops 2012. One of their members insisted that they all operate on the GLW. After the session one of the group, who was not in favor of giving up a good pick for a club layout, told me that operating on the GLW was, perhaps, the most fun he'd ever had on a club layout. We were humbly thankful for his comments.

Things change as time goes by. The scenery is mostly done, but there are always details to add or revise. Recently, we added a new industrial area named East Hammond [25] to provide more switching opportunities. This area still needs scenic work.

If you are going to be in the Phoenix area, contact us from our web site ([pcmrc.org](http://pcmrc.org)) and we can show you around. And, perhaps, even work you into an op session.

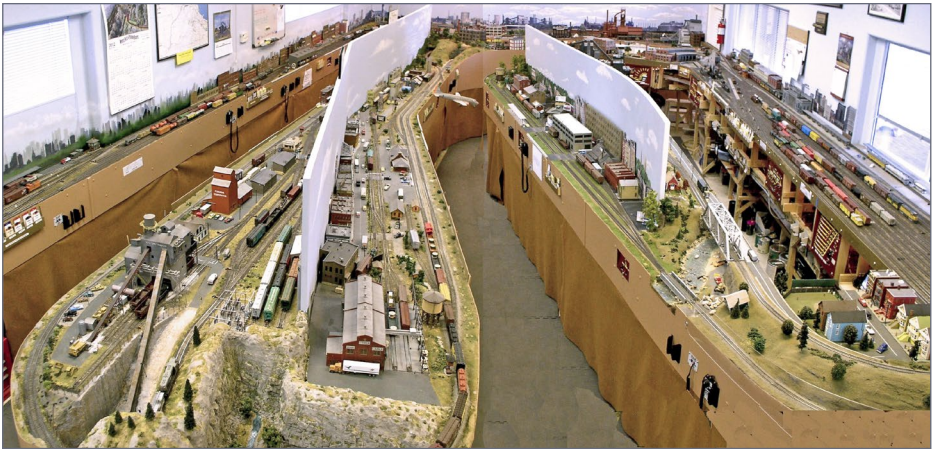

24. Aerial view of the Great Lakes Western railroad. *Mark Pelletier photo*



## GLW LAYOUT DETAILS

The benchwork construction is L-girder with Homasote underlayment. Main ground contour is plaster over cardboard.

Digitrax simplex radio DCC is used. Three boosters drive 19 PSx circuit breakers to isolate jobs from one another. The club owns UT4 throttles for operators to use. If a member brings his own simplex radio throttle, it may be used. The club's sole DT400R resides in a drawer, rarely needed.

A LocoBuffer-USB interfaces our computer and the Digitrax system. JMRI DecoderPro is used to keep track of the roster. There is a Wi-Fi connection for WiThrottle or Engine Driver (cell phone-based) control.

Atlas code 83 track is used exclusively on the GLW.

All rolling stock is club-owned or on "long term lease" from members.

All locos are DCC decoder-equipped. Many have sound. Adding sound to the remainder is an on-going project.

Technical standards for rolling stock include:

- NMRA car weighting
- Kadee couplers
- Metal wheels
- Glazed windows





25. East Hammond industrial area is a work in progress on the GLW. ✓



[Click here for reader comments](#)

***TrainMasters TV is part of the MRH product family.***

*TMTV members not only get great network TV level videos, they help pay for MRH and keep it free ...*

**NEW!**

# Back To the Basement



~~\$19.99~~

\$14.99

Instant download

~~\$36.99~~

\$29.77

+ S&H

DVD

## Layout building series from TrainMasters TV *by Miles Hale*

Follow a master model railroader on his basement layout journey ...

Formats available ...

Almost 4 hours of video



DVD

2 disks

DOWNLOAD



9 files

Click me to  
**GET IT NOW >>**

From the MRH Store: [store.mrhmag.com](http://store.mrhmag.com)

# RE-PAINT THE ATHEARN GATC 2600 AIRSLIDE HOPPER



BY BOB RIVARD

## *A study in detail weathering ...*

**TO ME, THERE IS NOTHING MORE EXCITING THAN** discovering that perfect freight car photo for my 1977 modeling era. I frequently search the internet for suitable candidates. Web sites such as Fallen Flags and Other Railroad Photos ([rr-fallenflags.org](http://rr-fallenflags.org)) and Railroad Picture Archives.net ([rrpicturearchives.net](http://rrpicturearchives.net)) are a few of my favorite sites.

Lately, I have gravitated to Airslide covered hoppers. One reason for this is the availability of a wonderful out of the box model. The Athearn GATC 2600 cu.ft. hopper provides a perfect starting point for my re-painting projects. The model has a high level of detail such as scale wire grab irons. In most cases I can easily remove just the lettering by wet sanding. The most challenging part of these projects can be the lettering.

• INDEX

• TABLE OF CONTENTS



[Click here for reader comments](#)

The two projects I will describe are lettered using decals from Dan Kohlberg Decals. Dan provides not only a lettering diagram but also nice prototype photos. This for me is invaluable, especially when it comes time to weather my models.

## GACX 45992

The project begins with an Athearn kit found on eBay, with lettering sanded away, a mounting plate installed, and new paint sprayed before relettering.

ADVERTISEMENT

Your Dream,  
Our Ambition!



[www.anemodel.com](http://www.anemodel.com)

ADVERTISEMENT

**WOW!**  
What scale is this?

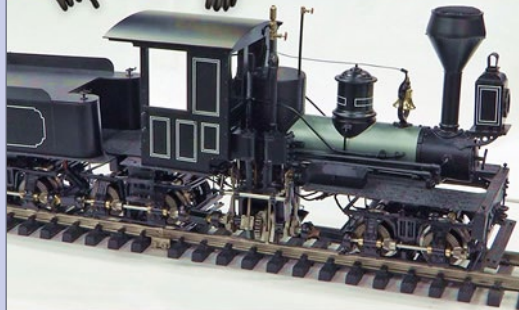

[Click for the answer ...](#)

MISSOURI LOCOMOTIVE COMPANY

# GATC AIRSLIDE HOPPER | 3

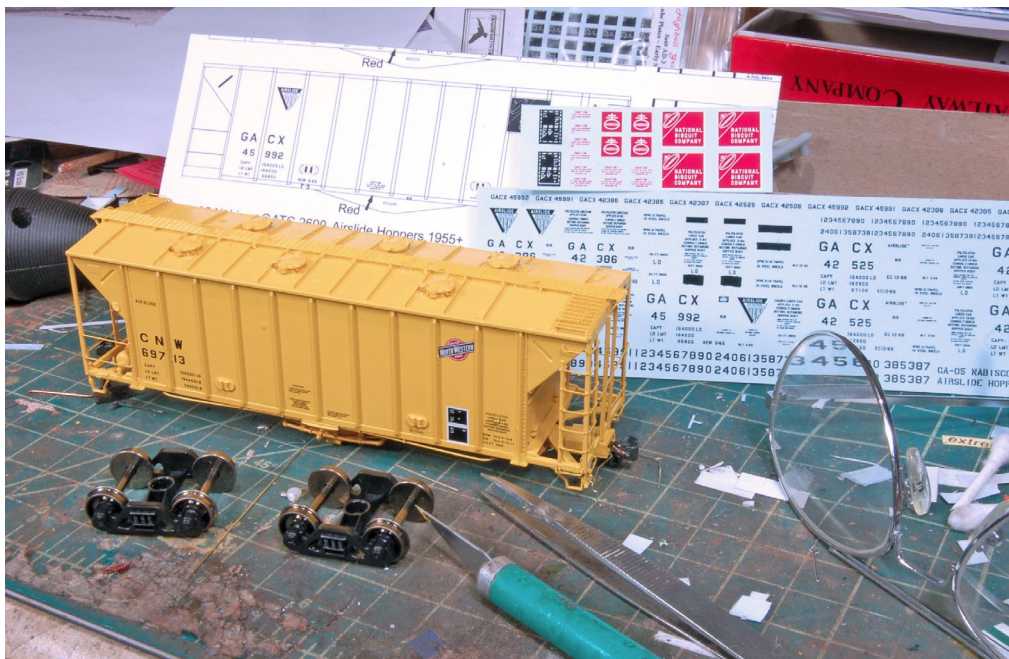

1. The GACX 45992 sports the triangle reinforced slope sheets. Athearn offers this option. These models are not in current production but I was able to find this model on eBay. I start by removing the trucks, and replace the plastic couplers with the tried and true Kadee #5.



[Click here for reader comments](#)

## GATC AIRSLIDE HOPPER | 4



2. The car lettering comes off easily when sanded with 400-grit wet-dry sandpaper. A few puddles of decal solution are used on the surface for the wet sanding process. After I cut a mounting plate from .010" styrene for the Nabisco logo my model is ready for a trip to the spray booth.



3. Using the prototype photo, I mix a batch of gray using Scalecoat II White and Locomotive Black. Nothing scientific here. I just add drops of black to the white until the mix looks right. I like using Scalecoat II for my projects because the glossy finish simply provides the best surface for applying decals.



[Click here for reader comments](#)



# GATC AIRSLIDE HOPPER | 6



4. After allowing the model to dry I'm ready to apply the decals. Dan's wonderful photo, along with the lettering diagram, makes the lettering process a joy.

# GATC AIRSLIDE HOPPER | 7

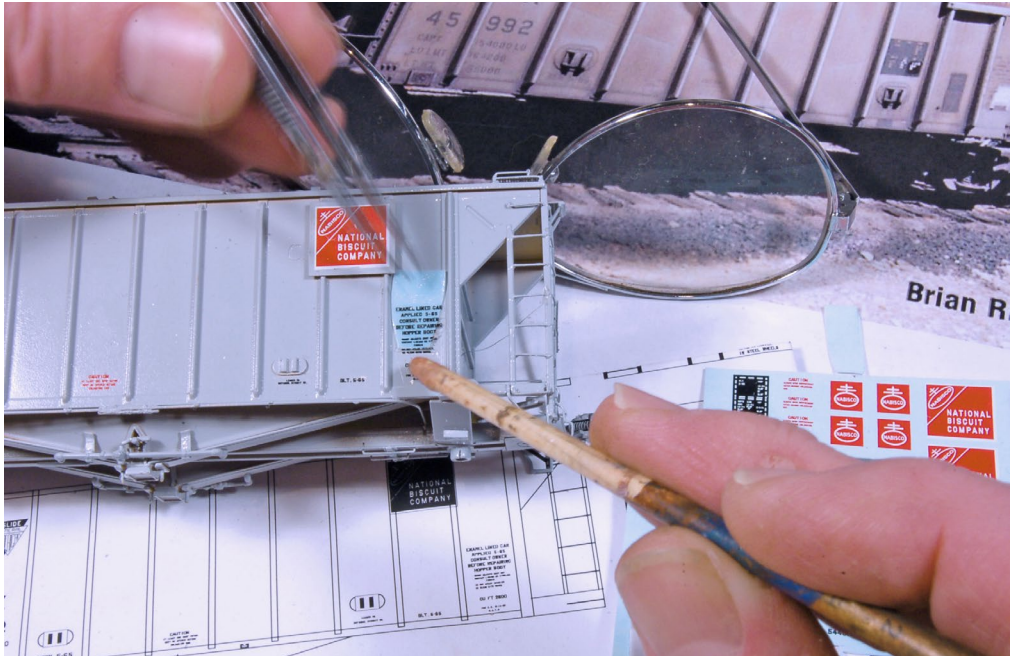

5. This car is lettered from set number GA-05. The decal film Dan uses on his decals is ultra thin and will tear easily. The best way to apply these is to slide the lettering off the backing paper onto the location. A few seconds of dipping the decal in warm water is all you need before sliding the lettering into position.



[Click here for reader comments](#)



6. I duplicate the prototype lube plates from multiple sets. After I have applied all of the decals, I set the model aside to give the decals time to dry. I then use a new sharp X-Acto number 11 blade to lightly poke multiple tiny holes through the decal film. I apply Solvaset decal solution to the surface. Capillary action allows the liquid to seep under the film and insure a good painted-on lettering look. The ACI plates are MicroScale set MC-4280.



7. After it dries again, I spray on Testors Dullcote to give the model a dead flat finish. The decal film edges all but disappear. Next, I use Floquil Grimy Black and lightly spray some weathering onto the underframe and couplers. I use a 50/50 mixture of thinner to paint for weathering.



[Click here for reader comments](#)

# GATC AIRSLIDE HOPPER | 10



8. Now I turn my attention to the trucks. The prototype photo indicates a roller bearing style truck with two center springs. Kato's 602 Barber S-2 roller bearing truck is a perfect choice. Next as I spray Grimy Black onto the trucks. Rolling each truck back and forth will ensure coverage on the wheel sides.



9. I spray some rust color on the couplers.

***TrainMasters TV is part of  
the MRH product family.***

***TMTV members not only get great network TV level  
videos, they help pay for MRH and keep it free ...***



10. Because this series of hoppers was painted in the mid-'60s, some moderate weathering would be required. As I observe prototype photos of these cars I notice a common weathering theme. The edge of the internal slope sheet is clearly visible. Why this occurs I'm not sure. I only know I need to come up with a way to duplicate this interesting effect on my models. I decided that masking off this area before the airbrush weathering would be the best way to simulate this effect. I start by using a pencil to make a mark two feet from the bottom on the center rib.



11. See on the prototype photo how noticeable the effect is.

**Want to help keep  
MRH free?**

**Then *click* on ads!**





12. I use the prototype photo as my guide and mask off the bottom portion of the slope sheet weathering line first. It is extremely important to make sure the tape is not very sticky. I accomplish this by pressing the tape onto a hard surface and removing it. I repeat this many times until most of the adhesive is gone. This step is important so that your lettering does not lift off when you remove the tape after the first weathering application.

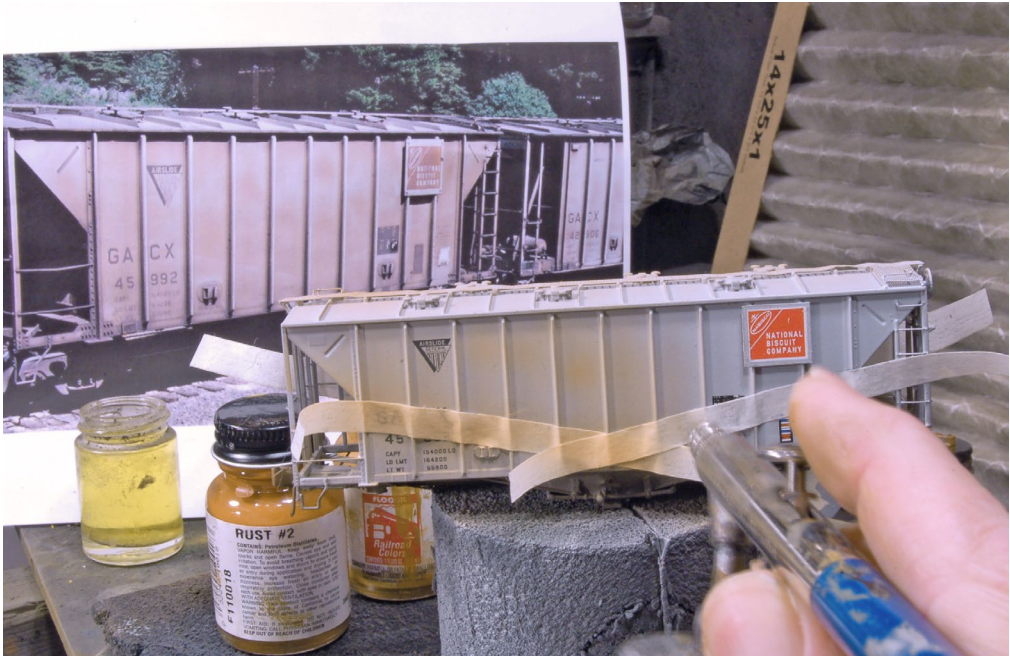

13. Using my airbrush, I make very light passes with Floquil Rust.



[Click here for  
reader comments](#)

# GATC AIRSLIDE HOPPER | 16

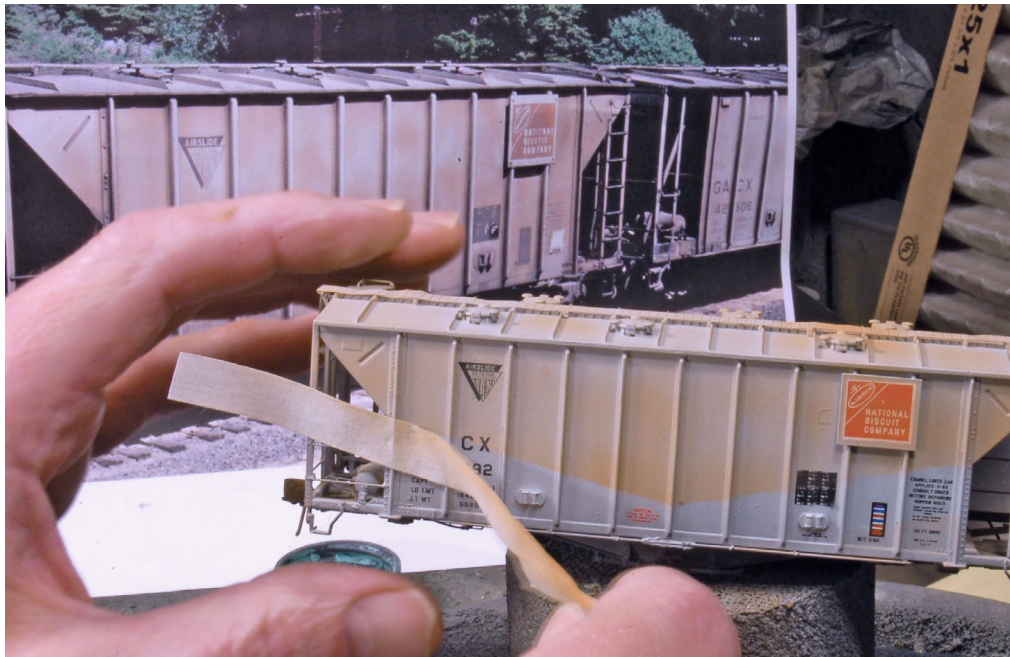

14. Next, I carefully and slowly remove the masking tape.



15. My worst fear! Sure enough, some of the lettering came off with the tape. Fortunately, I was able to find the correct lettering in an extra decal set to replace the missing lettering.



[Click here for  
reader comments](#)

# GATC AIRSLIDE HOPPER | 18

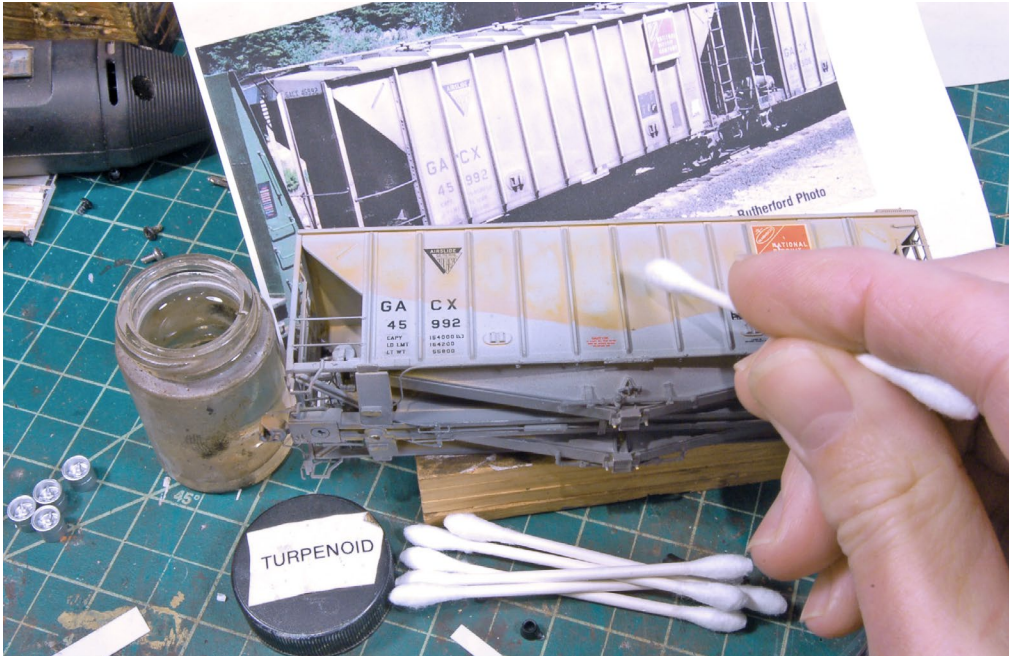

16. I use a Q-tip to remove patches of weathering. The swab is barely moistened with Turpenoid thinner.

# GATC AIRSLIDE HOPPER | 19



17. I clean the face of the ribs using a new Q-tip and Turpenoid thinner.



[Click here for reader comments](#)

## GATC AIRSLIDE HOPPER | 20

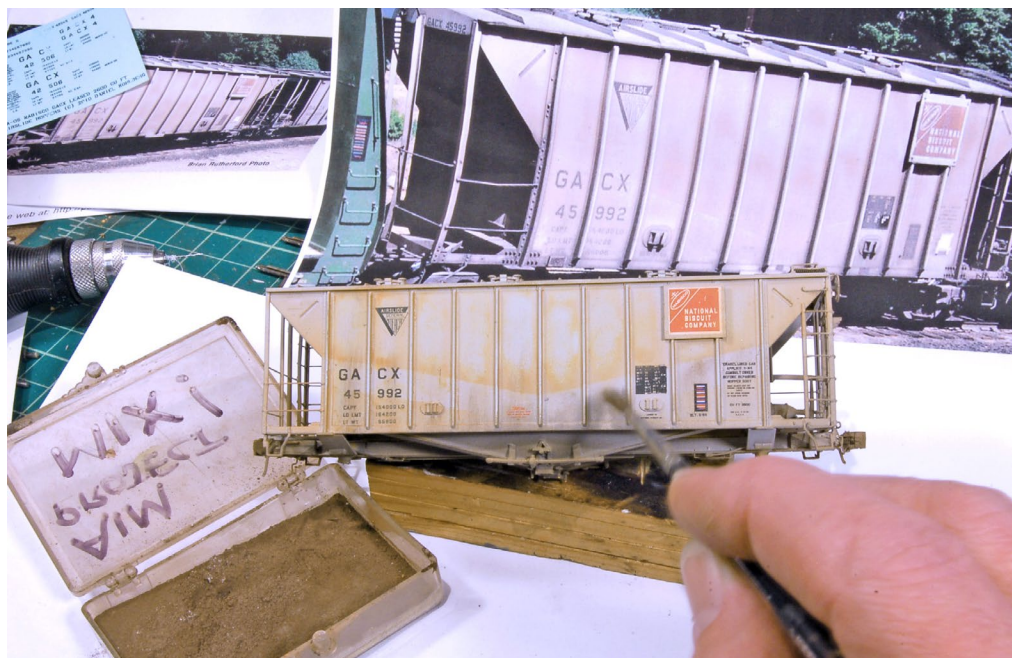

18. I add some final weathering to the lower portion of the car using some rust-colored weathering powder.



19. I clean the ribs one last time. The weathering is almost complete.



[Click here for reader comments](#)





20. Before I install the trucks I apply weathering powder to the wheel sides and springs.



21. The powders really enhance the intricate detail on the trucks.



**Click here for  
reader comments**

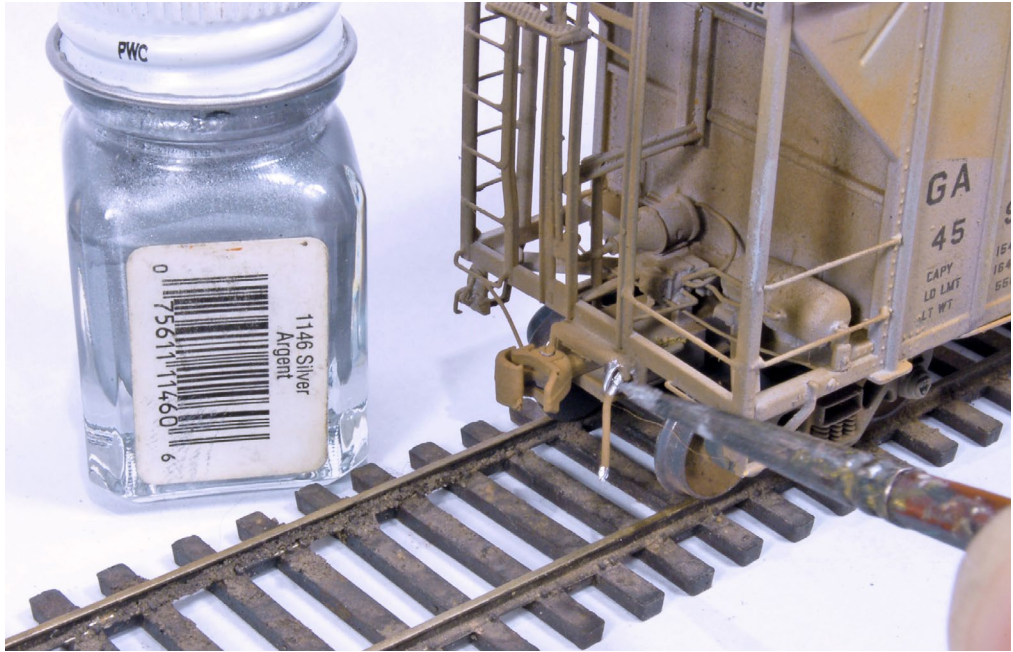

22. The weathering process is almost complete. One final step is to highlight the air hose coupling detail with silver paint.



23. I studied the prototype photo one last time and noticed some areas of dark grime and dirt on the end ribs, really accenting the rivets. I decide to duplicate this effect by brushing on some grimy black powder.



[Click here for reader comments](#)



24. Here is the finished car in the yard at Cardigan Junction.

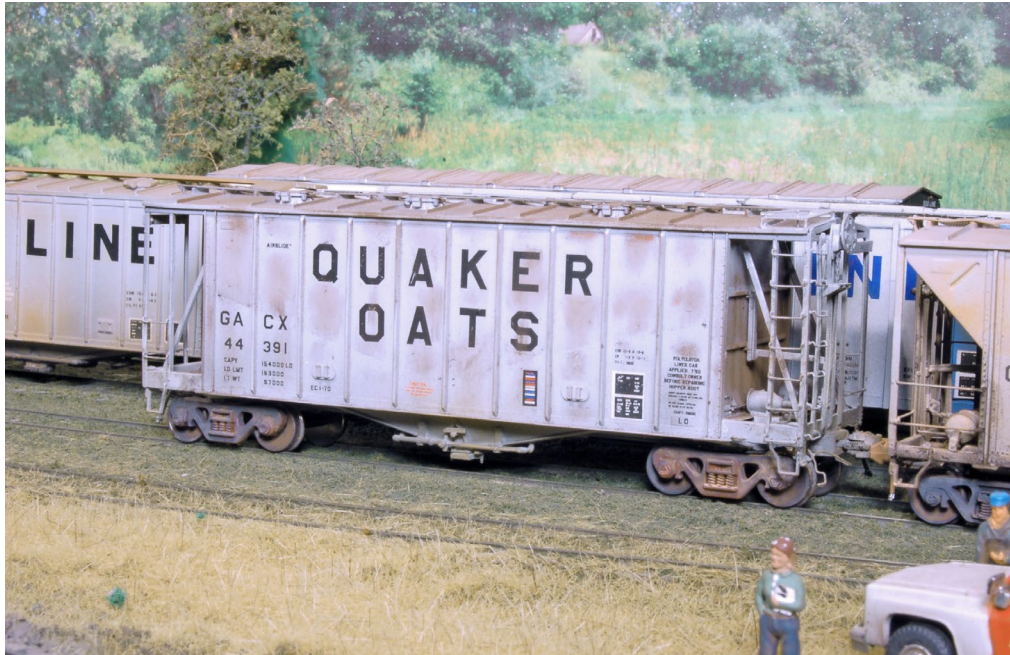

25. This Quaker Oats hopper was modeled using Dan Kohlberg Decals set GA-06.



[Click here for  
reader comments](#)



26. I took this shot of the two Airslide hoppers at Cardigan Junction.

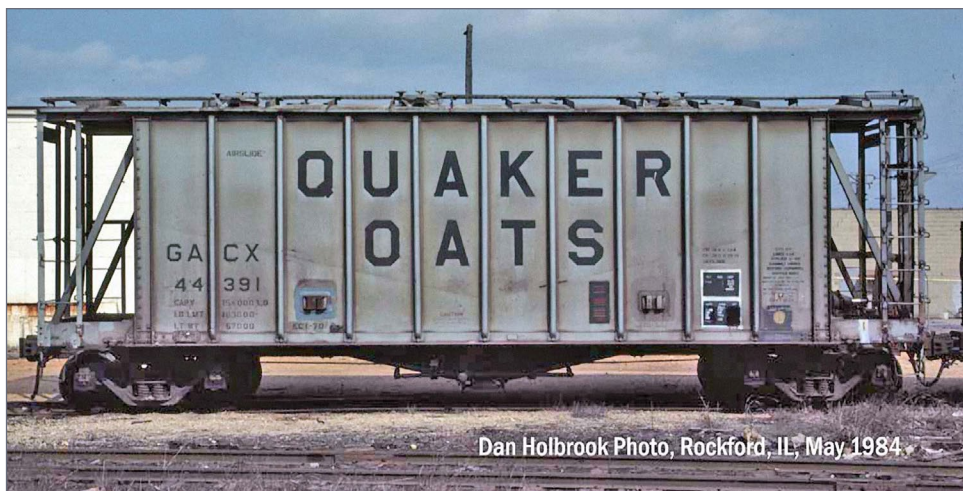

Dan Holbrook Photo, Rockford, IL, May 1984

27. This photo of GACX 44391, taken by Dan Holbrook, really inspired me to faithfully duplicate the weathering on my model.



[Click here for reader comments](#)

## Do ALL your model railroading friends know about MRH?

WE CONTINUE TO BE SURPRISED BY HOW MANY MODELERS STILL HAVE NEVER HEARD OF US – SO SPREAD THE GOOD WORD ABOUT MRH!



BOB RIVARD

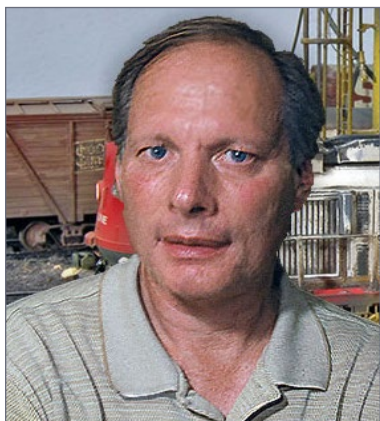

Bob Rivard has been fascinated with trains since the age of 5 when he received his first train set, the proverbial Lionel.

He really enjoys his job at KARE TV and has worked there for 34 years as a broadcast technician. He runs the robotic cameras during the 10 p.m. news. ■

ADVERTISEMENT



**1<sup>st</sup> choice for model railway supplies and service.**

**Expedited mail service available across North America.**

Click to visit:  
**WWW.CVRCO.COM**  
**1 800 464 1730**



# TRACK CLEANING THE EASY WAY

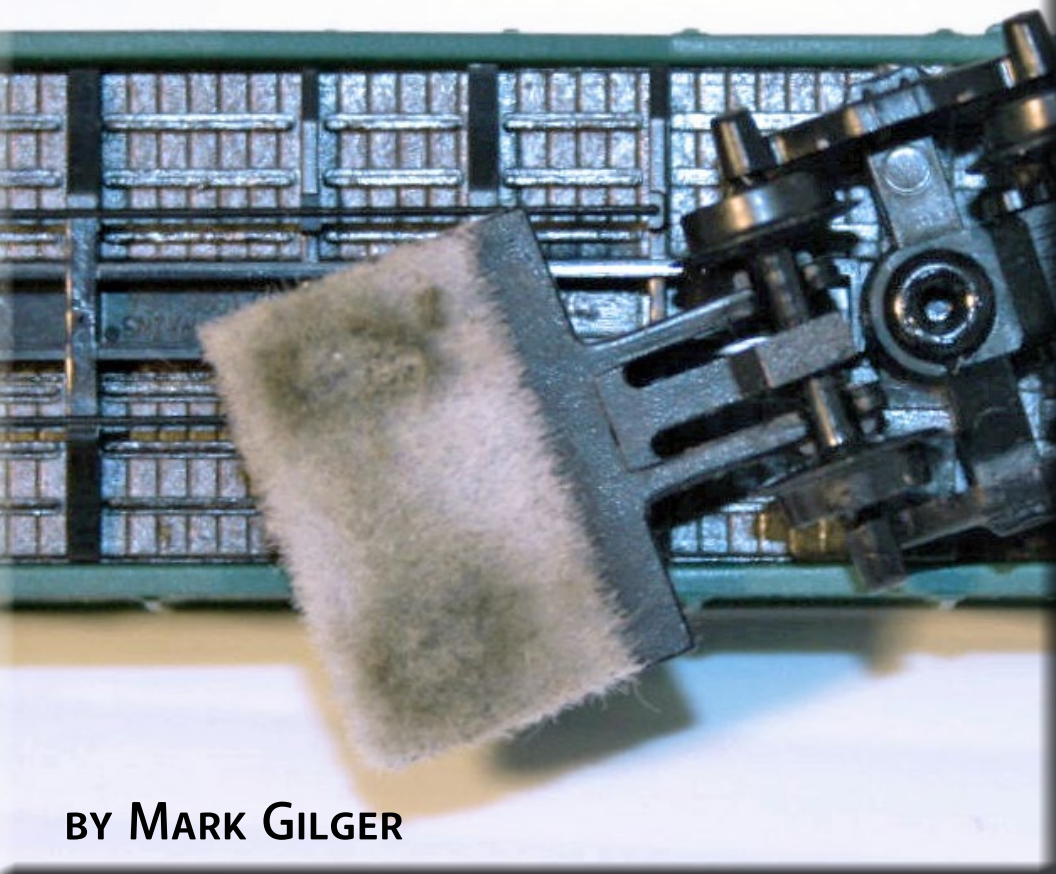

BY MARK GILGER

## *Cars that constantly clean ...*

**I RETURNED TO N SCALE ABOUT TWO YEARS** ago with a small 16' x 2' layout. I found it a challenge to keep the track clean enough to prevent the engines from jerking when they encountered areas of dirty track.

One of the products recommended by others is a paste-type cleaner. You apply a very small amount to your finger, and run it along the track.

• [INDEX](#)

• [TABLE OF CONTENTS](#)



[Click here for reader comments](#)

Another method is to place a small amount on the wheels, and let the engine do the work as it travels around the layout. However, I felt both methods were lacking. If too much was applied, engines would slip, not having the needed traction for even the smallest grades. In addition, the application of paste was difficult in tight and restricted areas.



## A better way had to be devised!

As an amateur radio operator, one of my other hobbies is refurbishing old tube-type radios. DeoxIT, by Caig ([caig.com](http://caig.com)), is a product often used to clean electrical contacts in radios. It can be found in many places, including Amazon and Radio shack, and is sold as a spray or in bottles. I use the DeoxIT D5, which is a 5% concentrate. DeoxIT D100 is a 100% concentration.

Caig advertises: “DeoxIT helps bring old systems back to life! DeoxIT is a contact cleaner, conductivity enhancer, and lubricant. It dissolves

1. DeoxIT D5 that I use as my track cleaning agent.

## TRACK CLEANING | 3

oxidation and corrosion on metal surfaces, fills in microscopic gaps, and reseals surface for better contact to enhance the flow of electricity. It rejuvenates electrical equipment by improving connector performance and reliability. This excellent cleaner and deoxidizing agent helps protect your electronics equipment, yet does not contribute towards ozone depletion.”

One day while surfing through some N scale sites, I saw Woodland Scenics Dust Monkeys. They are sold for both HO and N scale. The applicator snaps onto the axle of just about any rolling stock. It was designed to dust off the tracks as it moves over your track.



### 2. Woodland Scenics Dust Monkeys.

## TRACK CLEANING | 4



3. The dust monkey attached to my cleaning gondola.

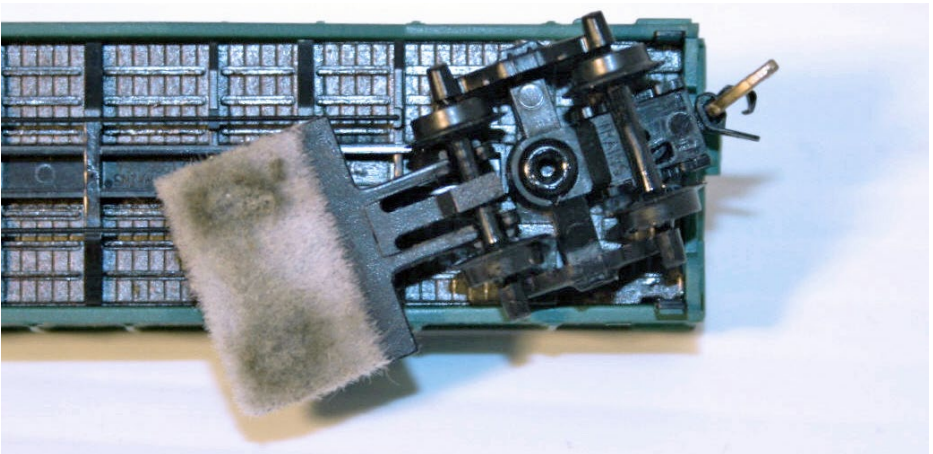

4. The DeoxIT and sprayed on the dust monkey cleaned a lot of dirt and grime off the tracks.

It occurred to me that these might work well for the application of the DeoxIT D5. I bought a package, and set out to test its effectiveness.

I put two applicators on a gondola. After spraying a small amount on each applicator, I pulled or pushed it through all the mainline

## TRACK CLEANING | 5

track, until I no longer noticed jerking, and the engines ran smoothly. For side tracks, I ran it back-and-forth over the entire length of the siding, perhaps three or four times, before moving to the next siding. It was approximately five months before I noticed the engines were not moving as smoothly, at which time I repeated this process. It has now been about 1½ years since the first application, and I'm 100% satisfied with both the DeoxIT D5, and Woodland Scenics Dust Monkeys. I also don't see a need to replace the used Dust Monkey with a fresh one anytime soon.

The pictures indicate the accumulation after approximately an hour-long track cleaning session.

The thing I find most appealing about this type of application is that I can include it in the regular operations of the railroad, by adding the cleaning car to a regular consist. As it moves throughout the layout it's doing the job it was designed to do. Another important advantage is that using this method, you can get into tight or restricted access areas with ease. Simple and easy ...



[Click here for  
reader comments](#)

### MARK GILGER



Mark Gilger is retired from the process control industry, and lives with his wife and two dogs in Doylestown, Ohio. His primary interest is outdoor G scale operations. Mark's MM&G railroad consists of 1,750 feet of track with over 45 turnouts. He holds several operating sessions per year for the local BSGR (Buckeye State Garden Railroad) group. Readers may

learn more about Mark's layout at: [mmg-garden-rr.webs.com](http://mmg-garden-rr.webs.com).

Mark also has a 16x2-foot indoor N scale layout that he uses primarily in colder and inclement weather. The N scale layout is operational, although it is not yet scened.

---

**Want to help keep  
MRH free?**

**Then *click* on ads!**



# HEADLIGHTS:

## Tips and Tricks with SMD LEDs

BY BILL BEVERLY

### *LED headlights that look incandescent ...*

**FOR THE PAST FIVE YEARS I HAVE BEEN EXPERIMENTING** with and using surface-mounted device (SMD) LEDs to light my engines. SMD LEDs are tiny [1] – think about the size of a pinhead and then think smaller. This makes them ideal for lighting things like locomotive headlights, classification lights, marker lights, and other small enclosures that are could use some light.

I have been using two sizes, the 0603 and 0402 Golden Whites with pre-soldered leads. You can get the LEDs without wires and attach your own, but to keep it simple we are going to talk about the pre-wired ones in this article. You can buy these LEDs online from many vendors such as Richmond Controls, Traintek, Amazon, and eBay. Some local hobby shops are also starting to stock them.





[Click here for reader comments](#)

The pre-wired LEDs have two wires, a slightly longer (+) positive wire and a slightly shorter (-) negative wire. To prevent damage to the LED, a resistor is required in series with one wire whether you are running DC or DCC. It is amazing how bright these little LEDs are – a 1000 Ohm (1K) ¼ watt resistor gives a fairly bright light. I typically use between 1.5K and 3.3K to reduce the brightness, depending on where I am installing the LED.

A few precautions are needed when using these LEDs. They have a miniature circuit board that can easily short-circuit if it contacts metal. I have been experimenting with various glues to smear over the LED to protect them. When dry, the glue forms a protective barrier. Aleené's Clear Gel Tacky Glue works best for me. It dries clear and can be mixed with paint to tint the LED.



1. To give you an idea of the size of the LEDs, here are a few 0402s on top of a dime. The LEDs are about the size of Roosevelt's eye.

## SMD LEDs | 3

I use these LEDs in steam engines to replace the original bulbs when I install DCC. The old bulbs have a nice golden glow like a 1930s steam engine headlight. But these LEDs have an almost bluish tint. Depending on where I am installing the LEDs, I will mix a little bit of Tamiya clear acrylic paint with Aleene's Glue to tint them. I put a drop of glue on waxed paper, add a small drop of Tamiya, and mix it in. I then smear the mixture on the LED, making sure to cover the tiny circuit board and the joint where the wires solder to it. I allow a few hours for the glue to dry completely. After the glue dries, I test the LED and add another drop of paint if needed.

I use clear yellow and clear orange to give a nice yellowish glow to a headlight. For steam engines, clear orange and clear red are used to color a pair of LEDs for a firebox flicker. I use clear green to tint an LED in a classification lamp and caboose marker lamp.



2. Tamiya Acrylic Paints come in a variety of colors. Make sure you use the clear versions. The Clear Green is X-25, item 81025, Clear Orange X-26, item 81026, Clear Red X-27, item 81027. Not shown in the picture is Clear Yellow X-24, item 81024.

## SMD LEDs | 4



3. I use the Radio Shack clips as holding clamps. I buy heat-shrink tubing from an electronics vendor like Mouser ([mouser.com](http://mouser.com)) or Digi-Key ([digikey.com](http://digikey.com)). It comes in various sizes and colors, and in three-foot lengths. These vendors also sell resistors. I found the decoder wire on sale at a local hobby shop. Decoder wire comes in 10-foot lengths in a variety of colors.

Let's talk about testing the LEDs. I like to build little test tools to help me manage the LEDs. One caution about the LED wires: they have a lacquer coating that can easily be scratched off. This will lead to a short if it comes in contact with metal. This is a problem if you are installing them in a brass engine or a metal maker lamp. To protect the wires, I handle them with padded tweezers and clamps.

## SMD LEDs | 5

I found a few bags of 1-1/8" smooth copper-plated clips at Radio Shack. To protect the LED wires when clamped, I attach a short piece of heat-shrink tubing to the tip. I then solder the clips to a short section of circuit board tie. This comes in handy to hold the LED wire in one clip and a decoder wire in the other clip when soldering them together.

Normally when I am working with LEDs, I am also working with a DCC decoder. I built a few gadgets to help program the decoder and test the LEDs before I install them in my engines. It is nice to know they will work together after everything is installed in the engine.

The first gadget [4] I call a spider. It is simply two clamps soldered to a section of copper PC tie with an electrical gap in the center, and a few different resistors soldered to one of the clips. I use the spider to test the LEDs. I attach the LED wires to the clips, and touch the power source to one resistor at a time until I get the brightness that I like.

The second gadget is a speaker with clips, and the third gadget is a motor with clips. These gadgets are tools for programming a decoder.

Let's put all of these gadgets together, program a decoder, and test the LED.

In the center of [5] is a Soundtraxx Econami decoder. The orange and gray wires go to my test motor. The motor allows the decoder to give feedback when I am programming it through JMRI. The two purple wires go to a speaker. I use this to adjust the sounds. The red and black wires go up to my NCE DCC system. The white and blue wires attach to my spider LED tester. I clip to different resistors until I get the brightness level

## SMD LEDs | 6

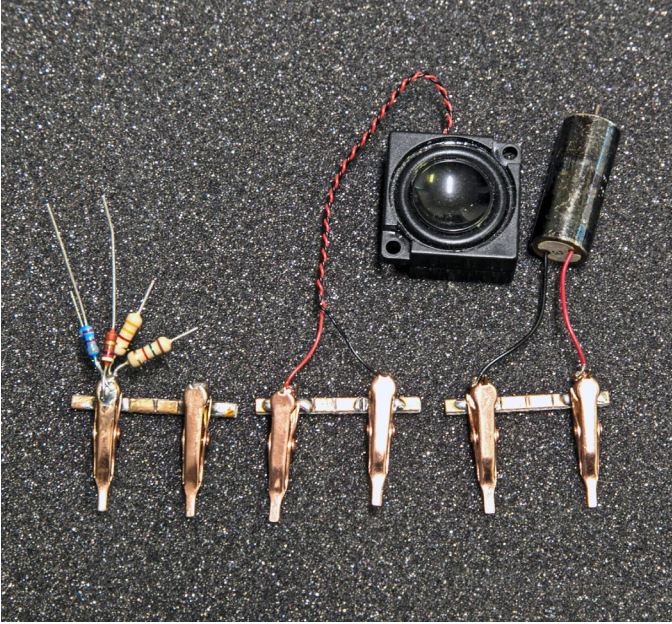

4. Left is a picture of my spider; it's kind of crude but it works. Center is a RailMaster speaker with clips, and on the right is an old motor I removed from an HO<sub>N</sub>3 engine when I upgraded it.

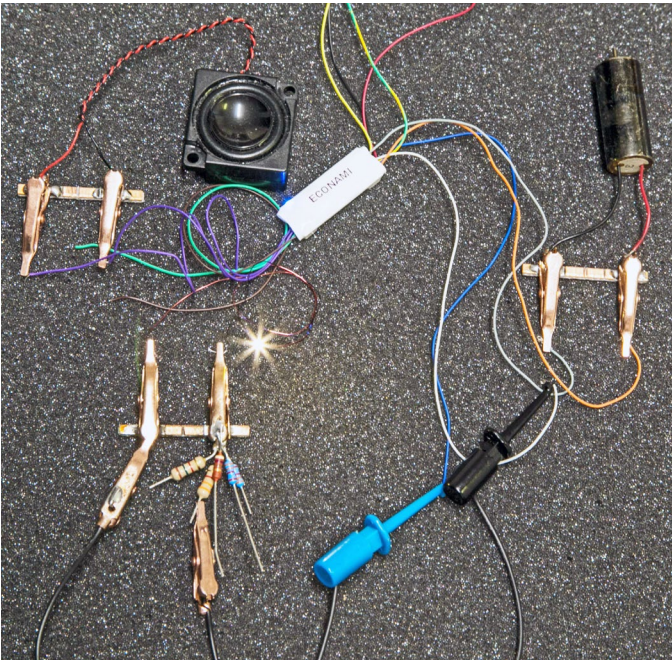

5. Gadgets used to program a decoder and test an LED.

## SMD LEDs | 7

I like. As you can see in the center of the picture, the tiny 0402 LED puts out a good deal of light.

About five years ago I put together a portable NCE DCC system. On the left in [6] is a NCE base unit, on the far right is a power supply, and in the center is a circuit breaker and a Soundtraxx PTB programming track booster. I use this to power my home modular layout, program decoders, and test LEDs.

The NCE base unit has a 9-pin connector that allows me to connect to my Macintosh MacBook Pro. I have the latest version of JMRI on my Mac that lets me program decoders and test LEDs. On the portable NCE system, the left pair of red and white

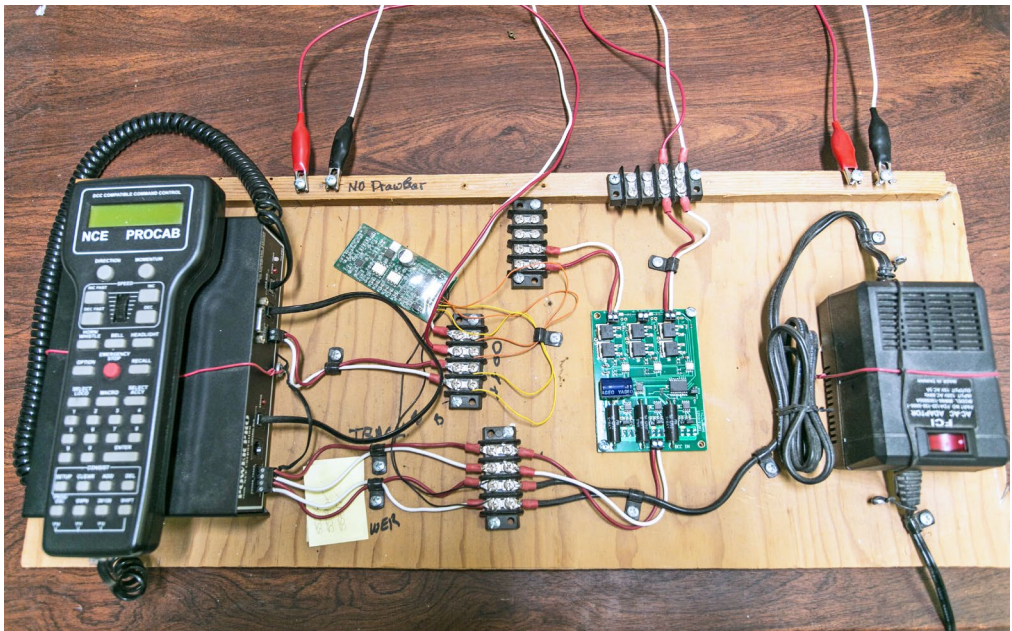

6. My NCE DCC 5-amp portable system. The white and red wires on the left go to a programming track, and the white and red wires on the right go to power my layout.

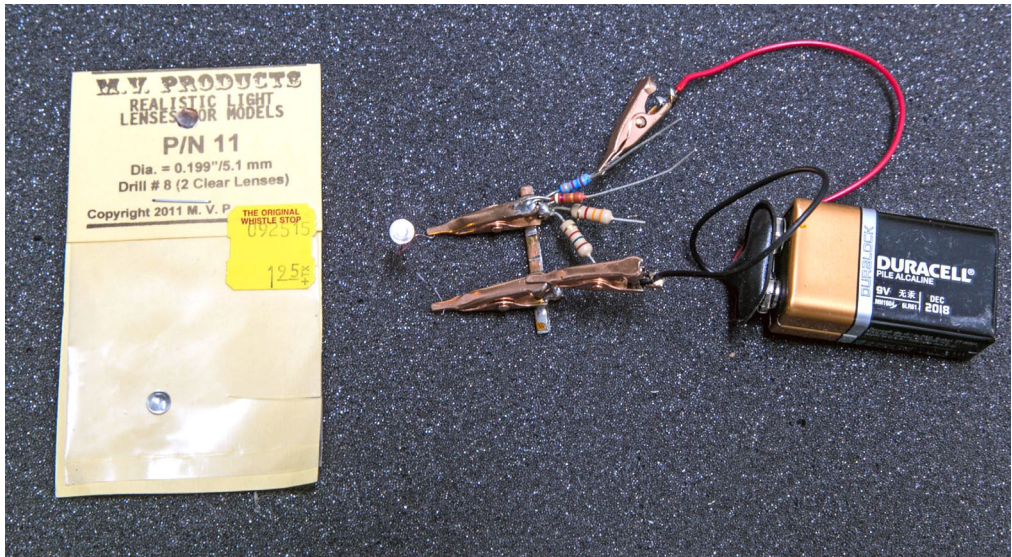

7. The MV Products Realistic Light Lenses come in various sizes. In the center is an example of a 0603 LED glued to the back of an MV Lens. Here I use a 9V battery connected to a resistor to test the headlight, but the brightness may change when powered by a decoder.

wires can be attached directly to the red and black wires on the Econami decoder for programming.

Now let's look at installing some SMD LEDs in a brass engine. I model the Denver & Rio Grande narrow gauge railroad in the 1930s to 1940s, with lots of 2-6-0 and 2-8-2 steam engines. Traditionally, decoders and speakers are installed in the tender, but this makes it tricky to power LEDs in the engine.

The first LED I install is the headlight. I use MV Products Realistic Light lenses for the headlight. This is a clear lens with an aluminum foil backing. To prepare the lens, I turn it over with the aluminum foil facing up. I use the tip of an X-Acto

## SMD LEDs | 9

blade to gently scrape the center to remove the foil about the size of the 0603 LED. After the LED has been tinted to the color that I like, I use ACC to glue it to the back of the lens so it shines through the hole scraped in the foil. This gives the headlight a nice antique glow.

The next task is what I call basket weaving [8]. Care must be taken to protect the LED wires from scraping against anything sharp that might remove the lacquer coating and cause a short circuit. I add some liquid plastic to the tip of my tweezers to help guard against scraping the wires. Using a small hand drill and a #70 bit, I gently enlarge the wire paths. Sometimes I roll the drill bit in LaBelle 106 lubricating grease with Teflon to reduce friction.

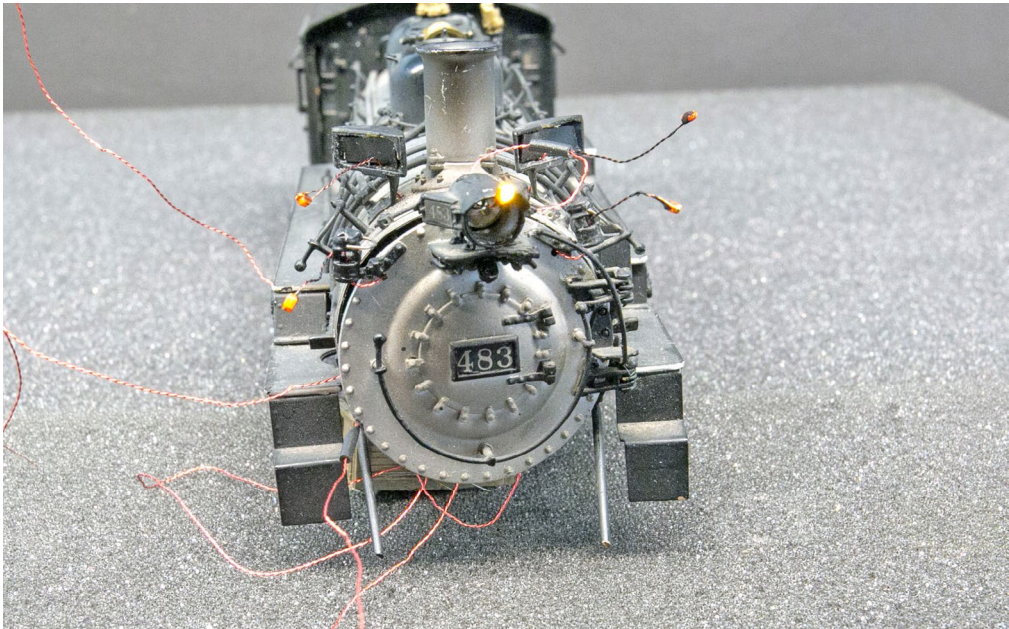

8. I threaded the LED wires through the channels. I test them before I move them to their final position, and before gluing the LED to the MV headlight lens.



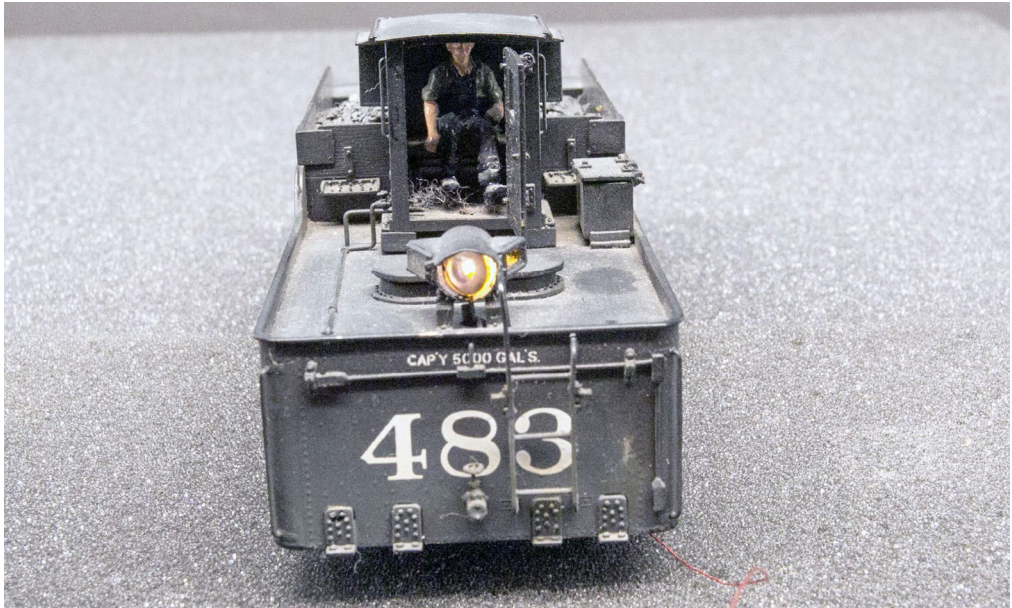

9. The backup light receives the same treatment as the headlight. Please excuse the dust bunny in the doghouse.

The K36 class 2-8-2 also has a backup light [9] that is treated just like the headlight with an MV lens.

The next task is building the wiring harness to bring power to the LEDs in the engine. I use the correct color DCC decoder wires that you can buy in 10<sup>1</sup> lengths from TCS. I use white to power the headlight and number board lights, brown to power the classification lights and the cab light, green to power the firebox light, and yellow to power the backup light. These colored wires go to the negative side of the LED, the shorter wire, and the blue wire goes to the positive side, the longer wire, of each LED.

I like to solder the LED current-limiting resistors in-line with the wires. Each LED gets its own resistor. Then I install the wire harness into the engine and attach the LEDs.

## SMD LEDs | 11

The LEDs come with 6" magnet wires. This can get a little sloppy in the engine with that wire all over the place. I normally cut the wires so they are about 1½ inches long. To tin the ends of the magnet wires, I heat a soldering iron and form a ball of solder on the tip, then pass the end of the wire through the solder a few times until the lacquer is burned off and the wire is tinned.

When soldering the wiring harness, I use my clip jig to hold resistor and the decoder wire. I tin each end. Next I slip on a short length of heat-shrink tubing and shrink it in place.

I continue to build a harness until it looks like a fork, with the white wire forking out with three wires, each with its own resistor (one headlight and two number board lights.) The brown

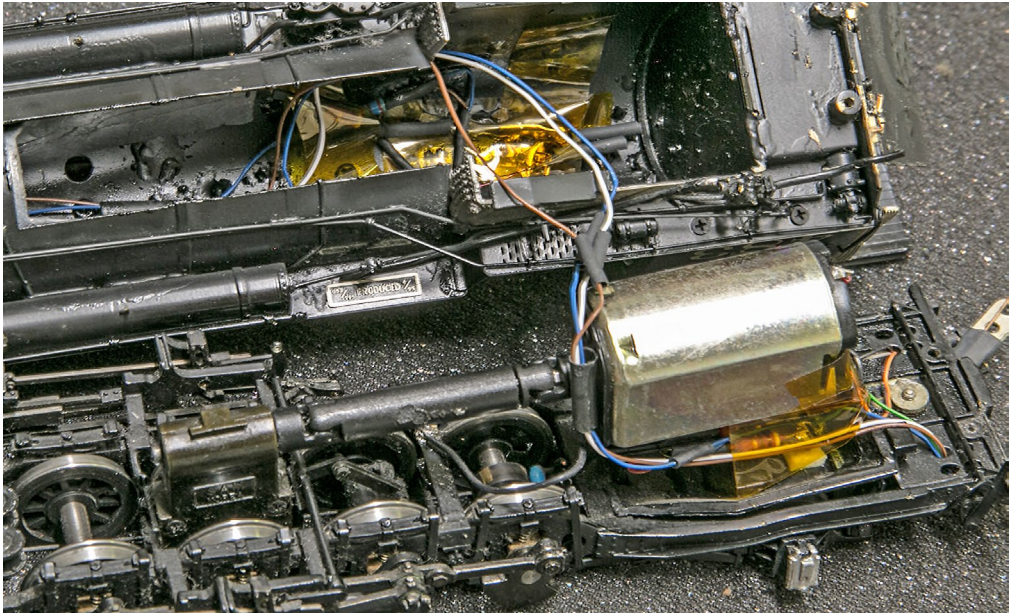

10. The wire harness is threaded through the engine. Heat-shrink tubing serves as a conduit to keep the wires in place.

## SMD LEDs | 12

wire goes to the front with two forks (two classification lights) and then splits and goes to the cab to light the cab light. The green wire goes to two LEDs for the firebox. I tint the one firebox LED with Tamiya yellow and one with red.

Now I put everything together [10]. I glue a few short sections of heat-shrink tubing to the inside of the engine to act as a conduit. I thread my harness through the tubing, up and around the motor, and into the boiler. I use a little Kapton tape to keep the wires from dropping down.

With the harness in place, I solder the LED wires to their appropriate colored wire, and put heat-shrink tubing on all solder joints. I then re-attach the boiler, checking that no wires are pinched, and test the whole thing.

To connect the engine to the tender, I use the TCS mini-pin connectors. I need three wires on the engineer's side (one right-side power pickup and two to the motor) and four wires (white, green, brown, and blue) on the fireman's side.

I hope you have found these little tips and tricks helpful and the next time you need to light a headlight or fixture, you will try using a SMD LED.



[Click here for  
reader comments](#)

## TOOLS USED IN THIS PROJECT

- Tweezers with a protective coating to avoid scratching the magnet wires.
- A small hand drill with a #70 bit.
- LaBelle 106 lubricating grease with Teflon.
- Soldering iron, and small-diameter rosin-core solder.
- Hobby knife.

## MATERIALS USED

- 0603 and 0402 SMD LEDs.
  - 1.5K – 3.3K resistors.
  - Colored decoder wire.
  - Heat-shrink tubing, 3/64”.
  - Aleene’s Clear Gel Tacky Glue.
  - ACC glue.
  - Tamiya Clear Acrylic Paints.
    - Clear Yellow X-24 Item 81024
    - Clear Green X-25 Item 81025
    - Clear Orange X-26 Item 81026
    - Clear Red X-27 Item 81027
  - Copper-clad PC board ties.
  - Radio Shack Micro Smooth Clips #270-0373
-

- MV Products Realistic Light Lenses
- TCS mini pin connectors.
- Kapton tape.

## DCC EQUIPMENT USED

- NCE DCC 5-amp system with power supply.
- NCE circuit breaker.
- Soundtraxx PTB programming track booster.
- Soundtraxx Econami ECO-100 decoder.
- RailMaster speaker.
- Old motor

### ADVERTISEMENT

# YD



Yankee Dabblor – Track 33

**FREE SHIPPING  
ON ORDERS OVER  
\$100.00**

## YD Specializes in DCC Sales-Service-Installation

### YD provides the BEST for LESS



**CLICK AND SAVE TODAY!**



Visit YD at Trainfest  
Booth 2220  
Milwaukee 11/12 & 11/13

YD installs DCC or RailPro in your engines

Technical Coordination (727) 457-9227 9AM to 9PM EST

Locations in NJ and FL / Visit our Web Site for Train Show Schedules

## BILL BEVERLY

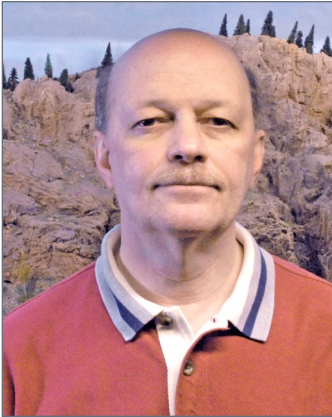

Bill's interest in trains started when he was 8 years old. His father and his uncle built a layout, but naturally he could only look but not touch. When he joined the Boy Scouts, he worked on his Model Railroading Merit Badge and built his first layout.

In his spare bedroom, is currently building a modular shadowbox layout based on the West Side Lumber Co. He models

in Sn3 1/64, S scale 3-foot narrow gauge. The engines are brass imports by PBL, [p-b-1.com](http://p-b-1.com).

He is a member of the Slim Gauge Guild Model Railroad Club in Pasadena CA.

For the past 30 years he has been working as a software developer for Northrop Grumman in Southern California. He hopes to someday retire and move to a large basement to build his dream layout, and have some type of house above it.

.....



**Click here for  
reader comments**

# WEATHER

*like a pro.*

(No airbrush required!)

Go from this ...



To this ...



Volume 1:  
Freight cars

Volume 2:  
Diesel locomotives

Click me to  
**LEARN MORE ...**

“Simple, effective, and a lot quicker than an airbrush ...” - *Koos F.*

DVD or Digital download - From the MRH Store: [store.mrhmag.com](http://store.mrhmag.com)

Brought to  
you by  
**MRH**  
MODEL RAILROAD HOBBYIST

# TRAINMASTERS.TV

## WHAT'S NEW!



**click for more**

### THE BACKSHOP CLINIC



**DCC DECODED**

Expanding an NCE PowerCab



**NOTCH 8**

Airbrushing 104: Weathering



**VENDOR PROFILE**

Rapido Trains



**Applying static grass**

Non-members: Watch an episode for \$1.49; become a member for unlimited access

*Our videos are in-depth like MRH articles, except without ads*

• INDEX

• TABLE OF CONTENTS



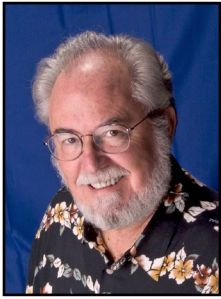

# OCTOBER NEWS

column

RICHARD BALE *and* JEFF SHULTZ

 [Click here for reader comments](#)

## Future iHobby Expos in Doubt

The Hobby Manufacturers Association has dropped plans to produce an iHobby Expo in 2017. A statement released by HMA president Bob Wilke said the future for a combined consumer and dealer trade show in the hobby industry is very uncertain. While some options or alternatives may be considered, at the present time there are no plans for a show in 2017. iHobby has been promoted as the nation's largest trade and consumer show for the model hobby industry. Nearly 19,000 people attended this year's show which was held in New Jersey in March.

## NEW CLUB MODELS

The Chicago & North Western Historical Society is selling an HO scale model of CNW's Bicentennial coal hopper no. 135799.

▶ THE LATEST MODEL RAILROAD PRODUCTS, NEWS & EVENTS

## OCTOBER NEWS | 2



Bethlehem Steel delivered the red, white and blue 3737 cu. ft. car on August 6, 1976. After taking over CNW, Union Pacific re-stenciled

the reporting marks and added top extensions to the sides and ends of the car. No. 135799 is still in service hauling Wyoming coal. The HO scale ready-to-run model was produced for CNWHS by ExactRail. For additional information go to [cnwhs.org/shopping/product\\_info.php?cPath=27&products\\_id=619](http://cnwhs.org/shopping/product_info.php?cPath=27&products_id=619).



The **Baltimore & Ohio Historical Society** is offering a resin kit for a B&O class 0-48 composite gondola. The HO

scale kit was designed and produced for the society by master modeler Chad Boas. In addition to custom resin and laser-cut wood components, the craftsman-style kit includes numerous Tichy detail parts. Trucks and couplers are not included. The model represents one of 300 cars B&O inherited from the Buffalo, Rochester & Pittsburgh Railroad. Decals for B&O and BR&P are sold separately. For additional information go to [borhs.org](http://borhs.org).

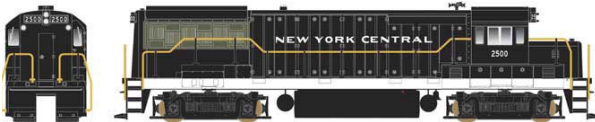

The **Lake Shore Railway Historical Society** is accepting reservations for their

New York Central GE U25b diesel electric locomotive No. 2500. The as-delivered Phase II locomotive with deck mounted handrails and a single pane windshield is being constructed for LSRHS by Bowser. The HO

scale model will be available with and without sound. For additional information contact Lake Shore Railway Historical Society, 31 Wall Street, PO Box 571, North East, PA 16428, or [email\\_lsrhs31@gmail.com](mailto:email_lsrhs31@gmail.com).

## NEW PRODUCTS FOR ALL SCALES



**Dead Rail Installs** is selling a kit that includes all of the components needed to install a Soundtraxx Tsunami2 or Econami Decoder in a dead rail model. In addition to optional decoders, the kit includes

a choice of either a CVP or Tam Valley receiver, a Soundtraxx speaker, a protected lithium polymer battery, connectors, Kapton tape, shrink tubing, and all of the hook-up wire needed to complete the installation. Pricing depends on the options selected, however, the final price is said to be significantly less than buying all of the components separately. The availability of this kit means that hobbyists no longer need to find multiple sources and pay multiple shipping charges. The photo illustrates the CVP option. During the introductory period of the kit shipping will be free. For additional information visit [deadrailinstalls.com](http://deadrailinstalls.com) or contact Pete Steinmetz at [pete@deadrailinstall.com](mailto:pete@deadrailinstall.com).

**Deepwoods Software** has announced the release of version 2.1.39 of their Model Railroad System software. A collection of programs, libraries, and utilities, the Model Railroad System contains communication software for Chubb and Lenz XPressNet networks, a driver for the Rail Driver console, a library

for parsing XTrkCAD files and several utilities for electronics, cameras, and creation operations paperwork. More information and download links can be found at [deepsoft.com/ModelRailroadSystem](http://deepsoft.com/ModelRailroadSystem).

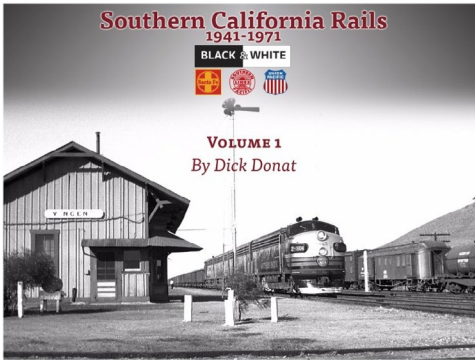

## Morning Sun

**Publications** has released Dick Donat's *Southern California Rails 1941-1971* as an e-book. The Southern Pacific, Santa Fe, and Union Pacific are the main focus, along with plenty of coverage of the Pacific Electric. In the 1940s, '50s, and '60s,

Dick Donat and his father spent Sundays traveling to Cajon Pass and other prime train watching locations in Southern California. Alongside well-known rail photographers like Chard Walker and Bob Hale, they photographed the last of steam and early diesels moving tonnage and passengers throughout the region.

Also new from Morning Sun is *Toronto, Hamilton & Buffalo In Color*, a hardback book with some 250 color photos of equipment operating on the international line; and a digital reprint of *Western Maryland Color Guide to Freight and Passenger Equipment* with more than 275 color photographs. For ordering information visit [morningsunbooks.com](http://morningsunbooks.com).

**The Pennsylvania Railroad Technical & Historical Society** is selling a new book titled *Pennsylvania Railroad - Lines West - Erie & Pittsburgh Branch*. Author Alan B. Buchan documents the history of the E&P branch from its 1835

# OCTOBER NEWS | 5

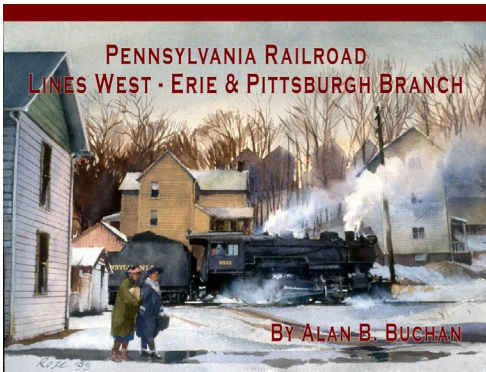

beginning to the present. Included are the various factors that influenced both the success and the eventual demise of the line. The city and port of Erie, freight and passenger operations, and equipment owned are all covered. The 247-page hardcover book contains

over 400 photographs, numerous track diagrams and two large insert pages of maps. This is a limited edition with only 500 copies printed. For more information visit [prrths.com](http://prrths.com).

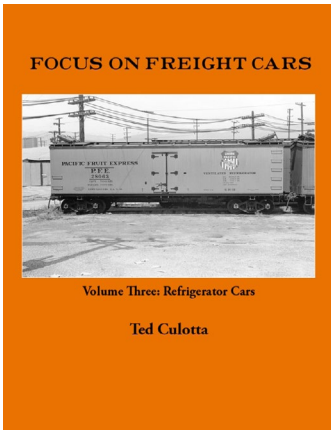

*Focus on Freight Cars* is the title of a series of books from **Speedwitch Media** that are essential for serious modelers of prototype freight cars of the late steam era. Currently available are Volume 1, *Single Sheathed Box & Automobile Cars*; Volume 2, *Double Sheathed Box & Automobile Cars*; and Volume 3, *Refrigerator Cars*. The books are based on Michael Uric's extensive collection of wonderfully detailed photographs of freight cars of the 1930s

and '40s. Most of the photos were taken in Southern California and have never been published. Writing the extensive text that defines the photos was started by acclaimed freight car authority Richard Hendrickson. Since the passing of both Uric and Hendrickson, Ted Culotta has undertaken the task of completing the project. For more information, including purchasing details visit [speedwitchmedia.com](http://speedwitchmedia.com).

.....

## O SCALE PRODUCT NEWS



**3rd Rail division of Sunset Models** has imported an O scale model of a Southern Pacific class S-12 0-6-0 switch engine. The

handcrafted all-brass model features a fully detailed backhead. Both 2-rail (48-inch minimum radius) and 3-rail (O54 track) models are available with appropriate wheel flanges, couplers, and operating systems. For additional information contact a dealer or visit [3rdrail.com](http://3rdrail.com).

.....



**Atlas O** plans to release two versions of a steel caboose during the first quarter of 2017. Features include full interior with crew figures, flashing warning light on the

rear, and Barber-Bettendorf style caboose trucks with rotating bearing caps. In addition to the Wheeling & Lake Erie scheme shown here, cabooses with a standard vision cupola will be available for Norfolk Southern (N&W Heritage), Norfolk Southern (Southern Heritage), Norfolk Southern (Horsehead scheme), and Northern Pacific.

Road names for cabooses with extended vision cupolas will be

# OCTOBER NEWS | 7

.....



cupolas will be included in the release.

MKT Bicentennial, Burlington Northern, and BNSF, shown here as a shoving platform with windows blocked. Undecorated models with both types of



Murphy 5/5/5 or 7/8 corrugated steel ends. Road names will be Duluth, Missabe & Iron Range; Quanah, Acme & Pacific; Chicago, Burlington & Quincy; Burlington Northern, Great Northern, and Northern Pacific. All Atlas O rolling stock is available for 2-rail or 3-rail operation.

Also coming from Atlas O during the first quarter of next year is a group of 40-foot USRA double sheathed boxcars with steel underframes. Variations on the classic wood car include



display case. For additional information on all Atlas O products contact a dealer or visit [atlaso.com](http://atlaso.com).

.....

Atlas O plans to release a 1967 VW Bug and tear drop trailer late this year. The 1/43 scale vehicles come mounted on a stand with a

**BTS** has released a group of O scale kits that assemble into Hyde Pulp Mill, a massive complex with a footprint of about 3 x 5 feet. Originally released in HO\*, BTS owner Billy Wade has spent more than two years preparing the O scale version. The Hyde Pulp Mill consists of eight buildings, a storage tank, and a riverside dock. It is being released in seven kits that can be used individually



or tied together to form the complete complex. The kits are composed of laser-cut basswood, plywood, and cardstock, plus numerous brass, plastic, and white metal detail castings. Most of the kits

are available now, with all scheduled to be completed by the first of next month. Additional information, including a history of the mill and the pulping process, is available at [btsrr.com](http://btsrr.com).

\* MRH's **Ken Patterson** has a two-hour video on the construction of the HO scale version of Hyde Pulp Mill. Although the video features 1:87 kits, they are very similar in construction to the O scale kits and the tips and techniques Ken offers are applicable to any scale. For more information visit [kenpatterson.com](http://kenpatterson.com).

.....



**Glacier Park Models** is selling an O scale kit for an AC&F general service gondola. Glacier Park says,

“These fine scale models are molded entirely in tough ABS plastic... We consider them to be craftsman type kits because assembly is required and to differentiate them from the RTR and shake the box stuff available elsewhere.” Trucks, decals or couplers are not included. The assembly instructions suggest various sources for these items. For more information visit [glacierparkmodels.com](http://glacierparkmodels.com).

.....

## S SCALE PRODUCT NEWS

**PBL** continues to offer Sn3 scale models with outstanding details. Currently, the company is accepting reservations for a group of





two-truck Shay geared locomotives. The Sn3 scale models are being hand-crafted in Korea. The run includes Dixiana, a still-active

locomotive on the Roaring Camp & Big Trees Railroad in the coastal redwoods at Felton CA. Other variations include Cherry Valley No.7, Greagle Aggregates No. 5, coal burning R. D. Ranger & Sons Timber No. 1, Buchanan & Sons Timber No. 3 with a diamond spark arrester stack, High Point Lumber Co. No. 4, and the coal burning Robert Dollar Co. No 2. For additional information visit [p-b-l.com](http://p-b-l.com).

**Rusty Stumps Scale Models** has introduced an S scale craftsman passenger station kit. Based on a late 1800s C&O standard station design, the footprint of the station is 7.375 x 4.875 inches, and the platform is 9 x 7.5 inches. For more information and a photo of the complete station and platform see the entry for the HO scale version of the kit or visit [rustystumps.com](http://rustystumps.com).

## HO SCALE PRODUCT NEWS

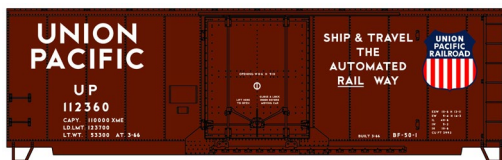

**Accurail** is selling a kit for an HO scale Union Pacific 40-foot insulated plug-door steel boxcar. As shown here the model is decorated with

a three-color UP herald and a mid-1960s Ship & Travel slogan.

# OCTOBER NEWS | 10

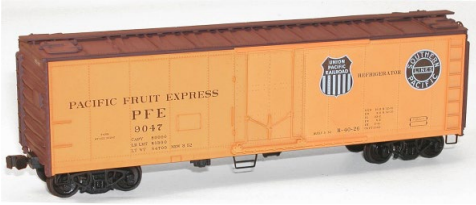

Additional new kits from Accurail include a 3-car set of 40-foot PFE steel reefers. The trio of cars are similar except for the positioning of the SP and UP heralds.



Also new from Accurail, and just in time for Wisconsin-based Trainfest, are three Milwaukee Road Pullman Standard 4750 cu. ft. class S-2 triple-bay covered hoppers. The body colors are gray, yellow, and aluminum.

A special 3-car set of ATSF freight cars will be available later this month. The mix will be one single-door AAR boxcar, one double-door AAR boxcar, and one steel refrigerator car. All will feature Santa Fe's system map scheme. New releases next month will include a 3-car set of 40-foot steel boxcars decorated for Pennsylvania Railroad with a shaded keystone herald. For more information about all Accurail products contact a dealer or visit [accurail.com](http://accurail.com).



**Athearn** has released a long list of new products it plans to deliver to dealers next July. Leading the list are EMD GP15 series locomotives decorated for CSX (with RV air conditioners),

# OCTOBER NEWS | 11

Chicago & North Western, Chessie System, Conrail, and MP (with four stack exhaust and spark arrestors). The Genesis series model will be available with DCC decoder and Soundtraxx Tsunami2 sound. Standard DC models without sound will be DCC-ready with 8-pin NMRA and 9-pin Quick Plug connector to simplify conversion to DCC.

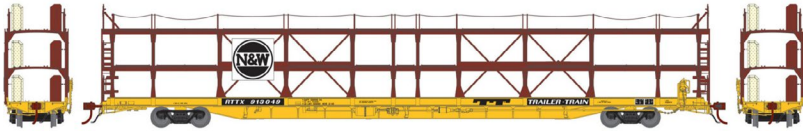

New F89 Tri-Level Autoracks are scheduled for release next July. Introduced in the early 1960s, the Trailer Train Company (now TTX) F89 flat car has been a mainstay of contemporary railroading. Bethlehem built more than 9,000 cars of this design. In addition to the Norfolk & Western/TTX combination above, decorating schemes will be Missouri Pacific, Northern Pacific, Seaboard Coast Line, Frisco (St. Louis-San Francisco), and Southern Pacific. Athearn's Genesis series model features Whitehead and Kales tri-level auto racks, a weighted diecast underframe, wire-formed brake rigging, separately applied wire grab irons, and 70-ton trucks with rotating bearing caps. The 89-foot cars will negotiate a 22-inch radius but 24-inch curves are recommended.

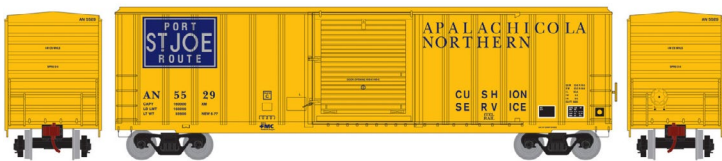

Athearn's list of Ready-to-Roll models due next July includes a group of ten 50-foot FMC 5347 cu. ft. boxcars. The HO scale versions of the 1970s era cars feature a sliding Youngstown door and non-terminating ends. Road names will be Apalachicola

# OCTOBER NEWS | 12

Northern (Fort St. Joe Route herald), Bath & Hammondsport Railroad, Helena Southwestern, Meridian & Bigbee Railroad, Port Huron & Detroit, Railbox, Rahway Valley, Saratoga & North Creek, Sabine River & Northern, and Vermont Railway.



Twenty-foot corrugated containers coming next July will be available for K-Line, Linea Mexicana, Mitsui OSK Lines, SSI

Container Corp, American President Lines, Waters AG, and Australia New Zealand. The shorty container will be available in 3-packs with each container having a different number.



A short rubber-tired trailer chassis designed to handle 20-foot containers will be available in 2-packs decorated for American President Lines, Evergreen, Matson, COSCO, Hyundai, NOL, NYK, TAL, and P&O Nedlloyd.



Athearn's July 2017 schedule includes two ver-

sions of a nicely detailed Ford Model A Tudor sedan. Features include rubber tires and clear window glazing. Cars with a spare tire mounted on the left front fender will be available in black, dark green, and tan.

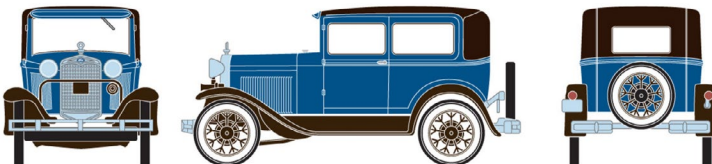

Cars with a spare tire mounted above the

# OCTOBER NEWS | 13

rear bumper will be blue, burgundy, and cream. Although the body colors vary, the top and fenders on all versions will be black.



## Athearn Roundhouse

models due next July include a 40-foot steel ice reefer with trucks

featuring machined metal wheels. Decorating schemes will be Chicago, Burlington & Quincy; Burlington Refrigerator Express, Fruit Growers Express, Great Northern, Pacific Fruit Express (Overland scheme with 3-color UP shield), Pacific Fruit Express (Express service with green body), Rock Island, Soo Line (white body, blue door panel), and Merchants Despatch.



Completing the July 2017 release will be an Athearn-Roundhouse 40-foot quad-bay

hopper with offset sides. Road names in this run will be CP Rail, Santa Fe, Burlington Northern, Canadian National, Chesapeake & Ohio, Peabody Short Line, Southern Pacific, and Union Pacific. For information on all Athearn and Athearn-Roundhouse products contact a dealer or visit [athearn.com](http://athearn.com).

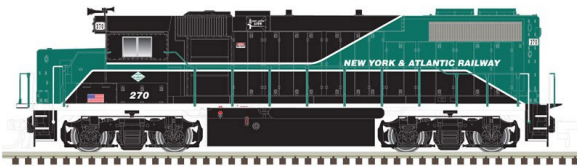

**Atlas Model Railroad Company** plans to release a Trainman series GP38-2 during the

second quarter of 2017. EMD unveiled the prototype Dash 2 locomotive in 1972. It featured a solid-state modular electrical control system that, among other things, improved traction and reduced exhaust emissions. Atlas' HO scale version will be

# OCTOBER NEWS | 14

available for standard DC operation with an NMRA compliant 8-pin plug to ease installation of an aftermarket DCC decoder. A Gold series DCC version of the GP38-2 will have a LokSound Select Dual-Mode decoder which allows the model to be used on DC as well as DCC layouts. Road names will be Burlington Northern, Buffalo & Pittsburgh, South Carolina Central, Canadian Pacific, Florida East Coast, Norfolk & Western, and New York & Atlantic (above). An undecorated GP38-2 will also be offered.



Atlas has scheduled the next release of its Master Line 50-foot 6-inch NSC plug door boxcar for the first quarter of 2017. The HO scale model is based

on a prototype National Steel Car built during the late 1970s primarily for handling paper. Road names will be British Columbia Railway, Canadian National, Canadian Pacific, Grand Trunk Western, Ontario Northland, Quebec Central, and YARR (Youngstown & Austintown Railroad). Depending on the practice of the prototype road being modeled, variations in the trucks (70 or 100 ton), plug doors (9 or ten feet wide), and ends (9 or ten corrugations) will apply. Undecorated models with each of the variations mentioned will be included in this release.



Also due from Atlas early next year are two versions of a steel caboose. Road names for cabooses with extended vision cupolas will be Alaska (left), Milwaukee, Racine & Troy; Belt Railway

of Chicago, Burlington Northern, Delaware & Hudson, MKT (Bicentennial flag scheme), and BNSF.

# OCTOBER NEWS | 15



In addition to the Northern Pacific scheme shown here, cabooses with a standard vision cupola will be available for Norfolk Southern (N&W Heritage scheme), Norfolk

Southern (Southern Heritage scheme), and Norfolk Southern (Horsehead logo). Undecorated cabooses with both types of cupolas will also be available.

Atlas has scheduled another release of its HO scale Cararama Volvo construction vehicles for the fourth quarter of his year. The run will include a timber carrier, bulldozer, excavator and backhoe. Also due late this year is a red and white Coca Cola delivery truck. For more information on all Atlas products contact a dealer or go to [atlasrr.com](http://atlasrr.com).

.....



**Bachmann** has announced the final road names for its HO scale Norfolk Southern 30th anniversary GE

ES44AC commemorative diesels. NS heritage paint schemes will be available for Interstate, Monongahela, Conrail, Norfolk & Western, and Norfolk Southern Railway.



EMD SD70ACe locomotives will get the heritage treatment for Delaware, Lackawanna & Western; Illinois

Terminal, Penn Central, Savannah & Atlanta, and Reading Company. Both ES44AC and SD70ACe locomotives will have

# OCTOBER NEWS | 16

Bachmann's Sound Value SoundTraxx diesel sound package with prime mover, three air horns, and bell. Additional features include operating ditch lights, and dual-mode NMRA-compliant decoder. For information on all Bachmann products contact a dealer or visit [bachmanntrains.com](http://bachmanntrains.com).



**Bowser** has announced plans to release a new run of its GE U25b diesel locomotive next March. Upgrades since the last release of the HO scale model more than three years ago include new handrails that are said to be correct for all phases, and 9-foot 4-inch wheelbase AAR B trucks with a new gearbox. Other features include metal MU hoses, air hoses, windshield wipers, individual grab irons, coupler lift bars, and operating headlight. Bowser's U25b will be available with sound and DCC as well as just DC with an NMRA 21-pin plug for an aftermarket DCC decoder. DCC/Sound versions will have a LokSound Select decoder.

Road names will be Erie Lackawanna (gray roof), Erie Lackawanna (black roof), Great Northern (shrouded horn, operating beacon, and snow plow), Milwaukee Road, Pittsburgh & Lake Erie, Pennsylvania Railroad, Pennsylvania (with train phone antenna), Southern Pacific, Union Pacific, New York Central, and New York Central (updated car body). For more information contact a dealer or visit [bowser-trains.com](http://bowser-trains.com). See our Club Models report for availability of a Bowser NYC U25b with a single pane windshield.

Future new models from **InterMountain Railway** include an HO scale 4750 cu.ft. triple-bay covered hopper car. The ready-to-run model will have etched metal roof walks, metal wheelsets and



# OCTOBER NEWS | 17

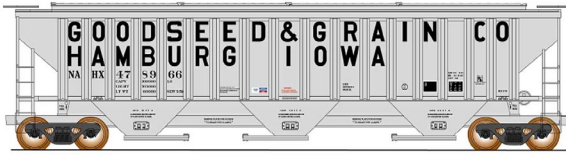

Kadee couplers. In addition to the Goodseed & Grain scheme shown here, six road numbers each

will be available for AM Grain Express (gray), AM (brown), Union Pacific (Bicentennial), State Line Elevator, Farmrail (I Care series), Farmers Elevator, Grain Handling Corp, Pomeroy Co-op Grain, and Evergreen Hatchery. Availability is expected in March or April 2017. An economy undecorated kit with plastic wheels less couplers is available now.



Also due from InterMountain next spring is a group of A-Line 20-foot corrugated containers. Decorating schemes will be CMAU-CMA CGM, TEMU-Textainer Equipment

Management, CXDU-Cronos Group, TKCU-Triton, PCIU-Pacific International Lines, MRKU-Maersk, APLU-American Presidents Line, MOAU-Mitsui OSK Lines, TRLU-Transamerica Leasing, and MSKU-Safmarine. Three sets of 3-packs will be available for a total of nine different container numbers. For additional information on all InterMountain products contact a dealer or visit [intermountain-railway.com](http://intermountain-railway.com).



**Kadee** has recently expanded its selection of HO scale HGC self-centering freight car trucks. New are (above left to right) Bettendorf T-section, Vulcan double-truss, and Andrews trucks. The trucks all come with 33-inch metal wheels. They are shown

# OCTOBER NEWS | 18

here with .88 semi-scale wheel treads. Standard .110 treads are also available.



New HO scale ready-to-run models coming from Kadee next month include a 50-foot Peoria & Eastern PS-1 boxcar with 10-foot Superior sliding doors. The car is painted in parent NYC jade green. Kadee will offer the model in two road numbers.



Also due in November is an ACF 11,000 gallon insulated tank car decorated for FBCX - Foley Butane Co.



December releases include an Atlanta & West Point 40-foot PS-1 boxcar with an 8-foot Youngstown steel door. For additional information on all Kadee products contact a dealer or visit [kadee.com](http://kadee.com).



**Monroe Models** has introduced a kit for a Diesel Engine House. The design of the HO scale model was influenced by a Chicago North Western structure built in the early 1960s. The office structure is separate and can be placed in a variety

of locations. The kit includes laser-cut board and basswood

## OCTOBER NEWS | 19

components, and laser-cut windows, doors, and trim with peel-and stick backing. Interior floors and bracing are also laser-cut. Lead-free cast metal details include lights, smoke jacks, fuel tank, and two styles of roof vents. Step-by-step assembly instructions, photos, and diagrams complete the kit. The figures, vehicle and locomotive shown here are not included. For additional information visit [monroemodels.us](http://monroemodels.us).

---



The newest HO scale kit from **Monster Modelworks** is for this Brick Yard Tower. The craftsman-style kit is based on the yard tower in East Deerfield, MA, and the prototype has three sister towers located on the east coast. The kit features laser-engraved American Bond brick walls, corner pieces and chimney. The concrete and decorative brick cornice overlays are also laser-cut. Windows and glazing are laser-cut peel & stick. The chimney pipe and stairs are 3D printed. Diamond cut asphalt shingles, assembly instructions, and hints on painting complete the kit. The finished model is 4.5 inches high. It has a footprint of 4.25 x 2.56 inches. For additional information go to [monstermodelworks.com/HO-Scale/HO-Kits/ho-scale-brick-yard-tower.html](http://monstermodelworks.com/HO-Scale/HO-Kits/ho-scale-brick-yard-tower.html).

---

.....

**Rapido** is developing an HO scale model of a Marine Industries 3800 cu. ft. cylindrical covered hopper car. This is in addition to the previously announced version of a National Steel Corporation prototype. Although similar, the two versions have distinctively different end details and brake valve arrangements. The models are expected to be ready during the first half of 2017. The early test

# OCTOBER NEWS | 20



sample of a 3800 shown here was painted and decorated by Dan Darnell. Brake piping on the end has yet to be installed.

In other news, Rapido has announced the cancellation of the Canadian Confederation Train project (see MRH June 2014). In announcing the cancellation, Rapido said the limited number of advance reservations would not support the amount of new tooling required to justify the historic train. For additional information on all Rapido products visit [rapidotrains.com](http://rapidotrains.com).



**Rusty Rail** has released an upgraded version of its popular HO scale workbench. The unpainted resin castings include the small storage cabinet. Some minor assembly is required. The bench

measures 2.125 x .5 x 1.25 inches tall. For additional information visit [rustyrail.com](http://rustyrail.com).



**Rusty Stumps Scale Models** has announced an HO scale craftsman passenger station kit. The kit is based on a late 1800s C&O standard station design and contains plywood sub-walls with RC-Board with details engraved in it. Trim and gingerbread consists of stripwood and plywood

# OCTOBER NEWS | 21

with laser cut 3-tab shingles for the roof. Windows and doors are laser cut and the chimney is cast resin. The platform is a framework of laser cut plywood topped by an engraved plywood sheet. The station has a footprint of 4.375 x 2.25 inches and the platform is 6.625 x 5.5 inches. For more information go to [rustystumps.com](http://rustystumps.com).

.....



**ScaleTrains.com** is selling HO scale ready-to-run models of Trinity Rail 31,000 gallon crude oil tank cars. Both the models and the prototype are readily identified by the unique trapezoid-shaped end shields.

Road names include DPRX, GATX (with a half ladder), TILX, and VMSX (Valero Marketing & Supply Co.) The model is available in the Operator series as well as in the more detailed Rivet Counter series.

Features of the HO scale model include photo-etched top and end platforms, detailed manway cover and tank saddles with defect card holders, metal anti-personnel rods, individually applied metal grab irons on the end sills and corners, and body-mounted metal semi-scale SE Type double-shelf knuckle couplers. The trucks are 110-ton Barber S-2-HD-9C with 36-inch machined metal wheels and blue rotating bearing caps.

Additional features on Rivet Counter models include uncoupling levers, train line hoses, brake plumbing, extra fine lettering on the car body, and reporting marks and road numbers printed on the trucks. Factory stock is sold out on some road names, however dealers may still have some on hand. For more information on all ScaleTrains.Com models and a list of dealers go to [scaletrains.com](http://scaletrains.com).

.....



**Walthers** is scheduled to release an EMD GP7 diesel late this year. In addition to the Santa Fe zebra stripe scheme shown here, the Proto

series ready-to-run locomotive will be available decorated for Baltimore & Ohio, Chicago North Western, Pennsylvania Railroad, and New York Central.



Walthers has set an April release date for its GE ES44AC GEVO locomotive. Road names for the ready-to-run Mainline series model will be Canadian Pacific, Canadian National,

CSX, Southern Railway, Norfolk Southern, and Union Pacific. Both the GP7 and ES44AC will be available for standard analog DC operation or with a SoundTraxx Sound and DCC decoder. For information on all Walthers products contact a dealer or visit [walthers.com](http://walthers.com).

## N SCALE PRODUCT NEWS



**Athearn** has scheduled the release of a 50-foot FMC 5347 cu. ft. boxcar for July 2017. Road names on the N scale Ready-to-Roll model will be Bath & Hammondsport, Apalachicola Northern (Fort St. Joe Route slogan), Helena Southwestern, Meridian & Bigbee Railroad, Port Huron & Detroit, Railbox, Rahway Valley, Saratoga & North

# OCTOBER NEWS | 23

Creek, Sabine River & Northern, and Vermont Railway. The model will have screw-mounted roller-bearing trucks with machined metal wheels. For additional information on all Athearn products contact a dealer or visit [athearn.com](http://athearn.com).

---



**Atlas Model Railroad Company** is planning a second quarter release for the next production run of its N scale Dash 8-40B (aka

B40-8) Dash 8-40BW (wide cab), and 8-32BHW (passenger version) diesel electric locomotives.

Atlas' Master Line Dash 8-40B models will be available decorated for Milwaukee, Racine & Troy; Union Pacific, CSX, Minnesota Commercial Railroad, and Saratoga & North Creek. Dash 8-40BW models will be available for Milwaukee; Racine & Troy, BNSF, Arkansas-Oklahoma Railroad, and Providence & Worcester. The run includes DCC decoder equipped (Lenz) models. Non-decoder models will be available for standard DC operation.



An N scale model of a 40-foot USRA double sheathed boxcar with a steel underframe is expected from Atlas during the first quarter of 2017.

Variations on the classic wood boxcar include Murphy 5/5/5 or 7/8 corrugated steel ends. New paint schemes include New York Central, Burlington Route, Northern Pacific, and Union Pacific. Previously issued road names with new numbers will be available for Duluth, Missabe & Iron Range; Quanah, Acme & Pacific; and Great Northern.

# OCTOBER NEWS | 24



Atlas has scheduled a production run of its N scale standard and extended vision cabooses for release in the first quarter of 2017. Road

names for extended vision cabooses will be Delaware & Hudson, Milwaukee, Racine & Troy; Belt Railway of Chicago, Burlington Northern, MKT, and Alaska Railroad. A riding platform with the windows blocked out will be available decorated for BNSF.



In addition to the Norfolk Southern (N&W Heritage scheme) shown here, cabooses with a standard vision cupola will be available for Norfolk Southern

(Southern Heritage scheme), Norfolk Southern (Horsehead logo) and Northern Pacific. Undecorated cabooses with both types of cupolas will be included in the early 2017 release. For more information on all Atlas products contact a dealer or go to [atlasrr.com](http://atlasrr.com).



## InterMountain Railway

plans to release an N scale 4750 cu. ft. triple-bay covered hopper car

in March or April. In addition to the Pomeroy Co-op Grain car shown here, six road numbers each will be available for Goodseed & Grain, AM Grain Express (gray), AM (brown), Union Pacific (Bicentennial), State Line Elevator, Farmrail (I Care series),



# OCTOBER NEWS | 25



**Kato USA** will soon release its N scale Union Pacific 4-8-4 steam locomotive in freight livery. Limited quantities of the previously announced Union Pacific Excursion Train No. 844

have already been shipped to dealers. Locomotives for analog DC, DCC, and DCC with sound should all be available by the end of October.



Kato USA is planning a new production run early next year for its N scale ES44AC GEVO diesels. Note the difference in number board placement and other nose details on these sample models. Two new

road numbers each will be available for Canadian National, Union Pacific, and BNSF. For information on all Kato products contact a dealer or visit [katousa.com](http://katousa.com).



New N scale models released by **Micro-Trains Line** include

two heavyweight passenger cars. This Canadian National 10-1-2 sleeper is painted green with a black band and yellow lettering and striping.



This New Haven 70-foot RPO-baggage car is Pullman green

with white lettering. Both cars are equipped with six-wheel trucks.

# OCTOBER NEWS | 26



post-1973 design. Many of the prototype cars are still in service.

Micro-Trains GATX 50-foot 4180 cu. ft. Airslide hopper car with twin discharge bays represents a



non-terminating steel ends.

This Lake Erie, Franklin & Clarion 50-foot rib-side boxcar features a single Youngstown sliding door and



three compartment prototype built in 1928. For information on all Micro-Trains Line models contact a dealer or visit [micro-trains.com](http://micro-trains.com).

Completing our report on new Micro-Trains N scale models is this Pennsylvania 6,000 gallon triple-dome tank car. It follows a



**Showcase Miniatures** is selling kits for three variations of an N scale structure from its Highways of the USA series. Shown here is their Route 66 Desert Café. A similar structure with appropriate signage and

details is available as an Indian Trading Post. Shown below is the third variation; Two Guns Gas Station.



The kits are made up of laser-cut components, cast pewter details, water slide decals, and high resolution graphics. The detailed instructions include painting suggestions. For additional information go to [showcaseminatures.net](http://showcaseminatures.net).

## NEW DECALS, SIGNS AND FINISHING PRODUCTS

**Great Decals** is selling white N scale lettering sets for Norfolk & Western class H-9 and H L twin-bay hopper cars. Decal set #137 is designed for MicroTrains Line car bodies but can be adapted to other manufacturers models as well. The set has material to decorate one car including N&W's 24-inch herald, road name, car classes, repack stencils, dimensional data, alternate LT WT lines, and 12 canned road numbers that can be used to make any road number. For more information go to [greatdecals.com](http://greatdecals.com).

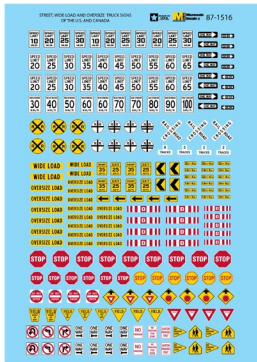

**Microscale Industries** latest release is a decal sheet with a wide range of street signs including stop, yield, one-way, railroad crossing, and speed limit signs. The lettering set also has truck decals for oversize load and wide load. For additional information contact a dealer or visit [microscale.com](http://microscale.com).

**Speedwitch Media** has released three new sets of HO scale decals. They are International-Great Northern 50-ton AAR war emergency flat car, Union Pacific class F-50-11 AAR 50-ton flat car, and Texas & New Orleans class G-50-19, -21, -24 war emergency composite gondolas. For additional information visit [speedwitchmedia.com](http://speedwitchmedia.com).

.....

**Tichy Train Group** has released several dozen new decal sets in HO, N S and O scale. This brings the total to more than 100 new decals introduced in the past few months. The website is being modified to make it easier to locate a particular car type, private owner or railroad name. For more information visit [tichytraingroup.com](http://tichytraingroup.com).

.....

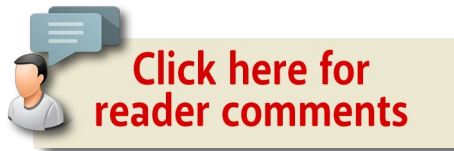

## DISCLAIMER .....

The opinions expressed in this column are those of the writer and do not necessarily reflect the opinion of *Model Railroad Hobbyist* or its sponsors. Every effort is made to provide our readers with accurate and responsible news and information, however, neither *Model Railroad Hobbyist* or the writer of this column can be held responsible for any inaccuracies or typographical errors that may inadvertently appear in this column.



## SEND US YOUR PRODUCT ANNOUNCEMENTS

If you are a hobby manufacturer with a product announcement, just [click here](#) and submit your announcement to us. Our web site and free magazine reach continues to grow, so get on board this new media train! ■



[Click here for  
reader comments](#)

# Please tell your buddies about MRH!

WE RELY ON WORD-OF-MOUTH TO  
GROW AND A BIGGER CIRCULATION  
MEANS MRH IS MORE LIKELY TO STICK  
AROUND FOR A LONG TIME TO COME!



BRIEFLY NOTED AT PRESS TIME ...

**Fine Art Models** (FAM), an importer of high quality transportation models, will no longer develop any new projects. Owner Gary Kohl said the problem is the lack of artisans capable of creating models of the quality and authenticity demanded by museums. One of FAM's finest railroad models is a large scale class H8 2-6-6-6 Allegheny on display adjacent to the prototype locomotive at the Henry Ford Museum in Dearborn, Michigan. For information on previously owned FAM models visit [fineartmodels.com](http://fineartmodels.com).

Volume 33 of the **Railway Prototype Cyclopedia** is scheduled for release late this month. This special 193 page all-color edition features part IV of Pat Wider's extensive study of Pullman heavyweight passenger cars. For additional information visit [rpcycpub.com](http://rpcycpub.com).

**Resin Car Works** plans to introduce a new HO scale resin kit at the Chicagoland (formerly Naperville) prototype modelers meet on October 20. The model will be for a Missouri Pacific 50-foot 6-inch automobile and BX Express boxcar. The resin body components are cast from upgraded masters Charlie Slater created for Martin Lofton of Sunshine Models. Additional parts include a Plano etched metal running board, Precision Scale brass air hoses and Tichy ladders. Decals to letter the white freight version with the Eagle slogan and larger shield are included along with dulux lettering for the passenger version of the express car. For more details visit [resincarworks.com](http://resincarworks.com).



# The Amherst Railway Society Railroad Hobby Show

Our 2017 Show will be

# January 28 & 29, 2017

Save the dates!

**Click  
to learn  
more ...**



## About The Show

Every year late in January or early in February, the Amherst Railway Society holds its Railroad Hobby Show at the Eastern States Exposition Fairgrounds (The home of The Big E) in West Springfield, Massachusetts. More than 25,000 railfans and public attended the Show each of the past three years.

The event features real life railroads and scale model railroads, historical societies, travel agencies, art shows, flea market dealers, importers, manufacturers and photographers. You have to see it to believe it!



# SELECTED EVENTS

## October 2016

*(Please note that many events charge a fee. Check individual info website for details.)*

**AUSTRALIA, QUEENSLAND, BEENLEIGH**, October 15-16, Model Train Show, at Beenleigh Events Centre, Crete and Kent Streets. Event sponsored by Logan District Model Railway Club. Info at [ldmrc.com/show](http://ldmrc.com/show).

**CANADA, ALBERTA, CALGARY**, October 29, Open House at Calgary Model Trainmen's Club, 7-11 street North East. Info at [calgarymodeltrainmen.com](http://calgarymodeltrainmen.com).

**CANADA, ALBERTA, EDMONTON**, October 22, Great Edmonton Model Train Show, sponsored by the Mainline Model Railroaders Fellowship, at Central Lions Seniors Recreation Centre, 11113 113 Street. Info at [mmrf.ab.ca/events.shtml](http://mmrf.ab.ca/events.shtml).

**CANADA, ONTARIO, BRAMPTON**, October 1-2, Model Railway Show, at Brampton Fair Grounds, 12942 Heart Lake Road. Info at [bramptonmodelrailwayshow.com](http://bramptonmodelrailwayshow.com).

**CALIFORNIA, SAN LUIS OBISPO & SANTA BARBARA COUNTIES**, October 6-9, Central Coast Railroad Festival and self-guided tour of 25 layouts. Request info from coordinator Bob Chaparro at [chiefbobbb@verizon.net](mailto:chiefbobbb@verizon.net).

**CALIFORNIA, SAN PEDRO**, October 15-16, Open House & Swap Meet, sponsored by Belmont Shore Railroad Club, at 3601 South Gaffey Street, Building 824. Info at [belmontshorerr.com](http://belmontshorerr.com).



## SELECTED EVENTS | 2

**FLORIDA, PALATKA**, October 8, Palatka Railfest, at Union Station, Reid Street at the Railroad tracks. Info at [railsofpalatka.org/rail-fest-2016.html](http://railsofpalatka.org/rail-fest-2016.html).

**ILLINOIS, CHICAGO**, October 1-2, Brass Expo, a juried show limited to pre-submitted items including brass models and items relevant to brass models. At The Westin Hotel (Chicago North Shore), 601 N. Milwaukee Ave. Wheeling, IL 60090. Info at [brassexpo.com](http://brassexpo.com).

**ILLINOIS, LISLE**, October 20-22, RPM Chicagoland (formerly Naperville RPM), hosted by Mike Skibbe, at Sheraton Hotel. Info at [rpmconference.com](http://rpmconference.com).

**IOWA, HAMPTON**, October 30 5th Annual North Central Iowa Model Railroad Show & Sale, at Franklin County Convention Center, 1008 Central Avenue West. Request info at [eastside-trains@gmail.com](mailto:eastside-trains@gmail.com) .

**LOUISIANA, METAIRIE**, October 22, Lone Star Region Division 2 Clinic & Operation Day at Crescent City Model Railroad Club, 601 North Lester Avenue. info at [ccmrc.com](http://ccmrc.com) .

**MARYLAND, TIMONIUM**, October 29-30, Great Scale Model Train Show, at Maryland State Fair, 2200 York Road. Info at [gsmts.com](http://gsmts.com).

**MASSACHUSETTS, WAKEFIELD**, October 8-9, Model Railroad Show & Open House, sponsored by the North Shore Model Railroad Club. Show October 8 at American Civic Center, 465 Main Street. Club layout open for viewing Oct 8-9 at 404 Main Street (rear). Info from Joe Greene at [info@nsmrc.org](mailto:info@nsmrc.org).

**MICHIGAN, FARMINGTON HILLS (Detroit area)**, October 30. Detroit Area Trainorama 2016, at Costick Activities Center, 28600 Eleven Mile Road.

## SELECTED EVENTS | 3

**MICHIGAN, NORTHVILLE**, October 6-9 North Central Express 2016, NMRA NCR Regional Convention, at Ward Church, 40000 Six Mile Road. Info at [div6-ncr-nmra.com/ncx-2016---overview.html](http://div6-ncr-nmra.com/ncx-2016---overview.html).

**MICHIGAN, WYOMING (Grand Rapids)**, Grand River Valley RRC Fall Train Show at the HSB, 5625 Burlingame Ave SW. Info at [grandrivervalleyrrc.org](http://grandrivervalleyrrc.org).

**MISSOURI, JEFFERSON CITY**, October 6-9, Missouri Pacific Historical Society Annual Meeting, includes modeling clinics and swap meet. Info at [mopac.org/annual-convention/110-2016-jefferson-city-mo](http://mopac.org/annual-convention/110-2016-jefferson-city-mo).

**MISSOURI, KIRKWOOD**, October 8-9, Greater St. Louis Metro Area Train Show at Kirkwood Community Center at West Argonne Drive and South Geyer Road. Event sponsored by Mississippi Valley N Scalers. Info at [seetrains.com](http://seetrains.com).

**MISSOURI, LA PLATA**, October 19, 7th Annual Silver Rails Model Train Show at the Silver Rails Event Center, 204 E Moore St. Hosted by the American Passenger Rail Heritage Foundation. Info at [aprhf.org](http://aprhf.org).

**MISSOURI, SEDALIA**, October 29, Sedalia Rails Train Show, sponsored by Pettis County Historical Society, at Liberty Park Convention Hall, 1500 3rd Street at Highway 65. Info from Ken Bird at [klbird@embarqmail.com](mailto:klbird@embarqmail.com).

**NEW JERSEY, HILLSBOROUGH**, October 1, NMRA Garden State Division Fall Meet, at Hillsborough Township Municipal Building. Info at [nergds.com/upcoming.html](http://nergds.com/upcoming.html).

**NORTH CAROLINA, DURHAM**, October 20-23, Mid-Eastern Region Fall Convention, sponsored by NMRA Carolina Piedmont Division, at Marriott at Research Triangle Park, 4700 Guardian Drive. Info at [mer2016.org](http://mer2016.org).

## SELECTED EVENTS | 4

**NORTH CAROLINA, HENDERSONVILLE-ASHEVILLE**, October 7-8, Autumn Rails All Scales Train Show, sponsored by French Broad e'N'pire Model Railroad Club, at Expo Building, WNC Agricultural Center, 1301 Fanning Bridge (off NC 280). Info at [nrmrc.org/events/shows/french-broad-enpire-autumn-rails-2016](http://nrmrc.org/events/shows/french-broad-enpire-autumn-rails-2016).

**OHIO, CINCINNATI**, Oct 8-9, Train & Trade Show, sponsored by NMRA Cincinnati Division 7, at Lakota West High School, 8940 Union Center Avenue. Info at [cincy-div7.org/events.html](http://cincy-div7.org/events.html).

**TEXAS, FOREST HILL**, October 8-9, Texas Western Train Show, at Forest Hill Civic Center, 6901 Wichita Street. Info at [twmrc.org](http://twmrc.org).

**TEXAS, SAN ANTONIO**, October 1-2, Model Train Show sponsored by Alamo Model Railroad Engineers Society at Freeman Coliseum, Expo Hall A, 3201 East Houston Street. Info at [txtransportationmuseum.org/event-amre-train-show.php](http://txtransportationmuseum.org/event-amre-train-show.php).

**VIRGINIA, VIRGINIA BEACH**, October 8-9, 27th Annual Train Show & Sale, at Virginia Beach Convention Center, 1000 19th Street, sponsored by Tidewater Division Model Railroaders. Info at [nmra-mer-tidewater.org](http://nmra-mer-tidewater.org).

**WASHINGTON, CHEHALIS**, October 8-9, Model Railroad Show & Swap Meet, at Southwest Washington Fair Grounds, Blue Pavilion Exhibit Building, 2555 North National Avenue. Sponsored by Lewis County Model Railroad Club. Info from [ted-strains@lewiscounty.com](mailto:ted-strains@lewiscounty.com).

## November 2016

**CANADA. BRITISH COLUMBIA, VANCOUVER**, November 5-6, 34th Vancouver Train Expo, at PNE Forum, 2901 East Hastings Street. Info at [vancouvertrainexpo.ca](http://vancouvertrainexpo.ca).

## SELECTED EVENTS | 5

**CANADA, BRITISH COLUMBIA, VANCOUVER**, November 3-6, Railway Modellers Meet, sponsored by NMRA, PNR 7th Division, at Atrium Inn, 2889 East Hastings Street. Info at [railwaymodellermeeetofbc.ca](http://railwaymodellermeeetofbc.ca).

**CANADA, NEW BRUNSWICK, QUISPAMISIS (Saint John)**, November 5, 32nd Annual Model Train Show at Island View Lions Club, 8 Market Street. Sponsored by Saint John Society of Model Railroaders. Info at [sites.google.com/site/sjsmrclub](http://sites.google.com/site/sjsmrclub).

**CANADA, ONTARIO, HAMILTON**, November 5, 2016 Hamilton & District Layout Tour at 22 home and club layouts in N, HO, and O scales (G scale weather permitting). Guide books available at local hobby shops. Info at [trainweb.org/homesclub](http://trainweb.org/homesclub).

**CALIFORNIA, SACRAMENTO**, November 12-13, Open House at Sacramento Model Railroad Historical Society, 1990 Grand Ave. Both HO and HOn3 narrow gauge layouts will be operating. Info at [smrhs.com](http://smrhs.com).

**MICHIGAN, EAST LANSING**, November 13, Lansing Model Railroad Club Show and Sale at Michigan State University Pavilion. Michigan's largest show, layouts, demonstrations, and 500+ tables. Info at [lmrc.org](http://lmrc.org).

**MICHIGAN, SALINE**, November 27, Southeast Michigan Model Train Show and Sale, sponsored by Rails on Wheels, at Washtenaw Farm Council Grounds, 5055 Ann Arbor-Saline Road. Info from Jeff at [wab2ndops@yahoo.com](mailto:wab2ndops@yahoo.com).

**NEW JERSEY, SCOTCH PLAINS**, November 5, Third Annual Garden State RPM, at Union County Vocational School, 1776 Raritan Road. Info at [gsrpm.org](http://gsrpm.org).

**OHIO, DAYTON**, November 5-6, Dayton Train Show, sponsored by NMRA Mid-Central Region, Division 3, at Upper Valley Mall, 1475 Upper Valley Pike. Info at [daytontrainshow.com](http://daytontrainshow.com).

## SELECTED EVENTS | 6

**OHIO, VANDALIA**, November 9-10, Annual Open House at Crossroads Railroad Club, 304 N. Dixie Drive. Info at [crossroad-srr.com](http://crossroad-srr.com).

**OREGON, CENTRAL POINT**, Nov 26-27, Rogue Valley Railroad Show, at Jackson County Expo, 1 Peninger Road. Request info from Bruce at [iwcr@charter.net](mailto:iwcr@charter.net).

**PENNSYLVANIA, ALLENTOWN**, November 12-13, First Frost Train Meet Show and Sale, at Allentown Fairgrounds, Agricultural Hall. Info at [allentowntrainmeet.com](http://allentowntrainmeet.com).

**PENNSYLVANIA, MONACA**, November 20, Beaver County Fall Model Train Show, at Monaca Turners, 1700 Old Brodhead Road. Info at [bcmrr.railfan.net](http://bcmrr.railfan.net).

**SOUTH CAROLINA, NORTH CHARLESTON**, November 19-20, Charleston Area Model Railroad Club Annual Train Show, at Danny Jones Armory Park, 5000 Lackawanna Boulevard. Info at [chamrc.com](http://chamrc.com).

**WASHINGTON, KENT**, November 12, 37th Annual Model Railroad & Railroadiana Swap Meet, sponsored by Boeing Employees Model Railroad Club, at Kent Commons, James & 4th Avenue. Info from Ed Sherry at [swapmeet@bemrrc.com](mailto:swapmeet@bemrrc.com).

### Future 2016, by location

**OHIO, SANDUSKY**, December 3, Open House at Erie & Mad River Model Railroad, 1309 North Depot Street. Request info from Robert Butler at [robertbutler@bex.net](mailto:robertbutler@bex.net).

**OKLAHOMA, OKLAHOMA CITY**, December 1-4, 21st Southern Plains N-Scale Convention, at Oklahoma State Fairgrounds. Convention hotel is Wingate Oklahoma City Airport, 2001 South Meridian Avenue. Info at [oknrail.org/convention](http://oknrail.org/convention).

## SELECTED EVENTS | 7

### Future 2017 and beyond, by location

**AUSTRALIA, VICTORIA, GEELONG**, April 14-16, 2017, 13th Annual Australian Narrow Gauge Convention. Info at [austnarrow-gaugeconvention.com](http://austnarrow-gaugeconvention.com) .

**CALIFORNIA, RIVERSIDE-SAN BERNARDINO AREA**, February 25, 2017, Self Guided Layout Tour and Swap Meet. Request info from coordinator Bob Chaparro at [chiefbobbb@verizon.net](mailto:chiefbobbb@verizon.net) .

**COLORADO, DENVER**, August 30-September 2, 2017, National Narrow Gauge Convention, at Marriott Denver Tech Center Hotel. Info at [37nngc.com](http://37nngc.com).

**FLORIDA, ORLANDO**, July 30-Aug 5, 2017, NMRA National Convention. Info at [nmra2017.org](http://nmra2017.org).

**MISSOURI, KANSAS CITY**, August 5-12, 2018, NMRA National Convention. Info at [kc2018.org](http://kc2018.org).

**SOUTH CAROLINA, EASLEY**, February 10-11, 2017, Annual Train Show, sponsored by Central Railway Model & Historical Association at (new location) Impact Center, Rock Springs Church 207 Rock Springs Road. Info at [crmha.org](http://crmha.org).

**UTAH, SALT LAKE CITY**, July 7-13, 2019, NMRA National Convention. Info at [nmra2019slc.org](http://nmra2019slc.org).

**WASHINGTON, MONROE**, February 25-26, 2017, 26th Annual Washington State Train Show and Marketplace, at Evergreen State Fairgrounds. Event sponsored by United Northwest Model Railroad Club. Info at [unwclub.org](http://unwclub.org). ■



Click here for  
reader comments

# Did you know there's an MRH index available?

CLICK TO FIND OUT MORE

*The* Get the Latest Model Railroading News, Tips, Reviews & Opinions  
**SCOTTY MASON**  
S H O W  
*The Original Model Railroad Podcast*

## -Monthly Interviews

- Modeler's Spotlight: Top Modeler's Talk
- Narrow Gauge Modeling w/Chris Lane
- Contemporary Modeling w/ Mike Rose

## -More Product Announcements & Reviews



Our feed has changed! To get the latest shows,  
Please search Scotty Mason and subscribe to the new feed!

[www.TheModelRailroadPodcast.com](http://www.TheModelRailroadPodcast.com)

Scott Mason Jimmy Simmons Mike Rose Joe Duckworth

# Clickable advertiser index – 1

[Accu-Lites](#)

[American Ltd \(San Juan\)](#)

[Amherst Railway Society](#)

[ANE Models](#)

[AQ Hobbies](#)

[Archer Fine Transfers](#)

[Athearn](#)

[Atlas Model Railroad Co.](#)

[Bachmann](#)

[Bachrus](#)

[Backdrop Junction](#)

[Banta Model Works](#)

[Berrett Hill Trains](#)

[Black Cat Publishing](#)

[Blair Line](#)

[Bowser](#)

[Canyon Creek Scenics](#)

[Clever Models](#)

[Coffman Graphics](#)

[Credit Valley Railway](#)

[Digitrax \(2 page spread\)](#)

[East Penn Traction Club](#)

[ESU LokSound](#)

[Fast Tracks](#)

[Fox Valley Models](#)

[GLX Scale Models](#)

[Great Decals](#)

[HO Diesel Supply](#)

[Iowa Scaled Engineering](#)

[Iwata-Medea](#)

[Jim's Track Plans](#)

[KC's Workshop](#)

[Ken Patterson.com](#)

[Lights 4 Models](#)

[Litchfield Station](#)

[Logic Rail Technologies](#)

[Main Street Heritage Models](#)

[Missouri Locomotive Co.](#)

[Model Railroad Benchwork \(1\)](#)

[Model Railroad Benchwork \(2\)](#)

[Model Rectifier Corporation](#)

[Monster Modelworks](#)

[Montreal Vermont & Essex](#)

[Motrak Models](#)

[Mountain Subdivision Hobbies](#)

[MRH Store \(1 - 2 page spread\)](#)

[MRH Store \(2\)](#)

[MRH Store \(3\)](#)

[Mt. Albert Scale Lumber](#)

[NCE \(2 page spread\)](#)

[Nick & Nora Design](#)

[North American Railcar Co.](#)

[North Texas Council of RR Clubs](#)

[Oak Hill MRR Track Supply](#)

[Pre-Size Model Specialities](#)

[Precision Design Co.](#)

[Railmaster Hobbies](#)

[Rapido \(1\)](#)

[Rapido \(2\)](#)

[Ring Engineering \(1\)](#)

[Ring Engineering \(2\)](#)

[Rulers-of-the-World](#)

[Rusty Stumps](#)

[Scale Trains](#)



# Clickable advertiser index – 2

[Scotty Mason Show](#)

[Select Model Railroads](#)

[Signature Press](#)

[Soundtraxx \(Blackstone\)](#)

[Southern Digital](#)

[Streamlined Backshop Services](#)

[TAM Valley Depot](#)

[Tony's Train Exchange](#)

[Train Control Systems](#)

[Trainfest 2016](#)

[TrainMasters TV \(1\)](#)

[TrainMasters TV \(2\)](#)

[TrainMasters TV \(3\)](#)

[Traintek](#)

[TSG Multimedia](#)

[Walthers](#)

[Westerfield Models](#)

[Yankee Dabbler](#)

[Yarmouth Model Works](#)

# Clickable “other” index

---

[Other – Cover](#)

[Other – Derailments](#)

[Other – Hobby Marketplace](#)

[Other – MRH Sponsors](#)

[Other – Contents](#)

## DOWNLOAD ISSUE



DOWNLOAD PORTRAIT



DOWNLOAD LANDSCAPE

• INDEX

• TABLE OF CONTENTS



# REVERSE RUNNING

commentary

LANCE MINDHEIM  
.....



[Click here for  
reader comments](#)

This piece was just too good to pass up as a Reverse Running, so we're breaking tradition to present this special *two spread* Reverse Running by Lance Mindheim.  
*-The MRH Staff*

## THE CASE FOR ONLY ONE PENINSULA

### THE VAST MAJORITY OF A RAILROAD'S RIGHT OF WAY

is linear. Capturing that look in our limited space is a challenge, to say the least!

The shortest distance between two points is a straight line. Of more importance, from a railroad's point of view, it's generally the cheapest. As modelers, we have a disconnect between how the real world looks and the harsh

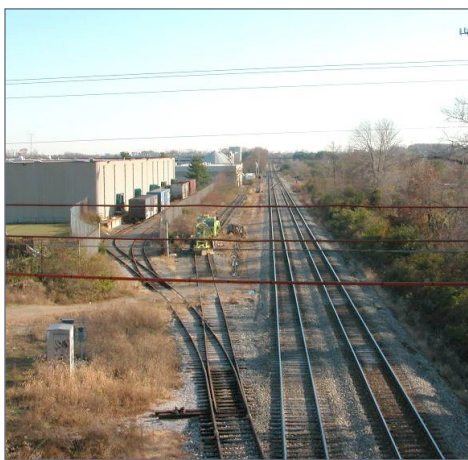

reality that our railroads are located in rooms that dictate all too frequently we hit the proverbial wall and must make a turn.

▶ STEPPING OUTSIDE THE BOX WITH A CONTRARY VIEW

We can't eliminate the problem, but there are design approaches that address the challenge more effectively than others.

The benchmark footprint, and its overlaid mainline route, is one of the most important design decisions. That being the case, I want to delve a little deeper into different benchmark footprint options.

The more a design footprint maximizes linear runs and minimizes curves, the more it lends itself to inserting the features we desire the most, such as yards, sidings, towns, and long bridges.

Long, straight runs are prime. The more the better. The longer the better. Ninety or 180 degree curves are very limiting. The fewer the better.

Many years ago Einstein (or maybe it was the Batavia club in Illinois. I can't remember) determined that the most efficient use of a given space is an around the walls design with only ONE serpentine peninsula. Not three, not two, *just one*.

For our purposes, we'll define efficiency as a design that not only creates the longest main line run, but the run with most straight sections. This assumes a plan where the main only passes through a scene once.

If you take the same space, and go to a format with multiple peninsulas, the quantity and quality of your straight sections drops precipitously because so much of the run is spent getting into and out of curves.

Let's take a look at an example to see why things shake out this way. For illustration purposes, let's assume a room 24 feet long by 14 feet wide.

Shown on the next page is an approach that shows multiple peninsulas. Linear track is shown in red, curves in black.

## REVERSE RUNNING | 3

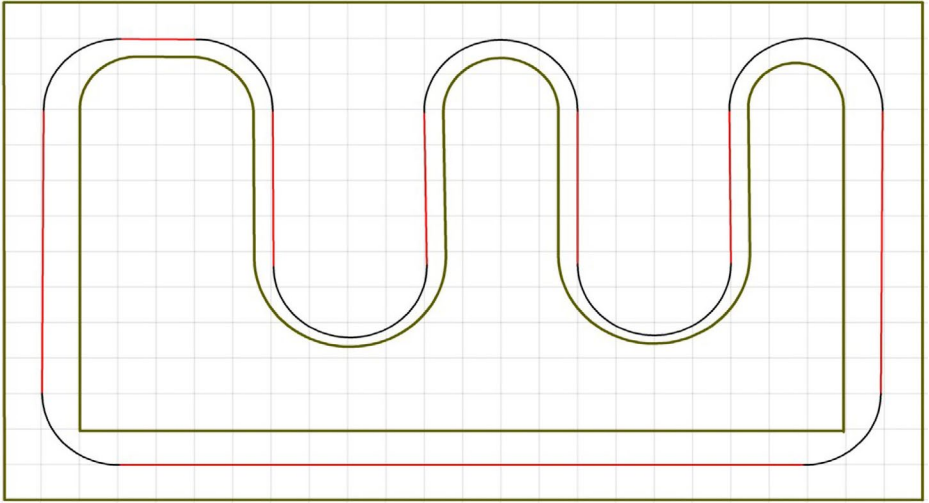

By contrast, below is a second diagram showing the footprint where only ONE serpentine peninsula was used. Note the much longer linear runs that we so desperately need.

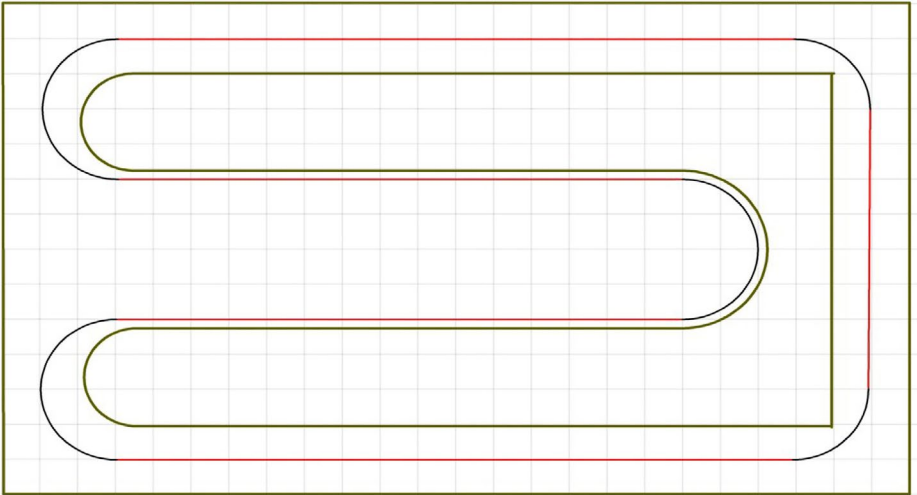

The next table shows how the numbers work out. Note that in addition to having a 10 percent longer main line run, the one peninsula plan has a whopping 50 percent more linear track.

# REVERSE RUNNING | 4

|                           | Total Run Length (feet) | Amount of Linear Track | Amount of Track on Curves |
|---------------------------|-------------------------|------------------------|---------------------------|
| One Peninsula Layout      | 99                      | 74                     | 25                        |
| Multiple Peninsula Layout | 91                      | 53                     | 38                        |

That's only part of the story though.

| Breakdown of Linear Track Segments                               |                  |  |                     |
|------------------------------------------------------------------|------------------|--|---------------------|
| (Number of linear segments and their respective lengths in feet) |                  |  |                     |
|                                                                  | Single Peninsula |  | Multiple Peninsulas |
|                                                                  | 18 ft.           |  | 18 ft.              |
|                                                                  | 18 ft.           |  | 8 ft.               |
|                                                                  | 15 ft.           |  | 8 ft.               |
|                                                                  | 15 ft.           |  | 4.5 ft.             |
|                                                                  | 8 ft.            |  | 4.5 ft.             |
|                                                                  |                  |  | 4.5 ft.             |
|                                                                  |                  |  | 4.5 ft.             |
|                                                                  |                  |  | 2 ft.               |
| <b>Total</b>                                                     | <b>74 ft.</b>    |  | <b>54 ft.</b>       |

It's not just that the single peninsula has a longer linear run. The quality of those runs is higher. Looking at the multiple peninsula plan, although it has 54 feet of linear run, that's misleading because the number is comprised of a lot of short runs. Of the 54 feet, 20 of that is made up of less than useful stretches of less than five feet. In comparison, the single peninsula plan is comprised of a high percentage of relatively long linear runs.

Wrapping things up, modeling the most common rail scenes is much easier the more long, linear runs of track we have. The around the walls with ONE center peninsula configuration provides that in heavier doses than other options.

Originally from Lance's Blog at: [shelflayouts.com/2016/09/the-case-for-only-one-peninsula](https://shelflayouts.com/2016/09/the-case-for-only-one-peninsula)



# DERAILMENTS



Photoshopped by Charley Hepperle

Automotive fans of a certain age should get the joke: An oil train with locos in Gulf livery is beating one in Shell livery. It's a reference to the Ford GT race cars in the mid-1960s (at least one in blue and orange, Gulf sponsored) winning against Ferrari race cars (in red and typically Shell sponsored). The engine numbers are also car-related: "427" for the would-be Ford and "250" for the would-be Ferrari. It was a huge embarrassment for Ferrari to lose to Ford.

► BIZARRE FACTS AND HUMOR (SUPPOSEDLY)

# YOU MIGHT BE A RAILFAN IF ...

- You have a denim vest or jacket that has more patches than the earth has carbon molecules.
- Your scanner is on 24 hours a day, seven days a week.
- The number 844 gets you more excited than the number 23 (Michael Jordan's jersey number).
- Your car has a bumper sticker that says "This vehicle stops at all railroad crossings."
- You've been known to stand on a car roof to see tracks behind a fence. ■

## GET PAID ...

If you're the first to submit a bit of good humor or bizarre facts and we use it, it's worth \$25! Just send to [derailments@mrhmag.com](mailto:derailments@mrhmag.com) ■

## Coming next issue ...

- Another easy real railroads segment: Andy Rubbo's Pennsy New York Division
- Building a pumphouse
- SW900E loco kitbash
- Modeling gravel loads
- Report from the 2016 National Narrow Gauge convention
- And lots, *lots* more!

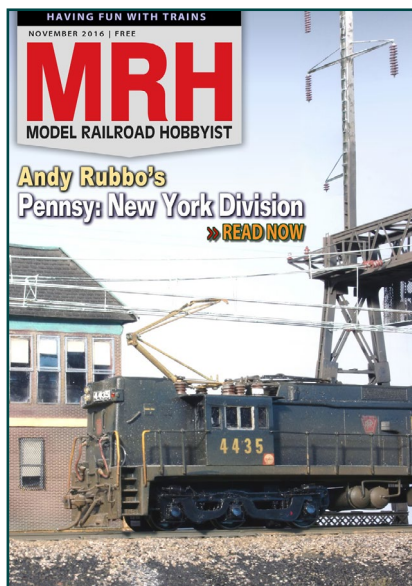

**Click here for  
reader comments**