

HAVING FUN WITH TRAINS

SEPTEMBER 2016 | FREE

MRH

MODEL RAILROAD HOBBYIST

Neil Schofield kitbashes
A Bowser Conrail C636
» **READ NOW**

ALSO:

- Hiding a helix
 - Build a photo backdrop
 - Toolshed: Pliers and cutters
 - More accurate railcar trucks
 - Build a cement road
- ... and lots more inside!*



EMBEDDED EDITION | LANDSCAPE



DOWNLOAD

• INDEX

• TABLE OF CONTENTS



ALL ABOARD THE ATLAS HO MODERN COMMUTER TRAIN



CLICK HERE!



Multi-Level Trailer

Multi-Level Cab Car



Multi-Level Trailer with Safety Slogan

Multi-Level Trailer with Toilet

*Products bearing NJ TRANSIT marks are made under trademark license from NJ TRANSIT.



Model Railroad Hobbyist | Sep 2016 | #79

STAFF CREDITS

Front cover: In our September cover story, Neil Schofield models Conrail 6792 by upgrading a Bowser Executive Line Alco C636.



ISSN 2152-7423

Editorial Staff

Joe D. Fugate, Publisher and Editor
Don Hanley, Assistant Editor

Production

Patty Fugate, Pasteup and Layout
Joe Brugger, Copy Editing
Mike Dodd, Copy Editing

Technical Assistant

Jeff Shultz

Advertising

Les Halmos, Account Manager
Daniel Nava, Advertising Assistant
Jean-François Delisle, Marketing Assistant

Columnists

Richard Bale, News and events
Jeff Shultz, News and events
Les Halmos, Modular railroading
Larry Smith, Narrow Gauge/Shortlines
Bruce Petrarca, DCC
Ken Patterson, Reporter at large

Special Correspondents

Joe Brugger, Questions & answers
Charlie Comstock, Contributing editor

Issue password: Sep2016

Published for the glory of God. [What's this?](#)



MRH SPONSORS

A - E



acculites.com



americanlimitedmodels.com



railroadhobbyshow.com



anemodel.com



archertransfers.com



athearn.com



www.atlasrr.com



bachmanntrains.com



bachrus.com



backdropjunction.com

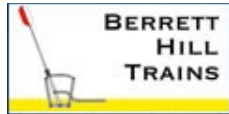

berrethill.com/trains



blairline.com



bowser-trains.com



caboosehobbies.com



coffmaneng.com



cvrco.com



coastmans.com



www.digitrax.com



esu.eu/en

F - R



www.handlaidtrack.com



foxvalleymodels.com



georgetrains.com



glxscalemodels.com



www.iascaled.com



iwata-medea.com



litchfieldstation.com



micromark.com



moloco.biz



model-trains-video.com



modelrectifier.com



monstermodelworks.com



stores.ebay.com/Motrak-Models



mtalbert.com



ncedcc.com



nickandnoradesigns.com



nwhs.org



www.pwrs.ca/main.php



railmasterhobbies.com



rapidotrains.com



ringengineering.com



rustystumps.com

[Vendors: Get your clickable logo here ...](#)

[Vendors: Get your clickable logo here ...](#)

MRH SPONSORS | 3

S - Z



sanjuancarco.com



scaletrains.com



soundtraxx.com



sodigi.com



sbs4dcc.com

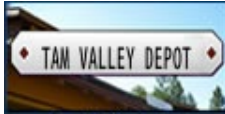

tamvalleydepot.com



tonystrains.com



trainmastermodels.com



trainteklc.com



tsgmultimedia.com



yankeedabbler.com

[Vendors: Get your clickable logo here ...](#)

Looking for something? Check the MRH Marketplace!

Take me there!

THREE NEW HO TRAIN SETS EXCLUSIVELY FROM BACHMANN!



NEW

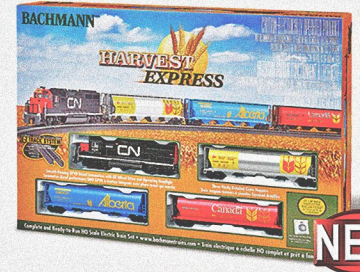

NEW



NEW



Bachmann newest ready-to-run electric train sets offer unique designs that will appeal to a wide range of HO scale modelers. They include everything needed to get started in model railroading: an EMD GP40 locomotive with operating headlight, cars, snap-fit E-Z Track®, power pack, and speed controller. The *Coastliner* boasts a CSX paint scheme and two flat cars with container loads plus caboose. Our *Harvest Express* features three colorful Canadian grain hoppers. With two bi-level full-dome passenger cars, the *McKinley Explorer* treats passengers to breathtaking views of the Alaskan wilderness. Visit your favorite hobby dealer to get on board with these exciting new train sets today!



COASTLINER
Item No. 00734
MSRP \$199.00

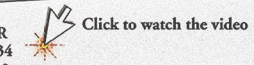

HARVEST EXPRESS
Item No. 00735
MSRP \$239.00



McKINLEY EXPLORER
Item No. 00743 (New cube-style box)
MSRP \$269.00

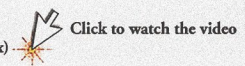

SHIPPING NOW!



Bachmann Industries, Inc. • 1400 East Erie Avenue • Philadelphia, PA 19124 USA • www.bachmanntrains.com



TABLE OF CONTENTS

FEATURES

Upgrading a Bowser Conrail C636

NEIL R. SCHOFIELD

Easy upgrades to an Alco C636 diesel loco



Build a photographic backdrop

BILL WILKEN

Free software & photo libraries for a backdrop



Pliers and cutters

JACK BURGESS

Beyond needle-nose pliers for modeling



Build a C&E boom car

DAVE AND DOUG FORBES

Model a prototype kitbash of this unique car



Rolling stock painting handle

GRAEME NITZ

Make this versatile handle for little cost



ALSO: MRH Marketplace | Subscriber extras

COLUMNS

MRH Q-A-T: Telltales, track warrants, ...

compiled by JOE BRUGGER

DCC Impulses: Traveling with DCC

BRUCE PETRARCA

Getting Real: More accurate railcar truck modeling

TONY THOMPSON

What's Neat: Quick switches, cement roads ...

KEN PATTERSON

Imagineering: Hiding a helix

ROB CLARK

Photo feature: Yes, it's a model

compiled by DON HANLEY

Derailments: Bizarre facts & humor

compiled by the MRH STAFF

NEWS and EDITORIAL

Publisher's Musings: Clearance differences by era

JOE FUGATE

News & Events: September 2016

RICHARD BALE & JEFF SHULTZ

Reverse Running: Forget foam for roadbed

JOE FUGATE

SEE THE DIFFERENCE AGAIN!



NEW ROAD NUMBERS



Union Pacific GTEL 8500 Horsepower "Big Blow" Turbine

Preorder Now



© 2016 ScaleTrains.com, Inc. ScaleTrains.com, Museum Quality and Rivet Counter plus respective logos are trademarks of ScaleTrains.com, Inc. ScaleTrains.com, Inc. 7598 Highway 411 Benton, TN 37307 844-9TRAINS 844-987-2467
 www.SCALETRAINS.COM
 Scene and photography by Ken Johnson. Actual models shown

Model Railroad Hobbyist | September 2016 | #79

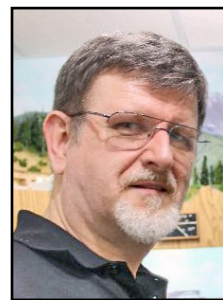

PUBLISHER'S MUSINGS

editorial

JOE FUGATE



Click here for reader comments

CLEARANCE STANDARD DIFFERENCES BY ERA

MY FIRST BOOK IN THE *RUN LIKE A DREAM* series, on trackwork, is nearing completion – in fact, it should start shipping later this month (store.mrhmag.com/store/p115/ebook/run-like-a-dream).

Because I've been writing this book, I have delved into the trackwork topic more deeply than I've ever seen in any book. I look at all scales, but especially I discuss the two most popular scales: HO and N.

Since the early days of the NMRA in the 1940s until the 1980s, the classic NMRA gauge has served us well. But as the years have gone by, railroad clearances in the modern era have increased. To address these clearance changes, the NMRA has issued a plastic extension to their HO and N scale gauges – see the image on the right.

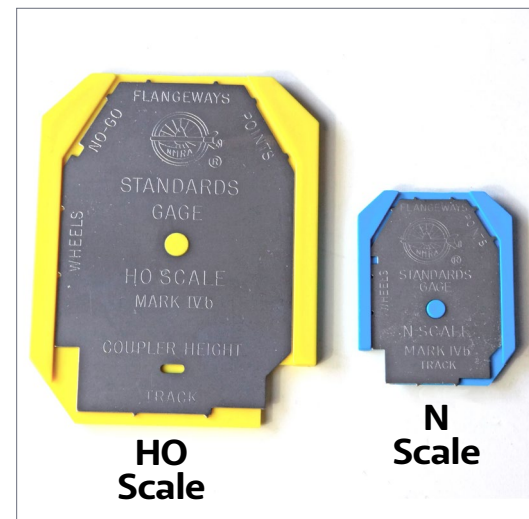

PUBLISHER'S MUSINGS | 2

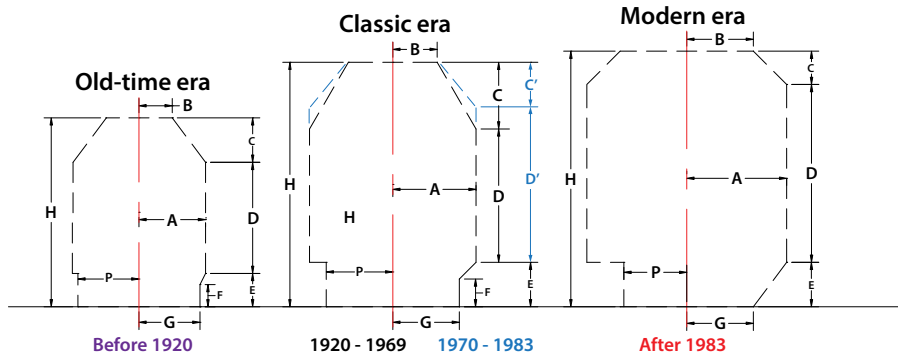

Era	A	B	C/C'	D/D'	E	F	G	H	P
Old-time	6 ft	3 ft	4 ft	10 ft	3 ft	2 ft	5 ft 6 in	17 ft	5 ft 6 in
Classic	7 ft 6 in	4 ft	6 ft / 4 ft	12 ft / 14 ft	4 ft	2 ft 6 in	6 ft	22 ft	6 ft
Modern	9 ft	6 ft	3 ft	16 ft	4 ft	--	6 ft	23 ft	5 ft 7 in

What some may not realize is that pre-1920 railroad clearances were quite a bit less than the classic NMRA gauge. See the diagram above from my trackwork book for the clearances by era.

ADVERTISEMENT

END OF TRAIN DEVICE

NEW ORANGE CASE!

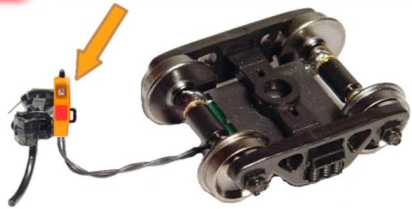

Patented Technology - US Patent 7,549,609

Bright Red Flashing Light!

Installs in minutes!
No freight car modification required!



Click Here to Learn More

Does not affect Load!

↓ Car without Load ↓

↓ Car with Load ↓



Rapido factory updates on our Youtube channel..

Click here
to watch the latest one!

Checked us out lately?

- ✓ HO/N and now O scale products too!
- ✓ Laser-cut Structures & Bridges.
- ✓ Advertising & Storefront Signs.
- ✓ Highway Signs, vintage & modern.
- ✓ New Detail Items.
- ✓ Laser-cut Grade Crossings.
- ✓ Billboards, roadside & rooftop.
- ✓ Laser-cut Graffiti Decals
- ✓ 1000's of satisfied customers.

WHAT'S NEW? Established 1993...
 **Blair Line**



Archer

FINE TRANSFERS
PROUDLY SERVING MODEL BUILDERS SINCE 1989

THE ORIGINAL
SURFACE DETAILS™

WE NOW HAVE MORE THAN 100 SHEETS OF RIVETS, LOUVERS, TREADPLATE AND MORE CAST ONTO MICROSCALE CLEAR DECAL FILM

FREE SHIPPING:

- DOMESTIC USA ORDERS \$50 OR MORE
- INTERNATIONAL ORDERS \$100 OR MORE

CLICK HERE TO VISIT OUR WEBSITE!

Archer Fine Transfers • PO Box 1277 • Youngsville, NC 27596 • USA
(919) 570-1026 • info@archertransfers.com • archertransfers.com

"Archer rivets are easy to apply and look great. To me, they are now a vital tool in building railroad models."

Tony Thompson, Model Railroad Author/Historian

PUBLISHER'S MUSINGS | 3

If you model a pre-1920 era, then you can actually cut down clearances to be a lot less than what is indicated with the NMRA gauge, by quite a bit less, actually. Equipment was smaller in the early days of railroading.

The diagram and table on the previous page gives the dimensions in actual 1:1 feet, so you can use it as a guide for any scale. This information comes from the NMRA S-7 standard on clearances, see: [\[nmra.org/sites/default/files/standards/sandrp/pdf/s-7_2012.02.pdf\]](http://nmra.org/sites/default/files/standards/sandrp/pdf/s-7_2012.02.pdf).

The classic NMRA gauge gives the proper clearances from 1920 to 1970 for the prototype. The classic NMRA gauge also works for the most part from 1970 to 1983, with just a bit more clearance needed on the upper corners for taller equipment. But from 1983 on, if you're going to run the more modern equipment, you will need to

MAKE MODEL RAILROADING
Come Alive
 — AMTRAK TRAIN SET —



NEW PAINT SCHEMES

FROM VINTAGE TO MODERN ERA, WE HAVE THE RIGHT SET FOR YOU

Athearn train sets return in 2016 as part of our new Roundhouse line. A wide variety of eras and railroads will be offered with an emphasis on fun. We are creating products for both beginners and experienced modelers alike.

TRAIN SETS: \$219.99

- RND14750 HO Streamliner Train Set, Amtrak
- RND14751 HO Streamliner Train Set, PRR
- RND14262 HO GP38-2 Iron Horse Train Set, CN Web Address
- RND14263 HO GP38-2 Iron Horse Train Set, KCS Retro Belle (New Road Name)
- RND14266 HO GP38-2 Iron Horse Train Set, CSX "How Tomorrow Moves"
- RND14267 HO GP50 Iron Horse Train Set, UP

TRAIN SETS: \$239.99

- RND14265 HO GP50 First Responder Train Set, BNSF Fire Train, Firetruck Included
- RND14264 HO GP38-2 First Responder Train Set, NS Safety Training, Firetruck Included



Visit athearn.com for more details!

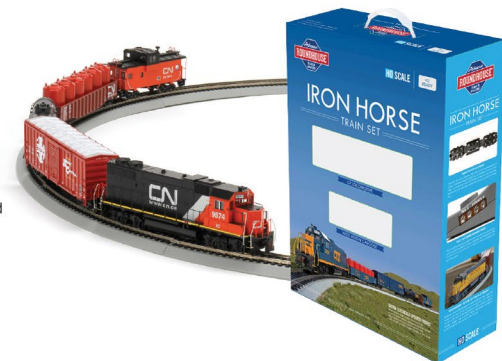

HORIZON
H O B B Y

VISIT
Your Local Retailer

CLICK
Athearn.com

CALL
1.800.338.4639

SERIOUS FUN™

©2016 Horizon Hobby, LLC. Athearn, Genesis, Ready To Roll, Trains in Miniature, Serious Fun and the Horizon Hobby logo are trademarks or registered trademarks of Horizon Hobby, LLC. The Union Pacific mark and other marks owned by Union Pacific are made under trademark license from Union Pacific Railroad Company. All other trademarks, service marks and logos are property of their respective owners. Final models may vary slightly from photos shown. 53595

HO GP60M, GP60B AND GP60 Locos



NOW AVAILABLE !



DC OR DCC WITH SOUND!



www.foxvalleymodels.com

ADVERTISEMENT

George's Trains EST. 1962
Canada's Greatest Model Train Store!

20 NEW Colours Just added!

PROTO-PAINT

ACRYLIC-Air Brush Ready
NOW OVER 45 Canadian Railway Colours!

Dealer inquiries welcome.

PP-001 CNR Green #11	PP-020 TH&B Maroon	PP-038 TTC CREAM
PP-002 CNR Imitation Gold	PP-021 Primer	PP-039 TTC Maroon
PP-003 CNVIA Blue #16	PP-022 Reducer	PP-040 Warm BLACK
PP-004 CNVIA Yellow #18	PP-023 Flat Finish	PP-041 Grimy Black
PP-005 VIA Grey	PP-024 Stencil White	PP-042 Anti-Glare Black
PP-006 CN Red/Orange #11	PP-025 Loco Black	PP-043 Slag Brown
PP-007 CN Lettering Grey #17	PP-026 Flat Haze	PP-044 GO Green
PP-008 CN Grey #11	PP-027 ONR LT BLUE	PP-045 GO White
PP-009 CNR Red #12	PP-028 ONR DK BLUE	PP-046 CONRAIL Blue
PP-010 CPR Tuscan	PP-029 ONR YELLOW	
PP-011 CPR Diesel Grey	PP-030 ONR Post 2000 Yellow	
PP-012 CPR Diesel Yellow	PP-031 ONR GREEN	
PP-013 CPR Steam Grey	PP-032 BCR/PGE DK GREEN	
PP-014 CPR Mineral Brown	PP-033 BCR RED	
PP-015 CP Action Red	PP-034 BCR Blue	
PP-016 CP Action Yellow	PP-035 BCR Yellow	
PP-017 CP Action Green	PP-036 BCR/PGE LL GREEN	
PP-018 CP Bright Red	PP-037 GTW Blue	
PP-019 TH&B Cream		

\$9.98 each Canadian

ORDER NOW!

550 Alden Rd. Unit 101 Markham, On, Canada L3R 6A8
Tel: 905-470-6200 Toll Free: 1-877-31RAINS (887-2467)
www.georgetrains.com

PUBLISHER'S MUSINGS | 4

get and use the plastic extension for your NMRA gauge.

These NMRA gauge clearances are for bridges, structures like tunnels and buildings, and for tangent (straight) track. That's right, these clearances are for *straight track* only.

When it comes to curves, the side-to-side clearance requirements go up, so don't rely on the gauge (or this table) alone!

To determine needed clearances on your curves, use your longest car and loco to field-test the clearances you will need. If one of those monsters fits past all your platforms and through all your tunnel portals and bridges, then all your other cars can make it through, no problem.

For those modeling the steam era, watch out for the swinging boiler on a model Norfolk & Western Y6 or a Union Pacific Big Boy – it can wipe out opposing traffic on curves that are set too closely together.

From these clearances, it's possible to derive other useful

PUBLISHER'S MUSINGS | 5

dimensions. For instance, A times two is the total clearance width needed for the right-of-way (Old-time: 12 ft., Classic: 15 ft., and Modern: 18 ft.).

Taking G times two gives the total clearance needed for just the roadbed (Old-time: 11 ft., Classic and Modern: 12 ft.).

Adding E plus D gives total equipment height (Old-time: 13 ft., Classic-early/late: 16 ft./18 ft., and Modern: 20 ft.). Of course, double-stacks fully loaded can approach the value of H (23 ft.) with only inches to spare on the prototype.

And here's a useful tip: the E plus D dimension can also be used to arrive at a less-than-full height clearance for situations that have height constraints on your layout. But always field-test this with your actual equipment to be sure!

Keep in mind these are ideal dimensions assuming relatively accurate scale models. That may not always be the case: these NMRA clearances have

coastmans



TREES Reinvented

made in Oregon, USA

www.coastmans.com

been made slightly greater than the prototype to allow for variations in model bridges, tunnel portals, buildings, trucks, wheels, and model car width.

As long as your car or locomotive doesn't ride high on its trucks and any containers are the correct height, you will clear the height requirement as given.

The only thing constant is change, it seems. From these updated clearance guidelines, it appears we can officially declare the modern era as starting after 1983. ☑

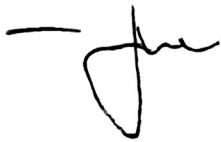

Click here for reader comments

ADVERTISEMENT



WE ONLY SELL WHAT WE MANUFACTURE

DETAILS IN HO, O, S & N SCALES

LASER CUT SHINGLES, DOORS & WINDOWS, FENCES, SIDING, CRATES. Also RESIN and WHITE METAL DETAILING CASTINGS.

CRAFTSMAN KITS IN HO, O & S SCALES

CHECK IT ALL OUT AT WWW.RUSTYSTUMPS.COM

Send \$3.50 for Catalog - Specify Scale

RUSTY STUMPS SCALE MODELS

6785 Cherry Blossom W. Dr., Fishers IN 46038

Phone (317) 595-9489

MRH SECOND ANNUAL "ONE MODULE" CHALLENGE CONTEST

ENTRY DEADLINE: January 31, 2017

Goal: Design the first "module section" for a sectional home layout design.

Hypothetical room is 10' x 14' - 2'x'8' closet can be used; window can be covered.

Note: This is a sectional home layout design, no modular standard required.

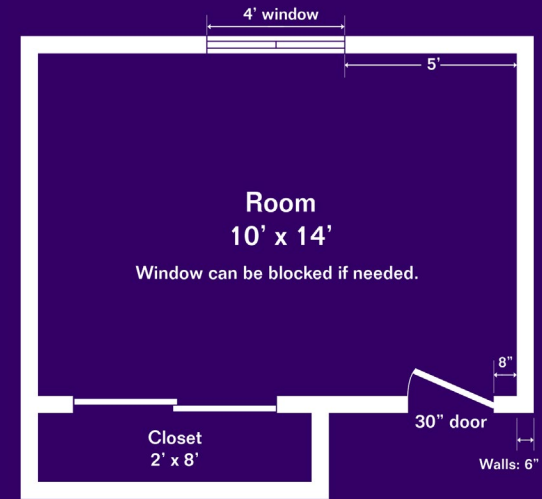

CONTEST RULES

- Modules can be any size or shape but must fit through the room door (7'-6" tall and 30" wide) without damage or pinching your fingers.
- Scale: From Z to O, using any track gauge combination.
- Module section must connect to a temporary staging yard module at each end. Staging yard must have at least three yard tracks.
- Rough in the outlines of the other layout module sections to be built for the entire room. No track plan required, just an outline of the modules in the room is sufficient. Bonus points awarded for showing a module construction progress plan.
- Modules can follow a standard or not. Custom sections are okay.
- Module support method / height up to you, but please describe.
- Innovative approaches get extra points: please describe and illustrate if possible.
- Include a cost estimate for the module. There is no need to actually build anything, this is a design contest only. Do be as comprehensive as possible in the cost estimate: the hypothetical goal is a completely finished, operational module.
- The best submissions will be published, so extra points are awarded for quality text, illustrations, photos and captions. Winners get a bonus payment rate.

SUBMIT ENTRY (Choose "Contest Entry")

★ LAST ISSUE'S RATINGS

The five top-rated articles in the [August 2016 issue](#) of *Model Railroad Hobbyist* are:

- 4.9 Reverse Running: Limited run model frustration?
- 4.8 Derailments
- 4.7 Yes, it's a model
- 4.6 Up the Creek: Joining dissimilar track
- 4.6 What's Neat: National Train Show, Tsunami 2, and more ...

Issue overall: **5.0**

Please rate the articles! Click the reader comments button on each article and select the star rating you think each article deserves. Thanks! ■

ADVERTISEMENT



AMERICA'S LARGEST OPERATING MODEL RAILROAD SHOW

NEW
2 DAY TICKETS

AVAILABLE JULY 1 THROUGH NOV. 11

Saturday & Sunday
Nov. 12 - 13, 2016

9:00am-
5:00pm

WI State
Fair Park
Milwaukee (West Allis), WI

Ticket discounts and show details at **Trainfest.com**

EXPANDED TRAINFEST CLINICS

FREE

Join us for **2 full days of clinics** presented by expert modelers and model railroading manufacturers. Choose from a wide range of modeling topics at any of our **56 total clinics!** Space is limited, register for clinics today at www.Trainfest.com.

60 MODEL RAILROADING MANUFACTURERS

Come to see all **major model railroading manufacturers** at Trainfest and many **cottage industry** businesses offering unique and interesting products for your layout. Don't miss any of the exciting announcements scheduled to be unveiled at Trainfest!

NEW PRODUCT ANNOUNCEMENTS

CELEBRATING THE MILWAUKEE ROAD

In 2016 Trainfest will partner with the Milwaukee Road Historical Association to celebrate the Milwaukee Road. Look for the Milwaukee Road throughout the show and don't miss the museum quality historical photo display, Celebrate-a-Railroad clinic series, and much more!

FREE RIDE THE MLES TRAIN!

70 OPERATING LAYOUTS

Make Trainfest your annual destination to meet with other modelers and find inspiration for your own layout at more than **70 operating model railroads**. Experience the camaraderie of the model railroading hobby and even **operate the trains** on participating layouts!

OPERATE THE TRAINS!

CELEBRATE A RAILROAD



THE MILWAUKEE ROAD

Sponsored by the Wisconsin Southeastern Division, Inc. of the National Model Railroad Association

ADVERTISEMENT

ADVERTISEMENT

TRINITY 3281 SUMMER 2016

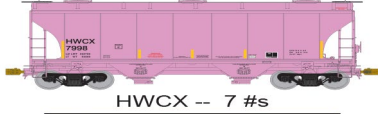
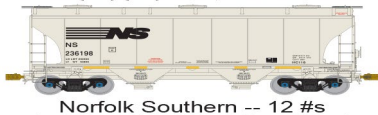

American Limited

www.americanlimitedmodels.com

NICK & NORA DESIGNS

Uniquely inspired craftsman kits



Craftsman Structure Kits,
Detail Parts, Shingles & More!
www.nickandnoradesigns.com

A message from
Joe Fugate

Founder, MRH and TMTV



**What makes
TrainMasters TV
different?**

We think how we approach model railroading video makes us unique. More specifically ...

#1: We don't give you a fish, we teach you to fish

TrainMasters TV works to bring you innovative new levels of understanding in the hobby, not just give you well-worn answers to the same old entry-level topics. **With TMTV, you learn to think and model like an expert.**

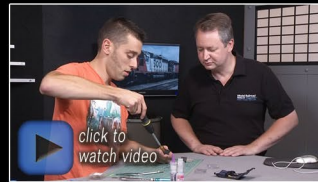

EXAMPLE

#2: We're about the hobby at-large, not just an MRH media marketing tool

TMTV is not the "MRH show" -- rather it's insightful expertise from the movers and shakers all around the hobby. TMTV is about giving you real answers, not marketing hype.



EXAMPLE

#3: It's the HOBBYIST too, not just the models

Besides showing great models in action, we take you inside the hobbyist's head to learn what makes them tick. Adding this extra hobbyist depth makes our videos more entertaining, more fun, and ultimately, more satisfying.



EXAMPLE

#4: Professional, network-quality video production

TMTV goes all-out to produce the best HD video and audio possible. Our Executive Producer, Barry Silverthorn, with a background in network / public television, works to make TMTV be what you'd expect from the pros. You will clearly see the difference -- TMTV is far more than just an ad-free YouTube on steroids.



EXAMPLE

LOOKS GOOD, SIGN ME UP >>



Model Railroad Hobbyist | September 2016 | #79

MRH Q-A-T
column

compiled by
JOE BRUGGER



**Click here for
reader comments**

? QUESTIONS AND ANSWERS

Telltales

Q. I bought four telltales from Tichy Train Group. They came in glossy black plastic so I have to paint them. However, I have unsuccessfully searched the web for relevant images.

—Robert from Sweden

A. Use Google search to look for "railroad telltale photos" and a few examples come up. The color depends on the materials used and the railroad involved. Railroads would paint metal telltale pole and hangers the same colors as signal posts – aluminum, black, sometimes white, and also green. Other companies used wood poles which would appear to be a black-brown when newly creosoted, and would fade to a pale beige or silver as they aged.

Neil (Cadmaster): Go with a wood color for the post and cross arm, assuming that is what the Tichy is made of. For metal parts, probably a rusted silver would fit the bill.

► MRH QUESTIONS, ANSWERS, AND TIPS

thought only one train could legally occupy a track at a time. What's the deal?

—MWB

A. The situation is more formally called “occupying same limits” and accommodates two or more trains, running under the authority of track warrants, that need to be in the same general space at the same time.

If you look at the General Code of Operating Rules, it's covered by Rule 409. You won't find the rule in older rulebooks because track warrants were not in common use before the 1980s.

409. OCCUPYING SAME LIMITS: Not more than one train may be permitted to occupy the same or overlapping limits of a track warrant at the same time except when:

(1) All trains or engines within the limits have been authorized to move in the same direction and required to provide flag protection to the rear as prescribed by Rule 99. The last train may be relieved of providing flag protection when instructed not to foul limits ahead of any preceding train within the limits.

A train required to provide flag protection to the rear must report clear of limits if main track is cleared before reaching second named point unless a flagman is left to prevent a following train from passing; or,

(2) Two or more trains authorized to “WORK BETWEEN” two specific points have been instructed by track warrant to move at restricted speed within the overlapping limits; or,

(3) Trains are moving through the limits of a train authorized to “WORK BETWEEN” two specific points and all trains have been instructed by track warrant to move at restricted speed within the overlapping limits.

3. Two more important points are covered on the following page: Flag protection is not required within the “work between” limits under (3), and, all yard limits provisions set by Rule 93 will apply.

The rule can come into play, for one example, when a local job is working a switching area that includes a stretch of main line, or when two switch jobs are working the same area under the authority of track warrants.

The dispatcher would issue a warrant to a switch job, UP 321 East, including instructions to make all movements within a defined area at restricted speed and could add a specific instruction saying “joint with UP 3300 East.” Restricted speed is a speed that permits stopping a train within one half the range of vision of the train crew.

A through train – UP 3300 East – would receive identical instructions on its track warrant, saying “joint with UP 321 East.” This tells the conductor and engineer of both trains that they will encounter other traffic in a certain area.

Find a copy of the General Code of Operating Rules by using Google to search for “GCOR” or “General Code of Operating Rules.” Individual railroads publish their own versions which can be found online or at swap meets. fogchart.com has study guides for GCOR and other contemporary railroad rules.

Many northeastern railroads use the Northeast Operating Rules Advisory Committee (NORAC) rulebook. Find more information at en.wikipedia.org/wiki/Northeast_Operating_Rules_Advisory_Committee.

Train make-up

Q. Some interesting points came up in a helix thread regarding the make-up of a train consist and running reliability. People said heavier cars should be toward the front of the train, and to avoid long-short-long car arrangements within a train. What other tips might be helpful when putting

together a train consist? Heavier cars toward the front? Keep cars of similar length together? Any other considerations?

—Randy Seiler

A. Dave Husman: If you are running set consists of trains I could see where this could be used, but if you are running mixed freights I don't see where it's going to be very useful other than possibly a long-short combination. A better bet is to make the fleet more reliable with consistent weighting, free rolling trucks, properly adjusted couplers, etc. That way every consist will have a good tracking.

Prototype trains do have certain placement restrictions. Can't have a continuous block of 20 loads behind a continuous block of 20 empties, can't couple a car over 89 feet long to a car less than 39 feet long. If you have DPs (distributed power) or mid-train units the tonnage has to be distributed properly, can't have a long empty car in first 10 cars, etc. But they still have loads and empties, and heavy and light cars mixed. The placement restrictions don't necessarily scale well. Train placement restrictions in a train that is 110 cars long have a different scope than train placement restrictions in train that is 10-20 cars long. Plus, in the model world, actual equipment weight has nothing to do with "waybill" weight.

Joe Atkinson: I agree with Dave. I've never cared for anything that forced my operators to think "model thoughts," that is, thinking differently than their prototype counterparts. If there are equipment or track issues, I think everyone will be happier if you resolve those rather than introduce guidelines that destroy the illusion we're trying to create for our guests. I understand prototype trains do have certain placement restrictions but to me, there's a world of difference between desiring to replicate those restrictions and blocking your train in descending order by car weight.

Rob Spangler: One thing to keep in mind is allowing trucks a reasonably full range of movement. The "three-point suspension" idea (tightening one screw to allow the truck to turn only, while the other is freer to rock), can get you into trouble with random

train consists as will happen during op sessions. I've found that derailments can be greatly decreased by allowing both trucks to turn and rock in all directions. Cars that are relatively light and/or long benefit from the ability to lean a bit on the trucks. If one truck is so tight it can't rock sideways on the bolster, it's far more likely to cause a derailment in some place like a helix where it has to handle a lot of curvature. One screw can still be tighter than the other to keep the car from slopping around.

Work on the bolsters, if necessary, to eliminate obstacles to trucks rocking. Some cars, like Accurail's 89-foot pig flats and the old Front Range ACF covered hoppers, have problematic bolsters that interfere with truck movement. In some cases, the easiest solution in HO is to go with Kadee trucks with the "self-centering" bolsters, which transfer all responsibility for truck motion onto the truck bolster assembly, and require only a flat mounting surface. I've cured a few problem cars by filing the body bolster smooth and adding these Kadee trucks.

Don Mitchell: The La Mesa Club has reliably run long trains of mixed equipment up and down a 2.25% ruling grade for several decades. Success has been achieved by adherence to standards developed and adhered to in that period.

There are short and long videos describing the standards on YouTube. Search for "LMMRRC Car Dep't." or "La Mesa standards."

MRH: Add your own thoughts and questions to the discussion on train make-up and reliability at mrhmag.com/node/24630.



GET PAID FOR YOUR TIP

We pay \$25 per tip we publish, or \$40 each if the tip also includes a photo or finished drawing. [Click here and select article type TIP.](#) ■

 TIPS

Soft weights

[Click here for reader comments](#)

Structure modelers are always in need of weights, and sometimes our configurations get pretty interesting.

Visit your local scuba dive shop and pick up a few of these soft weights. Being soft-sided, they conform to any configuration you need.

The weights are available in sizes from one to five pounds, from a variety of makers.

— David Kruiswyk

MRH: If one pound is too much weight, the idea can easily be adapted for smaller projects.



4. Weights made for scuba divers are soft and can adapt to odd shapes like peaked roofs on model structures. Here a couple weight the roof on CK's Workshop's Tarr and Wonson Marine Paint while the glue dries. *David Kruiswyk photo*

ONE MORE YEAR.



Fast Tracks invests in compassionate care

The Princess Margaret Hospital is one of the world's top cancer research hospitals. The hospital's research excellence is complimented by the Psychosocial Oncology Clinic, which provides therapies to help families cope with a cancer diagnosis.

On August 30, 2014, a dear friend of Fast Tracks, Lionel Strang, received a Stage 4 diagnosis, and was informed he would likely not survive another year. In 2015, Lionel hosted a barbeque to celebrate a year of survival, and collected donations for the Psychosocial Oncology Clinic. He repeated the effort in 2016, and has vowed to continue celebrating his survival for as long as he's able.

In honour of Lionel's efforts, Fast Tracks will donate a portion of its sales for the month of September to Princess Margaret Hospital's Psychosocial Oncology Clinic. Lionel, we admire your courage, and thank you for your friendship.

FAST TRACKS

HANDLAIDTRACK.COM

1-888-252-3895

service@fast-tracks.net

shop online 24/7



From first train set to railroad empire...

*Our complete line of DCC products
grows with you. Discover the fun!*

- Designed and manufactured in the U.S.A.
- Preferred for ease of use and ergonomic design
- Unlimited scalability for any size model railroad
- Plug-and-play means more time running trains
- Great customer service and excellent support



Visit our new and improved web site for all your DCC needs!

- Get the latest new product announcements
- Watch our detailed how-to videos
- Browse the all-new Information Station
- Enjoy secure online sales, day or night!



See your dealer

Visit ncedcc.com



Get Better Sound from your Locomotives

Can't get a good sound from your sound decoder?
Give our speakers a test drive with your ears.



RAILMASTER HOBBIES
9812 BELMONT
BELLFLOWER, CA 90706

Bass Reflex
Speakers



High Bass
Speakers



When it comes to speakers we have high quality speakers to fit many different applications. We are also a full line hobby shop. Need anything? We are an authorized dealer for Soundtraxx, Digitrax, Athearn, Walthers and many others. We provide quality speakers for your DCC sound systems and quality service.

**Click here for
the answer ...**

Model Railroad Hobbyist | September 2016 | #79

DCC IMPULSES

column



BRUCE PETRARCA MMR



**Click here for
reader comments**

TRAVELING WITH DCC

AS I WAS WRITING THIS, IT WAS SUMMERTIME in the USA, time to move about the country. Perhaps a long weekend away. Possibly going to a second home for an extended period of time.

Now that it's headed toward fall, for some folks' travel involves just heading from home to the club. But it is becoming spring for folks in the Southern Hemisphere. And they may be traveling soon.

Either way, how about a DCC system the size of a cigarette pack? I recently got my hands on a SPROG 3. All I can say is, "Wow." I can see a myriad of uses for this neat little box.

On a recent email thread, a user asked what SPROG stood for, since he didn't do well with acronyms. Well, it isn't an acronym, that is the name of the company and they spell it in all caps.

Also, this month, *Mr. DCC's Workbench* is taking a quick look at the new Digitrax DCS240 system box.

Introduction to SPROG

SPROG DCC (sprog-dcc.co.uk) is a company out of the UK that has been selling DCC products for about a decade. The BBM

► DCC TIPS, TRICKS, AND TECHNIQUES

DCC IMPULSES | 2

Group (bbmgroup.com) distributes SPROG DCC's products in North America. They are available from retailers, both online and brick-and-mortar, throughout the world.

Two SPROGs are currently available. The SPROG II V3 (\$105) is a decoder programming track driver and one-amp DCC system in a small box. The SPROG 3 (\$130) is the same size, but has a 2 ½-amp DCC system. Since I have garden locos, I chose the higher current capacity SPROG 3. Given the small price difference, I recommend the SPROG 3 for almost anyone. There are other products in the SPROG line, but these two are the basic ones.

The SPROG [1] has a USB B connector on one end and a power/track connector on the other. Two LEDs on top tell status.

Let's establish what the SPROG is not:

- It is not a computer interface to any other DCC system.
- It is not a sound loader. (See my August 2016 column mrhpub.com/2016-08-aug/online for those.)

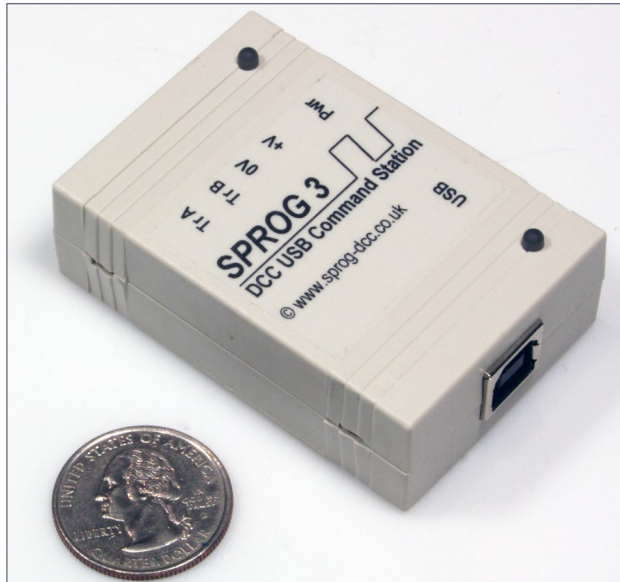

1. SPROG 3 box next to a US quarter for size comparison.

DCC IMPULSES | 3

So, what is it? It is a complete DCC system in a small box. It uses JMRI's DecoderPro (jmri.org) for control. Since JMRI uses run-time Java as a platform it will operate with Windows, Mac or Linux based computers. The major requirement is a USB port. Alas, most tablets do not have a USB port, so they won't work, even if they have run-time Java.

There are two ways to run trains with the SPROG products:

- DecoderPro's built in computer throttles
- With your smart phone using Engine Driver (Android) or WiThrottle (Apple)

The current SPROGs will read and write NMRA compliant decoders. That means that you don't need a programming track booster (PTB).

ADVERTISEMENT

An advertisement for RailPro and RE RING Engineering products. The background is blue with a train on tracks. On the left, it says "NEW TECHNOLOGY" and "DIRECT RADIO". In the center is a handheld controller with a screen showing "Control Locomotive" and "17.6%". On the right, it says "NEW Starter Kit \$399.99 MSRP" and "NEW Locomotive Module LM-2 & LM-2S". A button at the bottom says "Click Here to Learn More". At the bottom, it says "For more information visit our Internet site: www.RingEngineering.com".

RailPro™
RE RING™
ENGINEERING

NEW TECHNOLOGY

DIRECT™
RADIO

NEW Starter Kit
\$399.99 MSRP

- Includes Wireless Color Touch Screen Handheld Controller and 56 Watt Power Supply
- Expandable to Virtually any Size Layout

NEW Locomotive Module
LM-2 & LM-2S

- Direct Radio RF
- Sound and Non-Sound
- New Tiny Size
- 6 Light Outputs

Click Here to Learn More

For more information visit our Internet site: www.RingEngineering.com

Setting up the SPROG

The SPROG 3 comes in a bag [2] with everything you need except a computer. A CD with the software you need is included, with JMRI and a detailed setup manual. Rumor has it that future shipments will have the software on a flash drive instead of a CD. You can view the manual on the web at any time (sprog.us.com/install). The Windows USB drivers are not signed but the work-around instructions for Windows 8 and later are included.

I set mine up on my (2009 vintage) MacBook Pro with OS X 10.11.5 (El Capitan).



Since I had a 4.1 version of JMRI on my machine and the CD included 4.2.1, I opted to install the new version. I already had Java 8 (aka 1.8) installed. Various versions of Java and, therefore JMRI, are available for older versions of OS X. See the SPROG instructions for the details.

2. SPROG 3 in the bag. *BBM Group photo*

Later, I downloaded and installed the latest production version of JMRI (4.4.0) over top of the 4.2.1 without any issues.

The next step was to connect the SPROG to my USB port and install drivers. Oh, wait. The current SPROG products (Iiv3 and 3) use generic USB drivers, so all I had to do was plug in. No fiddling around with driver installation.

The SPROG instructions cover how to set up a JMRI profile. I created a new one, called SPROG. This way I can flip between the existing NCE USB and the new SPROG with impunity.

Next, I connected an ESU decoder tester [3] with an ESU LokSound Micro decoder. In a few minutes I was running the decoder with the DecoderPro throttle. I then asked DecoderPro

ADVERTISEMENT

Make LocoNet wiring extremely simple!



Suitcases belong in your baggage cars, not under you layout!

Introducing the DCC Vampire II ... this guy does the job of two suitcase connectors! And really holds the connection good too!



CLICK NOW TO DISCOVER THE AMAZING VALUE!

Dealer Inquiries Accepted

DCC IMPULSES | 6

to read all the sheets for the LokSound decoder. This took a long time (about ½ hour – I didn't sit and watch and time it). This went perfectly well.

On the road

All the equipment (SPROG, power supply and cables) fits inside of the zipper bag it came in (about two-quart size). With that, plus my MacBook, I can configure any DCC loco anywhere there is AC power. A rechargeable battery could run the SPROG for a totally “off grid” solution. Four lithium cells would work nicely.

Rosters

I have found that keeping my DecoderPro rosters in Dropbox simplifies things. I have one folder for my personal files [4] and another for the club (pcmrc.org) files. My MacBook JMRI points

DCC IMPULSES | 7

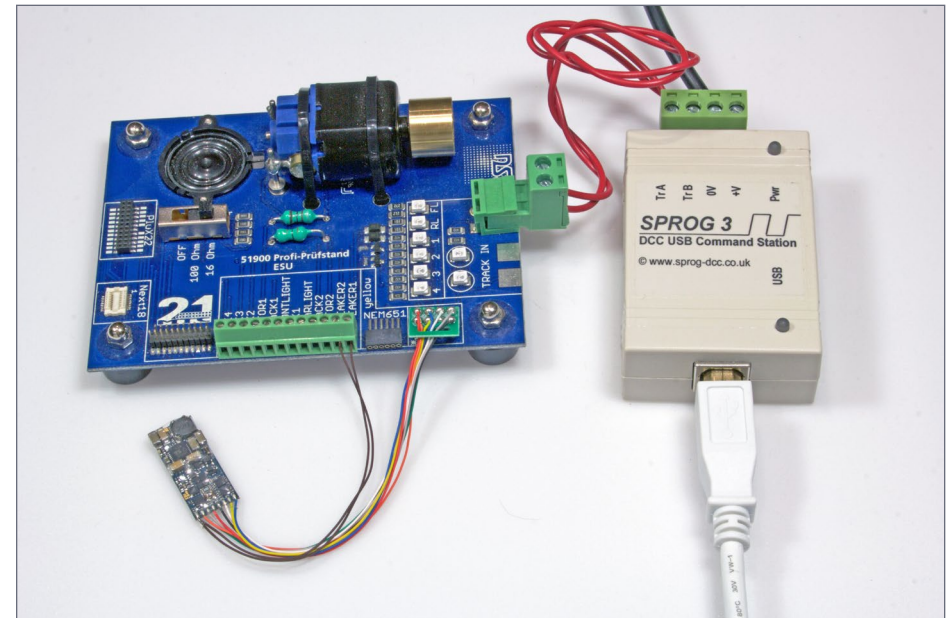

3. SPROG 3 connected to an ESU decoder tester and a LokSound Micro decoder.

to the appropriate subfolders in my folder. The club computer's points to their folder. If I want to work on a club loco at home, I copy the file from one roster folder to the other. When I'm done, I copy it back.

I am sure that other cloud services will work well with this scheme. The club has been using Dropbox amongst the club officers for many years. After I put the club's files in their folder, I moved my personal files in my personal Dropbox folder [4].

Running a layout

The SPROG 3 has enough power to run a small layout and they offer a similarly sized booster for expansion.

I feel that the highest and best use for the SPROG is on the workbench: customizing and verifying locomotives. No need to

ADVERTISEMENT

Fun Features for a Fraction of the Cost!

As the most versatile, feature-packed sound decoder, Econami redefines *value*. Starting at \$79.95 and available now!



SOUNDTRAXX®



DCC IMPULSES | 8

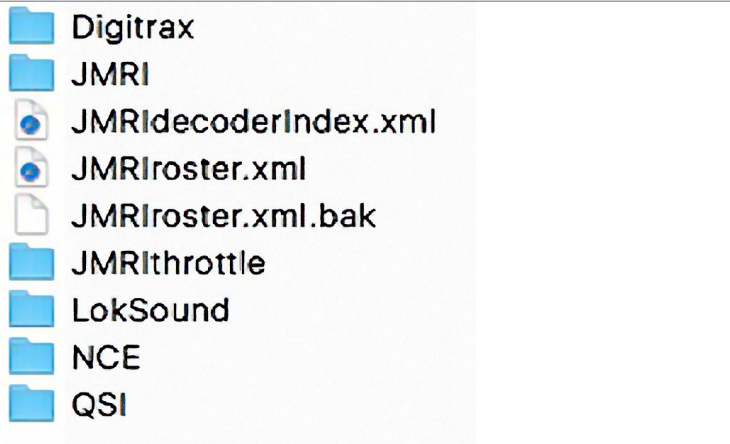

4. My Dropbox folder with sub folders for Digitrax, JMRI, LokSound, NCE and QSI. I store rosters, sound projects, drivers and PDF manuals.

duplicate an extensive DCC system. I have been using a PowerCab in this format for years. The SPROG 3 does the same function with more power. The only difference is that the SPROG uses the JMRI throttles instead of a standard knob or button throttle.

Please share your experiences, comments and ideas. Just click on the Reader Feedback icon at the beginning or the end of the column.

While you are there, I encourage you to rate the column. "Awesome" is always appreciated. Thanks.

DCC IMPULSES | 9

'Til next month, I wish you green boards in all your endeavors.

Coming up next is *Mr. DCC's Workshop* with a first look at the Digitrax DCS240.



ADVERTISEMENT

WAY TO GO, TRAINTEK!

Already great prices and NOW ...

FREE SHIPPING ON ORDERS OF \$79 or more*



Start saving now

*some exclusions apply

ADVERTISEMENT

LC2xx series DCC decoder for HO scale

CONFORMS TO NMRA STANDARDS

LEADER

DCC

ANE mode

High Performance
 High Compatibility
 Multi-lighting function output

- Conforms with NMRA specifications and is certified by the NMRA DCC
- DCC standard decoder is suitable size for HO scale locomotives
- Offers 4 to 6 100mA function outputs with short circuit protect
- Includes Back-EMF with client motor control
- Operates on a 28 step adjustable speed table
- Supports long address and bit mode program

ADVERTISEMENT

IOWA SCALED ENGINEERING

Enhance Prototype Realism
 Electronics for "Your" Model Railroad

- Switch Machines
- Time Lock Controllers
- Fast Clocks
- Sound Players
- Infrared Detectors
- Block Detectors
- And more!

open source hardware

LEARN MORE >

ADVERTISEMENT

Tam Valley Depot.com
 Great Electronics for Great Model Railroads

Home of the Frog Juicer

We are loading up the boxcars with Frog Juicers ready for your layout!

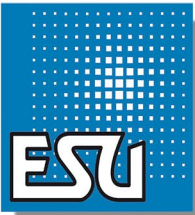

Tired of tearing apart valuable locomotives every time a new decoder is released?

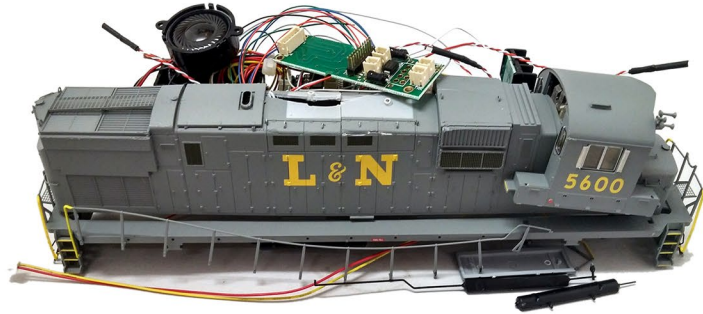

ESU decoders are re-programmable!

ESU LLC

23 Howard Street, Montoursville Pennsylvania 17754
 Phone +1 570-980-1980, Fax +1 866-591-6440
 (Office hours: Monday through Friday, 8AM to 4PM (EST))
 WWW.LOKSOUND.COM

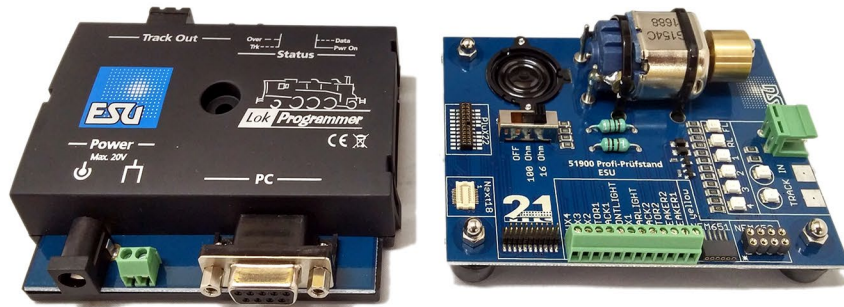

(June 1st - August 31st)

#53452 LokProgrammer - **SUMMER SALE** \$150 list!

#51900 - Decoder Tester - \$57.90 list

BUY IT ONCE & UPDATE IT FOR LIFE!

DCC IMPULSES | 10

MR. DCC's WORKSHOP

A first look at the DCS240 from Digitrax

As I was finishing this column, Jack from Litchfield Station (litchfield-station.com) called and asked if I'd like to check out the new DCS240 command station and booster that Digitrax announced in June. I only had a couple of days before I left for about a month of railfanning, but I still jumped at the chance. I brought home a DCS240 and the PS514 power supply that it was designed to mate with.

I fired it up and here are my first impressions. Currently it seems that this box is only available as a stand-alone. Digitrax hadn't announced a new set with the DCS240 as the system box.



5. Digitrax DCS240 System Box (command station and booster).

TONY'S TRAIN XCHANGE

Committed to your DCC support!

Broadway Limited C&O L-1 Hudsons



Extremely
Limited Quantities.
Pre-Orders Sold Out at BLI.

Brass Hybrid C&O L-1
Streamlined Hudsons with
Paragon 3 Sound & DCC

\$599.95

Order Yours

New SoundTraxx Tsunami2 Decoders



TSU-21PNEM
21 Pin

TSU-24400
4 Amp (Large Scale)

The Excellent Tsunami2 Sound,
Motor Control and Features You
Expect in Two New Formats

Starting at \$87.96

Order Yours

Hare™ Stationary Decoders for Tortoises™

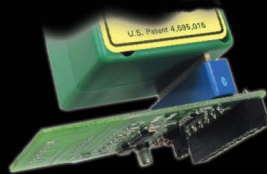

Patented Auto-Throw™
DCC & Manual Control,
Makes Wiring Easy! PnP!

Starting at \$27.45

Order Yours

**Do you need a Sound or
DCC Installation done?**

Get a quote!



Providing unmatched person to person
DCC support for more than 25 years, the
kind of service that has made us #1 in DCC.

DCC questions? CALL US! 1-800-978-3472

We'll get you on the right track!

Sep 2016



DCC IMPULSES | 11

The DCS240 lists for \$375, which is \$70 more than the older DCS200 8 amp system. The DCS240 includes PR3Xtra functionality. The PR3Xtra lists for \$86, making the DCS240 a few dollars less expensive than the DCS200 plus a PR3Xtra.

The box [5] should be familiar to Digitrax users. It is the same size, shape and color that has been the Digitrax trademark since 1993. The front panel has been redesigned a bit to accommodate new features.

I read the manual (digitrax.com/static/apps/products/command-stations-boosters/dcs240/documents/DCS240_manual_r1.pdf). Not cover to cover, but I skimmed and read several sections. It is obvious that someone with some technical writing skills was involved. It is much better than any prior DCS manual I've seen.

The 5 amp vs. 8 amp personality was difficult to understand based on the public announcement. What I realized after a bit of time with the manual is that the DCS240 is designed to receive power from the PS514, via a coaxial jack on the front panel that is rated at 5 amps. To use wires to connect to the DCS240, or if you want to run up to 8 amps, there are wire connections on the familiar gray plug.

The gray plug on the DCS240 is pin-for-pin compatible with other DCS units, so the DCS240 may be able to be plugged in where a DCS100 or DCS200 had been. The direct swap will only work if the current power supply is DC. The DCS240 will only work with a DC power input. The vast majority of Digitrax installations have used transformers, not power supplies. Transformers supply AC and cannot plug directly into the DCS240.

Digitrax has buried the power supply information on page 23 of the manual. Once you get past the 5 amp vs. 8 amp connection



Southern Digital



**20% Discount
on most items!**

Specializing in DCC Since 1992



DCC Conversions, Service & Support

Orders Received by 3:00 pm EST ship the same day

WWW.SODIGI.COM

E-mail: sales@sodigi.com

(770) 929-1888

(Photo's are from our N-Scale layout)

DCC IMPULSES | 12

MR. DCC'S WORKSHOP CONTINUED...

issue, there is the selection of voltage. Track voltage cannot be more than the power supply DC voltage. The closer the power supply voltage is to the desired track voltage, the better. One to three volts above the desired track voltage is just fine. It would have been nice if the Quick Start section had said:

“Unless you have adjusted track voltage from the default settings, set the PS514 voltage:

DCS240 scale switch to N, set the PS514 to the 13.8 volt position

DCS240 scale switch to HO, set the PS514 to the 16.8 volt position.”

It took a bunch of flipping through the manual for me to sort that out. Track voltage for each switch setting is adjustable over a range shown in the chart on page 25 of the manual. This adjustment uses a complicated procedure shown on page 26 of the manual.

Good news. The factory default settings are such that when you apply power to the DCS240, it comes up with the track power turned on. If you don't change it, it will continue to do so.

There is a new look to the front panel LEDs. Prior units were designed when red and red / green bicolor LEDs were the norm. The DCS240 uses other colors, but not to the best advantage possible. I was disappointed to see that there is no optical isolation between front panel lenses [6]. Thus, one or two LEDs illuminated had ghosting in the unlit LEDs. That makes the difference between an “off” and an “on” condition harder to detect.

This video [6] shows the response of the LEDs in various configurations.

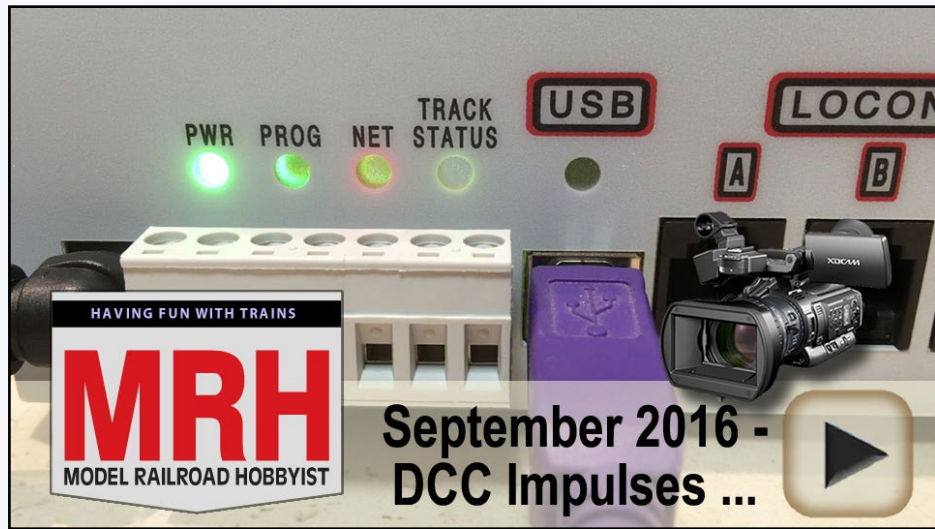

Playback problems? [Click here ...](#)

6. Video of front panel LEDs. Note, the PROG LED is not lit. The green hue is ghosting from the PWR LED.

I have a bit of an issue with the NET light. It is a red LED, as it has been on prior DCS units. This results in a panel of mostly green LEDs, but one red LED in normal operation. To my view, a yellow LED would be easier to understand. Red implies danger or an error to me.

The USB LED lights up blue when there is a computer successfully connected to the DCS240.

The DCS240 allows sound loading and Digitrax device updates in the same manner as the PR3Xtra. This requires a Windows computer with a USB port and uses SoundLoaderII software that is downloadable from the Digitrax site (digitrax.com/sound-depot/soundloader).

Great control in a tiny package



Original Touch Toggles

- Touch Toggle™ plug in controls
- Bright clear indication
- Easy setup
- Flexible system

Stall Motors, Twin-coils, Power, and Servos

Now for Tam Valley Depot and MRservo too!

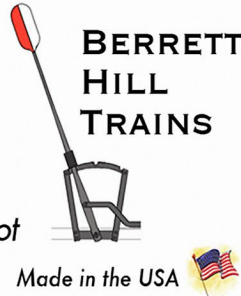

What will they think of next?

www.berretthillshop.com

www.SBS4DCC.com

DCC Specialties **MRC** Model Rectifier Corporation

ACCUTRACK II SPEEDOMETER **SPROG DCC** the DCC Programmer and Control Family **Digital plus** by Lenz

TAM VALLEY DEPOT **TEAM DIGITAL, LLC** Improving the world of DCC

N - HO - HO_{N3} Scale Trains

DCC and Sound in N Scale?

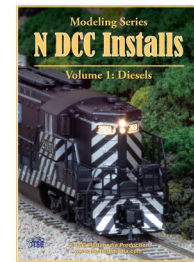

We'll show you how! *N DCC Installs* Examples with and without sound!

CLICK FOR DCC

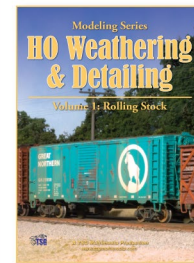

Want it now? Our titles are now available in digital download format!

CLICK FOR DIGITAL

TSG Multimedia

DCC IMPULSES | 14

MR. DCC'S WORKSHOP CONTINUED...

Although the Digitrax documentation ignores non-Windows computers, I was able to connect my MacBook Pro to the DCS240. The drivers embedded in OS X were used. I mostly followed the PR3 instructions (digitrax.com/static/apps/software/download/21/Using_the_PR3_with_OSX.pdf). There were a few wrinkles getting JMRI to talk with the DCS240, using version 4.4.0. I'm sure these will be ironed out in a future release of JMRI.

One feature that I like is the LOCO RESET button. Hidden at the bottom of the front panel, it requires a paper clip or ballpoint pen to activate. It clears out all the loco slots and consists. Prior DCS units needed an OP36 reset or using DecoderPro to clear things out.

The DCS240 supports 400 throttles and locos, provided you are using DT402 throttles that have been updated. The SoundLoader II software can update your DT402 throttles. UT4 and DT400 throttles are limited to the original 120 slots and are given preference for those slots.

Another front panel button is EZ RTS. This is used to make quick route settings. I didn't experiment with this feature. Also, time did not allow me to do a lab-test sort of evaluation. I don't expect much functional difference between the DCS240 and the older DCS200.



[Click here for
reader comments](#)



SOUNDTRAXX™

Digitrax®
Complete Train Control

**CLICK TO
LEARN MORE!**

Custom Installation Available

We carry all your DCC Requirements!

623-298-7355

www.LitchfieldStation.com

Digitrax

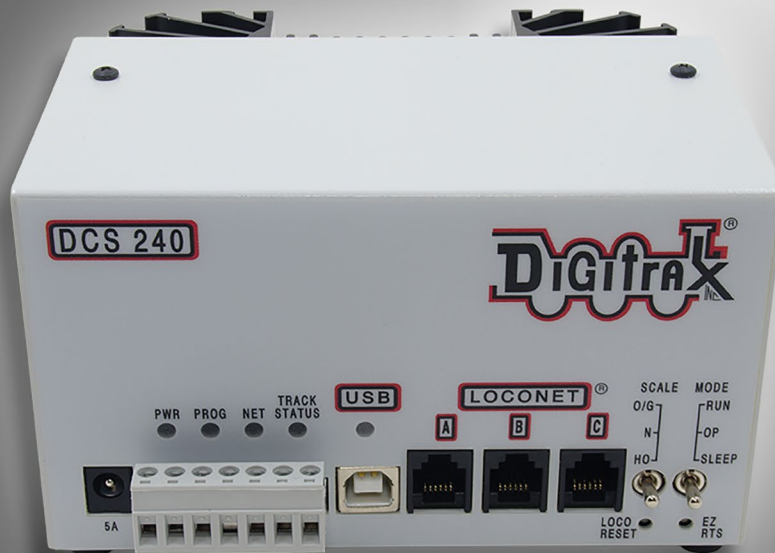

\$375.00 MSRP

Introducing
DCS240
 LocoNet® Advanced
 Command Station



- **400 Loco Addresses**
- **400 Throttle Support**
- **5 or 8 Amps of Power**
- **For Serious Operation!**

Find out more at:

www.digitrax.com

PREORDER
SPECIAL

Debug trackwork *Like an expert.*

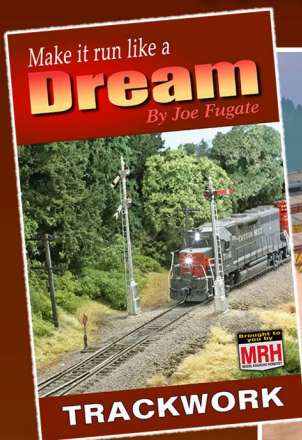
~~\$12.99~~**\$11.49**

eBook

Also coming in
paperback

Click me to
LEARN MORE ...

Make it run like a

Dream

TRACKWORK: *By Joe Fugate*

Book release late September - From the MRH Store: store.mrhmag.com

Other books in this series: *ROLLING STOCK* (Mar 2017) and *LOCOS* (Sep 2017)

Model Railroad Hobbyist | September 2016 | #79

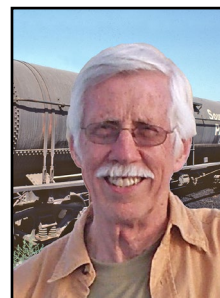

TONY THOMPSON
.....

GETTING REAL

column



Click here for
reader comments

ACCURATE MODELING OF INDIVIDUAL TRUCKS REQUIRES KNOWING THE PROTOTYPE

FOR LOTS OF MODELERS, TRUCKS ARE LIKE couplers. They are essential for operation, and as long as they look more or less okay and operate correctly, no further attention is necessary. But in fact trucks are a complicated and interesting topic, one that deserves a little examination. I will explore briefly both the prototype and model aspects of the subject in this column.

Understanding the design and history of prototype freight car trucks is an entire topic by itself, as Richard Hendrickson masterfully showed in his article in the May 2013 issue of *Model Railroad Hobbyist*, and complementing that article is a parallel work of Richard's, showing the HO scale equivalents of many of the prototype trucks. The latter is available on Google Drive at this link:

► **MODELING REAL RAILROADS AND WHAT THEY DO**

GETTING REAL | 2

docs.google.com/file/d/0Bz_ctrHrDz4wcjJWcENpaDJYbUU/edit?usp=sharing

There are other fine descriptive works out there about freight car trucks, such as Bob Karig's book chapter on the subject (Chapter 6 in *Coal Cars*; see Bibliography), and another article by Richard ("Freight Car Trucks," *Railway Prototype Cyclopaedia*, Vol. 4, 2000, pp. 35–51), which are well worth consulting. All these works can help you identify the types of prototype trucks, and begin to assign correct model trucks to your model cars.

Those descriptive works are an essential beginning, but only a beginning. Even if you have absorbed the information and

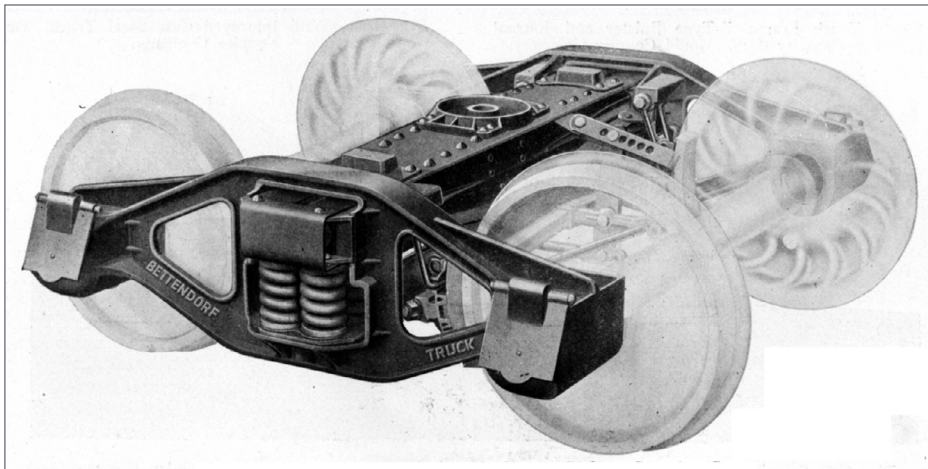

1. This truck view, with the wheelsets (wheel-axle assemblies) faded out, emphasizes the truck side frames and the riveted bolster which connects them. The brake beams are also faded in this view. The bolster rests on the spring package in the side frame, with the underlying spring plank not very visible. This truck is a modernized T-section truck by Bettendorf. Bettendorf Company photo, *Car Builders' Dictionary and Cyclopaedia*, 1919

GETTING REAL | 3

visual spotting features for all the trucks, you then need to find out which trucks were on the freight car you are modeling (or upgrading). And it may not be easy to reliably identify the trucks seen in a prototype photograph, especially if the photo was taken (or has been printed) so that the entire underbody area is a black hole as far as information is concerned.

Of course, it may be that stand-in trucks will be used in the absence of completely accurate model trucks, but in general terms it's a positive goal to have trucks which look as much like your particular prototype as possible.

Having made those general points, I want to turn to some truck details, which may be useful as a guide to modeling an individual

ADVERTISEMENT

GLX SCALE MODELS.COM

3D PRINTED MODEL

1/48 SCALE!!!

OIL LANTERN KIT

\$19.99 + S&H

12 VOLT POWERED LED LIGHT

truck when that is desired, as well as to illuminate some aspects of how trucks are built. Since about 1920, practically all trucks have had one-piece cast-steel side frames connected by a truck bolster and, in older trucks, a spring plank. As modelers, we tend to see only the side frame, and think of the truck in terms of how its side frame looks.

Prototype trucks

Given the several fine articles about trucks cited above, I will just offer a quick description. As shown in [1], the familiar parts of a truck to modelers are the side frames and bolster. Also present for many years was a spring plank, often not evident in prototype photos and rarely modeled, but a clear view of one is shown in [2].

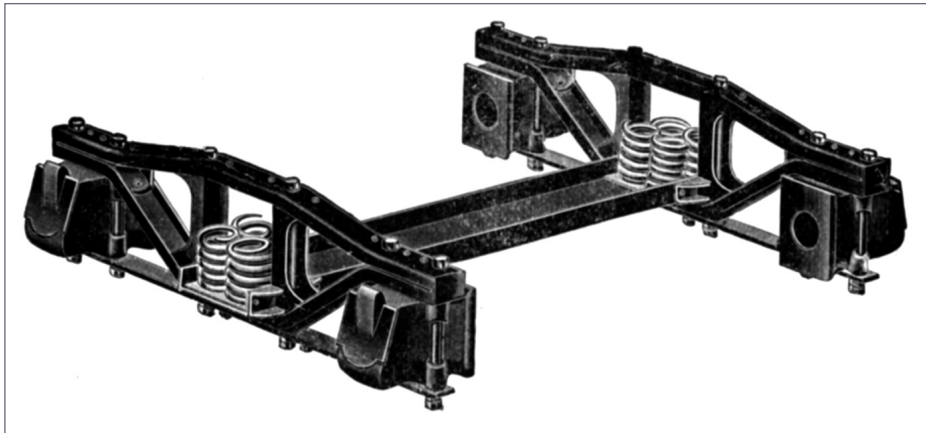

2. The important part not visible in [1] is the spring plank, shown here in a Cloud truck (a kind of arch-bar truck with pressed-steel members). The spring plank not only supported the springs but tied the side frames together and kept the truck square and the axles parallel. Originally spring planks were wooden planks, but by the end of the 19th century had become steel parts. Spring planks began to be superseded after 1937. *Car Builders' Dictionary, 1903*

What do modelers need to learn from this? First, prototype truck bolsters are a rather different shape than most model bolsters (usually that's okay because we don't see them). But if we model a truck in isolation, it may be useful to see how to reproduce the shape(s) of real bolsters. Two examples are shown here [3].

One common feature is a deep center section, as visible in the USRA (United States Railway Administration) bolster in [3]. Another commonly seen prototype bolster was the Simplex bolster, also in [3], a very strong cast-steel part, readily distinguished in photos by the bulky bolster end with its name cast on the surface [4].

Further, prototype trucks are not attached to the car, and only a two-inch kingpin runs between them. If a car body is lifted into

ADVERTISEMENT

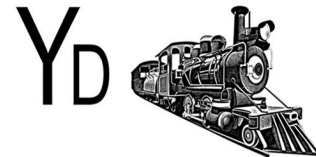

Yankee Dabbler – Track 33

**FREE SHIPPING
ON ORDERS OVER
\$100.00**

**YD Specializes in DCC
Sales-Service-Installation
YD provides the BEST for LESS**



ESU LokSound



CLICK AND SAVE TODAY!



YD installs DCC or RailPro in your engines
 Technical Coordination (727) 457-9227 9AM to 9PM EST
 Locations in NJ and FL / Visit our Web Site for Train Show Schedules

GETTING REAL | 6

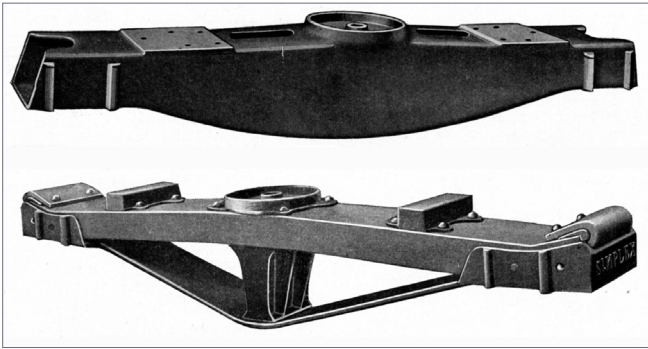

3. Two typical designs of truck bolsters. The upper one is the standard cast-steel bolster used on the USRA 50-ton trucks, and the lower one is the patented Simplex bolster, widely used as a sturdy replacement part. Truck center plates of both are evident, as are supports for side bearings on either side of center. *Upper, American Railway Association; lower, American Steel Foundries*

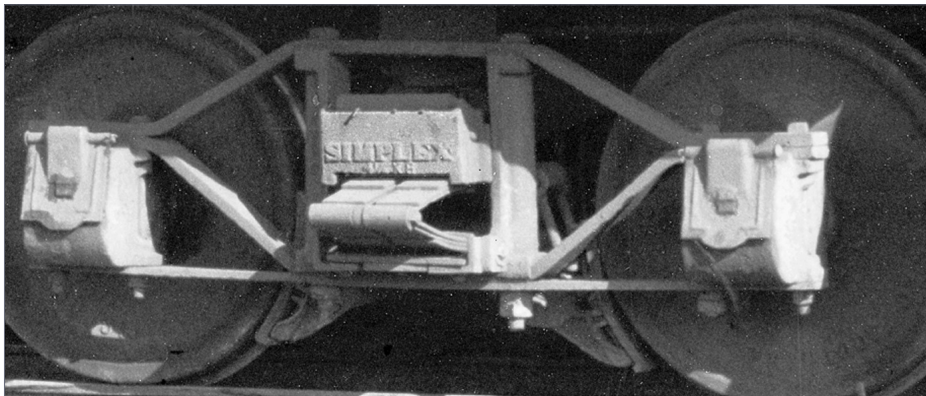

4. The Simplex bolster had its name cast into the bolster end, making it easy to spot in trucks where it was used, often as a replacement. This one was under an SP caboose. *Detail of photo by Wilbur C. Whittaker*

GETTING REAL | 7

the air, the trucks remain behind. A truck kingpin is clearly visible in some photos [5], though usually the kingpin remains in the body bolster. Modelers don't attach trucks this way, so there is no modeling need to think about kingpins, except when showing trucks on their own. I will return to that point. In some of these photos [3,5] the truck center plate is visible. This circular area, with a rim, mated with a corresponding circular part of the car's body bolster, keeping the truck centered. A section drawing is shown [6]. The center hole is only as large as the diameter of a kingpin. Though models do not have anything much like a center plate on either trucks or body bolsters, we might wish to represent them if those parts are separately modeled.

ADVERTISEMENT



Announces their purchase of
BEST's
Laser-cut Structure Kits

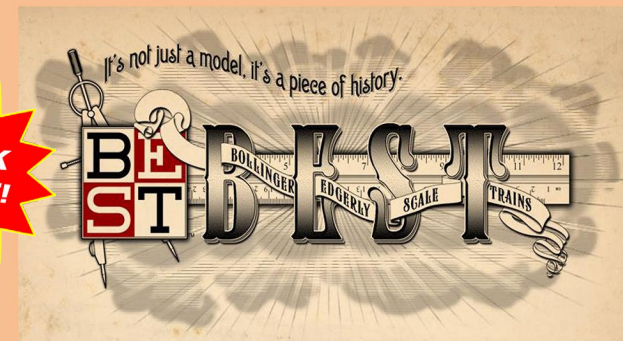

To order or get more information, please email Jeff at:
motrakmodels@centurylink.net

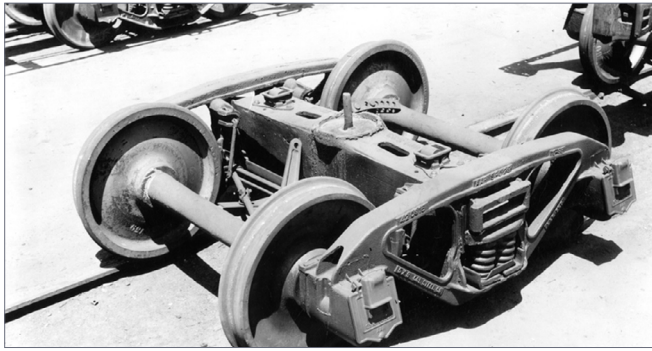

5. This view of an assembled truck shows several features, including the barely visible spring plank, and the kingpin (a 2-inch rod) is in place in the center of the truck bolster center plate. This is a standard ARA side frame, produced by Columbia Steel and used for many of PFE's rebuilding programs. Side bearings, which restrain rocking of the car body, are in place on this truck bolster. *Pacific Fruit Express*

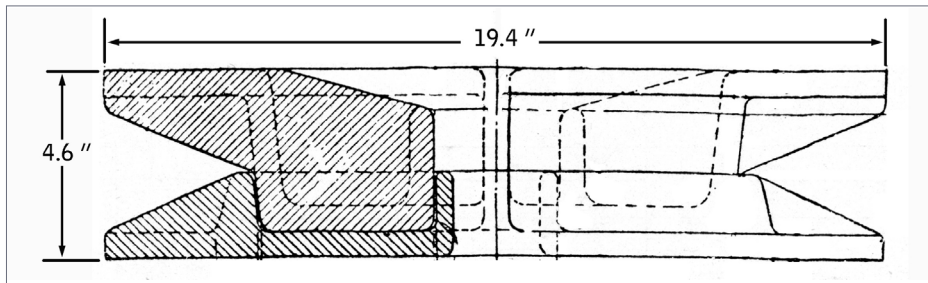

6. The standard Master Car Builders' center plate design for 50-ton cars. Overall dimensions are shown. The mating parts at the center are 1.5 inches deep. The upper part is the body bolster center plate, the lower part is the truck bolster center plate. They mate snugly for truck centering. *Car Builders' Dictionary and Cyclopedia, 1919*

A few words may be appropriate also on the journal box in these trucks. (The journal is the axle end, on which the bearings rest, and this arrangement is called a "journal bearing." That's why both solid and roller bearings are correctly termed journal bearings, because they both ride on the axle journal.) The solid bearings were contained and lubricated in these boxes. At their back, they had a (usually wood) "dust guard" to close the box; these are visible in [2]. Inside the journal box, there was some kind of material for transferring the journal oil onto the journal itself, often cotton waste. The waste, and other journal box parts, are shown in [7].

The bearing itself, shown as part (c) in [7], was usually a cast bronze part, with bearing metal such as Babbitt molded into it to form a working surface of the bearing.

ADVERTISEMENT

MT. ALBERT SCALE MODELS
SCALE LUMBER CO.

**COMING SOON
IN HO SCALE!**

We plan to produce an HO Scale version of our very popular Mt. Albert Lumber Yard kit later this year. Please watch our website and Facebook page for more details.

ADVERTISEMENT

**WOW!
What scale is this?**

Click for the answer ...

MISSOURI LOCOMOTIVE COMPANY

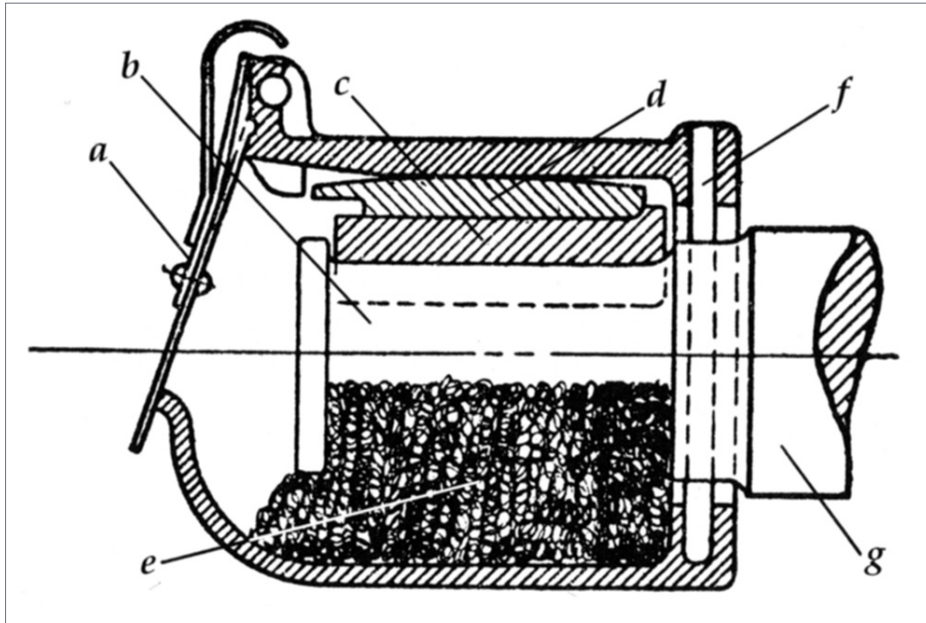

7. This cross-section drawing shows the interior of a journal box with solid bearings. The parts shown are: (a) journal box lid; (b) journal, part of axle; (c) journal bearing; (d) wedge or key to retain bearing; (e) waste or packing; (f) dust guard; (g) axle. *AAR Manual*

Once the bolster and side frames were assembled, springs were placed in the center opening of the side frame, resting on the spring plank if there was one [2]. Trucks were produced with spring planks for many years, and as modelers all we usually see is the end of the plank, underneath the springs. That is the case in the photo here [8], which is an ARA truck of standard dimensions.

Spring planks had the disadvantage that on a curve, they resulted in twisting stress on the truck, as the wheels on the inner and outer rails of the curve traveled different distances. A solution was devised by the nine principal truck manufacturers, who

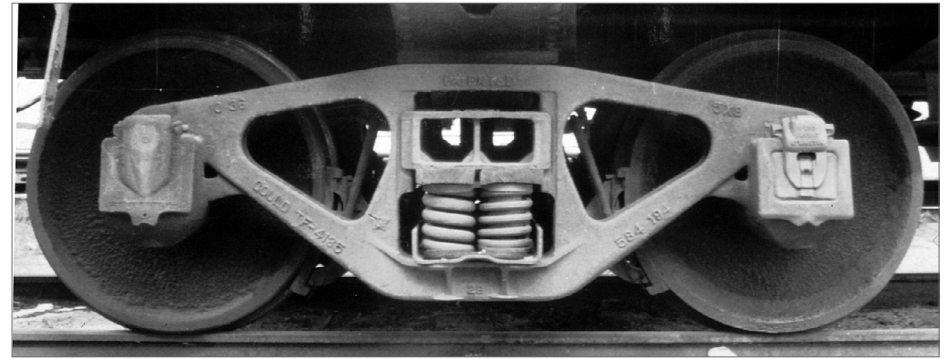

8. This ARA standard truck, manufactured by Gould, is for a 50-ton car. The spring plank, in the form of a steel channel below the springs, and the spring caps on the spring package, can be seen here. Note that the bolster is hollow, with light visible through it. *Richard Hendrickson*

had agreed to work together under a Four Wheel Railway Truck Agreement. In 1937 they announced a new truck design, which was termed a Self-Aligning, Spring-Plankless, Double-Truss Truck.

The double-truss part of the name referred to side frame design (see Hendrickson MRH article). The elimination of the spring plank was made possible by modification of the bolster to rotate slightly around the kingpin, relative to the side frames. That was called self-alignment. It substantially reduced the twisting stresses of a truck with spring planks, along with saving about 400 pounds of weight. A truck of this type is shown in an overhead view [9].

When trucks of this type were disassembled, they were much like earlier trucks, just without the spring plank. A truck with its springs removed is shown in [10]. It's worth a brief description of these springs and their arrangement. Depending on the truck capacity and spring travel, there might be four, five, six, or more

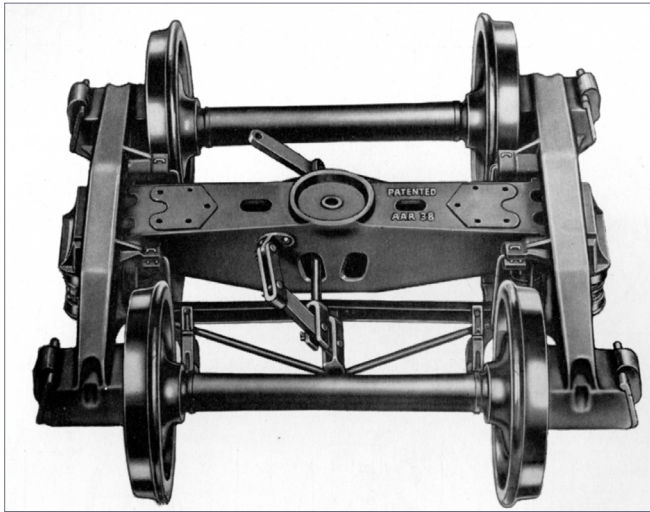

9. This top view of a spring-plankless, self-aligning, double-truss truck shows its features clearly. Note also the width of wheel treads. *Richard Hendrickson collection*

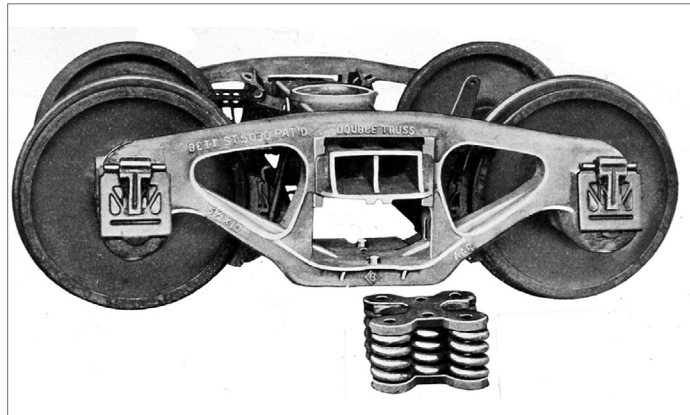

10. This interesting photo shows a truck with its spring group or spring package removed from the side frame. The springs are enclosed by "spring cap" plates, top and bottom, which were bolted together to make a one-piece package. *Bettendorf Company*

visible springs (there are five in [10]), and these were assembled with spring caps into a spring group or spring package. Though the truck in [10] is spring-plankless, the same spring group arrangement would be used in a truck with a spring plank.

Moreover, each spring might contain a second spring inside the outer spring [11], though it was not always necessary for all springs to be paired. The two springs in a pair would have different spring rates, and had higher capacity. Resources like the *Car Builders' Cyclopedia* volumes contain many examples of varying spring packages for trucks of different capacity and different spring travel.

In the foregoing, I have only written about coil or helical springs. But efforts to dampen spring motion and provide a better ride for freight cars, using several approaches to design of snubbing devices, is a

complex and interesting subject in itself. I have discussed that history in a fairly compact way in my modeling blog, and for those interested, here are links to three discussions of the topic.

modelingthesp.blogspot.com/2016/04/trucks-truck-springs-and-snubbers.html

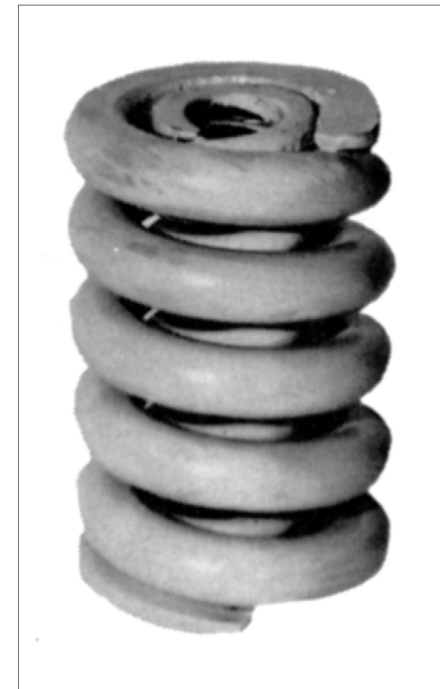

11. Typical pair of truck springs. Note that one of the two springs is right-handed, the other left-handed. *Union Spring and Manufacturing Company*

modelingthesp.blogspot.com/2016/04/truck-springs-and-snubbers-part-2.html

modelingthesp.blogspot.com/2016/05/trucks-and-snubbers-part-3.html

The topic of spring snubbers is also ably summarized in the Hendrickson MRH article of 2013.

Wheels

The major moving parts in a truck are the wheels. Though as modelers, we tend to see them as a simple appliance, in fact they too represent a complex story in some ways. One point to recognize is simply the vast numbers of wheels and axles needed in operating the prototype. The Southern Pacific wheel shop at Sacramento cast individual wheels in the thousands, year after year [12], to feed an immense production and replacement process. For a single illustration, again from the SP, here is a storage area for wheels [13].

Wheels were cast for many years as “double-plate” wheels, in which the plate center was hollow, until the ARA Recommended Practice wheel was redesigned as a “single-plate” wheel, meaning that the material connecting the rim to the hub was a single piece. Double-plate wheels were produced by casting with an internal sand or ceramic plug, which after solidification of the wheel could be broken up and removed. The sure sign of such wheels is the removal holes (often two or three holes) on the internal surface [14].

Cast wheels also might have or not have ribs or brackets cast on the inner surface. There have been a number of erroneous statements made over the years about the purpose of these ribs, but they were certainly not to provide faster casting solidification in the plate (if anything, slower solidification in this area would be beneficial), nor in dissipating heat during heavy braking in service (the plate is not the critical heating area). The reason was



12. Workers in the wheel foundry at Southern Pacific’s Sacramento General Shops pour molten iron from a ladle into wheel molds. The photo is from the 1920s. Considering the dangers of liquid metal splashes, the men have minimal protection. *Southern Pacific photo, John R. Signor collection*

mechanical strengthening of the wheel, and even that was not truly essential. Between 1928 and 1938, the recommended cast wheel had no ribs, though they were restored after 1938.

Wrought wheels can be forged or rolled (the latter are usually rolled after forging the wheel blank). An example of their appearance is shown [15]. Note that wrought wheels, whether forged or rolled, were much stronger and thus always produced without ribs.



13. The wheel storage area outside Building 11 of the General Stores at Sacramento General Shops of the Southern Pacific. Wheels here are mostly new, but some rows of worn-out wheels can also be seen. A line of wheelsets is near the building. *Southern Pacific photo X8351-04, John R. Signor collection*

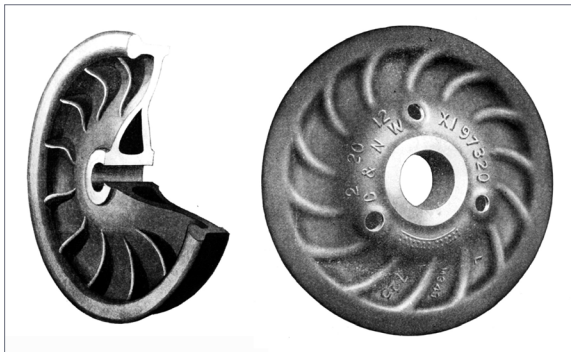

14. A double-plate wheel has a hollow area near the hub, and to remove the casting insert, holes are also part of the casting, and remain present in the final wheel. The ribs were called "arms" or "brackets" in the wheel business. *Association of Chilled Car Wheel Manufacturers*

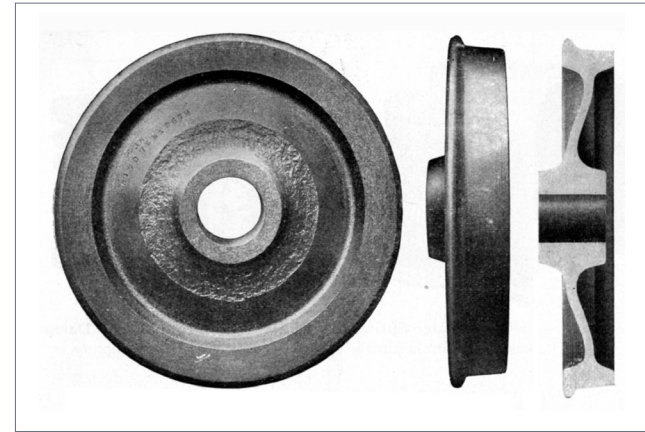

15. A wrought wheel is a single-plate design; the cross-section shows the S-shaped curvature of the plate. The S-shape optimized stress distribution.

Car Builders' Dictionary and Cyclopedia, 1919

The optimum cross-section of the plate was S-shaped, but in more recent years a simple conical plate has been used, at some sacrifice in weight.

Although it was possible to cast wheels with thicker treads, to make it possible to re-profile them to an as-new condition after they were worn (called "double wear" or even "multiple-wear" wheels), most railroads chose not to carry the substantial added weight of those thick treads on their freight cars, and by World War II, had standardized on single-wear wheels. (These were sometimes designated in car lettering as "1-W" wheels, as contrasted to 2-W or M-W wheels.)

These wheels were usually assembled into wheelsets by pressing onto the axle with a large hydraulic press, and then machined, to make sure the journal dimensions were correct, and the wheel treads would also be machined to standard profile if necessary. A wheel lathe in use is shown in [16].

Wheelsets when ready for use were often shipped from central shops to outlying facilities which might need to replace worn

GETTING REAL | 18

wheelsets in trucks. Many railroads developed some kind of wheel car for this purpose. Here is an example, drawn from SP practice, and note how prominent are the projecting journals in this photo [17]. I will say more below about modeling something like this.

There are other kinds of modeling challenges for an accurate looking truck. For example, another place trucks might be seen by themselves is on the truck car in a relief or wreck outfit. These could be used

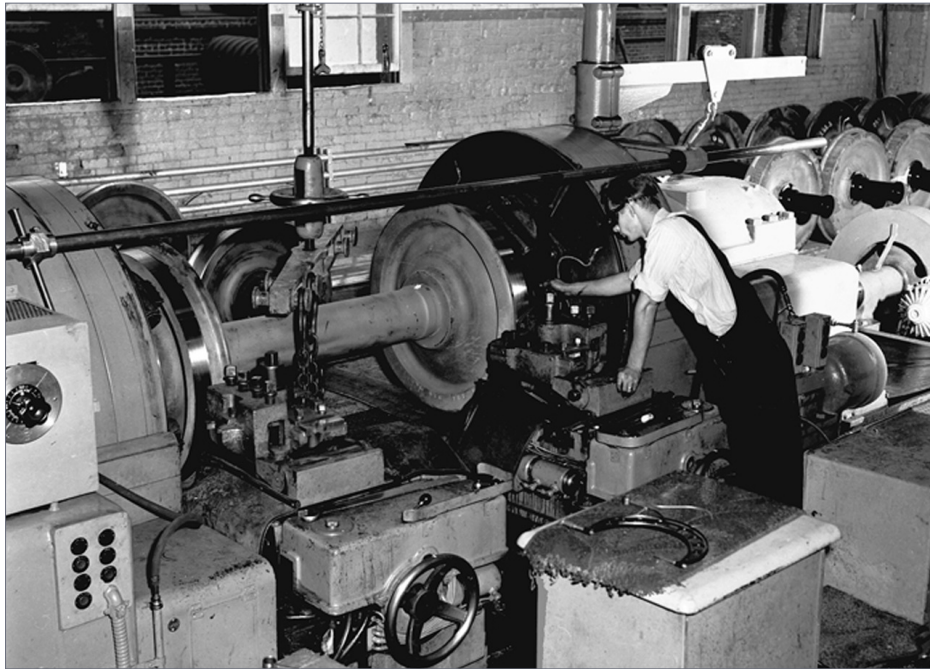

16. A wheel lathe in use at SP's Sacramento General Shops, with a line of wheelsets in the background (with coated journal surfaces). The primary task here would be turning the axle journals to correct diameter, but in this photo, the wheel tread is being machined to correct contour, probably after wear. The thick wheel rim is that of a multiple-wear wheel. *Southern Pacific photo N1924-1, John R. Signor collection*

GETTING REAL | 19

as temporary replacements under wrecked cars, or to move wreck debris. The photo on the SP at San Luis Obispo [18] is an example.

As mentioned above, wheelsets were changed out of trucks when wheel treads or flanges became worn, or if wheels were damaged by chipping or cracking. So how were wheelsets changed? The bolster would be supported with a jack or stand, the spring package removed, and the side frame lifted and swung to one



17. This Southern Pacific wheel car, modified from a Class F-50-3 flat car, has wheelsets staggered in two rows. There are about 20 wheelsets, making a total weight of about 47,000 pounds. The projecting journals are evident. The car, SPMW 2549, was converted to this service in 1943 from revenue car SP 40263. The photo was taken on September 19, 1954 at San Diego. *Chet McCoid photo, Bob's Photo collection*

side. Alternatively, a small jack was used under the journal box. That raised the bearing brass up off the journal. Then the wheelset could be rolled out.

Photos of wheelset changing are not often seen, but there are a few good ones available. One example is the photo here [19], which was taken at Pacific Fruit Express's Los Angeles Shop, on the light repair track, and the foreground wheelset has been removed from the truck just behind it. The replacement wheelset is already installed, and the two men on the far side of the truck are oiling the new journal.



18. Most railroad relief outfits (what modelers often call “wreck trains”) carried a supply of old freight car trucks that could be used under any wrecked car with damaged trucks. This photo shows SPMW 7024, a 120-ton derrick, long assigned to San Luis Obispo, California, with Relief Tender SPMW 7024B, a custom-modified flat car with storage compartments for tools, cables, blocking, and the like, and trucks on top. As in this case, normal SP practice was to letter all parts of the relief outfit with suffix letters on the crane’s number. Photo taken in September 1953. *Malcolm R. Gaddis*

A closer view of a truck being disassembled is in [20], with the side frames pulled away enough to permit the wheelset to be rolled away. Note the dust guards in place on the back of the side frame at the rear of the view, and of course the prominence of the axle journal.

It’s important to realize that all these are heavy parts. A typical freight car wheel in the transition era weighed about 750 pounds, making wheelsets in the vicinity of 2250 pounds. Bolsters might weigh 1000 pounds or more, as might each side frame, to which would be added the weight of spring packages and spring planks, plus brake beams. A complete truck often weighed 12,000 to 14,000



19. The light repair track at the Los Angeles Shop of Pacific Fruit Express in 1950, with a wheelset being changed out in the foreground. Nearest the camera is the replaced wheelset, rolled onto the paved working surface. The tread width, prominent journals, and nearly straight axle are evident on that wheelset. Many of the chalked notations on the cars under repair indicate needed work. Note that tools, carts, parts, etc. are relatively neatly organized. *Richard Steinheimer*

pounds or more. Wheelsets or complete trucks could readily be rolled around by hand, as photos document, but obviously not picked up without a crane.

Modeling

All these specifics on truck details can come into play if we wish to model a truck being worked on, or standing by itself. Many aspects of model trucks do not look much like the prototype, which is not a problem when the truck is under a freight car, but obviously the situation is different if for some reason, we get a good look at the model truck. I describe below some approaches to modeling in that situation.

Most trucks under freight or passenger car models need not be as detailed or accurate as the prototype, as long as they are hidden

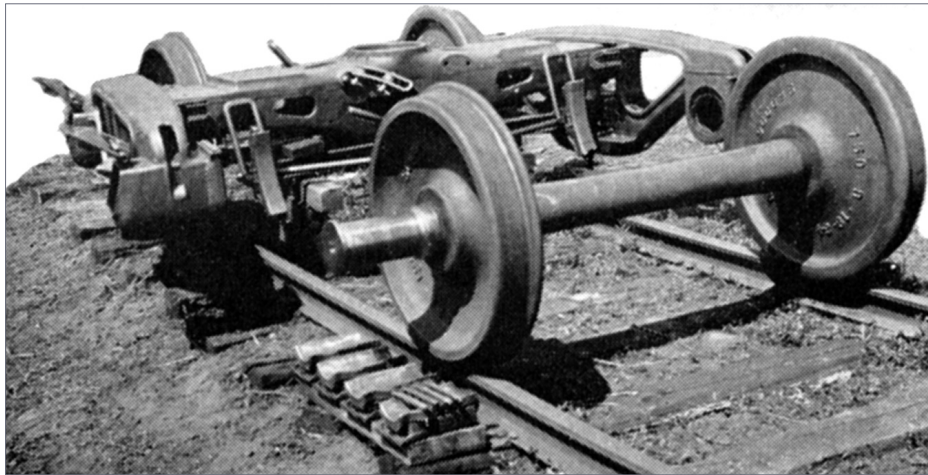

20. This photo of a truck being disassembled clearly shows the two side frames tilted away from the truck, and the foreground wheelset rolled away from the truck. Reassembly of the truck would proceed in the opposite order. This particular truck still has its brake beams in place. *National Malleable and Steel Castings Company*

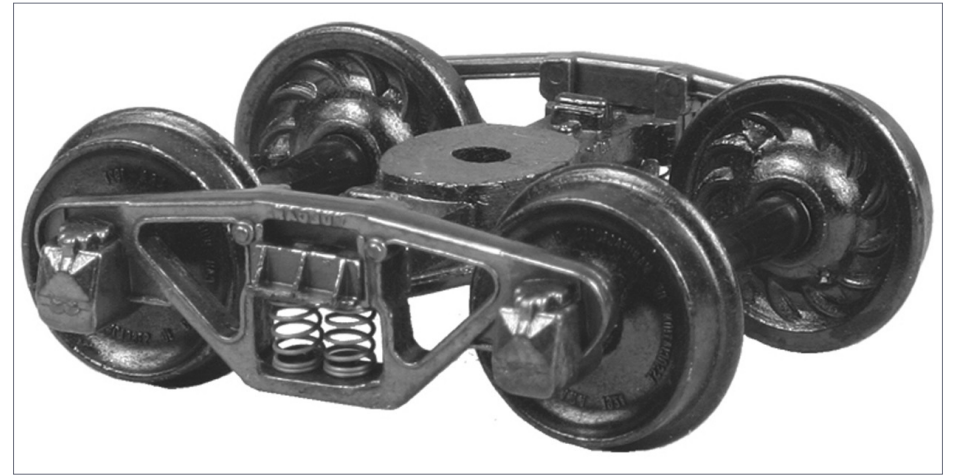

21. An example of a “sprung” model truck. The springs are obviously entirely unlike prototype truck springs (compare the spring group in [10] or the double spring in [11] to see the difference). These unrealistic springs may not be noticeable under a freight car, but stand out when a model truck is seen in isolation. This happens to be one of the old Kadee Vulcan trucks. This is not a criticism of Kadee, which is gradually introducing solid-side frame versions of all their trucks.

under the car body. But a truck being serviced, for example, is another matter, and it is worth seeking out prototype details for accurate appearance.

I can begin with the truck as a whole. Many model trucks look fine from the side, which is how we see them under a car. But when a “sprung” truck is examined [21], it is evident that the springs are quite unrealistic. One certainly could not see through a prototype spring pair, such as that shown in [10,11]. Moreover, testing has shown that such model springs do not actually provide spring action, at least in HO scale, for car weights below about half a pound.

GETTING REAL | 24

Trucks like those shown in [21] can be made to look better by a simple “view block” behind the springs, as shown here [22].

Second, model truck bolsters, though hidden under our cars, are not much like prototype bolsters, either in shape or in their immense (relative to the prototype) center holes for screw attachment. Again, as long as this is invisible to a viewer, it doesn't matter, but for a truck in isolation, it is glaringly evident.

One simple change to a model truck bolster is to file the sides flat, so that the center hole is no longer wider than the bolster. Even this change makes the bolster look less toy-like [23]. But even with this change, few prototype truck bolsters are straight beam shapes like model bolsters. I have added styrene shapes, approximating the USRA bolster shown in [3], to provide a generally realistic



22. An example of placing a thin styrene “view block” behind the spring area of a truck with “real springs.” This Dalman one-level brass truck was exactly correct for this Erie gondola, so Richard Hendrickson modified the truck as you see, to minimize the undesirable “see-through” of the springs.

GETTING REAL | 25



23. Model truck bolsters usually have immense center holes for our model truck screws. The one shown at left has been filed flat so that a dummy side panel can be added. At right are a pair, showing both sides of the bolster.

look. Exact shape probably is not vital here, given that prototype bolsters from different manufacturers varied widely. One example is shown in [24]. Of course to complete such a model bolster, one would need to add a center plate with a small center hole (see for example [8]), which has not yet been done in [24].

The best part of most model trucks is the side frame, and rightly so, since it's the part we mostly see with a freight or passenger car. For modeling of individual trucks and truck parts, the side frames are most easily provided from disassembled “sprung” trucks, as the side frame openings are generally well rendered [25]. These can definitely be used as scenery items around a truck maintenance facility.

Moving beyond bolsters and side frames, the next topic is wheels. There are certainly times when we need to aim at a prototypically correct, narrow wheel tread. That is when we model wheelsets in isolation, as were often found around shops and roundhouses. If separate wheelsets are to be visible, certainly the first requirement would be to avoid the usual model wheelsets with pointed axles

GETTING REAL | 26

[26]. These of course have absolutely no prototype correspondence, as can be seen in many of the photos above [19,20].

The long-standing width of HO scale wheels has been 0.110 inches, which has been termed Code 110. More recently, a “semi-scale” wheel which is only 0.088 inches wide has been introduced, under

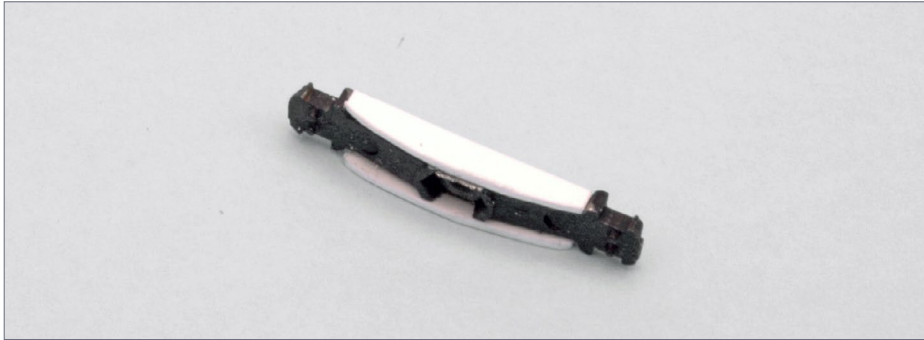

24. Styrene strip on each side of the bolster shown filed-down in [23] looks like this. The exact shape is not vital here. I have also made these panels from paper, which works fine and is thinner than what you see here.



25. An example of a side frame from an old metal “sprung” truck, with a realistic side frame opening, once bolster and springs are removed. These are good items for scenery, though stored side frames often had journal box covers removed.

GETTING REAL | 27

the name Code 88. There has been some anxiety among modelers about whether the Code 88 wheel can operate properly in track-work built to NMRA standards. Involved mathematical arguments have been put forward to “prove” that these wheels will drop into switch frogs.



26. Model wheelsets typically have pointed ends, for perfectly good operational reasons. But they do not make realistic wheelsets in isolation. The fat axle, large flanges, and Code 110 wheels here make the appearance even less realistic.



[Click here for reader comments](#)

Many layout owners with extensive experience with Code 88 wheels know well that such problems do not occur, for reasons we don't need to go into here, but likely arise from rigid truck frames. Nevertheless, it is possible that Code 88 is the limit of operable wheel width in HO scale, without going to more nearly prototypical dimensions for trackwork.

But even "semi-scale" Code 88 wheels really do not look much like the prototype wheels shown here; compare [5,9,19,20]. Yes, Code 88 is a big advance in appearance over the enormous (relative to the prototype) Code 110 wheel treads, and greatly improves the look of freight cars, but even Code 88 will not do for wheelsets in isolation.

The answer is realistically sized wheels in the wheelsets. These can be made in several ways, but the simplest is to use an excellent set of wheels and axles from Tichy, their set 3004. The same wheels and axles are supplied in the Tichy kit for a wheel car. The Tichy parts assemble into very good-looking wheelsets [27].

Modelers often respond to what is shown in [27] with a feeling that the wheels are way too thin. In fact, they are almost exactly correct prototype width, which in HO scale would be 0.065 inches. You can consult some of the prototype photos in this article [9,19,20] to get a clear idea of the comparison being made.

A quick word about color. Unused wheels and axles that have been sitting around awhile are a uniform dark rust color, reddish if not outdoors too long, more of a brown color with more age. New wheels have treads and flanges which were cast or wrought to correct contour, so a new wheel often would not have its tread contour turned, and thus would be the same color as the rest of the wheel. That is what is shown in [27]. I usually darken the assembled Tichy color with Burnt Umber acrylic tube paint.

By contrast, a wheelset that has been in service would be different. The wheel face was usually amazingly thickly coated in oily dirt.

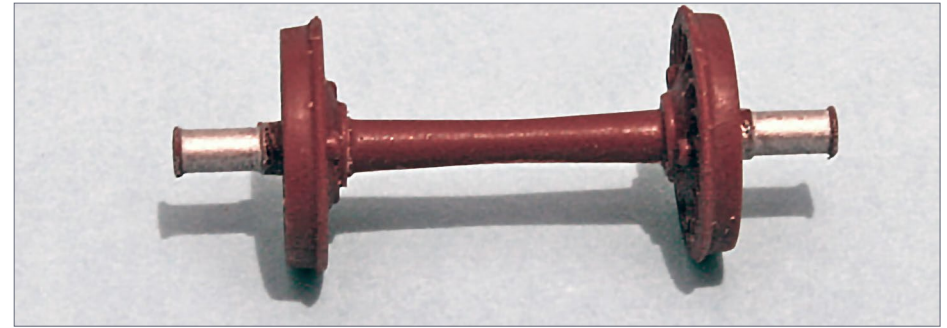

27. This is a Tichy wheelset, assembled from the wheels and axles in Tichy set 3004. The contrast to [26] is considerable. Journal surfaces have been painted silver. The rest of the wheelset is all one color, indicating a new wheel and axle.

Journal oil would leak and spatter, then collect dust and dirt, then accumulate more oil, and so on. This was a dark gray to almost black color. (I use Grimy Black or the Tamiya XF-63 "German Grey.") There was much less of this oily crud on the back of the wheel, so the wheel and axle would take on more of a "road dirt" color from dust and mud along many miles of right-of-way [22]. But wheel treads would be clean and shiny, just like the top of often-used rail.

Finally, removed wheels were often stacked outdoors for some time until scrapped, and in that situation the shiny wear surface of the tread would gradually rust. Final tread color would depend on length of storage. I show some of these colors below.

While on the subject of wheels, I like to make the point that wheels make good gondola loads. Ideally, one would use scale-width wheels like the Tichy wheels, but when stacked, the tread width is not as obvious as it is in a wheelset. I have made a couple of loads consisting of rows of wheels, painted rusty-colored and arranged as though they had been simply laid into the car. Here is a photo

of one such load [28]. It doesn't weigh much, as all the wheels are plastic, and that works for me, because nearly all my open-top cars are weighted so they can run either empty or loaded. I am one of those who makes lightweight loads, not heavy ones.

Just for comparison, here is a 40-foot gondola with one of the wheel loads in it, being switched at the town of Shumala on my layout [29]. There are more than 50 wheels here, most reclaimed from old model trucks with steel axles. The prototype weight of this many wheels would be over 40,000 pounds. Wheels like this could be scrap wheels, being returned to Sacramento to be remelted, or they may be new wheels, being delivered to the local shop to be mounted on axles. This particular load looks like new wheels, rusty but not covered with oily dirt as used wheels would be [29].

As a further comment, I didn't want to have to "polish" the wheel treads, as wheels recently removed from service would exhibit, because the treads are too wide — why call attention to them? (That is one drawback to the polished treads as shown in [22].) So in this case [29], the entirely rusty wheels look right.

But my real goal as part of this modeling was to be able to show clearly, on the layout, a truck being worked on. To model effectively an entire truck being serviced, there is a need to correct the model bolsters, which as I've said can be altered to look more prototypical, primarily in removing the model's huge center hole and adding a center plate.

Separate side frames can be included as part of a model truck scene if sprung trucks are disassembled and the side frames separated (without springs). Brake beams were often removed at the beginning of truck disassembly, so they can be shown as a stack at one side. A number of truck makers, particularly Tahoe Model Works, offer brake beams. (Note their presence in the PFE Los Angeles photo [19]).



28. A load of wheels, made from plastic wheels of old trucks, from which steel axles were discarded. The ones with ribbed backs are Train Miniature wheels. All are glued together into a single piece with contact cement, then painted rusty and various brown tones. The load is sized to fit a 40-foot gondola. Though these are Code 110 wheels, it's less obvious in a mass like this.



29. The wheel load shown in [28] is here put into a 40-foot gondola, and is being switched at the town of Shumala on my layout. The car models one of the 1944-built T&NO "Emergency" gondolas from World War II, Class G-50-17, and was built from a Funaro & Camerlengo kit.

My own work to make a truck having wheelsets changed began with a “sacrifice” truck. I had a one-piece plastic truck with a frame that was somewhat twisted, so that on a flat surface, all four wheels did not touch. It had already been replaced under a freight car, because trucks like that derail easily. I simply cut off the side frame from one side [30].

The reason for cutting off one side frame is because when wheelsets were changed, the side frames were spread apart so the wheelset, with its long journal, could be moved out of the truck. The cut model side frame is now readily placed at the appropriate angle. The spread side frames are evident in [20], showing a freshly disassembled truck, and are also nicely shown in a pair of photos from the early 1930s [31, 32].

These photos also show clearly a jack under the car body bolster, which had been used to raise the weight of the car off the truck

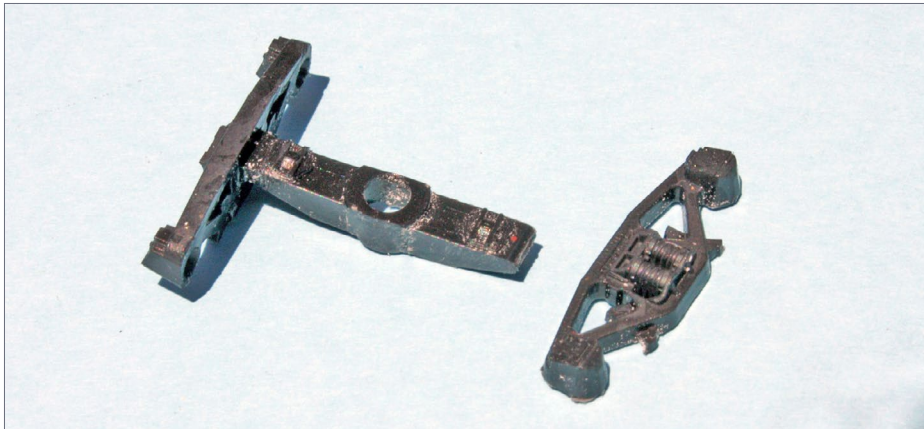

30. A “sacrifice” plastic truck being prepared for detailing. One side frame cut off, bolster filed down to eliminate the wide center hole like those in [23]. New bolster sides and a center plate will be added.

(paired, of course, with another jack on the opposite side). Then a car stand was inserted under the side sill to help support the car.

The next step for my model truck was to correct the bolster appearance, essentially in the way shown in [23, 24]. I added a center plate, simply with a disk of styrene sheet, which also serves to cover the large model center hole. I used a paper punch to make thin styrene discs of about 1/8-inch diameter, to serve as bolster



31. This photo at the Nampa Shop of Pacific Fruit Express shows a workman preparing to dismantle a truck (a T-section Bettendorf) that has been rolled out from under PFE 14966. You can see the kingpin hanging from the body bolster, vertically below the 4 and 9 in the car number. The car was jacked up at the body bolster to take weight off the truck, then a stand placed under the side sill. The reweigh date on the car is April 1929; the chalked shop date is May 12, 1930. *Pacific Fruit Express photo, Milton G. Sorenson collection*



32. Same scene as previous page, at Nampa Shop, with the truck now disassembled and the wheelset ready to remove. *Pacific Fruit Express photo, Milton G. Sorenson collection*

center plates. (Many hole punches make 1/4-inch holes, but some make other sizes.) I also added a small center hole (2 scale inches).

With that done, a couple of Tichy wheelsets were prepared to be shown as the new wheelsets being placed in this truck. One wheelset, depicted as the one already installed in the truck, had to have the journals shortened to fit the limitations of the side frames of the model truck.

The truck being worked on is then shown much like the prototype photo [20], with side frames spread and down. The photo of the model is deliberately posed with no scenery around it, so the arrangement can be seen clearly [33].

The destination for this truck model on my layout is the wheel track near my roundhouse. A concrete pad is located alongside

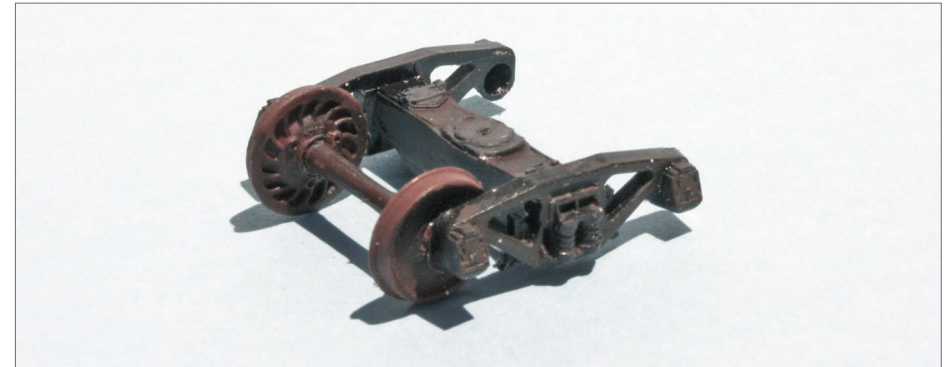

33. The truck being worked on, showing bolster correction with deeper sides, center plate, and kingpin hole. The wheelset is a Tichy.

this track, providing a place for needed tools and to give workmen room to maneuver. I have added a pair of wheelsets on the pad, colored to look like the used wheelsets which were removed from the truck. Accordingly, those wheel treads are painted silver [34].

Any working area where this kind of work was done offers many detailing opportunities. Additional wheelsets, and additional bolsters and axles, are definitely possibilities, as are the brake beams already mentioned. Tools such as car jacks should be present (I used Evergreen Hill set 608), probably also brooms, shovels, and other implements [34].

One illustration of stored wheelsets I've always liked is another of Dick Steinheimer's photos at PFE's Los Angeles Shop. The stored wheelsets here all have a protective coating on the journals, and it would be fun to model all the tools which are leaned up against the wheels [35].

One could go farther with this, for example including a cart with a couple of spring packages, tools, or other cargo on it. Other kinds of work carts could be part of the scene. More men working in



34. The scene with a wheelset replacement in progress. The two replaced wheelsets have silver wheel treads and oily black wheel faces. At left are some stored bolsters and side frames. Ties have been used to make “crossings,” where workmen can roll wheelsets on and off the rails. Note the shovel and broom resting against the new wheelsets at left, and brake beams at right.

appropriate poses can be added. As shown in [19], areas around truck work areas were usually paved to facilitate rolling wheelsets away from the track. But the 2000-pound weight of a wheelset means that these were preferentially rolled on rails unless absolutely necessary to do otherwise. The modeled area must take this into account. A small crane could also be included. All these ideas could help create a realistic and interesting model scene, all based on showing maintenance work on trucks.

Concluding remarks

I recognize that at least some, and maybe most, of the descriptions of model truck details in this article are beyond what anyone



35. Many prototype photos show axle journals prominently, such as the photo, taken at PFE’s Los Angeles Shop in December 1950, showing two rows of wheelsets with the axle journals quite visible. These have been machined and coated to protect them. Note also that the wheelsets are on paired rails (see another pair at right), so that all will roll even in this double-stacked arrangement. The wooden wedges would be useful to restrain rolling. In the background, posed in front of the Shop office, is PFE 93612, a member of PFE’s largest car class, R-30-9. *Richard Steinheimer*

would want to model on a freight or passenger car. Trucks are underneath cars and ordinarily, little other than side frames can usually be seen.

But any time the modeler has reason to portray a truck by itself, whether in a wreck train, around shops or roundhouses, or on a repair track, the various model compromises and shortcuts become blindingly obvious. The most glaring problem is representation of axle journals and width of wheel treads, but realistic truck bolsters and side frames can also be a challenge. I have tried to show ways to improve these aspects for those wanting to model more realistic trucks and truck parts in such situations. ☑

Do ALL your model railroading friends know about MRH?

WE CONTINUE TO BE SURPRISED BY HOW MANY MODELERS STILL HAVE NEVER HEARD OF US - SO SPREAD THE GOOD WORD ABOUT MRH!

BIBLIOGRAPHY

Car Builders' Cyclopedia, various issues, 1903 to 1961.

Hendrickson, Richard H., "Freight Car Trucks," *Railway Prototype Cyclopedia*, Vol. 4, 2000, pp. 35-51.

Hendrickson, Richard H., "Freight Car Trucks, 1900-1960," *Model Railroad Hobbyist*, May 2013.

Hendrickson, Richard H., "HO Scale Freight Car Trucks," April 2014, digital file available at:

docs.google.com/file/d/0Bz_ctrHrDz4wcjJWcENpaDJYbUU/edit?usp=sharing

Karig, Martin Robert, *Coal Cars*, (Chapter 6: Trucks), University of Scranton Press, Scranton, PA, 2007.

Thompson, Anthony W., "Reweigh Dates on Freight Cars," *Railroad Model Craftsman*, April 2011, pp. 72-73.

Thompson, Anthony, blog on Google, particularly these posts:

modelingthesp.blogspot.com/2016/04/trucks-truck-springs-and-snubbers.html

modelingthesp.blogspot.com/2016/04/truck-springs-and-snubbers-part-2.html

modelingthesp.blogspot.com/2016/05/trucks-and-snubbers-part-3.html



MODELS OR PARTS MENTIONED

Funaro & Camerlengo

HO scale T&NO "Emergency" gondola, kit 6263
Post-war version, T&NO gondola, kit 6264

Evergreen Hill

set 308, car jacks

Tichy

Wheels and Axles, set 3004
Wheel Car, kit no. 4023

iwata

by ANEST IWATA

Be Realistic

From weathering broad areas to painting concentrated details, an Iwata airbrush gives you precision and reliable performance for a natural, smooth finish.



Iwata Eclipse CS



NEO for Iwata TRN1



Locomotive from Alan Houtz, North American Prototype Modelers

Click to see the entire line of Iwata Airbrush and Artool Products

Get the Latest Model Railroading News, Tips, Reviews & Opinions

The SCOTTY MASON SHOW

The Original Model Railroad Podcast

-Monthly Interviews

- Modeler's Spotlight: Top Modeler's Talk
- Narrow Gauge Modeling w/Chris Lane
- Contemporary Modeling w/ Mike Rose

-More Product Announcements & Reviews

iTunes Our feed has changed! To get the latest shows, please search Scotty Mason and subscribe to the new feed!

www.TheModelRailroadPodcast.com

Scott Mason Jimmy Simmons Mike Rose Joe Duckworth

DC MODELERS

A lot happens when you put MRC's new Loco Genie on your DC layout.



- Run multiple trains simultaneously on the same track with no block wiring
- Wirelessly manage lights, sounds, speed and direction
- Depending on the Loco Genie chosen, you'll select from multiple prime mover and steam sounds, as well as bell, horns/whistles.
- No complex programming or addressing. No DCC system to buy*
- Easy to use. Plug the receiver into your loco. Activate the transmitter. Turn on your DC or AC power supply and start running.

Experience these features on your DC layout for an MSRP of \$79.98.

*If you already run DCC, or at a later date you decide to go DCC, Loco Genie's receiver-decoder works like a regular DCC decoder, and gives you the added advantage of wireless control.

For details and to watch the Loco Genie video visit us at: www.modelrectifier.com/locogenie-s/125.htm

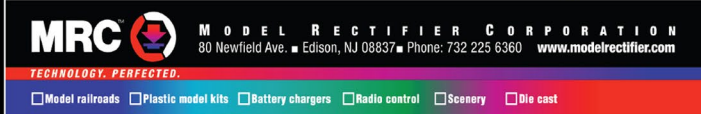

Model Railroad Hobbyist | September 2016 | #79



WHAT'S NEAT WITH KEN PATTERSON

column

KEN PATTERSON



Click here for reader comments

QUICK SWITCHES, CEMENT ROADS, AND MORE ...

THIS MONTH IN WHAT'S NEAT, JEFF OTTO FROM Oak Hill Model Railroad Track Supply stops by and shows us how to build a #6 HO scale turnout using his metal track jigs. For layout construction this month, I show you how to build roads with patching cement, talk about India ink weathering, and then finish the scenery around the roads. I include shoulders, painting the lines on the roads, and the wild grass scenery – it took lots of editing without losing content to fit into my What's Neat 35-minute run time limit.

▶ PHOTOS AND VIDEO OF SUPERB MODELS

WHAT'S NEAT | 2

Oak Hill HO turnout jig

WHAT'S NEAT | 3

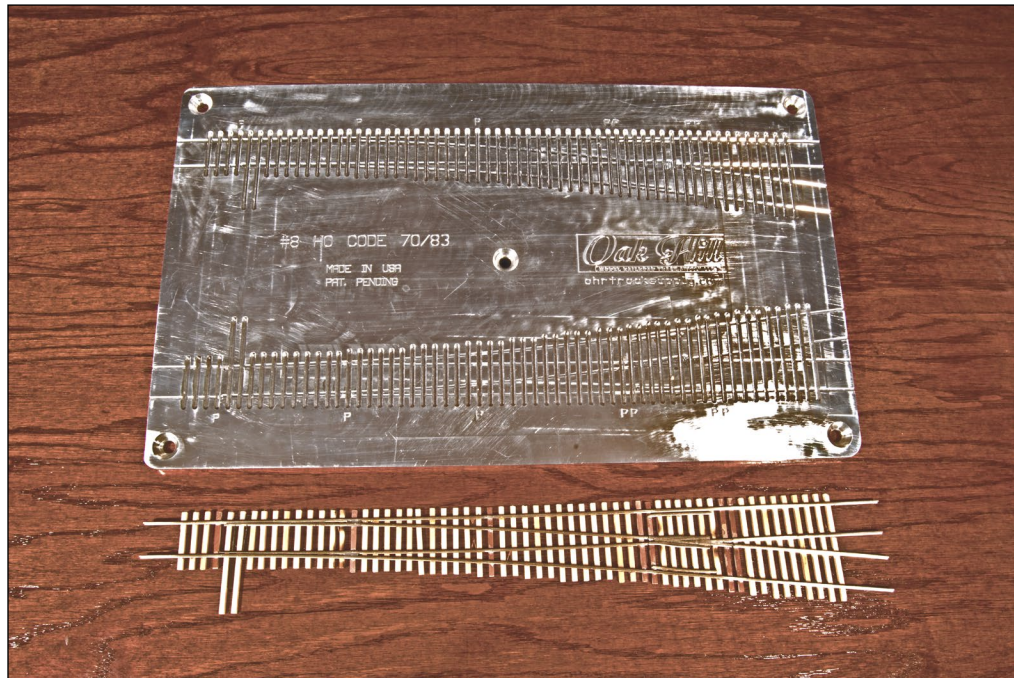

1. Jeff Otto shows us how to use the Oak Hill #6 HO scale track jig to build a finished turnout in 30 minutes from start to finish.

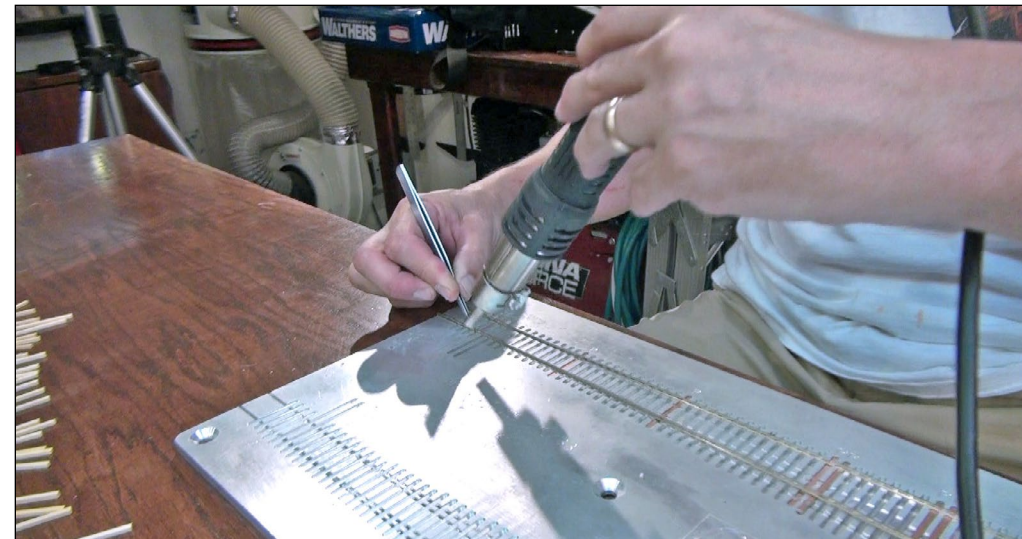

2. He starts by soldering the rails for the turnout to PC board ties. This holds the rail assembly together as an assembled structure ready to be glued to the wood ties.



[Click here for reader comments](#)



Playback problems? [Click here ...](#)

WHAT'S NEAT | 4



3. The wood ties are then placed in the tie grooves milled in the metal plate jig, fitting them into their space based on tie length. Jeff's switch kits include all of these ties cut to size. Of course, you can also use your own cut aftermarket wood ties.

WHAT'S NEAT | 5

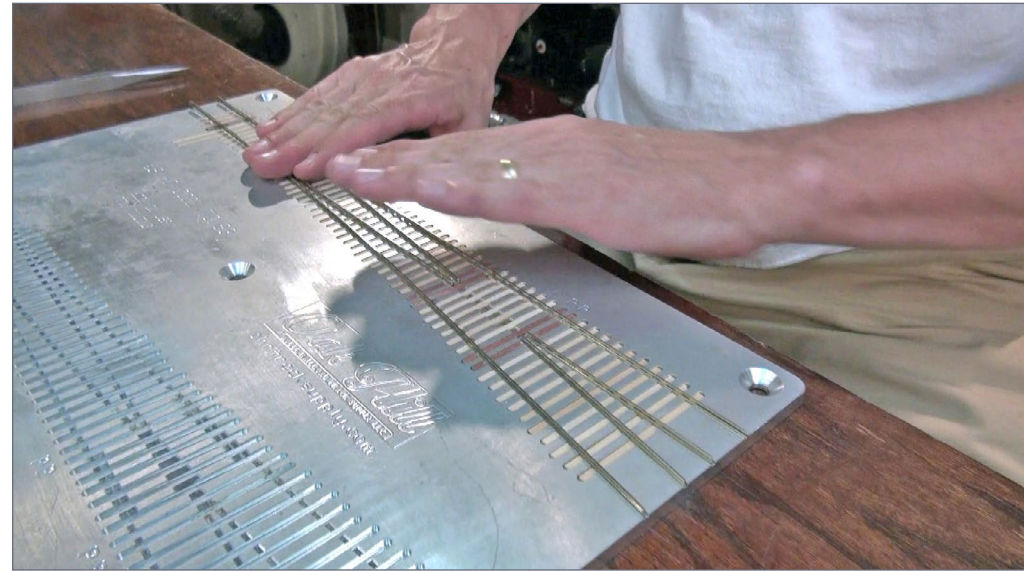

5. Jeff then presses the rails with the glue onto the wood ties atop the jig. He uses a soldering iron to help cure the glue, by gliding the iron's tip alongside the rail in the jig.

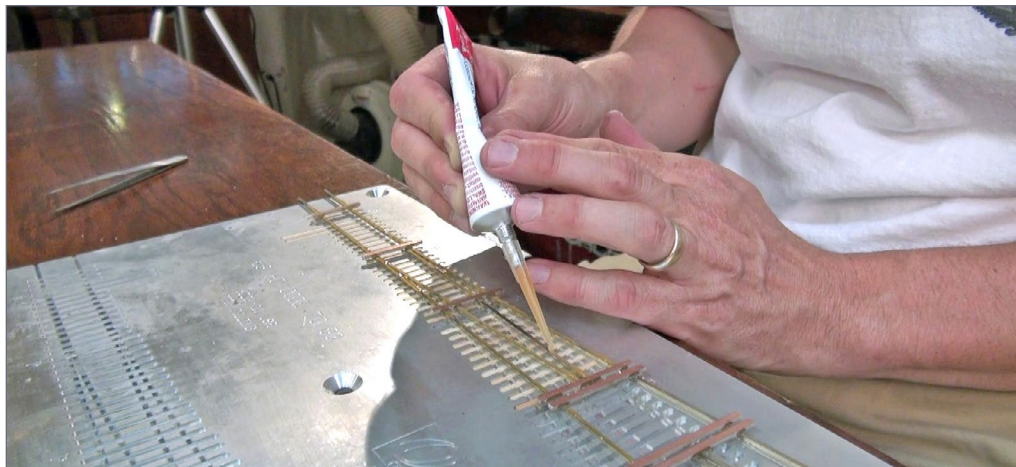

4. Next, Pliobond glue is very carefully applied to the bottom of the PC board switch rail assembly.



6. Jeff then glues the frog and guard rails into place atop the wood ties.

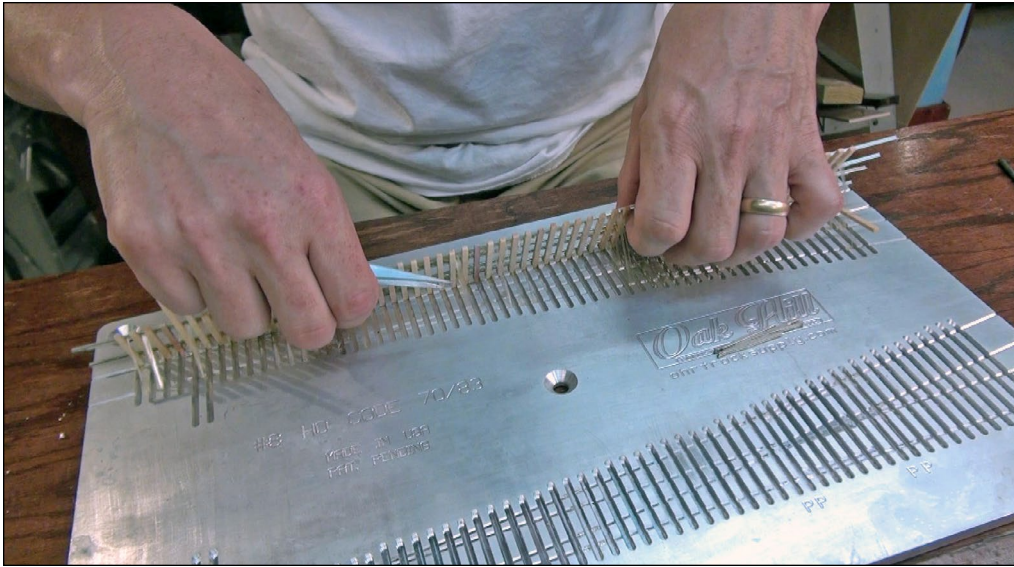

7. After the glue cures for five minutes, Jeff gently pulls the turnout out of the Jig in one piece.

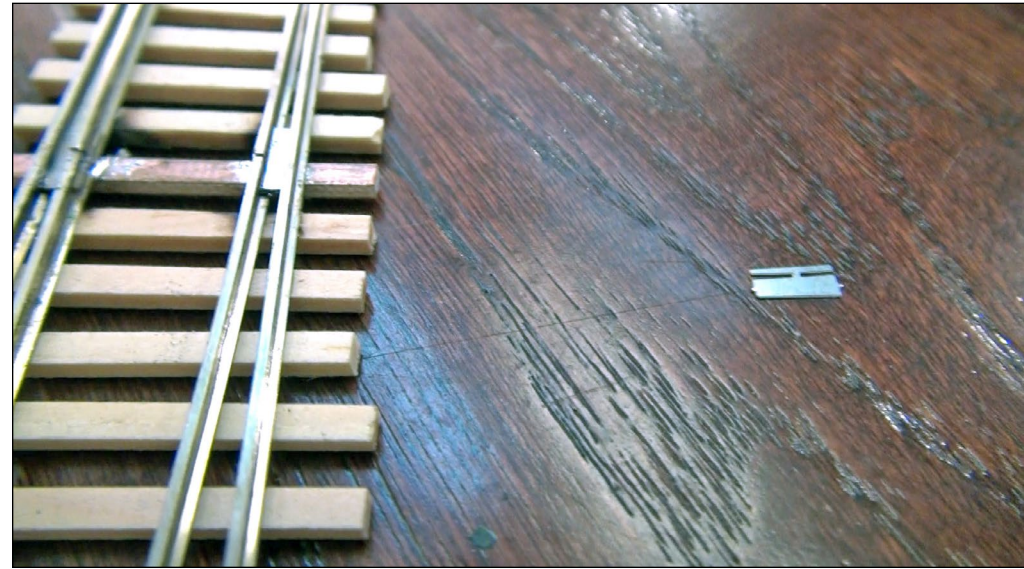

8. Here is the turnout with the hinge installed attached to the points and the adjoining rail. Alongside the turnout is the hinge as flat etched stock before it is bent and soldered to the rail. This flex point conducts the power to the switch point rails.

**Want to help keep
MRH free?
Then *click* on ads!**

 [Click here for
reader comments](#)

WHAT'S NEAT | 8

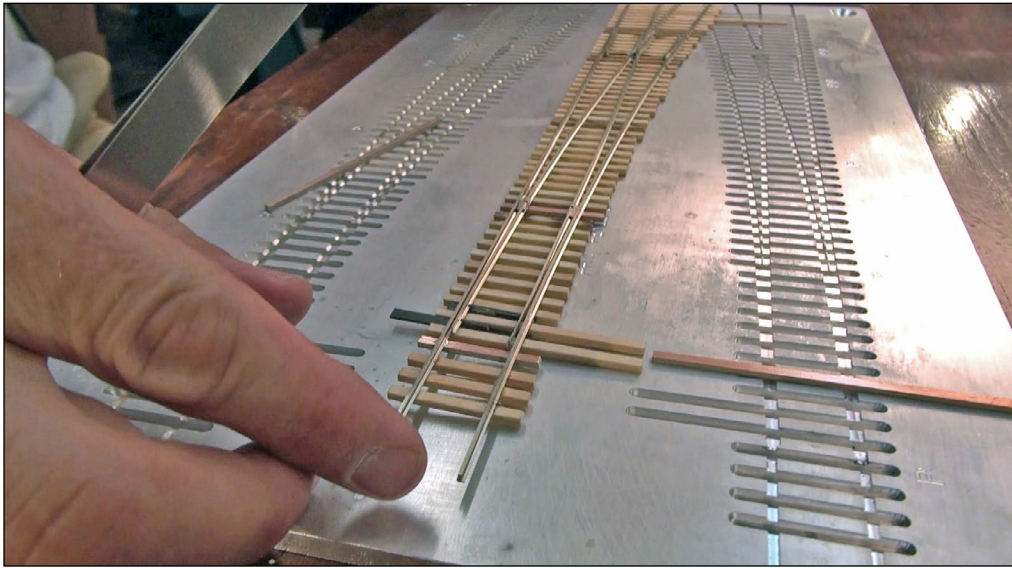

9. To finish the turnout, install the two throw bars to the inside of the point rails. This is easy as the points have holes drilled to fit the throw bars' notches. A little CA glue at the four assembly points and the switch is done, ready to be installed on the layout and weathered to look realistic. Thirty minutes from start to finish. Go to ohrtracksupply.com for more information on Jeff's track jig kits.



[Click here for reader comments](#)

Have you seen this?



CHECK IT OUT!

kenpatterson.com

click here to ...

Visit Ken's website

Ken Patterson reveals his modeling secrets on video!

Layout construction, Building Roads



10. Road-building articles have been in the model press since the hobby started. I have a method that came from a need and has never been covered. I like to use DAP patching cement sold at Home Depot. Building these roads and parking lots took 10 days with dry/set up time.



[Click here for reader comments](#)



11. Even after five years on the layout, the cement remains flexible and does not crack, as you can see where I tore up a section of my layout with roads on it.

TrainMasters TV is part of the MRH product family.

TMTV members not only get great network TV level videos, they help pay for MRH and keep it free ...

WHAT'S NEAT | 11



12-13. Fifteen years ago I used Plexiglas to make roads. It was flexible and could be scribed with expansion joints and cracks. It always looked good when painted and weathered. I built this scene to shoot the box art for Walthers auto rack loading scene.

WHAT'S NEAT | 12



14. I start the patching cement process by locating where I want to put the roads in relation to the trackwork. I cut 1/8" square strips of pine to make forms that curve with the flow of the road. Anchor the forms with 2" straight pins.

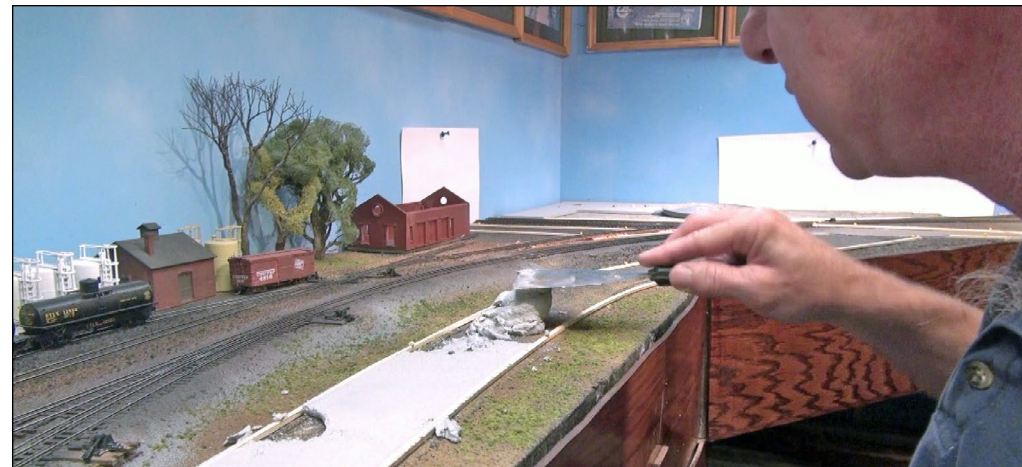

15. Scoop the cement with a 4" taping knife and work it in between the forms. It sticks together and is easy to work onto the foam surface.

WHAT'S NEAT | 13



16. After spraying on a little water I pull the cement smooth between the wood forms with a final wet troweling. I did this for the 17 feet of roads I was building for this area of the layout.

WHAT'S NEAT | 14



18. The cement remains soft deep within but the outside is solid enough to sand off sharp edges and smooth the top with 120 grit sandpaper.



17. After the cement has set up for 24 hours, use a knife to separate the wood forms from the cement.



[Click here for reader comments](#)

WHAT'S NEAT | 15



19. After 48 hours of drying time, use a small painters knife to apply a second coat of cement to the areas where the cement cracks as it shrinks while drying. This is just a normal step in the process. I let this dry for another two days before coloring the roads.

WHAT'S NEAT | 16



21. Apply this mixture to the roads with a 1" paint brush. Brush two coats on the roads, letting the ink-alcohol solution dry 24 hours between coats. To vary the tone, I put one coat on parking lots and side roads, and two coats on main roads.



20. I use India ink/well ink sold for mechanical ink pens to weather roads and wood craftsman structures. I use the dropper supplied with the ink and put two full droppers in a quart jar filled $\frac{3}{4}$ of the way to the top with rubbing alcohol.



22. The lighter application on parking lots and side roads gives them a sun-dried or aged look.

WHAT'S NEAT | 17



23. After the ink solution dries, I glue down strips of fake fur where wild grass would grow. I thin this grass with a barber's clipper.

WHAT'S NEAT | 18



25. I use a block of wood to plow and smooth the shoulders flat and flush with the blacktop roads.



24. I work dirt into the grass areas and ballast the track. I also use this ballast to create four-foot-wide shoulders along the roads.



26. Work in varying shades of ground foam to the grass areas. Then glue the entire scene with Woodland Scenics scenic cement. Let this dry for another 24 hours with a fan running to shorten the drying time.

WHAT'S NEAT | 19



27. Now that the scenery is dry and all the ballast and dirt are in place it is time to add random patches. I use a piece of paper with cut-out squares of varying sizes as a mask to airbrush on thinned black paint. This creates a nice effect.

WHAT'S NEAT | 20



29. Pulling up the tape reveals the white line.

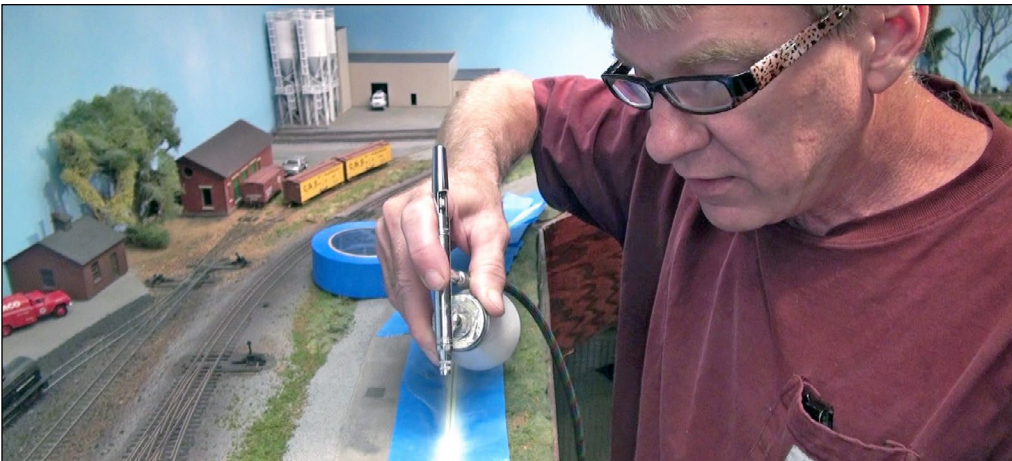

28. Now it is time to mask 4" white lines along the sides of the roads with 3M fine line tape from the auto parts store. I also use 2" masking tape to protect the road from overspray.

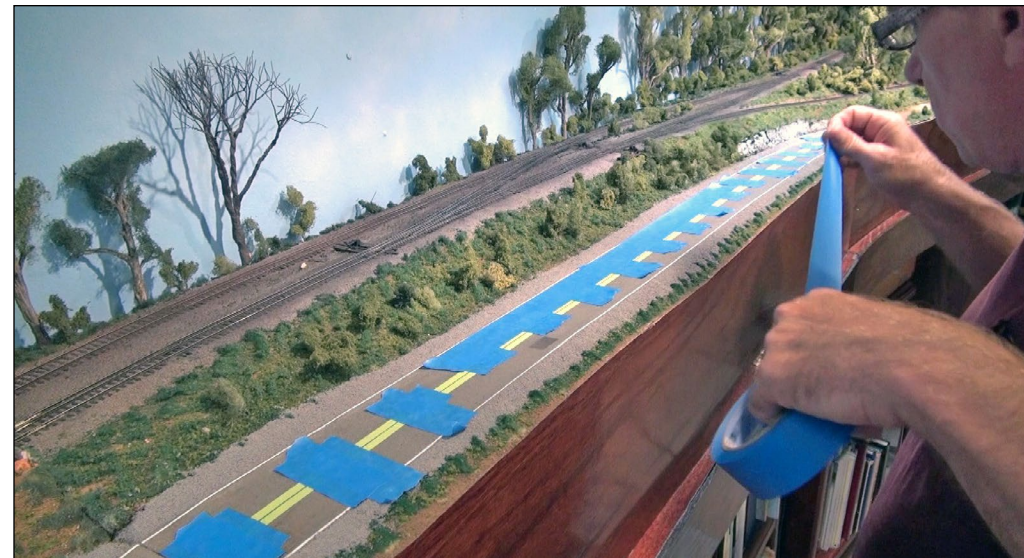

30. Mask the broken center line with the same tape process. Keeping the spaces even, with lanes measuring 11 feet wide.

WHAT'S NEAT | 21



31. With 15 pounds of air pressure, I spray these broken center lines with Testors flat white paint thinned 50%.

WHAT'S NEAT | 22



33. A black Sharpie creates tar patch lines where the road department fills cracks. I still need signs and guard rails, wires and poles, and crossing signals, etc. to finish the scene.



32. With the center lines painted, pull up the tape to find clean, sharp paint edges. The roads are almost finished and looking good.

 [Click here for reader comments](#)



34. Here is a finished section of roads and the parking lot. The road surface is smooth and just perfect to run RC HO scale cars along with the trains.

Brought to
you by
MRH
MODEL RAILROAD HOBBYIST

TRAINMASTERS.TV

WHAT'S NEW!

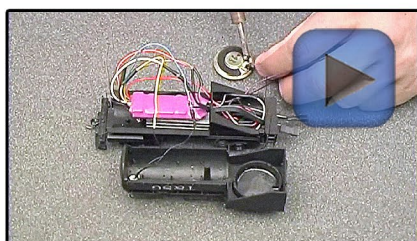

Hard-wire DCC decoder installs



Airbrushing 103



Modeling a flowering garden



Gauging trucks & couplers

Non-members: Watch an episode for \$1.49; become a member for unlimited access

Our videos are in-depth like MRH articles, except without ads

Model Railroad Hobbyist | September 2016 | #79



ROB CLARK
.....

IMAGINEERING

column



Click here for
reader comments

HIDING A HELIX | TRESTLE WORK AT WIDOWS VEIL DISTRACTS THE EYE FROM A SPACE-EATING STRUCTURE

THE CORNHILL & ATHERTON RAILROAD never existed, but in its model form it is slowly evolving from a hazy idea into a tangible reality.

This article is about the creation of Widows Veil trestle, which is a totally imagineered structure forming part of a helix hiding exercise.

Joe Fugate has said in the past “a helix is an evil thing” and so it is. However, there are limited ways to squeeze two decks into an 11' by 9' room, so for me, a helix was the way to go.

Hiding a helix involves a bit of shape shifting – fooling the eye by breaking up vertical and horizontal lines with different scenery textures and vignettes (sub-scenes). Basically, try to get the viewer to forget that the helix exists.

► EXPLORING THE CREATIVE SIDES OF THE HOBBY

IMAGINEERING | 2

A key vignette here is a trestle installed on the lower herniated loop of the helix.

By its very nature a trestle is a symmetrical structure, so I was keen to find a way of giving it a more interesting footprint. Typically, model bridges are measured up for gap and height and then assembled on the workbench. After installation the scenery is built up to match the bridge supports.

I wanted to try building the scenery first and then see what I needed to do to create the bridge. This should give a more natural look, since I would have to replicate the problems a real bridge engineer would face.

After a few experiments I have settled on a standard set of scenery construction techniques. Speed and simplicity are the key words. You can see in [2] the fascia profile board which was cut randomly and fitted to the base of the helix. I cut foam board with a serrated knife and fitted it behind the profile board.

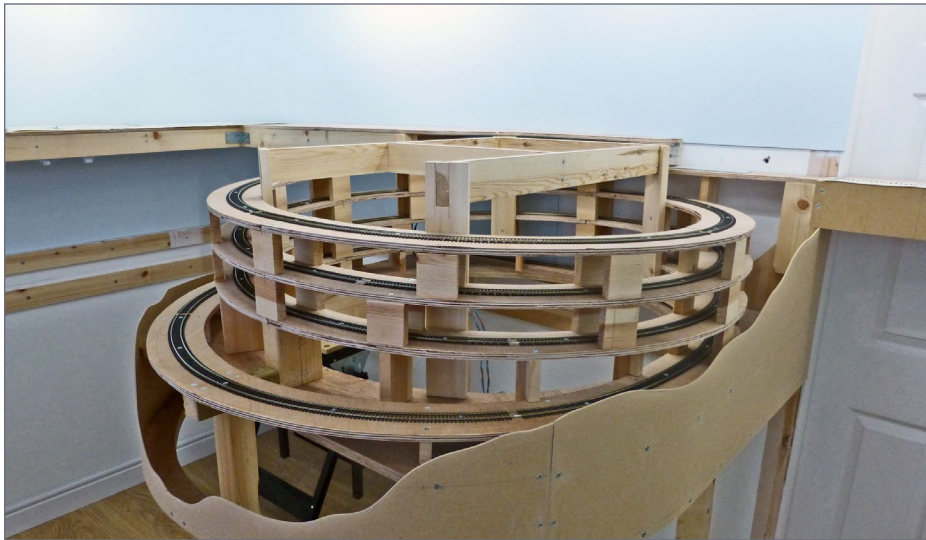

1. This is the starting point of the problem – a very ugly helix.

IMAGINEERING | 3



2. Screen wire is hot-glued to the outer helix frame and continued around to the foam board edge profile. The dummy trestle spans the gap between the tunnel formers to give clearance guidance when rock work starts.

Wire mesh is then hot-glued to the outer face of the helix where we will have a sheer rock face and it is also used to create the valley floor. It's better to use smaller pieces of mesh with overlaps, rather than forcing a larger piece to fit. Use thin mesh. It may seem flimsy but when plaster cloth is fitted it firms up nicely. It's also much easier to work into the shapes you want and cuts easily.

Dummy trestle

I decided to build a dummy trestle. This is useful when rock work is being applied so that sufficient track clearance is maintained. It

IMAGINEERING | 4

provides a visual anchor for the rock work and just having it physically in the scene influences how you apply rocks. The deck is balsa and bents are MDF. For assembly, hot glue is your friend.

I cast a selection of rocks using Woodland Scenics moulds and plaster of Paris. After a couple of days drying time, apply them to the vertical helix face using hot glue and then fill the gaps with Sculptamold.

The rock weathering is standard practice leopard spotting (see Woodland Scenics Tutorial – [youtube.com/watch?v=3Sfp4RpcDYw](https://www.youtube.com/watch?v=3Sfp4RpcDYw)) using burnt umber and yellow ochre



3. Plaster cloth is applied to the screen wire and more dummy trestle bents are in place. Balsa sheet has been used to create a shed former where the rock face is going to overhang the tunnel entrance. This will be replaced with a fully modeled version at the end of the build.

IMAGINEERING | 5



4. Plaster rocks cast in rubber molds are applied. Sculptamold has also been applied to the screen wire in the trestle valley and colored with a brown pigment wash. On the right you can see scenic effects being applied to the rock face.

followed by a wash of black. A spray of scenic cement fixes the pigments. Polyfiber, ground foam and fine leaf foliage break up the starkness of the rock and this fits in with the deliberately restricted and generally green palette of the Cornhill & Atherton.

I never have a complete picture in my mind when I start a scene – it just evolves (another article opportunity here!). So even though it might seem like an out of sequence process, applying scenic effects to the valley floor at this point [5] helps in visualizing the final scene.

I'm not planning to show you how to build a trestle here. This article is more about fitting a trestle into a developed scene. Take

a look at Charlie Comstock's trestle building article in the *Model Railroad Hobbyist* March/April 2011 issues (issuu.com/mr-hobbyist/docs/mrh11-04-apr2011-ol?viewMode=presentation&mode=embed). He followed the "bridge then scenery" approach I mentioned earlier.

Imagining the engineer's problem

Because of the steep slope and loose rockwork it wouldn't have been practical to rely on just the bent sills sitting on the valley floor. The trestle would tend to slide down into the valley. Therefore stone piers are required to give a solid foundation. To save money and time, only enough pier construction would have been done to get a safe situation.



5. At this point all of the basic scenery is complete and the dummy trestle has finished its job.



6. I have temporarily installed the core of the trestle deck. This is marked up to show where the bents will be installed.

To establish the size of each pier the key thing is to create each bent to be deep enough to reach the lowest point of the valley floor. Then cut away the rear bents to accommodate the valley slope and fit a new sill.

Piers are constructed for the cutaway part of the bent sill to rest on. Construction is from 5/8" MDF. The width matches the sill length plus 1/2" and the depth matches the maximum vertical distance from the base of the bent to just below the valley floor.

After roughening the MDF surface with glass paper to aid adhesion, apply a thin layer of plaster. When it is dry enough, use a ruler and small screwdriver to scribe the mortar lines. Spacing should

IMAGINEERING | 8

be to please your own eye – you are the boss! Color the pier to match the local stone available on your railroad.

On the C&A I have used an India ink and alcohol wash to get a gray base followed by smudges of acrylic wash – burnt sienna, burnt umber and raw sienna. Do whatever you feel like here – you can't make any mistakes with weathering!

Glue the bent to the underside of the trestle deck ensuring it is perpendicular to the track direction and hanging exactly square.

Cut a slot in the scenery base directly below the bent using a heavy duty craft knife. Use a sawing action and this will cut both the plaster cloth and screen mesh easily. Take care not to disturb the bent.

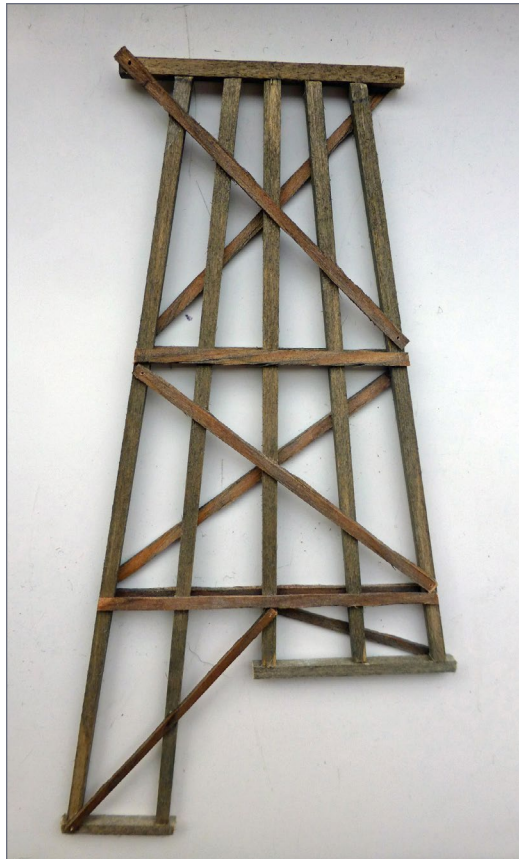

Feed the pier into the slot, offer up to the bent sill and then hot glue to the valley base. Use a few spots from above and then add more glue from underneath. The great thing with a glue gun

7. This is a jig-built trestle bent. I test-inserted it under the deck and cut down the rear uprights to accommodate the slope of the valley floor.

IMAGINEERING | 9



8. The bent piers are made from a core of 5/8" MDF cut to shape and then coated with plaster, mortar lines scribed and finally painted. Since some of the pier will be below grade, full detailing isn't required.

is the way you have a generous number of seconds to accurately position and then within a minute everything is held tight. Take great care with hot glue when applying in an upwards direction – it can dribble.

In picture [12] Jean (I don't wear nail varnish) is re-applying the scenery details to the valley floor after the piers have been installed. We use combinations of Woodland Scenics clump

foliage, foliage clusters, polyfiber and ground foam along with tea leaves and very small rock castings. A glue gun allows fast application of bushes to near vertical slopes.

A quick and easy way to get rock fall/scree is to crumble a spare casting you have made for the rock face. Apply the same wash as you used before so that the rock colors match.



[Click here for reader comments](#)



9. This shows how the bent and pier are mated. This is a final check to make sure that you have the correct pier and bent combination. If you batch build these it's easy to get them mismatched.



10. From left to right, the three stages of pier insertion. The first has the bent glued in place to the trestle deck. Then a slot is roughly cut to accommodate the pier. Finally the pier is inserted, butted up to the bent base, and hot-glued from below.

Completing the trestle

Once all the piers are correctly positioned you can move the trestle to the workbench and fit the cross bracing. I used a limited number of nut and bolt castings on the immediately visible joints to increase realism.

The portal shed, inspired by the White Pass & Yukon RR, was constructed very quickly using balsa wood. The previously made dummy shed was used as a guide to make a set of simple frames. The base is made using exactly the same technique as the trestle



11. And this is what it's all about. Every pier is different reflecting the construction issues that the crew faced on the real life bridge build.



12. The trestle has been removed for the bracing assembly and Jean is adding vegetation. A hot glue gun is a fast and effective way of adding bushes on nearly vertical faces.



13. All of the bracing has been added along with nut and bolt castings on the exposed joints only. This is most easily done with the trestle on the workbench.



14. I built a rock shed to protect the track from falling scree. The base sections are made with the same technique as the bridge piers and the rest is simple balsa framing and planking.

IMAGINEERING | 14

piers but using thinner wood. I applied 1/16" balsa planks to the frames to create cladding and a roof. These are pre-stained using my India ink and alcohol wash.

In this overall view [16] you can see how the irregular combinations of trees, rock strata and bridge all help to break up the helix outline. I'm thinking it works in a similar way to dazzle camouflage as used on wartime shipping.

This "scenery first" technique is one I plan to use a lot more in the future.

In the same way that there are a lot of folks working on the C&A that I just haven't met yet, there are a lot of hills and valleys just waiting to be surveyed.



[Click here for reader comments](#)



15. The completed job with plenty of vegetation and loose stones added.



The Amherst Railway Society Railroad Hobby Show

Our 2017 Show will be

January 28 & 29, 2017

Save the dates!

[Click to learn more ...](#)



About The Show

Every year late in January or early in February, the Amherst Railway Society holds its Railroad Hobby Show at the Eastern States Exposition Fairgrounds (The home of The Big E) in West Springfield, Massachusetts. More than 25,000 railfans and public attended the Show each of the past three years.

The event features real life railroads and scale model railroads, historical societies, travel agencies, art shows, flea market dealers, importers, manufacturers and photographers. You have to see it to believe it!



16. The finished trestle sits nicely at the base of the helix and the changes of texture from vertical rock to dense trees help break up the cylinder effect.



MRH MARKETPLACE



**New Kits Coming:
NWP USRA Express Box**

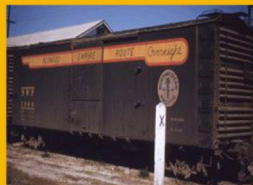

westerfieldmodels.com

LOOK
at what's new at
Black Cat this month

Click here for
our website

CN Ballast hoppers



Black Cat Publishing
(204)489-5005
ajfergus@mymts.net
blackcatdecals.com



Yarmouth Model Works
HO scale resin kits and detail parts



U.S.A. MAILING ADDRESS
3560 Pine Grove Ave. Unit 617
Port Huron, MI 48060
Tel. 519-633-7574
pierre.oliver@start.ca
www.yarmouthmodelworks.com
CANADIAN MAILING ADDRESS
85 Hiawatha St.
St. Thomas, ON N5P 2T5



Quality DCC Equipment

- Digitrax • TCS • NCE •
- QSI • SoundTraxx •
- Lenz • LokSound •

Visit our website!

dcchobbysupply.com



P.O. Box 6 Paonia, CO 81428
Ph. 970 527 4586
Made in The USA

Cast resin items for All Scales.
Tunnel portals, bridge piers, abutments,
culverts, and retaining walls.
Trackside details and sage brush tree
armatures.

"FREE SHIPPING see website for details"

Don't settle for lifeless signals!
We've got signaling circuits!



LOGIC RAIL™
TECHNOLOGIES

"Sophisticated
Model Railroad
Electronics"

Please visit our website and online store!

21175 Tomball Pkwy Suite 287
Houston, TX 77070
Phone: (281)261-5813
<http://www.logicrailtech.com>
info@logicrailtech.com



Craftsman Model Kits
www.kcworkshop.com
www.facebook.com/kcworkshop

FEATURING
**America's Historic
Main Street Architecture**



O-Scale model shown (HO available)



www.mainstreet-heritage.com

FREE SHIPPING

ON ALL ORDERS*
WITHIN CONTINENTAL U.S. & U.S. TERRITORIES



AVAILABLE
SEPTEMBER
2016

LED lights, Animated Signs, & Sounds
www.lights4models.com 614-296-8691 [Click Here](#)



Scale  Photo Etch

Radio Tower with Blinking Lights

Fully painted and assembled, ready to
be placed on your layout or diorama.

Kit includes 12V power supply.

www.scalephotoetch.com



**Affordable Modular (domino)
Benchwork in 200+ sizes**

Custom built to order benchwork also available!

AMERICA'S NUMBER ONE
RAILROAD PRINT SOURCE



**Jelsma
Graphics**

America's Railroad Embroiderer

Railroad Art-Prints,
Caps, Jackets,
Shirts and More ...
Jackets starting
at \$79.95

www.jelsma.com

1-904-221-3513 • Jacksonville, FL.

CLEVER
models LLC
Cardstock models & materials

Try one today!

www.clevermodels.net

JIM'S TRACK PLANS

EXPLORE HERE

New Designs Every Tuesday!

RULERS-of-the-WORLD
Scale Rulers \$4 each
Over 200+ scales!
Metric or Imperial
www.rulers-of-the-world.com

HO DIESEL SUPPLY
KATO EMD SD SPECIALIST-REPAIRS-UPGRADES
New and Rebuilt Locomotives
Powered Chassis-Trucks-Motors
Bodies and Parts-Handrails-Electronics
www.hodieselsupply.com
email:kato@hodieselsupply.com

Have you seen these popular blogs on the MRH website?



MODEL RAILROAD
BenchWork .com

Affordable built to order Benchwork starting at only \$20 a Sq Ft.

PRECISION DESIGN CO

Chains
Flat Car loads
Joint Bars
Signs & Posts

FREE SHIPPING

Great Decals!™
FEC, Interstate, Virginian Railway, & L&N Titles
After Hours Graphics Line
Coupler Gages and More
In O, S, HO, and N Scales

Tom Johnson's L&N
300,000 reads
CLICK TO READ IT NOW

Oak Hill
MODEL RAILROAD TRACK SUPPLY LLC

JEFF OTTO
TURNIN' it OUT

414-915-4671
ohrtracksupply.com
jeff@ohrtracksupply.com

N36W23431 Oak Hill Ln.
Pewaukee, WI 53072

Your ad could be in this space for as low as \$88 a month.

Click to learn more ...

?

DID YOU KNOW MRH SUBSCRIBERS GET FREE BONUSES?

CLICK TO SUBSCRIBE NOW - IT'S FREE!

Ken Glover's Shelf Layout
100,000 reads
CLICK TO READ IT NOW

Upgrading a **Bowser factory-painted Conrail C636**



BY NEIL R. SCHOFIELD

*Easy upgrades to a Bowser
Executive Line Alco C636 ...*



Click here for
reader comments

OVER THE LAST 10 YEARS OR SO, LOCOMOTIVE the manufacturers have been releasing well-detailed factory-painted locomotives that are far superior to some of the custom brass models of the 1990s. Even better, most are available with factory-installed sound systems specific to the locomotive. As a teenager and into my early 20s, I spent many hours custom-building locomotives, shaving off molded-on details and breaking countless #79 drills for new grab irons and eye bolts. The new factory-detailed models are a blessing for me. No longer is it necessary to spend weeks custom-building a locomotive model with road-specific details. Rather, a few enjoyable evenings can be spent adding minor details, followed by a nice weathering job, bringing a model to life. Instant gratification, as a friend and I always say. This article conveys some of the details I added to a factory-painted Conrail C636, converting it from a well-detailed model into a miniature replica of the prototype. Combining that with a great sound system from ESU Loksound esu.eu/en/downloads/sounds/loksound-select/loksound-select-usa and the early days of Conrail are resurrected once again. Follow along as I illustrate some of the details added to recreate Conrail 6792 as she appeared in the late 1970s.

Underframe and truck details

The approach I took with this model was to add details that will have an immediate impact from a few feet away, but I want the

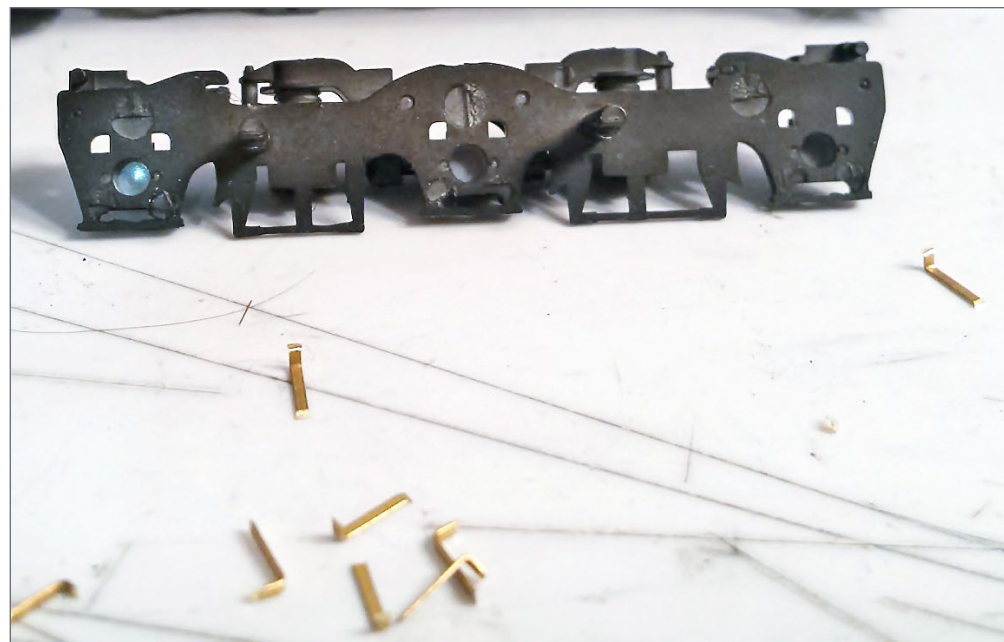

1. The formed brass flat stock pieces ready to add to the side frame.

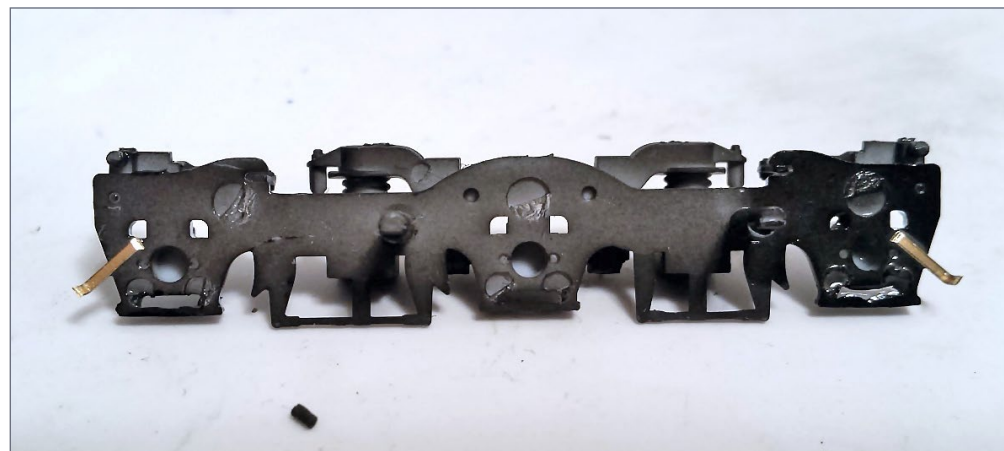

2. The location of the formed brass pieces. They are glued with ACC to the side frame

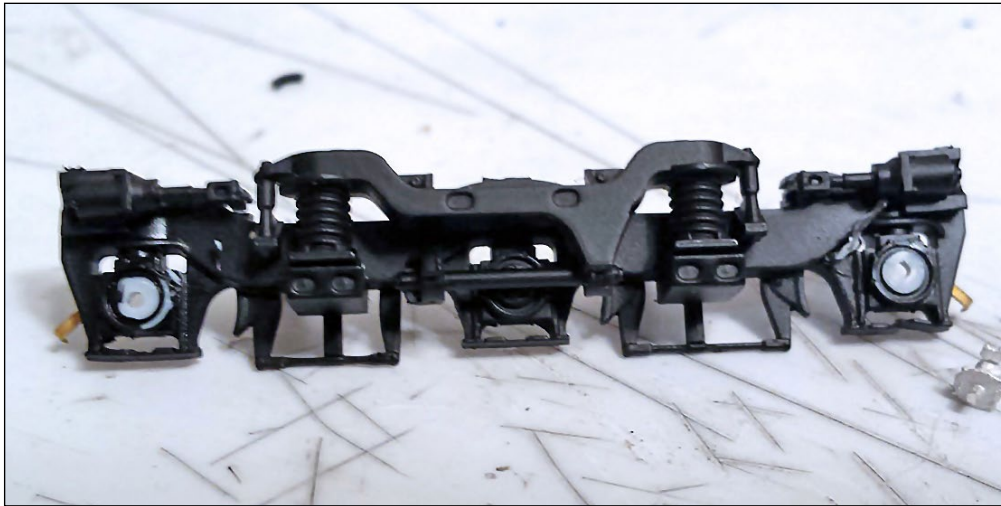

3. The bearings are removed and a pre-cut Details Associates wheel-slip indicator ready to install.



4. A #79 hole is being drilled just to the left of the wheel-slip indicator to allow installation of the 0.010" cable.



5. The completed side frame ready to remount to the trucks.

model to operate without parts falling off with simple handling or rerailling during operation. Details that always catch my eye are the sand hoses mounted to the truck side frames. The Bowser C636 has Alco's version of the Hi-Adhesion truck which is a busy-looking side frame with a bulky feel unlike any other side frame I've seen. Complementing that with sand hoses helps fill that empty space between the pilot steps and the truck side frames. Adding the sand hoses was done with some small pieces of 0.010" x 0.030" brass bar and 0.020" vinyl cable material available by Details Associates.

The next detail I added to the side frames are Details West wheel-slip indicators. The easiest and most effective method I've found

to represent the slip indicator cables is using 0.010" brass wire that is drilled into the side frame directly to the side of the face of the indicator as shown in [5]. The wire is bent at a 90-degree angle directly into the side frame, which adds strength and rigidity so it doesn't fall off when handled. However, care must be taken to not install the brass wire too far into the side frame or it will interfere with the locomotive axle.

After completing the side frames, it's time to make the eight sand hose cables (two per side frame) using the Details Associates vinyl cable. Each cable piece hangs down from the frame about 4'-6" with a 1'-6" section bent in an L-shape and glued to the underside of the frame as shown in [8].



7. The sand hoses made from Details Associates 0.020" vinyl cable; actual length is about a scale 4'-6".

Pilot details

After completing the side frame details, it's time to modify the pilot specific to Conrail 6792. As delivered from the factory, the Penn Central C636s had pilots that included MU hose pockets with step boards, but by the time of Conrail's formation, step boards were being removed to comply with safety regulations. In many cases, the entire pilot was modified with a steel plate. Such was the case with #6792. The steel plates were bolted in place. I replicated this piece with 0.010" styrene cut to the width of the pilot and glued in place with Testors Model Cement. Detail Associates nut-and-bolt locations were marked with a Sharpie pen, and a sharp-pointed needle was used to pre-mark the bolt

ADVERTISEMENT

1st choice for model railway supplies and service.

Expedited mail service available across North America.

Click to visit:
WWW.CVRCO.COM
1 800 464 1730

BOWSER CONRAIL C636 | 9

head locations. After the steel plates were glued in place and the nut-bolt castings installed, the factory-installed MU hoses were re-applied.

Cab details

On a diesel locomotive, my attention is always drawn to the cab, so enhancing cab details alone can often make a locomotive appear more detailed than it really is. For this model, I decided that opening the engineer's cab window would be a nice detail, adding a human touch, since the prototype cabs were rather dull with Conrail blue painted over the silver cab windows. This step is actually relatively simple with the exception of pushing out the plastic tabs that hold the cab onto the walkway. Once the

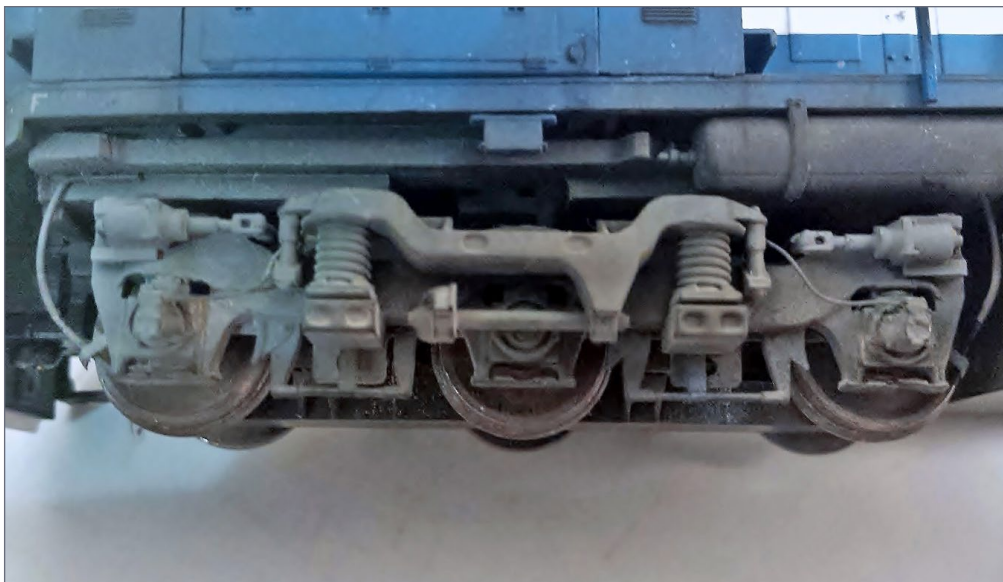

8. The sand hoses were attached to the underframe. While not prototypically accurate, the resulting illusion is effective when viewed from only a few feet away.

BOWSER CONRAIL C636 | 10



9. The factory model with the pilot removed.

cab is removed, I carefully remove the number board and light assembly, sliding it straight out from the cab face with the lighting wires still intact. Then, I can handle the cab separately and snap out the glass from the engineer's cab window and trim away the vertical window dividers. Using a small needle file,

I file down a flat spot at the top and bottom of the window to represent the opening where the two sliding panes are opened. I then cut two small strips of 0.015" x 0.015" styrene for the vertical pane supports and add a cab armrest with a piece of 0.020" thick styrene cut the length of the window and painted black. Finally, I add Details Associates "Prime" straight wind deflectors that are carefully painted blue.

The last cab detail was to replace the factory-installed windshield wipers with A-Line long and short wipers. Care must be taken to use a pair of needlenose pliers to pull the flat metal wipers out from the cab face so the tabs also come out. If necessary, re-drill a #76 hole to accept the new A-Line wipers,. Otherwise the existing hole can be reused.

Weathering

Like most model projects, building a convincing model involves a good weathering job to bring the model to life. There are countless methods and materials to use for weathering and while I don't profess to be an expert, I have plagiarized enough techniques from others that I feel comfortable attacking almost any weathering application. To me, this is the most enjoyable aspect of the construction because in a matter of an hour or two, the engine transforms from a shiny toy into a hard-working prototype. I'll leave the step-by-step instructions to Mike Confalone's



10. The sanded pilot and steel plate with drill holes marked with a sharp needle point to show where the bolt heads will be added once it's glued in place.

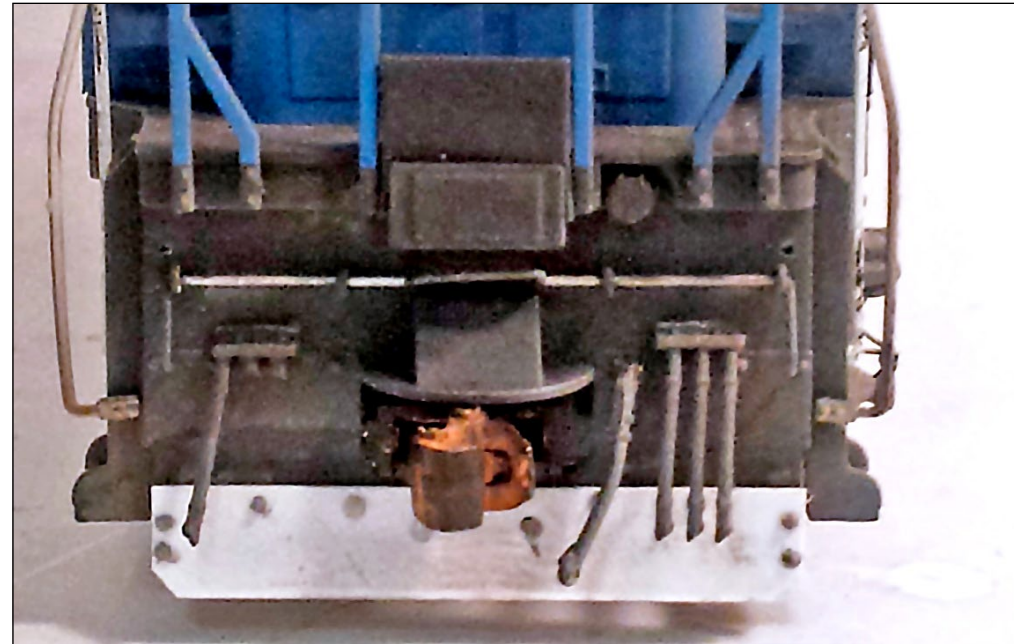

11. The steel plate has the nut-and-bolt holes drilled and glued in place, and is ready for touchup paint.

weathering videos or some of the other weathering techniques shown on various forums, but I will highlight some of my techniques used on this model.

Prior to all my weathering projects, I always start by applying a thorough coat of Testors Dullcote to the model, letting it dry for at least a few hours. I find applying it with an airbrush gives the most uniform coating. Spray cans can be used as well, though I've found the end results aren't as effective. Most of my weathering techniques involve three methods, including artist oil paints with a mineral spirit wash, Pan Pastels for dust, and an airbrush application of grimy black to the roof.

BOWSER CONRAIL C636 | 13

Following the Dullcote, the first technique starts with an application of artist oil washes. I use a small brush to drop the wash into the spaces between the hood doors and along weld seam lines. After I finish one side of the locomotive, I allow it to dry for 10 minutes or so and then use a Q-tip dipped in clean mineral spirits to wash off any blotchy areas of the oil paints. Once the first side is complete and dries for an hour or so, I jump to the second side of the model and do the same.

Next, I usually jump to Pan Pastels, which work well for applying dust to the walkways and truck details. I've been using the Pan Pastels for only a few months, but they work much better



12. Strip styrene pieces are used to rebuild the cab window and add wind deflectors. The painting imperfections will be covered with weathering later.

BOWSER CONRAIL C636 | 14

than other chalks I've used, and tend to grab to the model much more than some of the other commercially available chalks. Using one of several color variations, and following prototype photos, I blotch and streak on the pastels to bring out the details of the underframe, especially on and around the trucks and pilots where dust and sand accumulate the most.

The last step of weathering is usually airbrushing a light application of darkened grime on the roof and ends to blend the highlights together and soften the sharp contrasts. For this model, I was still fortunate to have some lacquer-based Floquil Grimy Black left, but there are alternate paints coming onto the market that will give the same results. I prefer Floquil paints for the fine size of the paint pigment when applied in a 10% paint to 90% thinner application, which builds up a little at a time. This is the key

Combo Right Clamp™

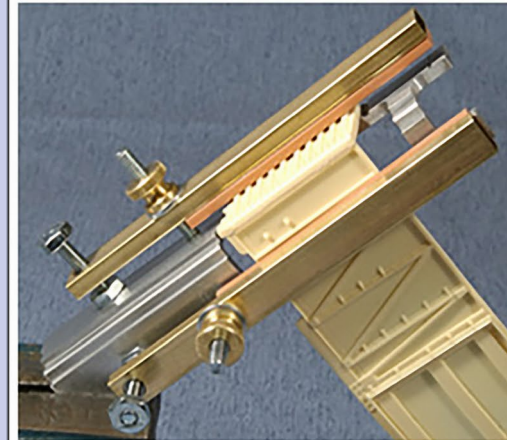

Combo Right Clamp™
with cast resin boxcar

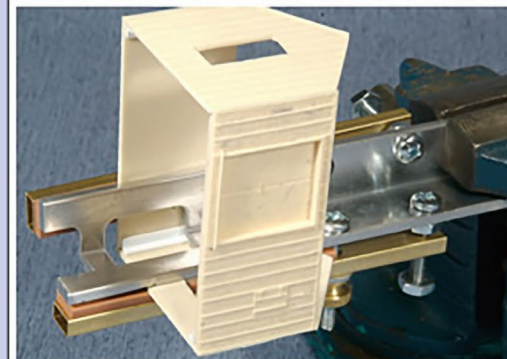

Combo Right Clamp™
with Wolf Design Pump House

[Click here for
all our products ...](#)

Tools for Modelers

Coffman Graphic Solutions Co.
1500 River Circle, Richmond,
KY 40475-7907

BOWSER CONRAIL C636 | 15

to effective weathering, rather than trying to apply weathering in one thick application. The final step is an application of Dullcote over the completed model to seal-in the weathering. After allowing the model to dry overnight, it's time to put the Alco back in service nearly 40 years after the first Alco emerged in Conrail Blue. ✓

Want to help keep
MRH free?

Then *click on ads!*

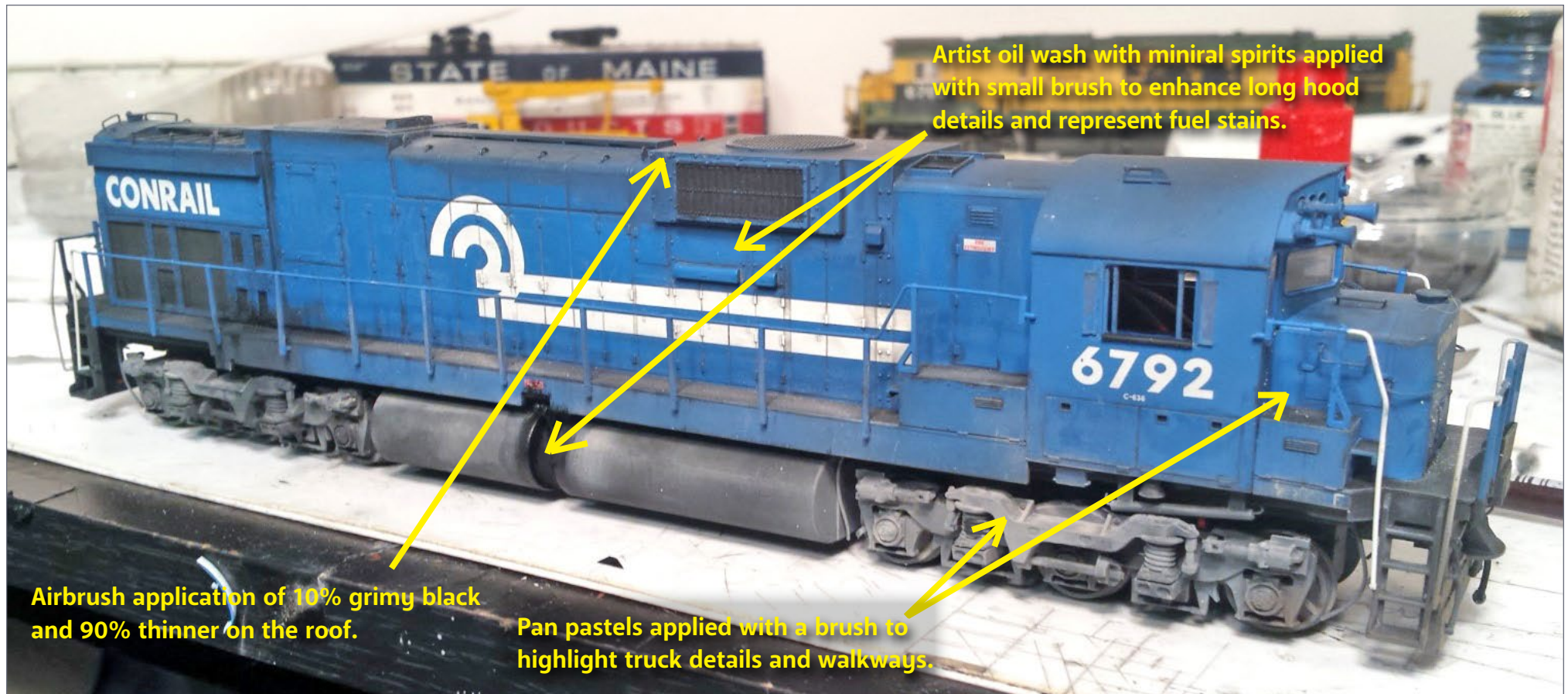

13. The finished results of the different weathering methods used on the locomotive.



14. The conductor's side of the locomotive and the overall effect of multiple weathering techniques.

MATERIAL LIST

A-Line

#29200 – Windshield Wipers (Long & Short)

Bowser

#23614 – Conrail Locomotive Number 6792 C636 (Sound Optional)

Detail Associates

1512 – Cable Material – Vinyl Black

2312 – Cab Deflector – “Prime” Straight

2503 – Brass Wire – 0.010” diameter

2524 – Brass Flat Bar (alternately plain 0.010” flat brass sheet cut in strips)

Detail West

WS350 – Wheel-slip Modulation Device

Evergreen Styrene

9015 – 0.015” Sheet Styrene (Cab Details)

9020 – 0.020” Sheet Styrene (Cab Details)

Kadee

#78 Couplers and coupler box

Testors

1160 – Dullcote



Click here for reader comments

NEIL R. SCHOFIELD



Neil Schofield lives in Charlton, MA with his wife, three children, and the family dog. He works in Holyoke, MA as a senior project manager for an environmental consulting firm.

This is Neil’s second feature in MRH. Thanks to his father, Neil has been interested in trains since he was 6 or 7. His childhood memories include many railfan trips throughout the Northeast,

along with fond memories of operating modern piggyback cars on his father’s steam-era layout.

Growing up, he was a self-proclaimed rivet-counter when it came to rolling stock and locomotives. Since layout building commenced, the rivet counting has diminished in favor of getting trains running, building scenery, and structures. He’s now about two years into his third layout that is based on CP Rail operations in Vermont. He has already installed his Agway Feed Mill featured in the September 2014 *MRH* magazine, and he is hoping to present the layout in a future MRH article.

While he enjoys modeling CP’s operations in Vermont, he also occasionally strays toward other prototype modeling, generally railroads found throughout the northeast.

When he’s not working, attending one of his children’s sporting events, or modeling, he enjoys exercising and watching Boston’s sports teams.

Great Northern – MOW Rock Train TRAIN SET



PACIFIC WESTERN RAIL SYSTEMS
SPECIAL RUN LOCO

PACIFIC WESTERN RAIL SYSTEMS
SPECIAL RUN CAR

PWRS has commissioned Atlas Model Railroad Co. Inc. and Micro-Trains® to produce one (1) Great Northern Alco RS3 Engines, eighteen (18) GN Hoppers plus one (1) GN Caboose, to make this exclusive set.

— Limited Run of 50 Sets —

CLICK HERE FOR

GN Rock Train



Pacific Western Rail Systems

Viewed here in Glacier National Park, near the historic Izaak Walton Inn, Essex, Montana, is the Great Northern Maintenance of Way Ballast Train.

(As pictured on the front cover of the 2013 Great Northern Railway Historical Society calendar. Photo by Phil Webb)

NORTH AMERICAN RAILCAR CORPORATION



Laser Cut Kit of the Famous Izaak Walton Inn

Coming soon, this is a must for anyone modelling the Great Northern in the area of Glacier National Park, and Essex, Montana.



CLICK HERE FOR

Izaak Walton Inn



Model Railroad Hobbyist | September 2016 | #79

YES, IT'S A MODEL

compiled by
DON HANLEY



**Click here for
reader comments**



1. West Side Lumber Co #15 drifts down-grade as the crew returns home after delivering a string of empty log cars to the upper reaches of the line in the high Sierras. The Sn3 Shay and caboose are brass imports. Bill Beverly painted and weathered the caboose using an airbrush. He took the photo on the lumber high line at the Slim Gauge Guild Model Railroad Club in Pasadena, CA.

► **MRH'S MONTHLY PHOTO ALBUM**

YES, IT'S A MODEL | 2



2. Something big must be on the ground for the Kansas City Northern to bring out the Big Hook! The KCN was a fictional railroad on the former Midwest Trains Club layout in Bettendorf, IA.

The crane and its boom car are Tichy Train models with many details added, while the work cars in the background are reworked MDC coaches. The models were built by Mark Schloemer for Midwest Trains owner Buzz Pinnow. After plying the rails of the Midwest Trains layout for many years, the work train is now in the collection of George Malcolm, who shot the photo outdoors on a diorama.



[Click here for reader comments](#)

YES, IT'S A MODEL | 3



3. VIP Pet Foods #4 is spotting a tank car of corn syrup for unloading. Once the tank is in position and the brakes set, the crew will go back and re-spot a boxcar at door 4 to finish unloading it.

Ray O'Neill took the photo on his new exhibition layout "End of the spur," based on a vegetarian pet food factory. The model is a Bachmann Alco S2.



4. Detroit & Toledo Shore Line Extra 22 South is on the Wabash West Detroit branch heading toward Dearoad Yard. The train originated in Durand, MI using trackage rights on the Grand Trunk Western to West Detroit, and then Wabash track rights from West Detroit past the Wabash Rouge River Bridge where it enters home rails and Dearoad Yard. After a brief layover in Dearoad, it will proceed to Lang Yard in Toledo.

The caboose is a modified Walthers GTW 30' caboose. The primary changes were to the cupola roof, addition of truss rods, tool cellar, and new end railings/ladders. Lettering was done with Microscale Railroad Gothic alphabet sets. The track is handlaid code 55 rail mounted on cast urethane rubber ties detailed with tie plates, joint bars, and lots of spikes. David Karkoski took the photo on his layout.

YES, IT'S A MODEL | 6



5. The crew of this SP train has just received a green signal at Rice Hill siding west switch. Splitting the semaphores, the crew will take the train downhill toward Oakland, OR. Publisher Joe Fugate took the photo on his Siskiyou Line set in Southern Oregon in the 1980s.

 [Click here for reader comments](#)

GET PAID FOR YOUR PHOTO

We pay \$40 per photo we publish. If you'd like to get your modeling in our photo feature, just start posting your photos on the MRH website, especially in the Weekly Photo Fun thread created each weekend.

See mrhmag.com/help for more on how to post an image. You need to be an MRH subscriber to post photos to our website, and becoming a subscriber is free, [just fill out this form here](#). ■

Floquil/PollyScale stash running out?



MRH has mapped the old familiar colors to new readily-available acrylic paints.

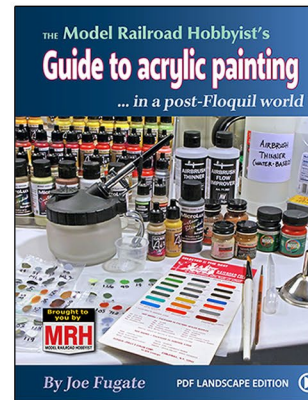

Floquil/PollyScale	Color Name	Model Master	Vintage Model	WOO/Dec	Notes
Primer Gray		MM 4763	VMA 71500	16-12	
Engine Black		MM 4888	ML 30008 VMA 71251	16-01	
Steam Power Black		MM 4976	VMA 71657	16-448	
City Black		MM 4792	VMA 71201	16-047	
Weathered (Charcoal) Black		MM 4760	ML 29023 VMA 71654	16-05	
Reflex Gray		MM 4887 MM 4762	VMA 71245	16-04	
Reflex White		MM 4873	ML 29025 VMA 71491	16-02	
Gring Black		MM 4887	ML 29025 VMA 71655	16-03	
Caboose Red		MM 4887 MM 4831	ML 29025 VMA 71202	16-08	MS 106 4831 with 20% Water/Water's Edge medium to get same glaze.

Floquil/PollyScale	Color Name	Model Master	Vintage Model	WOO/Dec	Notes
Tussock		MM 4650*	VMA 71256	16-15	
Reflex Orange		MM 4682*	VMA 71263	16-09	
Reflex Yellow		MM 4679	VMA 71278	16-10	
Rail Brown		MM 4881	ML 29009 VMA 71249	16-116	
Railroad Tan Brown		MM 4885	ML 29003 VMA 71429	16-487*	Closest match... get VMA 71212 for 16-54
Rail Brown		MM 4838*	ML 29001 VMA 71239	16-103	
Rail		MM 4825	ML 29025 VMA 71257	16-102	
Concrete		MM 4826	VMA 71492*	16-107*	Closest match... get VMA 71212 for 16-51
Apex Concrete		MM 4825	ML 29007 VMA 71493	16-50*	Closest match... get 16-51

MRH Subscribers: Download your FREE Post-Floquil acrylic painting eBook

Want a hardcopy version? Post-Floquil acrylic painting guide: \$15.99 (MRH Store)

BUILD A PHOTOGRAPHIC BACKDROP

BY BILL WILKEN

Use free picture editing software and commercial photo libraries ...

WHEN I DESIGNED MY LAYOUT, I DECIDED THAT I would limit my backdrop to a sky painted on Masonite. Once my scenery was complete – of course – I concluded that I wanted a photographic backdrop. Creating it required overcoming several challenges.

The smallest segment of my backdrop had to span some 40 feet and be integrated with existing scenes including the main

Model Railroad Hobbyist | September 2016 | #79



[Click here for reader comments](#)

street of a small city, a substantial passenger station, round-house, and an industrial area. Second, I was not able to find any lengthy ready-made backdrops that reflected the Mid-Hudson River Valley setting of my railroad. Third, to mount a lengthy pre-made backdrop would require me to work over and around existing scenery, and the Masonite backdrop was beyond arms-length distance.

I had committed the sin of failing to plan. My experience demonstrates that we, as model railroaders, can be saved from our transgressions. Even more important, it shows that creating a professional-looking photographic backdrop does not require great artistic talent. The key ingredients are persistence and willingness to learn a thing or two. A portion of what I was able to create can be seen in four panels of my homemade custom backdrop [1].

Find the photos

Creating a photographic backdrop involves several distinct steps. First, you need to locate a collection of appropriate photographs. I needed good quality stock photos of the Mid-Hudson River Valley, especially photos that showed the Catskill Mountains, bridges across the Hudson River, and old industrial buildings. After much googling, I discovered much of what I needed in CDs of photographs sold by LARC Products of Jamesville, NY.

BUILD A PHOTO BACKDROP | 3

I was happy to find an eight-foot panorama of Poughkeepsie and the Mid-Hudson Bridge. LARC's CDs also include many smaller shots of industrial scenes characteristic of the Mid-Hudson region.

Even after finding these photos, I was a long way from having a period-appropriate and coherent 40-foot backdrop. The panorama of Poughkeepsie showed structures that simply did not exist in the era of my steam and early-diesel railroad. Moreover, the panorama was less than two feet tall. Moreover, the panorama fell far short of the long image that I required. I could create that only by somehow stitching together multiple photos in a smooth and credible sequence.



1. Four panels of my custom photographic backdrop.

BUILD A PHOTO BACKDROP | 4

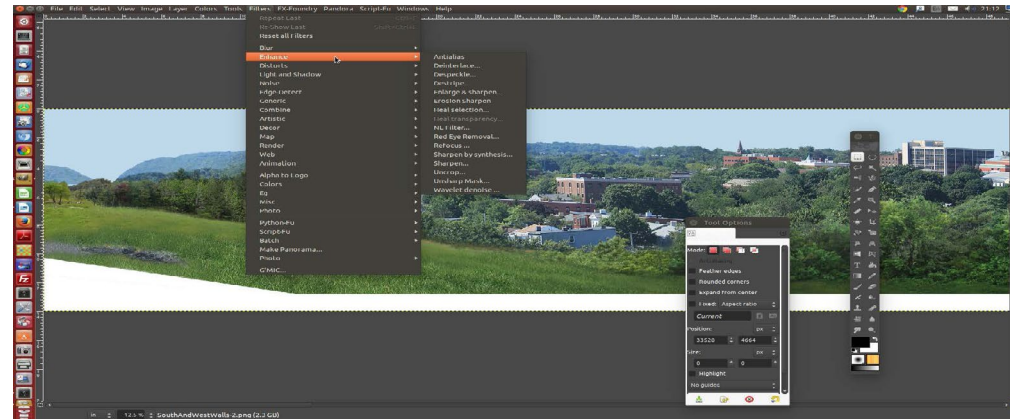

2. A screen shot of the GIMP photographic software. *GIMP*

Free photo software

Enter GIMP (GIMP.org/downloads), a near-clone of Adobe Photoshop software. GIMP can be downloaded and installed without cost on Windows, Mac, and Linux computers.

Like Photoshop, GIMP provides a wealth of tools for manipulating photographs. Images can be enlarged, reduced, trimmed, layered, sharpened, duplicated, blended, and much more. Like many other tools available to model railroaders, learning how to use GIMP skillfully requires time and practice. Fortunately, many excellent free tutorials on the web can make learning relatively straightforward, even for people with little computer software experience. In my case, it took about six months of exploring and experimenting before I was able to achieve adequate proficiency.

Before putting GIMP to work, I had to address two issues. First, the images that I wanted to use ranged widely in scale. While any image can be reduced in scale without adverse consequences,

BUILD A PHOTO BACKDROP | 5

enlarging images often brings loss of crispness. I was concerned especially about my eight-foot panorama of Poughkeepsie and the Mid-Hudson Bridge.

As delivered on one of LARC's CDs, it would have worked nicely on an N scale layout but it was not tall enough for my HO environment. Fortunately, a combination of GIMP's "enlarge and sharpen" filter and its "color curve" tool let me preserve enough of the original image's appearance to permit increasing its height by about 50 percent.

Second, I had to come to terms with the fact that my existing scenery and benchwork depth made it impractical to mount a backdrop printed on a long continuous sheet like those used by most commercial backdrop vendors. I debated using a commercial printer who could produce the backdrop on large format 23.4 x 33.1 inch paper but rejected that approach because of its cost.

At first thought, my Canon MX922 color inkjet printer seemed poorly suited to the task. While it has excellent color fidelity and can print to the edge of 8.5 x 14 inch sheets, I disliked having to join enough sheets to reach the top of my 36-inch-high backdrop "wall." Experience hanging wallpaper told me that the fewer seams, the better.

Blending the sky

As things turned out, I had an eureka discovery that eventually led me to print my backdrop using the Canon inkjet. While examining a single printed page on the backdrop wall, I noticed that the sky color on the page happened to blend perfectly with the color of my original painted sky.

Taking this discovery a step further, I photographed sections of the old painted backdrop and then used the GIMP color picker tool to

BUILD A PHOTO BACKDROP | 6

match the color of any painted sky progressively to each page of the new photographic backdrop. Next, before mounting any page of the printed backdrop, I used an X-Acto knife to trim away all but about one-quarter inch of any sky in the image. Once glued to the backdrop wall, the line between the new printed backdrop and the old painted sky became effectively invisible even when standing immediately in front of my benchwork.

Once these issues were settled, I was able to dive into the task of knitting together numerous photographs into a coherent natural looking panoramic backdrop. My first step was building a crude photographic "storyboard" that overlaid the images that I wanted to use against digital photos of my layout. This process

ADVERTISEMENT

New Product Release
OLD COBBLESTONE SHEETS



MONSTER
modelworks

HO & N SCALES
AVAILABLE

www.monstermodelworks.com

ADVERTISEMENT

Backdrop Junction
Your Stop for Railroad Backdrops

Click Here →

**For the Finest in Custom
Designed backdrop**



www.backdropjunction.com

BUILD A PHOTO BACKDROP | 7

revealed where there were gaps in my array of images and where it would be necessary to make a smooth transition from one image to the next. It also revealed where existing scenery might hide parts of images that I wanted to be seen.

Most perplexing, it became readily apparent that it would be impossible to integrate existing scenery with my panorama of Poughkeepsie. Many buildings shown in the panorama simply would have been in the wrong place. This problem, however, was not a show stopper. I simply rearranged the panorama, basically cutting it in half and moving the west side east and the east side west.

Edit for the right era

Before going further, I had to deal with the fact that some of my most important images contained buildings and structures such as cell phone towers that simply did not exist in the late steam, early diesel era that I model. Like an old Soviet apparatchik, I solved this problem by using GIMP's airbrush and cut-and-paste tools to erase them, replacing them with sky or trees.

Only two tasks in this category were especially challenging. First, I had to repair a rather derelict-looking cement factory so that it

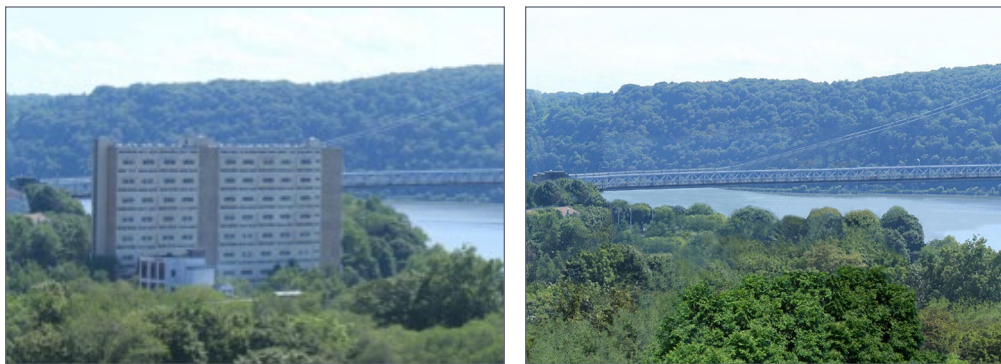

3. Mid-Hudson Bridge before and after photo editing.

BUILD A PHOTO BACKDROP | 8



4. Two of the photos used in the backdrop that are edited and merged to create a common scene with a tree filler.

appeared to be operating. Second, I had to fill in a portion of the Mid-Hudson Bridge that was obscured by a building that was not period-correct.

Next came the task of assembling numerous images into a nicely flowing panorama. I resorted to three tricks. In some places, I created clumps of trees or fields of brush to fill in real or logical gaps between photos. This was a cut and paste operation, but not without some tedious work [4]. Googling the Web for images of trees that were the right height, were regionally-appropriate species, and were free of extraneous content took more time than I would have liked. It usually was necessary to use several of GIMP's tools to refine found tree images. For example, I often had to remove any sky color visible through tree tops and to replace it with transparency that allowed images of yet other trees show through.

Similarly, borrowed tree images often had to be increased or reduced in scale or manipulated to place them in the proper perspective. I discovered rather quickly that it often was possible to use edited tree images in multiple areas of the backdrop.

BUILD A PHOTO BACKDROP | 9

There were a few areas of the backdrop in which covering gaps between images with trees would have been inappropriate. I worked around this problem in two ways. First, I created small fill-in scenes. In one run-down municipal area, I filled in a gap between two buildings with a weed-filled lot bordered with a chain link fence. Nearby, I created a small junk yard by integrating several images of derelict old cars. Once I found the right images, implementing these solutions required little more than learning how to render image backgrounds transparent.

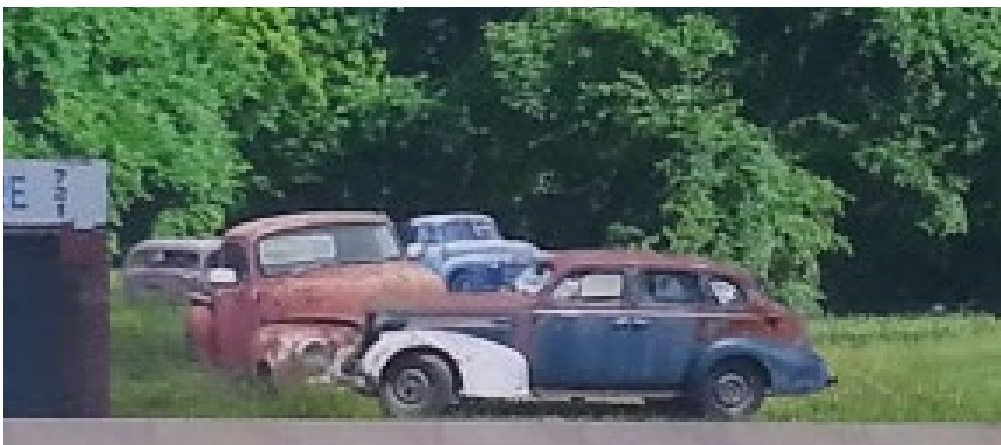

5. Merged photos of cars and trees create a small junked car lot.

BUILD A PHOTO BACKDROP | 10

When no other solution seemed to work, I covered gaps with small changes in foreground scenery, made hills higher, added buildings, or planted trees.

The strategies and tactics that worked for me will not work for everyone. There is no question that some modelers will want their backdrops to include printed cloud-filled skies. At least for those with HO or larger scale layouts, this almost certainly will require either turning to commercial printers or spending a substantial sum for a large format inkjet or laser printer. Similarly, in some cases it may be impossible to find relatively large image libraries like the one that was essential in my case. The joy of building one's own custom backdrop resides in large measure in figuring out how to meet specific or idiosyncratic challenges.

Points to consider

My experience suggests several points that should be taken into account for any do-it-yourself backdrop project.

First, be certain to use a printer that exhibits high color fidelity and that can print to the edges of your paper. Many inkjet and laser printers do a poor job of color rendering. Canon's printers usually produce very good output providing one has the patience to wade through sometimes obtuse or sketchy documentation.

Second, be prepared to use many ink cartridges before you get everything looking the way you want. While every printer manufacturer tries to convince users that it's risky to use anything but their expensive proprietary cartridges, there are some excellent and fairly inexpensive generic products available. I found one vendor on [Amazon.com](https://www.amazon.com) selling generic color cartridges for my Canon printer for less than one-third of what I would have to pay for big-name cartridges at any retailer.

BUILD A PHOTO BACKDROP | 11

Third, print your backdrop on matte photographic paper at the highest possible resolution. While some may disagree, backdrops printed on glossy finishes strike me as obtrusive. It may take some experimentation to find the right matte paper. The absorbency of matte paper is not uniform across manufacturers. Moreover, some manufacturers finish each side of their product differently, which can alter the appearance of printed images considerably.

Last and most important, be patient. Building a quality backdrop requires neither great artistic nor technical skill but there is a very definite learning curve and a need to pay attention to detail. If your instinct tells you something doesn't look right, you're probably correct. Take the time to step back and to figure out what is wrong, fix the problem, and move on to the next step.



[Click here for reader comments](#)

BILL WILKEN

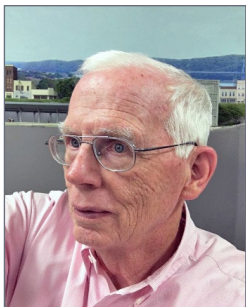

Bill Wilken is a retired corporate executive living in Granville, OH. His dogleg style 20-foot square HO layout was inspired by his childhood memories of the New York Central main line in the Mid-Hudson River Valley during the late 1940s.

BUILD A PHOTO BACKDROP | 12



6. Two shots to show the impact of my backdrop on the overall appearance of the layout.



[Click here for reader comments](#)

THE TOOL SHED

BY JACK BURGESS

Going beyond needle-nose pliers ...

WHILE TWEEZERS ARE MY MOST-USED TOOL

(February 2013 *MRH* mrhpub.com/2013-02-feb/land/#66), I use my pliers and cutters a lot too. My collection of nine pliers includes needle-nose, flat-nose, and round pliers. I also have eight diagonal cutters and flush cutters.

About 40 years ago I purchased a set of three matched pliers (needle-nose, flat, and round) which I still own. They were beautiful, with chromed bodies and red vinyl handles. They seemed perfect.

But those pliers were set aside after a tool-buying spree 10 years ago. They were replaced with a number of Xuron tools. Unlike many hobbyist tools these days, Xuron manufactures high-grade tools for a number of users, including hobbyists, and they are all manufactured in the USA.

The Xuron plier I use the most is their Model 450 Tweezer Nose Plier. [1] They can be purchased directly from Amazon for about \$15 (Xuron does not sell directly). These are traditional

needle-nose pliers with flat jaws. Xuron also has the same plier design with serrated jaws (Model 450S) for \$4 more. However, I have not found a need to have serrated jaws for the type of modeling work that I typically do. Many other Xuron pliers can also be purchased through Amazon.

I also have a Xuron 489 Combination Tip Plier. [2] This plier has one smooth jaw and one round jaw to bend wire into a circle for rings and eye bolts. The tip of the round head is about 5" in diameter in HO scale, meaning they can make an eye bolt a little smaller than 5", but the result is still somewhat large for some projects.

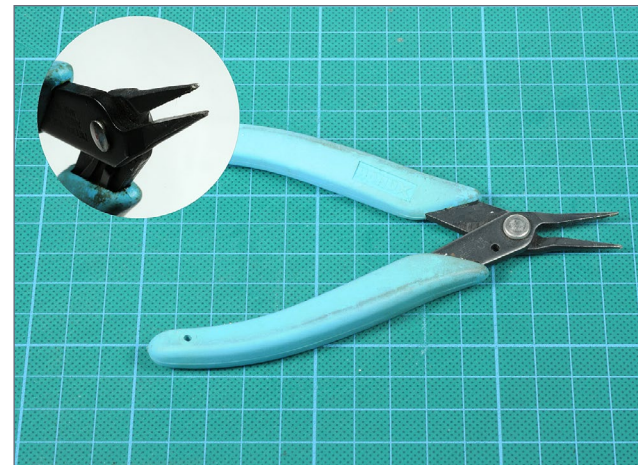

1. This is a Xuron Model 450 Tweezer Nose Plier. Both jaws are flat and the same size. It is a good plier for holding metal parts, bending wire and brass strip, and other basic modeling tasks.

THE TOOL SHED | 3

Sometimes you need to just flatten a piece of sheet brass after cutting it to size. That is a good task for a Xuron 485FN Flat Nose Plier which costs about \$14. Flat-nose pliers have several other applications. For example, I primarily scratchbuild with styrene, and the normal technique for cutting sheet styrene is to cut part-way through it in a series of passes with an X-Acto knife. The piece is then snapped off by simply bending the sheet along the cut line. But if the piece is quite narrow, it can be difficult to hold that narrow section with your fingers to snap it off. The solution is to hold it with a pair of flat-nose pliers to break it. [4] If the piece to be snapped off is long, just work your way down the length of it, bending it section-by-section.

While the Xuron 489 Combination Tip Plier works fine for many projects, I was recently told of another choice for making smaller

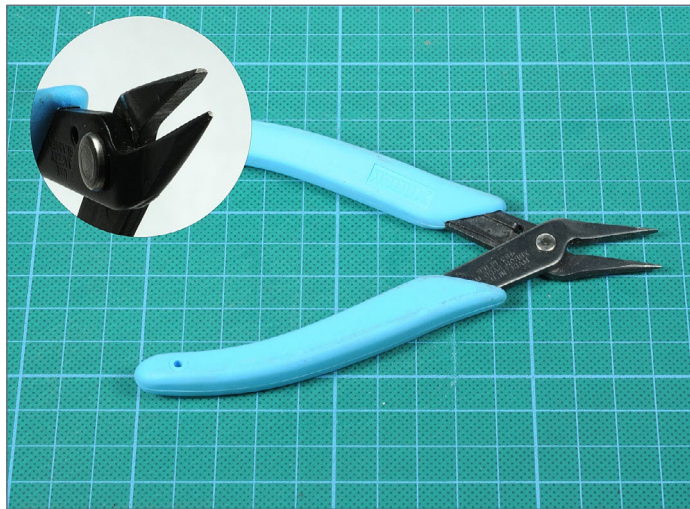

2. The Xuron 489 Combination Tip Plier has one round jaw and one flat jaw. It can be used to make tight bends in brass wire for underbody brake piping details and for bending custom handholds (grab irons)

THE TOOL SHED | 4

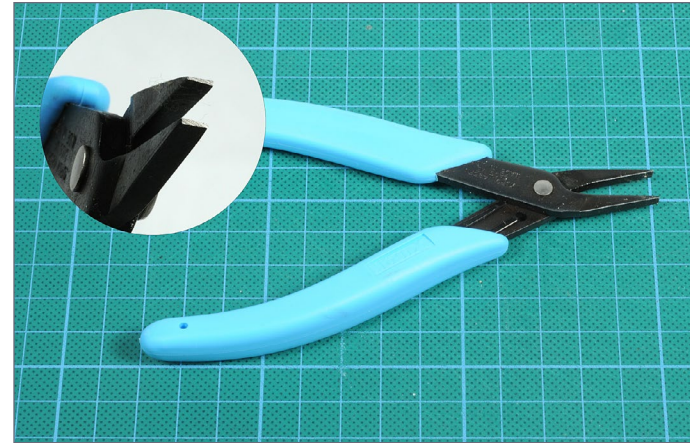

3. As its name suggests, both jaws of the Xuron 485FN Flat Nose Plier are flat. That makes it perfect for removing the curl from a strip of brass cut from a larger sheet or “mashing” brass wire into flat stock.



4. A flat nose plier can also be handy when snapping narrow strips of styrene from a larger sheet.

THE TOOL SHED | 5

rings and eye bolts. That is a round-nose plier sold by Rio Grande, a jewelry supply company (riogrande.com). The round tips of these American-made Swanstrom Round Nose pliers (Item 111302) are just over 3" in diameter in HO scale, a significant advantage over the Xuron pliers for some jobs. [5-6] At \$43 per pair, they are not inexpensive, but are worth the cost for scratchbuilders who need to fabricate small rings and similar items.

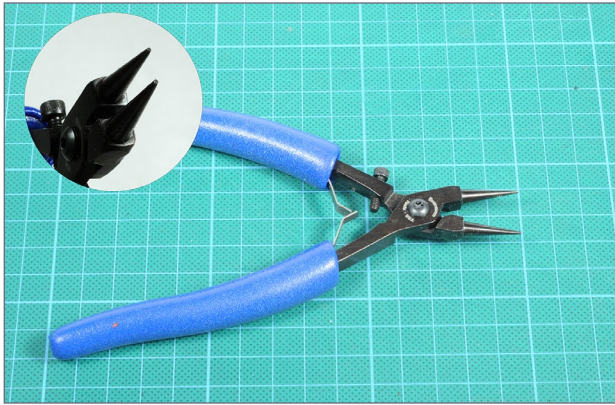

5. These Swanstrom Round Nose Pliers have a smaller tip on their round jaws than the similar Xuron models, which can be worthwhile when forming very small rings from brass wire.

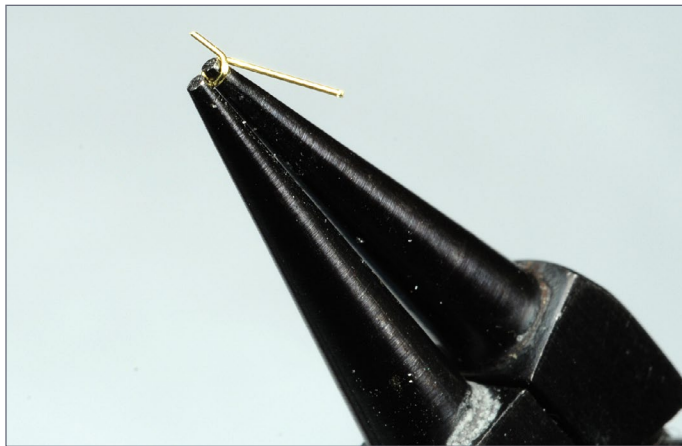

6. Here is an example of making an eye bolt from brass wire using these pliers.

THE TOOL SHED | 6

Keep in mind that a round-nose plier can also be used to make curved bends larger than the round jaws. For example, the main brake pipe on a freight car has an inside diameter of 1¼" and an outside diameter equal to .019" in HO scale. Per the American Association of Railroads (AAR) recommendations, this size pipe can be bent to a radius no tighter than 12", equal to a diameter of 24". Slipping a piece of ¼" brass tubing over one of the plier jaws (equal to 24" in HO scale) makes it easy to make a pair of equal curves in the main brake pipe to get from one side of the center sill to the other side. [7-8]

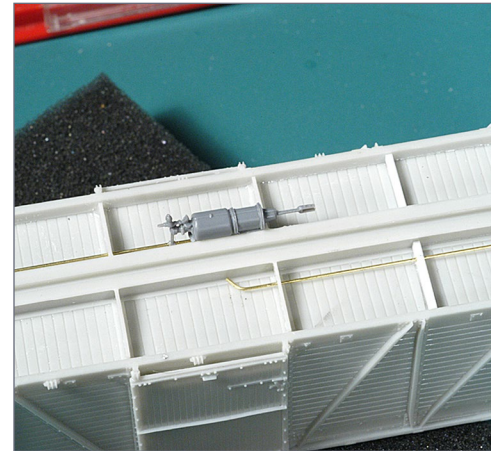

7. The main brake pipe on a freight car typically moves from one side to the other about midway along the center-line of the car. AAR specifications limit the minimum radius for this brake pipe to a 12" radius, and both curves on the prototype would most likely be the same radius. That is easy to do.



8. Slipping a piece of brass tubing over one of the jaws of a round nose plier lets you make specific radius bends in brass wire for the main brake pipe and the branch line pipe.

The Xuron 575 Micro-Bending Plier (about \$15) is another useful tool. [9] This tool is great for making right-angle bends in brass strip, brass wire, and other materials. I use it often to improve the right-angle corners on A-Line sill steps. These steps are great replacements for fragile plastic or resin steps found in resin kits but the bends on the sill steps are too curved as manufactured. It is easy to correct them with these pliers. [10].

Cutters

Xuron has two cutters that I also use for a number of projects. The first is their 410 Micro-Shear Flush Cutter (about \$11). [11] It leaves a nice flush edge which doesn't require additional filing when cutting soft materials such as brass wire. It is also handy when cutting large plastic parts from sprues since it can cut fairly close to the part although not close enough to eliminate additional trimming. More on that later.

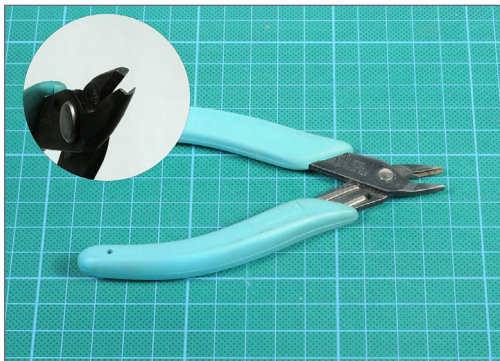

9. The Xuron 575 Micro-Bending Plier has a pair of jaws which form a right-angle. It can be used anytime you need to make a perfect right-angle in brass wire, brass strip, or other materials.

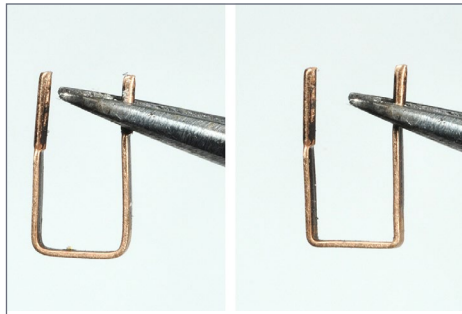

10. On the left is the before A-Line sill step. The right shows the same sill step after using the Xuron Micro-Bending plier to mash both corners to a more prototypical replica.



11. The cutting edges on the Xuron 410A Full Flush Shear are about 3/8" long. It produces a nice flush cut on brass wire .040" and larger.

The second is the Xuron 440 High Precision Scissor (about \$15). [12] This tool has a more limited use. I use mine for cutting thin brass sheets (.010" for example) and cutting photo-etched parts from their frets. The tool incorporates a return spring which makes it easy to make continuous cuts without the need for finger loops. Although I don't use them that often, they do such an excellent job in such instances that I find them worth the cost.

These Xuron tools are all designed to work with small parts where precision and tool quality is required. But sometimes larger, more robust tools are needed.

If you have a need to cut regular steel wire such as music wire, you need a pair of traditional diagonal cutters. These are a standard hardware store item. Keep in mind that if you will be cutting steel music wire, diagonal cutters with long handles will make the job easier.

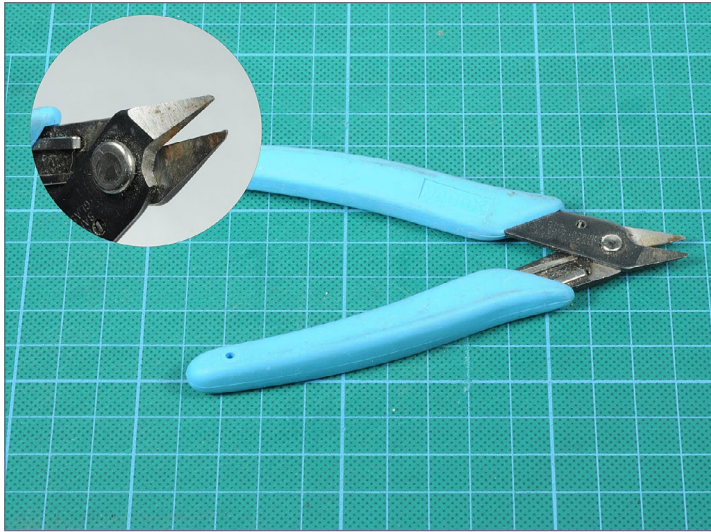

12. These Xuron 440 High Precision Scissors are perfect for cutting thin sheet brass and cutting photo-etched parts free from their fret.



13. The flush side of my economically priced red-handled flush cutters shows what can happen if you use them to cut hard steel wire such as music wire. The jaws of flush cutters are too thin for such hard materials.

If you have ever laid track, whether using flex track or handlaid track, you have most likely purchased a pair of flush rail cutters. If not, you should. Unlike regular diagonal cutters for cutting wire and metal, flush cutters leave one end of the rail square so that no additional filing is needed. I can't remember where I obtained my first pair of flush rail cutters. They were probably economically priced but they still got the job done. They have bright red handles and, with my track-laying days behind me, I tend to reach for them for many wire-cutting tasks, including cutting steel music wire. The condition of their jaws is an obvious warning not to use them for such tasks, even though I obviously have several times. [13].

I have since replaced them with a pair of jewelry-quality American-made flush cutters (Item 111706) by Swanstrom that I also purchased from Rio Grande jewelry supply. [14] At \$50 each, they are relatively expensive for a hand tool, but sometimes I just feel the need to purchase a new tool.

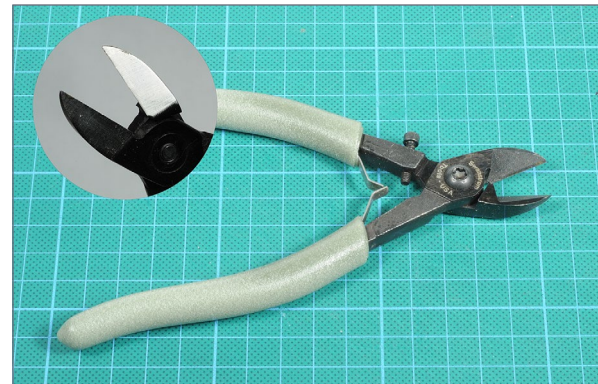

14. I replaced my economically priced flush cutters with these flush cutters from Rio Grande jewelry supply. Their large handles makes it easier to cut thick materials, but their use should still be limited to soft metals such as copper and brass.

THE TOOL SHED | 11

After purchasing them, I tested them by cutting some code 70 rail with both my economically priced flush cutters and my new expensive pair of jewelry-quality flush cutters. To my surprise, both tools left the cut rail with a nice square end. However, recently I needed to flush-cut the ends of some brass 2-56 screws which were in a hard-to-reach location. [15] It required that I cut them using just the tips of my new flush cutters, but it was an easy test and they cut through the screws with little effort. I then tried the same test with my old red-handled flush cutters. However, those old flush cutters couldn't cut through the same brass screws. I might have been successful with more force but I stopped trying before getting to that point since it was not worth the effort to potentially damage the model. The new cutters obviously had a sharper cutting edge and could therefore



15. I fabricated a brass support for an overhanging second-story balcony roof for this model of a two-story hotel, and attached it to the front of the hotel with three 2-56 brass screws which

ran through tapped holes in the brass support. While I have a cordless Dremel tool with a metal cutting blade, I would not have used it in this situation since it would have been too easy to overheat the brass screws or accidentally damage the rest of the building. The Rio Grande flush cutters easily clipped off the excess screw length.

THE TOOL SHED | 12

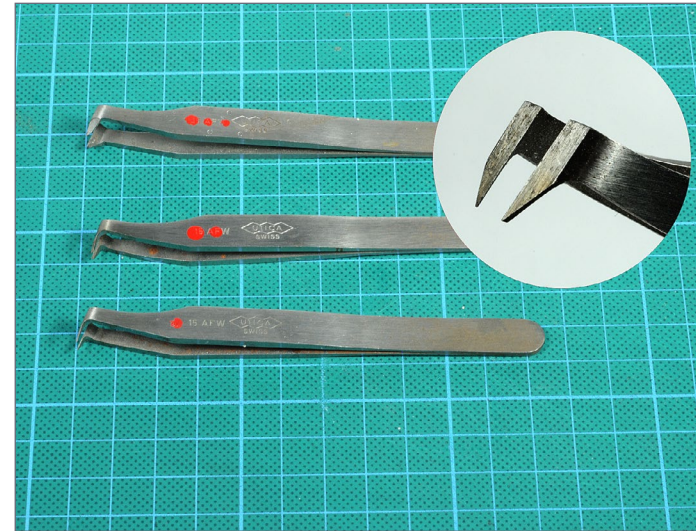

16. These are my three sprue cutters from P-B-L with the fine pair at the bottom with the single red dot of paint. The very thin flush-cutting head of the fine pair is apparent in the close-up view.

cut through the brass screws more easily. Could I have cut off the excess screw length with a Dremel tool fitted with a metal cutting blade? Probably, but I would have needed to be very careful not to heat up the brass around the screw to the point of melting the styrene. I thus concluded that my new, more-expensive flush cutters were worth the price for me.

Tweezer cutters

A cutting tweezer is another worthwhile tool which gained a following after P-B-L advertised their availability in an ad in a 1998 issue of *Narrow Gauge and Short Line Gazette*. Their advertisement called the Swiss-made cutting tweezers “de-spruing nippers” but they have since become to be known simply as “sprue

cutters.” They combine regular flush cutters with tweezers which allow a user to cut styrene parts flush with the casting sprue. This eliminates the need to file away any leftover sprue after cutting a part from a sprue. The P-B-L tools were available in four “styles” – heavy-duty, medium-duty, long-reach, and fine/tight spaces. [16]

To show how sprue cutters work, the “fine/tight spaces” sprue cutter can reach in-between the sprue and a hand brake wheel on a Tichy AB brake set, and cut it free from the sprue. [17] To do that, the jaws need to be very thin. P-B-L owner Bill Peter discovered these tools back in the late 1990s. They were high-quality tools, but he still had to hand-grind each one of them before selling them.



17. The distance between the hand brake wheel on this Tichy AB brake set and the thick portion of the sprue is obvious in this photo. But the fine P-B-L sprue cutter can easily cut the hand brake wheel free.

The original purpose of these sprue cutters was simply to cut plastic parts from a sprue. I don't build plastic freight cars or any structure kits, but resin freight car kits typically include a plastic sprue of brake parts, and these sprue cutters shine at that task. They also make short work of cutting Grandt Line windows and doors from their sprues.

By the time I ordered my sprue cutters from P-B-L, the long-reach ones were sold out. So I bought the other three and I use them a lot. The original prices for these tools ranged from \$13 to \$22 per pair (which would be equivalent to \$25 to \$42 today).

The three sprue cutters look the same unless you look closely at the cutting edges. I therefore marked the fine pair with a single dot of red paint, the medium pair with two dots, and the heavy-duty ones with three dots. But more importantly, I keep them in a vertical tool holder always in the same location so, when I reach for one, I don't need to look at those spots unless they are lying on the workbench rather than upright in the tool holder.

I use the fine sprue cutter only for cutting small plastic parts from a sprue. I use the heavy-duty one for cutting smaller-diameter brass wire since it leaves a nice square end. I haven't yet figured out what to use the medium-duty one for but I had to have it.

Unfortunately, these P-B-L sprue cutters were in limited supply and sold out quickly. Some other model tool suppliers eventually imported copies, but based on reports from others who have purchased such tools, they don't compare to the Swiss-made sprue cutters sold by P-B-L. Many are made in Pakistan, and the cutting edges do not even meet, which will not result in a clean cut edge.

Fortunately, P-B-L is selling sprue cutters or gate cutters once again. They are the same Swiss-made quality and will sell for about

THE TOOL SHED | 15

\$10 more than the original ones back in 1989. P-B-L currently has their PBL-803 Clear Vision Nipper in stock although their PBL-804b, which is even finer, is temporarily out of stock. Check their website occasionally for availability (p-b-l.com).

While primarily intended as sprue cutters, I have found many other uses for these cutters. For example, when I scratchbuild styrene buildings, I always add rafter tails. I cut one end of the scale 2x4s to match the roof angle, but leave the other end long. I then bond them in place to the underside of the roof. As soon as

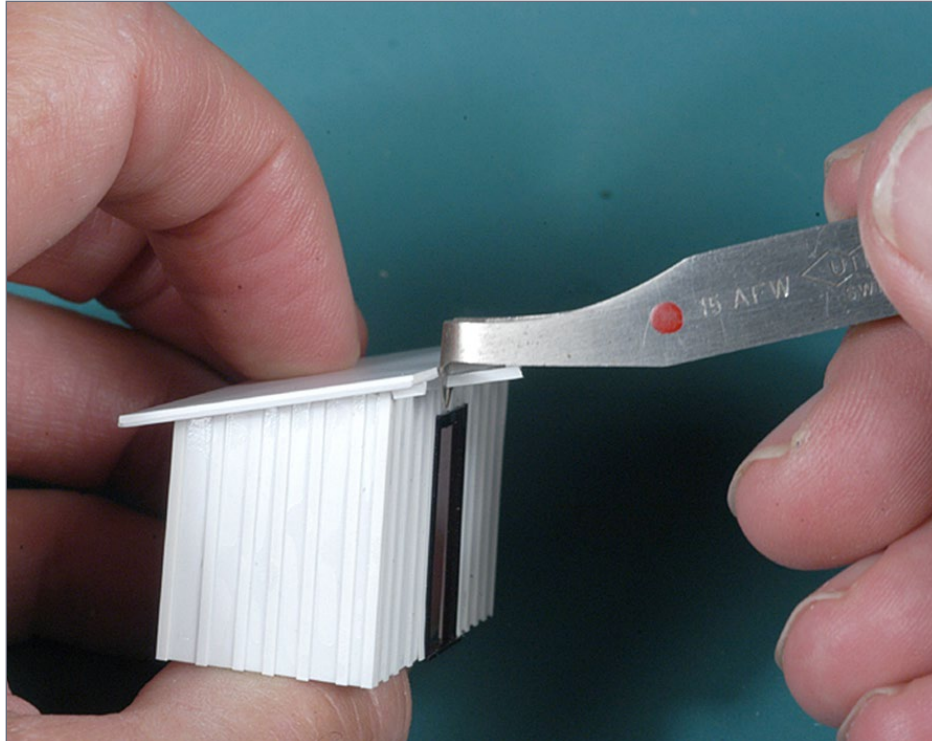

18. Over-length rafter tails were added to this small building and, once dry, were cut to length using a fine P-B-L flush cutter held with the cutting edge parallel to the front of the building.

THE TOOL SHED | 16

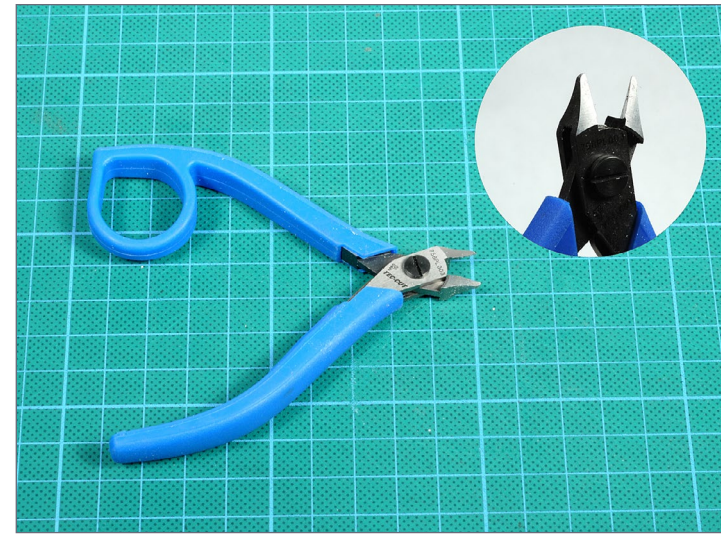

19. Here is a P-B-L miniature flush cutter and a close-up of the flush side of the blades. Although they cannot get into tight spaces, they can be used to trim away the rest of a plastic sprue.

the glue dries, I cut the long end with a sprue cutter held parallel with the side of the building. [18]

P-B-L also sells a very small flush cutter called a miniature flush cutter. While it cannot reach into very tight places, once the part is cut away from the full sprue it will cut it flush from the remainder of the sprue. They are listed under Tools on their website and sell for about \$35 each. [19]

One more tool

Although most likely unfair to readers, I must include another tool given to me by a modeler and close friend about 45 years ago. He worked for Western Electric (a subsidiary of AT&T in those days) maintaining the central office racks of relays and wire connections required in those pre-transistor/pre-router

THE TOOL SHED | 17

days. The tool was a standard Western Bell needle-nose plier [20] but was a very high-quality tool. The jaws were small enough to hold No. 24 gauge wire and were perfectly parallel. He gave it to me when I started hand-laying track, since I could not afford pre-fab track back in those days.

I used that Western Electric needle-nose plier on-and-off for the next 10 years until all the handlaid track and turnouts on my layout were finally completed. My layout was completed in 2011, and my best guess is that I used these pliers to set about 15,000 individual spikes.

A couple of years ago, I built a 3-foot-long diorama with some Proto:48 track and again used these pliers. My friend passed away several years ago, and I still treasure his gift to me.

Disclaimer – I love good tools and don't hesitate to invest in them. ✓



[Click here for reader comments](#)



20. Here is my trusty spike-driving needle nose plier. The 4-inch long handles make it easy to keep a tight grip on a spike, and the small tips let me start a spike right next to the rail web.

In-depth model railroading how-tos on TrainMasters TV!



- Super-detailing
- Expert tools and tips
- Weathering
- Layout design secrets
- Layout construction
- Realistic scenery tricks
- DCC decoder installs
- Operation insights
- Layout tours
- And much, much more!



Take your hobby to a new level with TMTV >>





[Click here for reader comments](#)

Build a C&EI boom car using a LaBelle wood kit ...

WHAT STARTED AS A SEARCH FOR A CHRISTMAS present from one model railroading brother to another ended as a unique kitbash following a prototype railroad kitbash. Follow along as we show how to replicate it.

Even though the environmental mantra “Reduce, reuse, recycle” is fairly modern, railroads have always looked to reduce, reuse, and recycle outdated equipment. It was common to repurpose equipment that could no longer be interchanged to haul supplies between stations, yards, and maintenance facilities. Numerous pictures exist of wooden passenger and box cars serving as temporary stations or storage facilities after the end of their tenure on the rail.

The Chicago & Eastern Illinois was no exception. Most of the C&EI maintenance of way (MOW) equipment was repurposed. This included former coaches and diners that became bunk and kitchen cars, auxiliary water tenders that became water cars,



Model a prototype kitbash of the
C&EI BOOM CAR

BY DAVE FORBES AND DOUG FORBES

out-of-date 40-foot flat cars that hauled trucks and track panels, and in later years, surplus troop cars that would serve as bunk and kitchen cars.

Crane tender A1132

Our subject is C&EI A1132, a crane tender converted from a mail storage car. The C&EI used the A “dash” prefix for its non-revenue equipment. A1132 began its life as mail car #54, built by American Car & Foundry in St. Charles, MO, in 1905. The car hauled mail and express between Chicago and Evansville, IN. When wooden head-end equipment was replaced by steel mail and express cars, this obsolete car was given a second life as a crane tender and assigned to crane A6.

The opening picture of A1132 was taken by C&EI Historical Society cofounder and current treasurer, Rick Schroder, in August of 1966. Rick would often drive by Mervis Recycling in Danville, IL, home of the main C&EI shops, to photograph any company equipment destined for the scrappers torch. The horizontal line through the car number indicates the car is marked for scrap. For more information about the C&EI Historical Society see ceihs.org.

Construction

Follow the pictures and captions on the following pages for a detailed description of the process.

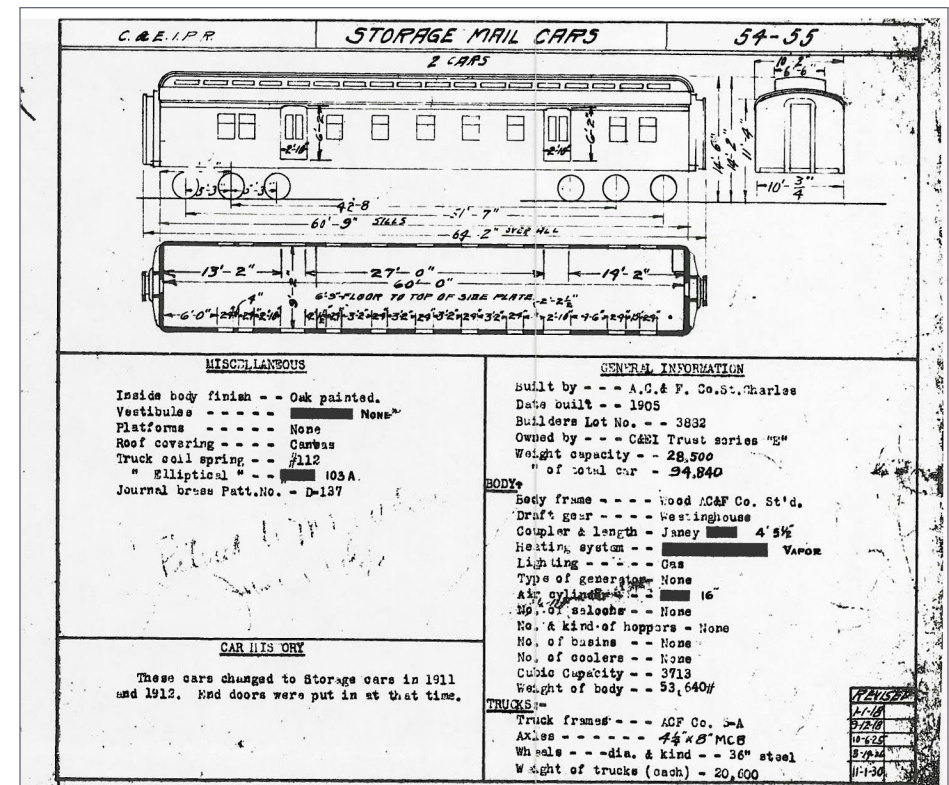

1. Information detailing the specs of this car.

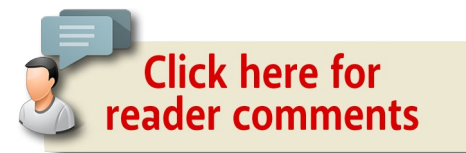

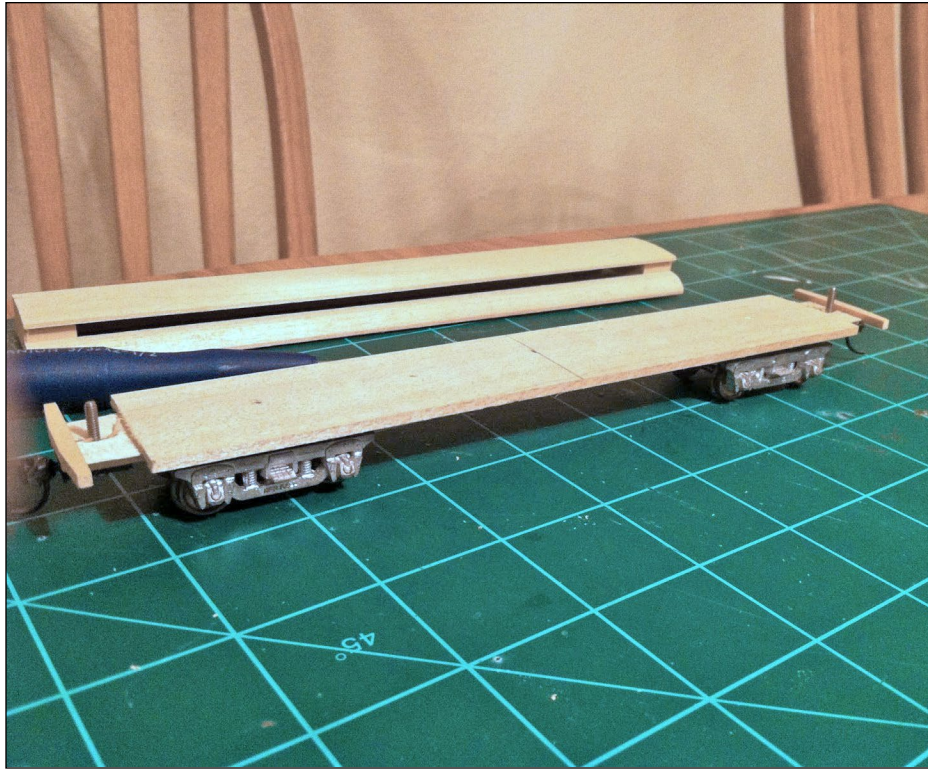

2. The base model for the project is an HO scale 60' wood baggage car kit produced by LaBelle Woodworking. Follow the kit instructions up to adding the bolsters and end beams. Add the Red Ball 4-wheel express passenger trucks and the standard Kadee #5 couplers with a Kadee coupler box to check for coupler height. A Kadee coupler shim may be needed to adjust the coupler to the correct height.

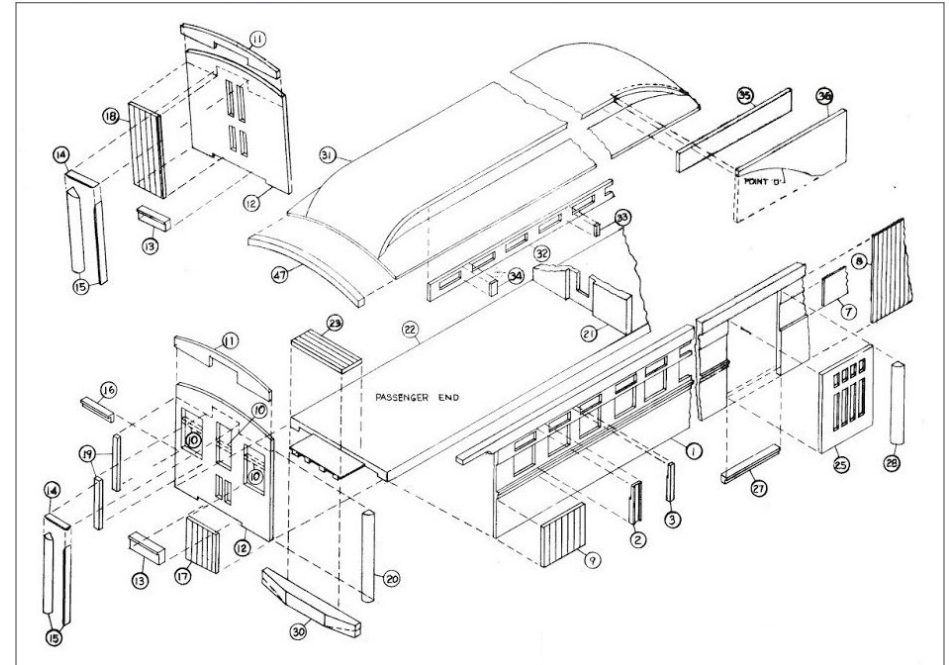

3. Next, add the walls and doors on the ends. This is where the first real departure from the kit instructions takes place. Because this kit is for a baggage car with an open platform, some changes are necessary. The wood construction makes alterations easy. Construct the end walls per the kit instructions. The wall at the end must be moved outward to the end to eliminate the open platform. Cut stripwood to the width of the deck to form the planking. Trim the base of the other wall so that it is the same height as the end wall, then place it on top of the decking.

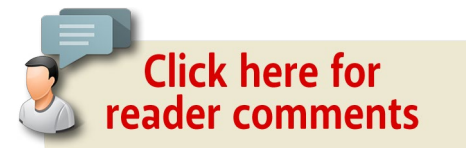

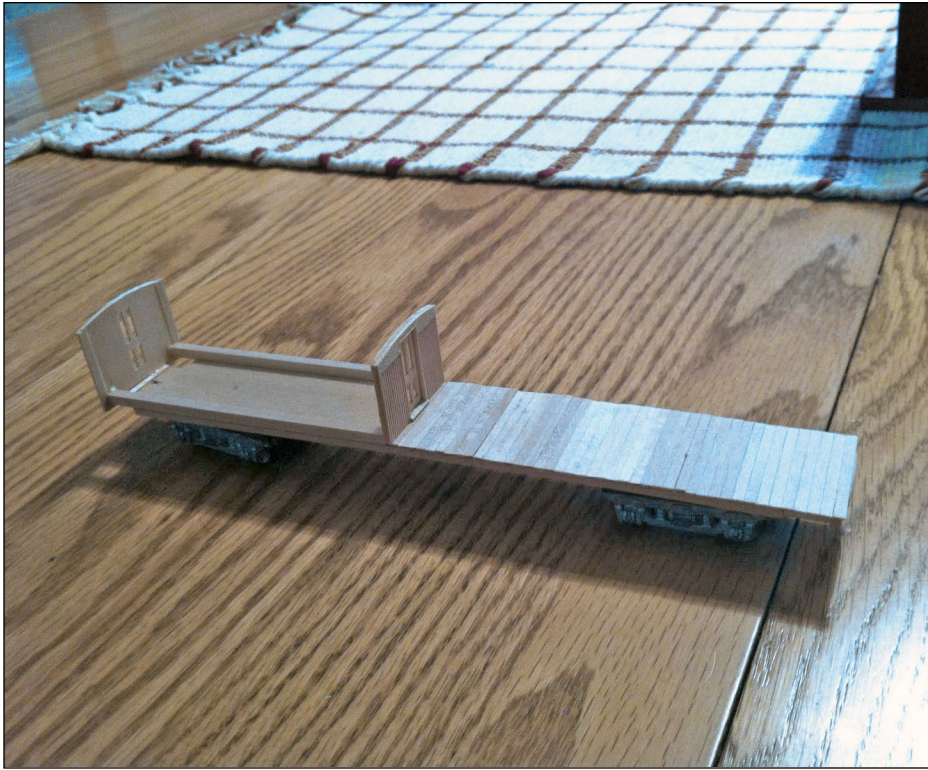

4. This picture from the kit plans shows how the ends are built.

**Want to help keep
MRH free?**

Then *click on ads!*

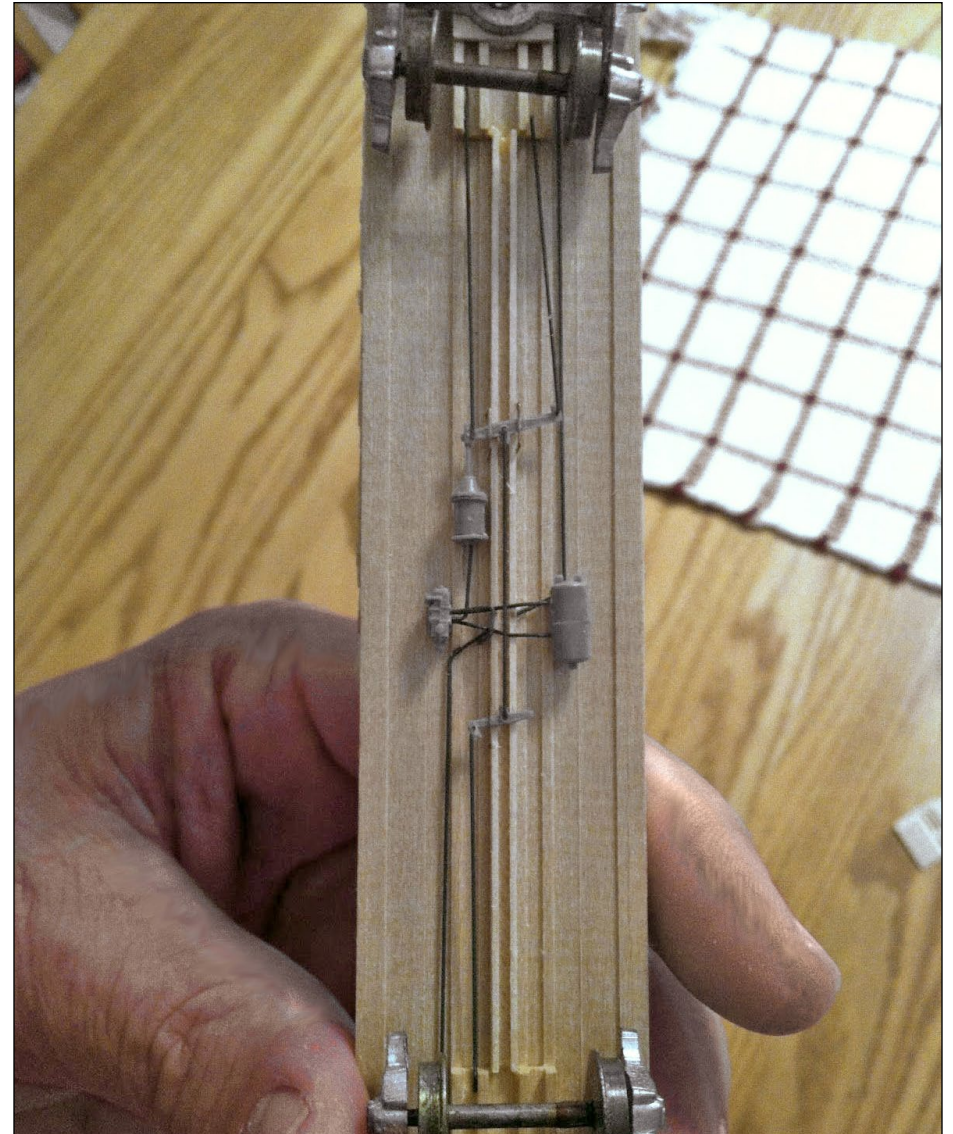

5. Add brake detail using the Tichy AB brake kit. Use soft floral wire for the piping. Because the picture of the boom car [1] is the only one known to exist and there are no known drawings of the brake rigging, we added the details to simulate the prototype as best we could.



6. Place the roof on the model and mark an approximate cut line, trying to match the overhang to that in the prototype photo. Sand the end of the roof to the round contour following the instructions. The stock LaBelle roof is a milled piece with inserts that can be installed to represent transom windows or can be flipped upside down to represent the clerestory windows being blanked out. The piece with the windows for this roof was turned upside down since the prototype doesn't have windows in the roof.

Cut the car sides from Evergreen v-groove siding, again trying to match the overhang at the bottom of the car. The siding supplied in the kit isn't long enough to use. Lay out and cut the window openings as well. Use rubber bands to hold everything together to mock up what it will look like. We made a few adjustments, such as carving a little of the wood from the bottom of the roof where it rested on the middle wall piece.

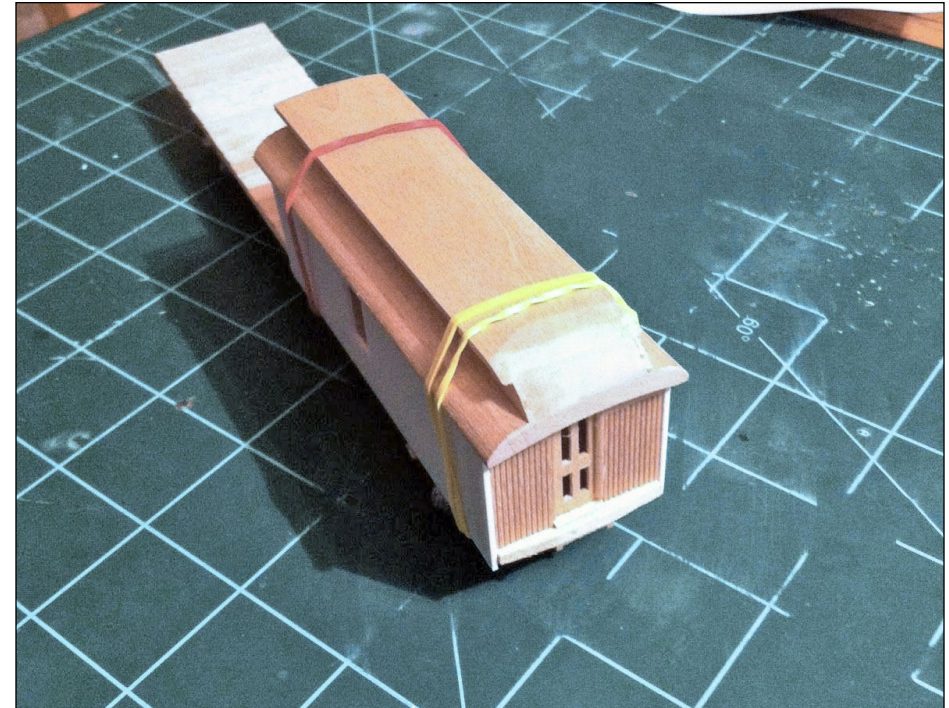

7. Construct the windows using scale 1" x 2" for the vertical parts and 1" x 4" for the bottom sill. Construct the stakes out of scale 6" x 6"s. Using the prototype photo, the stake locations can be spaced equally and the stakes glued to the side sill. The horizontal boards are 2" x 8"s. Add the Tichy nut-bolt-washer castings.



[Click here for reader comments](#)

HOLDER FOR PAINTING PROJECTS

You can see a homemade paint stand in several pictures. It consists of a scrap piece of plywood with a couple of holes drilled in it for two pieces of 2-56 threaded rod. The rod is screwed into the holes for the trucks, and then tightened down on the wood with washers and nuts above and below the wood. Felt pads underneath give it clearance for the nuts. There is also a wide end to the wood base to give it stability and to act like a handle. It works great. Just drill a new hole to match the distance between the truck holes.

This picture shows the paint stand without the car [A]. You can see the 2-56 threaded rod and the nuts at the top where it screws into the truck bolster. It also shows the “handle” on the end.

This picture shows the bottom [B]. The felt pads keep it elevated so the nuts on the bottom of the stand don't touch the surface that it is resting on.

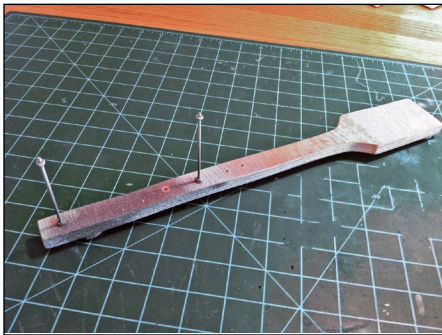

A. Paint stand minus the car.

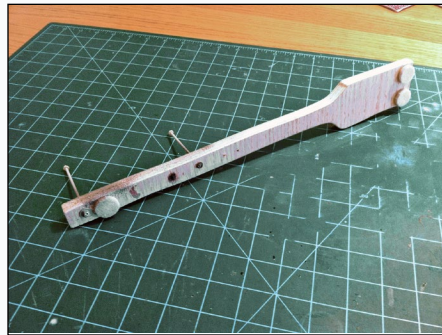

B. Bottom of the paint stand.

Norfolk and Western Historical Society

**Brand New
Video!**

**Feature
length DVD
or Blu-Ray.
The official
story of
611's 2015
restoration**

**to operating condition.
How can I add this great disc
to my collection?**

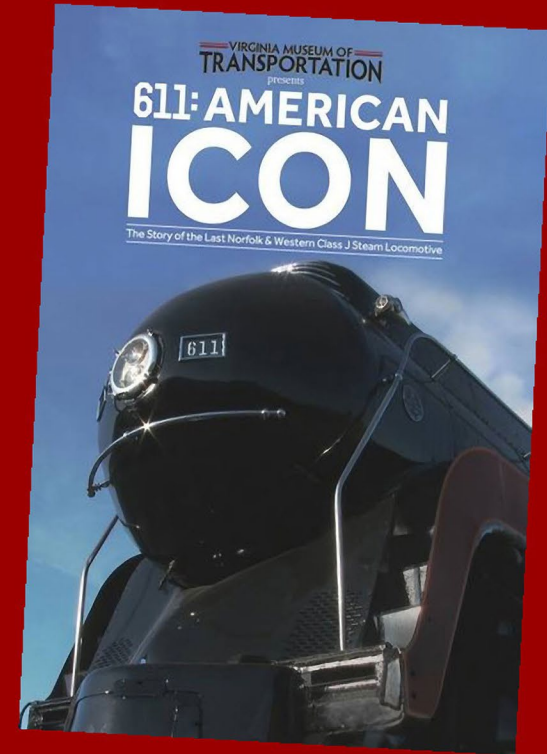

Click Here!

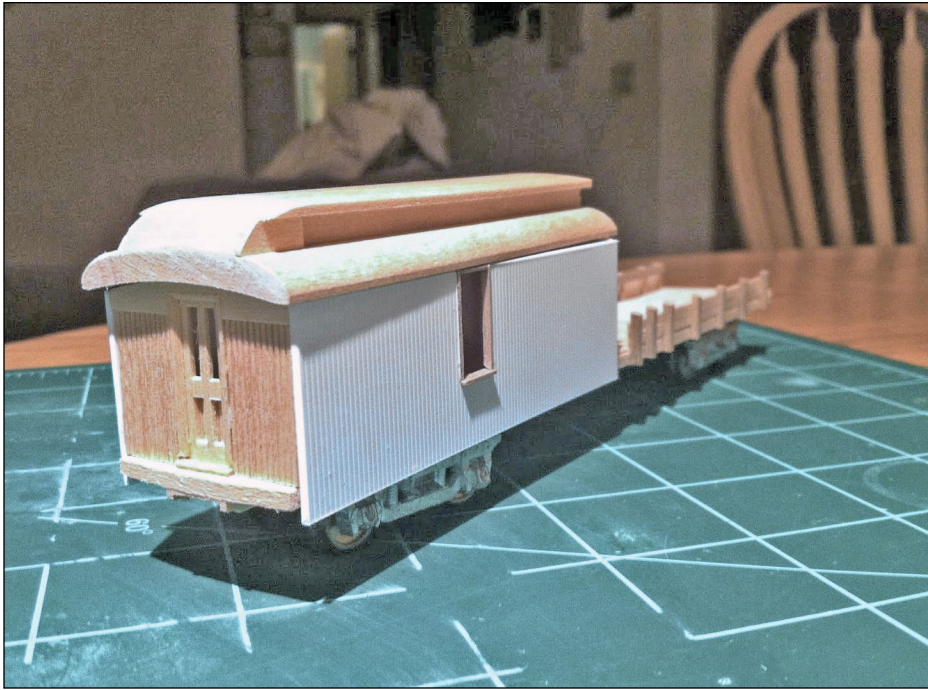

9. Before adding primer, add a few more details. Add drop-step grab irons to the end sills. Cut and fold stake pockets from poster board and glue them into place. Create the center metal step using strip styrene with nut-bolt-washer castings applied. Add grab irons on the sides and ends to match the prototype picture.

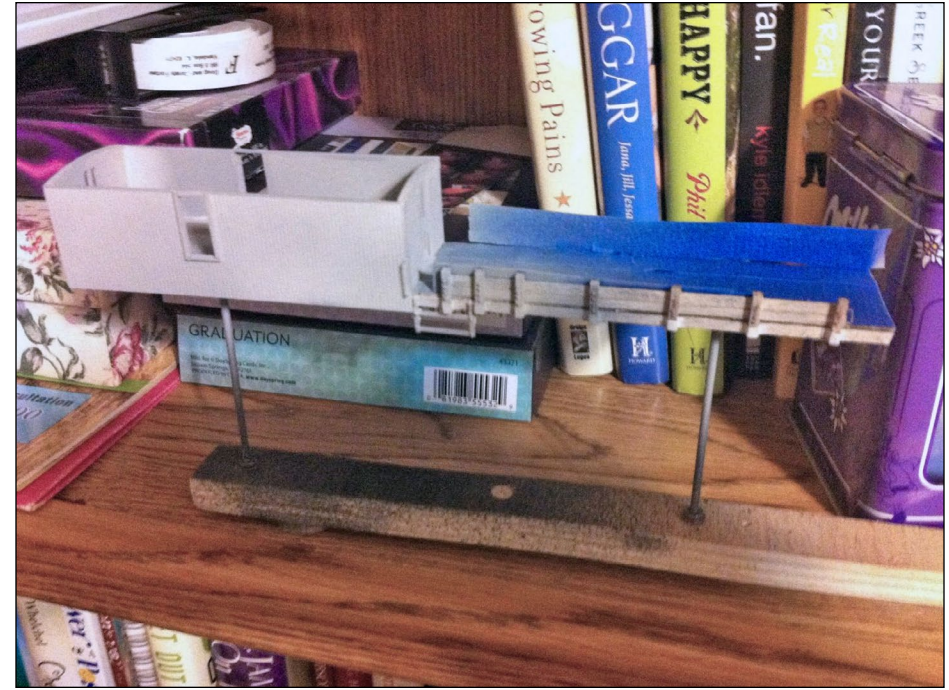

10. Because the prototype picture seems to indicate that the inside was not painted, apply a wash of India ink and alcohol to give the wood a silvery weathered appearance. Allow the wash to dry and mask off the interior with blue painters tape. Apply gray primer to prep the surface for paint. Paint the bottom of the car flat black.



[Click here for reader comments](#)

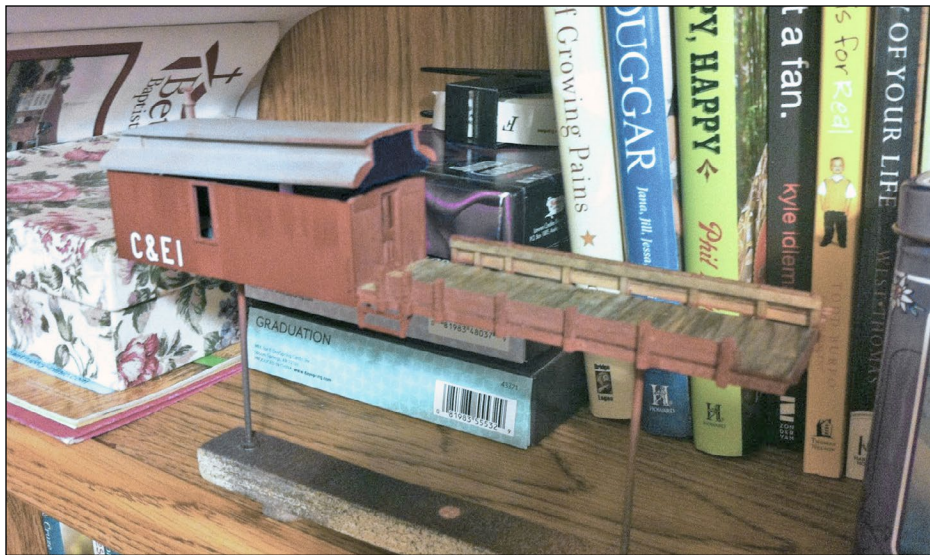
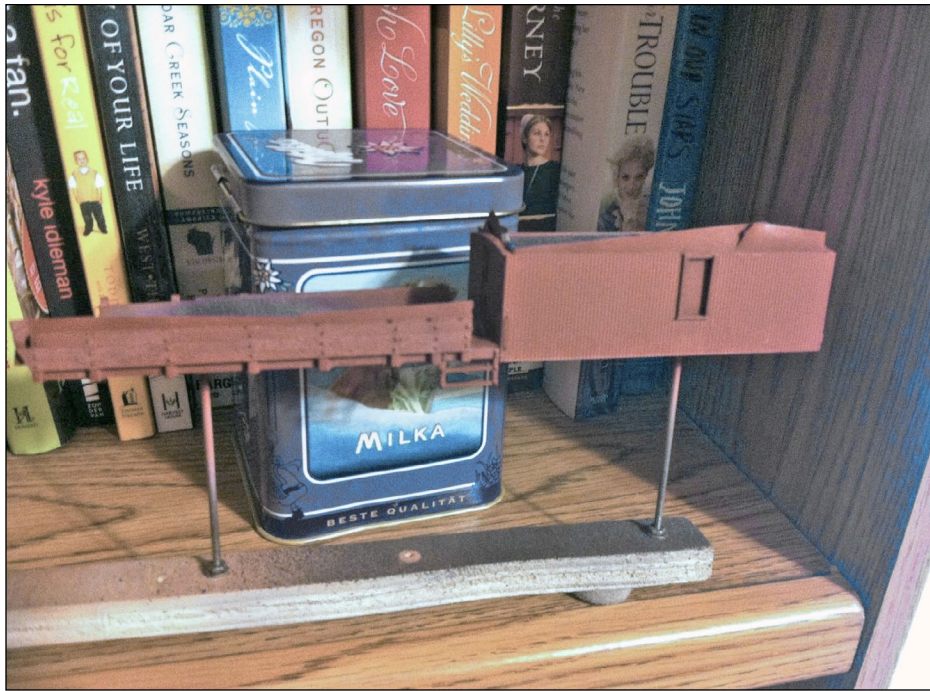

11-12. Mask the end of the roof and spray it flat black.

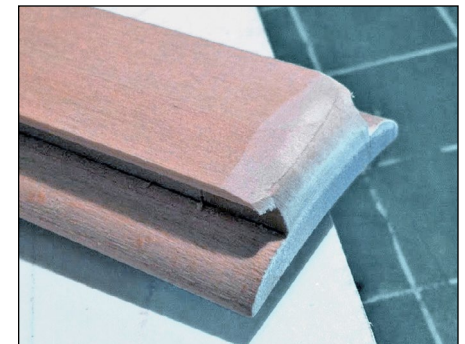
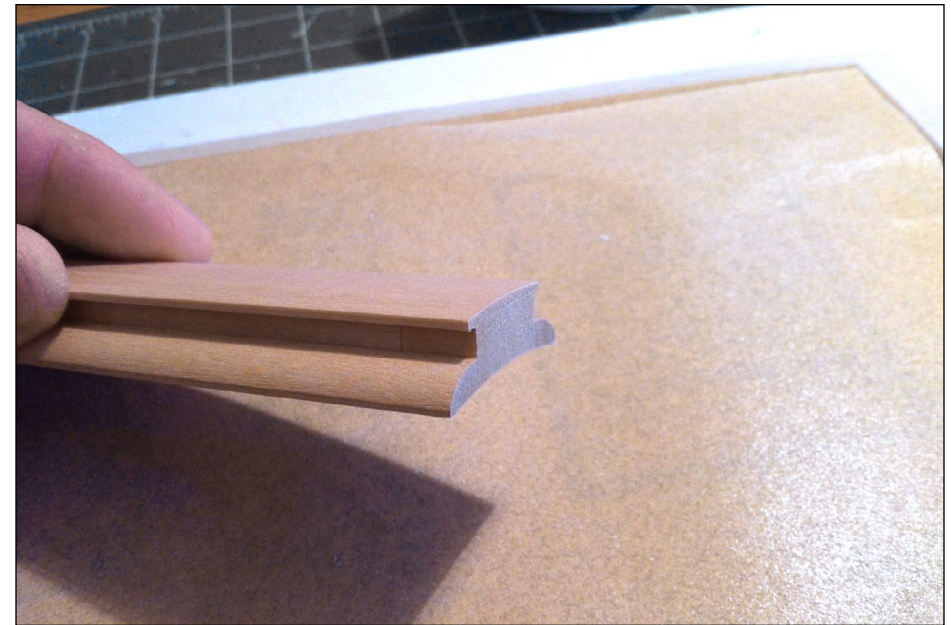

13-15. Round the end of the roof to match the prototype. Use a sanding board to shape the roof. Make the sanding board by taping a sheet of sandpaper to a solid surface. For this project, a piece of laminate countertop was used to mount the sandpaper.

Shape the roof by running the roof piece over the sandpaper. Basswood is very soft and even with a fine grit sandpaper the desired shape of the roof will be achieved quickly.



16. The next step is to represent the tarpaper roof. This type of roof was common on wood passenger cars. Use tissue paper to represent a tarpaper roof. Cut strips with a straight-edge and a knife with a sharp blade. Make several passes so the tissue paper doesn't tear.

 [Click here for reader comments](#)

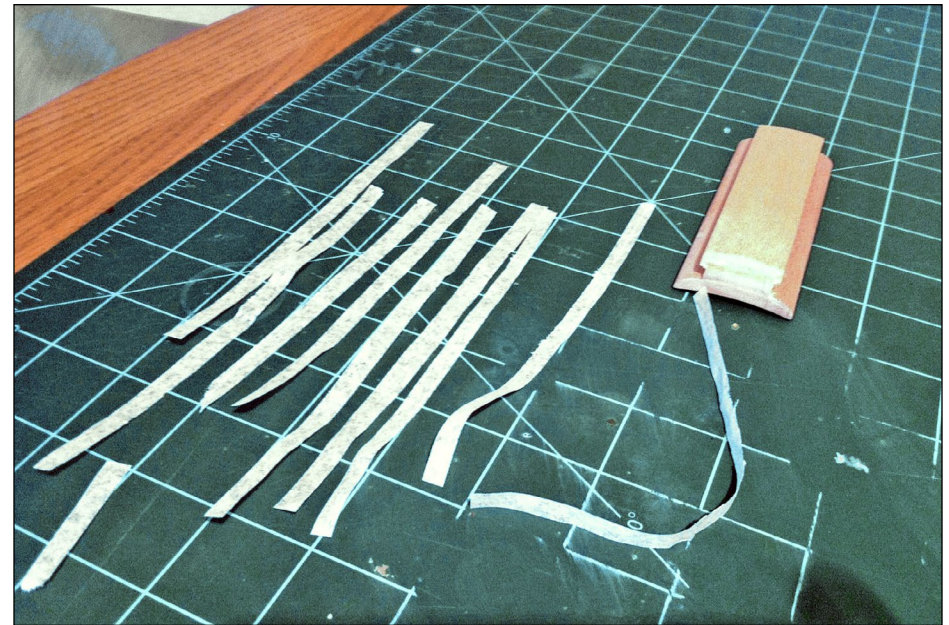

17-18. Next, apply a layer of thinned white glue to the roof surface to be covered. For this application a mix of 75% glue to 25% water was used. The glue shouldn't be so runny as to run off the roof.

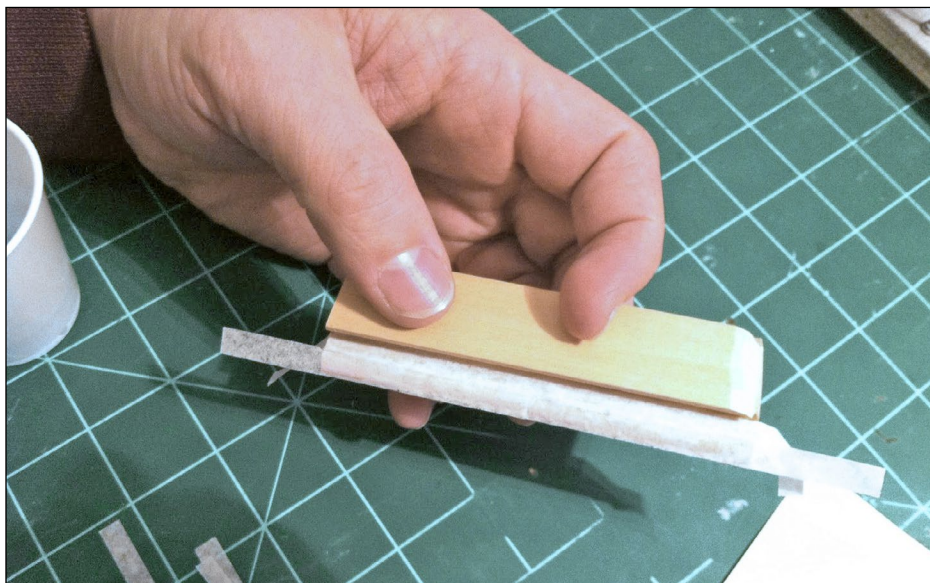

19-20. Apply the tissue paper strips and overlap them slightly to show the seams of the tarpaper roof. After one section is finished, apply another thin layer of glue to ensure the tissue paper will adhere to the roof.



21-22. At this point the roof is almost complete. Apply a final coat of glue to ensure every seam is glued into place. Use a throwaway paint brush for this step.



23. The final step of the tarpaper roof is to cut the excess tissue from the sides and ends of the roof. This should be as easy as the glue solution will have penetrated the overlapping tissue paper causing it to stiffen, making it an easy task to cut off the excess.

 [Click here for reader comments](#)



24. The roof is ready to be painted. For this application a rattle can of flat black is used.



25. The finished roof, minus some weathering, shows the effect of the tarpaper roof. The overlap seams make a nice effect on the finished roof. The prototype picture shows the roof in a state of disrepair. However, the model is intended to be an in-service car and therefore we will not destroy our new roof!



26-27. This picture shows the model on track to see how it performs on curves and through switches.



28. The next step is to apply the decals. The Chicago & Eastern Illinois Historical Society offers a caboose decal sheet that can be used to letter many C&EI models. An alphabet set will provide the missing lettering.

The model is decaled using traditional decaling techniques. First it is given a coat of Testors clear gloss to provide a smooth surface to receive the decals. Cut the decals from the sheet using a hobby knife with a sharp blade and a straight edge. Soak the decals in a dark container so that the white decal shows up against the dark lid.

After the decal backing film is soaked and falls away from the decal, use tweezers to place the decal on the model. I use a cosmetic makeup sponge to blot water from the decal and help seat it onto the model.



29-30. The finished car.



[Click here for reader comments](#)

BILL OF MATERIALS

- LaBelle HO14 18883 Open Platform baggage car kit (60')
- Evergreen 4040 V-groove siding, 0.040" spacing
- various strip styrene
- various stripwood
- Tichy Train Group 3013 AB brake detail
- Tichy Train Group 8142 nut-bolt-washer castings
- Red Ball 4-wheel express passenger trucks
- Kadee #5 couplers
- C&E1 Historical Society caboose decals
- Microscale roman white lettering
- tissue paper
- A-Line drop step grab irons
- Scalecoat Box Car Red paint.

DOUG AND DAVE FORBES



Doug and Dave are twin brothers who grew up with HO trains as a hobby, and continue to enjoy building and running them. Both are high school teachers; Doug teaches science and Dave teaches math. They model rival railroads. Doug models the Illinois Central and Dave models the Chicago & Eastern Illinois.



[Click here for reader comments](#)

To build a painting handle like I show here will only cost a couple of dollars and it is simplicity itself to build.

Parts List:

- 1 x 6" screwdriver
- 1 x 12" length of 5/16" threaded rod

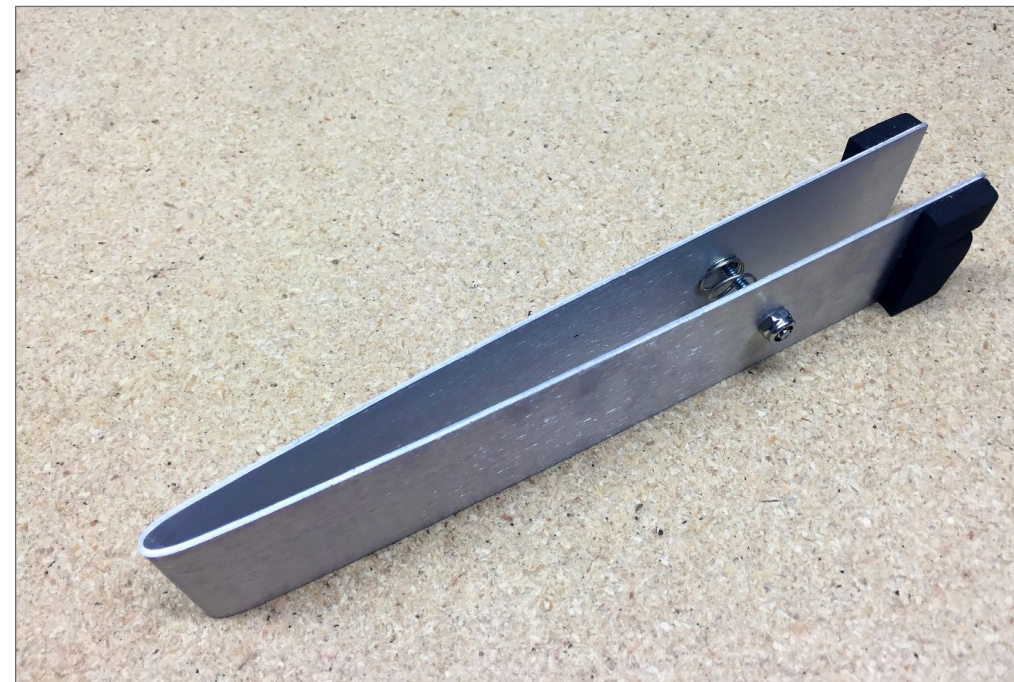

1. Painting handle by GB Engineering works perfectly for boxcars and similar but is not much good for other types of rolling stock.



Build a ROLLING STOCK PAINTING HANDLE

BY GRAEME NITZ

A versatile painting handle for less ...

RECENTLY AFTER MUCH PROCRASTINATION I have decided to start weathering my large collection of HO rolling stock. I had purchased a spring loaded painting handle from GB Engineering [1] which works very well for boxcars and similar but is not suitable for flat cars, gondolas, hoppers, covered hoppers, or tank cars.

I decided to make myself something suitable for these other types of rolling stock. After some thought and looking through what I had in my workshop parts bins, I came up with a plan.

ROLLING STOCK PAINTING HANDLE | 3

- 6 x 5/16" nuts or wingnuts
- 2 x medium screw eyes (Ace #51562)
- 1 x terminal insulated 1/4"-5/16" stud ring 4AWG (Ace #3205911)
- 2 x large alligator clips

Tools Required:

- Hammer
- Wrenches
- Soldering iron and solder or epoxy

Assembling the paint holder

I'll describe how I build my holder. Feel free to customize the design to your own needs or for the materials you have at hand.



2. The parts required to build the Mark I version of the Painting Handle. The Mark II version has 4 of the nuts replaced with wingnuts.

ROLLING STOCK PAINTING HANDLE | 4

Assembly is very easy.

Step 1: Insert the screwdriver in the terminal and hammer the terminal in tight around the shaft.

Step 2: Solder the alligator clips to the screw eyes. Align the clips to the loop on the screw eyes so that they open in the same plane as the loop. If you don't like to solder then you could probably do the same job with an epoxy glue.

Step 3: Run a nut to the middle of the threaded rod. Loop the screwdriver/insulator combination on the rod and run another nut up to it and tighten.

Step 4: Repeat Step 3 with the screw eye/alligator clip combinations adjusted to suit the spacing of your selected item of rollingstock.

Done!

This is not quite a five-minute job, but almost.

The clips can either be clipped to a frame member or to the truck mounting screws. They hold the cars quite strongly, even with heavily weighted cars like mine.

You can hold the car at an angle to allow spraying the under-frame and rotate it easily to get to all directions. When spraying, I push a paper towel down over the alligator clips to cover the threaded rod and wear disposable gloves. Don't forget your face mask!

After having used this tool, I am very pleased with it and I plan to build two more – plus a stand – to hold the tools while the paint is drying.

I am sure you will find the tool useful too!

ROLLING STOCK PAINTING HANDLE | 5

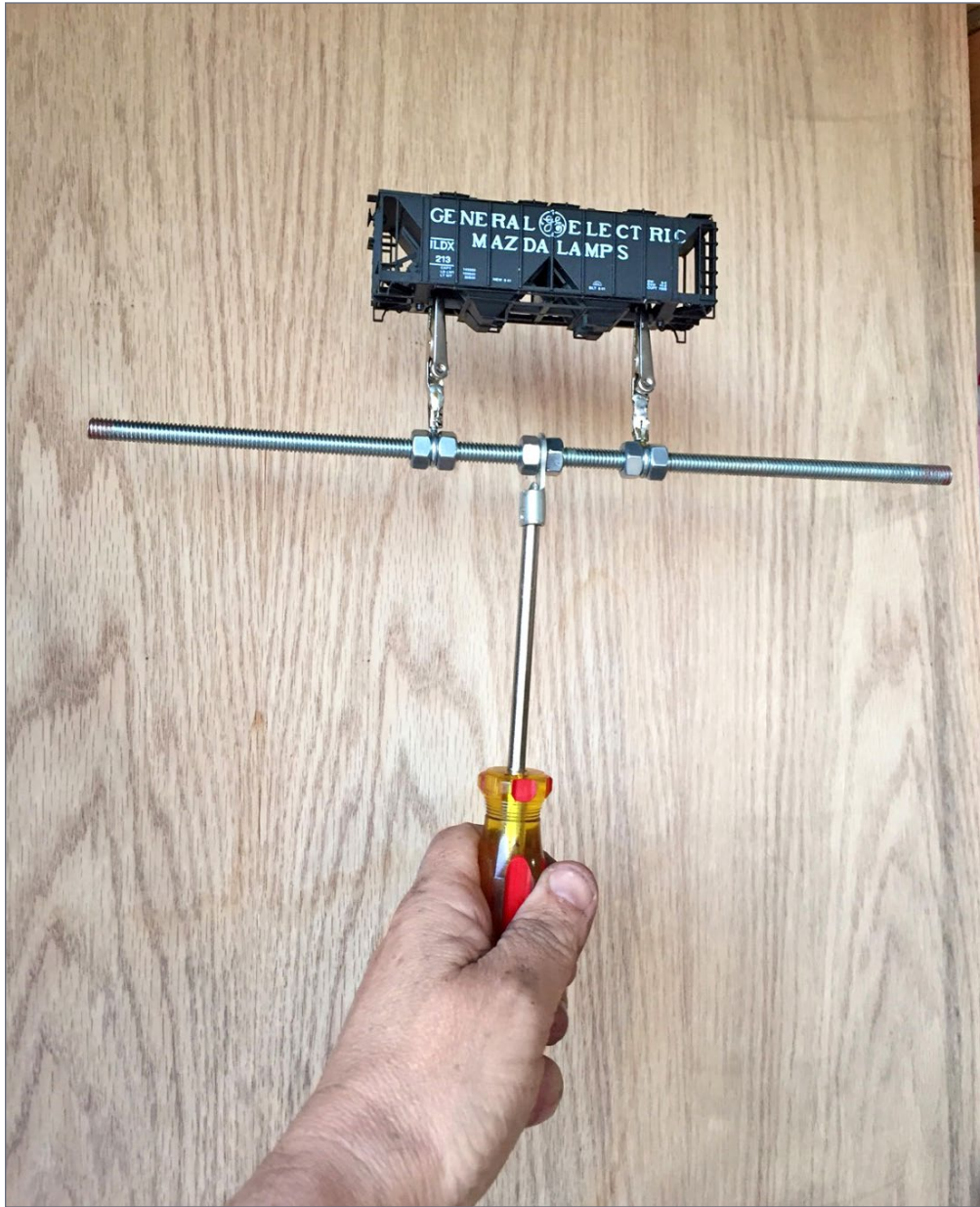

3. The completed painting handle with a Bowser two-bay covered hopper.

ROLLING STOCK PAINTING HANDLE | 6



4. Close-up of a Roundhouse hopper mounted on the painting handle.



5. After using the handle, I made a modification. For my Mark II version, I added wing nuts to make it easier and quicker to adjust the spacing. It's shown here with an E&B Valley 65-foot mill gondola. ✓



[Click here for reader comments](#)

GRAEME NITZ



Graeme is originally from Melbourne, Australia and now lives in Owasso, OK. He has been into model railroading since he received a three-rail tinplate Hornby set from Santa Claus at age 5. He got into serious modeling after joining the Australian Model Railroad Association, Victorian Branch at 12 and sold the “toy” trains to switch to N scale. This lasted a couple of years when he switched back to HO after being dissatisfied with the poor running N scale locomotives (this was the ‘70s!).

A longtime fan of the Pennsylvania Railroad he at present does not have a layout but participates in the very active Tulsa area operations group. He loves running a local train with lots of switching.

In the past Graeme has modeled in other scales and gauges including Swiss meter gauge in HOm, Austrian 750mm gauge in Oe (On30) and Victorian Railways 2’6” gauge in On30. He also is an avid railfan and is regularly out photographing the prototype trains.

Graeme has been married to Janice for 15 years and has two adopted daughters, Heather and Kaitlyn. Graeme was a technician for Telecom Australia for 18 years and then ran his own business “Rail Transport Models” for 10 years which was a distribution company for U.S.-prototype models in the Australian market. After moving to the USA he joined the Postal Service where he is an electronics technician and maintains mail sorting machines.

Bowser

New Product Announcement: N Scale GLa Hopper Cars
 Ready to Run. Features: Crisp details and sharp painting and printing. Roller bearing trucks with Fox Valley Models metal wheels and body mounted knuckle couplers.
 \$19.95 each



Arriving in August!!

HO VO1000 Locomotives

Alaska, ATSF, CB&Q, Frisco,
 NC&StL, NP, PAcific Lumber Co.,
 PRR, Reading, SP, & SSW Cotton
 Belt

DC Version \$199.95
 Sound Version \$299.95



Arriving in September!!

HO F30a Flat Cars

Lehigh Valley, Conrail, PRR, & UP
 \$23.95



N Scale N5c Caboose

PRR, PC, & Conrail
 Without Antenna \$24.95
 with Antenna \$32.95

HO 53' Roadrailer
 TC, Schneider, & Swift
 \$25.95



HO H30 Covered Hopper Cars

PC, & PRR,
 \$29.95



Click here to check out the details for these and other great
Bowser Products

Model Railroad Hobbyist | September 2016 | #79

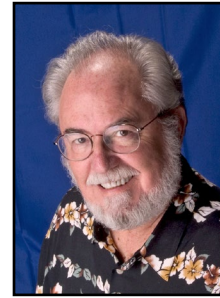

SEPTEMBER NEWS

column

RICHARD BALE and JEFF SHULTZ



Click here for
 reader comments

Caboose Hobbies to close

The largest model railroad store in the world will close its doors for good on September 25, 2016. Caboose Hobbies of Denver, CO, considered by many to be one of the premier retail dealers of equipment and supplies for model railroad hobbyists, has lost its lease and has been unsuccessful in finding a satisfactory new location.

Earlier this summer owner Duane Miller announced that the business would be moving from its Broadway location, its home since 1981. He hoped to announce a new location without delay, but Miller said that finding a suitable site proved to be difficult. After reassessing all circumstances, Miller, who began working at the store as a teenager more than 50 years ago, decided that he and his wife, Joanna, were ready for retirement.

Miller said that all pre-order reservations remain in effect and will be fulfilled by another, as yet unnamed, hobby company. He

► THE LATEST MODEL RAILROAD PRODUCTS, NEWS & EVENTS

said that instructions have been sent to the owners of consignment models still on hand at the Broadway store. In a final note, Miller urged anyone holding a Caboose Hobbies Gift Card to use the remaining balance before September 25th.

Caboose Hobbies was established in 1951 when Miller's father-in-law, Glenn Brazelton, purchased Hobby House. After a few years Brazelton focused exclusively on model train equipment and supplies and changed the name to Caboose Hobbies ...

Jerry Williams in Hall of Fame



Jerry Williams (center), founder of Williams Reproductions Limited, was recently inducted into the Model Railroad Hall of Fame. Presenting the award is Larry Harrington of Bachmann (left), and

Ken Silvestri of Broadway Limited. After the Lionel Corporation sold the rights to their name to General Mills in 1969, Jerry Williams acquired some of the original Lionel tooling and began to reproduce tinplate favorites under the name of Williams Reproductions. In the 1980s Williams sold the Lionel tooling to MTH Electric Trains and shifted his focus to O scale, including 3-rail. Upon his retirement in 2007, Jerry Williams sold his company to Kader, a major Chinese manufacturer of model railroad products and the parent company of Bachmann Trains. The O scale product line is currently marketed under the brand name of Williams by Bachmann. Jerry Williams is given much of the credit for reestablishing O scale and O scale 3-rail as a viable segment of the hobby ...

Boulder Valley Models Closes

Boulder Valley Models, a producer of On30 cast resin kits, has discontinued all operations. Known for its sometimes whimsical critters, the firm's product line included steam, diesel, and rail-car bodies designed to mount on powered chassis and running gear such as those made by Bachmann. Freight and passenger equipment and a selection of detail parts were also offered by Boulder Valley Models. The firm was established in 1997 by Dallas Mallerich who has recently joined the management staff at Model Train Stuff, a division of M.B. Klein. Additional details are available at bouldervalleymodels.com and modeltrainstuff.com ...

Athearn Seeking Prototype Photos

Athearn is looking for photos of the roof and hatches of certain ACF 4600 covered hoppers for a future Genesis series model. They are especially in need of detailed top photos of BN series 455800-455999 and B&O Chessie System cars numbered 606000-606439. Anyone with quality photos should contact Tom Bacarella at tba-carella@athearn.com ...

NEW CLUB CARS



The NMRA's Cincinnati Division Division 7 is selling kits for two versions of Virginian & Ohio 40-foot plug-door boxcars. The HO scale models replicate cars used on

W. Allen McClelland's famous V&O model railroad. The custom kits are manufactured by Accurail and include Bettendorf-style

trucks, Ajax brake wheels, AB brakes, and Accumate compatible couplers. For more information, including ordering instructions, visit cincy-div7.org/projects.html.

NEW PRODUCTS FOR ALL SCALES



New scenic products available from **Coastmans** include Green Branches, a foliage material for use with the firms' cedar and bamboo tapered model tree trunks. The new foliage replicates the look of undergrowth and needles. Also new are logs with each end drilled about one inch deep, leaving just a thin edge that has the appearance of bark. For additional information contact Roger Rasmussen at coastmans@gmail.com.

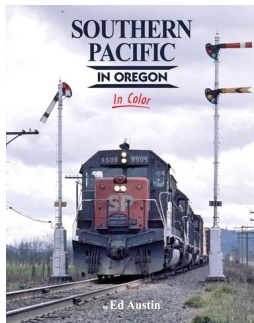

Under Milwaukee Wires by Bill Marvel, *Trackside Along the B&O 1957-1958*, and *Delaware Steam* by Chuck Yungkurth. For additional information visit morningsunbooks.com.

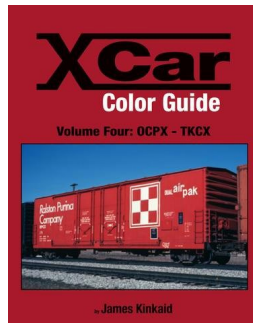

Morning Sun Books has released several new publications including *Southern Pacific in Oregon* by Ed Austin, *Conrail Central Region* by Stephen Timko, *X Car Color Guide OCPX -TKCX* by James Kinkaid,

NJ International is selling a Random Lighting Circuit that can control up to six LEDs. The device simulates the random on and off of lights in residences and commercial buildings. A 9-12 volt AC or DC transformer at a minimum rating of 100ma is required. For additional information visit njinternational.com.

O SCALE PRODUCT NEWS

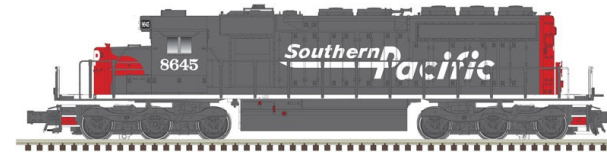

Atlas O plans to release its EMD SD40 locomotive in new paint schemes during the second quarter of 2017. Road names will be CSX, Norfolk Southern, Union Pacific, Wheeling & Lake Erie, Southern, Southern (NS Heritage), and Southern Pacific. Each of the road names will also be available in non-powered locomotives.



Atlas O is taking reservations for a new ACF 60-foot auto parts boxcar scheduled for release during the first quarter of 2017. Single door versions of the O scale ready-to-run model will be available for Baltimore & Ohio, Erie Lackawanna, CSX, and Rock Island.



Double door versions of the car will be available for Grand Trunk Western, Milwaukee

Road, Southern, and Union Pacific. Atlas O models are offered in 2-rail and 3-rail versions. For additional information on all Atlas O products contact a dealer or visit atlaso.com.



Dr. Ben is offering an O scale kit for a dilapidated backwoods grocery store. The Scale Model Masterpieces kit is an updated version of a structure Thomas Yorke introduced in 1987. Components in this craftsman-style kit include scale lumber, scarred wood

siding, sheets of rusted tin roofing to patch the original wood shakes, numerous details including vegetable bins, crates, and barrels; weathering suggestions, and full-size assembly instructions. The completed structure has a footprint of 3.125 x 5.0625 inches. For additional details, including ordering information, visit debenllc.com.



Mt. Albert Scale Lumber Co. is selling a kit for an O scale car shop. The structure represents a typical freight car repair facility in use throughout North America on branch line and narrow gauge railroads. The craftsman-style kit features laser-cut sheet

wood, plywood and LaserBoard; Mt. Albert Scale lumber

basswood, full interior framing and roof trusses, and a wood frame boxcar under construction. The operating doors may be constructed at either end of the structure.



Outsourced items in the kit include Stoney Creek Designs roofing material, two figures from Aspen Modeling Company, and numerous details from Grandt Line, Rusty Rail, and Tichy Train Group. A CD-ROM of construction photos and detailed instructions complete the kit. For more information visit mtalbert.com.

S SCALE PRODUCT NEWS



Rusty Stumps Scale Models is selling a craftsman-style kit for an S scale passenger station. The structure is based on a standard C&O design from the late 1800s. Components include 1/32-inch plywood sub-walls, 1/64-inch laser-engraved exterior wall panels,

detailed cast resin chimney, laser-cut windows and doors, laser-cut shingles and RC-board strips for trim. The sub-roof is scribed to help align shingles. As shown in the photo the base dimensions are 7.375 x 4.875-inches. For additional information visit rustystumps.com.

HO SCALE PRODUCT NEWS



New HO scale kits from **Accurail** include this Wisconsin & Southern PS 4750 triple-bay covered hopper. All Accurail kits

include appropriate trucks and Accumate couplers.



Also available now is a kit for this Georgia & Florida 40-foot single sheathed outside braced six-panel wood boxcar. The model is

based on a car built in 1926 with National wood doors and Dreadnaught steel ends. The prototype was rebuilt in 1954.



This 40-foot Louisville & Nashville car has 8 panels on each side. It also has National wood doors but it has Murphy corrugated steel ends.

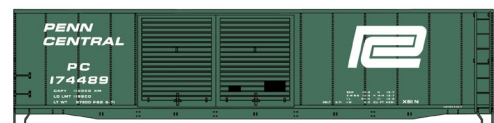

Accurail is selling an HO scale kit for this 50-foot Penn Central riveted steel boxcar with double

Youngstown corrugated steel doors. Additional new kits from Accurail include a Chesapeake & Ohio USRA twin-bay hopper car, a Great Northern 41-foot steel gondola, and a Delaware & Hudson USRA panel-side twin-bay hopper. Also a North Western Refrigerator Line 40-foot wood refrigerator car, and two 40-foot insulated plug door boxcars decorated for Pere Marquette and Union Pacific. Some of the kits mentioned are offered in

economical multi-packs. For additional information on all Accurail kits contact a dealer or visit accurail.com.

Athearn has responded positively to customer concerns regarding the hand brake configuration on a recent production run of Southern Pacific SD40R diesels and the sideframes on Flexicoil trucks supplied with the model. Athearn will reproduce the SD40R body shells with the brakewheel only on the rear for SP No. 7351. Athearn will also provide replacement high-mount brake cylinders for the Flexicoil sideframes. Athearn is expected to announce a procedure to obtain the replacement parts early this month.



Athearn has scheduled a June 2017 release date for a new production run of Genesis SD60M and SD60I diesels. The HO scale model represents EMD's highly successful series of modern diesel locomotives. The run will include SD60I units (Isolated cab, nose door on right side) decorated for Conrail (CR Quality scheme with can opener logo, above), Norfolk Southern (Horsehead scheme), and CSX SD60I units in the boxcar logo scheme.



SD60M units (nose door on left side) will be available decorated in the patriotic Desert Storm scheme, in Burlington Northern (green and black), and BNSF (orange and yellow).

SEPTEMBER NEWS | 10



Completing the SD60M release is locomotive No. 9297, aka ‘The Great Pumpkin’. It was painted in 1996 with different decorations on each side to help BNSF executives decide on a future fleet-wide paint scheme. DCC versions of the model will be equipped with Tsunami2 Sound. Standard DC models will have Athearn’s DCC-ready Quick Plug.

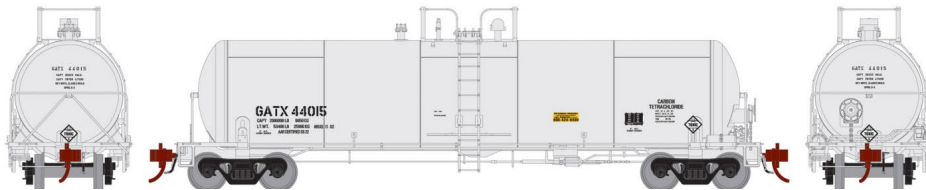

Also coming from Athearn next June is a group of Genesis series GATC 20,000 gallon tank cars. The run will include one white car decorated for GATX. All other cars in the release will be black. Road names will include GATX-Quality Liquid Feed, GATX/Agro-Culture, GATX de Mexico, GATX (late scheme), and Alaska. The HO scale models feature numerous hand-applied details. Depending on the practices of the prototype road being modeled, the cars will have either 70-ton roller bearing trucks with 33-inch machined metal wheelsets or 100-ton trucks with 36-inch wheelsets.



New Ready-to-Roll models scheduled for release next June include GP60 diesel locomotives. Road names will include BNSF (red and

SEPTEMBER NEWS | 11

silver warbonnet, above), Santa Fe (red and silver warbonnet), Santa Fe/Maersk (modified blue warbonnet scheme), and BNSF (orange and yellow, below).



The HO scale models will be available for standard DC operation. They will be equipped with a Quick Plug to simplify conversion to DCC.

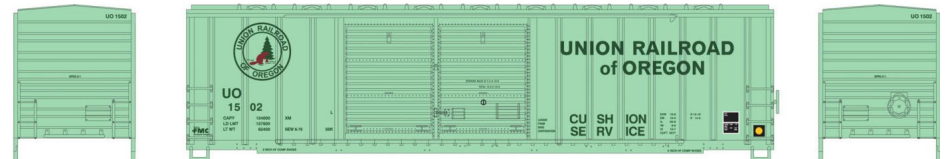

Athearn has included 50-foot FMC steel boxcars with offset double doors in the June 2017 production schedule. Road names will be Union Railroad of Oregon, City of Prineville, Port of Tillamook Bay, Yreka Western, Oregon, Pacific & Eastern; and Union Pacific.

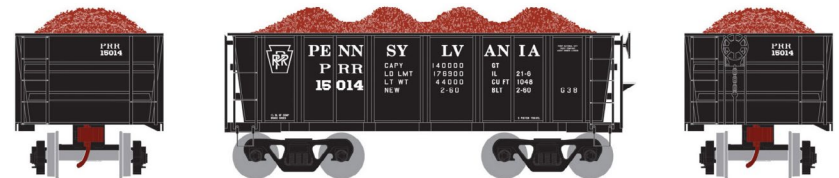

A large production run of 26-foot ore gondolas with multiple numbers is also scheduled for release next June. Cars with low sides will be available decorated for Pennsylvania Railroad, Canadian Pacific, Conrail, Penn Central, and Union Pacific.

A tall car with an extension added at the top of the sides will be available decorated for Southern Pacific. All of the cars will be

SEPTEMBER NEWS | 12

available individually as well as in a selection of three 4-packs for a total of 12 different road numbers. The models come with 36-inch machined metal wheelsets and removable ore loads.



Athearn has included 40-foot smooth-side containers and chassis in its June 2017 schedule. The containers will be available in 3-packs decorated for Mitsui O.S.K. Lines, American President Lines, K-Line, NOL, OOCL, and NYK.



Appropriate chassis to haul the containers will be available for Cosco, MOL, OOCL, P&O, TransAmerica, and Evergreen. They feature rubber tires and will be available in 2-packs.



Athearn Roundhouse models coming next June include a 50-foot boxcar with Dreadnaught steel ends, positionable Youngstown sliding doors, and trucks with machined metal wheelsets. Although most detail is molded on, the cars will have separately applied brake wheels and running boards. Road names will be Chesapeake & Ohio, Santa Fe, Bangor & Aroostook, Northern Pacific, New York Central, Southern Pacific, Union Pacific, and Western Pacific. For additional information on Athearn and Roundhouse products contact a dealer or visit athearn.com.

SEPTEMBER NEWS | 13



Atlas is booking dealer reservations for a new production run of its 60-foot auto parts boxcar. The HO scale ready-to-run model is

scheduled for release during the first quarter of 2017. Double door versions of the ACF-built car will be available for Grand Trunk Western, Milwaukee Road, Union Pacific, and Southern as shown here. Single door versions of the car will be available for Baltimore & Ohio, CSX, Erie Lackawanna, and Rock Island. Features of the Atlas Master series model include a cushion underframe with extended coupler pockets, and 70-ton roller bearing trucks with blackened metal wheelsets and adjustable mounting screws.



Atlas plans to release this Trainman series Evans 52-foot gondola during

the last quarter of this year. In addition to the C&O car shown here, the HO scale ready-to-run model will be available decorated for Burlington Northern, Indiana Harbor Belt, Kansas City Southern, and Nacionales de Mexico. For additional information on all Atlas products contact a dealer or visit atlasrr.com.



The big news about **Bachmann's** newly announced HO scale Climax steam locomotive is that it has metal gears. This is good news

to owners of earlier Bachmann locomotives that had plastic gears that aged and split. The model is equipped with DCC for speed, direction, and lighting. It comes with a factory-installed speaker

and is ready for Bachmann's Plug-and-Play sound module which is sold separately. The ready-to-run locomotive is available decorated for Moore-Keppel & Co. #3, W.M. Ritter #4, and Climax #3. The locomotive is also available painted black but unlettered. Contact a dealer for additional information or visit bachmann-trains.com.



Broadway Limited's fall delivery schedule includes this 6,000 gallon ACF Type 27 insulated high pressure tank car. Road names on the HO scale ready-to-run

model will be Canadian Industries, Columbia Southern, Penn Salt, Pittsburgh Plate Glass, Virginia Chemicals, and Hooker Chemicals. Two 4-packs will also be available with a mixed variety of road names. Contact a dealer for additional information or visit broadway-limited.com.

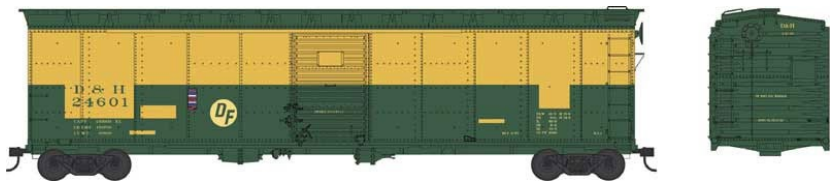

Bowser is working on a group of HO scale ready-to-run 50-foot 10-panel steel boxcars for release in January. Cars with single Youngstown doors will be available for Delaware & Hudson (yellow over green, ex-Reading), Delaware & Hudson (all green, ex-Reading), ACL (stenciled for Bulk Salt Service slogan), and L&N (stenciled for Company Material Service). Cars decorated for MKT, Peoria & Eastern, and Reading have single Creco six-panel doors.

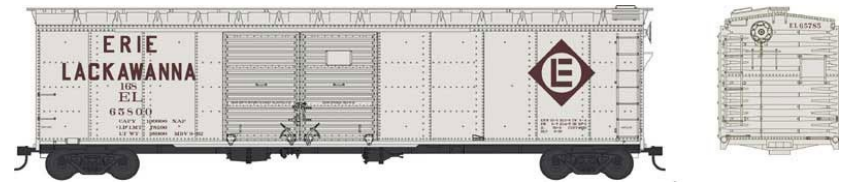

Cars with double Youngstown corrugated doors will be available for Erie Lackawanna, N&W (black with red doors), Southern Pacific (stenciled for Copper Rod Service), and Southern Pacific (yellow door). The HO scale ready-to-run models are equipped with running boards, power hand brakes with a vertically mounted brake wheel, and Dreadnaught ends. Additional features include metal wheelsets and knuckle couplers. For more information contact a dealer or visit bowser-trains.com.



Downtown Deco has introduced a kit for a group of brick structures that represent the back of a block of commercial businesses. Called Downtown Alleyway Flat, the 30-inch long structure features detailed Hydrocal castings, plastic doors and windows, pallets, oil barrels, pallets, boxes, crates, gas

cylinders, and full color signs.



The assembly instructions suggest techniques for painting and aging the cast plaster structures. Figures and vehicles shown in the photos are not included. For complete information visit downtowndeco.com.



ExactRail has issued another release of its Pacific Car & Foundry 6033 cu. ft. boxcar. The HO scale ready-to-run Evolution series model replicates spotting features of

the prototype including 3/3/3/1 Improved Dreadnaught ends, overhanging diagonal-panel roof, 10-foot 6-inch Youngstown sliding doors, and Hydra-Cushion underbody detail. The model comes with either 70-ton Barber S-2 or ASF Ride-Control trucks depending on the practice of the road being modeled. Road names include Western Pacific, Southern Pacific (two schemes), Alaska Railway, SSW-St. Louis Southwestern, SIRX- Southern Illinois Railcar, and BAEX-The Andersons Inc. For additional details including ordering information visit exactrail.com.



Highliners is accepting advance reservations for an undecorated HO scale body shell for an EMD FP7/9. As seen above in the preliminary test samples, an F7 (rear model) has been lengthened four feet to create an FP7 (front model).

The additional space accommodates a larger water supply and a steam generator to provide heat to passenger cars. The undecorated FP kit includes etched details and small parts such as fans, dynamic brake hatches, pilot/nose door choice, M.U. lines, battery details, and lift lugs.

Accurate C&NW and NdeM locomotives can be built from the Highliners FP7/9 kit. An additional group of detail parts is sold

separately to build Canadian versions of the FP9s. Longer Farr Aire grilles will also be available. Highliners created the original tooling for Athearn's Genesis F units and currently sells undecorated kits of both A and B F-units. Highliners consulted with Athearn in preparation of the new FP7/9 that is scheduled for release in several road names next April (*See MRH News July 2016*). Highliners is currently developing a new website. Meanwhile, additional information can be directed to Highliners, P.O. Box 22435, San Diego, CA 92192.



InterMountain Railway has expanded the list of road names for its forthcoming General Electric Tier 4 GEVO diesel locomotives.

Norfolk Southern has been added to the original list that included BNSF, Canadian National, CSX, and Union Pacific. The HO scale model will feature several road-specific details.



InterMountain is also working on a new release of its GE C44-9W diesel. The HO scale models will be available in multiple phases representing road-specific details.

Among the variations are three and four window cabs, Canadian teardrop window cab, high and low headlights, and early and late radiator intake grilles. Four road numbers each will be available for BC Rail, BNSF H2 (above), and BNSF (new image, below).



are Reserve Mining, GATX (ex-Reserve Mining), and Progressive Rail (below).

InterMountain Railway has added three new road names to the lineup of SD38-2 locomotives announced in April. The new names



locomotives mentioned above will be available ready-to-run with ESU sound decoder or ESU non-sound decoder. An optional DC plug will be available on request.

Availability of the HO scale locomotive is planned for late this winter. All of the



February or March. The HO scale ready-to-run model will feature a laser-cut wood deck, metal wheelsets, and Kadee couplers. Road names will be Wabash, ATSF, Pere Marquette, Central Railroad of New Jersey, Chessie System-B&O, NYC, B&O, Delaware & Hudson, Chesapeake & Ohio, and Western Maryland. An economy priced undecorated version will be available with plastic wheels and no couplers.

InterMountain plans to release a new run of its 70-ton flatcar in



Improved Dreadnaught ends will be available for Delaware,

InterMountain plans to release a group of 1937 AAR 40-foot steel boxcars in February with three types of steel ends. HO scale ready-to-run cars with

Lackawanna & Western; Chicago & Eastern Illinois, Louisiana & North West, Atlantic & East Carolina, Copper Range, and New York Central.



For additional information on all InterMountain Railway products contact a dealer or visit intermountain-railway.com.

Cars decorated for Chesapeake & Ohio (two schemes) and Baltimore & Ohio will have Deco "waffle" ends (above). Canadian National and Ontario Northland cars will have NSC-2 ends, a Dreadnaught-type with vertical stiffeners.

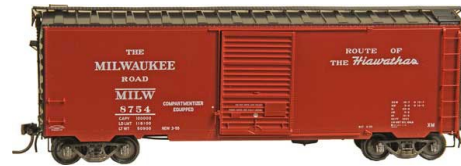

The decorating scheme follows a car built by Pullman-Standard in 1955.

New freight cars coming from **Kadee** next month include this Milwaukee Road 40-foot PS-1 boxcar. The HO scale model has 6-foot Youngstown



couplers. For more information contact a dealer or visit kadee.com.

Also due this fall is a Soo Line PS-2 twin-bay covered hopper with eight round roof hatches. Both models are ready-to-run and come with two-piece self-centering trucks and Kadee

KATO USA has added Pacer Stacktrain and TTX (new logo) schemes to its previously announced AOK and TTX (original) road names for its Gunderson MAXI-IV double-stack well-car sets. The



three unit MAXI-IV articulated cars can handle containers 20 to 53-foot long in the well, plus 40 to 57-foot containers stacked in the upper position.



Like the prototype, Kato's HO scale version has two different sized wheels. The end trucks have 33-inch wheels while the two middle trucks are equipped with 38-inch wheels.

The TTX car sets will be released in December with the Pacer cars expected the following month. For more information contact a dealer or visit katousa.com.



Brazilian model manufacturer **Prema Comércio de Modelismo Ltd.**, is selling an HO scale version of EMD's 1,250 horse power G12 diesel electric locomotive. Between 1953 and

1968 EMD and its licensees built several hundred G12s in various gauges for export to all parts of the world including Brazil.



PCM's new HO scale version has an ABS body, cast zinc chassis, and a 5-pole DC motor. For additional information visit premamodels.com.br.

Rapido Trains has introduced an HO scale extruded vinyl roadbed it calls Noise Killer Roadbed. The product is made of



dense foam that has the feel of rubber. The roadbed can be curved for broad curves or cut down the middle for application on tighter curves. The roadbed is available in two thicknesses: 3.5mm for mainline and 2mm for branch lines. The main line roadbed is 1.5-inches wide at the top and tapers out to 1.875-inches at the base. The thinner branch line roadbed is 1.5625 inches wide at the top and 1.875 inches at the base. For more information on all Rapido products visit rapido trains.com.



Summit-USA has introduced an HO scale kit for a Carl's Jr. Restaurant. The same kit is also available with signs for Hardee's. The restaurant group operates under different names

in various states.

The kit includes all building parts and window frames milled in white styrene and laser-cut in white acrylic. Clear acrylic window glazing, a street sign, self-adhesive logo signs and posters, and detailed instructions with pictures are all included. Some scenic items, including autos in the above photo, are not included. For complete details visit summit-customcuts.com.

Tangent Scale Models has added eight new paint schemes for its HO scale General American 4180 cu. ft. Airslide covered hopper. Road names available now are Burlington Northern (1972 original green), Northern Pacific (1967 original gray), SLSF-Frisco (1965 gray), Southern Railway (1978 gray), and GACX (gray with small



Coca-Cola lessee notation). Three Missouri Pacific cars are also available. They are decorated as UP repaints for May 1992, May 1994, and June 1994. For complete details including ordering information visit tangentscale-models.com.

.....



Walthers has established a November release date for this General American 30,145-gallon tank car. The 55-foot prototype is in service now

hauling crude oil, ethanol, and gasoline. Features on the Proto series model include see-through etched-metal walkways and end platforms, appropriate roller bearing trucks with 36-inch metal wheelsets, and factory-installed grab irons. The ready-to-run model will be available decorated for BRCX, CTCX, GATX, NATX, and TILX.

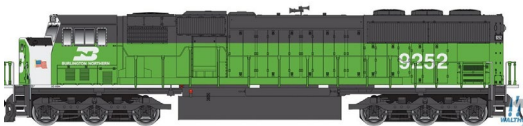

Walthers has announced plans to release an EMD SD60M diesel locomotive in late March of 2017. The

Mainline series ready-to-run model will be available decorated for Burlington Northern, BNSF, Conrail, CSX, Norfolk Southern, and Union Pacific. Features include a late-style safety cab with two-piece windshield, metal knuckle couplers, and a nine-pin plug to simplify conversion to DCC. The body shell has molded-in drill starter points making it easier for hobbyists to install individual grab irons. A set of grab irons is sold separately. For information on all Walthers products contact a dealer or visit walthers.com.

.....

N SCALE PRODUCT NEWS

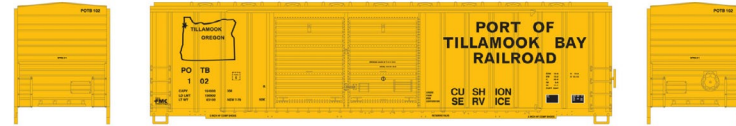

Athearn has announced plans to deliver N scale 50-foot FMC steel boxcars in June. Note the offset double doors. Road names will be Oregon, Pacific & Eastern; Union Railroad of Oregon, City of Prineville, Yreka Western, and Port of Tillamook Bay.

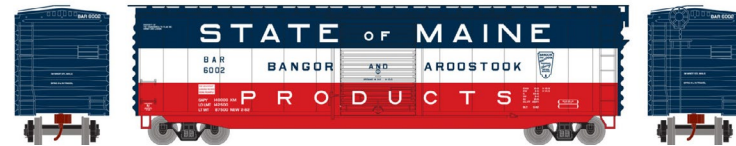

N scale models of 50-foot PS-1 single door boxcars are also due in June. Features include see-through metal running boards and machined metal wheelsets. In addition to this colorful Bangor & Aroostook scheme, the ready-to-run model will be available for Santa Fe, Chesapeake & Ohio, Northern Pacific, New York Central, Southern Pacific (DF logo), Western Pacific, and Union Pacific with a three-color shield. For more information on Athearn N scale products contact a dealer or visit athearn.com.

.....

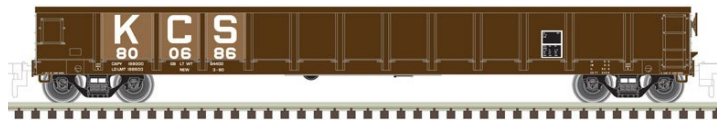

New N scale models coming from **Atlas**

during the last quarter of this year include this Evans 52-foot gondola. In addition to the Kansas City Southern car shown here, the ready-to-run model will be available decorated for Burlington

Northern, Chessie System, Indiana Harbor Belt, and Nacionales de Mexico.



Atlas has scheduled an early-2017 release for a new run of its RS-3 and RSD-4/5 locomotives. The N scale Master Line

models are based on diesel road switchers Alco built during the first half of the 1950s. The RS-3, with four-wheel power trucks, will be available decorated for Boston & Maine, New York Central, Canadian Pacific, Great Northern, Seaboard Air Line, Pittsburgh & Lake Erie, and Jersey Central.



Road names for the RSD-4/5, equipped with six-wheel power trucks, will be Santa Fe, Chesapeake & Ohio, and Milwaukee Road.



Atlas is booking dealer reservations for a new production run of a Master Line series 60-foot auto parts boxcar due during the first quarter of 2017. Double door models of the ACF-built prototype will be available for Grand Trunk Western, Milwaukee Road, Southern, and Union Pacific as shown here.



Single door versions of the N scale ready-to-run model will be available for Erie Lackawanna, Baltimore & Ohio, CSX,

and Rock Island. For additional information on all Atlas products contact a dealer or visit atlasrr.com.



Bachmann is selling an N scale Alco S4 switch engine with factory installed DCC for speed, direction and lighting control. The dual-mode

controller offers operation in either standard DC or DCC. Decorating schemes include Union Pacific, Western Maryland, Southern Pacific, New York Central System P&LE, and Santa Fe as shown here in zebra stripes.



Bachmann has released a new run of its 4-6-2 Pacific class K4 locomotive. The model

features a heavy diecast chassis, all-wheel pickup in the tender and locomotive, LED headlight, and NMRA profile wheels. Models decorated in PRR's standard post-war scheme and equipped with a modern pilot are available in two road numbers. Pre-war versions with slat pilots are available in standard PRR livery as well as in Brunswick green with gold and red stripes (above). The ready-to-run N scale model comes with Bachmann's Sound Value SoundTraxx steam package that includes chuff, short and long whistles, bell, air pump, steam release, and blower. A video demonstrating the sound system can be viewed at shop.bachmanntrains.com/index.php?main_page=index&cPath=265_372_1019.

Bachmann has also released a 72-foot heavyweight coach with LED lighted interior. In addition to the New York Central car

SEPTEMBER NEWS | 26



shown here, the N scale ready-to-run model is available decorated for Santa Fe,

Pennsylvania (Tuscan red), Union Pacific (yellow), and Baltimore & Ohio. For additional information on all Bachmann products contact a dealer or visit bachmanntrains.com.



Bowser has set a February release date for a new production run of class GLA twin-bay rib-side hopper cars. Road names will be Westmoreland Coal, PRR (circle Keystone), Rutland, and Virginian.



Additional road names will be Buffalo, Rochester & Pittsburgh; Berwind NRBX, Baltimore & Ohio, Lehigh Valley, and New

York Central (Big Four). The N scale ready-to-run model has body-mounted knuckle couplers and 70-ton AAR trucks with metal wheelsets supplied by Fox Valley Models. For more information about Bowser products contact a dealer or visit bowser-trains.com.

GATR Works has introduced a new FRED (flashing rear end of train device) with a small LED that measures just .059 x .047 x .036-inches. Called the 'NanoFRED' the device incorporates

SEPTEMBER NEWS | 27



GATR's R2 technology with a slower blink rate of just one cycle per second. Several versions are available for mounting on freight car bodies or N scale couplers. For additional information visit gatrworks.com.



InterMountain plans to release a new run of

its 70-ton flatcar in February or March. Features of the N scale ready-to-run model include a heavy cast deck, metal wheelsets, and working knuckle couplers. Road names will be Chesapeake & Ohio, Wabash, ATSF, Pere Marquette, Central Railroad of New Jersey, Chessie System-B&O, NYC, B&O, Delaware & Hudson, and Western Maryland. For additional information contact a dealer or visit intermountain-railway.com.



NJ International has introduced new N scale platform lights and modern street lights. The platform light shown on the left is 19 feet, 6 inches tall. The street lights

are 28 feet tall. The lights feature all-brass construction with LEDs and a socket base. They come ready to install. For additional information visit njinternational.com.

KATO USA plans to release its Siemens ACS-64 Electric Locomotive this December as a stand-alone model. Previously the N scale



locomotive has only been available bundled with matching Amfleet cars. Three new road numbers will be available, including #600, the first ACS-64 to enter Amtrak service which has special “David L. Gunn” (former president of Amtrak) lettering on the nose.

The other locomotive numbers will be 627 and 648. The ACS-64, also known as the Amtrak Cities Sprinter, is a replacement for Amtrak’s aging AEM-7 and HHP-8 electric locomotives on the Northeast and Keystone Corridors. Kato plans to release a sound card for the ACS-64 in October. To hear a preview of the sound recorded at Siemens’ test track in Sacramento, CA, go to youtube.com/watch?v=0PzVefh-2DQ. For more information on all Kato products contact a dealer or visit katousa.com.



New N scale models from **Micro-Trains Line** include a

heavyweight 78-foot paired-window coach decorated in Pullman green and lettered for New Haven.



Also new is this Canadian Pacific 70-foot heavy-weight bag-

gage car based on a prototype used to transport thoroughbred racehorses.



This 50-foot steel boxcar with double Youngstown sliding doors is equipped with high-speed roller bearing trucks. It is based on a prototype built

in 1941 and later converted to express service in passenger train consists. For more information about Micro-Train Line products contact a dealer or visit micro-trains.com.



Trainworx Inc. sells N scale vehicles including Peterbilt 350, 351, 379, and Kenworth T800 trucks. Two downloadable catalogs illustrating decorated parts for customizing can be viewed at train-worx.com/truckparts.pdf and train-worx.com/truckparts.htm.

NEW DECALS, SIGNS AND FINISHING PRODUCTS



Black Cat Publishing has new HO scale decals for Great Northern heavyweight

passenger cars in both gold leaf and dulux gold (yellow ochre). The sets are suitable for decorating cars painted Pullman green before the introduction of the Empire Builder scheme with serif lettering. Also new are decals for Dominion Atlantic Dayliner RDC cars. DAR had two RDCs lettered similar to CPR's with two Tuscan stripes on the side and tiger stripes on the end. Completing the list of recent releases are Grand Trunk Western decals for eight-hatch reefer cars in the wet noodle scheme. For information visit blackcatdecals.com.



Great Decals reports that Curt Fortenberry's lettering sets for the L&N Hummingbird are back in stock. Available now are HO scale dulux gold decals for

L&N Hummingbird/Georgian tavern-lounge and dining cars. The set includes four pairs of L&N road names, train name, car names, and road numbers. Also available are lettering sets in dulux gold for Louisville & Nashville lightweight coaches. Each sheet will decorate one car. L&N road names are included along with a dozen pairs of canned road numbers from which any valid car number can be assembled. Bill Mosteller offers a wide range of decals for most popular scales. They can be viewed at greatdecals.com.

Daniel Kohlberg has released decals for Chicago & North Western GATC 2600 cu. ft. Airslide covered hopper cars.

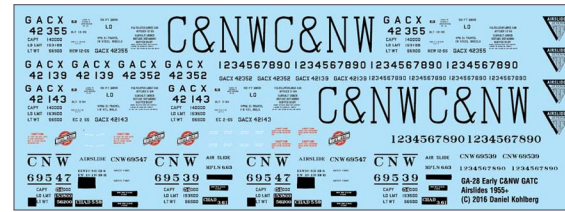

Identified as item GA-28, the HO scale lettering set is suitable for cars from 1955 through the 1980s.

For additional details including prototype information and ordering instructions go to home.mindspring.com/~paducah.

New HO scale steam-era decals available from Smokebox Graphics include Ann Arbor Railroad 40-foot boxcars. The lettering set is intended for AA steel boxcars built by ACF and Pullman Standard and contains extensive data, two sizes of road names, and four different types of pennant heralds. A data sheet provides specific information on lettering the cars. Smokebox Graphics decals are printed in Italy by Cartograf and have very fine detail. For more information visit smokeboxgraphics.com.



Tichy Train Group has released several new decal sets including many formerly sold by Jerry Glow.

Selected items include this lettering set for a DSDX Milwaukee Road rib side reefer. Additional items include URTX Milwaukee Road rib side reefer, Milwaukee Road rib side Hiawatha boxcar, Pennsylvania class H-32 covered hoppers (red, gray), and SCL stump cars. Also new are sets for SL-SF, L&N, Erie, and Virginian USRA hopper cars; NYC hoppers and gondolas, SP tank cars, and DL&W boxcars. Tichy decals are available for HO, N, S and O scale. For additional details including ordering information visit tichytraingroup.com and click on Shop.

DISCLAIMER

The opinions expressed in this column are those of the writer and do not necessarily reflect the opinion of *Model Railroad Hobbyist* or its sponsors. Every effort is made to provide our readers with accurate and responsible news and information, however, neither *Model Railroad Hobbyist* or the writer of this column can be held responsible for any inaccuracies or typographical errors that may inadvertently appear in this column.

i SEND US YOUR PRODUCT ANNOUNCEMENTS

If you are a hobby manufacturer with a product announcement, just [click here](#) and submit your announcement to us. Our web site and free magazine reach continues to grow, so get on board this new media train! ■

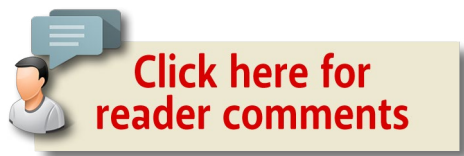

! BRIEFLY NOTED AT PRESS TIME ...

Paul Mayer of Glenview, IL passed away August 14, 2016. He was a devoted traction fan and modeler and produced HO and O scale trolley decals under the Shoreline brand. Mayer was 82 years old.

Bluford Shops is taking advance reservations for 30-foot 6-inch twin-bay hopper cars with panel-sides. The N scale models will be weighted with a die casting assembly that incorporates the slope sheet, hopper bay, and center sill. Additional features include valve and air lines, body mounted brake hose detail, a lever-style hand brake, body mounted magnetic knuckle couplers and trucks with Fox Valley Models metal wheelsets. The ready-to-run model comes with a removable coal load. Road names are Chesapeake & Ohio, Frisco, Pittsburgh & Lake Erie, Ann Arbor, Big Four - NYC, Canadian National, and Grand Trunk Western. For more information visit bluford-shops.com.

Highball Graphics is selling a cover for an HO scale Proto 2000 53-foot mill gondola. The item replicates a smooth surface Ecofab-style cover. Ecofab decals are included. In addition to the Proto 2000 model, with a little trimming the cover will also fit the new Rapido gondola. For more info visit highballgraphics.com.

Microscale Industries has released an HO scale decal set for an ADMX (Archer Daniels Midland) Corn Syrup Uni-Temp tank car. For details contact a dealer or visit microscale.com.

Continued on the next page ...

! BRIEFLY NOTED AT PRESS TIME *CONTINUED ...*

Randy Lee has acquired the PFM – Pacific Fast Mail name and plans to rebuild the once-famous brand. Lee plans to introduce HO and O scale laser-cut kits for Kettle Valley passenger cars at the National Narrow Gauge Convention Train scheduled to be held in Augusta, ME September 7 through 10. He also plans to show samples of a laser-cut kit for White Pass & Yukon cabooses. Lee is familiar with PFM and has been doing repairs and upgrades on PFM sound systems for several years. Nothing is definite but long range plans include importing some brass items. Lee can be contacted at banjopicker1949@yahoo.com.

San Juan Decals has released a new kit for an O scale Cumbres Section House Coal Shed. The O scale kit features laser-cut wood framing and wall planks for board-by-board construction. The roof panels, door and floor are cut, notched and scribed as one piece assemblies. Special details include Grandt Line hinges. Also included are laser-cut wood templates to aid assembly. The prototype structure has a tarpaper roof, however, no roofing material is included in the kit. The explanation given is that modelers may want to use tarpaper, shingles or sheet metal. HO and S scale versions are scheduled for future release. For more information visit sanjuandecals.com ...

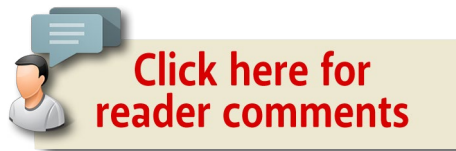

Model Railroad Hobbyist Store

CHECK OUT OUR NEW VISUAL CATALOG:

click here

The grid contains 12 thumbnails, each with a 'LEARN MORE' button and a small 'VIEW THE ARTIST STUDIO' link. The thumbnails are numbered 1 through 12:

- 1. VISUAL CATALOG Model Railroad Hobbyist Store
- 2. WEATHER Like a pro
- 3. BACKDROP PAINTING with Chris Lyon
- 4. STREAMLINERS
- 5. EXTREME Weathering
- 6. Layout tours
- 7. WEATHER Like a pro
- 8. Layout tours
- 9. Allagash Railway Scenery Modeling Outside the Box
- 10. Op Session Live
- 11. Allagash Railway Scenery Modeling Outside the Box
- 12. Op Session Live



SELECTED EVENTS

September 2016

(Please note that many events charge a fee. Check individual info website for details.)

CANADA, QUEBEC, MONTREAL, September 24-25, Montreal Model Train Exposition, at Sun Youth Organization Centre, 4251 St. Urbain Street. Info at montrealmodeltrainexposition.com.

ALABAMA, DOTHAN, September 17-18, Wiregrass Model Railroad Show & Sale, at National Peanut Festival Fairgrounds, 5622 Highway 231.

CALIFORNIA, CULVER CITY, September 21-25, NMRA Pacific Southwest Region LA Junction Convention, at Double Tree Hotel LA Westside, 6161 West Centinela Avenue. Info at psrconvention.org/lajunction.

CALIFORNIA, LOS ANGELES, September 25, Self-guided tour of area layouts. Info at groups.yahoo.com/neo/groups/Model_Railroads_Of_Southern_California/info.

INDIANA, INDIANAPOLIS, September 22-24, 48th National O Convention, at Wyndham Indianapolis West Hotel, 2544 Executive Drive. Info from Kimberly Ryker at kim.ryker@yahoo.com.

INDIANA, NOTRE DAME, September 30-October 1, NMRA Michiana Division Modeling Like a PROTOTYPE Education and Training Conference, at Morris Inn & Conference Center on Notre Dame campus. Info at michiana-nmra.org.

MAINE, AUGUSTA, Sept. 7-10, 36th National Narrow Gauge Convention. Info at nngc2016.org.

SELECTED EVENTS | 2

MICHIGAN, HASTINGS, September 17, 3rd Annual Hastings Train Show and Swap Meet, Barry Expo Center, 1350 N. M-37 Highway. bcmrrc.net.

NEW YORK, CLAYTON, September 10-11, 30th Annual Thousand Islands Train Fair, Recreation Park, 615 East Line Road.

NORTH CAROLINA, DENVER, September 23-25, HO Modular Layout Display sponsored by The Sipping & Switching Society of North Carolina. At Salem United Methodist Church, 378 N. Pilot Knob Road. Info at groups.yahoo.com/neo/groups/SandSSofNC/info.

OHIO, FOSTORIA, September 24, 15th Rail Festival & Fostoria Iron Triangle Train Show, at Fostoria High School, 1001 Park Avenue. Info at fostoriairontriangle.com/festival.htm.

VIRGINIA, FREDERICKSBURG, September 30 - October 1, Mid-Atlantic Prototype Modelers Meet, at Wingate by Wyndham Hotel, 20 Sanford Drive. Info at marpm.org.

WEST VIRGINIA, September 10-11, Coal River Model Train Show, at Madison Civic Center, 261 Washington Avenue.

WISCONSIN, MADISON, September 11, NMRA South Central Wisconsin Division Meet, at Zor Shrine Center, 575 Zor Shrine Place. Info at nmra-scwd.org.

WYOMING, EVANSTON, September 10, 1st Annual Mountain States Prototype Modelers Meet, in restored Union Pacific Machine Shop, 1440 Main Street. Info at tinyurl.com/MSRPM.

October 2016

AUSTRALIA, QUEENSLAND, BEENLEIGH, October 15-16, Model Train Show, at Beenleigh Events Centre, Crete and Kent Streets. Event sponsored by Logan District Model Railway Club. Info at ldmrc.com/show.

SELECTED EVENTS | 3

CANADA, ALBERTA, EDMONTON, October 22, MMRF Fall Swap Meet, sponsored by the Mainline Model Railroaders Fellowship, at Central Lions Seniors Recreation Centre, 11113 113 Street. Info at mmrf.ab.ca/events.shtml.

CANADA, ONTARIO, BRAMPTON, October 1-2, Model Railway Show, at Brampton Fair Grounds, 12942 Heart Lake Road. Info at bramptonmodelrailwayshow.com.

CALIFORNIA, SAN PEDRO, October 15-16, Open House & Swap Meet, sponsored by Belmont Shore Railroad Club, at 3601 South Gaffey Street, Building 824. Info at belmontshorerr.com.

ILLINOIS, CHICAGO, October 1-2, Brass Expo, a juried show limited to pre-submitted items including brass models and items relevant to brass models. At The Westin Hotel (Chicago North Shore), 601 N. Milwaukee Ave. Wheeling, IL 60090. Info at brassexpo.com.

ILLINOIS, LISLE, October 20-22, RPM Chicagoland (formerly Naperville RPM), hosted by Mike Skibbe, at Sheraton Hotel. Info at rpmconference.com.

IOWA, HAMPTON, October 30 5th Annual North Central Iowa Model Railroad Show & Sale, at Franklin County Convention Center, 1008 Cental Avenue West. Request info at eastsidetrains@gmail.com.

MASSACHUSETTS, WAKEFIELD, October 8-9, Model Railroad Show & Open House, sponsored by the North Shore Model Railroad Club. Show October 8 at American Civic Center, 465 Main Street. Club layout is open for viewing Oct 8-9 at 404 Main Street (rear). Info from Joe Greene at info@nsmrc.org.

MICHIGAN, NORTHVILLE, October 6-9 North Central Express 2016, NMRA NCR Regional Convention, at Ward Church, 40000 Six Mile Road. Info at div6-ncr-nmra.com/ncx-2016---over-view.html.

SELECTED EVENTS | 4

MISSOURI, JEFFERSON CITY, October 6-9, Missouri Pacific Historical Society Annual Meeting, includes modeling clinics and swap meet. Info at mopac.org/annual-convention/110-2016-jefferson-city-mo.

MISSOURI, KIRKWOOD, October 8-9, Greater St. Louis Metro Area Train Show at Kirkwood Community Center at West Argonne Drive and South Geyer Road. Event sponsored by Mississippi Valley N Scalers. Info at seetrains.com.

MISSOURI, SEDALIA, October 29, Sedalia Rails Train Show, sponsored by Pettis County Historical Society, at Liberty Park Convention Hall, 1500 3rd Street at Highway 65. Info from Ken Bird at klbird@embarqmail.com.

NEW JERSEY, HILLSBOROUGH, October 1, NMRA Garden State Division Fall Meet, at Hillsborough Township Municipal Building. Info at nergds.com/upcoming.html.

NORTH CAROLINA, DURHAM, October 20-23, Mid-Eastern Region Fall Convention, sponsored by NMRA Carolina Piedmont Division, at Marriott at Research Triangle Park, 4700 Guardian Drive. Info at mer2016.org.

NORTH CAROLINA, HENDERSONVILLE-ASHEVILLE, October 7-8, Autumn Rails All Scales Train Show, sponsored by French Broad e'N'pire Model Railroad Club, at Expo Building, WNC Agricultural Center, 1301 Fanning Bridge (off NC 280). Info at nrmrc.org/events/shows/french-broad-enpire-autumn-rails-2016.

OHIO, CINCINNATI, Oct 8-9, Train & Trade Show, sponsored by NMRA Cincinnati Division 7, at Lakota West High School, 8940 Union Center Avenue. Info at cincy-div7.org/events.html.

TEXAS, FOREST HILL, October 8-9, Texas Western Train Show, at Forest Hill Civic Center, 6901 Wichita Street. Info at twmrc.org.

SELECTED EVENTS | 5

TEXAS, SAN ANTONIO, October 1-2, Model Train Show sponsored by Alamo Model Railroad Engineers Society at Freeman Coliseum, Expo Hall A, 3201 East Houston Street. Info at txtransportationmuseum.org/event-amre-train-show.php.

VIRGINIA, VIRGINIA BEACH, October 8-9, 27th Annual Train Show & Sale, at Virginia Beach Convention Center, 1000 19th Street, sponsored by Tidewater Division Model Railroaders. Info at nmra-mer-tidewater.org.

WASHINGTON, CHEHALIS, October 8-9, Model Railroad Show & Swap Meet, at Southwest Washington Fair Grounds, Blue Pavilion Exhibit Building, 2555 North National Avenue. Sponsored by Lewis County Model Railroad Club. Info from ted-strains@lewiscounty.com.

Future 2016, by location

CANADA, BRITISH COLUMBIA, VANCOUVER, November 5-6, 34th Vancouver Train Expo, at PNE Forum, 2901 East Hastings Street. Info at vancouvertrainexpo.ca.

CANADA, BRITISH COLUMBIA, VANCOUVER, November 3-6, Railway Modellers Meet, sponsored by NMRA, PNR 7th Division, at Atrium Inn, 2889 East Hastings Street. Info at railwaymodellersmeetofbc.ca.

CALIFORNIA, SACRAMENTO, November 12-13, Open House at Sacramento Model Railroad Historical Society, 1990 Grand Ave. Both HO and HOon3 narrow gauge layouts will be operating. Info at smrhs.com.

MICHIGAN, SALINE, November 27, Southeast Michigan Model Train Show and Sale, sponsored by Rails on Wheels, at Washtenaw Farm Council Grounds, 5055 Ann Arbor-Saline Road. Info from Jeff at wab2ndops@yahoo.com.

SELECTED EVENTS | 6

OHIO, SANDUSKY, December 3, Open House at Erie & Mad River Model Railroad, 1309 North Depot Street. Request info from Robert Butler at robertbutler@bex.net.

PENNSYLVANIA, ALLENTOWN, November 12-13, First Frost Train Meet Show and Sale, at Allentown Fairgrounds, Agricultural Hall. Info at allentowntrainmeet.com.

PENNSYLVANIA, MONACA, November 20, Beaver County Fall Model Train Show, at Monaca Turners, 1700 Old Brodhead Road. Info at bcmrr.railfan.net.

WASHINGTON, KENT, November 12, 37th Annual Model Railroad & Railroadiana Swap Meet, sponsored by Boeing Employees Model Railroad Club, at Kent Commons, James & 4th Avenue. Info from Ed Sherry at swapmeet@bemrrc.com.

Future 2017, and beyond by location

AUSTRALIA, VICTORIA, GEELONG, April 14-16, 2017, 13th Annual Australian Narrow Gauge Convention. Info at austnarrowgaugeconvention.com.

COLORADO, DENVER, August 30-September 2, 2017, National Narrow Gauge Convention, at Marriott Denver Tech Center Hotel. Info at 37nngc.com.

FLORIDA, ORLANDO, July 30-Aug 5, 2017, NMRA National Convention. Info at nmra2017.org.

MISSOURI, KANSAS CITY, August 5-12, 2018, NMRA National Convention. Info at kc2018.org.

SOUTH CAROLINA, EASLEY, February 10-11, 2017, Annual Train Show, sponsored by Central Railway Model & Historical Association at (new location) Impact Center, Rock Springs Church 207 Rock Springs Road. Info at crmha.org.

SELECTED EVENTS | 7

UTAH, SALT LAKE CITY, July 7-13, 2019, NMRA National Convention. Info at northernutahnmra.org/2019-nmra-national-convention.

WASHINGTON, MONROE, February 25-26, 2017, 26th Annual Washington State Train Show and Marketplace, at Evergreen State Fairgrounds. Event sponsored by United Northwest Model Railroad Club. Info at unwclub.org. ■



Click here for
reader comments

**Please include
a phone
number when
contacting
MRH**

(in case your spam
filters eat our
email response)

122,000 have seen this
MRH video - have you?



Watch the
video now 

CLICK HERE FOR RAILFAN GOODIES!



Rapido SWAG STORE

Clickable advertiser index – 1

[Accu-Lites](#)
[American Ltd \(San Juan\)](#)
[Amherst Railway Society](#)
[ANE Models](#)
[Archer Fine Transfers](#)
[Athearn](#)
[Atlas Model Railroad Co.](#)
[Bachmann](#)
[Backdrop Junction](#)
[Berrett Hill Trains](#)
[Black Cat Publishing](#)
[Blair Line](#)
[Bowser](#)
[Canyon Creek Scenics](#)
[Clever Models](#)
[Coatmans Scenic Products](#)
[Coffman Graphics](#)
[Credit Valley Railway](#)
[DCC Hobby Supply](#)
[Digitrax \(2 page spread\)](#)
[ESU LokSound](#)
[Fast Tracks](#)
[Fox Valley Models](#)
[George's Trains](#)
[GLX Scale Models](#)
[Great Decals](#)
[HO Diesel Supply](#)
[Iowa Scaled Engineering](#)
[Iwata-Medea](#)
[Jelsma Graphics](#)
[Jim's Track Plans](#)
[KC's Workshop](#)

[Ken Patterson.com](#)
[Lights 4 Models](#)
[Litchfield Station](#)
[Logic Rail Technologies](#)
[Main Street Heritage Models](#)
[Missouri Locomotive Co.](#)
[Model Railroad Benchwork \(1\)](#)
[Model Railroad Benchwork \(2\)](#)
[Model Rectifier Corporation](#)
[Monster Modelworks](#)
[Motrak Models](#)
[Mountain Subdivision Hobbies](#)
[MRH Store \(1\)](#)
[MRH Store \(2\)](#)
[MRH Store \(3\)](#)
[Mt. Albert Scale Lumber](#)
[NCE \(2 page spread\)](#)
[Nick & Nora Design](#)
[Norfolk & Western Historical Society](#)
[North American Railcar Co.](#)
[Oak Hill MRR Track Supply](#)
[Pre-Size Model Specialities](#)
[Precision Design Co.](#)
[Railmaster Hobbies](#)
[Rapido \(1\)](#)
[Rapido \(2\)](#)
[Ring Engineering \(1\)](#)
[Ring Engineering \(2\)](#)
[Rulers-of-the-World](#)
[Rusty Stumps](#)
[Scale Trains](#)
[Scale Photo Etch](#)

Clickable advertiser index – 2

[Scotty Mason Show](#)
[Soundtraxx \(Blackstone\)](#)
[Southern Digital](#)
[Streamlined Backshop Services](#)
[TAM Valley Depot](#)
[Tony's Train Exchange](#)
[Trainfest 2016](#)
[TrainMasters TV \(1\)](#)

[TrainMasters TV \(2\)](#)
[TrainMasters TV \(3\)](#)
[Traintek](#)
[TSG Multimedia](#)
[Westerfield Models](#)
[Yankee Dabblers](#)
[Yarmouth Model Works](#)

Clickable "other" index

[Other – Cover](#)
[Other – Derailments](#)
[Other – Hobby Marketplace](#)
[Other – MRH Sponsors](#)
[Other – Contents](#)

DOWNLOAD ISSUE

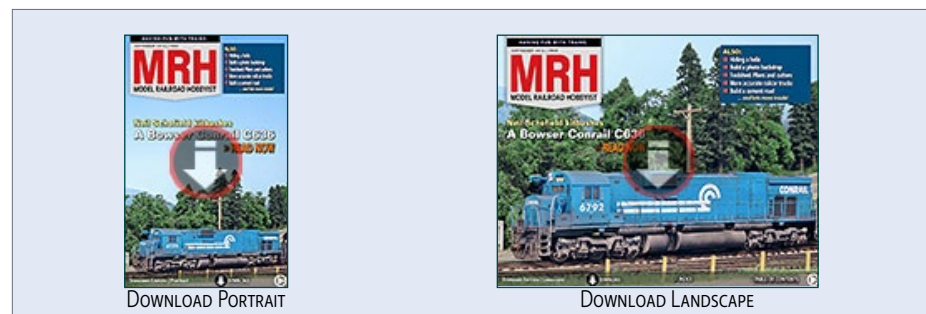



REVERSE RUNNING

commentary

JOE FUGATE



[Click here for reader comments](#)

FORGET USING FOAM UNDER YOUR TRACK

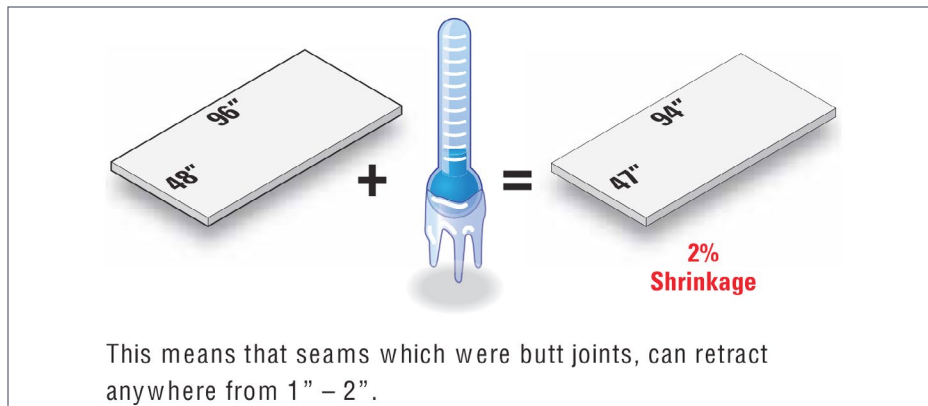

AS PART OF MY NEW *RUN LIKE A DREAM* TRACKWORK book project, I've compiled the manufacturers' specs on various products we model railroaders have been using for roadbed. Perhaps the most surprising discovery involves foamboard and my findings have convinced me to forget using formboard under track.

There are three main types of foamboard I've seen in the building supply stores: white foamboard (expanded polystyrene or EPS), and

▶ STEPPING OUTSIDE THE BOX WITH A CONTRARY VIEW

blue or pink foamboard (extruded polystyrene or XPS). Isulfoam (and others) make the white foamboard. Dow makes the blue foamboard, and Owens Corning makes the pink foamboard.

In looking at their spec sheets, they all say the foam's dimensional stability is around 2%. In other words, an 8 foot sheet of foam can shrink by up to 2" in extreme temperature environments! In googling the foam shrinkage issue, I found several examples of severe foam shrinkage in exterior applications where the temperature may shift say from -20°F in the winter to +100°F during the hot summer months. This column's lead illustration is from Dow's documentation on using their blue foam – note the huge 2% dimensional shift!

True, we're talking a 120° temperature shift and most climate-controlled model railroad rooms won't see such drastic changes. But a 20° shift isn't unreasonable. For instance, my basement (which doesn't have A/C, only furnace heat), stays a comfortable 70 degrees most of the year, but one heat spell a few years ago saw the basement get up to 90 degrees – a 20-degree temperature shift.

It also appears once a cold board shrinks, it does not completely recover when it warms up: some of the polystyrene cell walls collapse. As a result, some of the shrinkage becomes permanent.

If we assume the shift is linear, then that 20° change is one-sixth as much, which means the foam could still change by 1/3" in that 20° temperature swing. What would *that* do to your track?

Ken Patterson reported recently in his *What's Neat* column that he has seen a permanent 1/2" shrinkage in his foam roadbed over the decade (and more) that his layout has been in existence.

In researching this, I can see why it is happening. Foam board is very light – and that's because it's mostly air. If you recall your high school physics, gases expand and contract more than liquids or solids. Academic research papers on this problem blame the mostly air composition of foamboard for this radical dimensional instability.

The bottom line is this: forget using foamboard under your track! ☑



DERAILMENTS

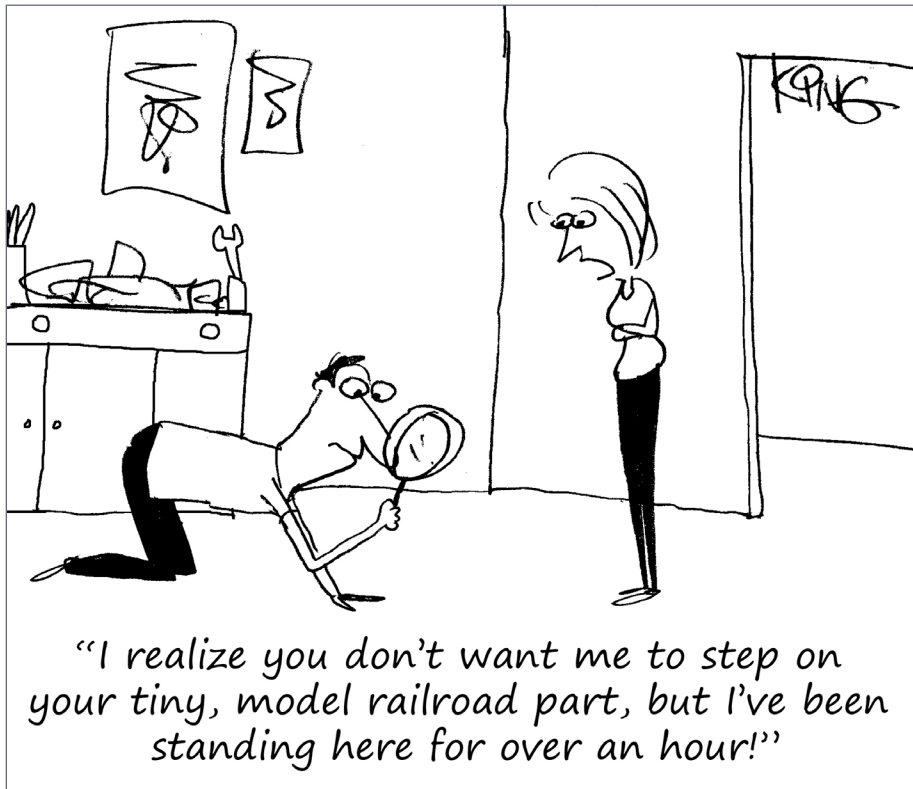

Jerry King

Phrase recently used at the club to describe a couple elderly club members: "Yes, their gates are down, their lights are flashing, but the train ain't coming ..."

► BIZARRE FACTS AND HUMOR (SUPPOSEDLY)

YOU MIGHT BE A RAILFAN IF ...

- Your car's license plate is customized with a locomotive designation or railroad reporting marks.
- And so is your email address.
- Your territorial dominance near the railroad tracks is enough to scare away even a biker gang.
- You still live with your parents because you spend so much on digital SLR accessories and disk storage for train photos.
- Your dog's name is "Conrail." ■

\$ GET PAID ...

If you're the first to submit a bit of good humor or bizarre facts and we use it, it's worth \$25! Just send to derailments@mrhmag.com ■

Coming next issue ...

- Kurt Matthey's Cleveland Flats module
- Modeling gravel loads
- Railfanning the Great Lakes Western club layout
- Using surface-mounted LEDs for headlights in steam locos
- Track cleaning the easy way
- And lots, *lots* more!



Click here for reader comments

