

HAVING FUN WITH TRAINS

MARCH 2016 | FREE

MRH

MODEL RAILROAD HOBBYIST

ALSO:

- More realistic brick structures
- Boxcar & reefer doors guide
- PollyScale/Floquil replacements
- Better metal roofwalk glue
- Is DCC on the way out?

... and lots more inside!

Mike Holly on Detailing an Alco C420

>> READ NOW



STANDARD EDITION | PORTRAIT



DOWNLOAD

BLMA MODELS



HO & N

HERE COME THE REPAINTS

3 NEW BNSF SCHEMES



PRE-ORDER MODELS

BNSF
Bx-166

60' Double-Door Box Car

• 24 Unique Road Numbers •

ORDERS DUE: Jan 15, 2016

DELIVERY: Summer 2016

BLMAmodels.com



• INDEX

• TABLE OF CONTENTS



STAFF CREDITS

Front cover: Mike Holly takes a diesel locomotive to the next level, specifically an Atlas Norfolk & Western Alco C420 in this issue's cover story.

ISSN 2152-7423

Editorial Staff

Joe D. Fugate, Publisher and Editor

Don Hanley, Assistant Editor

Production

Patty Fugate, pasteup and layout

Joe Brugger, copy editing

Mike Dodd, copy editing

Technical Assistant

Jeff Shultz

Advertising

Les Halmos, Account Manager

Daniel Nava, Advertising Assistant

Jean-François Delisle, Marketing Assistant

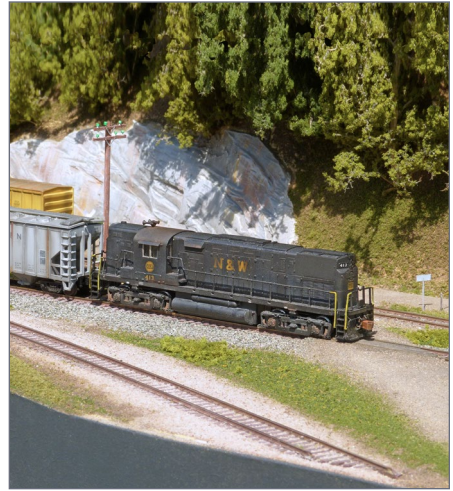

Columnists

Richard Bale, News and events

Jeff Shultz, News and events

Les Halmos, Modular railroading

Larry Smith, Narrow Gauge/Shortlines

Bruce Petrarca, DCC

Ken Patterson, Reporter at large

Special Correspondents

Joe Brugger, Questions & answers

Charlie Comstock, Contributing editor

Issue password: Mar2016

Published for the glory of God. [What's this?](#)



MRH SPONSORS

A - E



acculites.com



onlinetrainauctions.com



americanlimitedmodels.com



railroadhobbyshow.com



anemodel.com



archertransfers.com



athearn.com



www.atlasrr.com



bachmanntrains.com



bachrus.com



backdropjunction.com

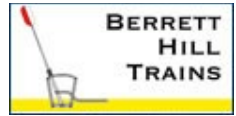

berretthill.com/trains



blairline.com



blmamodels.com



bowser-trains.com



caboosehobbies.com



coffmaneng.com



coastmans.com



crrco.com



www.digitrax.com



esu.eu/en

[Vendors: Get your clickable logo here ...](#)

MRH SPONSORS | 2

F - R



www.handlaidtrack.com



fiferhobby.com



modelrailroadexpo.com



foxvalleymodels.com



glxscalemodels.com



georgestrains.com



www.iascaled.com



iwata-medea.com



litchfieldstation.com



micromark.com



modelrectifier.com



model-trains-video.com



monstermodelworks.com



stores.ebay.com/Motrak-Models



modelrectifier.com



nano-oil.com/Model%20Railroad.html



ncedcc.com



nickandnoradesigns.com



www.pwrs.ca/main.php



nationaltrainshow.org



rapidotrains.com



ringengineering.com



rslaserkits.com



rustystumps.com

[Vendors: Get your clickable logo here ...](#)

MRH SPONSORS | 3

S - Z



sanjuancarco.com



scaletrains.com



signaturepress.com



soundtraxx.com



sodigi.com

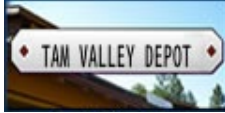

tamvalleydepot.com



tonystrains.com



traintekllc.com



tsgmultimedia.com



yankeedabblers.com

[Vendors: Get your clickable logo here ...](#)

Looking for something? Check our Hobby Marketplace!

The screenshot shows the MRH Marketplace website interface. At the top, it says 'MRH MARKETPLACE | 2'. Below this, there are several promotional banners and product listings. On the left, there's a 'MRH MARKETPLACE' banner with 'Logos' and 'coastmans' sections. In the center, there's a 'Logos' section with an image of a train. To the right, there's a 'New Available Again KIT HOBBIES PBR GLA Modernized Hopper' section. Below that, there's a 'CLICK HERE FOR LIST OF Closeout Kits' section. At the bottom, there's a 'hobby supply' section with 'Quality DCC Equipment' and a list of brands: Digitrax, TCS, NCE, GSI, SoundTraxx, Lenz, LokSound. There are also smaller ads for 'SUGAR CUBE SPEAKERS', 'BenchWork', and 'HELP WITH'.

Take me there!



HISTORIC HO 4-4-0 AMERICANS

SHIPPING NOW IN DCC SOUND-EQUIPPED and DCC-READY VERSIONS

Ken Peterson

The famed 4-4-0 steam locomotives that completed the first Transcontinental railroad at the Golden Spike ceremony at Promontory Point in 1869 have been updated for 2016. With all new tooling that now includes a can motor in the engine, flywheel, and more detailed loads, they are available in DCC sound-equipped and DCC-ready versions. The DCC sound-equipped model includes our Sound Value *SoundTraxx*® steam sound package with authentic prototypical chuff, short and long whistles, bell, air pump, steam release and blower—all in 16-bit polyphonic sound. The DCC-ready version runs DC out of the box and has a factory-installed 8-pin socket for the DCC decoder installation of your choice. Visit your favorite hobby retailer to create your own historic railroad today!



UNION PACIFIC® #119
with WOOD LOAD
Item No. 52701



CENTRAL PACIFIC #60
"Jupiter" with WOOD LOAD
Item No. 52702



DCC SOUND VALUE-EQUIPPED
MSRP \$319.00 each

Click for
more info



BALTIMORE & OHIO®
with COAL LOAD
Item No. 52703



SANTA FE #91
with WOOD LOAD
Item No. 52704

**SHIPPING
NOW!**

Click for
more info

DCC READY • MSRP \$239.00 each

- Item No. 51002 UNION PACIFIC® #119 with WOOD LOAD
- Item No. 51003 CENTRAL PACIFIC #60 "Jupiter" with WOOD LOAD
- Item No. 51004 W&ARR "Texas" with WOOD LOAD
- Item No. 51005 PENNSYLVANIA with COAL LOAD



Bachmann Industries, Inc. • 1400 East Erie Avenue • Philadelphia, PA 19124 • www.bachmanntrains.com
Click to learn more.

• INDEX

• TABLE OF CONTENTS



TABLE OF CONTENTS

FEATURES

Taking an Atlas C420 to the next level

MIKE HOLLY

Make your diesel locos look better and run great



Using Monster Modelworks brick

DAVID KARKOSKI

Make your brick structures more realistic



Modeler's guide to boxcar & reefer doors

RICHARD BALE

Doors found on Twentieth Century rolling stock



Dave Petty's Midwest Central

DAVE PETTY and the MRH STAFF

Layout on tour at this summer's NMRA National



Intro to the puzzle of switching

GREG BAKER

Can you solve these two switching scenarios?

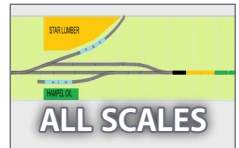

ALSO: MRH Marketplace | Bonus extras

TABLE OF CONTENTS | 2

COLUMNS

MRH Q-A-T: Benchmark edge, metal roofwalks, ...

compiled by JOE BRUGGER

DCC Impulses: Is DCC dead?

BRUCE PETRARCA

Getting Real: Tank car basics, part 2

TONY THOMPSON

What's Neat: Trade show displays, shop lights, and more ...

KEN PATTERSON

Photo feature: Yes, it's a model

compiled by DON HANLEY

Derailments: Bizarre facts & humor

compiled by the MRH STAFF

NEWS and EDITORIAL

Publisher's Musings: Painting in a post-Floquil world

JOE FUGATE

Staff Notes: The new MRH Staff Pick award ...

compiled by the MRH STAFF

News & Events: March 2016

RICHARD BALE & JEFF SHULTZ

Reverse Running: Hobby is going to the dogs

JOE FUGATE

ADVERTISEMENT

TODAY'S ROLLING PIPELINE

Trinity 31K Crude Oil Tank Car With Head Shields



Scene and photography by Ken Johnson. Actual model shown

Continuing our quest to create Innovative ScaleTrains™ models, we've developed two distinct detail levels for our first tank car. This allows us to offer a value-priced model as well as a super-detailed version. Learn more and purchase now at www.ScaleTrains.com or a Select Retailer.



© 2015 ScaleTrains.com, Inc. ScaleTrains.com, Operator, and Rivet Counter plus respective logos are trademarks of ScaleTrains.com, Inc.

ScaleTrains.com, Inc. 7598 Highway 411 Benton, TN 37307 844-9TRAINS 844-987-2467

• INDEX

• TABLE OF CONTENTS



PUBLISHER'S MUSINGS

editorial

JOE FUGATE



[Click here for
reader comments](#)

PAINTING MODELS IN A POST-FLOQUIL WORLD

FLOQUIL AND THE RELATED ACRYLIC POLLYSCALE

line were for many modelers the go-to paints for model railroading. But as we all know, Testors discontinued the Floquil/PollyScale line of paints in 2013.

The hobby has good post-Floquil/PollyScale alternatives, but we need the replacement paints mapped back to familiar Floquil/PollyScale color equivalents to make getting weened off these now-defunct paints easier. To that end, MRH is starting two color-mapping projects, one for “acrylics” (defined as water-cleanup paints) and another for “lacquers and enamels” (defined as solvent-cleanup paints).

This month I’ll talk about the acrylics mapping since those are my preferred paints. Next month Assistant Editor Don Hanley can discuss the solvent-based paints mapping since he prefers those.

I gave up Floquil paints and moved to PollyScale water-based paints back in the 1990s. Floquil’s solvents had an intense chemical-like odor and after I had a couple of frightening episodes getting double-vision from Floquil solvent odor inhalation, I moved to PollyScale and its less problematic fumes.

PUBLISHER'S MUSINGS | 2

With the demise of Floquil/PollyScale, I have sought out a good replacement. My ideal replacement paint would be:

1. A low odor water-soluble acrylic paint that's price competitive and available in a broad color line.
2. Allows soap-and-water cleanup with no solvents needed.
3. Pre-thinned for airbrushing, but usable as a brush paint for model details.
4. (Optional) Color names expressed in railroad terms like the Floquil/PollyScale line.

I have found three excellent paints that fit my criteria #1 through #3: Badger's ModelFlex, Testors' Model Master acrylics, and Vallejo Model Air/Game Air. You can find more on their websites:

ADVERTISEMENT

REEFER MADNESS!

New runs of the 40' Wood Refrigerator Car in N, HO and O scales are heading your way from Atlas! This highly detailed model is based on the 40' wood refrigerator cars built by Pullman for the Northern Refrigerator Car Co. in 1930. With its rooftop ice hatches, USRA-style fish belly underframe and vertical brake shaft, it is representative of the thousands of similar cars that were built during the "Billboard" era of American railroads.

[CLICK HERE](#)

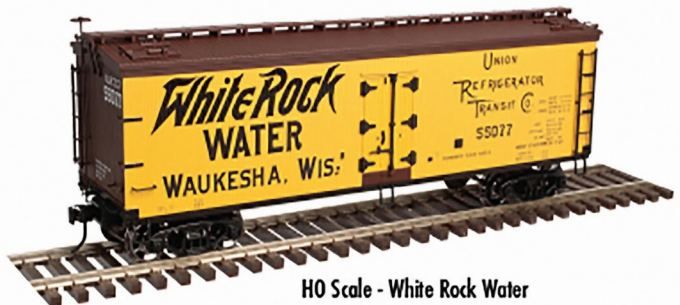

HO Scale - White Rock Water

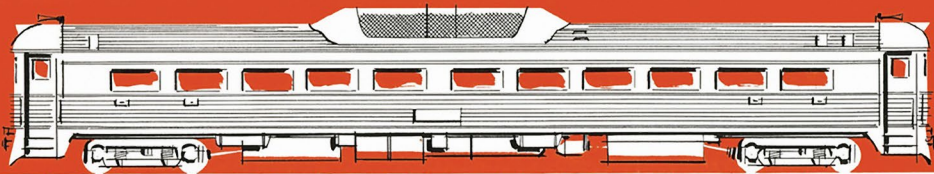

RDC

by Rapido Trains Inc.

Coming in HO.

Order Deadline March 7, 2016

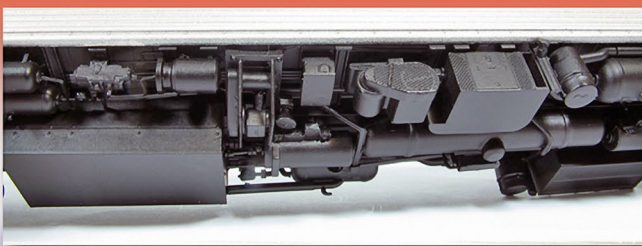

**CLICK
HERE**

Pre-Production Samples Shown

• INDEX

• TABLE OF CONTENTS



Archer

FINE TRANSFERS
PROUDLY SERVING MODEL BUILDERS SINCE 1989

THE ORIGINAL

SURFACE DETAILS™

WE NOW HAVE MORE
THAN 100 SHEETS OF
RIVETS, LOUVERS,
TREADPLATE AND
MORE CAST ONTO
MICROSCALE CLEAR
DECAL FILM

FREE SHIPPING:

- DOMESTIC USA ORDERS
\$50 OR MORE
- INTERNATIONAL ORDERS
\$100 OR MORE

CLICK HERE TO
VISIT OUR WEBSITE!

Archer Fine Transfers • PO Box 1277 • Youngsville, NC 27596 • USA
(919) 570-1026 • info@archertransfers.com • archertransfers.com

*"Archer rivets
are easy to apply
and look great.
To me, they are
now a vital tool
in building
railroad models."*

Tony Thompson, Model
Railroad Author/Historian



TRINITY 3281 SUMMER 2016



Norfolk Southern -- 12 #s



ICE-GATX -- 8 #s



Winchester & Western -- 12 #s



NRLX Ciment Quebec -- 12 #s

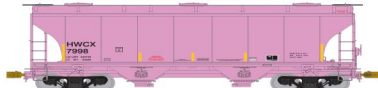

HWCX -- 7 #s

American Limited

www.americanlimitedmodels.com

PUBLISHER'S MUSINGS | 3

ModelFlex (modelflexpaint.com) – 120 colors

Testors Model Master acrylics (testors.com/product-catalog/testors-brands/model-master/acrylic-paint) – 194 colors

Model Air/Game Air (acrylicosvallejo.com/model-paints) – 204 colors
(Also see **MicroLux**: micromark.com/paint-for-brush-and-spray-application.html?page=2)

However, Badger's ModelFlex line has the fewest colors of the three paints in my list. Nevertheless, I do know some modelers who love the ModelFlex line of paints. List price, \$4.25 per 1 oz [29.5ml] bottle.

Testors' Model Master acrylic line comes pre-thinned for airbrushing, but their colors need to be translated to railroad paint names to meet my criteria #4. I've contacted Testors to do a color-for-color translation, so stay tuned. List price, \$3.69 per 0.5 oz [14.7ml] bottle.



FAST TRACKS

YOUR VERY OWN TRACK FACTORY

Make the most of your modeling experience.

Build perfect trackwork easily and inexpensively when YOU want it!



Check out our extensive (and growing!) online video library to learn how easy it is to hand lay your own trackwork with Fast Tracks tools and supplies.

Play Video 



shop online 24/7

1-888-252-3895

handlaidtrack.com

service@fast-tracks.net

• INDEX

• TABLE OF CONTENTS

DISCOVER Your POT of Golden Savings!



YD 
Yankee Dabblers.Com

Click NOW!
(while supplies last)

HO

DCC 

All Scales

- Kadee - NCE - SoundTraxx
- Digitrax - And more!



PUBLISHER'S MUSINGS | 4

Regarding criteria #4 on Model Air/Game Air, Micro-Mark recently rebranded a few Vallejo Model Air paint colors as "MicroLux paint" by color matching them for common Floquil/PollyScale colors like Reefer Yellow and Grimy Black – so that's a start.

As for price, Model Air/Game Air lists at \$3.30 per 0.6 oz [17 ml] bottle. MicroLux lists at \$7.35 per 2 oz (59 ml) bottle.

Micro-Mark selected ten of Vallejo's Model Air paints and re-packaged them into larger 60ml (2 oz.) craft paint flip-top bottles as MicroLux paint. So Micro-Mark's matching their repackaged Vallejo paints to PollyScale paint colors. They further augmented the MicroLux line with some standard 17ml (0.5 oz.) dropper bottles of Model Air.

Thanks to Micro-Mark sending me a sample of the new MicroLux line, I tried out the Vallejo Model Air paints.

The result? I'm impressed with Vallejo Model Air. I find airbrushing Model Air to be

PUBLISHER'S MUSINGS | 5

quite easy, and using Model Air for brush painting details works nicely as well.

The intense ultra-fine pigment and milk-like consistency means these paints cover exceptionally well when using an airbrush. I find the paint self-levels and hugs the details nicely, making it hard to lose details to the paint, even when brush painting.

The paint has an ever-so-slight "floral" odor, and Vallejo says in their official documentation that none of their paints require any "health hazard" warnings. Their soap-and-water cleanup is a big plus for me.

Take the MRH

2016 Reader Survey yet?



TAKE THE SURVEY >>

Click to *Search* the
New **CON-COR** Website



<http://www.con-cor.com/website>

ADVERTISEMENT

Lasercut structures. Highway, storefront and billboard signs.



WHAT'S NEW?



HO-N-O scales
Blair Line

Vallejo's storage method of using dropper squeeze bottles is quite clever, beating glass or hard plastic jars hands down. I find the dropper bottles to be much less messy and the paint keeps longer. Vallejo says the shelf life of Model Air in the dropper bottles should exceed five years.

If you prefer water-soluble pre-thinned model paints as I do, then I want to help you make an easy transition in a post-Floquil world to the Vallejo paints or one of the two other paints I list above.

To this end, I'm building a Floquil/PollyScale color translation chart for these paints as a free subscriber bonus starting with this issue of MRH. My chart is incomplete right now, but I'll update it each month until it's complete.

As a first step, I'm matching the Vallejo Model Air/Game Air paint to paint chips made from the Floquil/PollyScale paints, and also matching the colors to loco shells in cases like Union Pacific Armour Yellow and/or matching to Microscale decal sheets like the nose wings in Southern Pacific Scarlet.

In many cases, I'm finding colors that translate straight across. For instance, MicroLux Grimy Black is a dead-ringer for Floquil/PollyScale Grimy Black.

However, there is no direct match for BN Green in the Model Air/Game Air colors, but mixing 12 parts Lt. Livery Green (72.733), 4 parts Lt. Camo Green (71.006) and 1 part Magic blue (72.721) matches the Floquil/PollyScale paint chip that I have.

As I develop formulas for colors that don't translate one-to-one, I'll be adding them to this free subscriber bonus. Plus I'm including how I put the mixed paint into my own fresh dropper squeeze bottles so they store like all the other Vallejo Model Air paints.

Once I'm done with this first stage of the project, I will have translated all the Floquil/PollyScale paint colors to Vallejo's

PUBLISHER'S MUSINGS | 7

Model Air/Game Air colors. I plan to add tips for transitioning to acrylics in general, along with advice on how I do both brush painting and airbrush painting.

In addition, I'm contacting Badger (ModelFlex) and Testors (Model Master acrylics) to get their paint lines included in this Floquil/PollyScale color-for-color acrylic paint translation to get the most comprehensive guide possible.

Eventually, we'll sell this definitive acrylic model railroad painting guide on the MRH Store, but MRH subscribers will get the "Post-Floquil/PollyScale model railroad painting guide, volume 1: Acrylics" for free.



**Click here for
reader comments**

ADVERTISEMENT

MONSTER modelworks

**Freight Depot
Background Flat Kit**

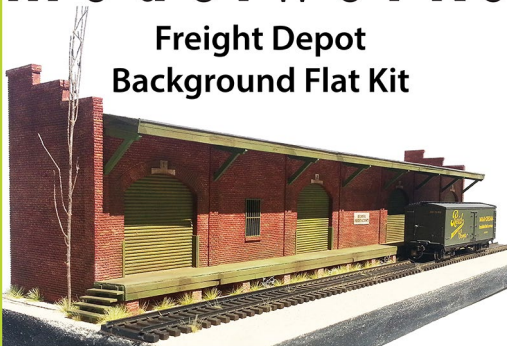

N & HO Scales



www.monstermodelworks.com

NOTE: While I personally am happy with Vallejo Model Air paint, the other two manufacturers' paints also meet my criteria, and many modelers like them too. I encourage modelers who like these two other brands of paints to post their experiences on the comment thread to this editorial. There's also the new Proto-color line, but that's in transition to [Rapido as the new Proto-paint line \(April\)](#), so stay tuned there.

• INDEX

• TABLE OF CONTENTS

**PREORDER
SPECIAL**

Make it run like a **Dream**

By Joe Fugate

EBOOK SERIES: ... hardcopy books also available ...

First time these methods all collected in one place

\$12.99

\$12.99

\$12.99

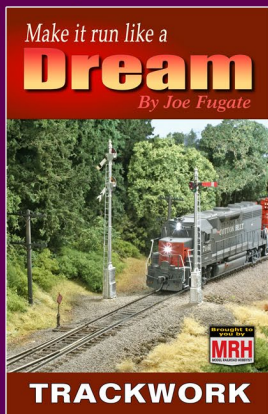

Est release: Jul 2016

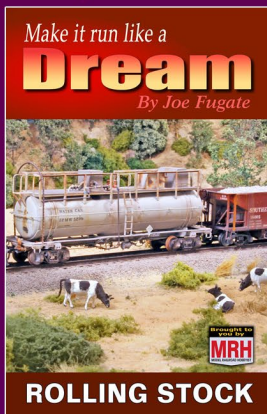

Est release: Jan 2017

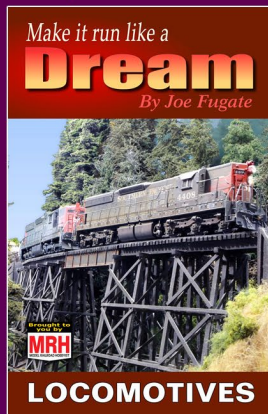

Est release: Jun 2017

*Pre-order customers get sneak peeks at chapters,
and get exclusive access to video shorts ...*

~~**\$38.97**~~ **\$29.99**

PRE-ORDER TODAY >>

store.mrhmag.com

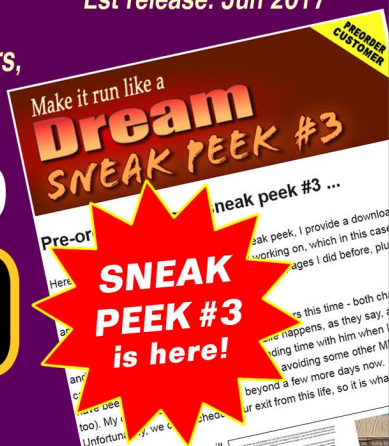



STAFF NOTES



[Click here for
reader comments](#)

THE NEW MRH STAFF PICK AWARD ... AND MORE



EVERY SO OFTEN, ONE OF

the MRH Staff will run across a great web resource for model railroading.

Or, someone will post something really useful to the MRH website forums.

We've decided to recognize the best of such resources with the new *MRH Staff Pick award*. An MRH Staff pick is a notable non-commercial web resource that we, the MRH Staff, feel has great material and is something modelers should bookmark for their reference library. Also, we want to recognize the authors of this material for substantially giving back to our hobby with these well-executed efforts.

If you get selected for this award, we send you an official signed certificate and we recognize you here in MRH magazine. We also add you to an official page on our website that lists all the MRH Staff Pick resources. We also encourage you to include the staff pick logo on your website and in your resources like PDFs or videos you produce.

STAFF NOTES | 2

By displaying the MRH Staff pick logo, this lets modelers know the MRH Staff is highlighting your resource as something to be bookmarked and made a part of their standard reference set.

For the first award, we've picked Luke Towan's superb website, tutorials and videos. If you haven't seen Luke's material then you definitely need to go take a look. Luke is doing an awesome job producing how-to resources on model railroading.

Congratulations, Luke. Well done!

Imagineering column delayed

The next Imagineering columnist up is Ray Dunakin, but he just had a major death in the family, so we're delaying the Imagineering column one more month to allow Ray the time

ADVERTISEMENT

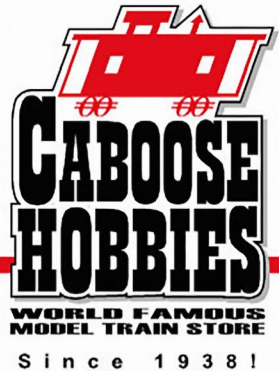

The World's Largest Model Train Store!

Model trains G to Z, DCC, brass models, kits, RTR, collectable models, scenery, structures, books, magazines, DVD's, hobby tools & supplies and a full service repair department.



WWW.CABOOSEHOBBIES.COM

• INDEX

• TABLE OF CONTENTS

mrhmag.com

Staff Pick ✓

MRH
MODEL RAILROAD HOBBYIST

The Staff of *Model Railroad Hobbyist* recognizes

Luke Towan

For model railroading web
resource excellence provided by
the URL:

bouldercreekrailroad.com

Awarded on this date of

March 1, 2016



Joe Fugate
CEO and Publisher



Don Hanley
Assistant Editor

BOULDER CREEK RAILROAD

Home

Tutorials

Gallery

Members

Contact



he needs to focus on the more immediate needs right now: his family. Imagineering should be back next month, either with Ray's column or a column from one on the other columnists.

"One Module" Contest Winners

We have the winners from our "One Module" Challenge Contest!

GRAND PRIZE WINNER:

Peter Vassallo for his Chama, San Juan extension, 1937

FIRST PLACE WINNER:

Rene Gourley for his Pembroke in Proto:87

SECOND PLACE WINNER:

Greg Baker for his SP&S in Redmond, Oregon



MRH
MODEL RAILROAD HOBBYIST

Take the MRH
2016 Reader Survey ...
... and get a chance to win a 10" Kindle Fire tablet!



amazon
fire HD10
OUR LARGEST DISPLAY
ON OUR THINNEST TABLET

TAKE THE SURVEY >>

ADVERTISEMENT



NICK & NORA DESIGNS
Uniquely inspired craftsman kits



Craftsman Structure Kits,
Detail Parts, Shingles & More!
www.nickandnoradesigns.com





LAST ISSUE'S RATINGS

The five top-rated articles in the [February 2016 issue](#) of *Model Railroad Hobbyist* are:

- 4.8 Getting Real: Tank car basics, part 1
- 4.7 DCC Impulses: A dozen more DCC myths
- 4.6 What's Neat: New motor, sagebrush trees, and more ...
- 4.6 Classic backwoods diorama
- 4.4 Publisher's Musings: Building for the future

Issue overall: 4.7

Please rate the articles! Click the reader comments button on each article and select the star rating you think each article deserves. Thanks! ■

ADVERTISEMENT



Your Local **N Scale**
Online Hobby Shop

575-523-9743
fiferhobby.com

• INDEX

• TABLE OF CONTENTS

THIRD PLACE WINNER:

Shawn Becher for his Stocktown, Ferryville & Eastern

HONORABLE MENTIONS:

- Chris Hellewell for his Maine 2 ft Module
- James Eager for his Illinois Central in the late 1960s

Each of these winners will have their submission published in MRH and they will get paid for their article. Also, in line with their ranking, they will get a bonus added to their payment, with the Grand Prize winner getting the largest bonus, the First Place winner getting the second largest bonus, and so on.

If you didn't win, but the staff feels your entry has some interesting twist to it, we may also be contacting you to have you rework your entry into an article submission.

Congratulations to all the winners. The rest of us can look forward to seeing these "TOMA-style" layout designs coming to the pages of MRH throughout the rest of 2016.

What's new on the MRH website?

The MRH website has two major kind of posts: forum posts and blog posts. I like to describe a forum post thread as more of a discussion in a conference room, where everyone is on equal footing and there's no central presenter.

A blog (short for webLOG) is a personal journal and is more like being in a clinic where you can make comments, but there's a main presenter and it's their discussion.

Here's a handful of blog threads from our site. If we didn't select your blog, please don't feel slighted. This is just a quick random grab of a few blogs that have recent new posts.

STAFF NOTES | 7

PeterAtt's blog: mrhmag.com/blog/peteratt

JLandT's blog: mrhmag.com/blog/jlandt

Mikerhea's blog: mrhmag.com/blog/mikerhea

NormanW's blog: mrhmag.com/blog/NormanW

Jmt99atsf's blog: mrhmag.com/blog/jmt99atsf

Ferroequinologist1's blog: mrhmag.com/blog/ferroequinologist1

Be sure to have a look at these blogs. They're often hobby progress journals and it's great fun seeing others doing the hobby!



**Click here for
reader comments**

ADVERTISEMENT

HO GP60M, GP60B AND GP60 Locos



NOW AVAILABLE !



DC OR DCC WITH SOUND!



www.foxvalleymodels.com

ADVERTISEMENT

George's Trains
EST. 1962

Canada's Greatest Model Train Store



ACRYLIC-Air Brush Ready
NOW OVER 45 Canadian Railway Colours!

Dealer inquiries welcome.

20 NEW Colours Just added!

PP-001 CNR Green #11	PP-020 TH&B Maroon	PP-038 TTC CREAM
PP-002 CNR Imitation Gold	PP-021 Primer	PP-039 TTC Maroon
PP-003 CN VIA Blue #16	PP-022 Reducer	PP-040 Warm BLACK
PP004 CN Via Yellow #18	PP-023 Flat Finish	PP-041 Grimy Black
PP-005 VIA Grey	PP-024 Stencil White	PP-042 Anti-Glare Black
PP-006 CN Red/Orange #11	PP-025 Loco Black	PP-043 Slag Brown
PP-007 CN Lettering Grey #17	PP-026 Flat Haze	PP-044 GO Green
PP-008 CN Grey #11	PP-027 CNR LT BLUE	PP-045 GO White
PP-009 CNR Red #12	PP-028 CNR DK BLUE	PP-046 CONRAIL Blue
PP-010 CPR Tuscan	PP-029 CNR YELLOW	
PP-011 CPR Diesel Grey	PP-030 CNR Post 2000 Yellow	
PP-012 CPR Diesel Yellow	PP-031 CNR GREEN	
PP-013 CPR Steam Grey	PP-032 BCR/PGE DK GREEN	
PP-014 CPR Mineral Brown	PP-033 BCR RED	
PP-015 CP Action Red	PP-034 BCR Blue	
PP-016 CP Action Yellow	PP-035 BCR Yellow	
PP-017 CP Action Green	PP-036 BCR/PGE LL GREEN	
PP-018 CP Bright Red	PP-037 GTW Blue	
PP-019 TH&B Cream		

\$8.98 each Canadian

ORDER NOW!

550 Alden Rd. Unit 101 Markham, On, Canada L3R 6A8
Tel: 905-470-6200 Toll Free: 1-877-8TRAINS (887-2467)
www.georgetrains.com

MODEL RAILROAD HOBBYIST MAGAZINE

STATEMENT OF OWNERSHIP, MANAGEMENT, AND AUDIENCE¹

Title of publication: Model Railroad Hobbyist Magazine

- ISSN: 2152-7423

Date of statement: 5 February 2016

Frequency of issue: monthly

- Number of issues published annually: 12
- Lifetime subscription: No charge (just supply email)

Location of office of publication:

Woodburn, Oregon 97071

County, Marion

Names of publisher, editor:

Publisher: Joe Fugate

Editor: Joe Fugate

Owners: Joe and Patty Fugate

Known bondholders, mortgagees, and other security holders

owning or holding one percent or more: none

Extent and Nature of Audience² as of Feb 5, 2016

Total monthly unique device views: 119,549 (based on unique IPs)

Total monthly unique users: 89,660 (determined per [IAB guidelines](#))

Total monthly website visits: 261,034

Percentage of OS/devices used to visit:

Windows: 61.0%

iOS: 16.7%

Android: 11.1%

Macintosh: 9.5%

Linux: 1.1%

All others: 0.5%

Percentage of browsers used to visit:

Chrome: 37.9%

Safari: 19.9%

Firefox: 17.4%

Internet Explorer: 15.6%

Edge: 4.5%

All others: 4.7%

Total mailing list subscribers: 32,730

We certify that the statements made above are correct and complete.

Joe D Fugate Sr., CEO and Publisher; Patricia C. Fugate, Co-owner

Model Railroad Hobbyist Magazine

¹ Per the Alliance for Audited Media and the Interactive Advertising Bureau (IAB), a totally digital publication such as Model Railroad Hobbyist must measure "circulation" by tracking *Audience* per publishing cycle (monthly in the case of MRH) since there is no direct physical publication to count. The Audience statistics reported here follow the strict guidelines set forth in this document published by the IAB and endorsed by the AAMI: <http://www.iab.com/guidelines/iab-measurement-guidelines/#audiencereach>

² Computed and provided by Google Analytics (and can be independently verified by Google as correct and complete).

The Get the Latest Model Railroading News, Tips, Reviews & Opinions

SCOTTY MASON

S H O W
The Original Model Railroad Podcast

-Monthly Interviews

- Modeler's Spotlight: Top Modeler's Talk
- Narrow Gauge Modeling w/Chris Lane
- Contemporary Modeling w/ Mike Rose

-More Product Announcements & Reviews

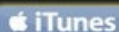

Our feed has changed! To get the latest shows, please search Scotty Mason and subscribe to the new feed!

www.TheModelRailroadPodcast.com

Scott Mason Jimmy Simmons Mike Rose Joe Duckworth

ADVERTISEMENT

ANE MODEL new accessories :

Crossing gate module

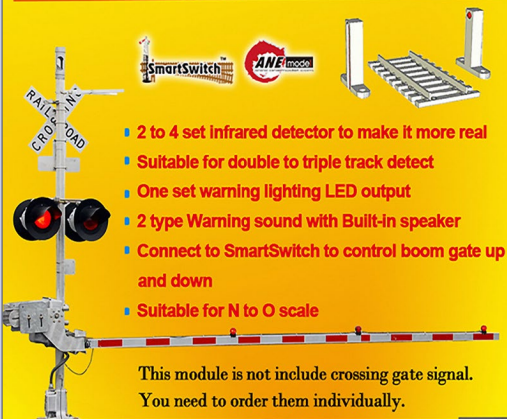

- 2 to 4 set infrared detector to make it more real
- Suitable for double to triple track detect
- One set warning lighting LED output
- 2 type Warning sound with Built-in speaker
- Connect to SmartSwitch to control boom gate up and down
- Suitable for N to O scale

This module is not include crossing gate signal.
You need to order them individually.

ADVERTISEMENT



Quality
Convenience
Variety
Pricing

www.onlinetrainauctions.com

• INDEX

• TABLE OF CONTENTS



SSW and FEC late order GP40-2 available for the first time in Genesis quality

ARRIVING HO GENESIS EMD DIESELS

Railroad-specific details right down to the fuel tanks!

Athena® Genesis® announces the latest run of the EMD GP38-2 and GP40-2 locomotives with prototype specific details and our Genesis motor and drive. These models are truly "As close to real as it gets™."



HO GENESIS EMD GP38-2

DCC-Ready	DCC+Sound	
ATHG65301	ATHG65401	HO GP38-2 Phase 1a, S00/Bandit #4500
ATHG65302	ATHG65402	HO GP38-2 Phase 1a, S00/Bandit #4504
ATHG65303	ATHG65403	HO GP38-2 Phase 1a, S00/Bandit #4510
ATHG65304	ATHG65404	HO GP38-2 Phase 1a, S00/Bandit #4513
ATHG65305	ATHG65405	HO GP38-2 Phase II, CR #8271
ATHG65306	ATHG65406	HO GP38-2 Phase II, CR #8276
ATHG65307	ATHG65407	HO GP38-2 Phase II, CR #8279
ATHG65308	ATHG65408	HO GP38-2 Phase II, CR # 8280
ATHG65309	ATHG65409	HO GP38-2 Phase 1a, D&H #7303
ATHG65310	ATHG65410	HO GP38-2 Phase 1a, D&H #7304
ATHG65311	ATHG65411	HO GP38-2 Phase 1a, D&H #7312
ATHG65312	ATHG65412	HO GP38-2 Phase 1a, D&H #7322
ATHG65313	ATHG65413	HO GP38-2 Phase 1a, DT&I #224
ATHG65314	ATHG65414	HO GP38-2 Phase 1a, DT&I #225
ATHG65315	ATHG65415	HO GP38-2 Phase 1a, DT&I #227
ATHG65316	ATHG65416	HO GP38-2 Phase 1a, DT&I #223
ATHG65317	ATHG65417	HO GP38-2 Phase 1a, DT&I/Bicentennial #1776
ATHG65318	ATHG65418	HO GP38-2 Phase 1a, MKT #304
ATHG65319	ATHG65419	HO GP38-2 Phase 1a, MKT #306
ATHG65320	ATHG65420	HO GP38-2 Phase 1a, MKT #307
ATHG65321	ATHG65421	HO GP38-2 Phase 1a, MKT #312

DCC-READY: \$169.⁹⁸ DCC+SOUND: \$269.⁹⁸

HO GENESIS EMD GP40-2

DCC-Ready	DCC+Sound	
ATHG40788	ATHG40888	HO GP40-2L, Guilford/MEC #500
ATHG40789	ATHG40889	HO GP40-2L, Guilford/MEC #501
ATHG40790	ATHG40890	HO GP40-2L, Guilford/MEC #503
ATHG40791	ATHG40891	HO GP40-2L, Guilford/MEC #506
ATHG40912	ATHG40962	HO GP40-2, FEC #430
ATHG40913	ATHG40963	HO GP40-2, FEC #432
ATHG40914	ATHG40964	HO GP40-2, FEC #433
ATHG40915	ATHG40965	HO GP40-2, FEC #434
ATHG40916	ATHG40966	HO GP40-2, GTW #6413
ATHG40917	ATHG40967	HO GP40-2, GTW #6416
ATHG40918	ATHG40968	HO GP40-2, GTW #6407
ATHG40919	ATHG40969	HO GP40-2, GTW #6422
ATHG40920	ATHG40970	HO GP40-2, L&N #6600
ATHG40921	ATHG40971	HO GP40-2, L&N #6607
ATHG40922	ATHG40972	HO GP40-2, L&N #6611
ATHG40923	ATHG40973	HO GP40-2, L&N #6614
ATHG40924	ATHG40974	HO GP40-2, SSW #7248
ATHG40925	ATHG40975	HO GP40-2, SSW #7253
ATHG40926	ATHG40976	HO GP40-2, SSW #7257
ATHG40927	ATHG40977	HO GP40-2, SSW #7265

DCC-READY: \$169.⁹⁸ DCC+SOUND: \$269.⁹⁸



VISIT
Your Local Retailer

CLICK
Athena.com

CALL
1.800.338.4639

SERIOUS FUN®

©2016 Horizon Hobby, LLC. Athena, Genesis, Ready To Roll, Trains in Miniature, Serious Fun and the Horizon Hobby logo are trademarks or registered trademarks of Horizon Hobby, LLC. All other trademarks, service marks and logos are property of their respective owners. Final models may vary slightly from photos shown. 51878



Model Railroad Hobbyist | March 2016 | #73

MRH Q-A-T

column

compiled by
JOE BRUGGER
.....



[Click here for
reader comments](#)

QUESTIONS AND ANSWERS

Freight cars on the edge

Q. I have a lot of track close to the edge of my benchwork. At what point are the tracks so close to the edge that you will need a guard of some type? I don't want to leave more than about two inches of space between the edge of my track and the end of my world to save aisle space. Is that enough to catch a wayward car in HO scale? Will that require a guard? Thought about just letting the fascia stick up a quarter-inch or so.

—Randy Seiler

A. Blayne: In my book a quarter of an inch is not near enough. I guarantee each time you bounce something off the floor the fascia will grow taller, and if you do it to a brass loco it will only take one. Why ignore the cheapest insurance you can buy?

musgrovejb: I would say six inches of buffer zone would be minimum. Otherwise I would consider Plexiglas along the edge.

▶ MRH QUESTIONS, ANSWERS, AND TIPS

• INDEX

• TABLE OF CONTENTS
.....

MRH Q-A-T | 2

Bill Brillinger: I had an LBF hopper roll sideways off my layout on an outside curve where the track is nearly six inches from the edge. Gravity is amazing.

dark2star: Is it possible for you to use trees, telegraph poles or otherwise strategically placed scenery to prevent your equipment falling off your layout, instead of a “visible” barrier?

Randy Seiler: I think I’ll just cut pretty close to the tracks and figure to add some kind of guard, probably clear Plexiglas. I can’t



1. Trees, foliage, or even a fence or pole line can make a safe barrier to prevent rolling stock from plunging off the edge of a layout. *Rob in Texas photo*

give up six inches or more of aisle space and I can't really put trees or anything in that spot as it is a river on the prototype.

Eric Bergh: I recently had occasion to use some clear one-eighth inch polycarbonate/Lexan for a flexed curving guard on my lathe. I was really impressed with its strength and resilience. It can be cut with woodworking machines, polishes up nicely just like acrylic, but it is not going to snap or shatter like acrylic. It will bend and flex quite a bit if you bump into it, then return to shape. I found mine at TAP Plastics, which has both local stores and an online presence. No doubt you can find it at a local shop dealing with plastic signs, etc.

John Garaty: If you want to be totally safe, then your fence should be at least as high as the height of the roadbed plus the height your highest piece of rolling stock. This means that for anything to hit the floor it would have to “pole vault” over the fence.

Graeme Nitz: I built a “barbwire” fence from inch-and-a-half wire brads and some fine wire. I drove the brads in so that there was about a half-inch poking out. Cut off the heads with a Dremel motor tool, and grind them round so no one gets cut. Then string three strands of the wire and solder each joint. This has caught quite a few pieces of rolling stock from falling into oblivion. It was two or three inches from the edge.

Read more layout edge suggestions and other ideas for materials at mrhmag.com/node/24916.

Roofwalk glue

Q. A few months ago I picked up an Athearn FMC covered hopper with etched-metal roofwalks that had bowed up in

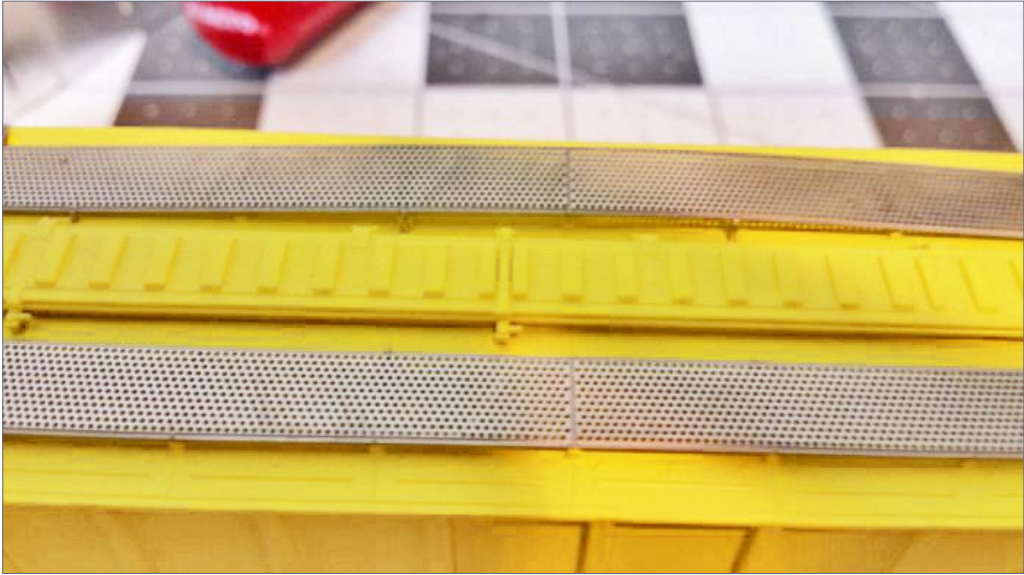

2. Poor assembly or temperature changes can cause etched-metal details to pop loose from plastic models. Fixing the problem is not always easy.

a couple places. As you can see [2], they are attached with a series of pins into the car body. Two of these pins are loose on one side and one on the other. What would be the best way to re-attach these? I haven't found a way to get inside the car so I think that is out of the question.

—arinella

A. Rob Spangler: I don't know about this being the "best" way, but I try to go about it like so...

1. Check between the place that's bowed up and the closer end of the car. Try to figure out if the roofwalk is coming loose because the end is attached in such a location as to place stress on the rest of the roofwalk that's forcing it upward. If necessary,

break a few attachment points loose so you can flatten the roofwalk by allowing a few supports to move in their mounting holes. Sometimes that isn't the problem, or isn't necessary, so move to...

2. Re-attach the roofwalk using flexible CA like Microbond or Poly Zap. Apply the glue with something like a piece of wire or scrap of paper if you need to get it between the running board and the roof. Flexible CAs tend to have longer setting times than the standard kind, which helps get the parts lined up before the glue sets. It may be helpful to use some CA accelerator.

3. If you accidentally fill any holes with glue, drill them out or remove the excess with a knife.

Slow orders

Q. We modified some trackwork on our layout and want to post a slow order to draw our crews' attention to the change. How do we go about this?

—Watson

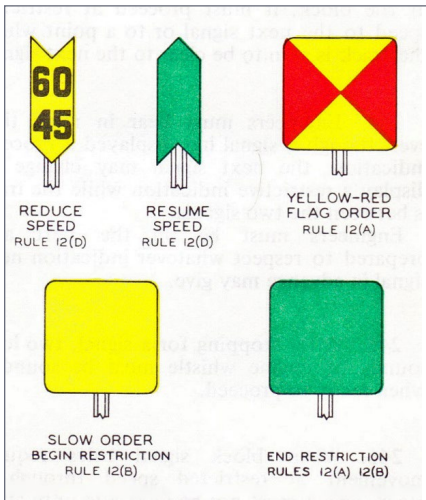

A. The answer depends on your dispatching system. Under train orders, you would use the wording contained in Form X:

1) *Do not exceed* ___ MPH *between* ___ *and* ___.

Or

2) *Do not exceed* ___ MPH *on* *No* ___ *track between* ___ *and* ___.

3. Speed restriction signs.
Union Pacific

MRH Q-A-T | 6

These examples can be modified by adding location of condition by mile posts, or time as:

801 am until 501 pm

Under most other North American dispatching systems,

Track bulletins will be issued by the train dispatcher as required, containing information as to all conditions affecting the safe movement of trains or engines. In addition to track bulletin Forms A and B, other forms may be used as necessary. That's from General Code of Operating Rules, Second Edition, effective October 29, 1989.

TRACK BULLETIN FORM A

NO. _____ ON _____ SUBDIV. _____ 19____
 TO _____ AT _____

BETWEEN POINTS SHOWN IN LINES 1 THROUGH 10 BELOW DO NOT EXCEED SPEED GIVEN:
 (Under column headed "FLAGS" enter "ARE" if displayed or "NOT" if not displayed. Use last two columns when displayed less than distance prescribed by Rule 10 to indicate location and direction.)

LINE VOID	LINE NO.	LIMITS:		BETWEEN:		SPEED	TRACK(S)	FLAGS	AT	FOR
		MP	TO MP	STATION	& STATION	MPH			MP	DIRECTION
	1.									
	2.									
	3.									
	4.									
	5.									
	6.									
	7.									
	8.									
	9.									
	10.									

11. OTHER CONDITIONS: _____

OK _____ M COPIED BY _____ DISPATCHER _____
 RELAYED TO _____

TRACK BULLETIN FORM B

NO. _____ ON _____ SUBDIV. _____ 19____
 TO _____ AT _____

ON _____ (date) BE GOVERNED BY RULE 455 WITHIN THE FOLLOWING LIMITS:

LINE VOID	LINE NO.	LIMITS:		BETWEEN:		FROM	UNTIL	TRACK(S)	FOREMAN	STOP
		MP	TO MP	STATION	& STATION				or GANG NO.	
	1.					M	M			
	2.					M	M			
	3.					M	M			
	4.					M	M			
	5.					M	M			
	6.					M	M			
	7.					M	M			
	8.					M	M			
	9.					M	M			
	10.					M	M			

OK _____ M COPIED BY _____ DISPATCHER _____
 RELAYED TO _____

Several editions of the GCOR are available online in PDF form. Search with Google for “General Code of Operating Rules” and it will show up.

The conductor and engineer must receive a track warrant at their initial station unless otherwise instructed by the train dispatcher. All track bulletins that affect their movement must be listed on the track warrant. The conductor and engineer must have copies of all track bulletins listed, and are required to have read and understood them.

If you want to go for something more visual, you can use “Protection of Track Work” signs [3] under Rule 12 and Rule 14. The vertical signs are generally used for permanent restrictions and the square ones for temporary situations.

A Rule 12 (B) yellow flag (usually a steel square painted yellow and mounted on a post) placed on the right side of the track facing an oncoming train indicates that restricted speed begins at a specified distance from the sign, often one or two miles. Speed must not be increased until the entire train has passed a green flag or a green signal light displayed to the right side of the track indicating the end of the restriction.

Make the signs with brass, card, or styrene on a piece of wire or straight pin.

Rule 12 wording varies among rulebooks, so it can help to check the rulebook used by the company you are modeling.

The yellow-red sign illustration is from a 1972 Union Pacific/Spokane International Maintenance of Way and Signal rulebook, which says:

12 (A). A train or engine finding a yellow-red reflectorized sign displayed to the right of the track as viewed from an approaching train, must proceed prepared to stop for a red flag or a red

light two miles beyond the yellow-red signal. In the absence of a red signal at that location, train or engine may proceed, but must move prepared to stop short of men or machines on or foul of track without flag protection until proceed signal, given with yellow flag or yellow light is received, or proper verbal information is received from employe in charge, or rear of train has passed a green flag or green reflectorized sign displayed to the right of the track.

What's the difference between a Form A and a Form B? We asked an experienced Amtrak engineer.

He said the primary difference is what the two different forms are used for ...

“Form A is for issuing temporary slow orders that limit the track speed at a given location. This occurs if the track is unsafe for normal speed as determined by the track department or unusual circumstance exists like report of vehicle on the track ...

“Form B is used to protect men and/or equipment and establishes a person in charge of train movements thru a given area.

“Both of these forms could be used in model form, although the “foreman” in charge of a form B wouldn't really have anybody/thing to “clear up” before calling a train through. Still, it might make for an interesting radio dialogue!”

—MRH and AmtrakPetey



TIPS

Tile scraps

A small piece of smooth glazed tile is ideal for dispensing small amounts of CA and other adhesives. Squeeze a bubble onto the tile and pick up the amount you need with a small applicator

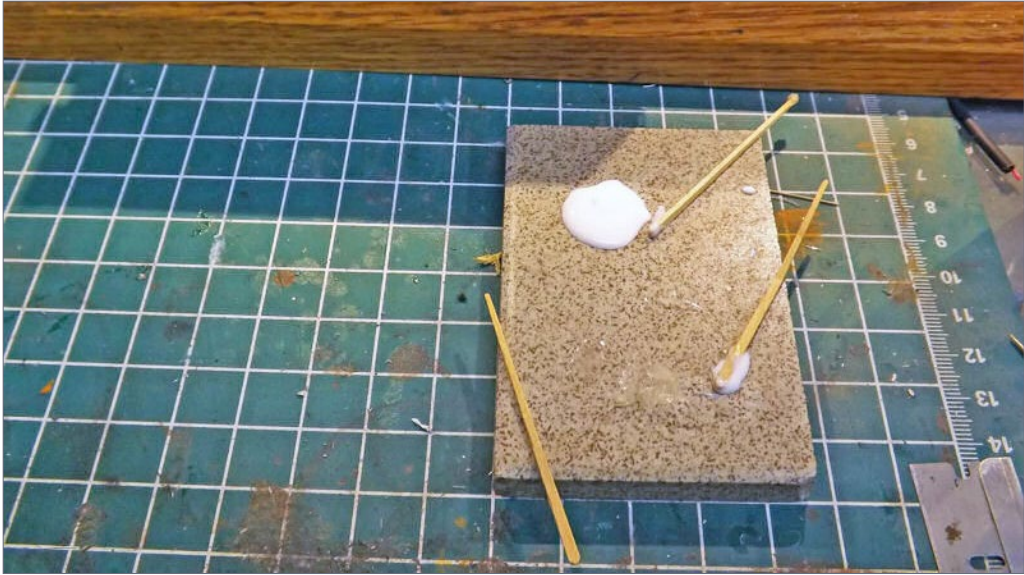

4. A small piece of tile is an ideal workbench palette for small dabs of CA, epoxy, or paint. Tile is heavy enough to stay in place and can be wiped or scraped clean. *Bob Bochenek photo*

or toothpick. What makes this especially neat is that I let the unused material just dry and then just a quick swipe of the single-edge razor blade makes it clean again for re-use. This beats using paper or cardboard which can suck up the moisture, or trying to find a scrap piece of styrene to use.

—Bob Bochenek

Check out a long thread of other helpful readers' workshop tips at mrhmag.com/node/19337.



**Click here for
reader comments**



GET PAID FOR YOUR TIP

We pay \$25 per tip we publish, or \$40 each if the tip also includes a photo or finished drawing. [Click here and select article type TIP.](#) ■
.....



**Click here for
reader comments**

ADVERTISEMENT



**1st choice for model
railway supplies
and service.**

**Expedited mail
service available
across North America.**

Click to visit
WWW.CVRCO.COM
1 800 464 1730



 NORTH AMERICAN RAILCAR CORPORATION
NORTH AMERICAN RAILCAR CORPORATION

DO YOU MODEL ANY OF THESE ROADS?
NEW TOOLING COMING!!!
WE WILL SOON BE TAKING ORDERS FOR 2 BRAND NEW, NEVER BEFORE RELEASED MODELS... FOR ALL OF THESE ROADS.
STAY TUNED FOR MORE INFORMATION ON OUR FIRST 2 RELEASES.



Pickens



St Lawrence



Chessie System



NARC Cars are sold exclusively through

Pacific Western Rail Systems

• INDEX

• TABLE OF CONTENTS

ZEPHYR xtra™

\$255 MSRP



All-In-One Throttle / Command Station /
Booster to run your layout!

Super EMPIRE BUILDER xtra™

\$355 MSRP



Super Empire Builder Xtra has everything you
need to get started in Advanced Digitrax
Command Control.



Complete Train Control

Digitrax Starter Sets for great operation!

View more at: www.digitrax.com

Super **Chief** *xtra*™
\$455 MSRP



Maximum capacity, maximum features.
Take it to the Max with Super Chief Xtra!

MRC's Tech 6 . . .



What is it?

Is it an advanced throttle that runs DC trains and can unleash onboard sounds...without switching to DCC?

Does it let you enjoy as many of the 28 sounds and lighting functions your sound decoder equipped loco has to offer... without buying a DCC system?

Will it run most DC railroads as well as allow you to enjoy advantages that until now were only available to DCC railroaders?

For answers and more info
CLICK HERE....



MODEL RECTIFIER CORPORATION
 80 Newfield Ave. ■ Edison, New Jersey 08837 ■ Phone: 732 225 6360 ■ www.modelrectifier.com

TECHNOLOGY. PERFECTED.

Model railroads Plastic model kits Battery chargers Radio control helicopters, planes, cars & boats Slot Cars Scenery Die cast

• INDEX

• TABLE OF CONTENTS



DCC IMPULSES

column

BRUCE PETRARCA
.....



[Click here for
reader comments](#)

Is DCC DEAD?

No, THIS IS NOT GOING TO BE A DOOM AND gloom nightmare. I'm just going to push some paradigms a bit.



1. Circa 1975 Texas Instrument digital watch.

It is very easy to ignore things that are out of your mainstream of thought. For example,

Texas Instruments almost bankrupted Timex in the 1970s. TI came out with a LED watch [1] and Timex ignored it because it didn't have wheels and hands and was from an electronics company. The digital watch caught on and Timex was struggling to compete for a few years.

► DCC TIPS, TRICKS, AND TECHNIQUES

DCC IMPULSES | 2

I have seen advertisements over the last few months (maybe a year or so, I don't remember) for the MRH advertiser Bachmann and their E-Z App locomotives and train sets. They have a catchy logo [2]. At a quick glance, I dismissed them as something for the "toy train" folks and not for real "hobbyists."

While I maintain my position on the quality of the product that Bachmann has installed the technology in, I have discovered that this technology might be the camel nose under the tent flap of DCC.

How can that be? Well, hang on, let's check this out

How would you like to run your trains without a DCC system, but still have the motor and function control that we have come to love? Oh, yes, that would be wirelessly, without expensive radio cabs and a base station. In addition, how about:

- Add sound for less than \$20, even after the fact?
- Use DCC, DC or battery to power your locomotive?
- Control your loco from as far as 150 feet away?
- Update your decoder in a couple of minutes without removing it from the loco?



2. Bachmann's E-Z App™ logo.

I was introduced to David Rees, the CEO of BlueRail Trains (bluerailtrains.com) by Pete Steinmetz. Pete is a member of the Dead Rail Society (deadrailsociety.com) and owner of Dead Rail Installs (deadrailinstall.com). I respect Pete's knowledge of lithium

DCC IMPULSES | 3

batteries and his influence in the on-board power world. Recently, Pete was getting together with David to do some tweaking on the product that BlueRail Trains is getting ready to release. It may be available by the time you see this in print.

Here is what I learned by talking with David.

BP: What are you folks preparing to sell this spring?

DR: We are offering a board [3] that is small enough (58 x 28 x 7 mm or 2.28 x 1.1 x 0.28 inches) to fit in some HO or larger locomotives. It will use the 9-pin JST connector commonly used in DCC as its interface and is plug-compatible with DCC-ready locos having that plug. It has 4 functions for lights and will provide up to 2 amps stall current for the motor(s). If it is plugged into an unmodified DCC loco, it will take power from the track

ADVERTISEMENT



Fun Features for a Fraction of the Cost!

As the most versatile, feature-packed sound decoder, **Econami** redefines *value*. Starting at \$79.95 and available now!



Hear how you can get more for less!

SOUNDTRAXX

• INDEX

• TABLE OF CONTENTS

DCC IMPULSES | 4

and control the loco completely by Bluetooth from your smart-phone at distances up to 150 feet away.

There is a video from our web site with more information (youtu.be/Hrokc9KQOHA) about this initial direct offering.

The motive power from the track can be DC or DCC. If you are running the loco on a DCC track, you will only be taking power from the DCC system. The control will not come from the DCC data. Control will come over the air with your smartphone talking directly to the loco.

BP: Wow, this is blowing my mind. What about battery operation?

DR: There is a place to connect a battery in the 12 to 24 volt range to the board. With this, you can be totally self-contained. The loco could sit on your wood desk and run until the battery goes dead. Or you can use a smaller capacity battery as an energy support device to help the loco over areas of less-than-perfect contact with the rail power.

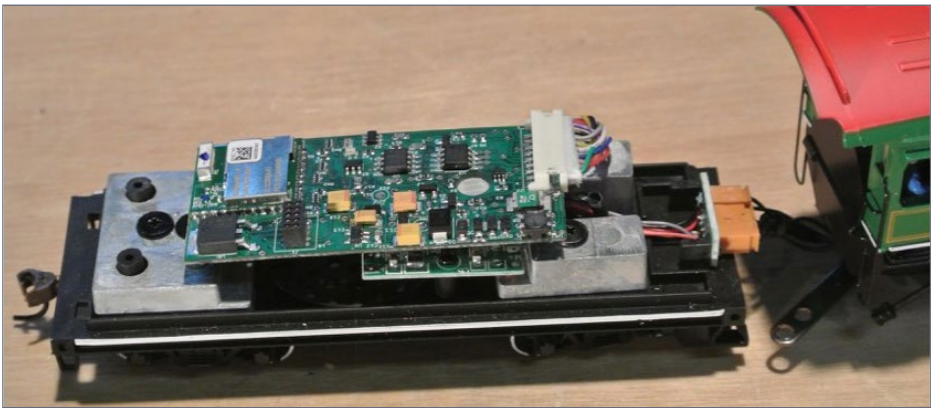

3. BlueRail Trains' first board is plug-compatible with DCC locomotives using a 9-pin JST connector.

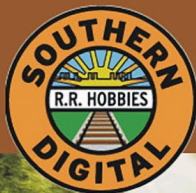

Southern Digital



**20% Discount
on most Items!**

Specializing in DCC Since 1992



DCC Conversions, Service & Support

Orders Received by 3:00 pm EST ship the same day

WWW.SODIGI.COM

E-mail: sales@sodigi.com

(770) 929-1888

(Photo's are from our N-Scale layout)

DCC IMPULSES | 5

For smoothest operation in the energy support mode you will want to select a battery voltage about ½ volt to 2 volts higher than your track voltage. This will have the transition from track power to battery power not affect the loco speed noticeably, even as the battery discharges a bit. This also allows for convenient battery selection. Battery voltage more than 5 volts above the track power will cause a change in speed with the loss of track power.

BP: So, let me see if I get this right. If I plug one of your boards into my loco, I can put it on a track that is powered by an inexpensive DC power supply and run it with my cell phone? No cost for a DCC system or for a lot of other hardware? None of the set-up hassles of other forms of software control? No expensive radio throttles or base stations?

DR: Yes, that is correct.

BP: Many of us have been in the situation where we install a DCC decoder and need to update it. So, we take it out and send it back to the manufacturer. We are out the cost of postage to send it back, plus the loss of use, plus the time to remove and reinstall it. How do BlueRail Trains boards get updated?

DR: When you launch the app, the app checks your train's firmware version. If there is a newer version available, the app offers you a chance to upgrade the firmware. Upgrading firmware is accomplished with one click. It is about a 2 minute process. Of course, you will need an active Internet connection and the loco must be powered up for the update process to go forward.

BP: Let's back up and talk about how BlueRail Trains got started.

DCC IMPULSES | 6

DR: About 6 years ago, I was working on a 3-rail O scale layout and looking for better ways to control it. I discussed a concept with two friends (Pete Skeggs and Eric Laun) and we came up with the original prototype board [4]. This board was called “Box Car Willie Version 1” as it was our first attempt to control the motor on a locomotive using the new Bluetooth Smart (V.4) communications standard. It was so big that it needed to be installed in a trailing box car. The three of us formed BlueRail Trains to continue developing this concept.

What this “concept” board allowed us to do is to control the speed and direction of our locomotive with our iPhones. The power came from the track through our board to the motor. The iPhone provided the throttle mechanism via Bluetooth radio.

ADVERTISEMENT

ADVERTISEMENT

DCC and Sound in N Scale?

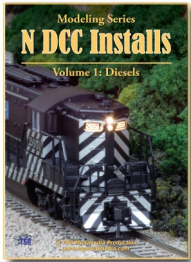

We'll show you how!
N DCC Installs
Examples with and without sound!

CLICK FOR DCC 

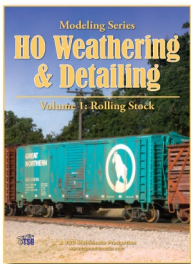

Want it now?
Our titles are now available in digital download format!

CLICK FOR DIGITAL 



TSG Multimedia

• INDEX



Installing DCC sound just **NOT** your thing?

Trust Traintek for sales and installation of sound decoders from these fine vendors!



RailPro™

“Taking model railroad control to the next level ...”



traintekllc.com

Click here for more details...



“Traintek was the way to go!”



• TABLE OF CONTENTS

DCC IMPULSES | 7

BP: What came next?

DR: Within a few months, we were able to shrink the module until we could install it in an HO-scale F unit. We called this Box Car Willie Version 2, even though it was installed inside an HO locomotive [5].

After we had the smaller board and our iPhone app working, we partnered with Bachmann. They licensed our technology and put it in some locos, trademarking it as E-Z App.



4. Box Car Willie Version 1, BlueRail Trains' first prototype board connected to a Lionel 3-rail locomotive.

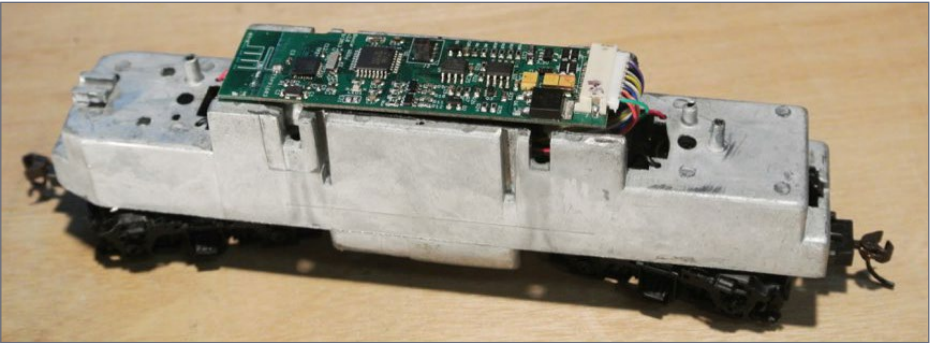

5. BoxCar Willie Version 2 - miniaturization allowed an installation into a Stewart HO F unit.

Great control in a tiny package



**Original
Touch Toggles**

- Touch Toggle™ plug in controls
- Bright clear indication
- Easy setup
- Flexible system

Stall Motors, Twin-coils,
Power, and Servos

Now for Tam Valley Depot
and MRservo too!



Made in the USA



What will they think of next?

www.berretthillshop.com

IOWA SCALED ENGINEERING

Exciting and
affordable
sound player
for your model
railroad



LEARN MORE >

TamValleyDepot.com

Great Electronics for Great Model Railroads



We are loading up the boxcars with
Frog Juicers ready for your layout!

DCC IMPULSES | 8

All of our Bluetooth products (BlueRail Trains plugin boards or Bachmann E-Z App trains) can be controlled by the BlueRail Trains free app. The Bachmann E-Z App assumes you have a standard headlight configuration (like most out-of-the-box trains).

The BlueRail Trains app is more adjustable. It allows you to configure lights and accessories. You can performance-tune your specific loco. The iOS app is available in the Apple App store (supports iPhone 4s or later, or iPad 3 or later, or iPod Touch 5 or later). The Android version is expected late Q1 2016.

BP: Do you have a price range for your plug-in board?

DR: We are working with our suppliers just now to firm up pricing. Our goal is well below \$100.

BP: How do you do sounds?

DR: Our BlueRail plugin boards have an expansion port designed to accommodate a future sound module. The control app also contains in-app sounds which can be played either on the smart device or through Bluetooth speakers (either on your layout or in a train).

For a single loco solution, a small Groove Cube speaker can be purchased in the \$15 range and housed in a loco or trailing car [6]. This is detailed on a video from our web site (youtu.be/lB4HT-9jFQ).

BP: I found the Groove Cube speaker on Amazon.

DR: This package includes the speaker, Bluetooth receiver and battery. It only needs to be installed so that the sound has a path from the grille to your ear. The stock car, with the holes in the sides, is perfect for this. You also need access to the jack on the speaker to charge the internal battery.

TONY'S TRAIN XCHANGE

Committed to your DCC support!

Tony's Is Your Locomotive Price Leader!

Steam



Athearn Genesis, Bachmann, Broadway Limited Imports, MTH, Rapido, Rivarossi & More

Starting at \$129.95

[View Stock](#)

Diesel



Athearn, Atlas, Bowser, Broadway Limited, Intermountain, Kato, Korea Brass, Walthers & More

Starting at \$97.95

[View Stock](#)

Tony's Carries A Complete Wiring Line



Stranded Bus Wire, Drop Wire, Layout Wiring Kits, Decoder Wire, Locomotive Wiring Kits, Connectors, Etc.

Miniatronics, NCE, TCS & More

[View Stock](#)

Do you need a Sound or DCC Installation done?

Get a quote!



Providing unmatched person to person DCC support for more than 25 years, the kind of service that has made us #1 in DCC.

DCC questions? CALL US! 1-800-978-3472

*Mention this ad for \$5.00 off your next order over \$100!

We'll get you on the right track!

Oct 2015



• INDEX

• TABLE OF CONTENTS

DCC IMPULSES | 9

BP: I cannot get my iPhone to talk to more than one Bluetooth device at a time. How do we get multiple sounds on the layout at once?

DR: You are right. The protocol in smartphones only allows you to connect to one set of Bluetooth speakers at a time. We have a solution in mind that will allow you to expand this in increments of 7 locos (7, 14, 28 etc.). We will be pursuing support for both a sound decoder-type module as well as more extensive use of Bluetooth speakers.

BP: How do you performance-tune your loco with the BlueRail Trains board and app?

DR: The board drives the motors with high frequency (16 kHz) Pulse Width Modulation (PWM). We have carefully tuned the PID (motor control circuitry) to a setting that gives very good slow speed operation (newer DCC decoders have CV variables that allow for this).

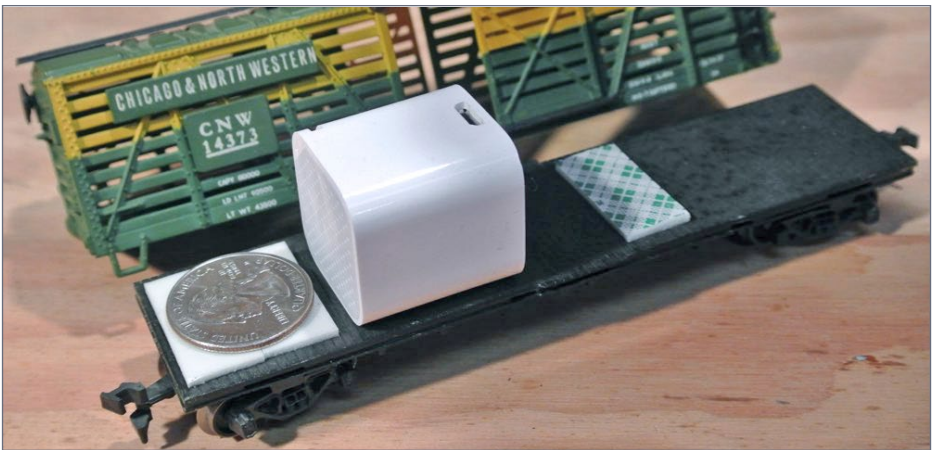

6. Bluetooth (Groove Cube) speaker installed in a stock car to be pulled behind the loco. Sound added for under \$20.

DCC IMPULSES | 10

Because these boards can be installed in anything that has an electric motor, the BlueRail app will give users access to tweak these variables if they desire. The “out-of-the-box” settings work great for 90% of engines. The “start voltage” and the “update period” are the only variables I have needed to adjust to tune slow speed on certain locos.

To tune the PID, you run your train at a slow speed, open the tuning panel, and adjust a few options in real-time as you watch your train move. Users will have a simple tuning panel to make easy tweaks, as well as a more in-depth panel that lets you play with all the variables.

Outside of the PID tuning, users are able to set minimum speed step, acceleration, deceleration, and calibrate chuff rate. The

ADVERTISEMENT

Make LocoNet wiring extremely simple!

ACCU-LITES, inc

Your DCC Center!

CELEBRATING
20
YEARS
ANNIVERSARY

Dealer Inquiries Accepted

PM42
breakout
board



BDL168
Multi-zone
breakout board



SE8C
breakout
board



BDL168
Single-zone
breakout board

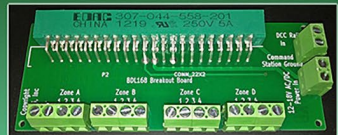

Now Offering SNAPS! in packs of 6 or 12 pieces! [CLICK TO LEARN MORE ...](#)

• INDEX

• TABLE OF CONTENTS

15
YEARS
ANNIVERSARY 2016
2001

Litchfield

S T A T I O N

www.LitchfieldStation.com

623-298-7355

Making
DCC FUN
for 15 Years!

Everything Digital
Command Control
Command Systems
Decoders,
Layouts,
Command Systems
Accessories
& More!

ease of using these interfaces is one of the nicer advantages of this system.

BP: What are your plans going forward?

DR: We will be making BlueRail Trains boards in several sizes for various scales in the next little while. Some of the ideas are shown at the end of the video about our first board. That video and others about our product, including a demo of our operating range, can be found on our web site (bluerailtrains.com/videos).

BP: Thank you David Rees, from BlueRail Trains. I look forward to running my Fn3 garden trains with a future board from your company.

So, folks, that's it.

Think about this in the foreseeable future. A bedroom-sized HO layout with two trains running simultaneously would need two BlueRail Trains boards (under \$200) and a 1.5 amp, 12 to 15 volt power supply (under \$10 on allelectronics.com) and two Groove Cube speakers (\$15 each) plus two smartphones that you probably already have. That's under \$250, perhaps near \$200. The least expensive way to do the same with DCC is with a Sprog3 (\$135) plus two Econami decoders (\$160) for a total of \$295 plus the two smartphones.

Yes, two smartphones. I'm an operations-oriented guy. That means one throttle per operator per train. You can easily jump from one train to another with the app. If you want to watch trains go around in circle, you only need one smartphone.

In the garden, I can see a much greater cost savings. In many ways, the larger and more complex the layout, the more cost advantageous BlueRail Train's solution becomes: no multiple boosters and circuit breakers; no layout wiring; no reversing loop controllers. If you want rail power, hook up a power supply to the

DCC IMPULSES | 12

track, making sure that it is designed to tolerate shorts without damage or fire.

I'm looking forward to getting my hands on some hardware (and the app).

Well, let's talk about this on the MRH blog for this column. Just click on the Reader Feedback icon at the beginning or the end of the column. While you are there, I encourage you to rate the column. "Awesome" is always appreciated. Thanks.

Until next month, I wish you green boards in all your endeavors. ✓



Click here for reader comments

ADVERTISEMENT



NEW TECHNOLOGY



Click Here to Learn More



RE RING RailPro Power ON Main Page
Handheld Controller Model # HC-2

Control Locomotive (CO) [Battery Icon]

17.6% [Link Icon] [Forward Icon]

UP 5714 [Info Icon]

Frnt Light Dim Dilch Pop Off Next Page 1
Horn Bell Engine Back Light Exit Page



NEW Starter Kit \$399.99 MSRP

- Includes Wireless Color Touch Screen Handheld Controller and 56 Watt Power Supply
- Expandable to Virtually any Size Layout

NEW Locomotive Module LM-2 & LM-2S 

- Direct Radio RF
- Sound and Non-Sound
- New Tiny Size
- 6 Light Outputs

For more information visit our Internet site: www.RingEngineering.com



LokSound L -Premium Quality Low Cost DCC and Sound in O Scale!

Coming Soon in "Atlas O"



Each Decoder set
comes with Decoder
and Adaptor board



FULL FEATURED "LOKSOUND L SELECT"

ESU Item# 73399 ****ONLY \$149.99****
Shipping Now!

- Dimensions: 1 Inch x 2 inch
- Amperage: 3Amps continuous (up to 4Amps for a short time)
Overload Protected
- Function Outputs: 11(!)
- Servo Outputs: 2
- And More Features!

-
- Perfect for ESU Synchronized Smoke Units 54678 and 54679 with supported Sound Files
 - Smoke units will work with Steam and Diesel files
 - Smoke units can be set up to work with Smoke Chuff and Cylinder Steam!

**Click here for
MORE FEATURES ...**

Also Available: 54399 Fully Programmable LokSound L V4.0 199.99

ESU LLC 23 Howard Street Montoursville PA 17754 - 1-570-980-1980

www.LokSound.com

From first train set to railroad empire...

*Our complete line of DCC products
grows with you. Discover the fun!*

- Designed and manufactured in the U.S.A.
- Preferred for ease of use and ergonomic design
- Unlimited scalability for any size model railroad
- Plug-and-play means more time running trains
- Great customer service and excellent support



See your dealer



Visit our new and improved web site for all your DCC needs!

- Get the latest new product announcements
- Watch our detailed how-to videos
- Browse the all-new Information Station
- Enjoy secure online sales, day or night!

Visit **ncedcc.com**



ALCO/MLW FA-2 & FPA-2

FPA-2: FIRST TIME EVER IN HO SCALE



Pre-Production Sample Shown

<i>Baltimore & Ohio</i>	<i>Great Northern</i>
<i>Canadian National (Delivery)</i>	<i>Lehigh Valley</i>
<i>Canadian National (New herald)</i>	<i>New York Central</i>
<i>Canadian Pacific (Block)</i>	<i>Pennsylvania</i>
<i>Canadian Pacific (Script)</i>	<i>Undecorated</i>
<i>Erie</i>	

Roadname-specific details - Accurate body contours - Heavy, die-cast chassis - 5-pole, skew-wound motor with excellent slow-speed performance - Operating number boards, headlights and two-color class lights - Dynamic brakes - Etched-metal grilles (Farr or chicken wire, as appropriate) - Full underbody piping and conduits - Correct, roadname-specific FA-2 and FPA-2 fuel tanks - Separate grab irons and handrails installed at the factory - Full cab interior - Accurate sounds

**CLICK
HERE**

**Order Deadline
May 24th 2016**



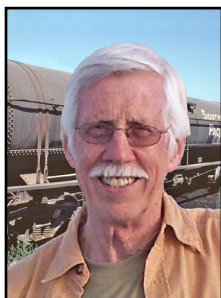

GETTING REAL

column

TONY THOMPSON
.....



[Click here for
reader comments](#)

TANK CAR BASICS: PART 2

| ACCURATE TANK CAR MODELING FOLLOWS
THE PROTOTYPE

PART 1 SUMMARIZED THE HISTORY OF tank car construction and regulation for the period up to and including the 1950s. It showed details of car appliances, along with a description of tank cars in service. In Part 2, the intent is to show examples of modeling approaches that take advantage of the prototype information in Part 1, with emphasis on HO scale, my own modeling scale. These are not descriptions of modeling projects as such, just indications of what models may be possible, and ways to address them.

It is useful to begin by reminding modelers that though there have been many commercial tank car models down through the years, before about 1990 these were usually rather generic. They often did not match any specific car exactly; they were also often oversize, perhaps reflecting a desire by manufacturers

▶ **MODELING REAL RAILROADS AND WHAT THEY DO**

that these models would have bulk “comparable” to house and other larger freight car models. In more recent years, a number of outstanding accurate models have arrived on the market. But all of them have their place in developing a model tank car fleet, as described below.

There have been a great many articles in the model press about tank car modeling, and in more recent years, some have provided excellent guidance toward prototype accuracy. It is of course impossible to review all of these, but some of the landmark articles are listed in the Bibliography, and are mentioned in the text of this column.

Basic modeling approaches

The simplest approach, of course, is to identify an accurate model, with accurate paint and lettering, as produced by the manufacturer. This may or may not be a ready-to-run car. Many brass tank car models, especially an excellent series produced by Overland Models, have been highly accurate. Styrene kits and ready-to-run cars from Proto2000 (now Walthers), modeling the AC&F Type 21, and InterMountain, modeling the AC&F Type 27, are dependable car bodies, even if every paint scheme may not be accurate. The recent Tangent models are quite accurate in construction and decoration.

Resin kits from Sunshine Models, Southern Car & Foundry, Resin Car Works, and others, are also in most cases very faithful to prototype [1]. Painting and lettering these models may call for access to resources of the kind provided in the Bibliography of Part 1.

But for many potential prototype cars you might wish to model, it is necessary to do more. My preference is to try and use an existing kit underframe, and an existing kit tank, or both, whether or



1. One of the Southern Car & Foundry tank car models, a superbly designed and executed resin kit, modeling a car which has had two end compartments added after the car was built, thus the smaller domes at each end. Moreover, it is a Standard Tank Car Company design, with its distinctive STC bolsters. Paint scheme exactly follows a prototype photo, including Du Pont's typical light gray paint (rendered incorrectly on some models as silver).

not those parts were made to go together. And if really necessary, one can, with surprising ease, scratchbuild a tank or an underframe to be combined, or to mix with kit underframes or tanks. I describe each approach below.

Upgrading models

This may mean upgrading details (especially brake gear, a highly visible part of tank cars and thus worth upgrading), or perhaps

correcting a deficiency. One good example of that is conversion of the Athearn 12,500-gallon tank car to the Southern Pacific outline. The SP car is almost certainly the prototype of the Athearn model but as manufactured, it has some shortcomings. I will explain these briefly below, though a full article on this conversion, entitled “Modeling SP tank cars,” has been published (see Bibliography), and it should be consulted for details. An updated version is online at: modelingthesp.blogspot.com/2011/05/modeling-sp-tank-cars.htm.

The most glaring deficiency of this model is its dome height, an artifact of Athearn’s production of three-compartment cars with lower dome heights. This is evident when comparing a corrected dome with an uncorrected one [2].

The way to correct this was first suggested by Richard Hendrickson, slightly modified by me, as shown in [3]. I use sacrifice bodies to obtain the extra domes; three-dome Athearn bodies are still available as parts.

Slicing off a dome from the sacrifice body, filing its bottom flat, and scraping a taper on the inside of that dome, allows gluing it onto the working body [3]. The equilateral arrangement of three

2. (Next page, top) The foreground model is an Athearn tank car with unmodified dome and incorrect paint, though a vertical-staff handbrake has been added. Behind it is a car with dome height corrected. The three safety valves on the uncorrected dome are also incorrect, and they need to be repositioned.

3. (Next page, bottom) The method for correcting the height of the Athearn dome, using a dome from a sacrifice body, filed to have an interior taper (shown at bottom) so it can be glued directly onto the dome being corrected. The basic idea came from Richard Hendrickson.

GETTING REAL | 5

safety valves is also incorrect, and these can be removed. There should be just two of them, paired toward the B end of the car.

The double rivet rows on either side of the Athearn dome are also artifacts of the three-dome model and should be removed for the

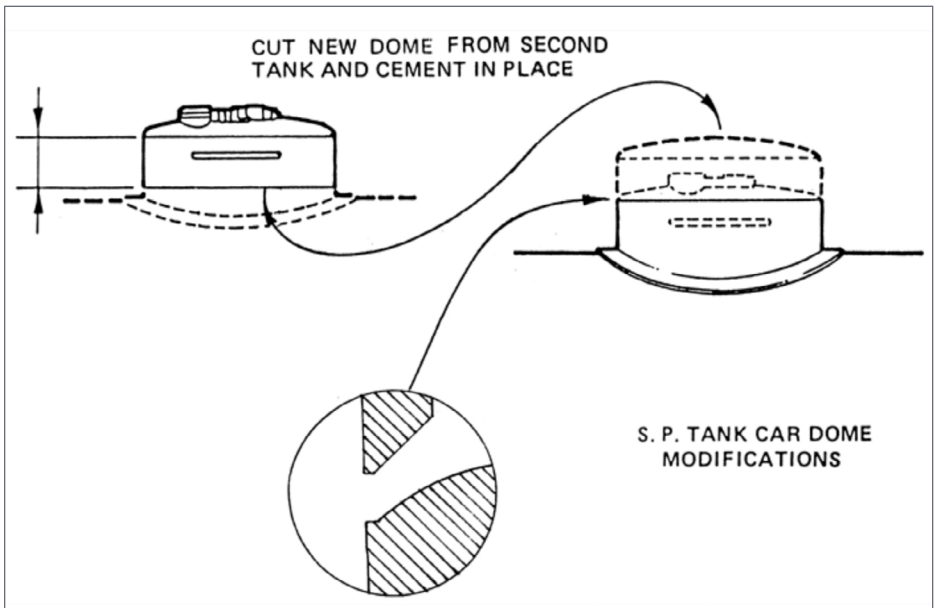

GETTING REAL | 6

SP car or any single-compartment car, as should the outboard bottom outlets. And the dome walkway and ladder on the right side of the car should be removed.

Other upgrades include a vertical-staff handbrake, brake rigging, and perhaps a corrected tank handrail, as the Athearn one is oversize in diameter. When completed, a variety of paint schemes can be applied, as shown in [4].

For SP and other cars built before the mid-1920s, there were a number of construction differences, as described in Part 1. Circumferential riveted joints in the top of the car were one such difference. These are not difficult to reproduce using such resources as Archer rivets (see Parts List), as shown in [5]. Safety valves were usually mounted on elbows at the side of the dome (as shown in Part 1). An excellent lost-wax brass part is now



4. Here are five completed SP tank cars, five different paint schemes (the front and back cars are diesel fuel schemes of different eras, the yellow car is a gasoline scheme, the car with the "S" in the diamond on the dome is equipped for liquid sugar service, and the plain black one is in general service). Most are converted from Athearn plastic models.

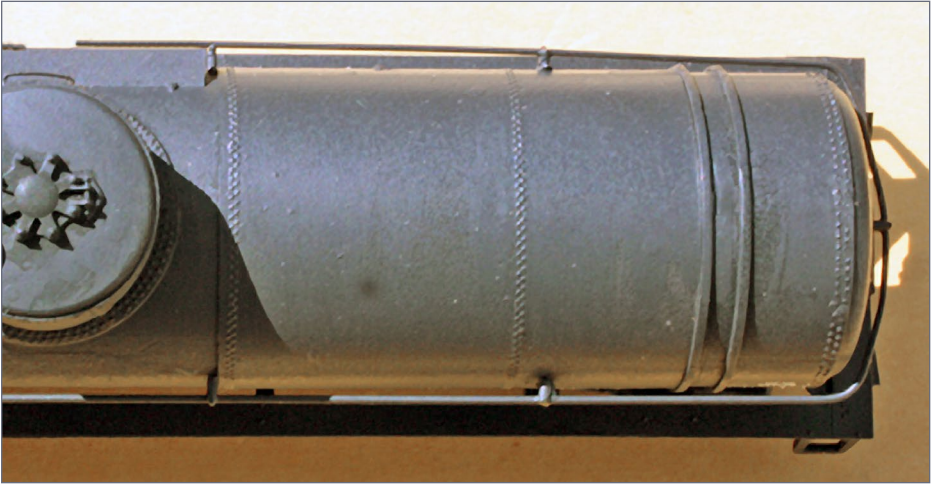

5. The top of an Athearn tank car, converted to circumferential double-row rivets using Archer set AR 88031. That set was designed to reproduce exactly this kind of double-row rivets.

available from Owl Mountain Models (see Parts List) for these elbow valves [6], along with frangible-disc safety vents.

Another kind of simple upgrade for some cars is the substitution of a screw-top manway for the bolted manway on most models (see Part 1 for illustration of this appliance). The Tichy tank car detail set, no. 3007, contains crisp versions of both manway covers. This part set, and others mentioned in these modeling approaches, are included here in a Parts List. I allude below to sources of detail parts, both to complete some models, and also to upgrade kit parts, in a few cases.

Model conversions

To inter-convert parts of tank car kits, for example swapping tanks and underframes, it is useful to know the size (in gallons) of what you are working with. The first problem, at least with older

models, is to determine how big the tank actually is. The second problem is to determine what the prototype car you are modeling might have contained in gallons.

A way to do this is shown in [7]. The idea here is to simplify measuring a tank, by choosing easily located end points, and then to juggle the conversion factor to compensate for what is ignored. Measure, in scale inches, the cylindrical or barrel dimensions of tank or dome, ignoring tank heads and crown of dome. Then use the equation shown (merely the equation for the volume of a cylinder) to calculate volume in cubic inches. Next divide by 225 to get the gallons (in other words, assume there are 225 cubic inches per gallon). This conversion factor allows for shell thickness and curvature of tank heads. (For the technically inclined, the “handbook” conversion factor is 231 cubic inches per gallon; the overestimate of roughly 2 percent compensates for head shape, etc.)

One of the simpler conversions, if the volume of your target prototype is right, is to correct the Athearn

“chemical” tank car. Athearn somehow created a car with an immensely oversized valve bonnet (see Part 1 for discussion of what this is for) and a correspondingly oversized dome platform. You can get a sense of this if you put an HO scale man on the Athearn platform.

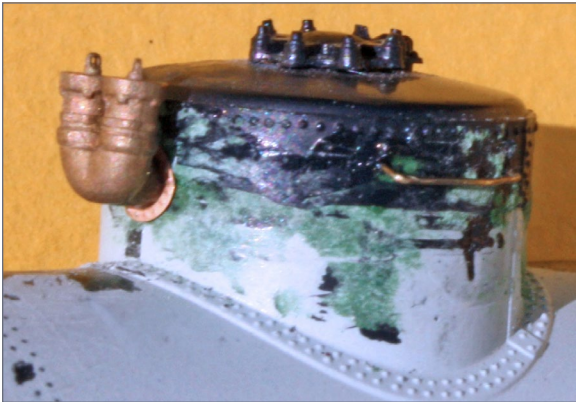

6. The Owl Mountain double safety valve on an elbow mount. The dome height of the Athearn car has been corrected.

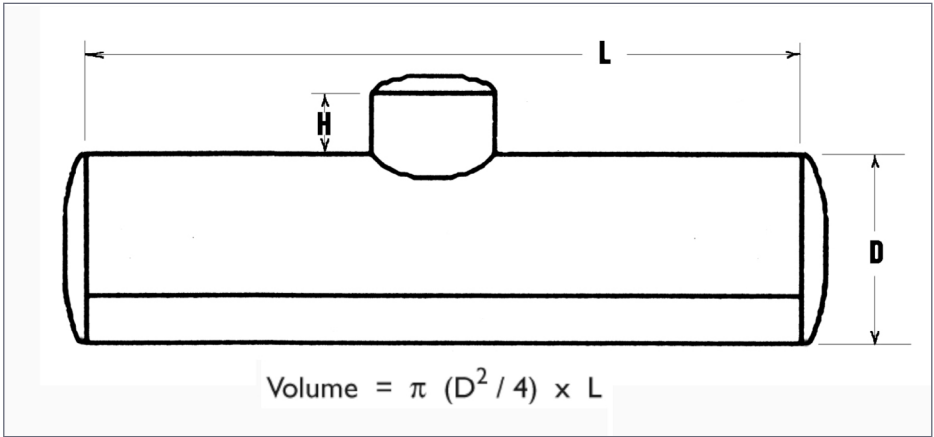

7. Computing the volume of a tank car or its dome, using the formula shown (see text for details). Measurements should be in scale inches.

Correction is easy: replace the Athearn bonnet with Precision Scale's part [8,9]. Both size and appearance are now much better. The only remaining problem is to add either a correct-size dome platform, or, as was quite common, simply add dome walkways. Prototype photos are essential to determine which one is correct.

One example of making a new dome platform is to cut down an Atlas kaolin tank car part to make a scale-size platform [10]. I have described this project in a blog post, at: modelingthesp.blogspot.com/2015/05/another-approach-to-tank-car-platforms.html.

Another approach is to simply add dome walkways, as shown in [11]. This too is an Athearn "chemical" tank car with a replaced valve bonnet. This particular prototype, leased to Brea Chemicals, had a very short walkway at the top of the ladder, just as modeled here. The grid walkway is also taken from the Atlas tank car platform described above.

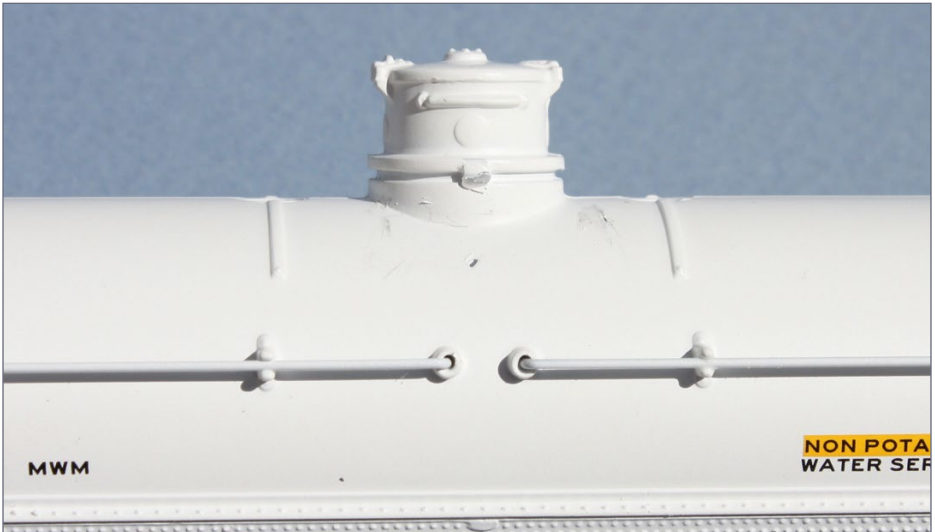

8. The stock Athearn valve bonnet on the “chemical” tank car. It’s seriously oversize, as is the platform which goes with it.

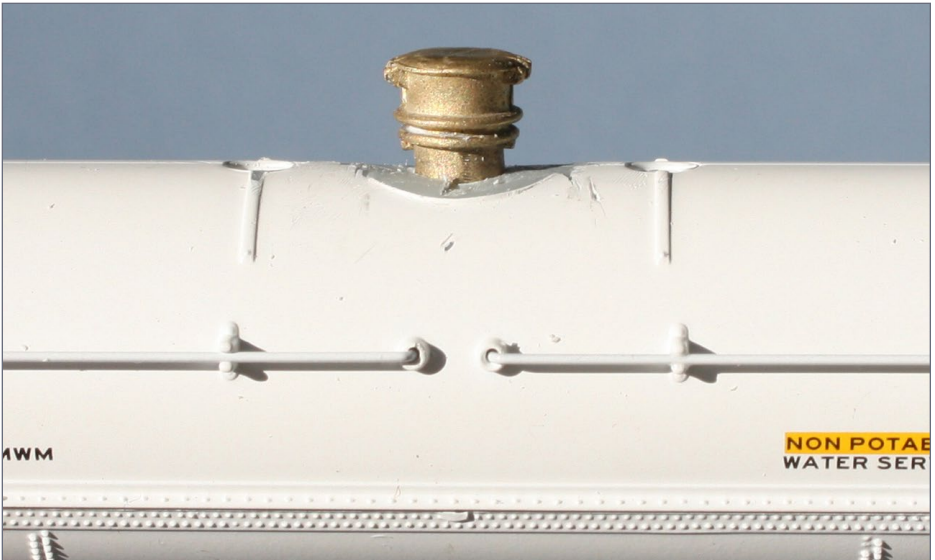

9. With the Athearn bonnet removed, the Precision Scale brass bonnet (part 31005) can be placed. It’s scale size.

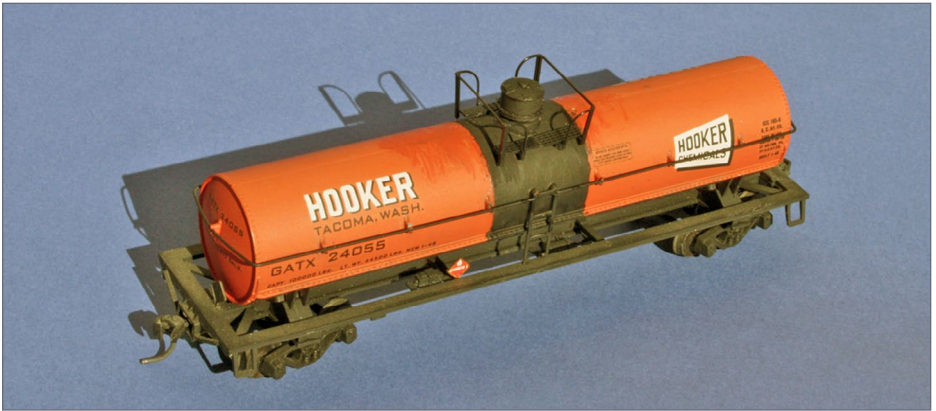

10. This Athearn “chemical” tank car has a replaced valve bonnet of correct size, and a platform around the bonnet made from an Atlas tank car part (see text).

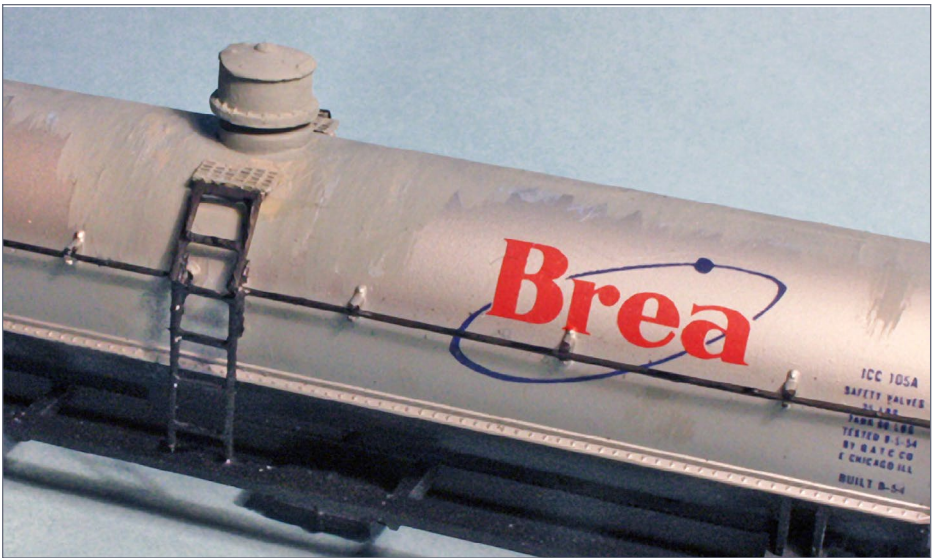

11. At the top of the Athearn metal ladder, a short walkway was located, using plastic grid walk cut from the same Atlas tank car part used for the platform of the Hooker car [10]. This short walkway matches the prototype part.

GETTING REAL | 12

The two models just described, involving only replacement of valve bonnets and addition of vertical-staff handbrakes, brake rigging, and appropriate top walkways or platforms, are relatively simple to carry out. Next I turn to more extensive projects to modify tank car models, both in body modification and in scratchbuilding.

More extensive tank car modification

One example of more extensive modification is the swapping of tanks and underframes. This may require one of the two swapped parts to be significantly modified. Here is one example. The InterMountain 8000-gallon tank car is an accurate AC&F Type 27. But if one wishes to model a General American car, a different style of underframe construction is needed. Either the AC&F

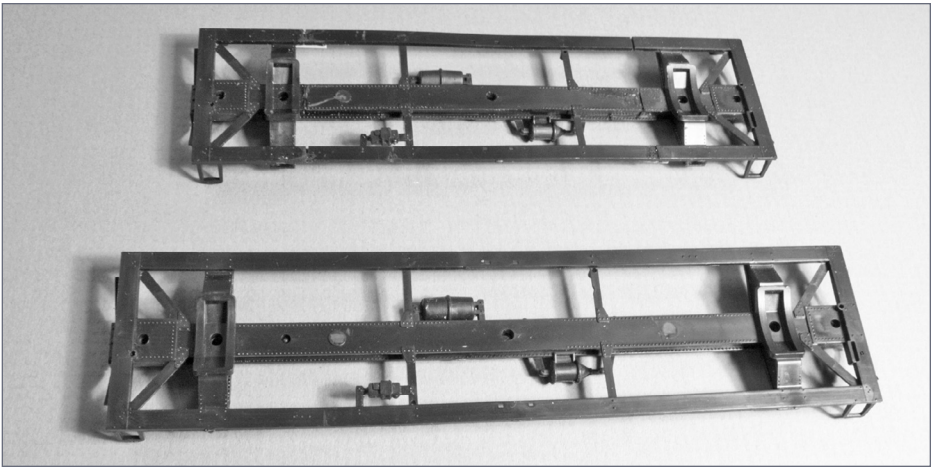

12. Shown here are a stock Athearn tank car underframe, at bottom, and a shortened one at top. The stock part was cut at the bolsters and the center section shortened to match an InterMountain 8000-gallon tank. When reglued and spliced, as in the underframe at top here, the frame is sturdy and effective.



13. The kit swap described in the text, placing an InterMountain 8000-gallon tank on a cut-down Athearn underframe, resulted in this GATX model. The lettering is from custom decals. The car is shown delivering vegetable oil to a fish cannery.

underframe of the InterMountain car must be reconstructed, or a General American underframe substituted.

In one project, I chose to do the latter. The Athearn underframe is indeed a General American design, if crude in some of its details, but has the drawback that it is sized for a larger tank car, 12,500 gallons. It can readily be shortened, however, to fit the InterMountain tank. That was what I did; see [12]. The InterMountain tank is screwed to the underframe through the bolsters, so the spacing of those screws sets the distance between bolsters of the shortened frame.

GETTING REAL | 14

When complete, the model was lettered with custom decals to represent a General American car leased to El Dorado Oil Works of Berkeley, California, a producer of edible oils, not petroleum products. It is shown in [13], and was described in my *Railroad Model Craftsman* magazine article of 2011 (see Bibliography).

In that same article, I described the “reverse” of the swap just described, using the leftover InterMountain AC&F underframe to accept the tank that had been in the Athearn kit from which I took the underframe for [12]. In this case, the tank was too large, and had to be cut down to the length of its new underframe. And once again, the distance between bolster screw centers was an essential measurement, this time for the new dimensions of the cut-down tank.

I had to remove five scale feet from the Athearn insulated tank. On the upper part of the tank, I could cut out five feet anywhere near the center. But for the bottom sheet, to keep the center anchorage details in the center of the tank, I had to remove two equal parts from each side of the center. As always in such cutting

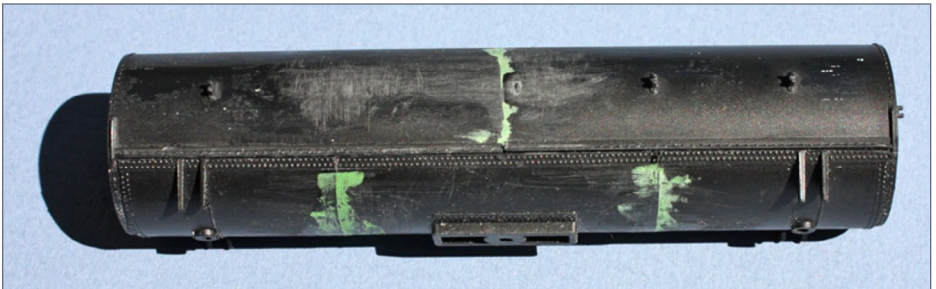

14. An Athearn insulated tank body, shortened to fit the InterMountain frame, and reassembled. Cuts in the top and bottom pieces are differently located (see text). Longitudinal rivets seen here are incorrect and were removed.

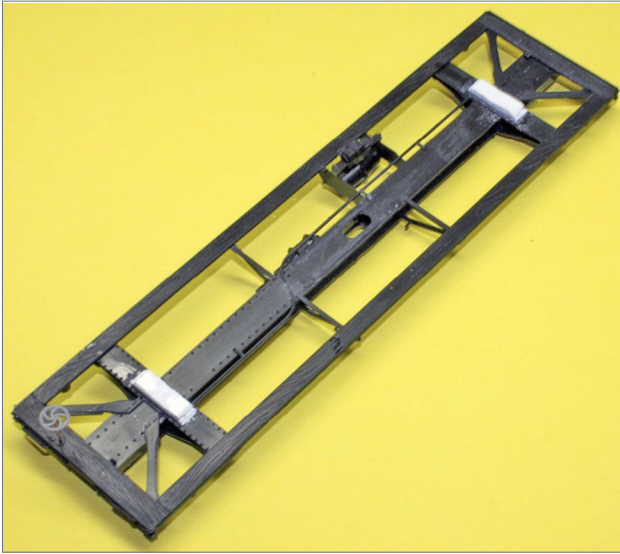

15. The Inter-Mountain frame could be used almost in stock condition, though styrene pads were added at the bolster to support the tank correctly. A vertical-staff handbrake has been installed, and additional brake rigging was added later.

and reassembly, I cut out a little less than would be needed, so that cleanup of the cut parts can bring the size to just the right length. Shown in [14] are all the tank parts, re-glued and with a little modeling putty used to fix any small errors.

The InterMountain frame to be used is an AC&F design, which fit the prototype I was aiming at, a Warren Petroleum ICC 104 car, like the one shown in Part 1. (Using a prototype photo is, of course, a good guide to all the changes in detail needed to complete a model.) The tank was cut down mainly to fit the frame, but also to reduce its size to about the 10,000 gallons of the Warren car.

The InterMountain frame needed only spacer pads under the Athearn tank to line up all the parts correctly. This minor change in the underframe is shown in [15].

The dome of the Warren car in question was insulated and was visibly larger in diameter than the required two-percent

GETTING REAL | 16

expansion dome would be. It was easy to make a new dome from tubing, in the way shown in [16]. It was also necessary to make new dome-top fittings, like the air vent and siphon covers shown in Part 1. I simply turned some styrene rod to make these conical-looking parts, and also added the bolted manway from the Tichy tank car detail set (see Parts List).

The final model [17] has the advantage that it represents a car not available any other way, as well as consuming the leftover frame and tank from the El Dorado Oil project!

One other example of cutting down a kit model to make something else comes from the work of the late Richard Hendrickson. His article in *RailModel Journal* in 1996 described construction of this model (see Bibliography), so I will only briefly summarize here. He wanted to make a 10,000-gallon General American tank car from the 12,500-gallon Athearn tank. To do that, he cut down



the Athearn frame length, much as I showed in [12], then did similar cutting and reassembly of the Athearn tank to that shown in [14].

16. Dome creation is easy if abrasive paper is wrapped around tubing of the tank diameter, and then the dome tubing is sanded to shape. Shown here is aluminum tubing, but this method works equally well for Plastruct and other types of tubing.



17. The completed 10,000-gallon tank car using the Inter-Mountain underframe and the cut-down Athearn insulated tank body, with a new dome. A mixture of Champ and Jerry Glow decals was used.

His tank cuts were alongside the hold-down bands at each end, to make them easier to clean up upon reassembly [18]. The completed car is shown also [19].

Scratchbuilding tank cars

This idea sounds intimidating to many, but as with a lot of projects, the key is recognizing that the model is made up of sub-assemblies, and each one is quite manageable. A major component is the underframe. These are actually not hard to scratch-build. The ones I have done were based on an Eric Stevens “Dollar Car” project article in *Model Railroader* (see Bibliography).

This article showed an easy way to scratchbuild an underframe for a tank car using interlocking wood parts. The general idea is sketched in [20], with the end notches intended to hold coupler boxes. I used basswood, 3/16-inch square, to make the center

GETTING REAL | 18

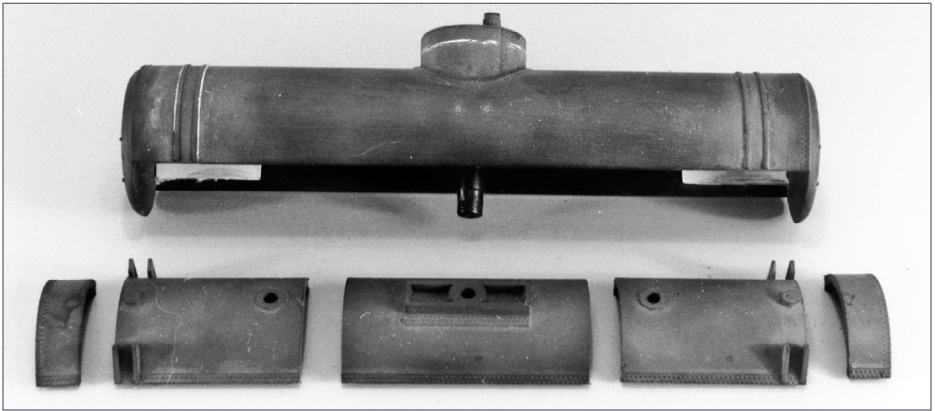

18. The cut-down tank parts for Richard Hendrickson's model. The top has already been reassembled and dome height increased as in [3]; the modeling putty at joints alongside the tank hold-down bands is visible. The bottom sheet had to be cut into five pieces also. "Fins" on bottom sheet were removed. (Richard Hendrickson)



19. The completed 10,000-gallon tank car built by Richard Hendrickson from an Athearn tank car kit. Note that the tank bands at bolsters have been redone as separate bands. I inherited this model from Richard.

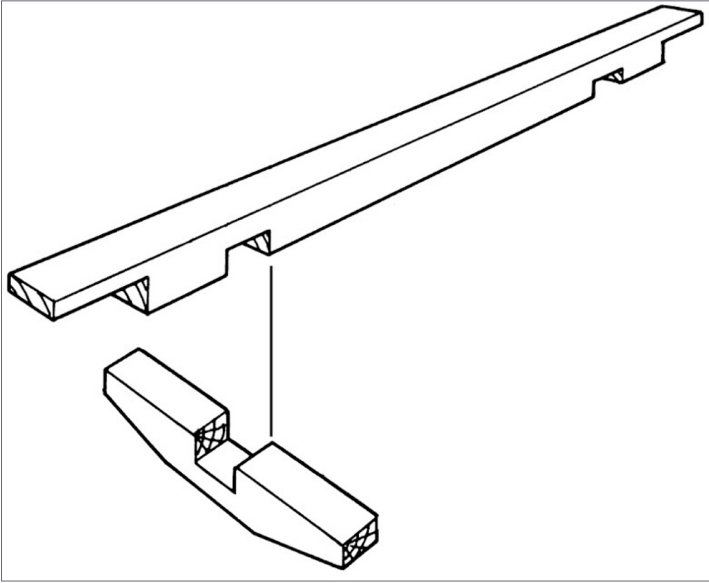

20. Tank car underframe construction from bass-wood. This is a very strong and rigid frame.

sill and bolsters. I then used light cardstock and made overlay strips, which were embossed with rivets made by a row of scribe indents, to make the wood parts look like flanged structural shapes [21]. This underframe is surprising easy to make, and when complete, is impressively strong and rigid.

But an excellent kit underframe is available also – the Tichy styrene frame (see Parts List). This is an AC&F underframe but is readily modified to represent the General American style of construction, and can also be easily modified for various tank diameters. Moreover, the location and arrangement of brake gear is also easy to adjust to match a prototype. The frame is intended for K brakes, but it is easy to install AB brakes, for example. This is shown in [22], with simple addition of styrene shapes to support the brake gear parts.

This underframe can also be shortened if needed, and re-detailed in a variety of ways. It is an excellent foundation for several kinds

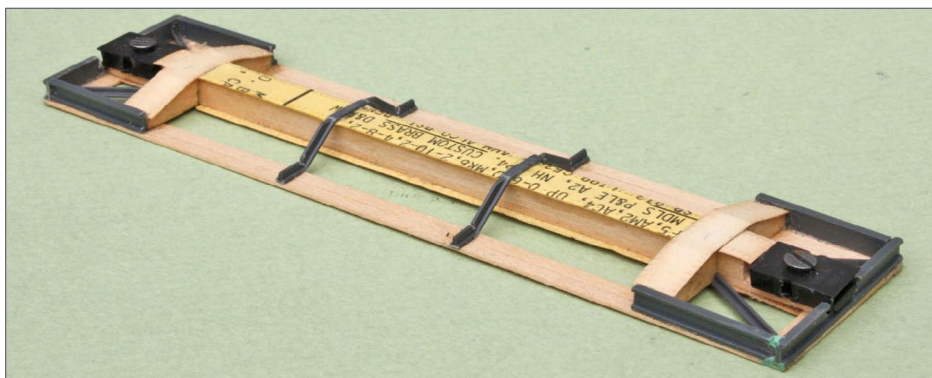

21. A scratchbuilt tank car underframe in progress, based on the basswood construction shown in [20]. Wood running boards have been added, along with styrene side and end sills and running board supports. Rivet-impressed overlays for center sill and bolsters were made from a manila parts envelope.

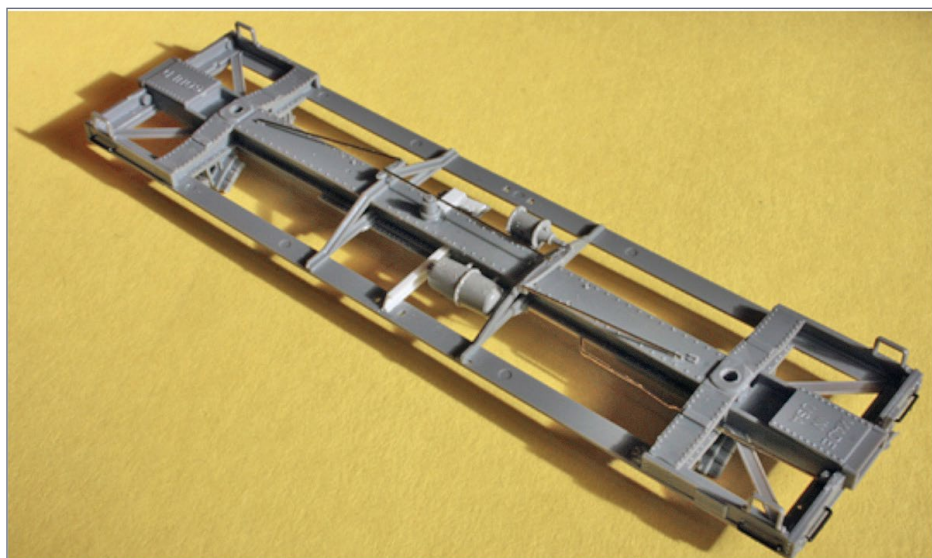

22. A Tichy underframe, set 3011, modified to accept AB brake parts (also Tichy). Brake rigging applied, but piping not yet installed.

of tank car model projects. I show just one such project here, which is described in more detail in my article in *Railroad Model Craftsman* for January 2012 (see Bibliography).

I was aiming at a tank car of the kind modeled years ago in an article by Mark Feddersen, who I believe was way ahead of his time in his tank car modeling. Specifically, I wanted to model a hydrogen peroxide car (see Bibliography for Mark's article from January 1986). This is only a 6000-gallon car, rather smaller than any of the models described so far. I decided to create the tank from scratch.

Tanks are easily made from the various diameters of Plastruct tubing, particularly since they also sell matching end caps. The elliptical ones are still too rounded, but as the material is fairly soft acrylic, they are very easy to file and sand to a flatter profile [23]. I used 3/4-inch tubing for this car.

I used the Tichy underframe for the model, with the significant modification of narrowing the tank cradle width to accommodate the 3/4-inch tubing.

I applied Precision Scale handrail stanchions as needed, with 0.019-inch brass wire handrails. This is almost exactly the prototype size (nominal 1-1/4-inch pipe) in HO scale. Unions in the handrail were made from 0.020-inch ID hypodermic tubing (see Parts List). I made tank hold-down bands from styrene strip.

Dome top appliances are typically different on tank cars like this one, with various kinds of unloading pipes and other details, along with the usual manway cover and safety valve. For this car, I used a Tichy manway cover, a single safety valve (as called for with this car of less than 6500 gallons, see Part 1), and a steam locomotive pop valve to represent the access pipe cover. These are shown in [24]. The completed car is in [25].

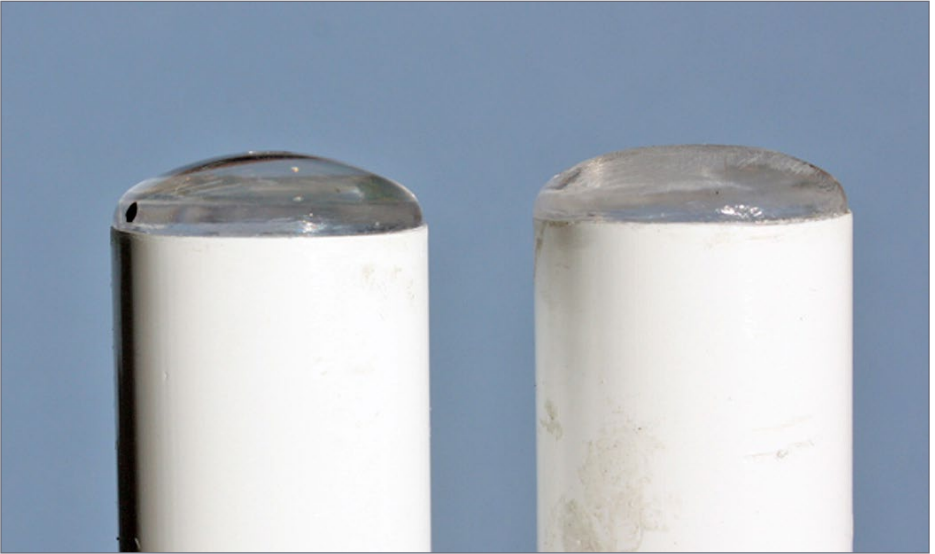

23. On the left is the elliptical end cap sold by Plastruct, while on the right is an end cap filed and sanded to match prototype tank car end shapes.



24. The dome top on the Becco peroxide car shown in [25]. As is typical, the manway cover is offset to one side, and a safety valve and access pipe cover are alongside it.

iwata

by ANEST IWATA

Be Realistic

From weathering broad areas to painting concentrated details, an Iwata airbrush gives you precision and reliable performance for a natural, smooth finish.



Iwata Eclipse CS



NEO for Iwata TRN1



iwata
MEDEA
ANEST IWATA-MEDEA Inc

PRODUCTS
ARTOOL
COMPANY, INC.

Locomotive from Alan Houtz, North American Prototype Modelers

Click to see the entire line of Iwata Airbrush and Artool Products

• INDEX

• TABLE OF CONTENTS



25. The completed peroxide tank car, with Champ decals for Buffalo Electro Chemical Company (Becco) applied. This is a Plastruct tank with K&S aluminum tubing for the dome, and a variety of detail parts used for the dome top.



26. A riveted 7000-gallon acid tank car from a resin kit produced by Resin Car Works. As was typical before 1948, the dome platform is wood planks. (Eric Hansmann photo)

In my January 2012 *Craftsman* article that described building the Becco car in [25], I also showed a scratchbuilt acid tank car, for which there were then no commercial models. Now there are two excellent ones, a welded one from Tangent and a riveted one as a resin kit from Resin Car Works [26]. Time does march on, in a good way.

Placards

Tank cars for many years have carried warning placards for various dangerous cargoes [27]. In the earliest days, these were made up by individual shippers or railroads, and the only standard one was for explosives, specified by the federal Bureau of Explosives. But in 1921 an amendment to the 1920 Transportation Act gave

27. A workman in this John Vachon photo is inserting a “DANGEROUS” placard in the holder on a loaded Phillips Petroleum tank car. The placard holder to his right still has the empty placard



from the previous trip; sometimes the black-white division in the diamond was placed horizontally, as here. Photo taken at the Phillips gasoline plant in Borger, Texas, November 1942. (Library of Congress, negative LCUSW3-011653)

GETTING REAL | 25

the ICC (Interstate Commerce Commission) authority to regulate transportation of dangerous commodities, and they introduced four standard placards in that year [28]. By 1930, the need for other commodity descriptions was evident, and four additional placards were made standard [29].

In the late 1930s, a more general “DANGEROUS” placard was introduced, with a blank space where the particular commodity could be written in. This is a flexible category, and this placard is



28. These are the first four standard placards, introduced in 1921. Before that time, various placards made by individual shippers or railroads were used, the only standard being a federal placard for explosives. “Inflammable” means the same as “flammable,” and today only the latter word is permitted. The use of red type helped make warnings visible.

used for many cargoes. An example printed by SL-SF in 1962, is shown in [30].

Since I model 1953, the placards in [28-30] are relevant. But modelers of later periods must recognize that after the 1950s, a series of changes to placard standards took place. In 1960, more color was added to some placards, and designs were given more of a family resemblance. In 1974, considerable changes were made,



29. In 1930, these four placards were added to the four shown in [28]. The placard for corrosives recognizes that liquids other than acids can be corrosive. The “EMPTY” placard was a printed version of the common practice of folding a loaded placard in half and placing it back in the holder, thus showing the black background of the holder.

with many placards given an entirely new look, even different colors. And then in 1981, the United Nations international placard standards and commodity numbers were adopted, which are still in use today. This history, and much else on the topic, has been ably summarized by John Ryczkowski in a magazine article (see Bibliography).

With good images of these placards, modeling them is easy, as I show in [31]. I make up sets of these and have them printed at my local copy shop, which has a high-resolution color printer. They can then be cut out [32] and applied to tank car models as needed [33].

As mentioned in Part 1, there are commodity tables which tell you which cargoes are accompanied by which placards, and a link was provided to such a table. Even tank cars such as helium cars did carry placards [34].



30. This placard, printed in 1962 by the St. Louis–San Francisco Railway, is very similar to comparable placards first used in the 1930s. It has a space just below center to write in the particular cargo. (author’s collection)

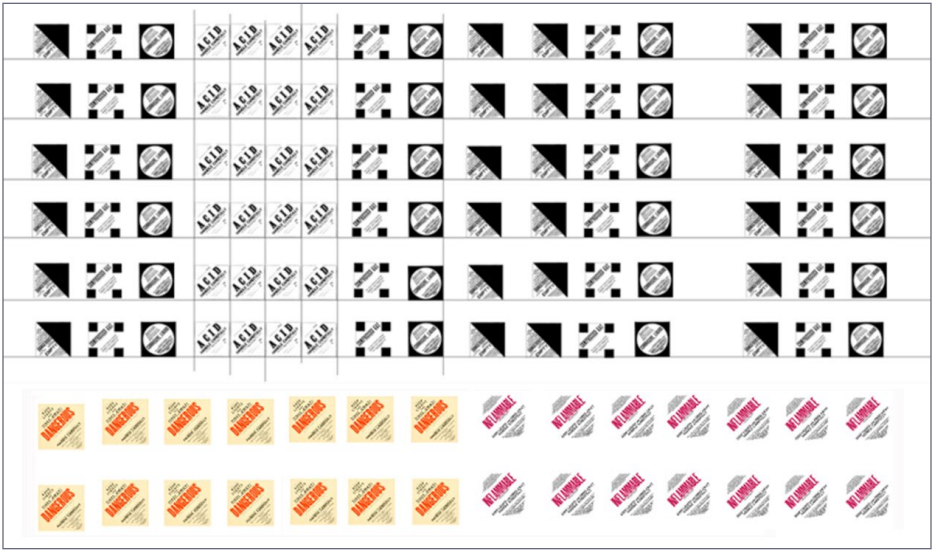

31. The prototype placards are specified to be 10.75 inches on a side. In HO scale, this comes out to exactly 0.125 or 1/8 inch. I reduce the prototype images to this size and print them in quantity, as you see here. This size, incidentally, also tells you the size that placard boards on model tank cars ought to be, though some models have distinctly oversize boards.

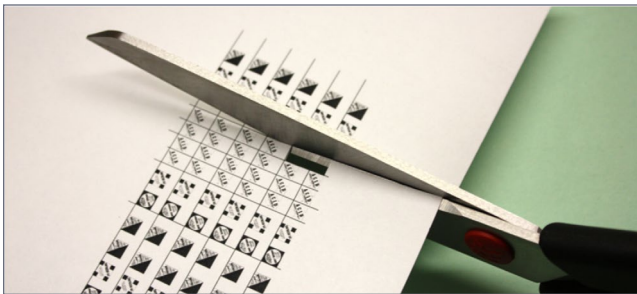

32. An accurate shear or good-quality scissors can be used to cut out the placards, or a hobby knife may be preferred. I usually print them on plain paper, but glossy paper may be better when color ones are being made.

GETTING REAL | 29

Once you are aware of the presence of placards, they show up in many prototype photos. The “EMPTY” placard was usually placed with the black-white division vertical [35], but especially in earlier



33. In this photo, an “EMPTY” placard is being placed over the placard supplied on this ready-to-run tank car from the Proto2000 line (now sold by Walthers). I usually use canopy glue for this application.



34. This AHM model helium car, with upgraded trucks and details, carries a “COMPRESSED GAS” placard. As explained in Part 1, it’s an ICC-107A tank car.



35. This UTLX tank car, photographed in 1948 and still showing (correctly) its “ARA Spec III” designation, has a standard “EMPTY” placard, the vertically divided diamond in black and white. Note the chalk marks on the car. The UTL car design has side and end sills of inward-facing channels, instead of the outward-facing channels of the AC&F underframe (Richard Hendrickson collection)



36. This Ethyl Corporation car, EBAX 6357, carries a “DANGEROUS” placard, with that word in red. Photographed at North Broadway Yard (Los Angeles) on the Southern Pacific in July 1961. (Morris Abowitz)

GETTING REAL | 31

days, it was sometimes installed with the division horizontal [27]. Loaded placards are not always readable in prototype photos, though the example in [36] clearly is a “DANGEROUS” placard.

At the same time, many common commodities, including petroleum products, like heating oil and kerosene, did not require placards in the 1950s, so not every model car would or should carry a placard. On my layout, there is no reversing loop, so the same side of each model car is always toward the viewer. I take advantage of this in applying my placards, with an “EMPTY” placard on one side, and an appropriate load placard on the other side. When a car changes status, from loaded to empty or vice versa, the car is



physically reversed to show the other side. Of course this would not work on every layout.

Concluding remarks

I recognize that at least some, and maybe most, of the descriptions of model modifications and rebuilding may seem obsolete in light of new models of higher quality. The new models include the recent Tangent and Resin Car Works cars, but there is no better example than last year's introduction of the Kadee high-pressure tank car [37], which is what the Athearn tank car should have been. For my part, I very much hope that more cars of the



37. The recent Kadee 11,000 gallon ICC-105A tank car, lettered for Tidewater Associated Oil Company, and shown at the Associated dealer on my layout. Construction of this dealership model was described in *Model Railroad Hobbyist* in March 2014. The valve bonnet is white to assist in rapid return of these cars for reloading. Propane consumption jumped after World War II and cars were in short supply.

quality and accuracy of the Kadee tank car do come along. It will make the work of the modeler easier and better.

But in the meantime, there remain a great many prototype tank cars that will require kitbashing or scratchbuilding to create. The modeling challenge will continue. Some of the approaches outlined in this article may be of help if you confront such a situation.

The two parts of this article are intended in combination to demonstrate how and why different kinds of tank cars were built and regulated, the cargoes they were built to carry, and then an extended discussion of how to model them.



[Click here for reader comments](#)

ADVERTISEMENT

Still available – in a limited, revised edition!

Southern Pacific Freight Cars

Volume 4: Box Cars (revised edition)

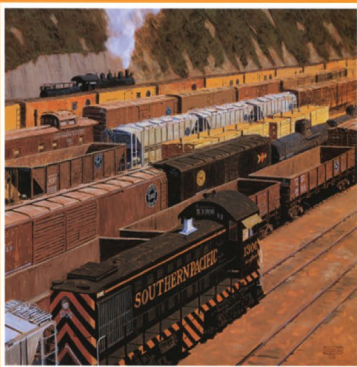

Anthony W. Thompson

This thorough and complete history by SP freight car authority Tony Thompson has been revised and is back in print. It contains a phenomenal amount of information about the SP. How can I learn more about this book? How can I buy it?

**Click here for
the answer ...**

SIGNATURE PRESS

APPENDIX: LANDMARK DATES PART 1

- 1899 – American Car & Foundry formed from 13 firms
 - 1902 – German-American Car Company incorporates
 - 1903 – Master Car Builders (MCB) institutes recommended practice for tank cars
 - 1910 – MCB 1903 practices adopted as standard; post-1903 cars become “Class II,” cars built before 1903 become “Class I”
 - 1916 – German-American becomes General American
 - 1917 – MCB becomes part of ARA; new ARA Class III for cars after May, 1917; Class IV specifications adopted (insulated, low-pressure for flammable cargo)
 - 1918 – Class V specifications adopted (insulated, high pressure, dangerous cargo)
 - 1924 – Class VI adopted for very high-pressure helium gas
 - 1927 – On July 1, ARA specifications were superseded by ICC: Class III became ICC Class 103, Class IV became ICC Class 104, etc. Older cars retained ARA markings, such as “ARA Spec III.”
 - 1957 – ICC begins introduction of new classes of domeless cars, ICC 109, 110, 111, 112
-

BIBLIOGRAPHY

- Culotta, Ted, *Steam Era Freight Cars Reference Manual*, Vol.2, Tank Cars, Speedwitch Media, 2008.
- General American Tank Car Manual*, GATC, Chicago, 1961.
- Hendrickson, Richard H., “Multiple Compartment Tank Cars,” *Model Railroad Hobbyist*, February 2015.
- Hendrickson, Richard H., and Richard W. Pelouze, *Santa Fe Tank Cars* (Santa Fe Railway Rolling Stock Reference Series–Volume 5), Santa Fe Railway Historical and Modeling Society, Midwest City, OK, 2004.
- Kaminski, Edward S., *American Car & Foundry Company, 1899–1999* (Chapter 2: Tank Cars) Signature Press, Wilton, CA, 1999.
- Kaminski, Edward S., *Tank Cars from American Car & Foundry Company, 1865 to 1955*, Signature Press, Berkeley and Wilton, CA, 2003.
- Ryczkowski, John, *Mainline Modeler*, Vol. 14, January 1993, pp. 68–73.
- Thompson, Anthony W., *Southern Pacific Freight Cars*, Volume 5: Hoppers, Covered Hoppers and Tank Cars, Signature Press, Berkeley and Wilton, CA, 2008.
- Thompson, Anthony W., “Reweigh Dates on Freight Cars,” *Railroad Model Craftsman*, April 2011, pp. 72–73.
- Wilson, Jeff, *Freight Cars of the '40s and '50s* (Chapter 6: Tank Cars), Kalmbach Books, Waukesha, WI, 2015.
-

Bowser

EXECUTIVE LINE

ALCo Century C-636 Locomotives

Executive Line: Ready to Run & Detailed

Features:

Flywheels,
RP-25 wheel flanges,
Kadee metal couplers,
Railroad specific details,
Flashing beacon when appropriate,
Numbered,
With DCC and Sound or DC with an 21 pin
plug for easy DCC module installation.

Delivery Late 2016
DC Analog \$199.95
DCC Sound \$299.95



Demonstrator



BN



Penn Central



SP&S



Illinois Central



Penn Central



SP&S/BN



Fantasy D&H



Fantasy Lehigh Valley



Fantasy Pennsylvania



Fantasy Union Pacific

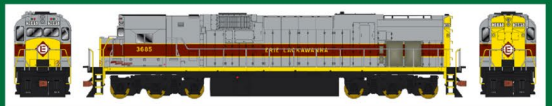

Fantasy Erie Lackawanna

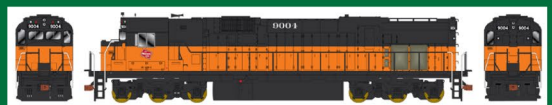

Fantasy Milwaukee Road

Click here to check out the details for these and other great Bowser products!

• INDEX

• TABLE OF CONTENTS

SELECTED MODELING ARTICLES

- Bill Darnaby, “GATX Tank Car,” *Mainline Modeler*, Vol. 12, November 1991, pp. 74–79.
- Ted Culotta, “Essential Freight Cars 12: UTLX class X-3 tank cars,” *Railroad Model Craftsman*, Vol. 72, No. 12, May 2004, pp. 75–82.
- Ted Culotta, “Essential Freight Cars 45: AC&F type 11 tank cars,” *Railroad Model Craftsman*, Vol. 78, No. 2, July 2009, pp. 80–87.
- Mark Feddersen, “ICC-104 Insulated Tank Car,” *Mainline Modeler*, Vol. 6, October 1985, pp. 63–69.
- Mark Feddersen, “The Becco peroxide tank car,” *Prototype Modeler*, January 1986, pp. 16–19.
- Mark Feddersen, “Twin Dome Kit Modification,” *Mainline Modeler*, Vol. 9, July 1988, pp. 50–53.
- Richard Hendrickson, “Fifties Era Tank Cars” [GATX 10,000-gallon car], *Railmodel Journal*, Vol. 8, No. 3, August 1996, pp. 18–21.
- Allan Mende, “Modeling a Shippers’ Car Line 4,000-gallon Tank Car in HO Scale,” *Model Railroader*, Vol. 61, June 1994, pp. 72–76.
- Stevens, Eric, “Building an HO Tank Car,” *Model Railroader*, October 1953, p. 44; reprinted as Chapter 18 in *Easy-to-Build Model Railroad Freight Cars*, Kalmbach Books, 1971, a compendium of the Dollar Car projects.
- Anthony W. Thompson, “Modeling SP Tank Cars,” *S•P Trainline* (Southern Pacific Historical & Technical Society),

GETTING REAL | 37

Issue No. 71, Spring 2002, pp. 35–37. [An updated version is on-line at: modelingthesp.blogspot.com/2011/05/modeling-sp-tank-cars.htm]

Tony (Anthony) Thompson, “Tank car kit swap,” *Railroad Model Craftsman*, Vol. 80, No. 2, July 2011, pp. 65–71.

Tony (Anthony) Thompson, “Modeling less-common tank cars,” *Railroad Model Craftsman*, Vol. 80, No. 8, Jan. 2012, pp. 61–66.

.....



**Click here for
reader comments**



**DID YOU
KNOW MRH
SUBSCRIBERS GET
FREE BONUSES?**

CLICK TO SUBSCRIBE NOW - IT'S FREE!

PARTS LIST

Archer Fine Transfers

HO scale tank car double rivets, set AR 88031

Athearn

tank car body, 3-dome, part 14990

Atlas

kaolin tank car, “upper platform,” part 9170013

Detail Associates

NBW, part SY 2203

brass wire, 0.015 and 0.019 inch

K&S Engineering

7/16-inch thin-wall aluminum tubing

Owl Mountain Models

elbow safety valves, single or double, parts 1001, 1002

frangible disc safety vents, parts 1003, 1004

Plastruct

3/4-inch tubing, part TB-24

elliptical end caps, part VHE-24

Precision Scale

Handrail stanchions, brass, part 32110

Tank car pressure bonnet, part 31005

Pop valve, brass, part 3294

Small Parts

0.020-inch hypodermic tubing, code B000FMYLZS

Tichy

Tank Car Underframe, set no. 3011

Tank Car Detail Set, set no. 3007

Yarmouth Model Works

sill steps and dome platform frames,
yarmouthmodelworks.com/details.php ■



**Click here for
reader comments**

**Want to help
keep MRH free?**

**Then click on
Ads!**

Spring Break Jubilee SALE

TRAINMASTERS.TV



Free bonus
months if
you join the
TMTV family
in March!

BECOME A MEMBER



Model Railroad Hobbyist | March 2016 | #73

WHAT'S NEAT WITH KEN PATTERSON

KEN PATTERSON

column



[Click here for
reader comments](#)

TRADE SHOW DISPLAYS, LED SHOP LIGHTS, AND MORE ...

FOR MARCH, WE TAKE A LOOK AT MAKING building displays for manufacturers to show off their products at trade shows, at track building parts and supplies from Oakhill Model Railroad Track Supply, and at new options for workshop lighting. Another new product is the Bachmann EZ App train control system, and there are more railroad drone videos to study. We also build a great B.T.S. laser kit and show off a great Tank Train model video runby.

▶ PHOTOS AND VIDEO OF SUPERB MODELS

• INDEX

• TABLE OF CONTENTS

WHAT'S NEAT | 2



1. This month we start with a turntable display that I built for Athearn a few years ago. Now Athearn has asked that I power up all the tracks and the turntable bridge so they can display their models with sound and lighting effects.

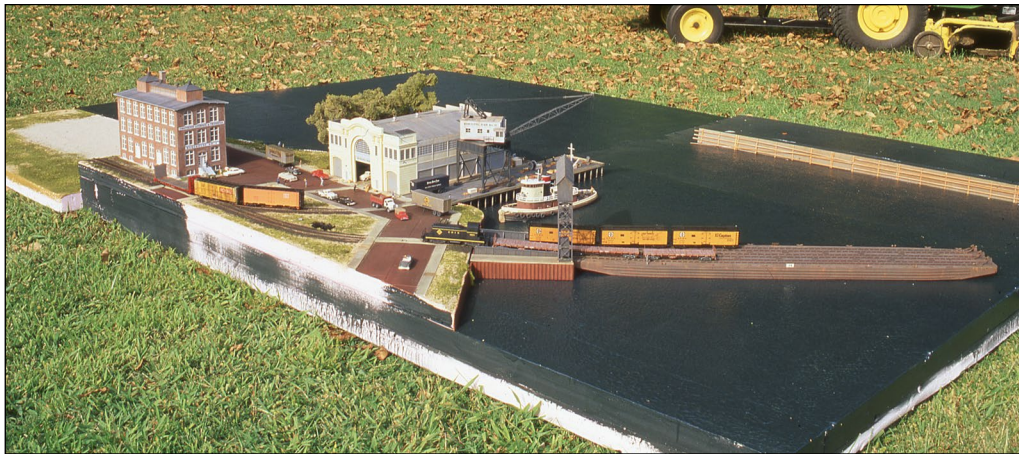

2. Building trade show displays is nothing new for me, as I have built many over the years, like the waterfront series for Walthers. This display measured six by eight feet and was used to shoot the box art photos for all of the waterfront building series products.

WHAT'S NEAT | 3



3. After the photos were done, I wrapped the diorama in 1/4-inch oak plywood so it would be well-dressed for the trade show booth.



[Click here to play video.](#)

Playback problems? [Click here ...](#)

WHAT'S NEAT | 4



4. Another trade show display I built was the photo prop for the box art of the Atlas roundhouse building in HO scale, with a crew was replacing a brake shoe.



5. The Atlas roundhouse set-up also became a nice oak-wrapped trade show display for the Atlas booth.

WHAT'S NEAT | 5



6. Walthers' car dealership diorama, part of the popular automotive series, also got wrapped in oak after the photo shoot to be displayed in the Walthers trade show booth. All of the cars and details made this a very interesting display to look at.



7. To start wiring up the Athearn turntable display, I pressed a brass tube through the foam base to feed a power wire from the rail to the bottom of the scene. I did this for all 22 rails around the pit.

WHAT'S NEAT | 6

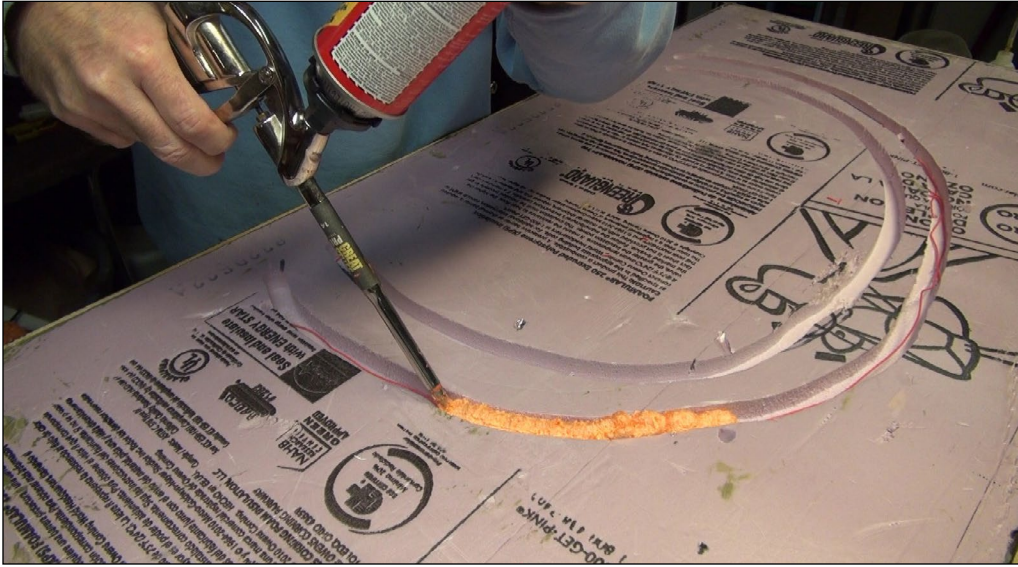

8. On the bottom of the display I cut two grooves to channel the wires, one groove for the positive rail and the other groove for the negative power feed. The wires were pressed into the groove and covered with Great Stuff foam to seal them inside.

**Want to help keep
MRH free?**

Then *click* on ads!

WHAT'S NEAT | 7

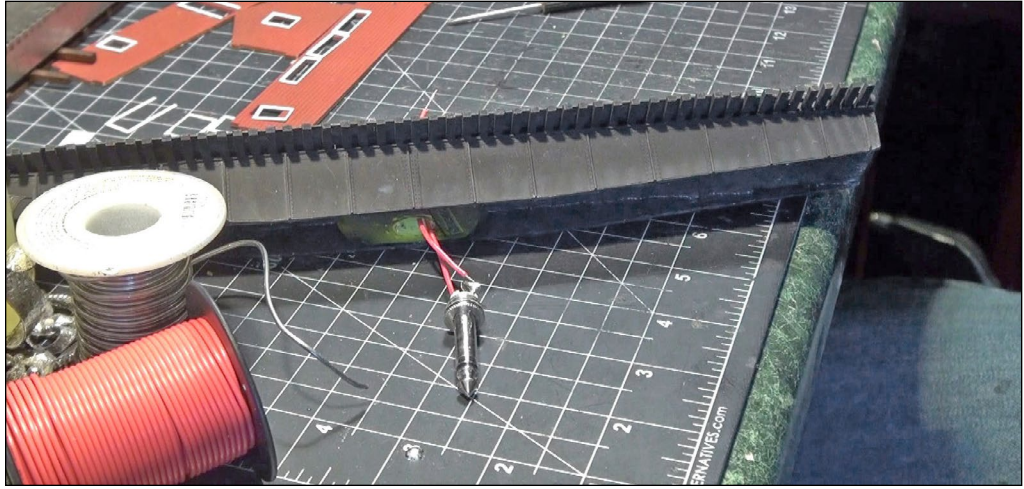

9. I ran power wires through the bridge and screwed a microphone jack into the bottom of the turntable bridge. This will power the rails on the bridge through a 360-degree turn.



10. I cut a Plexiglas disk and centered a female microphone jack on it. This disk assembly was glued into the bottom of the pit to accept the male microphone jack attached to the turntable, as you see here.

WHAT'S NEAT | 8



11. A piece of flex track was fed through the band saw to form the rail and tie strips for around the pit walls. I simply bent this around the pit and glued it in place with wood glue.



12. I painted this pit rail with Rustoleum Camouflage Brown paint with a household dinner plate acting as a mask to protect the pit's bottom.

*Learn to solder track, wiring and
brass models in this video!*

**CHECK IT
OUT!**



kenpatterson.com

click here to ...

Visit Ken's website

**Ken Patterson shows
you how to solder like
an expert!**

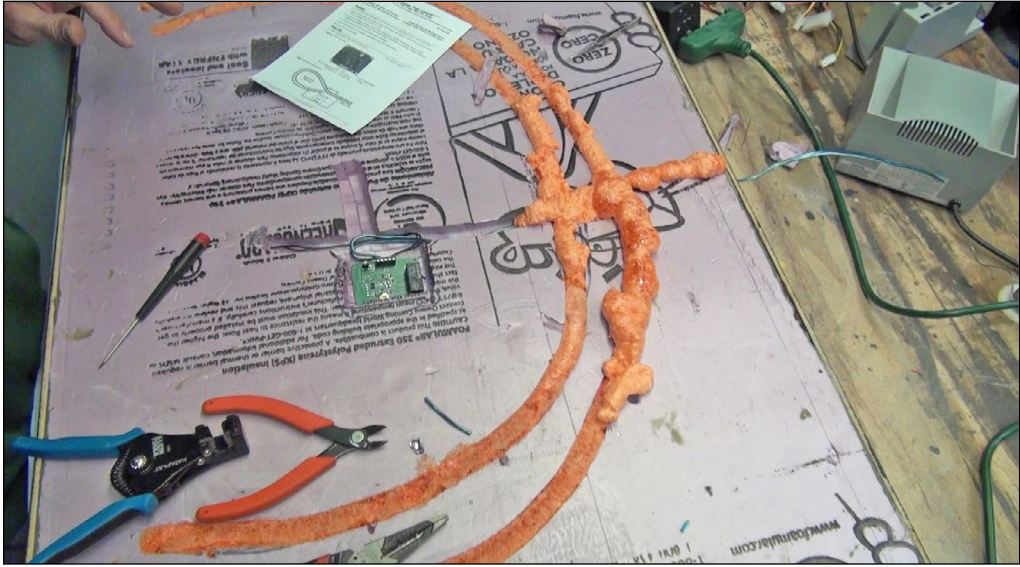

12. Another groove in the bottom of the diorama carries power wires to the turntable's microphone jack in the center of the pit. I installed a Digitrax AR1 power reversing module in line to the pit to keep the bridge from shorting out when spun around, reversing the polarity of the locomotive.

Did you see this MRH video?



The ultimate “Yes, it’s a model” video as James McNab switches NW 86th

[Watch the video now](#)

WHAT'S NEAT | 10



13. After covering the remaining wires with foam, I used a flush cutting saw to trim the expanded foam smooth on the bottom of the display.



14. I painted the orange and pink foam on the bottom of the scene black to make things look clean and professional.

WHAT'S NEAT | 11



15. With the other work finished, I freshened up the scenery and ballast on top of the diorama and secured it with a bottle of Woodland Scenics Scenic Cement to make everything look new.

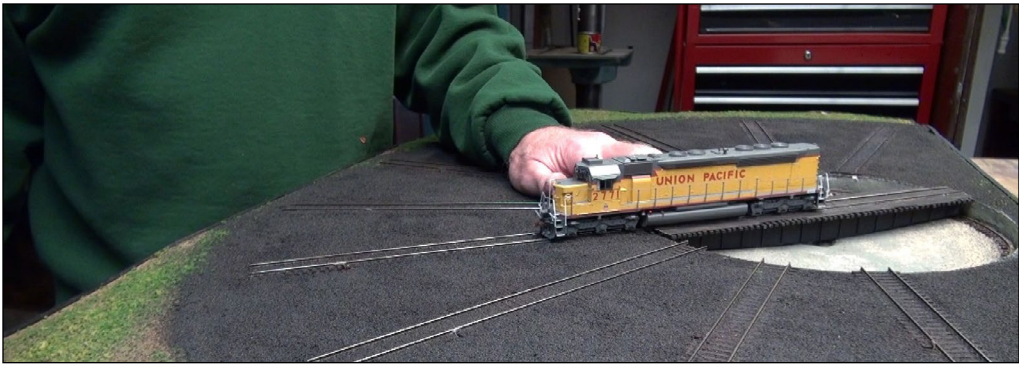

16. Now it was time to test run a locomotive on and off of every track, spinning the bridge around. The AR1 worked well as the locomotive ran smoothly and did not short out when the polarity was changed as the bridge rotated. So, when you see this scene at the Athearn booth you will know a little about how it was built.

WHAT'S NEAT | 12



17. Jeff Otto from Oakhill Model Railroad Track Supply stopped by the studio to share his line of turnout building jigs with us. Number #6, 8, and 10 turnouts and crossovers in various scales with different size rail can be built easily using this line of products. Each template is machined out of heavy aluminum and really looks like art to hang on a wall. In the video he shows many types of track templates. The web site to check out is ohrtrack-supply.com.



**Click here for
reader comments**

WHAT'S NEAT | 13



18. I tested a new type of LED shop light fixture bulbs. These are totally new and use only 17 watts each. They cost around 22 dollars per bulb but I'll bet that price will come down over the next year. Here you see me installing the bulbs for our overview. The light above my head is the LED bulb. The light on the left is a regular fluorescent. The LEDs seem brighter than the regular bulbs and use less than half of the electricity.



[Click here for
reader comments](#)

WHAT'S NEAT | 14



19. Jon Dietzen provides us with some really nice drone footage this month, of some very large transformers being hauled by depressed-center flat cars with idler cars between them. Great detail shot from the drone.

***TrainMasters TV is part of
the MRH product family.***

***TMTV members not only get great network TV level
videos, they help pay for MRH and keep it free ...***

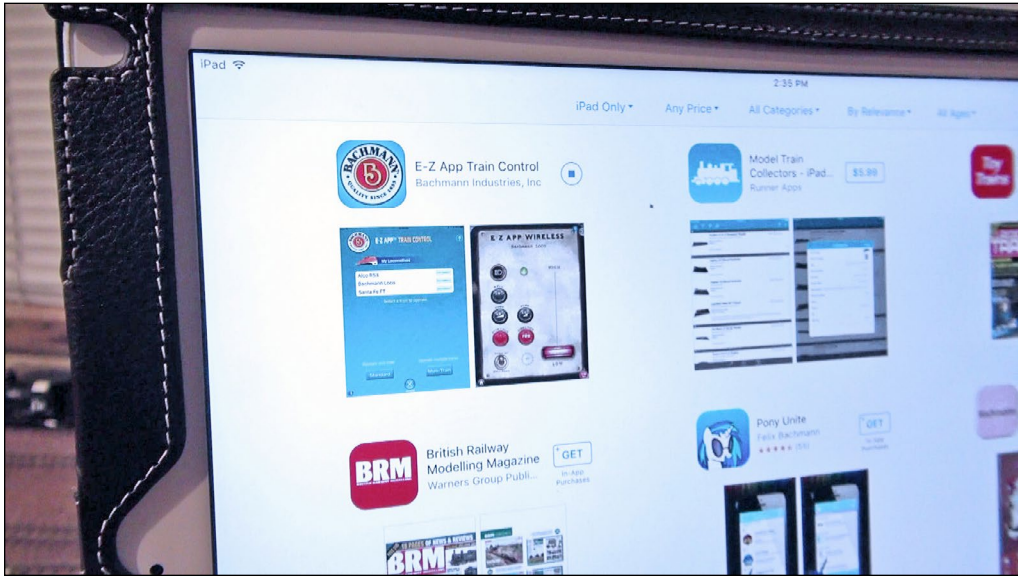

20. This month we look at the new Bachmann EZ App train control system. We found the app at the iTunes Store and downloaded it for free to my son's tablet.

**Did you know
there's an
MRH index
available?**

CLICK TO FIND OUT MORE

WHAT'S NEAT | 16



21. Bachmann sent two EZ App locomotives for catalog photography so we used these for the overview. Upon powering up the app in the tablet, the EZ App screen appeared and identified the two EZ App locomotives on the track. I hit the multiple throttle option and two throttles appeared on the screen, one for each of the locomotives. The locomotives ran well with fast response to the throttles' slide switches. The locomotive sound coming from the tablet or I-phone device synchronizes with the movement of the locomotive.



[Click here for reader comments](#)

WHAT'S NEAT | 17



22. To further enhance the sound experience, we placed a “Groove Cube” in a box car right behind the EZ App locomotive and programmed the I-pad to play the train sounds on the Groove Cube rather than from the tablet. The cube provided full rich sound to the train set.

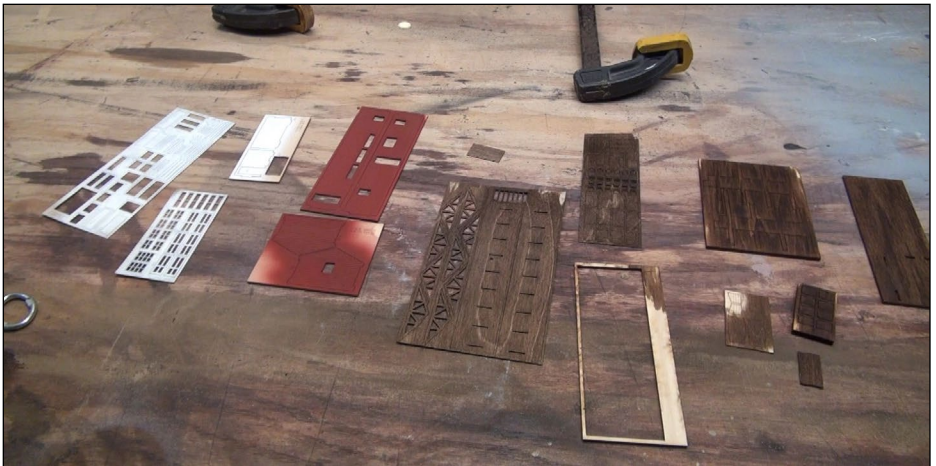

23. This month we build a B.T.S. McCabe Rail Facility Office laser kit. Here you see all the parts painted or stained before assembly. I find this speeds up the building process.

WHAT'S NEAT | 18



24. I glued the building's floor to the foundation, then assembled the interior walls.

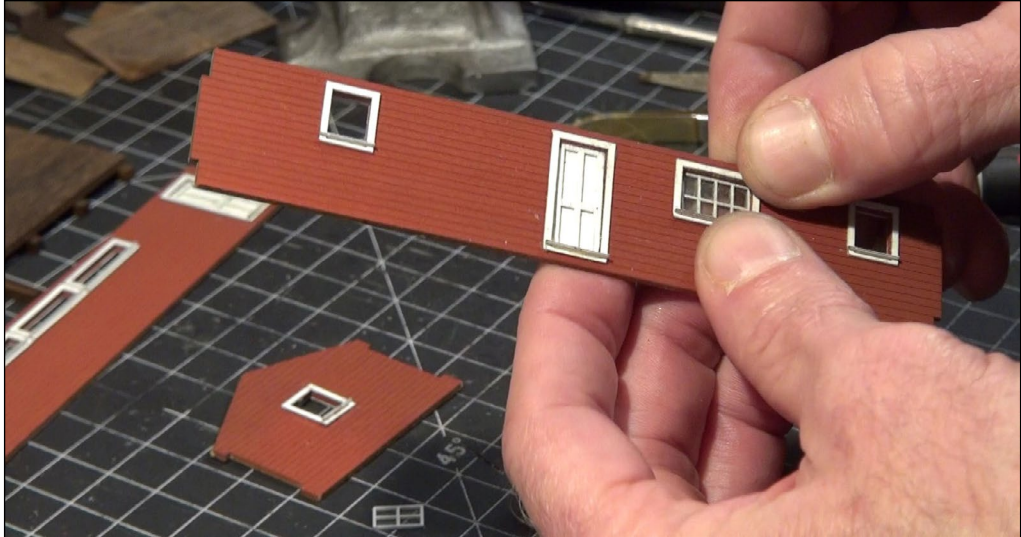

25. I glued the trim and windows to the walls, then glued the main walls to the base.

WHAT'S NEAT | 19

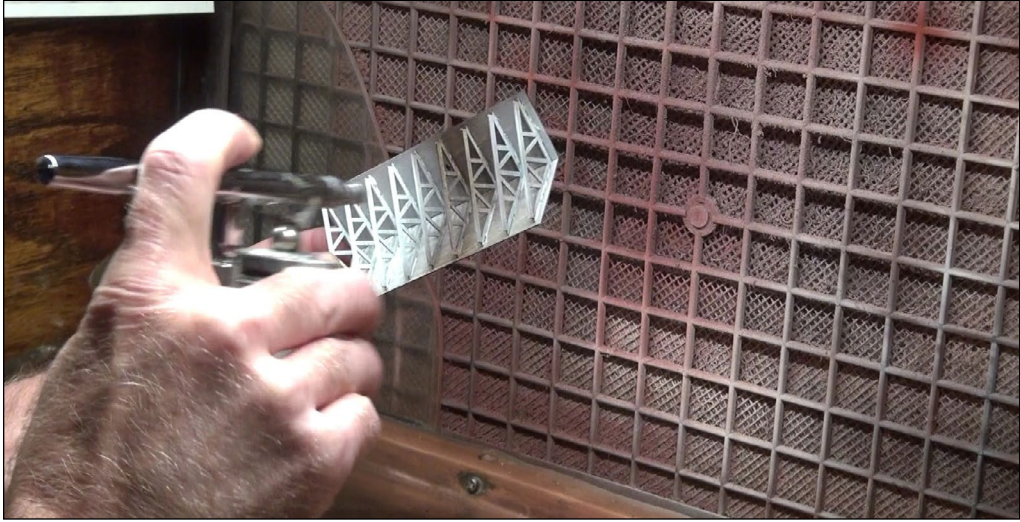

26. The roof and trusses are painted white underneath with Testors flat enamel paint thinned 50%. I applied this with an airbrush with about 25 pounds of air pressure.



27. I decided to use shingles for the roof rather than the tar paper that came with the kit. I colored the shingles flat black, then used gray colored pencils to add further shading before applying the strips to the roof.



28. Here is the finished office building being placed on the layout in the new car shops area I am in the process of building. The kit only took three hours to put together and looks like a craftsman structure.

**Use our custom
Google search on the
MRH website to find
topics of interest**

CLICK TO FIND OUT MORE



29. Here the just-built office building nestles in the background of the overall car shops scene.

Want to keep MRH free?
CLICK on ads.

If ads in MRH don't get clicks, then advertisers won't advertise with us, it's that simple ...



30. Chris Palomarez showed off his new “Tank Train,” purchased from Athearn. The cars are joined together with hoses that made for interesting-sounding coupler slack. We show a few runbys of this train in this month’s video. I was just happy I did not have to purchase a tank train myself! To get the runby footage for this video clip alone would have cost \$2300. It looks really cool with all the hand railings along the top of the train.



[Click here for reader comments](#)



MRH MARKETPLACE

LIGHTS 4 MODELS



Miller Signs | Evan Designs | Iron Penguin
Ring Engineering | EZ Line | Tomar

LED lights & Animated Signs
for all your Modeling & Hobby needs

[Click Here](#)



P.O. Box 6 Paonia, CO 81428

Ph. 970 527 4586

Made in The USA

Cast resin items for All Scales.

Tunnel portals, bridge piers, abutments,
culverts, and retaining walls.

Trackside details and sage brush tree
armatures.

"FREE SHIPPING see website for details"

STREAMLINED BACKSHOP

Sales
... Services
..... Solutions

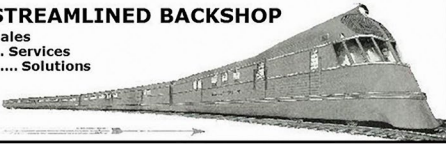

"SUGAR CUBE" SPEAKERS...

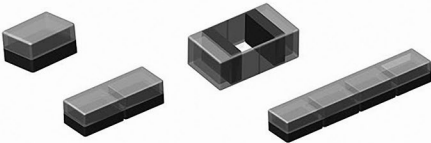

4 Sizes * 4 Baffles

...**"Sweet" Speaker Options!**



www.SBS4DCC.com



Affordable Modular (domino)
Benchwork in 200+ sizes

Custom built to order benchwork also available!

KC'S WORKSHOP CRAFTSMAN MODEL KITS



WWW.KCWORKSHOP.COM



Now Available Again
KIT #5761/5762 PRR GLA
Modernized Hopper

Check our Website For
List of Closeout Kits.
westerfieldmodels.com

LOOK
at what's new at
Black Cat this month

Click here for
our website

Esquimalt and Nanaimo
caboose
in HO,O,N,S & TT



Black Cat Publishing
(204)489-5005
ajfergus@mymts.net
blackcatdecals.com



CLICK HERE



AMERICA'S NUMBER ONE
RAILROAD PRINT SOURCE

...America's Railroad Embroiderer

Railroad Art-Prints,
Caps, Jackets,
Shirts and More ...
Jackets starting
at \$79.95

www.jelsma.com

1-904-221-3513 • Jacksonville, FL.



Your online source for:

Quality DCC Equipment

- Digitrax • TCS • NCE •
- QSI • SoundTraxx •
- Lenz • LokSound •

Visit our website!

dcchobbysupply.com

JEFF OTTO
TURNIN' it OUT

414-915-4671

ohrtracksupply.com
jeff@ohrtracksupply.com

Oak Hill

N36W23431 Oak Hill Ln.
Pewaukee, WI 53072

PRECISION DESIGN CO

Chains
Flat Car loads
Joint Bars
Signs & Posts

FREE SHIPPING

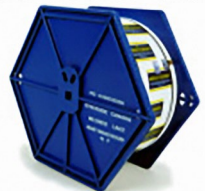

MRH MARKETPLACE | 3

Don't settle for lifeless signals!
We've got signaling circuits!



LOGIC RAIL™ "Sophisticated Model Railroad Electronics"
TECHNOLOGIES

Please visit our website and online store!

21175 Tomball Pkwy Phone: (281)251-5813
 Suite 287 <http://www.logicrailtech.com>
 Houston, TX 77070 info@logicrailtech.com

Model Railroad BenchWork.com



Affordable built to order Benchwork starting at only \$20 a Sq Ft.

Vector Cut .com

PRECISION

Laser Cut Details & Kits

FEATURING
America's Historic Main Street Architecture



MAIN STREET HERITAGE

Mr. Detail Parts

Bulk Packs Now Available



EXPLORE HERE

Available Scales: HO - N - S - O - G - TT - 1:72

www.mrdetailparts.com



ATSF Bx-4B

Yarmouth Model Works
 HO scale resin kits and detail parts

..... U.S.A. MAILING ADDRESS
 3560 Pine Grove Ave. Unit 617
 Port Huron, MI 48060

..... CANADIAN MAILING ADDRESS
 85 Hiawatha St.
 St. Thomas, ON N5P 2T5

Tel. 519-633-7574
pierre.oliver@starL.ca
www.yarmouthmodelworks.com

Great Decals!™

FEC, Interstate, Virginian Railway, & L&N Titles
 After Hours Graphics Line
 Coupler Gages and More
 In O, S, HO, and N Scales





CLEVER
models LLC
Cardstock models & materials

KHARDSTACH BROS. MFG. CO.

Try one today!

www.clevermodels.net

MOUNTAIN SUBDIVISION HOBBIES

www.modelrrsupply.com

FREE USA SHIPPING OVER \$29.00

NCE - SOUNDTRAXX - DIGITRAX - PECO - CIRCUITRON
DCC SPECIALTIES - INTERMOUNTAIN - CMX - ATLAS
BAR MILLS - BOWSER - KATO - MRC - TOMAR - RIX -
PIKESTUFF - LOGICRAIL - CENTRAL VALLEY AND MORE!

RULERS-of-the-WORLD

Scale Rulers \$4 each

Over 200+ scales!

Metric or Imperial

www.rulers-of-the-world.com

HO DIESEL SUPPLY

Are you serious about your HO Diesel fleet or just tinkering? Either way
You probably bought just the right parts you needed from us already

BACKSHOP HARD PARTS DIVISION

Now Direct Personal Service

www.hodieselsupply.com

email: TheBoss@hodieselsupply.com

Have you seen these
popular blogs on the
MRH website?



Tom Johnson's L&IN

270,000 reads

[CLICK TO READ IT NOW](#)



Ken Glover's Shelf Layout

81,000 reads

[CLICK TO READ IT NOW](#)



Taking your diesel locos

TO THE NEXT LEVEL

BY MIKE HOLLY



1. N&W 413 is hard at work pulling a long cut of cars for inter-change with my home road.

• INDEX

• TABLE OF CONTENTS





[Click here for
reader comments](#)

THE ATLAS N&W ALCO C420 WAS THE FIRST

engine I purchased when I started my US-based N scale layout. It remained untouched until I came up with my own freelance railroad and paint scheme. While most of my rolling stock will be repainted to my freelance road scheme, I will keep some foreign road names. I plan on weathering all of my units to a decent level to add a bit of realism.

I initially planned to start weathering this engine, doing some research using the Internet as a source to find some prototype photos. I also researched the *Norfolk and Western, Second Generation Diesels* by Paul K. Withers and Robert G. Bowers, Withers Publishing, that was gifted to me a while back. I discovered that photographs of this specific engine showed two major differences from the model. On the model the air intake hood is missing and the paint scheme doesn't match the prototype.

The prototype engine was decorated in what Norfolk & Western called "Scheme F5." This scheme featured large N&W gold letters on the long hood and the "Hamburger Logo" or half-moon medalion on the front and rear, as well as below the cab windows. Discovering this, I held off on the light weathering idea and went a step further trying to match the prototype by changing a few details.

STEP 1: ADDING DCC

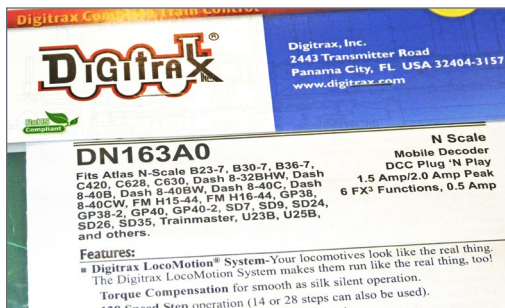

First task I always perform on each non-DCC engine is to add a DCC decoder. For the Atlas Alco C420, Digitrax offers a plug in-decoder. No milling is required and the engine can be converted to DCC in minutes.

The Digitrax decoders come with Kapton Tape, which I remove and keep at hand in case I need to isolate some parts of the chassis from the decoder.

2. I purchased a Digitrax DN163A0 plug-in decoder from my local hobby store.

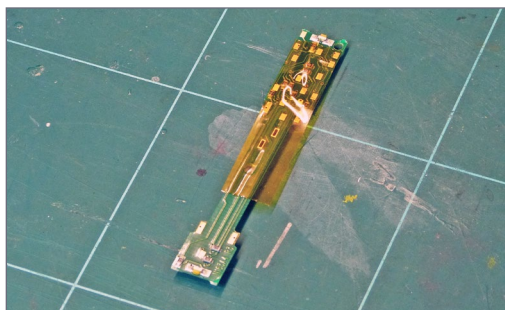

3. The decoder comes with a little strip of Kapton tape on the board. I set this aside to isolate the decoder board from the frame, if needed.

STEP 1: ADDING DCC *CONTINUED...*

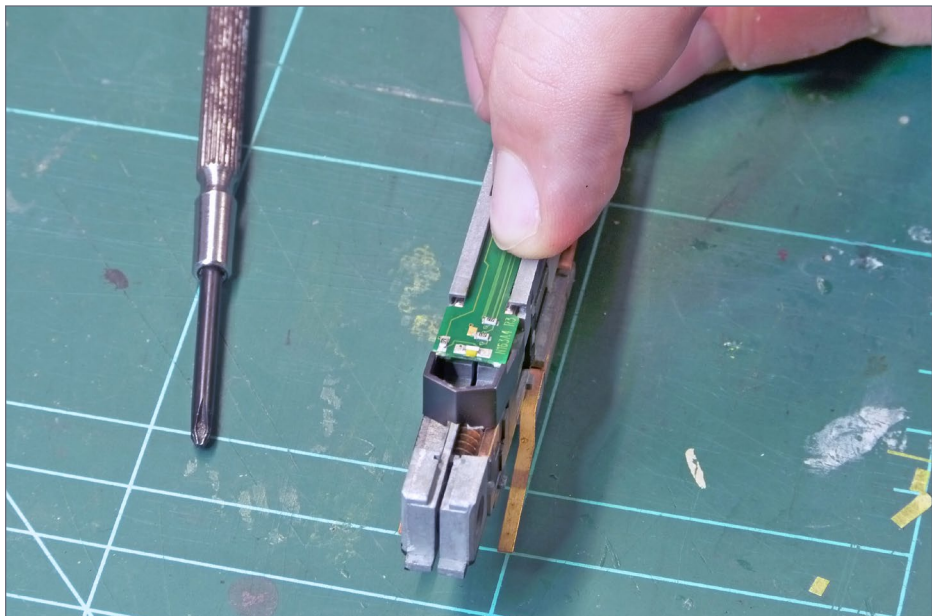

4. The decoder fits into the original place but there is a fair amount of space between the power pickup contacts and the frame.

To remove the DC board from the chassis and insert the DCC decoder, I loosened the two screws and removed one side of the chassis, being careful not to lose any of the bearing parts. After setting the DCC board in place, I noticed a fair amount of space between the frame and the board. Since I don't want to hassle with potential power pickup problems later, I removed the board and added some solder to the power pickup contacts on both sides of the board.

IMPROVING AN ALCO C420 | 6



5. I used solder to build up a little dimple on each of the contact plates for reliable conductivity.

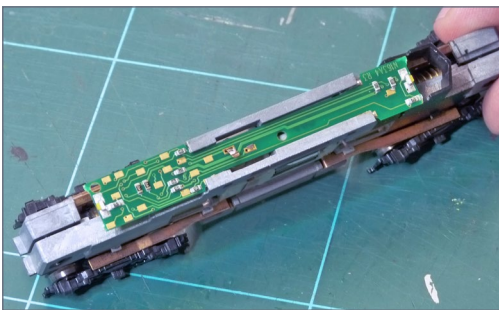

6. The decoder now fits in tightly. The motor contact is provided by the two long-hole notches on the decoder board.

With the contacts tinned, the boards fit snugly into the frame. I performed test runs with the engine to ensure everything worked flawlessly. With DCC installation done, I began modifying the body to match the prototype.

STEP 2: MODIFYING THE CAB

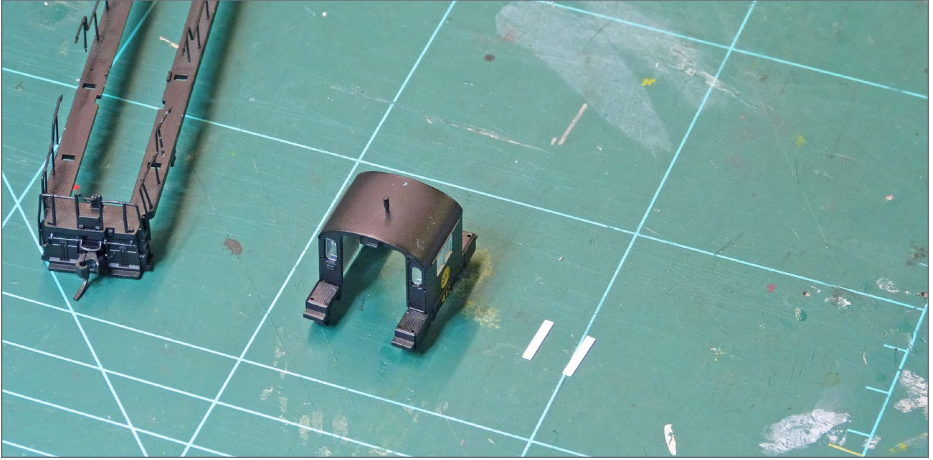

7. I cut to length .010" x .060" styrene strips. The molded gutter helped align the sun shades at the proper angle.

I wanted to match the appearance of the prototype sunshades without purchasing commercially available add-on details. To determine the sunshade width, I compared several styrene strips to the prototype photo. I found that Evergreen .010" x .060", item 103, works good for the width. I determined the length of the sunshades by comparing the prototype photo to the model. I came up with 0.35" to match the overall prototype appearance. For the delicate gluing I use a small piece of wire to apply small amounts of glue to the necessary spots. I glued the styrene stripes to the cab with plastic cement.

IMPROVING AN ALCO C420 | 8

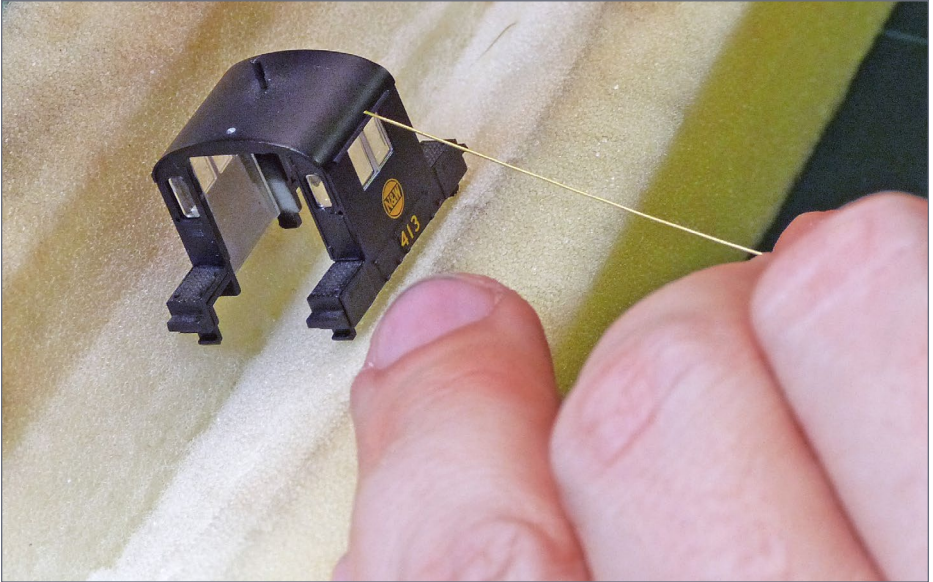

8. I used a small diameter wire to apply glue to delicate spots.



9. With the sun shade is in place, I left the cab sitting in a working cradle until the glue set thoroughly.

STEP 2: MODIFYING THE CAB *CONTINUED...*



10. Cut-to-length brass wire. To make the straightened wire, I picked up a piece of rolled wire with two pairs of pliers, and gently pulled it apart until it stretched a bit.

To simulate the bracing which holds the sunshade in place, I straightened out piece of AWG 28 solid brass wire.

I cut this to length to match the length of the sunshade, and glued it into the gap between the sunshades and the cab, using ACC gel, which takes longer to cure than the liquid ACC.



11. A wood skewer was inserted into the antenna hole and cut off flush with the cab roof after the glue dried.

While working on the cab, I decided to remove the antenna on the center of the roof. To fill the hole, I glued a tip of a wooden skewer into it. After cutting the skewer flush with the cab roof, I sanded the skewer slightly, making it flush with the roof. With this done, the cab was ready for painting. Since I only wanted to repaint the sunshades and the cab roof, I masked off all sides of the cab using Tamiya narrow masking tape..

STEP 3: ADDING THE AIR INTAKES



12. Cut through the upper half of the grille frames.

To build the missing air intake hoods, I took a pair of them off an Alco C628 body from my scrap-box. Atlas also lists them as Part No. 540218 as a spare part for their Alco C628 models. To have them sit perfectly flat against the body, the intake as well as the grilles need to be modified. I snapped off the mounting pins on the backside of the hoods.



13. Cut on the inside of the upper grille frame.

From the grille I removed the upper half of the molded frame and slightly lowered the first row of the molded grid using a sharp razor knife. Visual checks helped me ensure that enough but not to much material was removed. The gray plastic body is a good contrast to the black paint, highlighting the area I was modifying. I glued the air intake hood to the body with plastic cement after the paint was stripped in the next step.

STEP 3: ADDING THE AIR INTAKES *CONTINUED...*

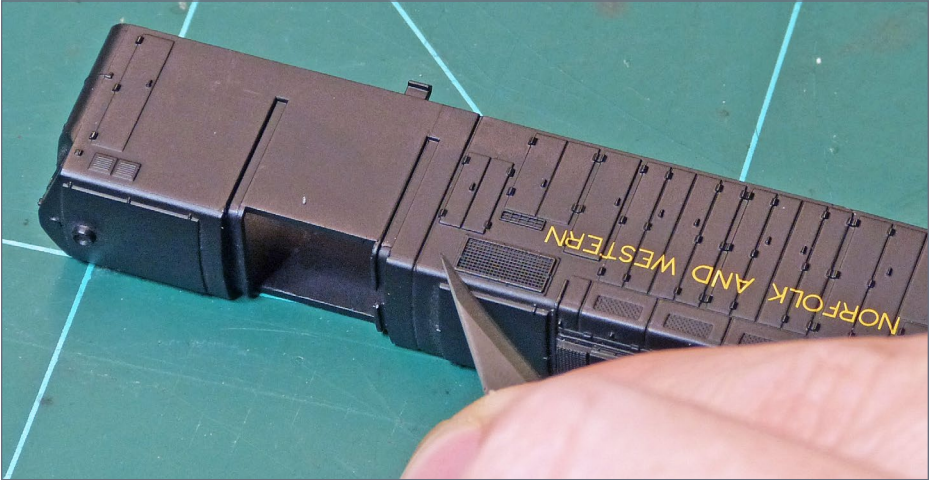

14. I chisel away the grille frame, working from the edge to the middle.

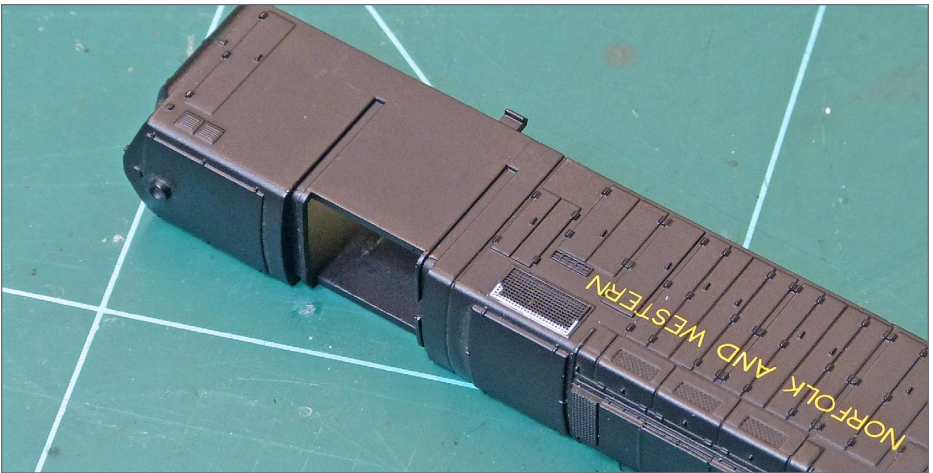

15. The modified grille. I visually checked throughout the process to ensure the air intake hood fit perfectly over the grille.

STEP 4: PAINTING AND LETTERING



16. I used 99% isopropyl alcohol to remove factory paint. After I finished stripping the paint, I stored the used alcohol in a container for re-use on the next job.

I began by removing the factory paint from the body. From several custom paint jobs I did in the past, I found that placing the body in a small bowl filled with 99% isopropyl alcohol is a reliable way to remove the factory paint. To speed up the process, I used a low-budget ultrasonic cleaner. After removing the paint, I rinsed the body with clear water and let it dry. Before repainting the body, I glued the air intake hood in place and left the body untouched until the glue had set

STEP 4: PAINTING AND LETTERING



17. The still-wet body after the paint was removed. The black areas needed to be rubbed with a brush to remove all of the paint, but for repainting in black, it is sufficient to leave it.

Next I airbrushed the body with flat-black acrylic paint. I use locally available artist acrylic paints and thin them with 70% isopropyl alcohol to use in my airbrush. I set the body aside for at least two days to allow the paint to dry thoroughly. After the drying period, I over-sprayed the areas where decals would be placed with a layer of gloss clear acrylics. This gives the decals a smooth surface to sit on and minimizes distortion from enclosed air-bubbles.

IMPROVING AN ALCO C420 | 16

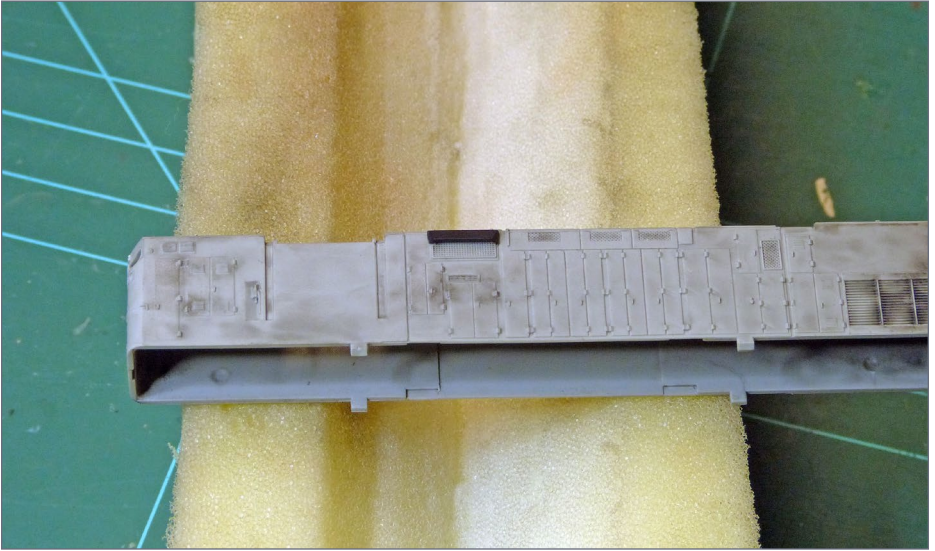

18. The air intake hood glued in place.

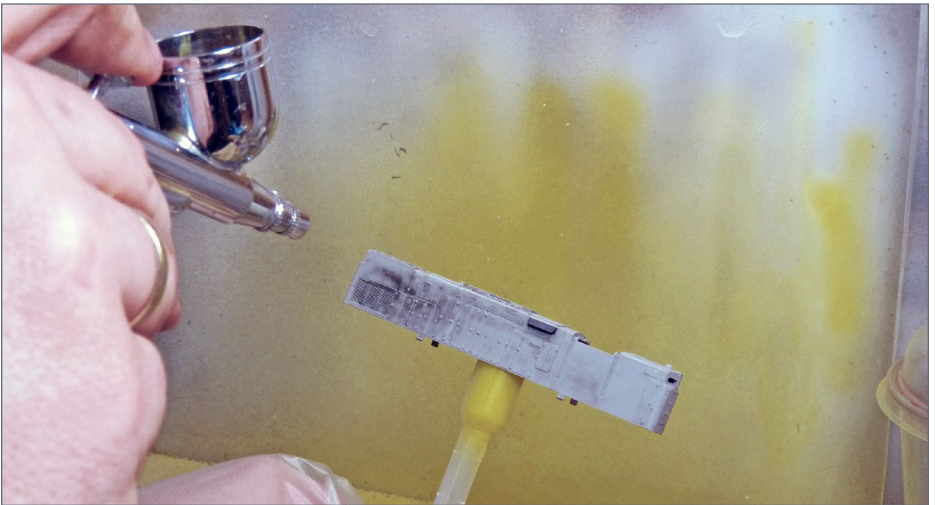

19. The engine body in the paint booth. A disposable plastic pipette helped as a holder.

STEP 4: PAINTING AND LETTERING *CONTINUED...*

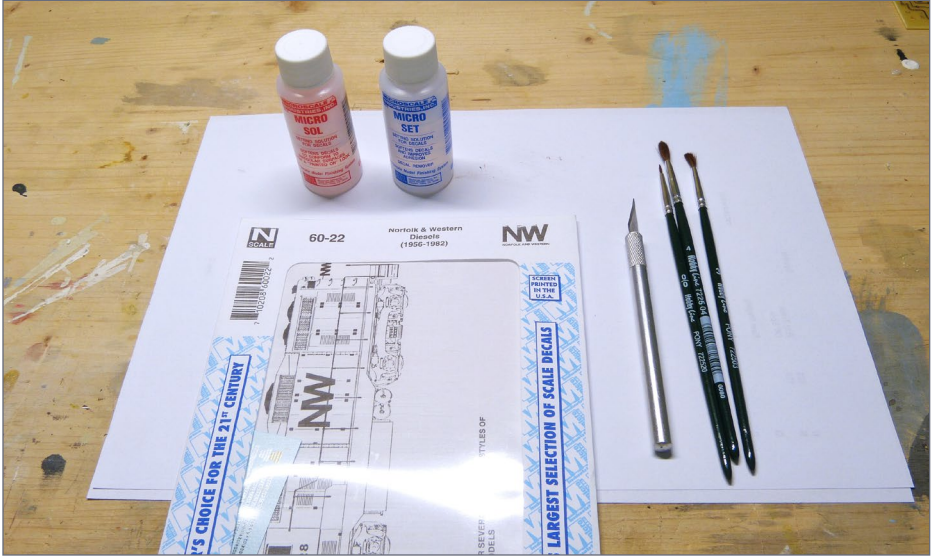

20. The needed tools for decaling.



21. I used a good amount of Microscale Micro Set to lift the decal-film from the backing paper.

IMPROVING AN ALCO C420 | 18

.....

For the N&W lettering I bought Microscale decal set No. 60-22, Norfolk & Western Diesels 1956-1982, which contains the tall N&W letters and the “Hamburger Logo.” Other stuff I recommend for decaling includes Microscale Micro Sol & Micro Set, a set of several soft brushes, a sharp X-Acto knife, and a toothpick.

I used the sharp X-Acto knife to cut the decals from the sheet, leaving a little space between the print and the cutting line. I discovered that even a slightly worn blade will tear the decal instead of cutting it. After the decals are cut, I placed one piece of decal at a time on my workplace and wet it directly with the Micro Set using a soft brush. This will soften the decal more than if you use water to slide it of the backing paper. After wetting the decal, I apply Micro Set on the spot where the decal is to be placed.

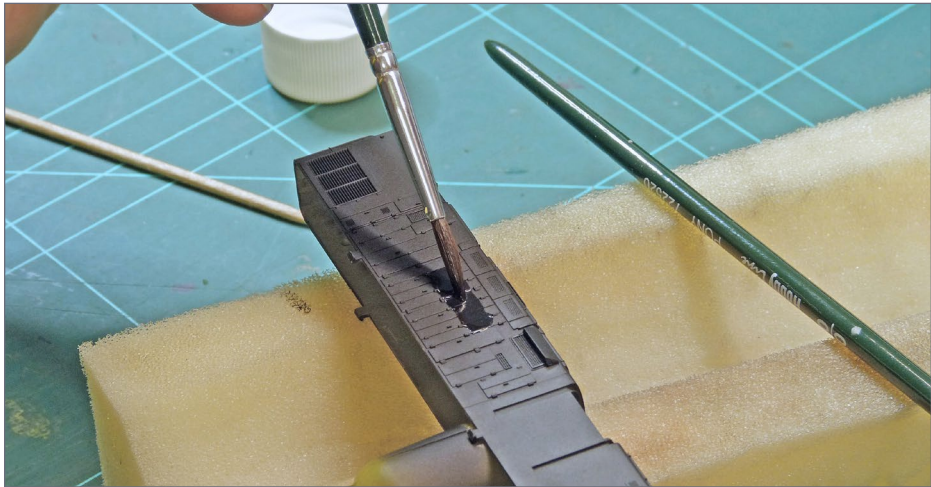

22. I applied some Micro Set to the decal’s location. This helps in aligning the decal.

STEP 4: PAINTING AND LETTERING *CONTINUED...*

When the decal film slid easily on the backing paper I picked up the film using a soft paintbrush tip or the tip of a razor blade, and maneuvered it onto the wet spot on the engine body. I placed the decal onto the surface with no wrinkles. I applied more Micro Set to keep the decal wet, and aligned it with a small soft brush. After it was aligned I squeezed out excess setting solution by gently pressing on the decal with a small soft sponge. A lint-free Q-tip also will do the job. Simply press gently, and do not rub over the decal surface, as that will misalign or destroy the decal.

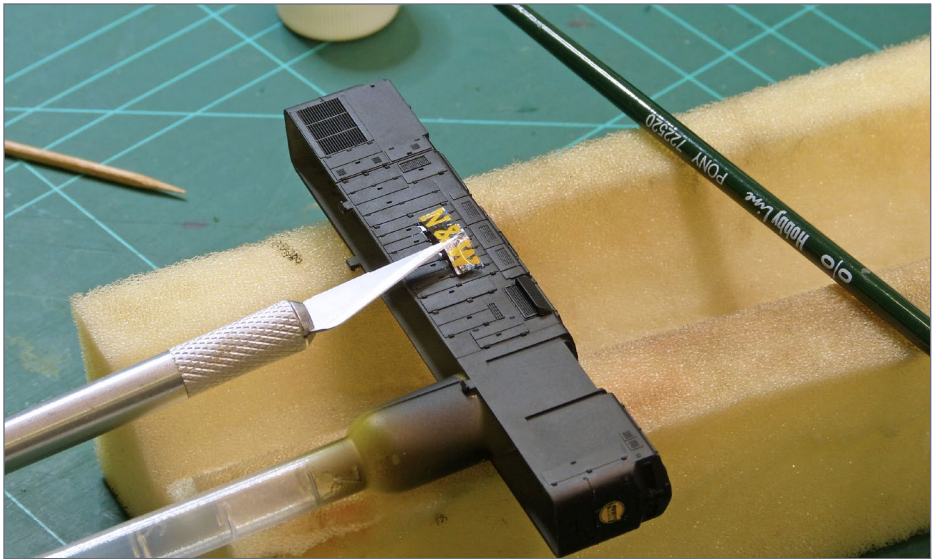

23. I used the tip of an X-Acto blade or a soft brush to transfer the decal from the backing paper to the engine body.

IMPROVING AN ALCO C420 | 20

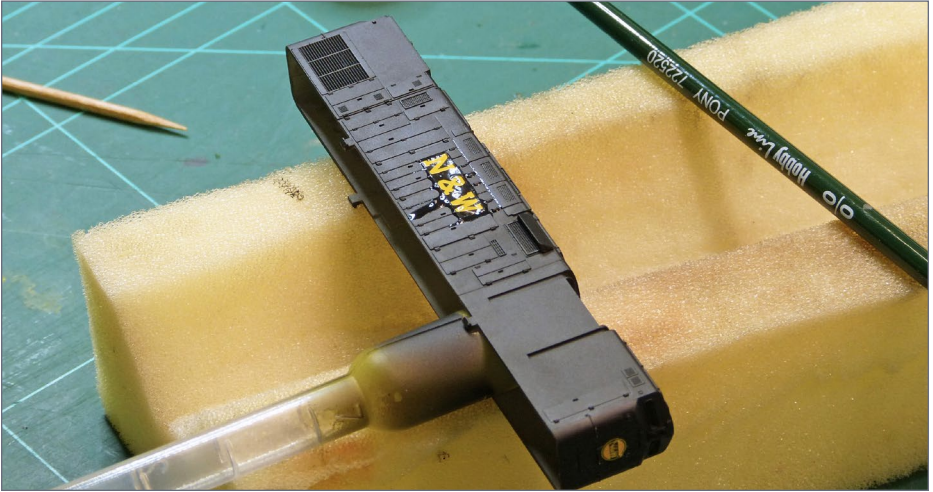

24. Applying more Micro Set helped the decal flow on the engine body for easy alignment.

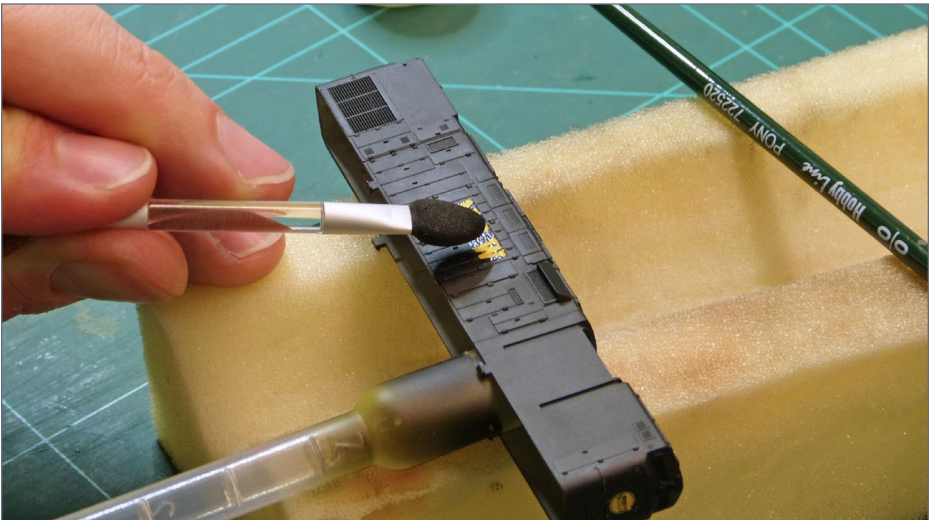

25. After aligning the decal I used a soft sponge or cotton swab to soak away excess Micro Set while gently pressing on the decal.

STEP 4: PAINTING AND LETTERING *CONTINUED*...

I applied the N&W lettering on the engine body where the maintenance doors are located and pressed the decal gently into the gaps using a toothpick. After I was pleased with the alignment, I placed the shell in a flat and level position and applied Micro Sol to the decal, then left it alone until the solution was evaporated. I repeated the process and applied a second application of Micro Sol and pressed the decal film into the gaps and around levers and bolts. I let all decals dry overnight, then continued the other side of the body on the next day. To finalize the decaling part, I sprayed the whole parts with a flat clear coat and let it dry. This secured the decal print and provided a good base-layer for weathering.

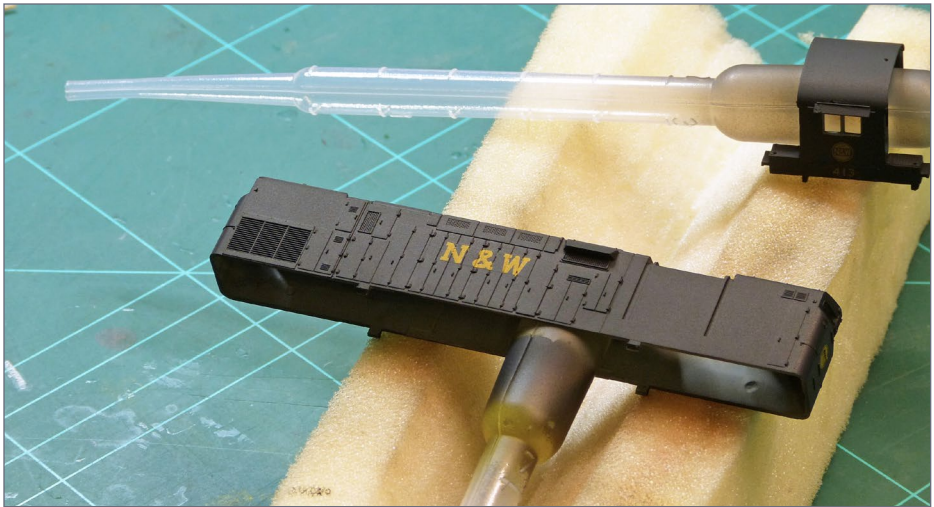

26. I secured the decal with a good overspray of flat clear-coat. This also hid the decal edges.

STEP 5: WEATHERING

With the body prepared, it was time to turn the locomotive from a brand new unit into a well-used workhorse. For my weathering technique, I used mainly powdered pastel chalks and some flat acrylic paint. For oil trails and soot I used clear gloss acrylic paint.

As a basic step I apply clear flat acrylic paint with a touch of off-white added all over the engine body. This gives some teeth for the powder to stick to the body surface and fades the base paint. To keep the window glazing shiny I mask them off with Tamiya masking tape. Another basic step is

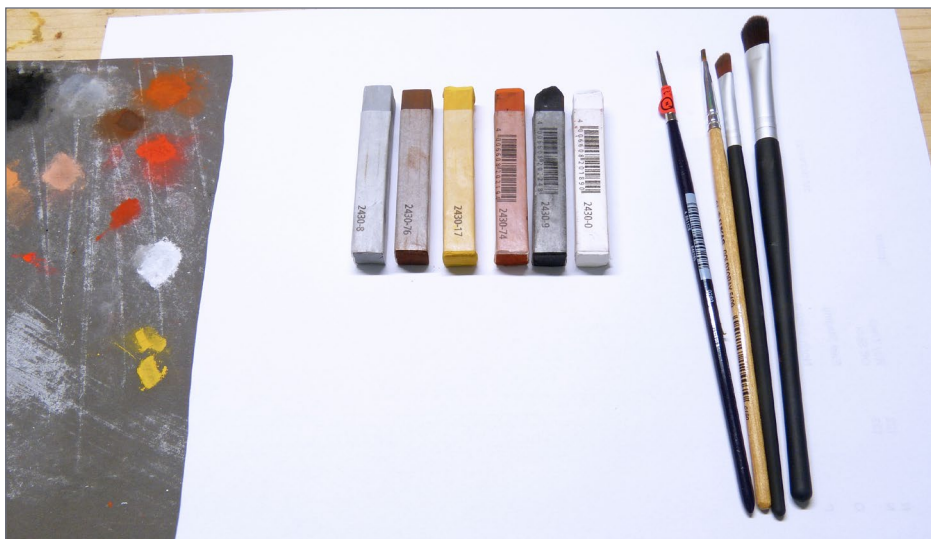

27. The tools for weathering are: Different colored pastel chalks, various soft brushes from a department store beauty department, and a piece of ultra-fine sanding paper.

STEP 5: WEATHERING *CONTINUED...*

adding depth to the radiators and grilles. To do this I apply thinned black flat acrylic paint to them using a very small soft paintbrush. I thin down the acrylic paint using straight 70% isopropyl alcohol. The isopropyl will let the paint flow into the small gaps through capillary action. I do this to all grilles on the engine. To add extra depth I apply several layers of the wash.

After the basics, I added soot around the exhaust on the roof top. I rubbed a chalk stick on a sheet of ultra-fine sandpaper to make chalk powder. I applied the powder using a

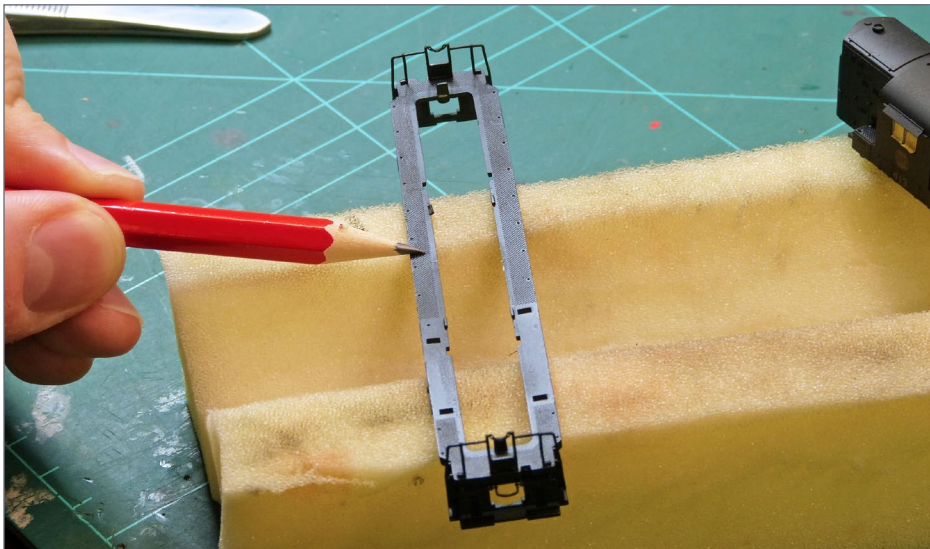

28. To get a “paint scrubbed off”-effect on the running boards, I used an HB-grade graphite pencil and rubbed it over the tread of the running boards.

medium-size makeup brush. To remove excess powder from the brush I swiped it over a paper towel. For the soot effect, I touched the brush near the exhaust stack and brushed the powder away from it. This needs several applications to get the effect of heavy exhaust trails, especially on a black body.

I added some lighter marks to other parts of the body top and the cab roof, starting in the middle and brushing the powder straight to the edges. I also added some streaks beneath the main air intake and the other vent openings on the body sides, starting just below the lattice and brushing down to the bottom of the engine body.

I repeated the application of powder until I got the desired look. When I was pleased with the appearance, I secured the powders by misting them with a flat clear-coat. A hair dryer with low heat setting helped speed the drying.



[Click here for
reader comments](#)

STEP 5: WEATHERING *CONTINUED...*

To add oil spills around the bottom of the doors on the engine sides, I used a two-step procedure. First I applied thinned flat black acrylic paint with only a very sparse amount on the tip of a soft brush. After the black paint dried, I applied thinned glossy clear acrylic paint on top of the black paint. I did this also around the exhaust stack and edges of the roof boxes.



29. I added depth to the radiators and grilles by applying thinned black acrylic paint.

IMPROVING AN ALCO C420 | 26



30. I used a medium-soft brush to put some of the black powder around the exhaust, streaking it outward to the roof edge.

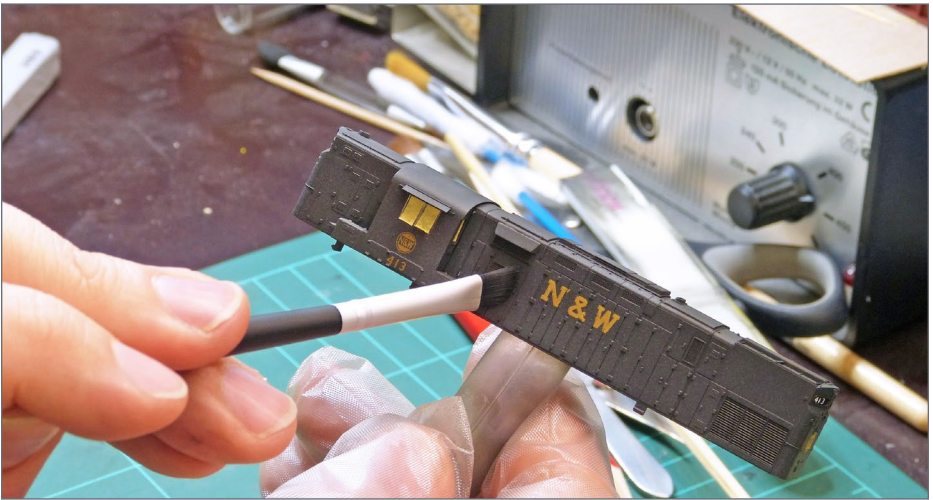

31. To create weathering streaks around the side grilles, I started by applying the powder beneath the grille, brushing it to the lower edge of the body.

STEP 5: WEATHERING *CONTINUED...*

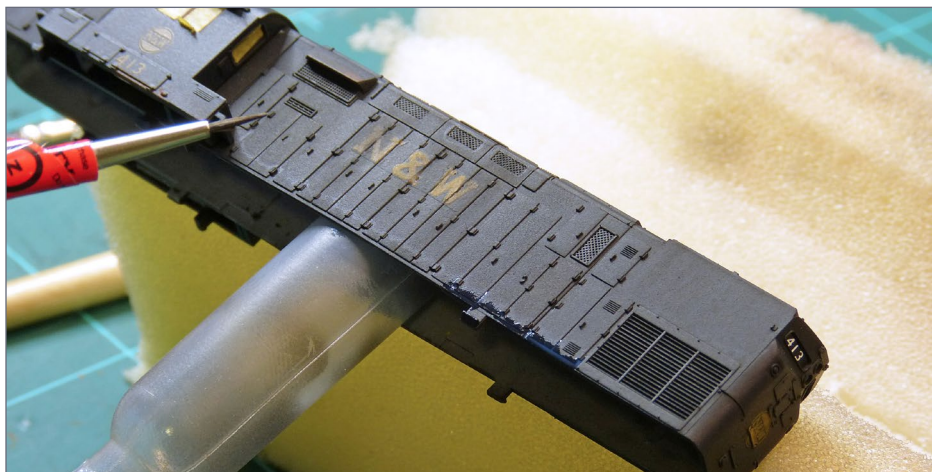

32-34. (Top, bottom and right-top) To create grease or oil spills, I applied thinned black acrylic paint with a small-tip brush (Size 00) to the bottom of the body and edges of the roof boxes. I followed this with clear gloss acrylic to give the shiny effect.

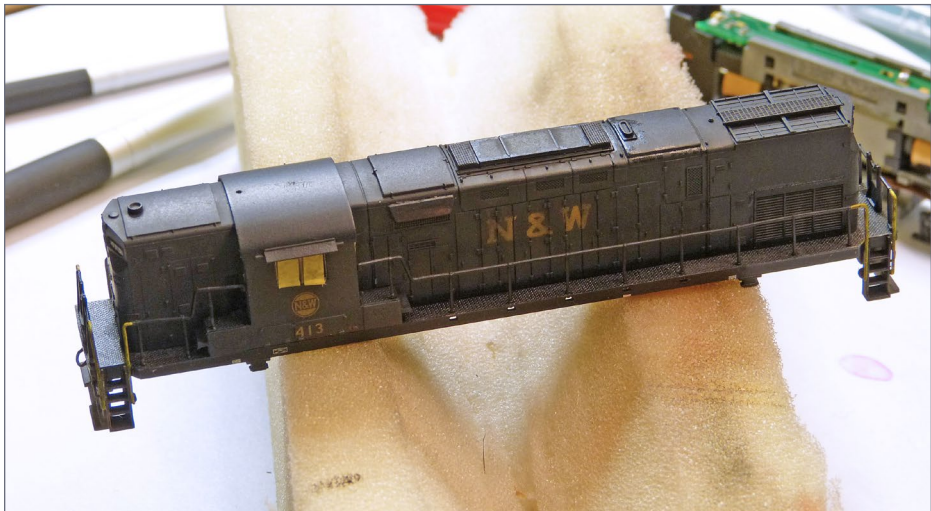

ADVERTISEMENT

ADVERTISEMENT

Backdrop Junction
Your Stop for Railroad Backdrops

Click Here →

**For the Finest in Custom
Designed backdrops**



www.backdropjunction.com

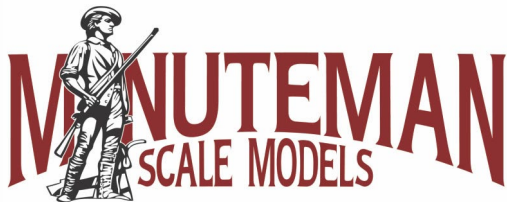

The New Home of...



Scalecoat Model Paint

Phone: (603) 921-5139

Info@minutemanscalemodels.com

STEP 5: WEATHERING CONTINUED...

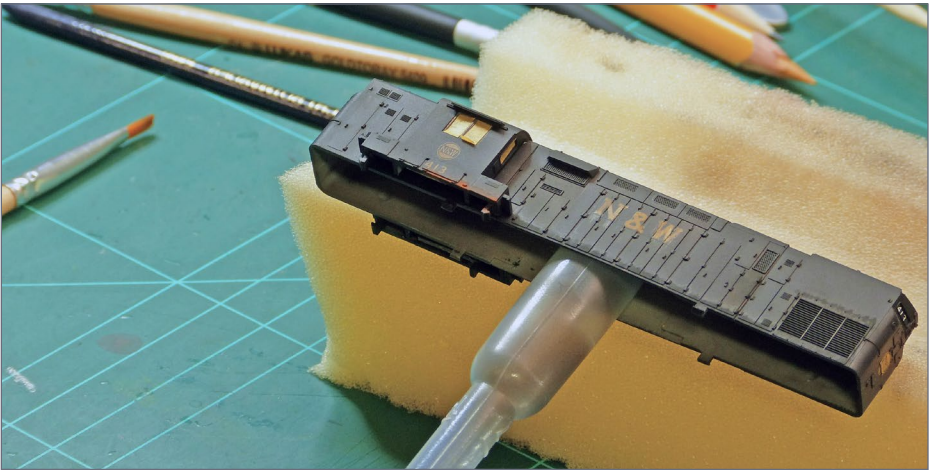
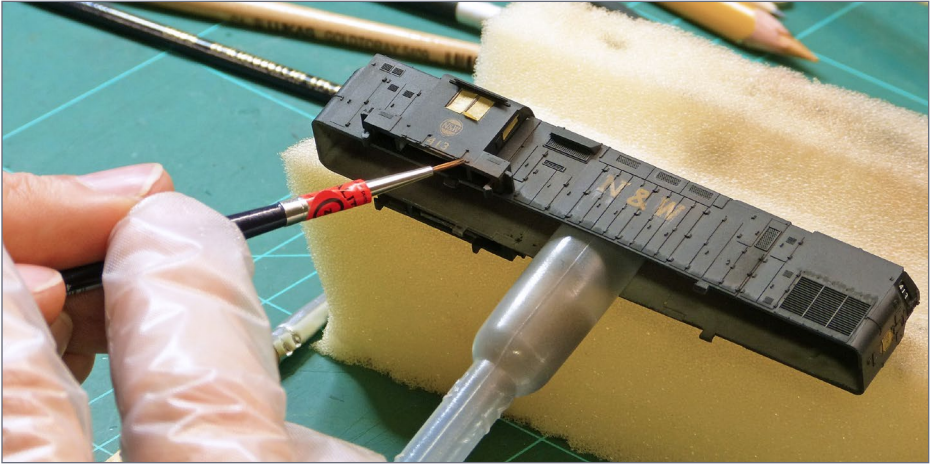

35-36. (Top and bottom) To add local rust spots I applied a good amount of straight 70% isopropyl alcohol to the area. Before the alcohol evaporated, I applied rust colored powder. I used the tip of a size 00 paint brush and applied the powder directly into the alcohol.



37. Brushing these spots with a wide soft brush softened the look of the rust and blended it to the body.

To add local rust spots, I applied straight 70% isopropyl alcohol to the area where I wanted the rust. Before the alcohol evaporated I applied rust-color powder directly into the alcohol with a size 00 paint brush. I blended the rust into the body with a wide soft brush. I added dirt to the lower part of the cab and frame using a gray powder and large makeup brush. As a last step, I secured the powders in place with flat clear-coat.

Now I have a well-used locomotive for my layout.

STEP 5: WEATHERING *CONTINUED*...

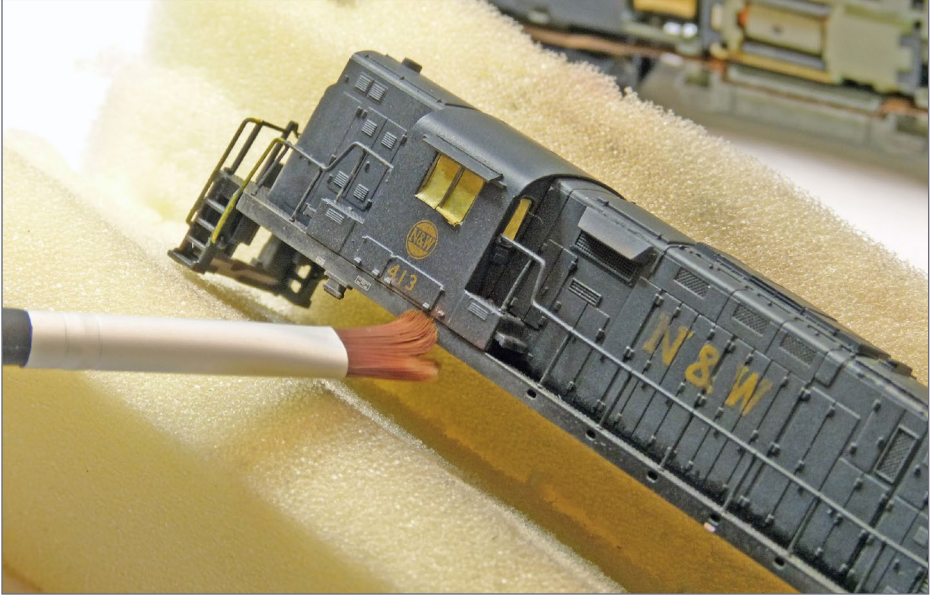

PARTS LIST FOR THE ALCO C420

- DCC decoder, Digitrax DN163A0 or SDN144A0 for sound
 - Air intake hood, Atlas part # 540218
 - Styrene strip .010" x .060" Evergreen item 103
 - AWG 28 brass wire.
 - ACC gel cement.
 - Plastic cement.
 - Microscale decal set No. 60-22 "Norfolk & Western Diesels 1956 – 1982"
 - Microscale Micro Sol
 - Microscale Micro Set
 - Masking tape Tamiya
 - Acrylic paint and clear-coat. Hobby Line by C.Kreul
 - Various pastel chalks, such as Staedler Karat soft pastel chalks ■
-

38. (Top-left) I added some dirt to the body frame and lower cab by brushing on gray powder with a large soft makeup brush.

39. (Bottom-left) To finish off the engine, I highlighted the step handrails on both ends by priming them with white followed by a coat of yellow acrylic paint. Further I airbrushed the couplers in a light rust color and added rust spots to the trucks by brushing on powdered pastels to the brake shoes and springs. The oil streaks on the tank are done by applying clear gloss acrylic paint with a fine soft brush streaking down from the topside.

MIKE HOLLY



Mike Holly, 39, lives in Germany, near Wiesbaden, with his wife Nicole and 5-year-old daughter who loves railfanning.

Mike got his first train set at the age of 10. He started two German themed layouts however after visiting a local U.S. model railroad convention a couple of years ago he got infected by the U.S. railroading virus.

While planning his house, Mike convinced Nicole to add a dedicated room for a model railroad in the basement. After moving in, he started the planning process for his first and current U.S.-themed layout, the proto-freelanced Elizabeth Oaks Branch Line, which is operated by the fictional Cleveland & Eastern Railroad Company in northeast Ohio and Pennsylvania. Construction of the layout started in 2011 and it was extended in 2015.

Mike has a Bachelor of Engineering degree in Road Design and Construction. ■



[Click here for reader comments](#)

Nano-Oil™

Made in U.S.A.

**New
Innovation**

Nano Technology Lubricants

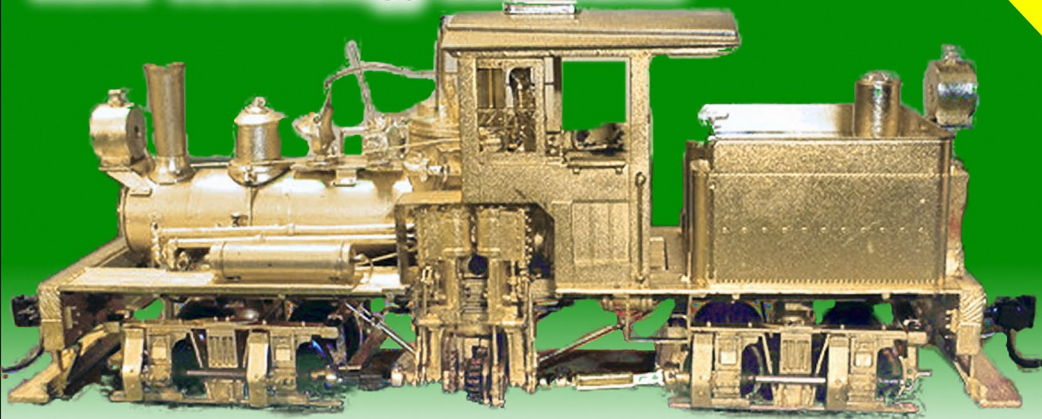

"After eight years of extensive testing, the only lubricants now used in my shop are Nano-Oils and Nano-Grease. The extreme reduction in power draw by mechanically minimizing friction is simply technologically superior."

- Phil Floyd, 'The Shay Fixer'

**Nano-Grease**

For more details click here ...

**THE SHAY FIXER** 

VISIT US AT...

SHAYFIXER.COM

Specializing in brass Pacific Fast Mail / United geared locomotives

• INDEX

• TABLE OF CONTENTS

WEATHERING with Mike Confalone Vol 1: Freight cars

Most comprehensive freight car weathering series ever produced

Over 5 hours
of step-by-step
video



8 different
freight car
projects,
start to
finish

Instant Download

~~\$24.99~~ **\$19.99**

HD format

[GET DOWNLOAD NOW >>](#)

Large video files: Good broadband connection required

“Simply stunning.”
- Axel T.

DVD media **\$29.99**
~~\$44.99~~ + shipping/handling

“Excellent weathering clinic.”
- Andy K.

[PREORDER DVD SET >>](#)

3-DISK SET

Expected to ship late March



YES, IT'S A MODEL

compiled by
DON HANLEY
.....



**Click here for
reader comments**



1. Hunter Hughson made this shot on his home layout depicting North Tonawanda NY in the Penn Central era. Working from period photos, he detailed, painted, and weathered the Atlas locomotive and Bowser caboose. The locomotive reveals its New York Central heritage. The numerals are in the NYC face and the white frame stripe is starting to show through the coat of black paint that was hastily applied at the time of the ill-fated merger. To see more of Hunter's work, visit his blog at ontarioinhoscale.wordpress.com.

► **MRH'S MONTHLY PHOTO ALBUM**



2. James Thompson recently posted this photo of his Seaboard System in the MRH Forum weekly photo fun thread.

The CSXT hopper began as a Walthers Seaboard System car. The end and side ladders were removed along with all molded-on grab irons and replaced with styrene and wire grab irons. The stock air tank, control valve, and brake piston, and sill steps were replaced with Detail Associates parts. Plano etched-metal cut levers and brackets were added along with Sergent couplers. Craft paints were used to fade the lettering and heralds, then multiple washes of oil paints and weathering powders were used to get the faded dirty black. The load is made from a piece of foam board cut and carved to shape, then painted and covered with sawdust.

TMTV Layouts, volume 2!

Our "best layout tours ever produced" series continues!

12 Awesome layouts!

\$14.99 ~~\$19.99~~

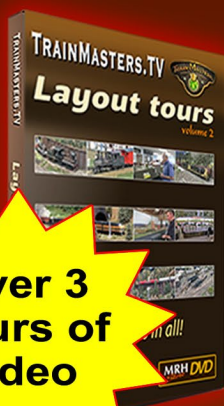

BUY DOWNLOAD NOW >>

Good broadband connection required: large video files

Over 3 hours of video

ORDER DVD SET NOW >>

2 DISK SET

\$24.77 ~~\$39.99~~
+ shipping/handling

2 DVD Set

SPECIAL!



Layouts 1 and 2 DVDs:

GET BOTH FOR \$39.99 >>
+ shipping/handling

Layouts 1 and 2 Download:

GET BOTH FOR \$ 19.99 >>

Get Layouts 1 and 2: That's 28 inspiring layout in all!



3. The low sun is highlighting many of the details on this well-used SP caboose as it tags along on the local. Michael Tolich of Auckland, New Zealand, shared this photo on the MRH Forum recently. The photo was taken on his Pacific Western Railroad layout. The caboose was weathered using the acrylic wash and dry powder method demonstrated by Gary Christensen in his series on *TrainMasters TV*.



[Click here for
reader comments](#)



4. Nicholas Florio shares his first weathering attempt with us. The car is an out-of-the-box 40-foot Modified 1937 AAR boxcar from InterMountain Railway Company. After a few detail upgrades, he was ready to begin his first attempts at weathering.

Nicholas credits hobby publications and online videos with building the confidence to approach his first weathering project with excitement instead of fear. Using acrylic and oil paints as well as weathering powders, he created the look of a car that had been in service for quite some time. Prototype photos were necessary points of reference to naturally depict the unforgiving effects of the elements on the car. As Nicholas says "I plan on putting the techniques I gathered to use on the rest of my rolling stock featured on my HO scale New York Central layout."



5. This is another boxcar, destined to spend some time in the hot, dusty environs of Rick Sutton's Visalia Electric on the eastern edge of the San Joaquin Valley and the foothills of the Sierras.

The VE seemed to collect some pretty worn-out rolling stock and this out of production ExactRail unit fit the bill. An eBay find, Rick distressed the herald and other factory paint with a pencil eraser soaked in rubbing alcohol. Next, it was faded with Vallejo stencil white acrylic and then rusted with Graham transparent orange oxide oil paint and turpentine. Bragdon weathering powders and Dullcote give it the overall dusty patina. The graffiti decals are from Microscale, if he remembers correctly.

YES, IT'S A MODEL | 7



6. Humm . . . let's see, was it the superintendent at fault for not checking the switch alignment before sending him out at 100 mph?

Marc Simpson shared this photo and said fortunately only durable cars went to the ground. Pop the boxcar floor back in and away we go, once the 0-5-0 crane is done re-railing cars!



[Click here for
reader comments](#)

If Power Is Your Passion, Here's More Power To You.

- 125 Watts of sustained power
- Higher volts for G/O, mode switch for HO/N
- Backlit LCD for volts and amps
- Features: momentum, brake button, special slow speed circuitry



[Click Here To Learn More About
MRC's Throttlepack 9950](#)



MODEL RECTIFIER CORPORATION
80 Newfield Ave. ■ Edison, New Jersey 08837 ■ Phone: 732 225 6360 ■ www.modelrectifier.com

TECHNOLOGY. PERFECTED.

Model railroads Plastic model kits Battery chargers Radio control helicopters, planes, cars & boats Slot Cars Scenery Die cast

• INDEX

• TABLE OF CONTENTS

\$ GET PAID FOR YOUR PHOTO

We pay \$40 per photo we publish. If you'd like to get your modeling in our photo feature, just start posting your photos on the MRH website, especially in the Weekly Photo Fun thread created each weekend.

See mrhmag.com/help for more on how to post an image. You need to be an MRH subscriber to post photos to our website, and becoming a subscriber is free, [just fill out this form here.](#) ■

 **Click here for reader comments**

Take the MRH 2016 Reader Survey ...



fireHD10
OUR LARGEST DISPLAY
— ON OUR —
THINNEST TABLET

amazon

... and get a chance to win a 10" Kindle Fire tablet!

TAKE THE SURVEY >>

You're the kid.



Welcome to the candy store.

- 180,000 square feet of “candy”
- Over 250 manufacturer & retailer booths
- 44,000 square feet of modular layouts
- “Ask the Collectibles” appraiser
- Trains, accessories, collectibles & more
- Hands-on demonstrations

July 8 - 10, 2016
Indiana Convention
Center

100 S. Capitol Ave.
Indianapolis, IN 46225

**CLICK HERE
FOR ALL THE
DETAILS!**

www.nationaltrainshow.com

Sponsored by



We make it more fun!

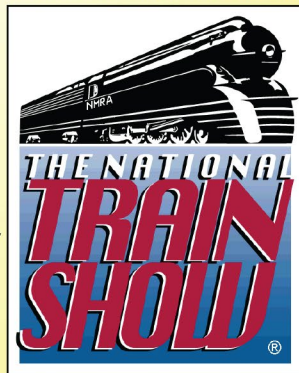

• INDEX

• TABLE OF CONTENTS

SCRATCHBUILDING

With Monster Model Works Brick – PART 1



BY DAVID KARKOSKI

Take your brick structures to the next level...

I HAVE BEEN CONSTRUCTING MODELS FOR over 50 years and have used many types of materials to simulate brick. My results were usually satisfactory using these materials; when Monster Model Works introduced their etched basswood material I was interested in trying it out. I was totally amazed at the results I obtained using this product.

To demonstrate techniques using MMW brick materials, I constructed three flats that represent trackside warehouses. These

• [INDEX](#)

• [TABLE OF CONTENTS](#)



1. The warehouses built with Monster Model Works brick sheets.

freelanced buildings would have been constructed in different eras – 1880s, 1890s, and 1900s. Buildings like these can still be found in contemporary settings.

When I scratchbuild a structure, either freelanced or working from photos, I find it helpful to use a CAD program to create a simple outline drawing of the major features of the building. I print the drawing and work out the details of the model.

During the construction of these models I did make changes that were not on my original plans, not an uncommon occurrence when freelancing.



**Click here for
reader comments**

This documentation is not intended to be a detailed step by step build of a structure but a review of techniques to create satisfactory results when using MMW materials. In part 1, I cover the brick structure itself. In part 2 next month, I get into doing the roof and related details.

ADVERTISEMENT



Rusty Stumps
Scale Models

WE ONLY SELL WHAT WE MANUFACTURE

DETAILS IN HO, O, S
& N SCALES

LASER CUT SHINGLES, DOORS & WINDOWS,
FENCES, SIDING, CRATES. Also RESIN and
WHITE METAL DETAILING CASTINGS.

CRAFTSMAN KITS
IN HO, O & S SCALES

CHECK IT ALL OUT AT
WWW.RUSTYSTUMPS.COM

Send \$3.50 for Catalog - Specify Scale

RUSTY STUMPS SCALE MODELS

6785 Cherry Blossom W. Dr., Fishers IN 46038

Phone (317) 595-9489

An 1890s Building

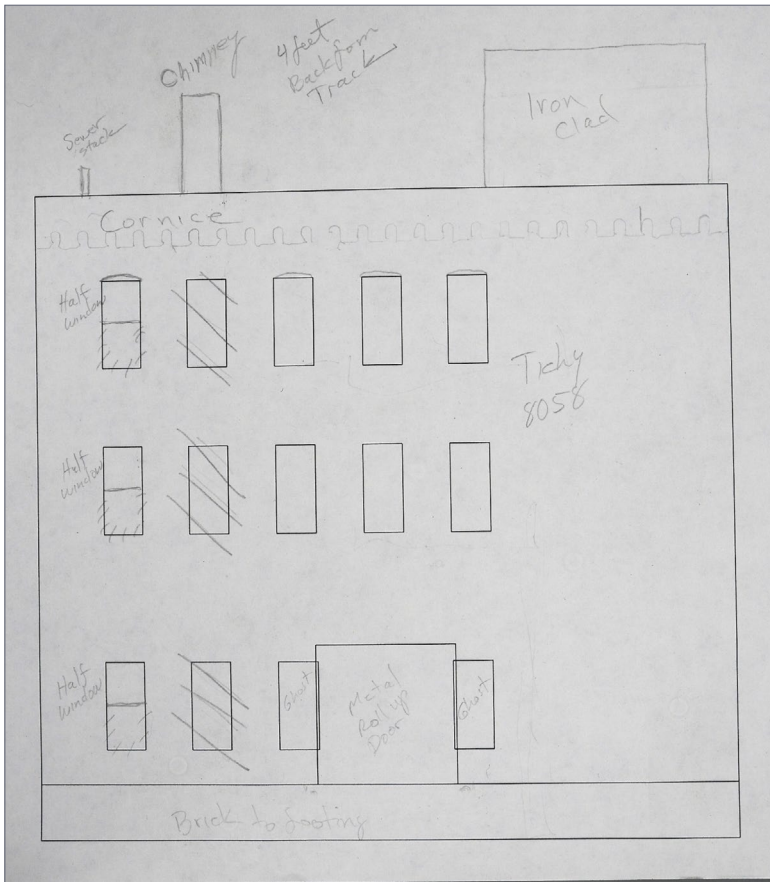

2. This is the outline drawing of my 1890s building. When I created the drawing I made window openings scaled to the size of the Tichy 8058 Masonry 6/6 castings. I have included an enlarged freight door, a 1950s upgrade, with some patched-in windows on its flanks. I also removed one column of windows and decided that a half-window would represent the locations of restrooms on each floor. This building has a cornice, iron-clad elevator penthouse, chimney, and a four-foot deep loading dock.

Wall Sections

MMW has three textures of brick available for modeling – clean brick, aged American brick, and old brick. I used the aged brick on the 1890 and 1900 buildings and old brick on the 1880 building.

3-4. The majority of brick sheets are very accurately etched. Occasionally one might have a misaligned starting row as seen above. To build a crisp model it is imperative that the brick courses be horizontal, so this misaligned row of brick must be removed. My preferred tool for cutting this sheeting is a single-edge razor blade. Note that there is an UP direction marked on the back of the brick sheet. Indicate this direction on all your cut pieces, as you will need to reference it in later construction steps.

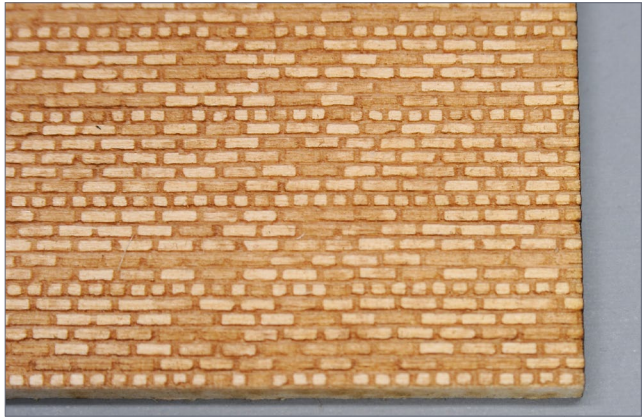
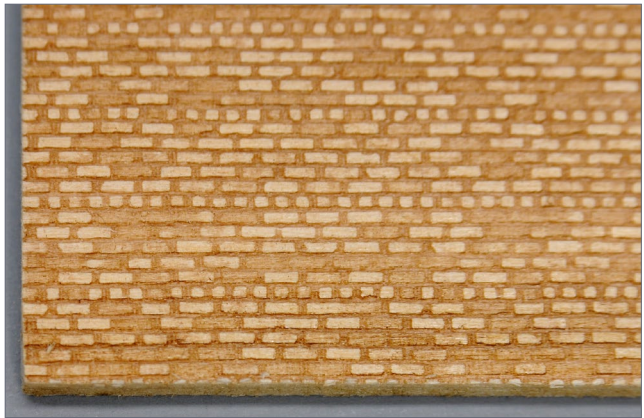

PART 1: SCRATCHBUILDING WITH MMW | 6

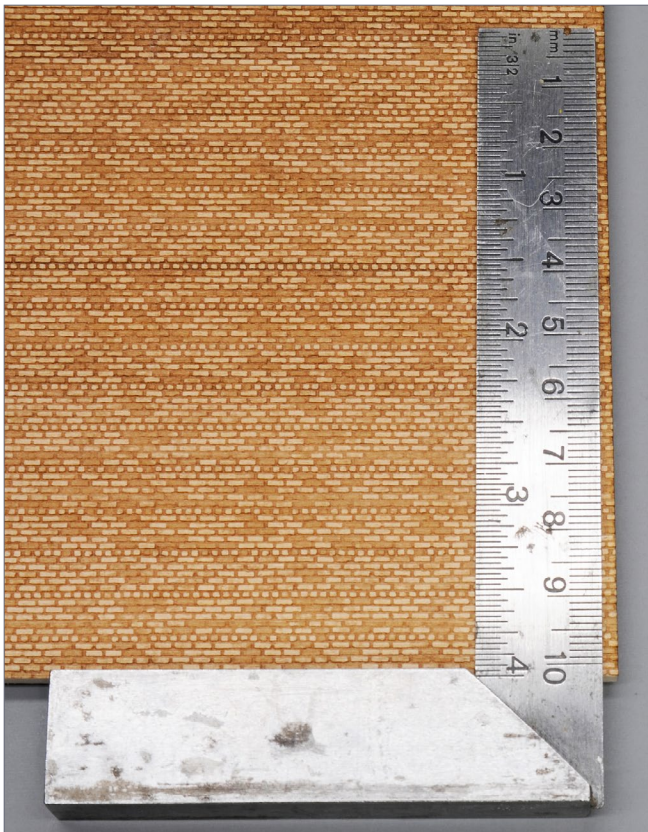

5. (Top) After removing the misaligned row of brick, you must reestablish a square end on the sheet. It is a good practice to verify that all sheets are square with the mortar lines.

6. (Bottom) I always sand the end of the sheet to ensure that it is perpendicular to the sheet face. You must do this on the laser-cut edge, as well as on your cut ends, cutting in either case creates a slight bevel. If not removed, this bevel will make it impossible to create a tight fit with the MMW corner posts.



PART 1: SCRATCHBUILDING WITH MMW | 7

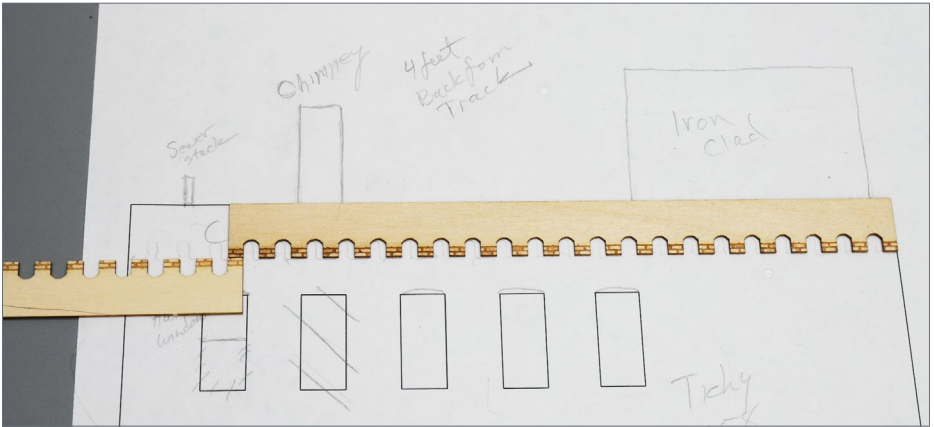

7. MMW manufactures a cornice that is used on the 1890 Building. It is important that a complete bottom segment align with the edge of the wall. As can be seen, my drawn wall is a little longer than a cornice bottom and will need to be shortened.

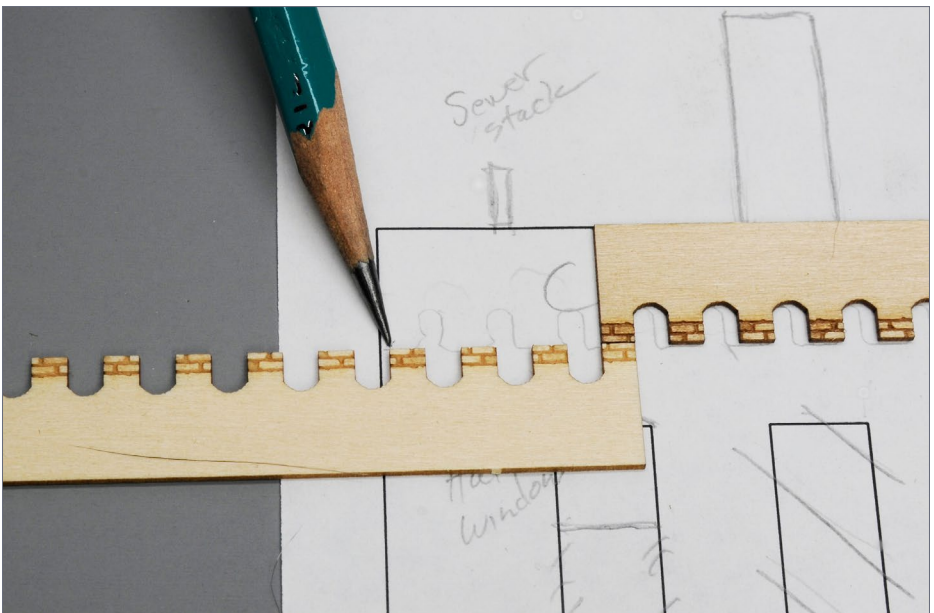

8. Mark the location of the cornice bottom; this is now the total width of the building.

PART 1: SCRATCHBUILDING WITH MMW | 8

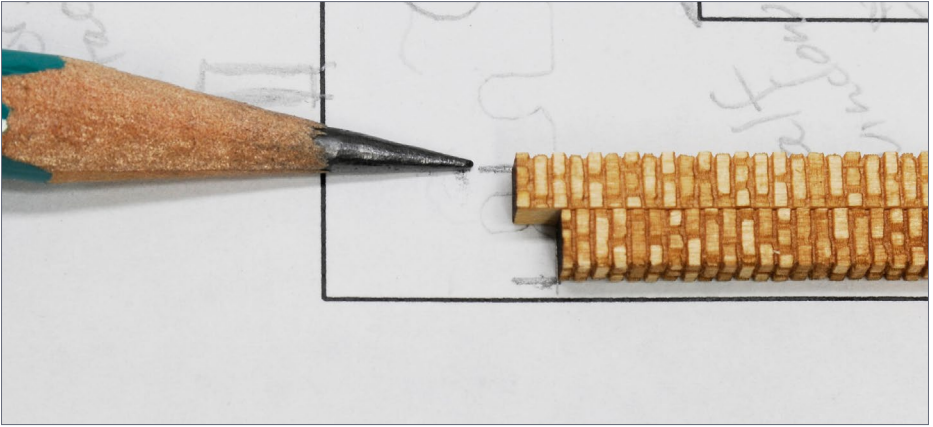

9. Next take two corner posts, abut their backs, align with the total wall width mark, and mark the width of the wall face to be cut from the brick sheet.



10. Transfer your wall width measurement to the stock sheet. Work in such a way that your straightedge protects the wall face from a wandering blade. In this photo the wall face is on the left, waste is on the right.



11. Tip 1: When cutting the 1/8"-thick basswood sheet, position it such that the waste side overhangs the edge of your cutting mat. This will allow the waste material to flex down out of the way of the blade, making it much easier to draw the blade through the wood.

Take the MRH 2016 Reader Survey ...



... and get a chance
to win a 10" Kindle
Fire tablet!



fireHD10
OUR LARGEST
DISPLAY
— ON OUR —
THINNEST TABLET

amazon

TAKE THE SURVEY >>

TrainMasters TV ...

Cast your vote for *MORE* Network-TV level video programming for model railroading from MRH



**Become a TMTV
member today**



Brought to you by

MRH
MODEL RAILROAD HOBBYIST

PART 1: SCRATCHBUILDING WITH MMW | 10

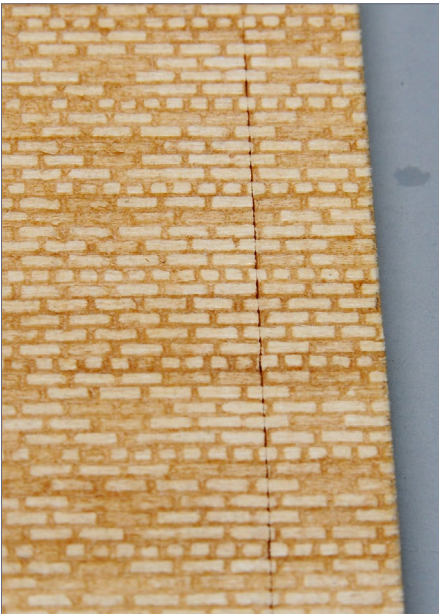
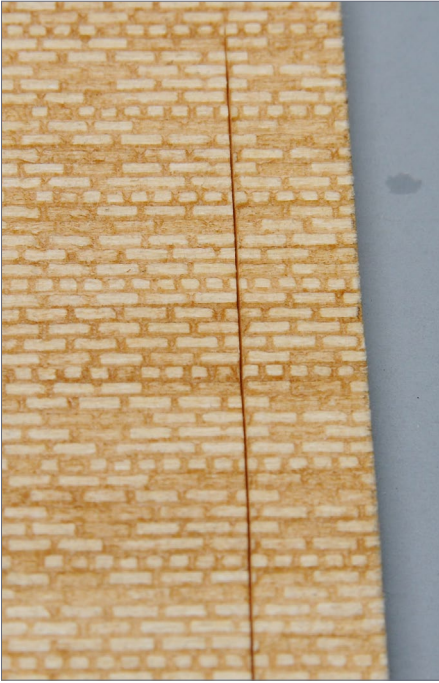

Horizontal Seams



12-15. (Left) Tip 2: The basswood substrate allows you to correct inadvertent cuts. On the upper-left is a cut about 1/32" deep that needs to be corrected. First press the wood back into the cut along both edges. I find my fingernail works well for this. To swell the wood, apply a few drops of water along the cut and allow it to soak in. The photo on the bottom-right shows the repair, after painting it will never be seen.

16. (Above) A horizontal seam between sheets is not difficult to fabricate. The primary concern is to create a mortar line that matches the standard mortar lines. In the above photo it can be seen that the joint between the bond course and running course needs to be reduced to match the surrounding mortar lines.

PART 1: SCRATCHBUILDING WITH MMW | 12

Window Openings - method one

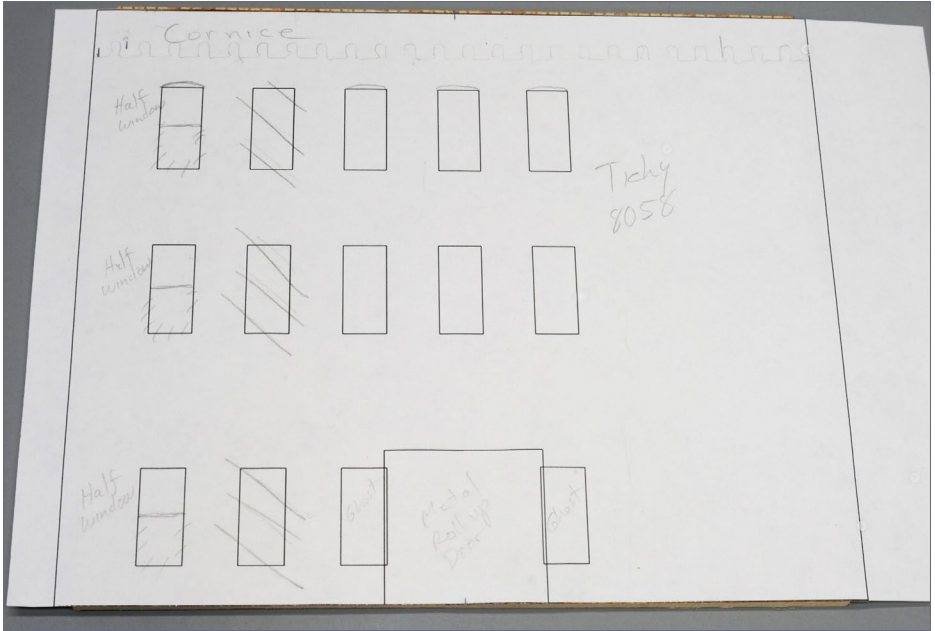

17. Having precise window opening sizes on my printout of the building allows me to use it as a template to cut out the windows. The door is centered on the wall. Mark its center point on the top and bottom of the template, aligning the marks with the corresponding wall center points. Make sure the bottom of the template is aligned with the bottom of the wall, and verify your up direction mark. Use double-sided tape to hold the template in place.

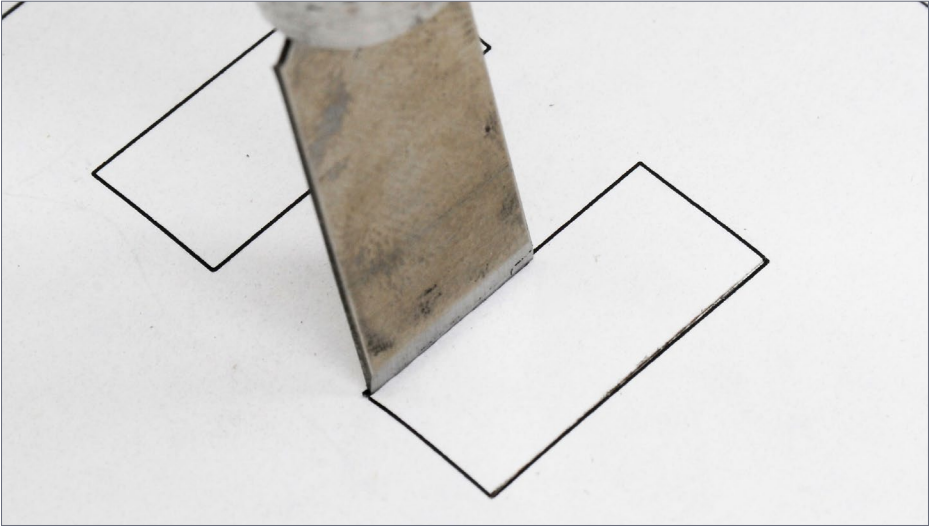

18. The 1/8" thick basswood wall requires a special technique to cut out openings – creation of a relief notch. It is imperative that you work from the front of the wall toward the back; this will prevent the etched bricks from breaking away from the wall at your cut line. Use a wide chisel blade along the sides of the windows and a narrow blade along the top. Press the blade into the basswood about 1/32". Follow the inner edge of the template, as the opening can be enlarged later if needed.



[Click here for reader comments](#)

PART 1: SCRATCHBUILDING WITH MMW | 14

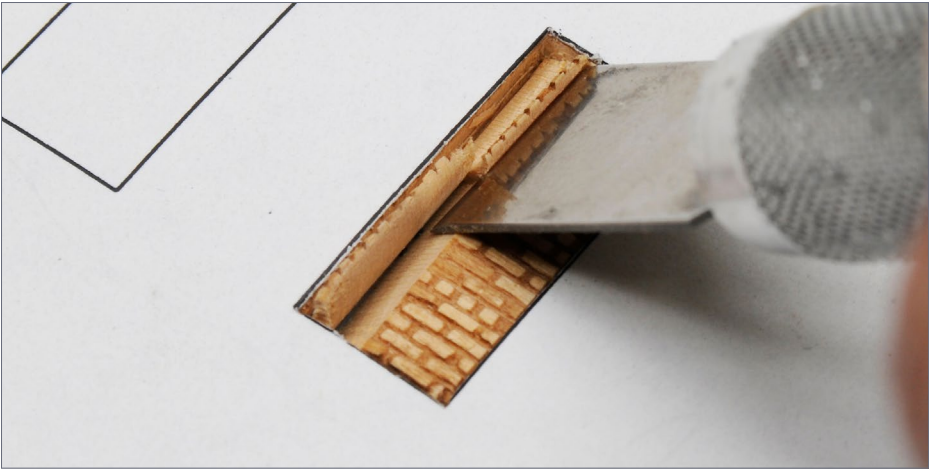
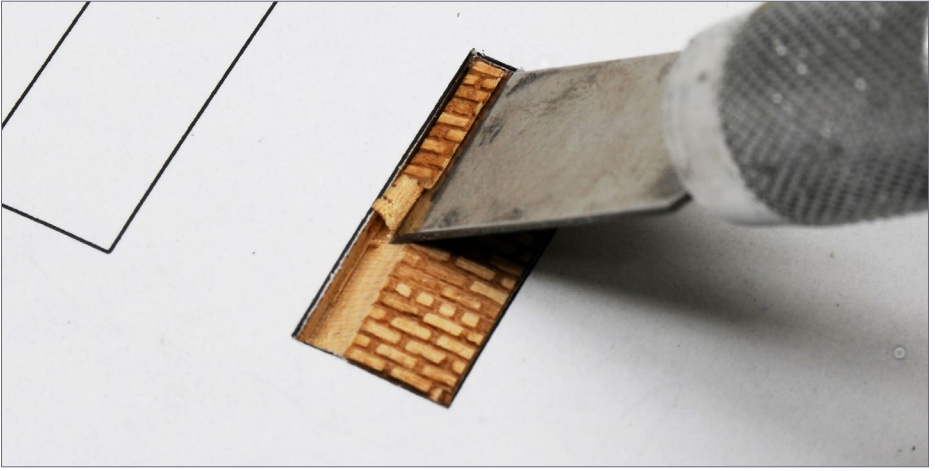

19-20. Create your notch on the side of the window that has the narrowest amount of wall, in this case between the windows. Do a bevel cut down to the vertical cut made along the side removing a wedge of waste wood. Repeat the initial vertical cut followed by the bevel cut; repeat this process until you create a slot.

PART 1: SCRATCHBUILDING WITH MMW | 15

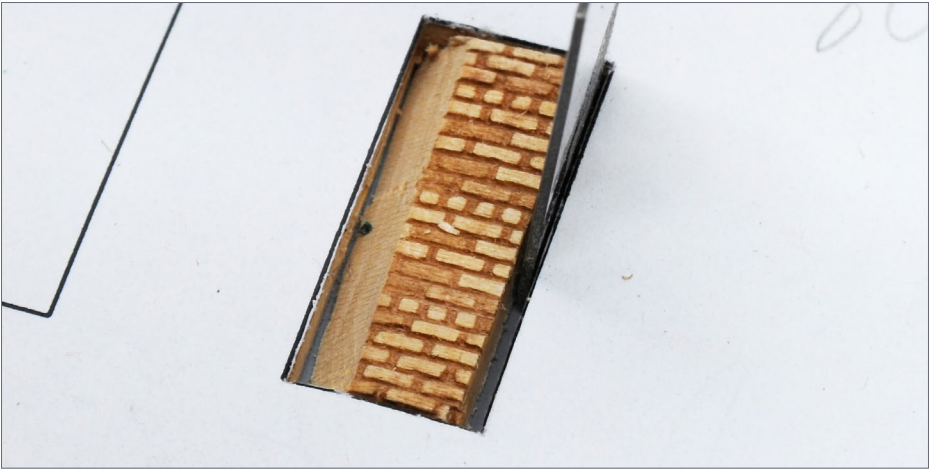

21-22 This slot will create space for the window cutout to enter. Again using a vertical cut, slice down through the wood along the top and bottom of the window. Now cut through the last side of the window opening using several shallow vertical punch cuts. As you cut thru, the waste material will shift into the notch.

PART 1: SCRATCHBUILDING WITH MMW | 16

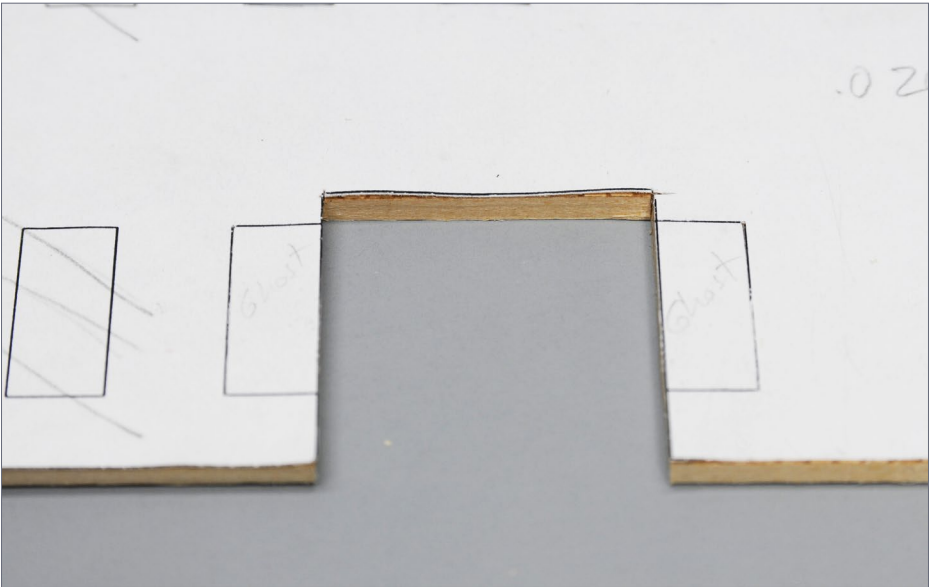
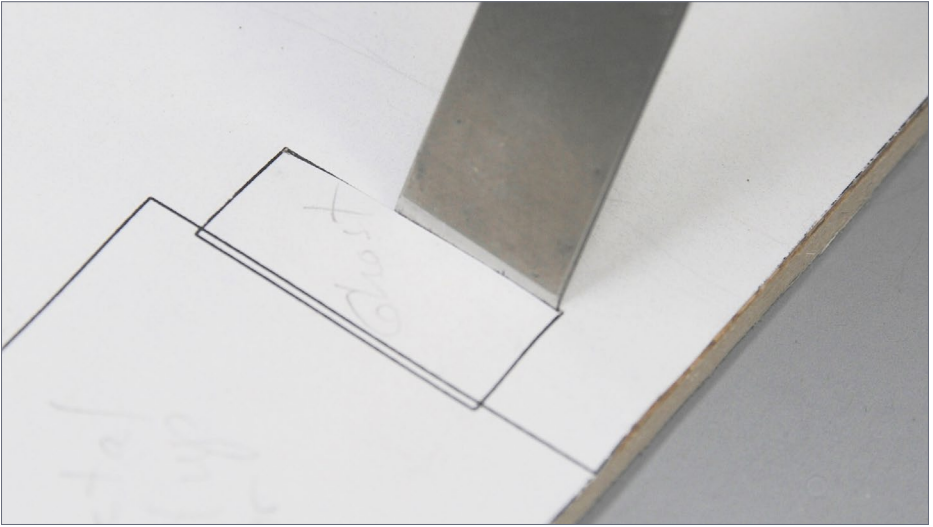

23-24. (Above) To create the ghost window, score a seam along the side of the window. Do not remove any of the brick from the opening. The door opening is created using the same technique as on the windows.

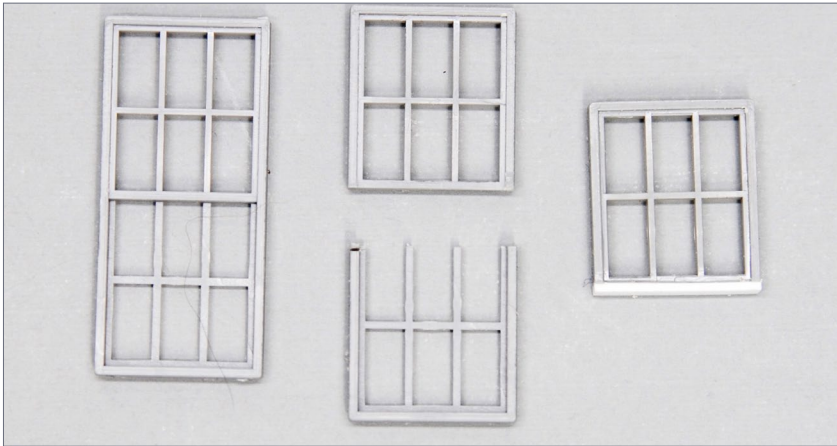

25. To create the restroom window, split the Tichy 8058 window as shown and then bond a strip of .020" x .060" styrene along the bottom of the upper sash to create a sill.

ADVERTISEMENT

Lasercut kits and details

O, S, HO, TT and N scale



New kit
"The Grove"
HO, N and
TT scales



Custom cutting, Scratch Building supplies
ASPEN Models N, Nn3 and Z scale

Rslaserkits



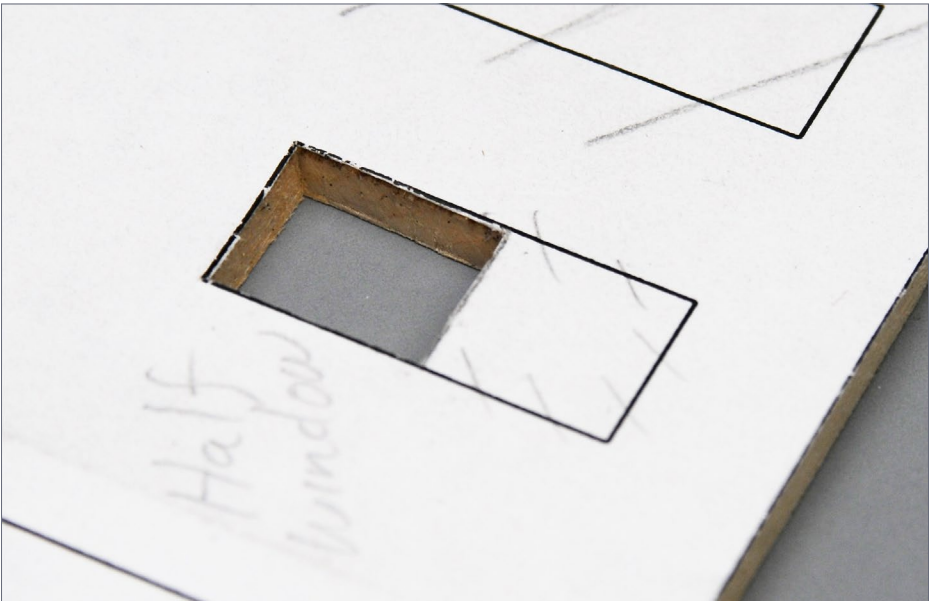
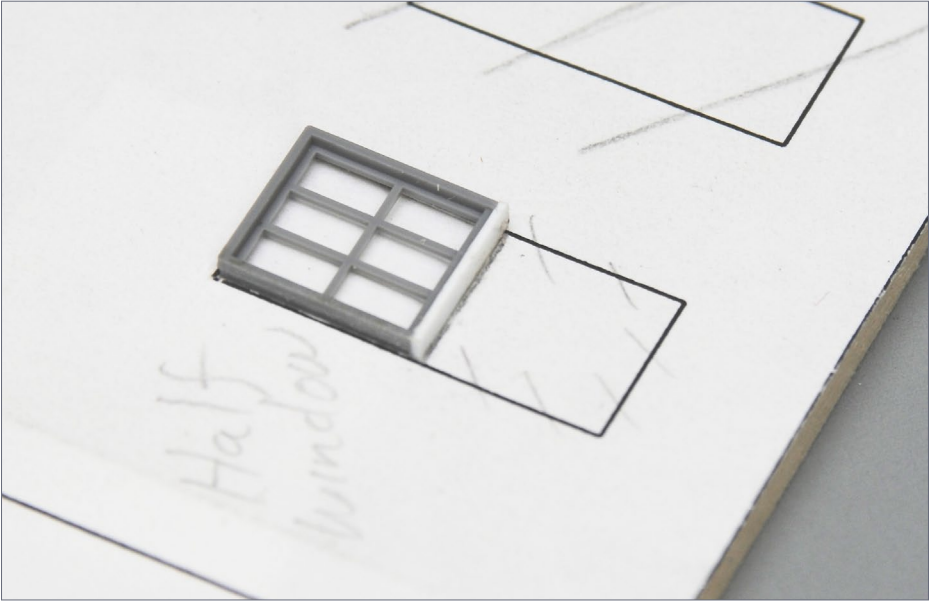

26-27. Use the fabricated half-window to mark the bottom of the sill, and then cut out the opening.

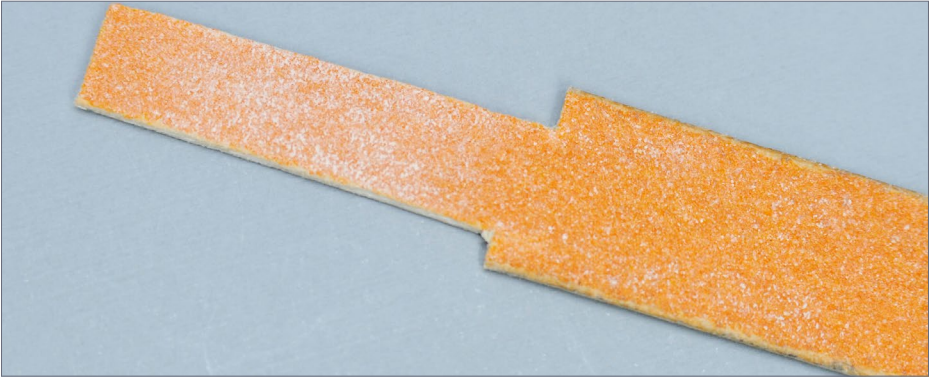

28. Tip 3: Emery boards make excellent sanding tools when working with wood. To facilitate sanding out the window openings, cut a tab on the end of the board. This allows the board to fit within the opening and creates square edges along the tabs side. This square edge helps clean out corners.

ADVERTISEMENT

GLXSCALEMODELS.COM

GLX SCALE MODELS - OTTAWA, ONTARIO, CANADA - 613-294-2276



**3D
PRINTED
MODEL**

**NO
ASSEMBLY
OR
PAINTING**



MOBILE LOADING RAMP



PORTABLE RAILCAR
UNLOADER



RAILCAR INSPECTION
TOWER

BUY & DISPLAY NOW!!!

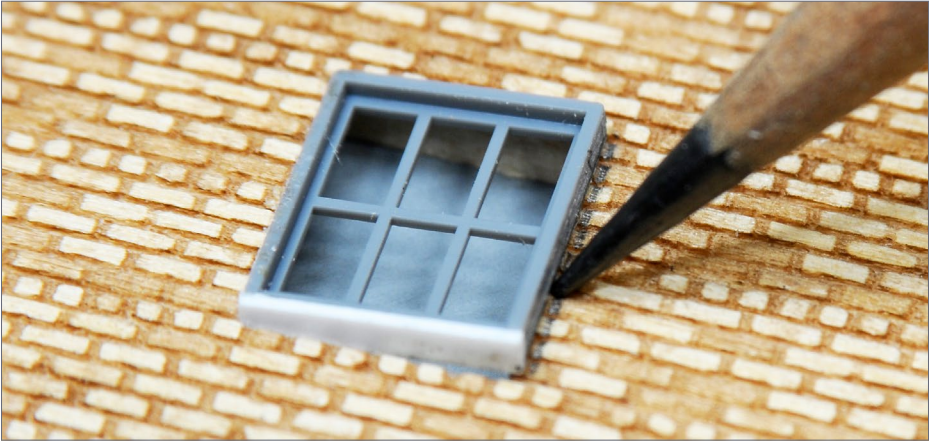

29-30. Cutting with the template will get you close to the correct size for the opening, but some fine-tuning will be needed. Sand the top and bottom of the opening until the window frame fits. Now sand one side of the window opening to remove irregularities in your cut. Place the window in the opening and mark the brick surface along the window edge. Sand out this edge until the window drops into place, using the marked line as a stop point.

Window Openings - method 2

Trimmed windows require another method for creating openings. You need to remove the trim from the window. This can impart slight variations in the size of the window. These variations make each opening unique to its window.



31-32. The 1900 building uses two styles of frame windows. On the top are the Tichy 8029 windows. Turn the window face down and slice away the side trim, then slice away the top. Now flip the casting face up and remove the trim under the sill. On the bottom are Micro Engineering 80-060 windows. Again working from the front, remove the trim under the sill. These castings are not quite symmetrical, so working from the rear, bond a .020" x .040" filler along the top and a .010" x .040" strip is along the left side. The top and side trim is then removed.

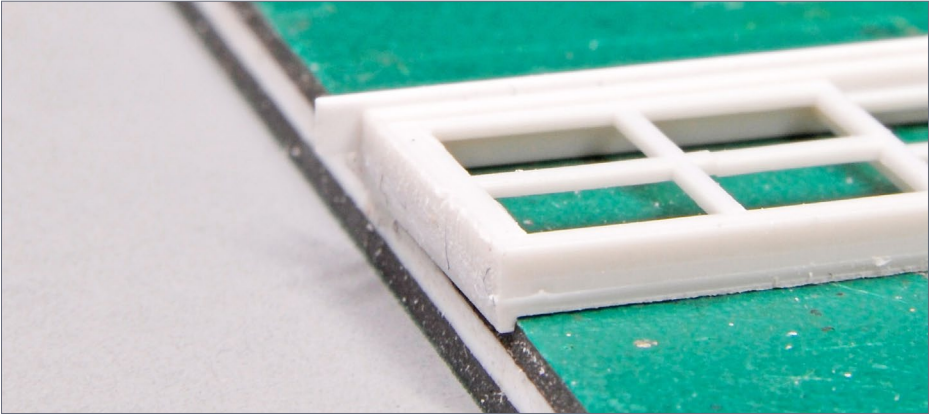

33. Tip 4: When trimming the frame place the sill of the casting over the edge of your cutting pad. This will keep the face of the frame flush against the mat.

Want to keep MRH free?

CLICK on ads.

If ads in MRH don't get clicks, then advertisers won't advertise with us, it's that simple ...

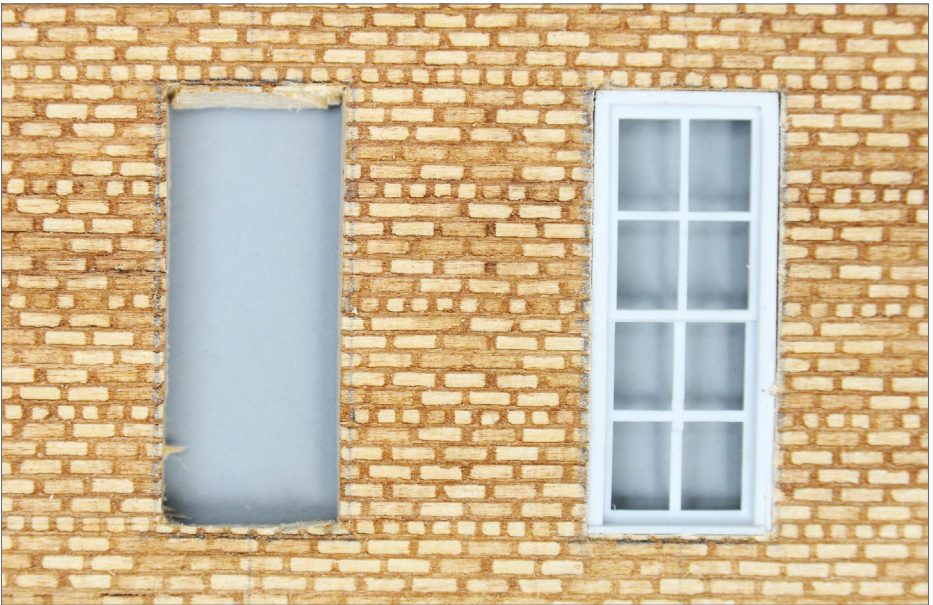

34-35. Place the casting in position and make a pencil outline. Using the notching technique, remove the waste wood. Note that the cuts were not made on the pencil line; the opening should be enlarged by sanding until the window fits.

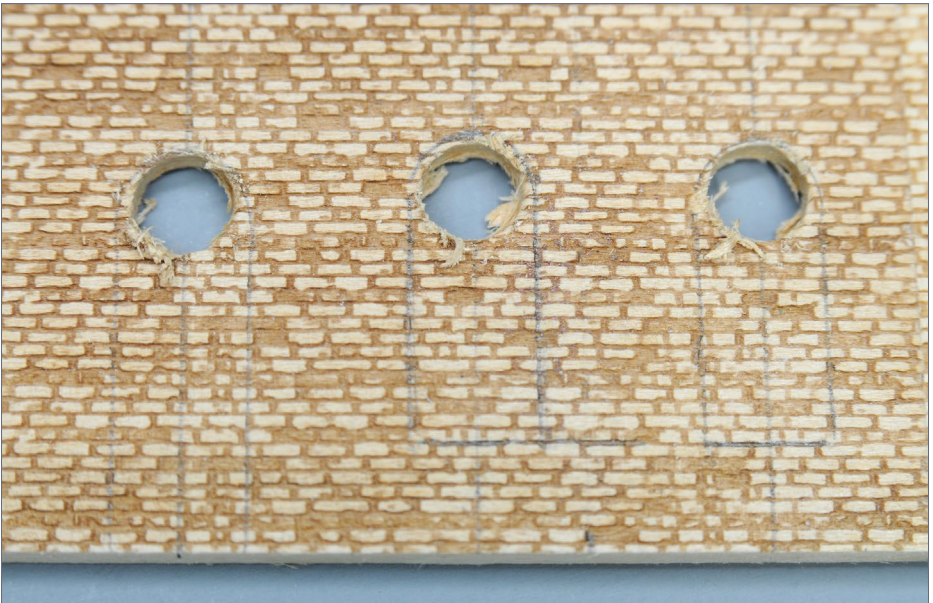
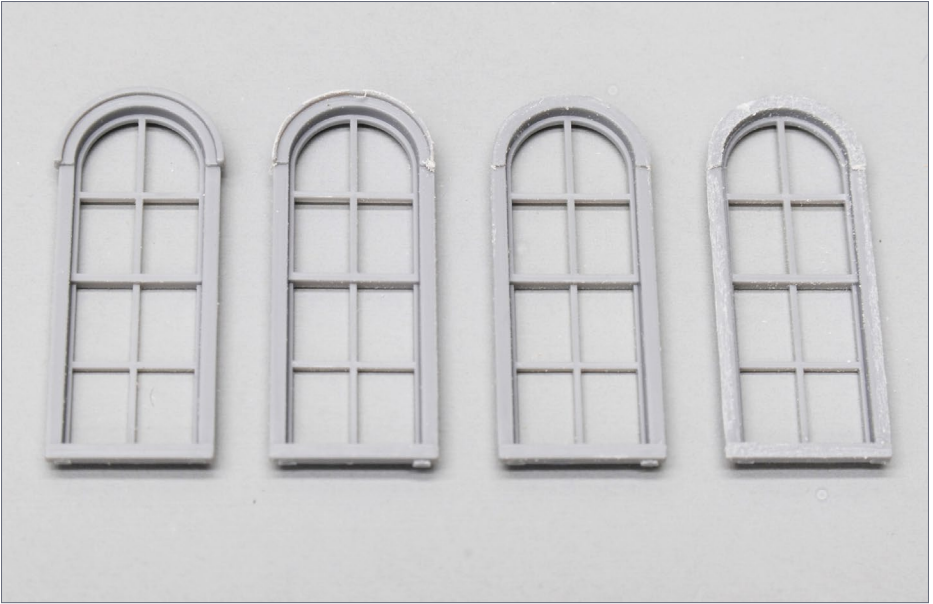

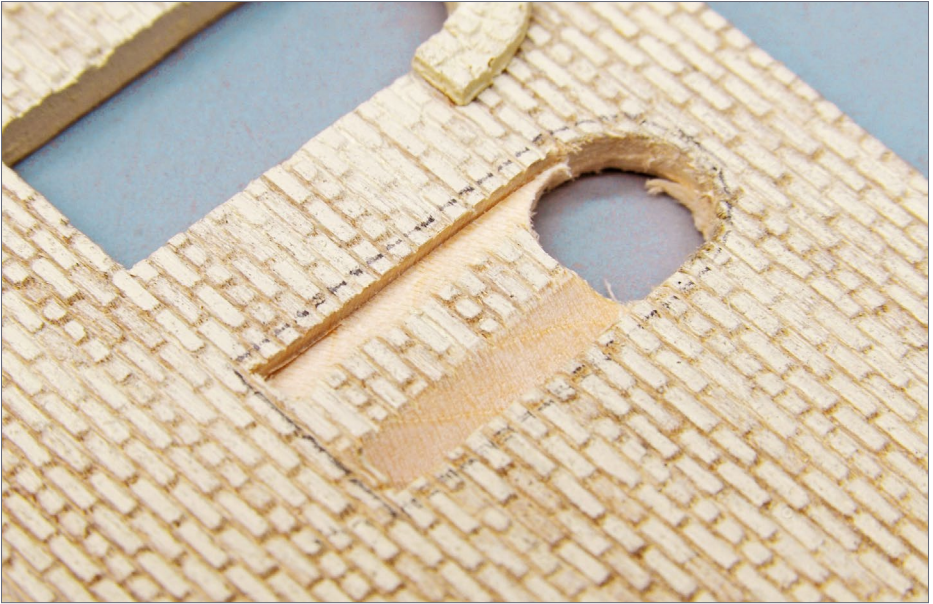

36-38. Upper-left, the 1880 building uses Tichy 8202 and 8205 castings. To use these castings in a brick wall, the small curved trim around the top of the casting needs to be removed. Carefully sand the top until its width matches width of the side of the casting; a small remnant of the trim will remain. Slice the remnant off and texture the casting face with sandpaper simulating wood grain. Lower-left, outline the window and then drill a 5/16" hole in the arched section. Above, when the wall section between windows is small, you should create a notch on both sides of the window opening when removing the waste. Sand and file the opening until the window fits.



[Click here for reader comments](#)



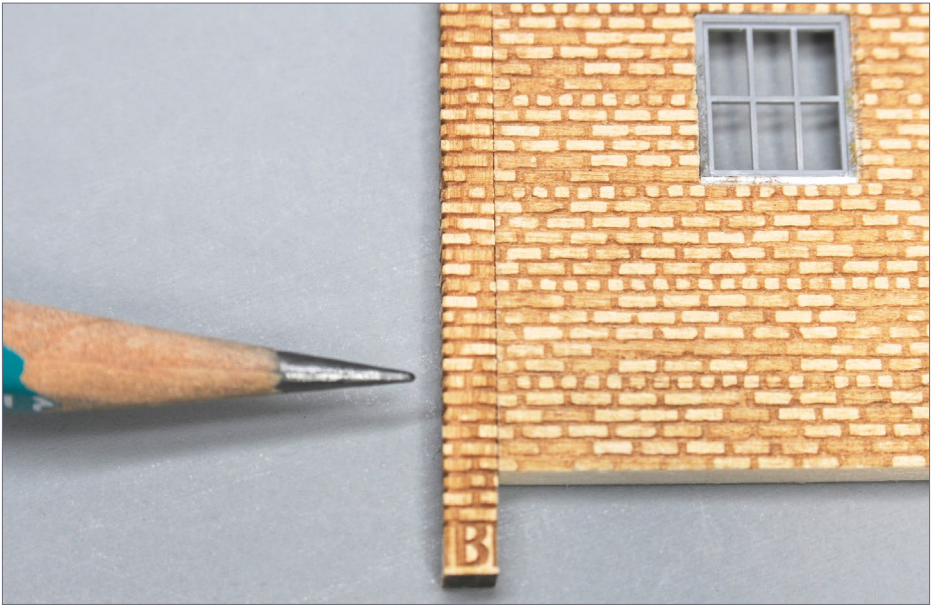

39-41. The 1880 building also required a round-top transom on the door. Remove the transom from the Grandt 5072 door and the round top from a Tichy 8202 window. Trim the round top to the horizontal mullion; add a .020" x .060" styrene strip to form a sill. Curve a styrene strip and apply it around the new transom. Bond the transom to the door and add a styrene strip along the side of the door to match the width of the transom frame.

42. The etched corner post, AB5COR-HO has a bond row etched into the surface. These bond rows must be aligned with the bond rows on the wall. Make sure that the edge of the wall is sanded perpendicular to the wall face.

Corners

The fitting of corners is critical to the final appearance of a brick model. MMW has created an etched corner post that facilitates the process, but you must work carefully to get superior results. It is much easier than attempting to create a long 45-degree bevel joint.

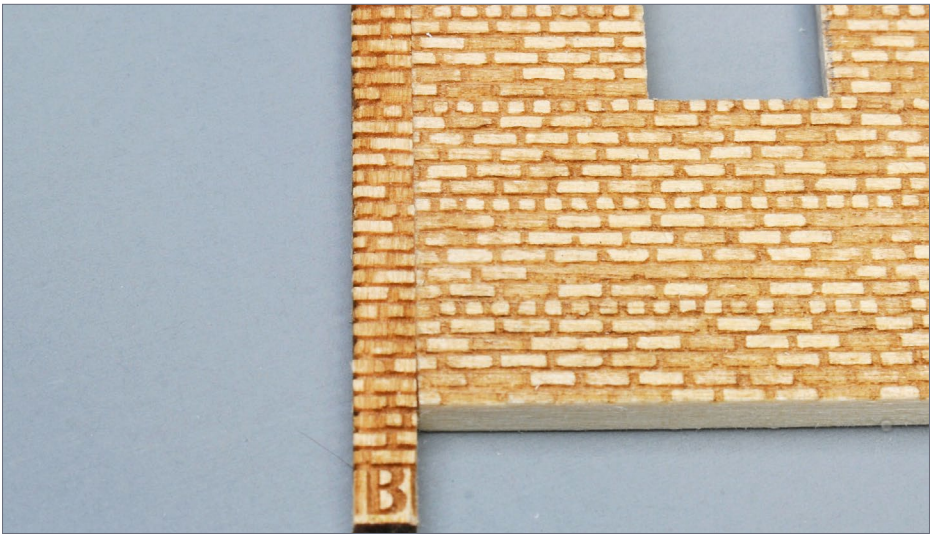
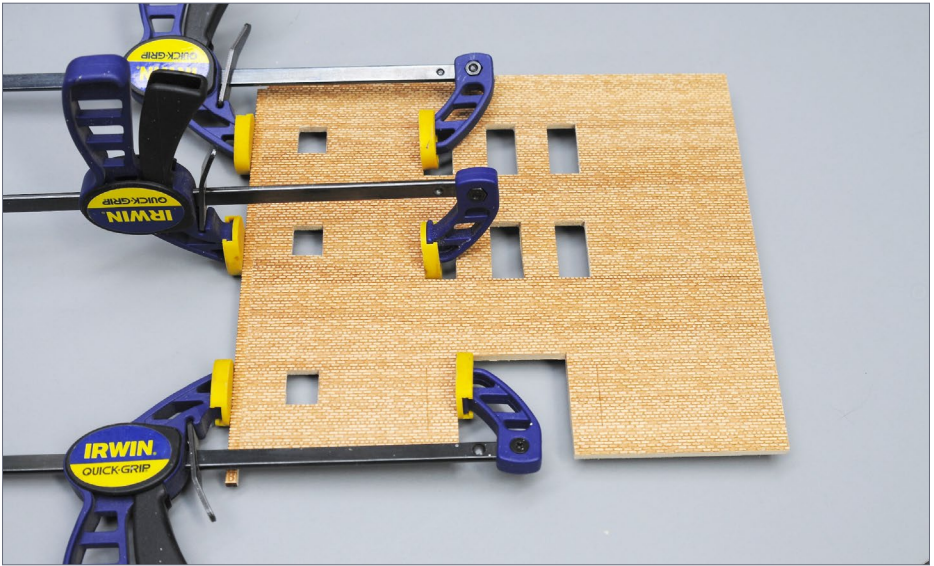

43-44. Apply white glue to the edge of the wall. Align the bond rows, as well as the faces of the wall and post. Take time to align the faces. On the finished model, misaligned rows will not be as obvious as misaligned faces. Clamp the assembly until the glue has dried. The lower photo is of the completed corner.

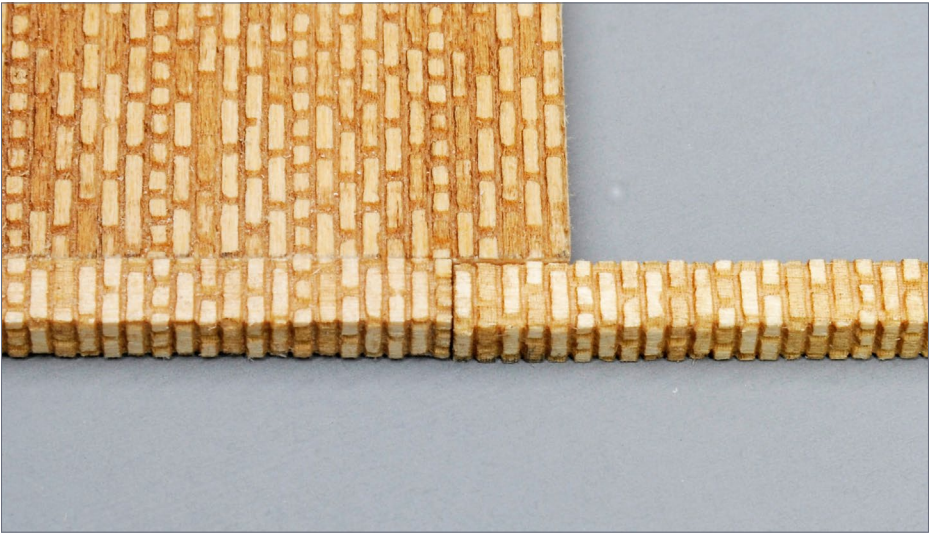
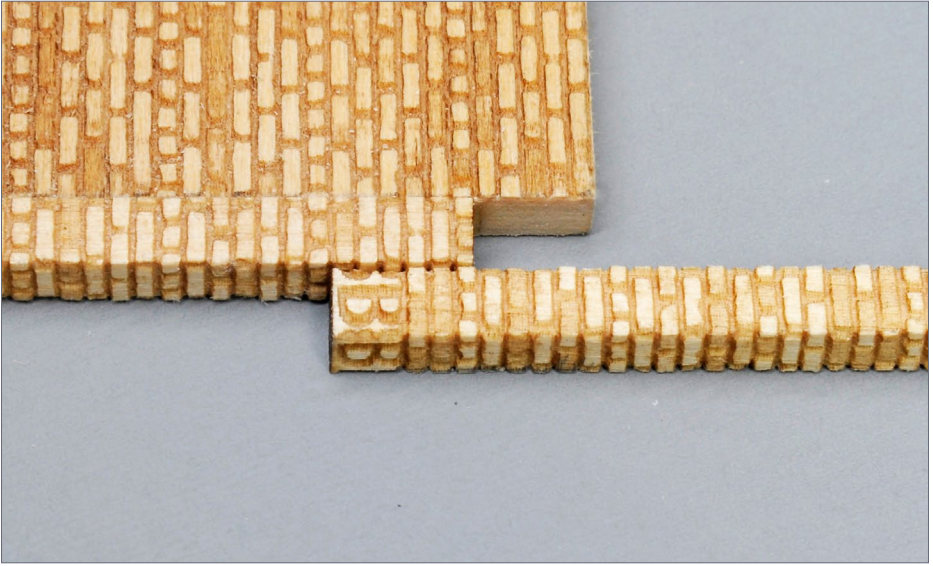

45-46. The height of your wall will determine if you need to extend the corner post; in this case a slight extension was needed. Above, the bond course is aligned to establish the cut point. Below, the post is positioned and ready to cut to length.

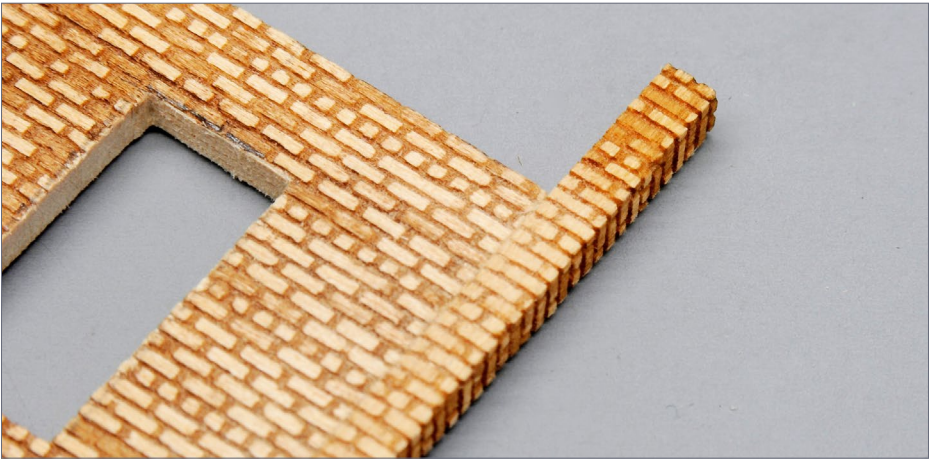

47. The corner post must be extended above the wall in the circumstance where a side is taller than an end. This is the case for the 1880 and 1900 buildings.

**Did you know
there's an
MRH index
available?**

CLICK TO FIND OUT MORE

Cornice

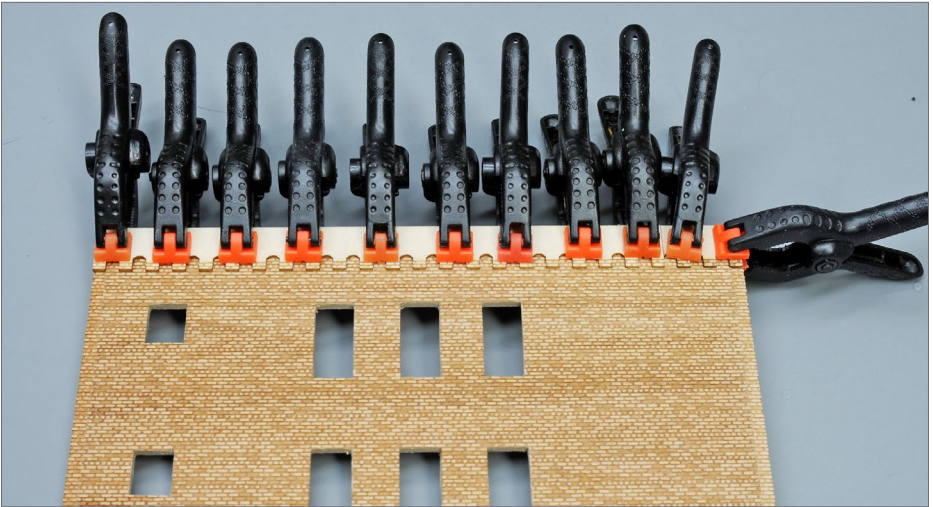
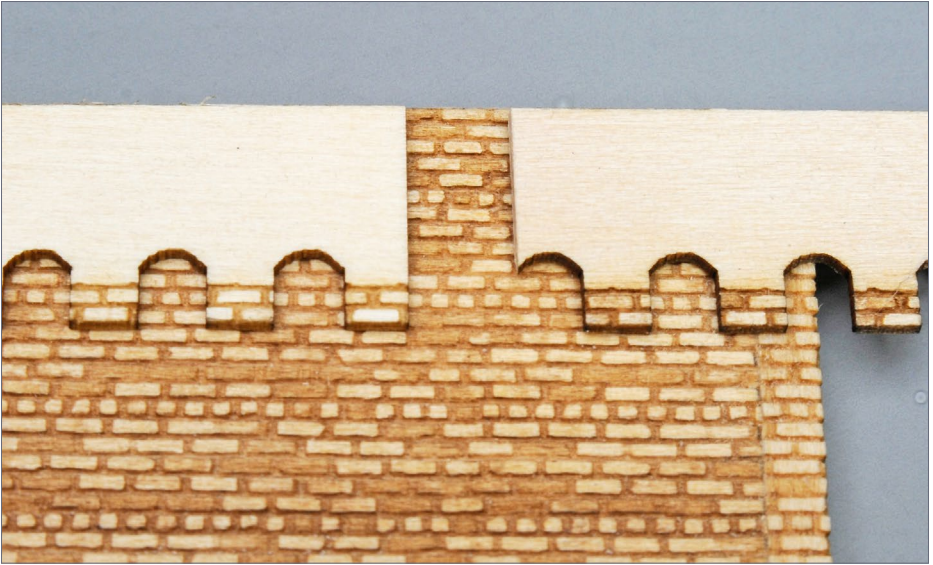

48-49. The 1890 building required extending the cornice by joining two end-to-end. Shorten one end of the cornice as shown, butt it to the full cornice section, and cut to length. Apply glue and clamp while drying.

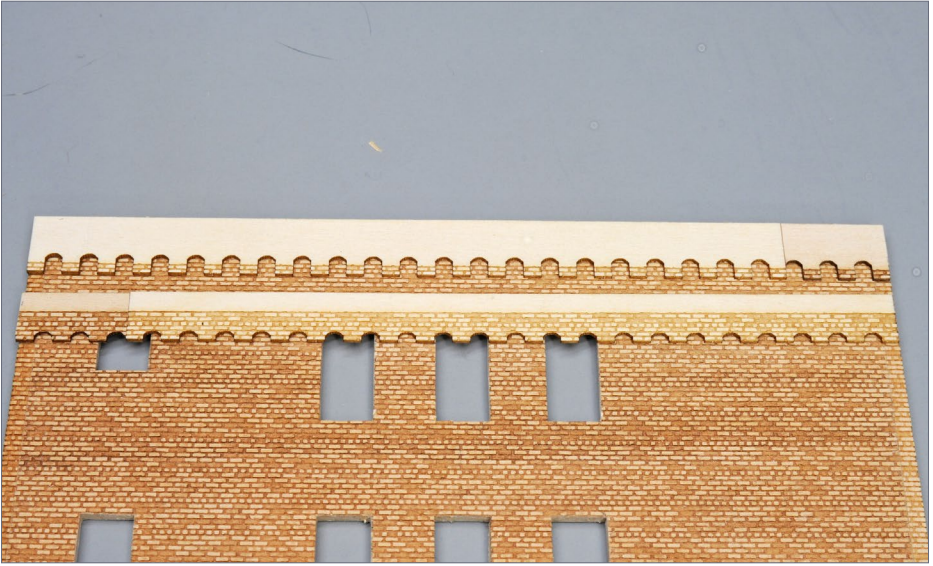

50-51. Repeat the process for the next layer of the cornice. Note that the seams between sections are placed on alternate sides of the wall, not positioned over one another. Angling of the clamps helps hold down the narrow upper most cornice strips.

Foundation - method one





52-54. I used MMW medium cut stone for the foundation on the 1890 building. Slice off a strip of the appropriate width foundation. Use a machinist's square to mark the end at a 45° angle. Using a sharp razor blade, rough-cut to the line and then finish by sanding. Then determine the length of the foundation and bevel the next end.

Tip 5: Cut the bevel first and then measure the length. If the first bevel fabrication fails, you will not waste a long strip of etched wood.



[Click here for
reader comments](#)

PART 1: SCRATCHBUILDING WITH MMW | 35



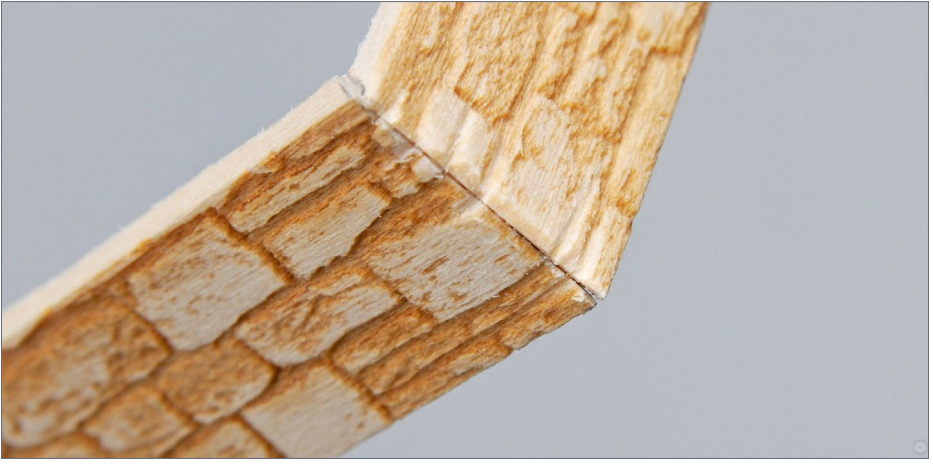

55-57. (Top and bottom left, top-right) Repeat the prior steps to create side foundation strips and glue them to the face strip. Use two squares as shown [55] to ensure proper alignment. Lastly, round over the corner and enhance the mortar joints.

58. (Bottom-right) A lesson learned: after final assembly, an issue with the accuracy of the foundation size was apparent. It was a little over $1/32''$ wider than needed. I noticed this during construction, did not consider significant, and did not correct it. Always correct an error when noticed, even if it appears minor.

Foundation - method two

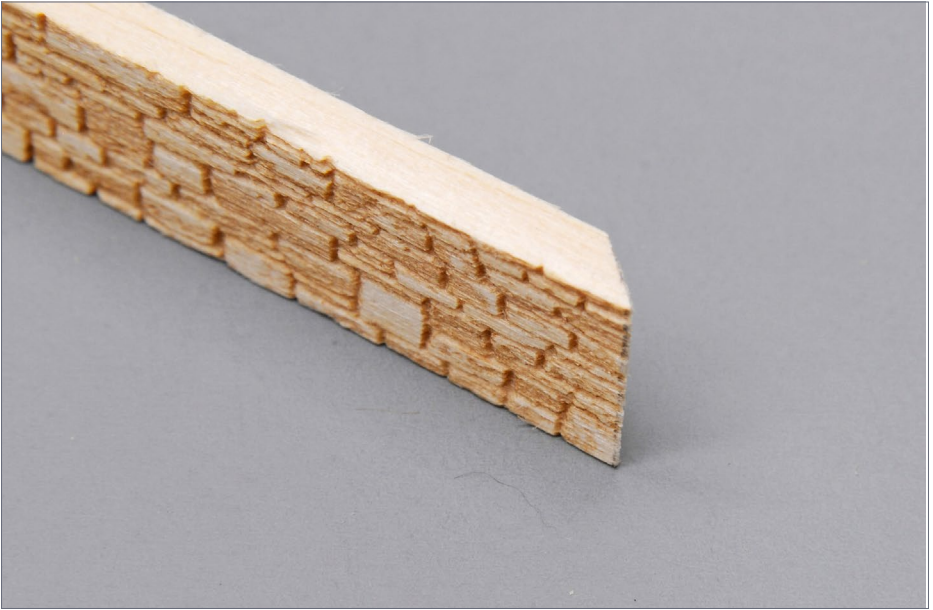

59-60. Cut and fabricate the foundation strip as in method one. Bond the foundation to the bottom of the wall section, aligning the ends of the bevel with the wall edge. After adding the side walls to the face wall, cut and fit the side foundation sections. Bond the side foundation at both the wall and the bevel joints.

Interior bracing and side walls

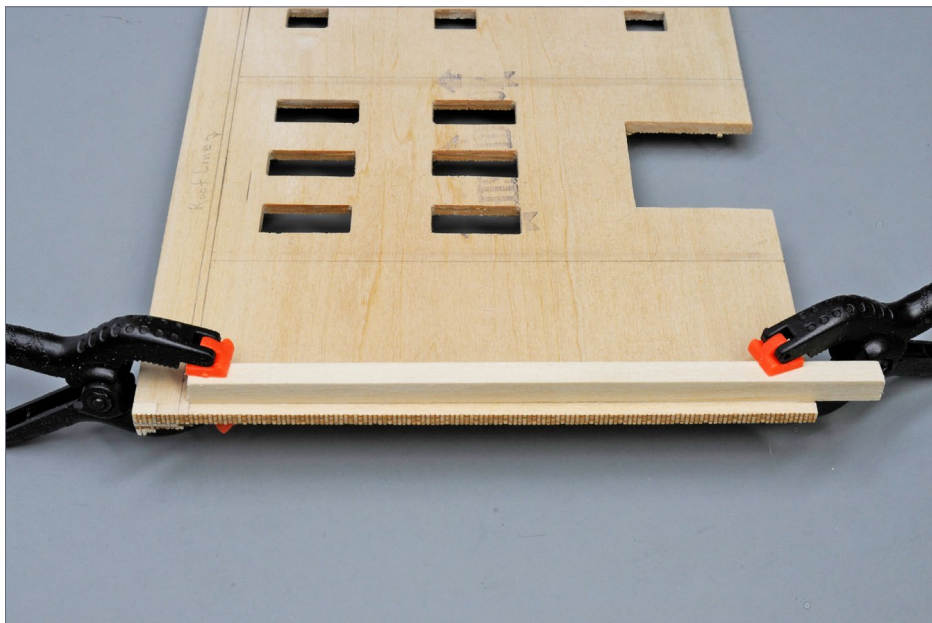

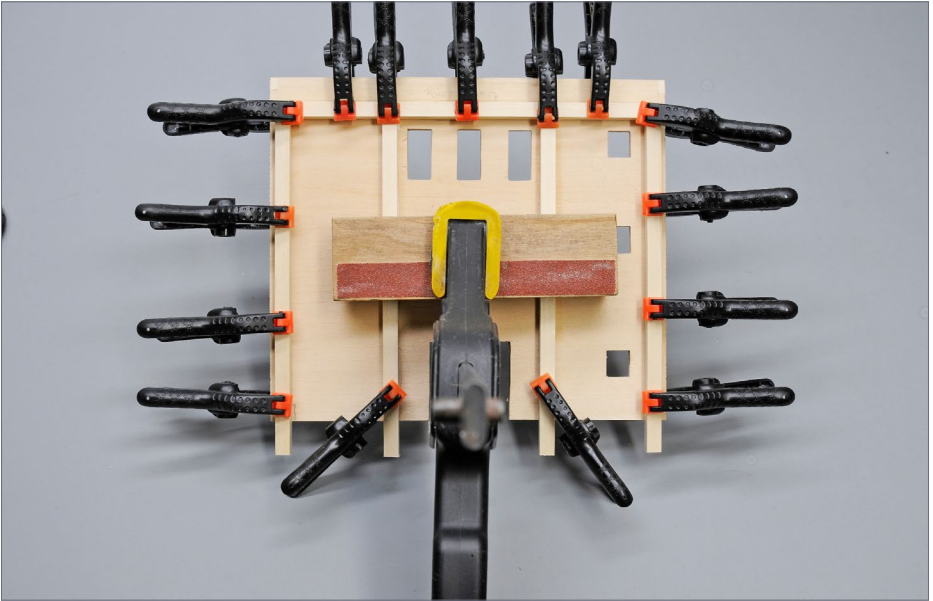

61-63. Use substantial bracing on models. Nothing is more discouraging than to see a fine model warp or fall apart. 1/4" square stripwood is used to brace these models. Bond the side braces, aligning them with the inner edge of the corner posts. To improve the fit of the sides, use a blade to scrape away any glue that squeezes out along the corner post edge. Position and glue the additional bracing. Clamp until dry.



[Click here for reader comments](#)

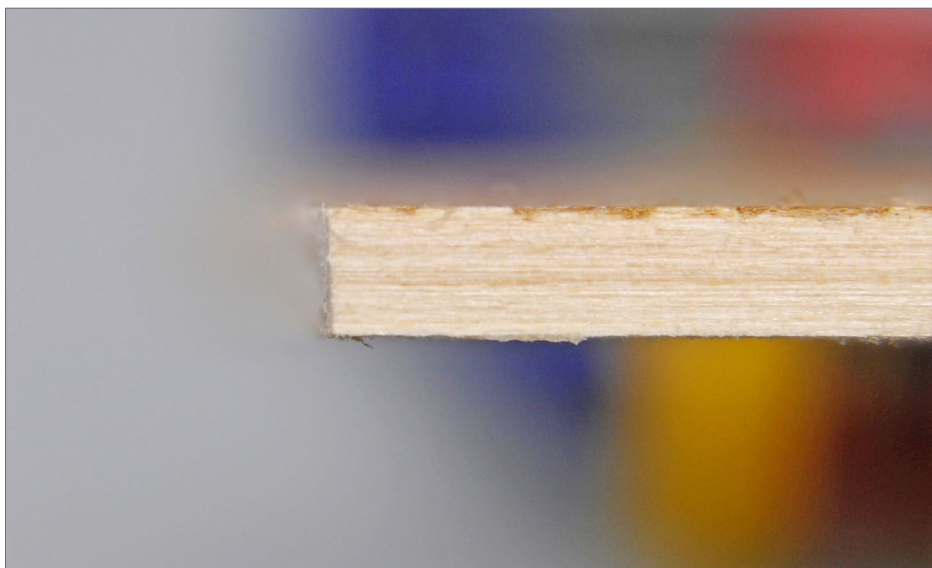

64-65. On the edge of the side that butts against the corner post, do the following: sand a slight bevel that slopes backward with respect to the brick face, then chamfer the back edge. This helps achieve a tight fit against the corner post.

PART 1: SCRATCHBUILDING WITH MMW | 41

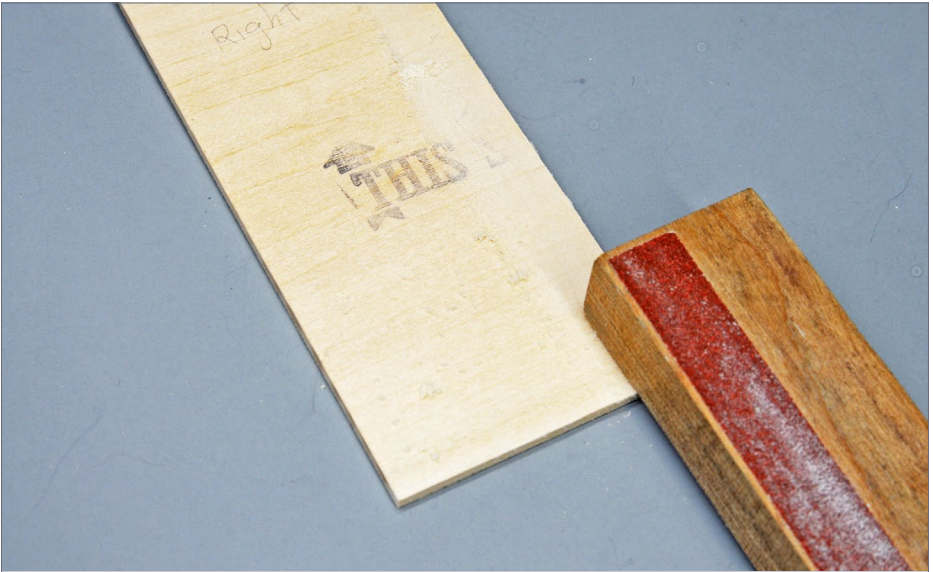

66-67. Test-fit the wall. If it protrudes beyond the corner post, sand the back until it is flush with the post, and make the chamfer if it has been removed.

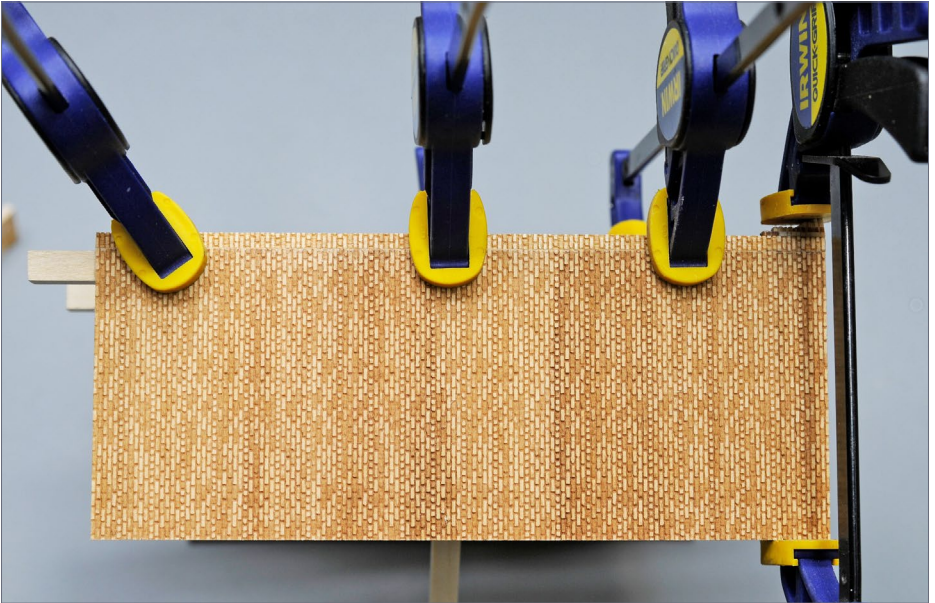
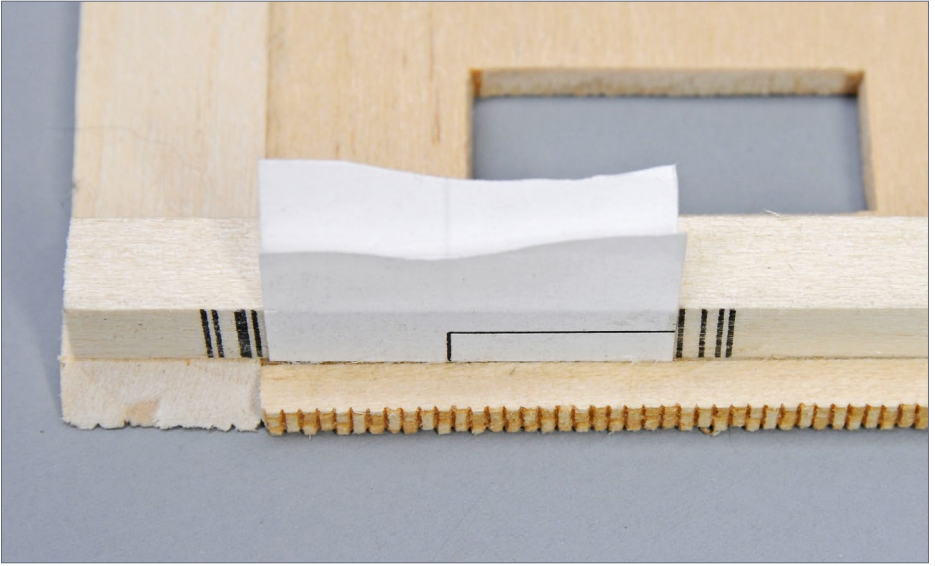

68-69. If the wall is recessed back from the post, add paper shims to bring the wall forward. Apply glue and clamp the wall in place.

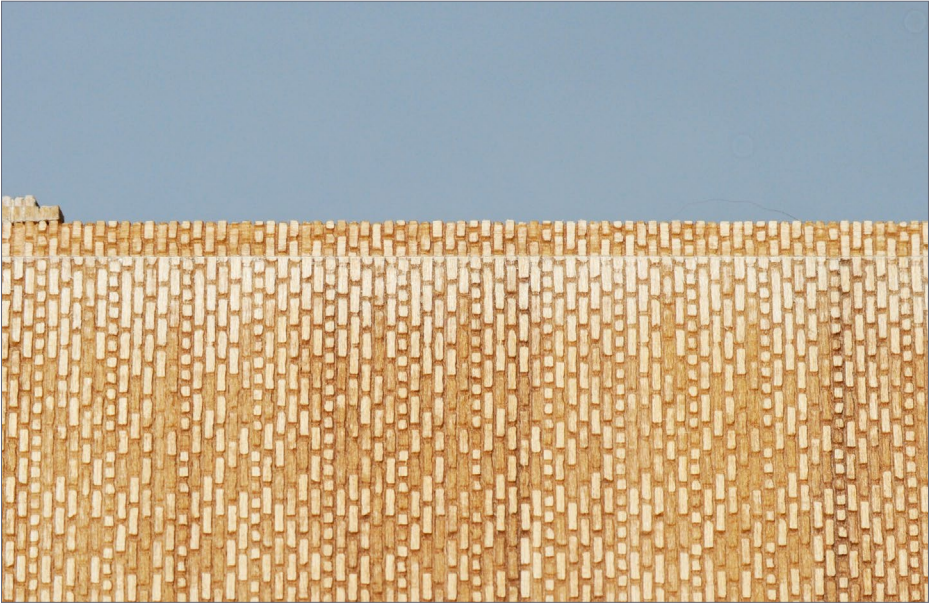

70. In the event that the edge is not flush, you can lightly sand the surface. Use the fine side of an emery board. Sanding will remove the etching on the brick surface, so only sand lightly and only if needed.

Over 40,000 have seen this MRH video - *have you?*



**Watch the
video now**



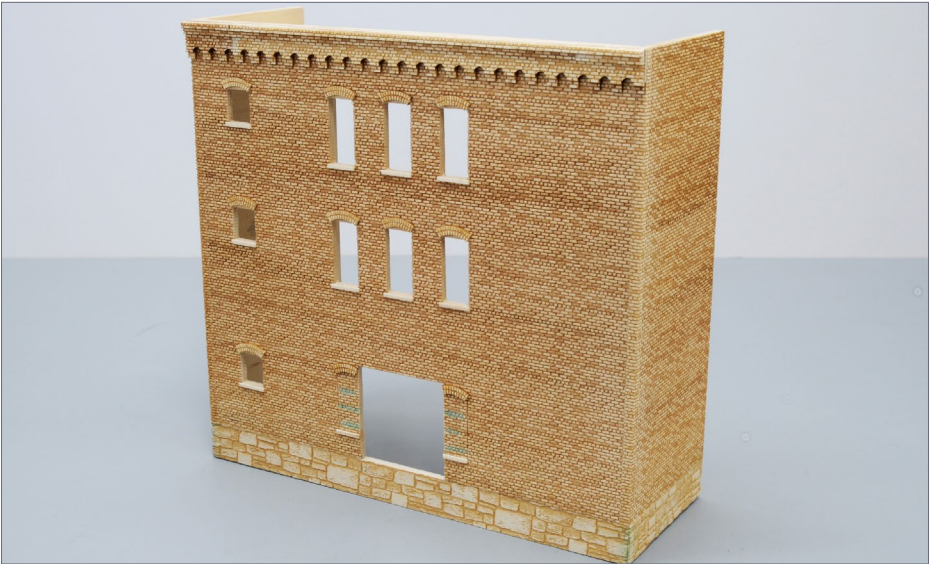
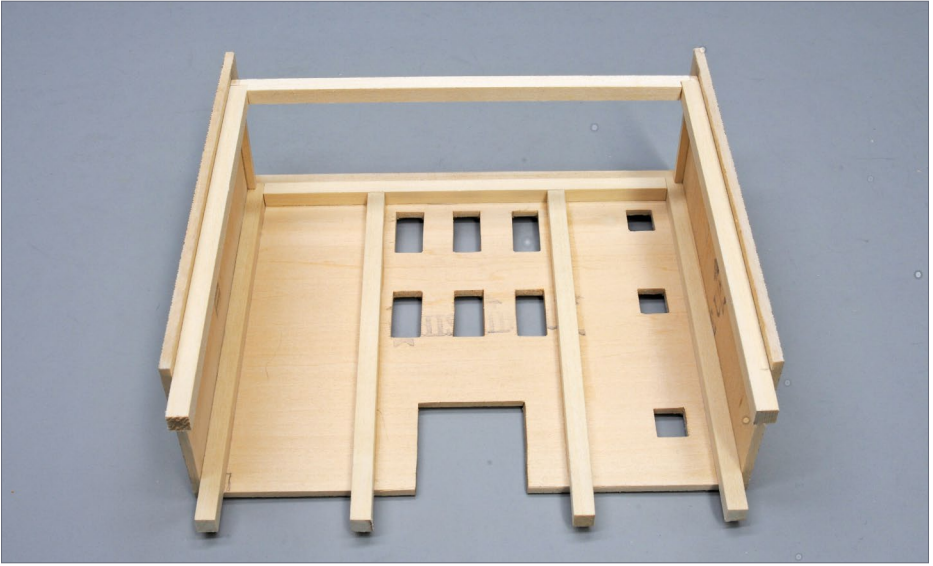

71-72. The bracing around the rear is recessed 1/8" to provide space for a black matte board back. 1/16" basswood is used as the base for the flat roof on the 1890 building. The lower photo is the finished superstructure.

Lintels, sills

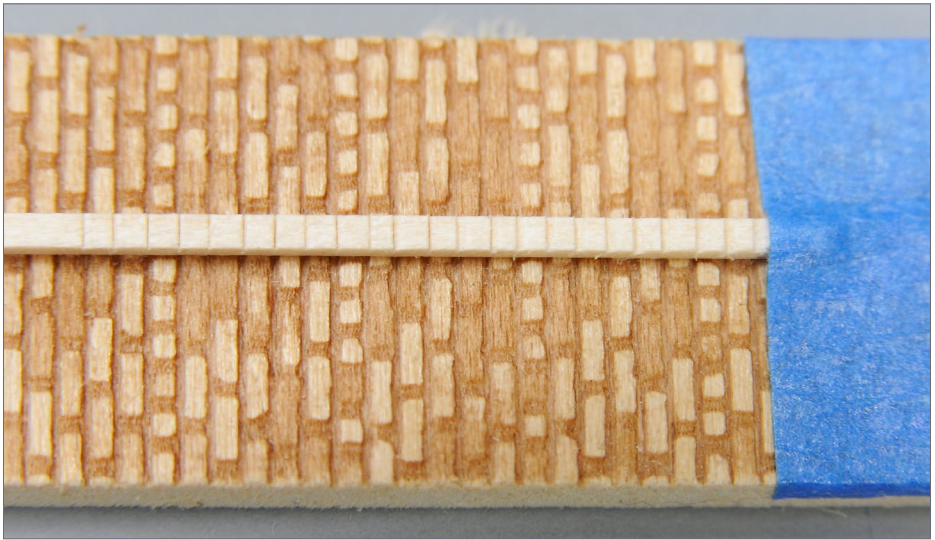

73-74. MMW does not manufacture window sills. To fabricate brick sills, tape a scale 4x4 to some brick sheet. Then use a razor to cut notches into the 4x4, corresponding to the brick sheet's mortar lines. Use an unmodified 4x4 to simulate concrete or limestone sills.



75-76. MMW manufactures two sizes of two-tier lintels – a small-radius 74LIN-HO (shown) and one with a large radius, 2TLIN-HO. Both are handled in the same manner. Place the lintel over the opening as shown, and cut the lintel at the point where it meets the corner of the opening. [76] shows the attached lintels and sills.

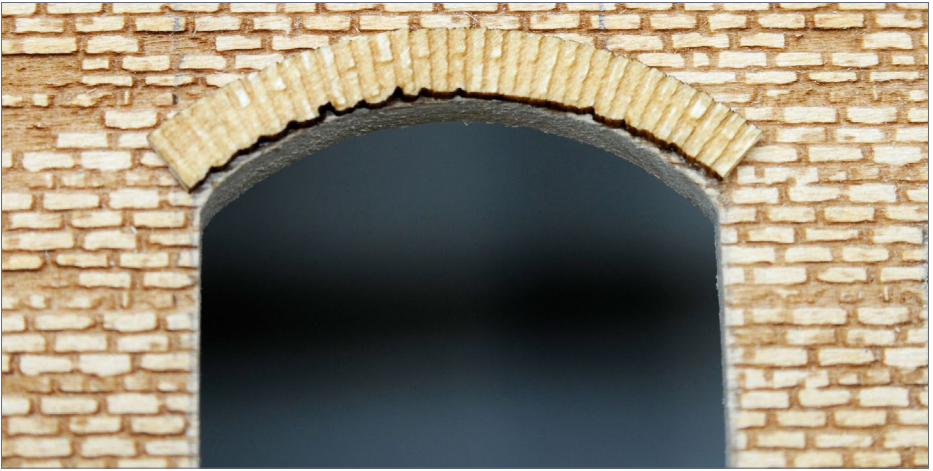
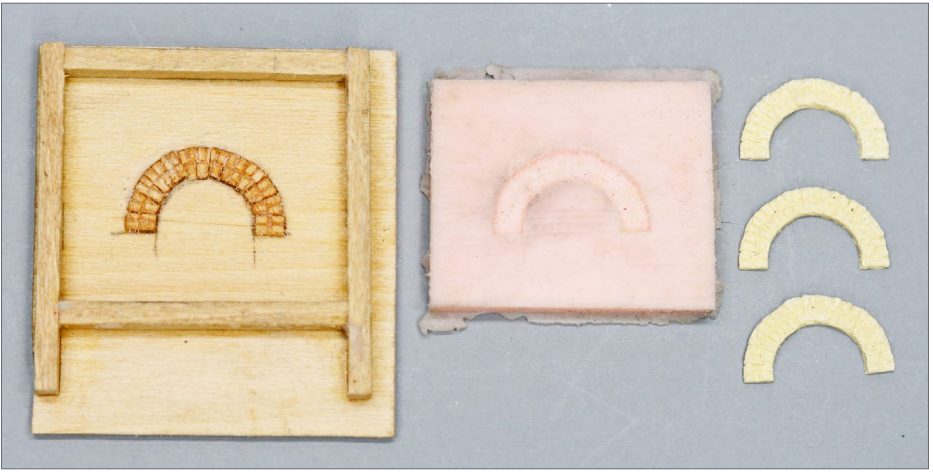

77-78. The 1880 building requires round lintels. Start with an MMW 74LIN lintel and cut it into small segments. Bond them to a backing board, following the outline of a round-top window. Form an RTV mold from this pattern and then cast lintels in Durhams Rock Hard Water Putty. The 1880 building also uses a Tichy 8022 freight door. The MMW part 2TLIN-HO is a close match to the top curve. To allow the lintel to flex, cut a few shallow notches at the mortar lines along the outer edge of the part. Care should be taken, as this action can cause the lintel to split.



79. The cast lintels are applied above the window and personnel door openings. A small portion of the re-curved freight door lintel can be seen on the left.



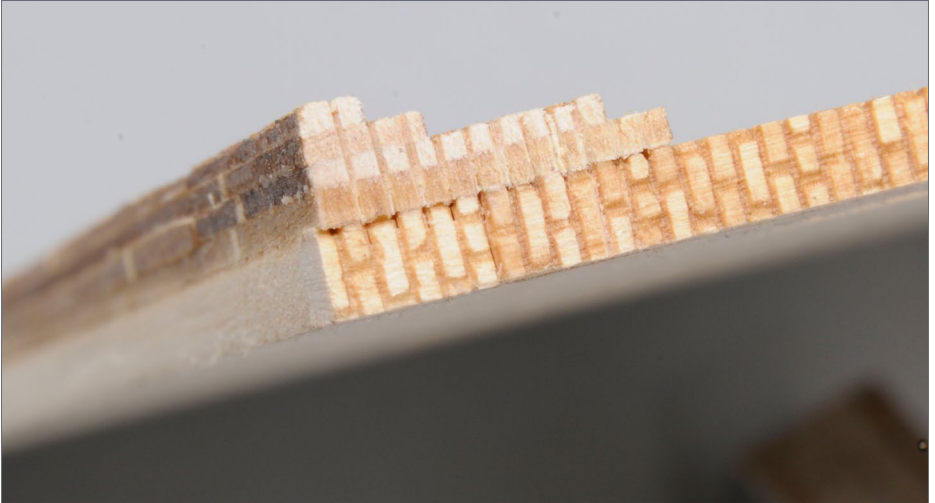

80-82. (Bottom-left, top-right, bottom-right) Use a hobby knife to cut mortar lines into the sides of the windows, doors and the tops of the sills. Also add mortar notches on the edges of the cornice.

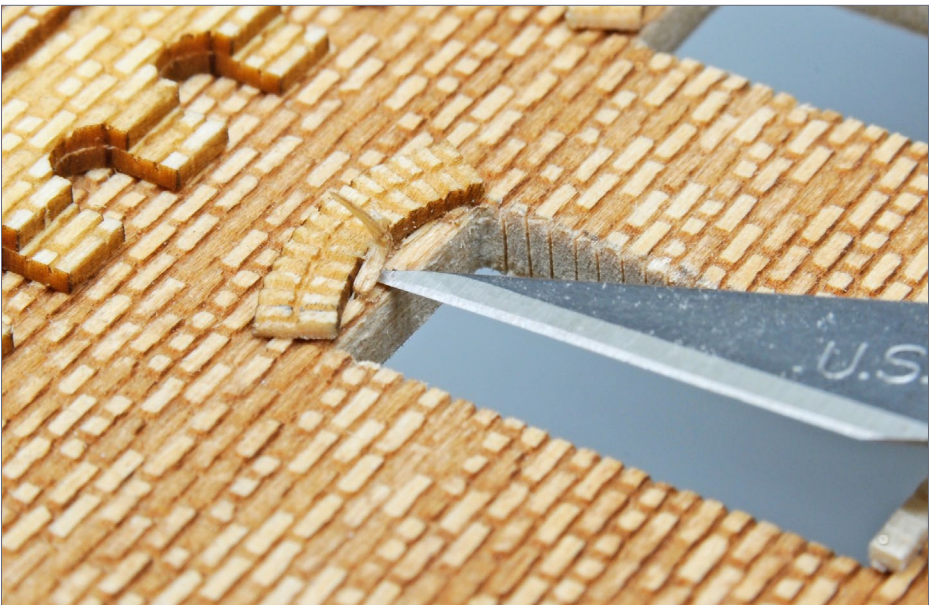
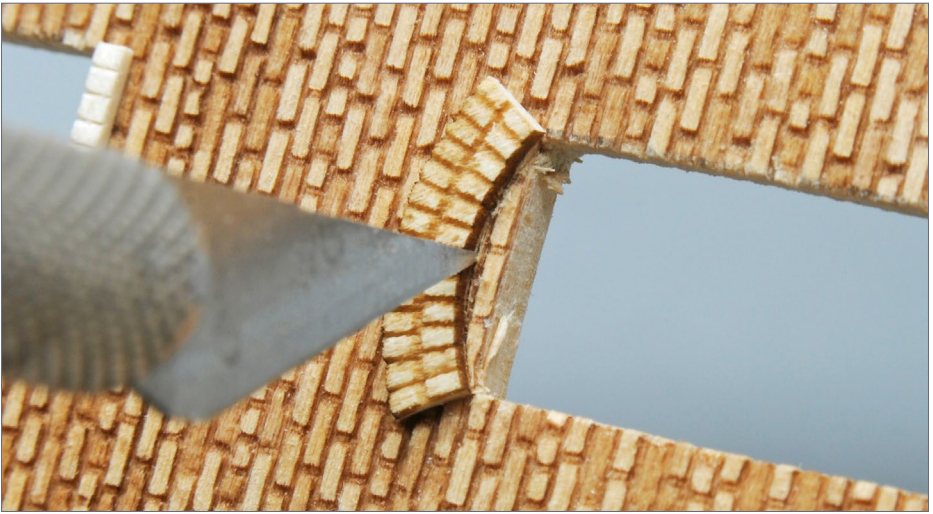

83-84. The area under the lintel arch can be modified to represent either metal or wood. Cut into the brick siding following the lintel arch; this is a shallow cut. Now use your knife to slice off the brick. Sand the surface smooth using the curved end of an emery board.

PART 1: SCRATCHBUILDING WITH MMW | 51

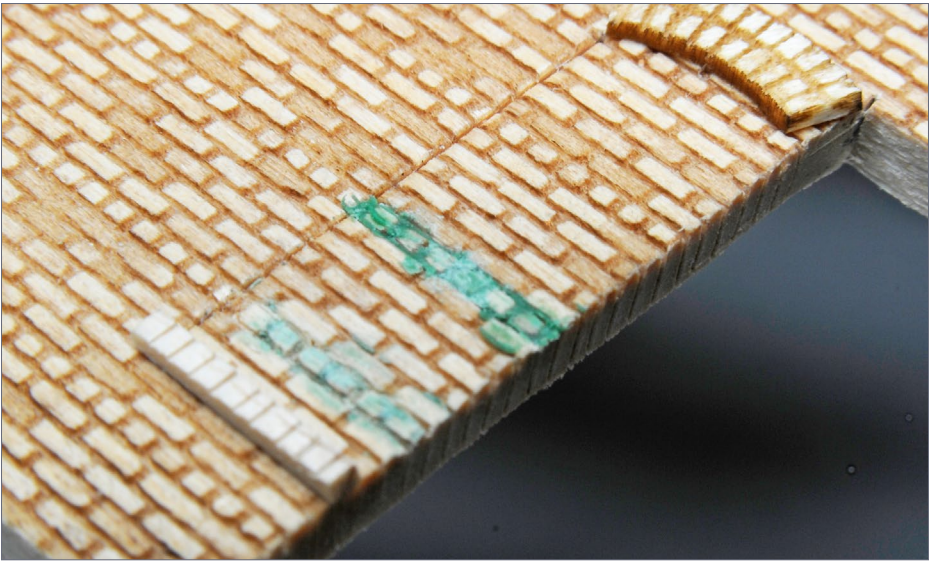

85-86. Emphasize the ghost window side by scoring with a hobby knife. Add putty to alternate mortar seams in the bond rows to disguise them from the bond rows in the wall. [85] shows a finished row bottom and roughed-in putty above. The idea is to make this look like a patched in window, not a continuation of the wall.

Painting

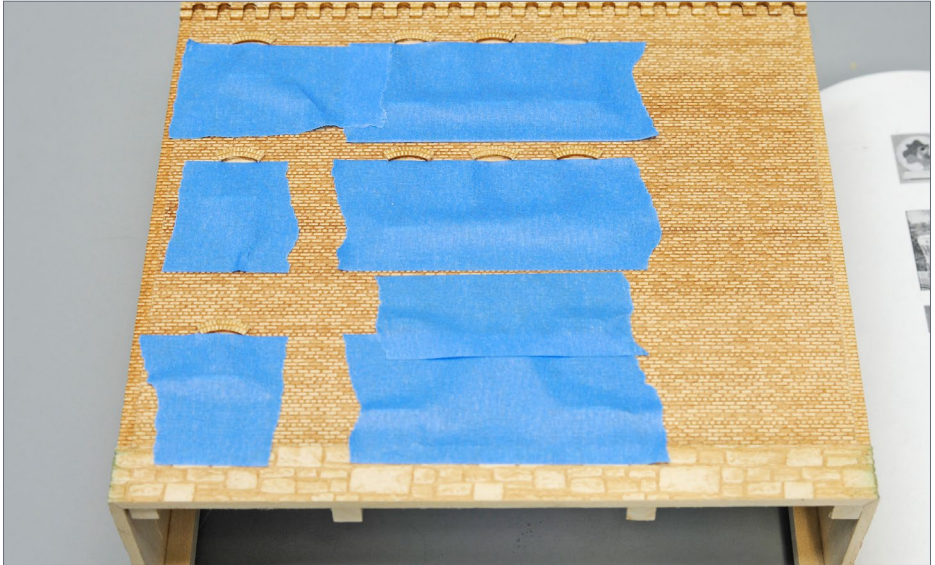

87-88. Paint the interior of the structures black. To prevent overspray of black onto the exterior I sealed over the window openings with tape and then wrapped the entire exterior in paper.

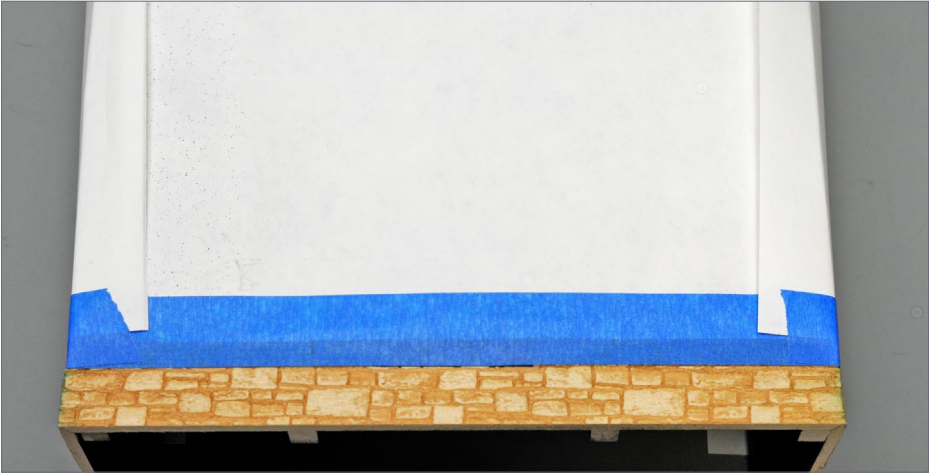

89-90. Mask the exterior so that the foundation can be painted. The color Almond, manufactured by Rust-Oleum, is a good base color for limestone. If you prefer a more gray tone, use their Fossil color. When painting the MMW etched material, avoid applying too much paint onto the surface. The final colors can be augmented using powdered pigments or watercolors. Next mask off the foundation and the interior of the windows, then paint the brick. Rust-Oleum Cinnamon is an excellent base color. If a redder tone of brick is desired, lightly over-coat the Cinnamon with Paprika color. I did this on the 1900 building.

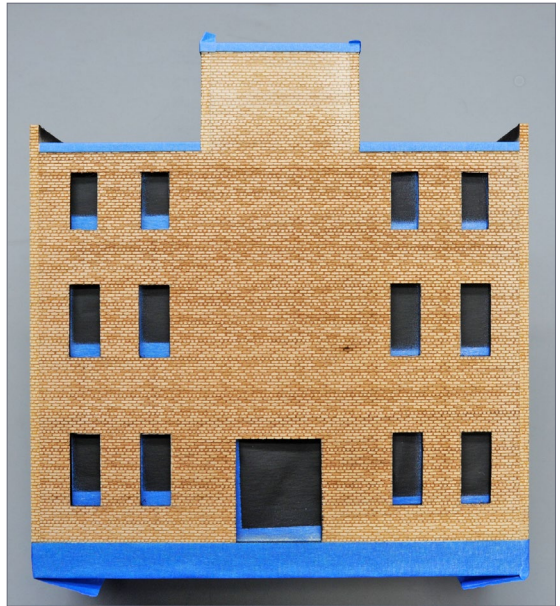

PART 1: SCRATCHBUILDING WITH MMW | 54

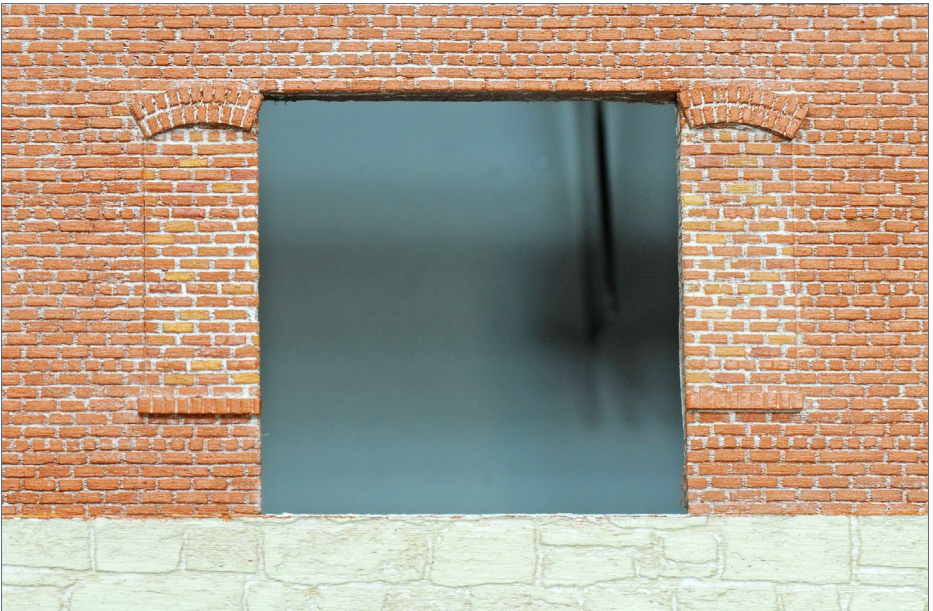

PART 1: SCRATCHBUILDING WITH MMW | 55

91-92. Mortar can make or break your model. To create mortar, I used Liquitex Modeling Paste, which contains marble dust. It is the only modeling paste that I have found that contains marble dust.

Mix up a small amount of paste in water, brush it over the wall surface, and then let it dry. Like magic, the mortar will appear in the grooves between bricks, while the brick surface is unaffected. You can repeat the application to darken the mortar lines. Start with a dilute solution and then adjust the concentration as needed. In [92] I applied a more concentrated solution of mortar to the ghost windows to replicate recent patches. To enhance the character of the patch, vary the color of the bricks in the ghost window opening before doing any mortar work.

Use powdered pigments to add variation to the brick color. DEBenLLC has an extensive range of reds applicable to brick coloring. I applied the pigments in a random manner using a makeup sponge pad. Fix the pigment with an over-spray of Testors Dullcote.

115,000 have seen this MRH video - *have you?*

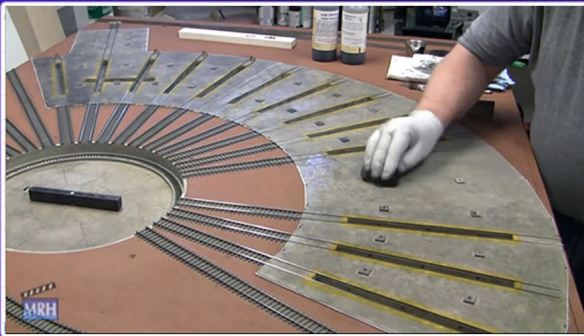

Watch the
video now



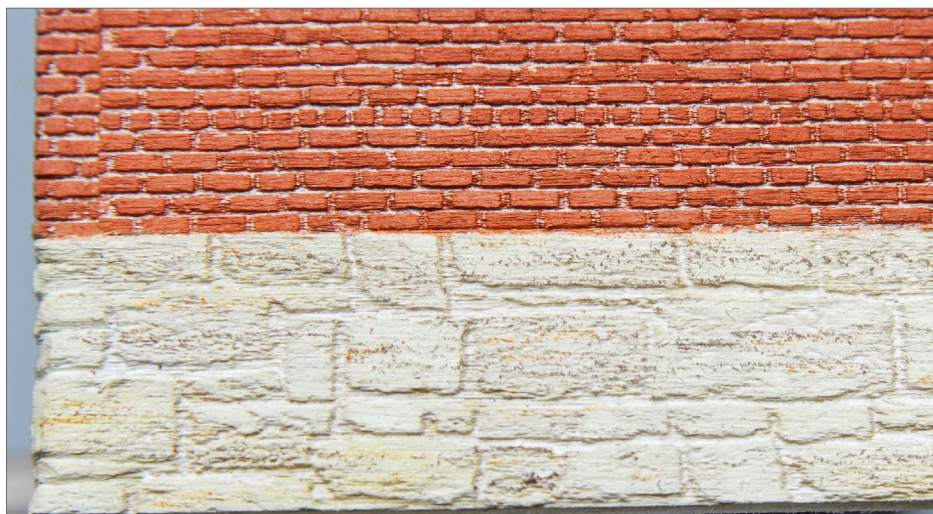

93-94. Lyra Rembrandt watercolor pencils can be used to add color highlights to the foundation stone [93]. I used both the point and side of the pencils lightly rubbed on the surface of the foundation [94]. A brush barely moistened with water blends the colors. The colors I used are Burnt Ocher, Brown Ocher, Raw Umber, Van Dyke Brown, Dark Sepia and Cool Dark Gray.

DAVID KARKOSKI

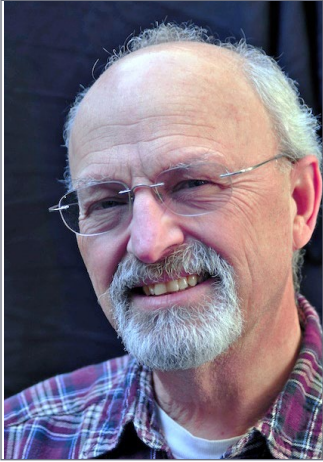

David Karkoski is retired and lives in Milwaukee, WI. His interest in model railroading stems from a color photo of Paul Larson's Mineral Point and Northern in the December 1959 *Model Railroader*. David also was inspired by articles on structure building by Jack Work and Al Armitage in the same issue.

David is currently building a DCC dead-rail sectional shelf layout that can be changed to depict various eras and railroads, in keeping with his ever-changing interests. ■



[Click here for reader comments](#)

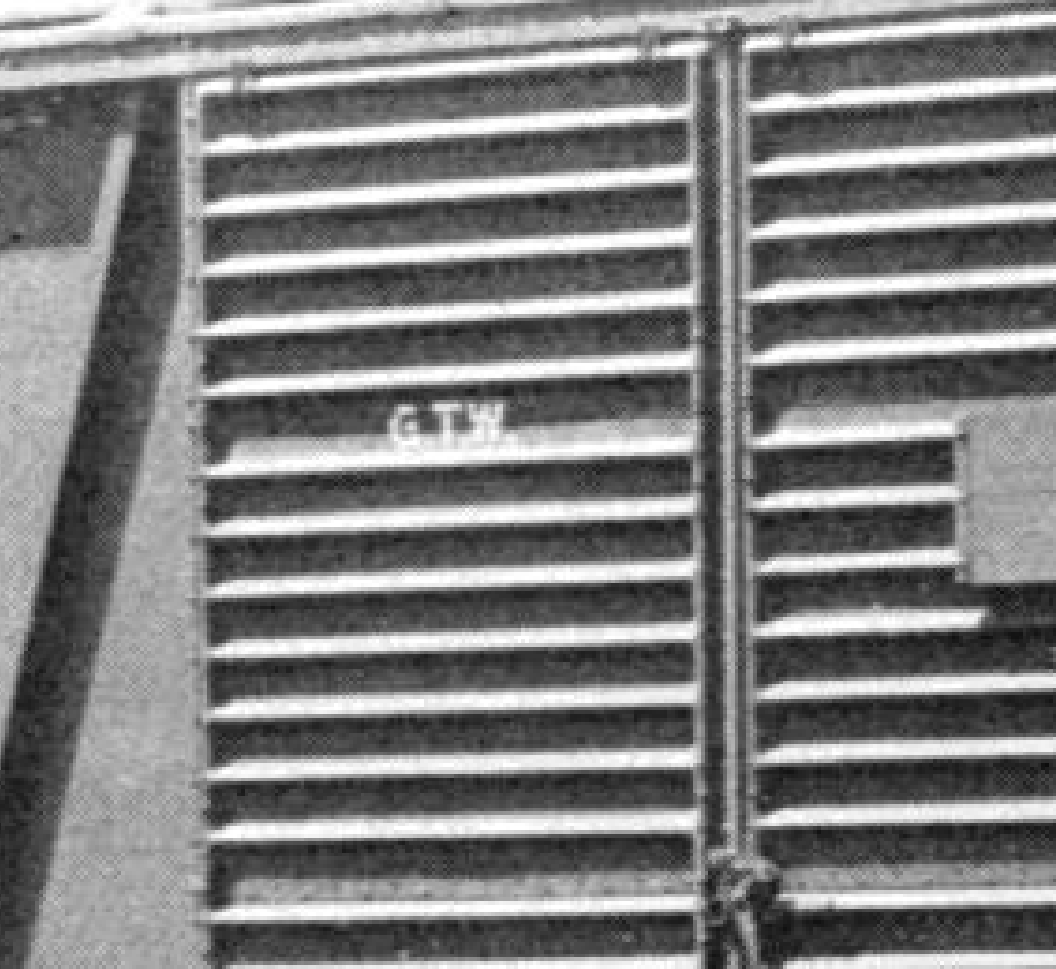

The Modeler's Guide Series continues with rolling stock doors ...

FROM THE EARLIEST DAYS OF RAILROADING, car builders assembling house cars searched for a reliable side door that would first protect the contents of the car against theft, fire, and weather; second, be easy and safe to operate, and third, economical to produce and maintain.

Some doors of the 1860s, 70s, and 80s had difficulty meeting any one of the requirements, let alone all of them. Early doors were often easy to jimmy open and goods could be pilfered

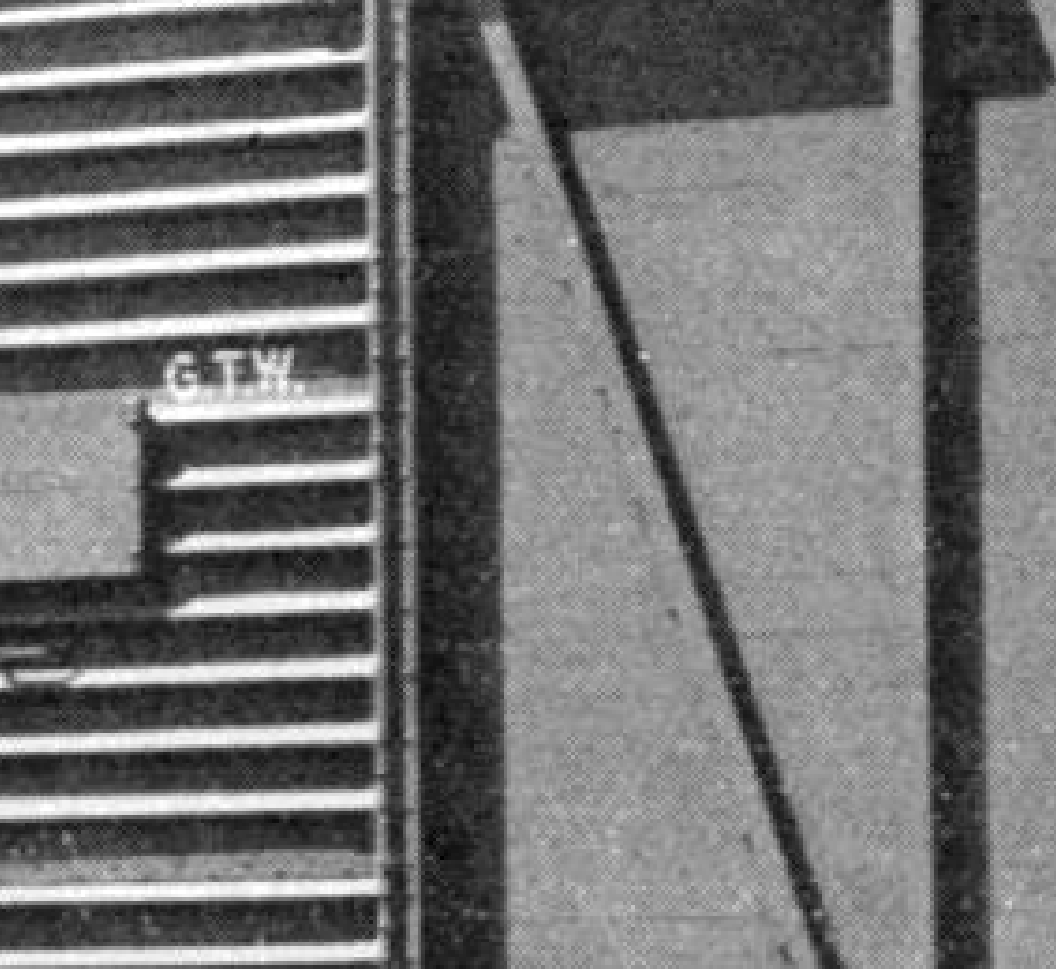

without leaving evidence that the car had been disturbed. As a car traveled over multiple railroads to its final destination it was virtually impossible to determine where the theft occurred and which carrier was to be held responsible.

Wood cars tended to shift and sway, forcing framework against the side doors, jamming them and making them difficult to open. Top-hung doors on wood cars put added weight on roofs of already questionable strength and stability. Doors were heavy and were particularly difficult to move when jammed or out of square. Stuck doors sometimes required the use of a crowbar and a sledge hammer to get them open.



[Click here for reader comments](#)

The earliest wood doors were generally made of oak stiles and rails, framed together using tenon and mortise. A metal bar was often placed across the outer face of the door tying everything together and limiting any tendency for the door to warp or bulge from shifting lading.

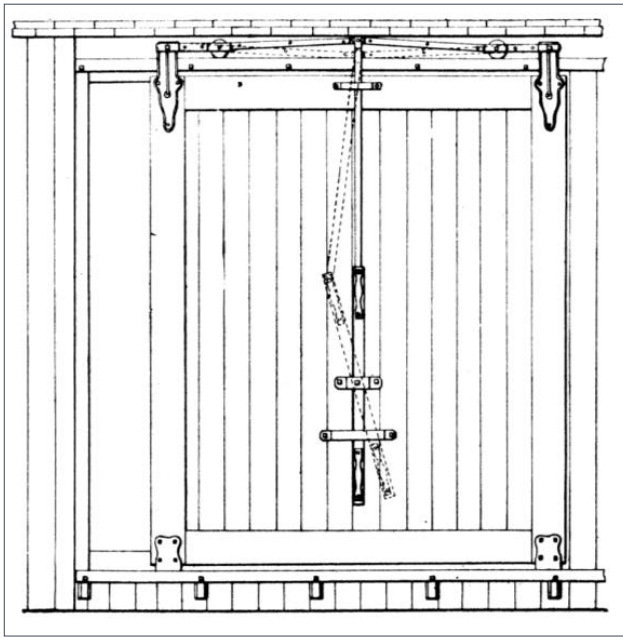

1. Moore top-hung car door.

BOXCAR AND REEFER DOORS | 4

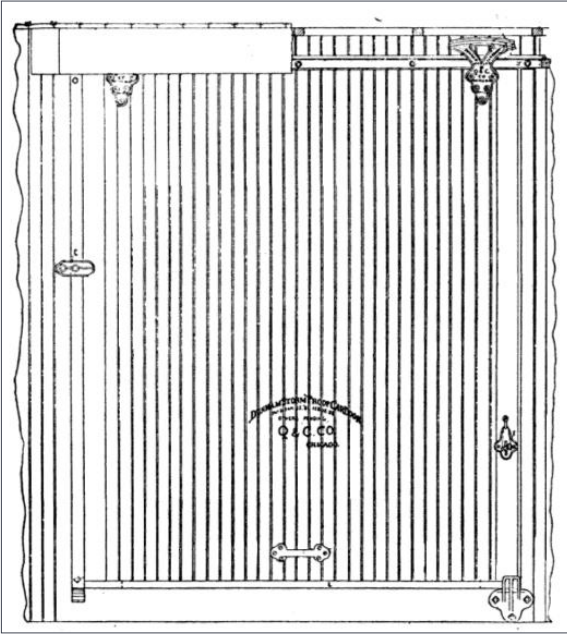

2. Durham car door.

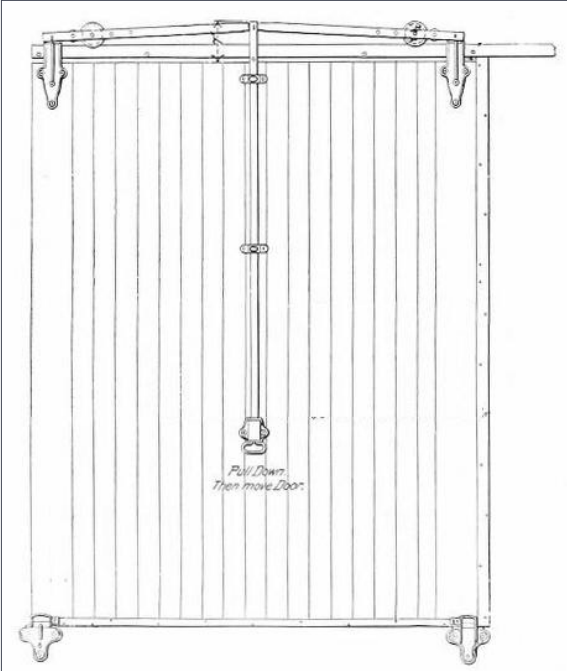

3. Jones car door.

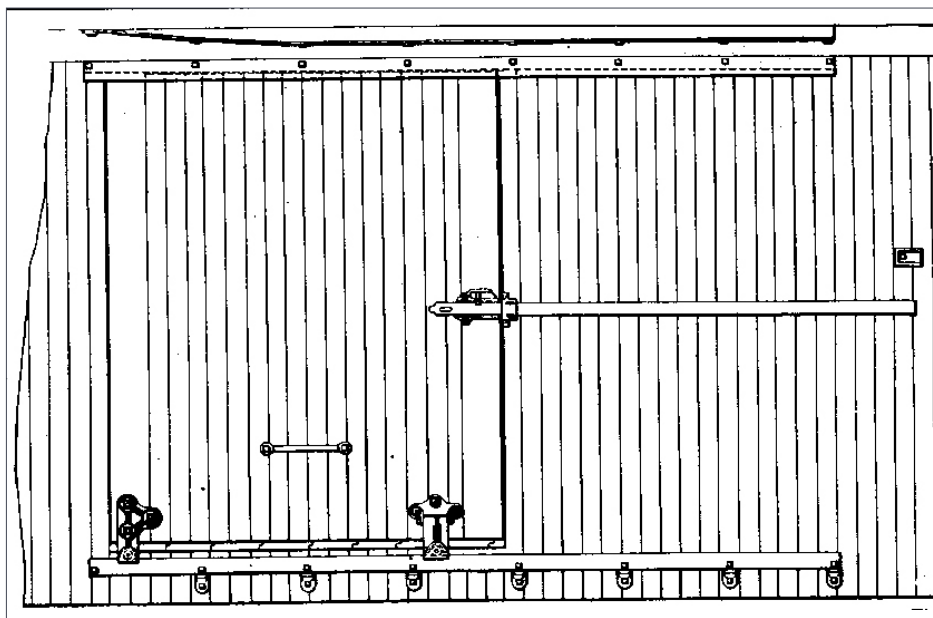

4. American Flush car door.

The Moore Company offered a top-hung door [1] in the late 1880s with a lever in the center of the door that when released, allowed the door to be opened or closed. When actuated the lever took the weight off the bottom supports so the door could be moved. With the lever in the locked vertical position, the door rested on the bottom with its weight wedging it against the side of the car.

In the early 1890s a firm named Q&C Manufacturing Company developed a top-hung sliding door called the Dunham Storm-Proof Car Door [2]. The company also sold the malleable iron fixtures separately to independent car builders that preferred to fabricate their own wood door. Around the turn of the century the Jones Car Door Company offered a top-hung door with a locking bar located in the center of the door [3]. It was similar in appearance to the Moore door. Jones also

BOXCAR AND REEFER DOORS | 6

sold several versions of a top-hung wood door including one branded the Smith car door.

Lading could fall out of a car if the door did not remain firmly in place. The American Flush Car Door Company attempted to solve that problem in the late 1890s with a bottom-supported door that, when locked, wedged into the opening – much like an early plug door [4]. The bottom rollers were spaced to insure that the door, regardless of its position, was always supported by at least three rollers. A metal strap to the right of the door opening protected the car side from being scarred by the sliding door.

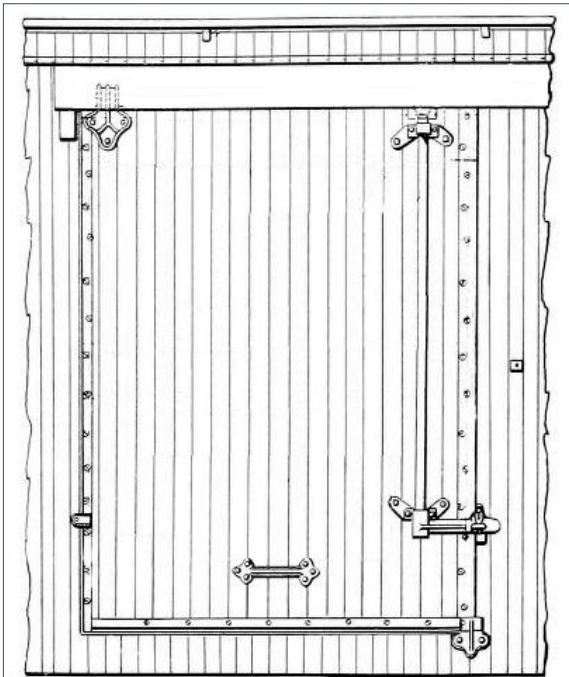

5. St Louis Flush car door.

BOXCAR AND REEFER DOORS | 7



6. Wagner left-hand car door.

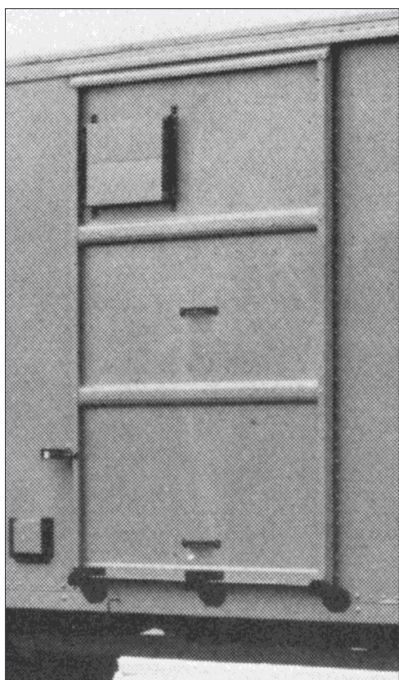

7. Creco steel car door.

Another approach to eliminate spilled lading was met in the first decade of the 20th century by Western Railway Equipment Company that promoted a top-hung door called the St. Louis Flush Car Door [5]. The front of the door slid into a vertical Z-shaped bracket while the back side of the door was locked in place with a rod mechanism. It met with some acceptance with both the Pennsylvania Railroad and the Santa Fe, two roads not easy to please. Both wood and metal-clad versions of the St. Louis door were offered.

The left-hand sliding Wagner door [6] is shown here on a 34-foot San Antonio & Arkansas Pass boxcar built by the Pullman Company in the early 1900s. Most doors of the period moved to the right but in-service photos portray the Wagner door as a left-hand slider. Note that the Miner-type rotating rod with cam locks is mounted on the back side of the sliding door.

The first all-metal door to gain general acceptance was launched in 1910 by the Chicago Railway Equipment Corporation (Creco), a major supplier of other accoutrements to car builders. Creco three-panel steel doors [7] were used on Pennsylvania Railroad's X23 boxcars built in 1912 but acceptance of Creco doors remained limited. Things changed in 1923 when the three-panel bottom-supported Creco doors was applied to many PRR X29 boxcars. Variations of the Creco door continued in use into the 1940s.

The top-hung Allen Flush Car Door was introduced during a meeting of the Master Car Builders Association in 1914. It gained limited attention and was used by only a few railroads, most notably the Southern Pacific. Because of the inadequacies of the locking fixtures on some top-hung doors it was possible to jimmy the door open with a crowbar without breaking

the seal on the locking fixture. Promotional literature for the Allen door claimed it could not be pilfered without breaking the seal. Additional features mentioned in Allen ads noted the door was flush on inside allowing for maximum loading, and flush on the outside to minimize wind resistance.

Between 1923 and 1924, the Southern Pacific acquired 6,675 single-sheathed boxcars. Most of the cars were delivered with Type 32 Camel doors, but 1,000 were fitted with the rare Allen door. In most respects the Camel-Allen door was like other wood doors of the period, except the door hardware was located on the right hand side of the door, even though the opening was on the left.

Wood continued to be a major ingredient in car building and one of the most popular boxcar doors from the late teens through the 1930s was the composite wood and metal National car door manufactured by Union Metal Products Company. The National door [8] was composed of vertical tongue and groove wood secured within a steel frame. Riveted steel gussets at the four corners of the door and a horizontal L-shaped bracket about one third of the way from the bottom are spotting features of National doors. An additional feature is a handle centered at the bottom of the door. Locking hardware varied but many had a fastener with a long hasp made by National Malleable Casting Company [9].

National made both top-hung and bottom-supported doors. In photographs, the two types cannot be identified with any certainty. The rollers at the open doorway were beveled to force the door tightly against the car when closed [10]. Other brackets with flat rollers kept the door away from the side of the car when open. Lower supporting brackets were open at the

BOXCAR AND REEFER DOORS | 10

bottom to prevent accumulation of dirt, cinders, ice, and snow. Thousands of USRA boxcars were built with National doors.



8. National wood door with Camel hardware.

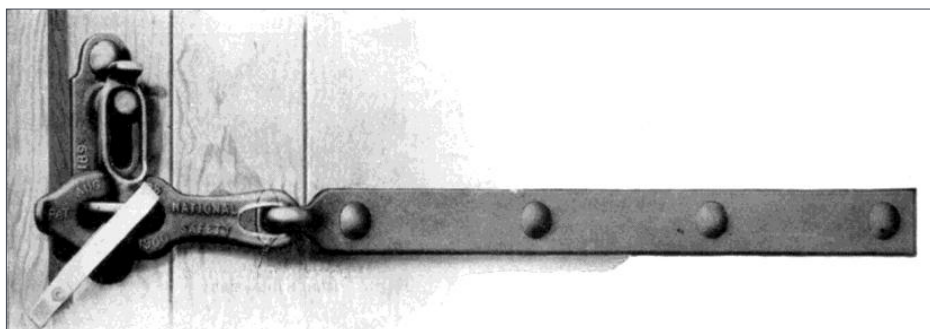

9. Long hasp door fastener made by National Malleable Casting Co.

BOXCAR AND REEFER DOORS | 11

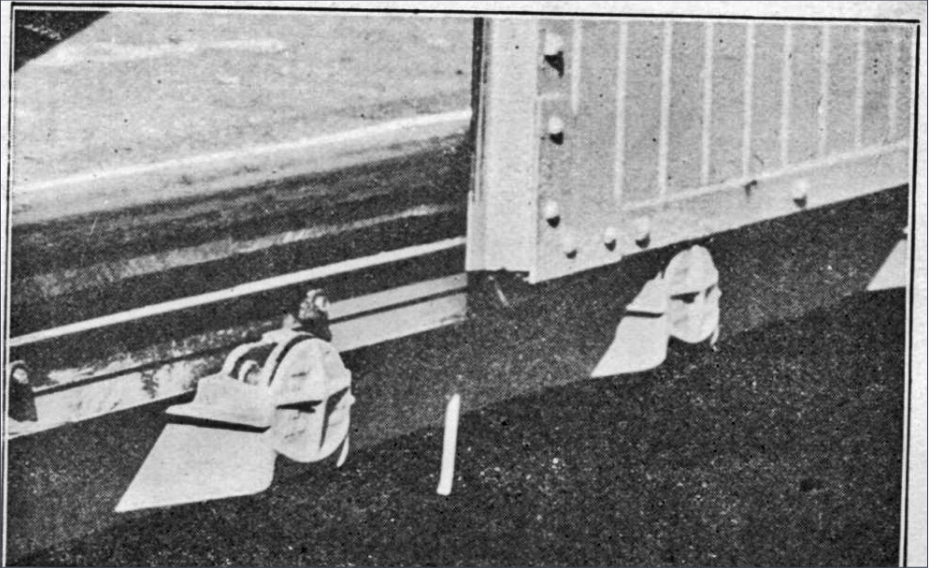

10. Bottom rollers on a National door.

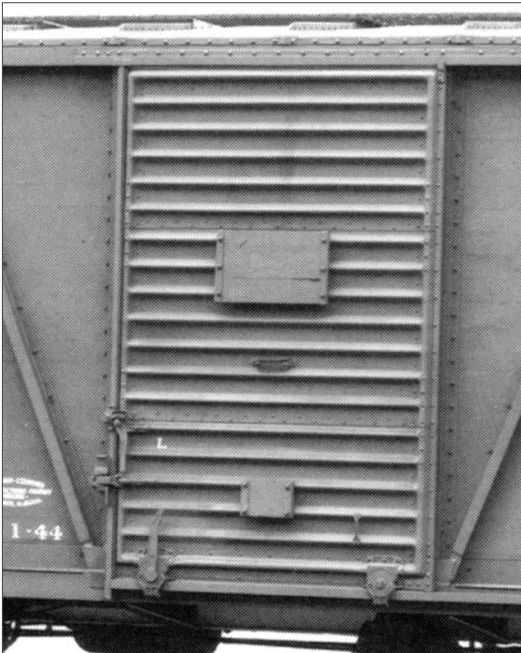

11. Youngstown corrugated steel car door.

BOXCAR AND REEFER DOORS | 12

The Camel Sales Company, which handled the marketing of Youngstown steel doors, introduced a new sliding door about 1925 that would, in time, become the most popular door of the steam era [11]. The three equal-sized steel panels with multiple horizontal corrugations made the Youngstown door easy to identify.

Freight car doors are heavy. Hundreds of miles of travel in a wide range of weather conditions, coupled with shifting lading wedged against the inside of a door, could make a 150 pound door difficult to open. Hardware manufacturers attempted to solve the problem with a variety of locking and unlocking mechanisms that incorporated levers to help force a stuck door off dead center. Among the more successful designs was a “door starter” sold by the Camel Company [12]. Many early Youngstown doors had Camel door starters mounted on the opening side of the door about one-third up from the bottom [11].

According to Youngstown sales literature, the use of Camel fixtures made opening and closing heavy steel doors much easier. When the lifting lever at the opening edge of the door was held down, the door was raised off the bottom support and was free to move. When the lever was released, the door dropped down on

the bottom track and was prevented from further movement.

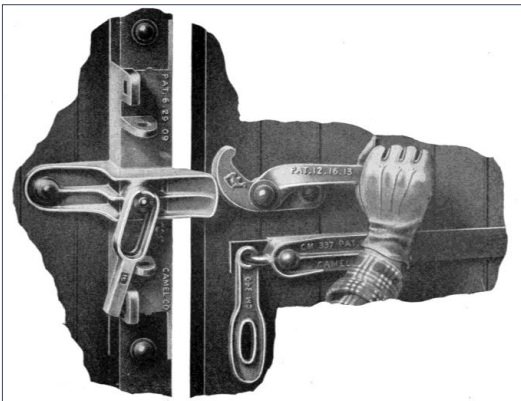

12. Camel “door-starter.”

BOXCAR AND REEFER DOORS | 13

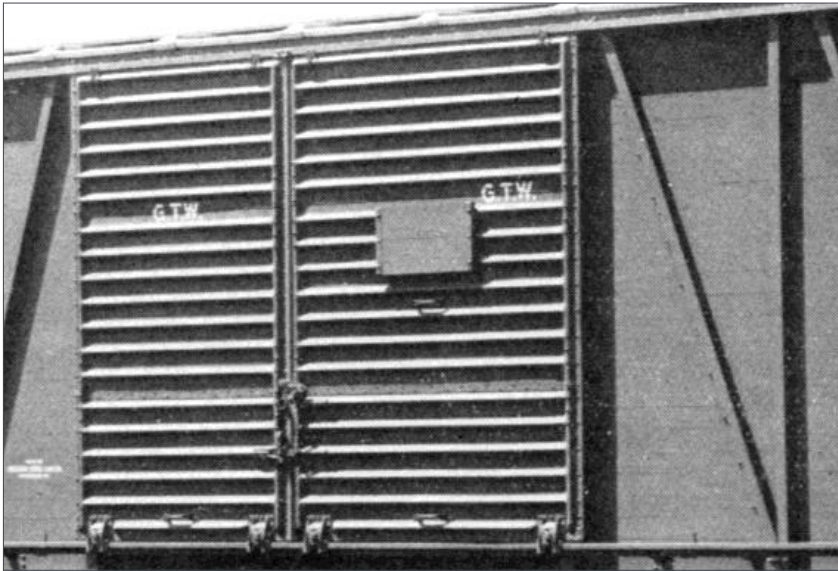

13. Youngstown double doors on an automobile car built in 1929.

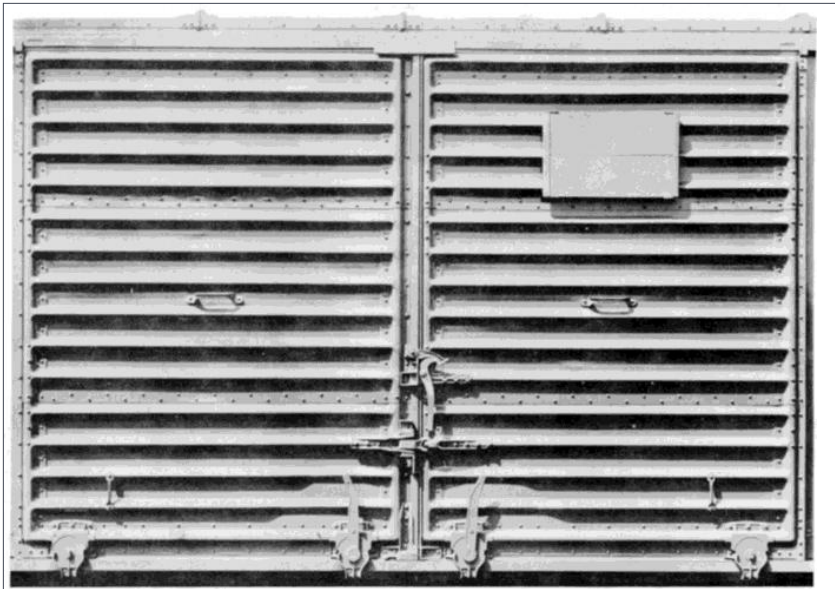

14. Youngstown double doors from late 1930s.

BOXCAR AND REEFER DOORS | 14

Figures 13 and 14 show the evolution of the bottom support rail and operating hardware on Youngstown corrugated steel doors from the late 1920s to the late 1930s. During WWII Youngstown produced composite doors using tongue and groove hardwood [15] as well as plywood [16]. The lower portion of the wartime doors that housed the rollers and locking mechanism showed the familiar Youngstown corrugations.

Near the end of 1945, Youngstown introduced a revised door design with visible changes. The new door had the rollers covered and a single operating lever located at the center of the door. For a brief interim period, the section where the three panels were

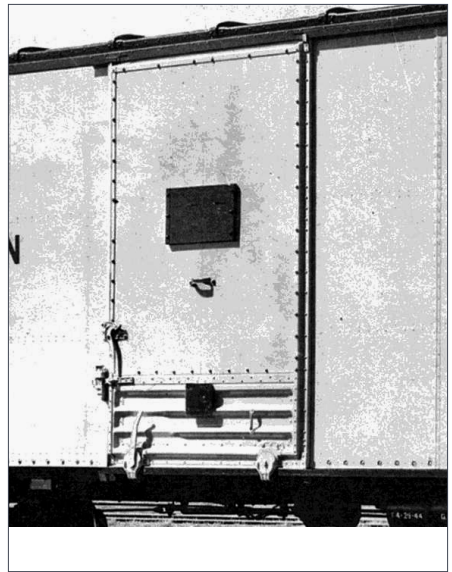

15. (Left) Youngstown WWII-era composite door with tongue and groove panel.

16. (Right) Youngstown WWII-era composite door with plywood panel.

BOXCAR AND REEFER DOORS | 15

riveted together was raised and widened [17]. They remained raised for only a short time and the following year they reverted to their original width [18]. Following its introduction in the mid-1920s, the Youngstown door became the most common boxcar door well into the diesel era.



17. A Santa Fe car built in December 1945 by Mount Vernon Car Manufacturing Company has the interim version of the Youngstown door with wide horizontal join panels and centered door opener at the bottom.

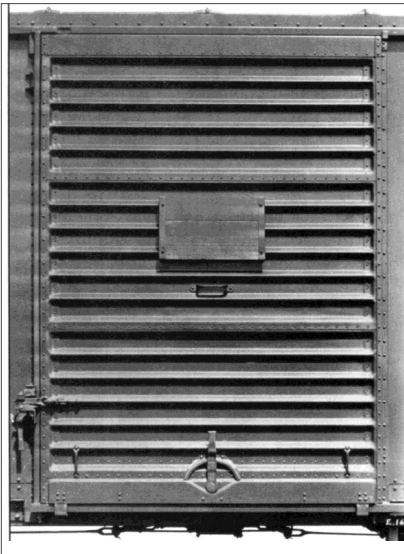

18. By 1946 Youngstown had revised their postwar door with narrow rivet sections similar to prewar designs.

BOXCAR AND REEFER DOORS | 16

Identifying doors from different manufacturers sometimes requires a close look. Beginning in the late 1950s the panels on Pullman-Standard boxcar doors featured a slightly peaked pattern with beveled ends [19]. The raised diamond pattern in the panels of the Evans door [20] are similar to those on the Pullman-Standard door. The Evans and Pullman-Standard doors are often confused with the other.

Less familiar than their six-panel door [19] is Pullman-Standard's sliding steel door with four bold rectangular corrugations in each of three panels [21] that began to appear in the late 1960s. A similar door with corrugations of varying lengths was first used by P-S on a series of 50-foot 70-ton waffle side boxcars built in their Bessemer plant for the Southern Railway in 1970 [22].

ADVERTISEMENT

CHECK
IT OUT!



Announcing
***Motrak Models New Coal Load
For Fox Valley 50' Coal Gondola:***

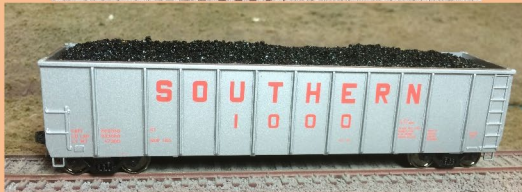

Phone number: 813-476-4784
Email: motrakmodels@centurylink.net

BOXCAR AND REEFER DOORS | 17

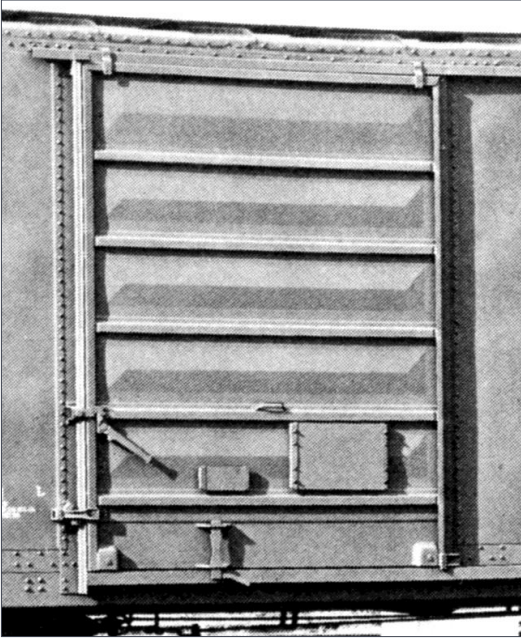

19. Pullman-Standard six-panel steel door.

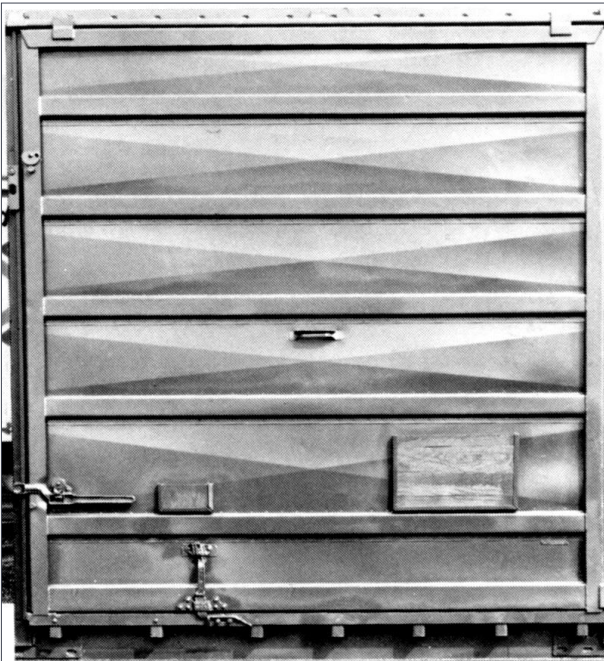

20. Evans six-panel steel door.

BOXCAR AND REEFER DOORS | 18

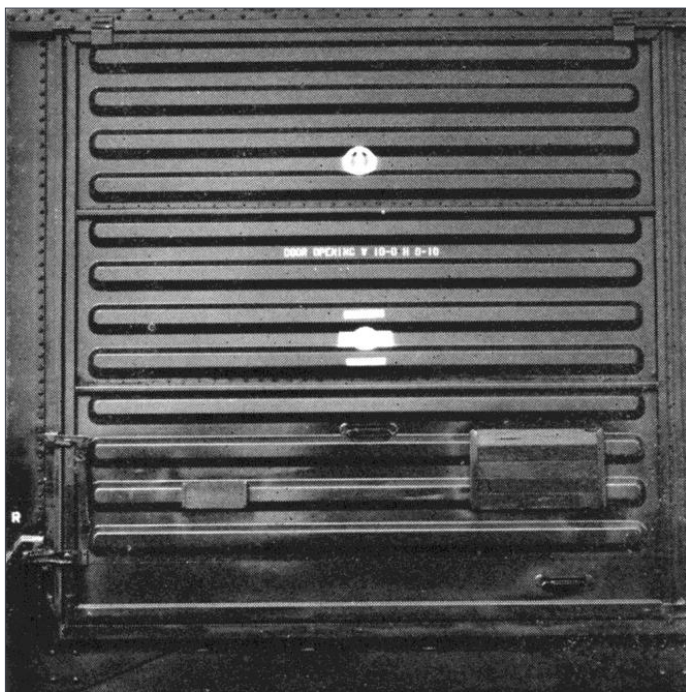

21. Pullman-Standard corrugated steel sliding door dating from the late 1960s.



22. Pullman-Standard waffle-design sliding door with corrugations of different lengths.

BOXCAR AND REEFER DOORS | 19

Occasionally car doors became stuck or jammed and were difficult to open. The sledge hammers, crowbars and forklift trucks used to open sticky doors often resulted in damage to the door jamb and the door itself. Various mechanical devices were developed with the most successful being the Slidewell rack and pinion system manufactured by the Hennesy Company.

It was attached to the right hand side of a sliding door [22] and was operated by simply turning the wheel.

In 1945 the Superior Car Door Company introduced the Superior Welded Car Door for box and automobile cars. Advertising literature explained how the door was fabricated with overlapping panels that were welded in place. Five [23] to seven [24] flat panels were used with wider doors generally having more panels. Superior doors were bottom-supported with the door riding on

four ball bearings contained in a carriage along the bottom of the door. Promotional material claimed Superior doors rolled freely and were lighter than the more popular Youngstown doors. Some PS-1 boxcars built by Pullman-Standard in 1954 had six-panel Superior doors.

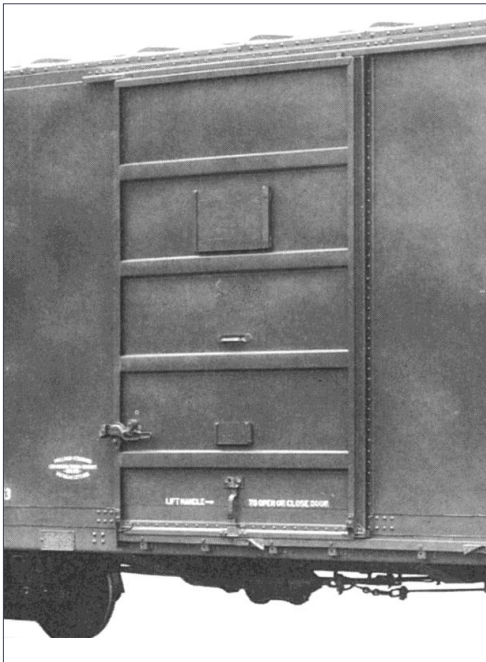

23. Superior five-panel door.

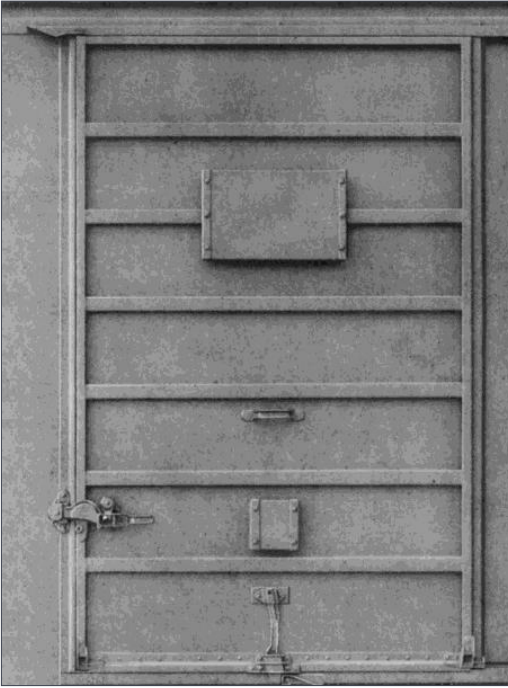

24. Superior seven-panel door.

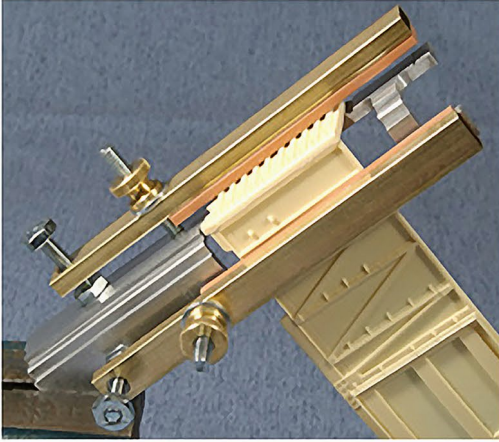

25. Superior seven-panel double doors.

Combo Right Clamp™

Combo Right Clamp™
with cast resin boxcar

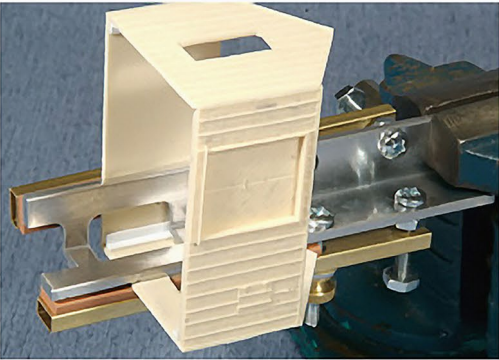

Combo Right Clamp™
with Wolf Design Pump House

**Click here for
all our products ...**

Tools for Modelers

Coffman Graphic Solutions Co.
1500 River Circle, Richmond,
KY 40475-7907

BOXCAR AND REEFER DOORS | 21

Unarco Industries developed a line of bottom-supported steel replacement doors that were sold under the brand name of Equipco [26, 27].

The spotting feature on Equipco doors that distinguishes them from Superior and International doors is the small gusset at the upper corners.

In the 1970s the International Steel Company of Evansville, IN, introduced a sliding car door the company claimed could be easily repaired [28]. The door used no castings and was fabricated from standard off-the-shelf steel parts.

Application literature suggested that any shop with welding capability could easily repair their sliding side doors. The horizontal ribs of the International five-panel door are thinner than those on a similar

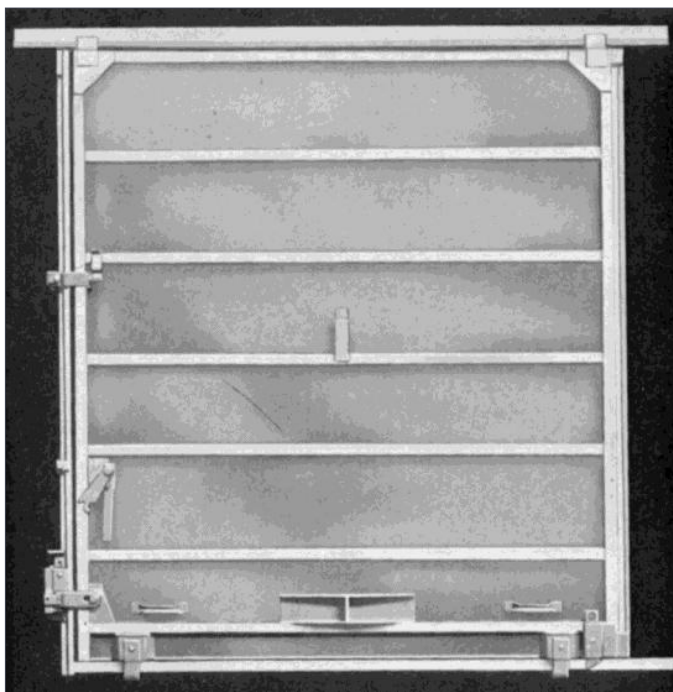

26. Equipco six-panel car

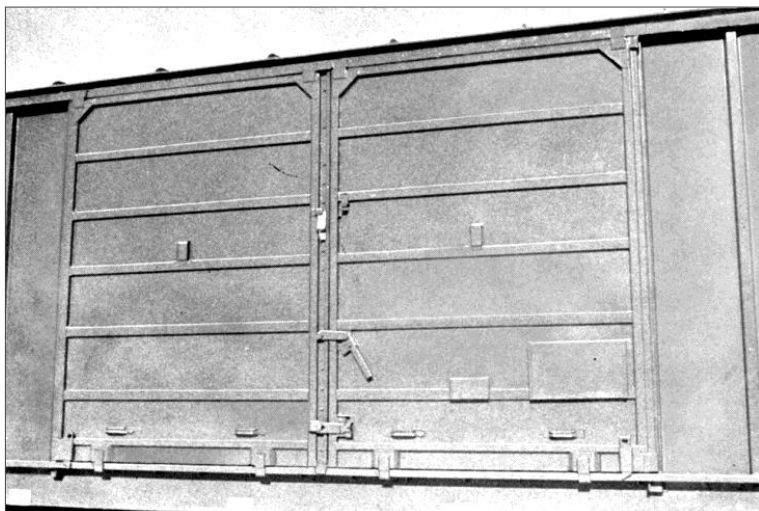

27. Equipco six-panel double sliding door circa 1980. Note small gussets at the upper corners.

BOXCAR AND REEFER DOORS | 23

Superior door [23, 24]. International Steel was perhaps better known for their car underframes and full-width end doors for automobile cars [57].

In an effort to speed up the loading and unloading process Pullman-Standard built several 52-foot cars for Southern in 1963 with three Youngstown roll-up doors on each side [29]. Some of the cars were modified with four Youngstown sliding doors [30]. Neither idea proved particularly successful.

Hinged refrigerator doors

Prior to the introduction of ice bunkers, railroad cars transporting perishable goods had screened or barred doors that provided ventilation to the interior of the car. Some cars had both ventilated and standard doors to give trainmen an option depending on the type of lading and changing climate conditions as a train moved from one region of the nation to another.

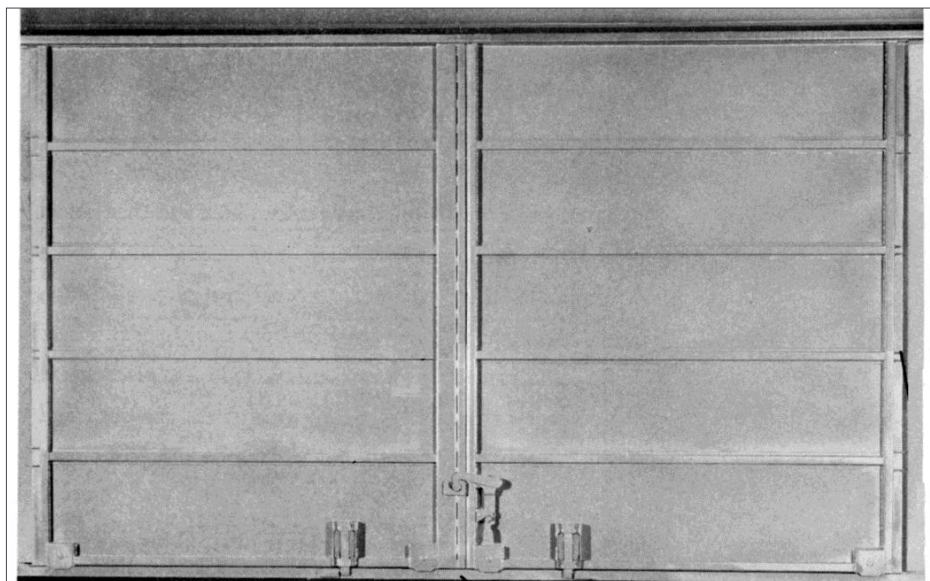

28. A pair of International five-panel doors, circa 1970.

BOXCAR AND REEFER DOORS | 24

Construction of ventilating doors varied from large openings with bars [31] to fabricated metal doors with adjustable louvers [33]. Built in the mid-1920s by Standard Steel Car Co., the durable ventilated car with the fishbelly underframe [31] remained in regular service until 1957.

By the 1890s fresh fruit, vegetables and dressed beef were being shipped in insulated cars fitted with ice bunkers at each end. Ice was loaded through hatches at the corners of the roof. Two of the early successes were the Tiffany Car and the patented Wickes Refrigerated Car built by Pullman-Standard with the distinctive diagonal patterned wood swing doors [34].

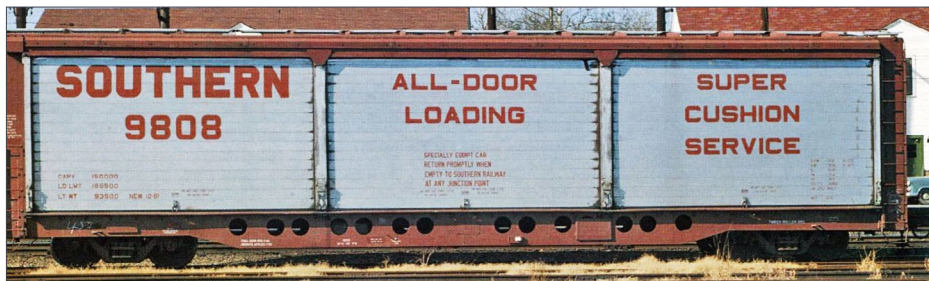

29. All-door car with roll-up doors.



30. All-door car with four Youngstown sliding doors.



31. Combination vented door and solid wood door.

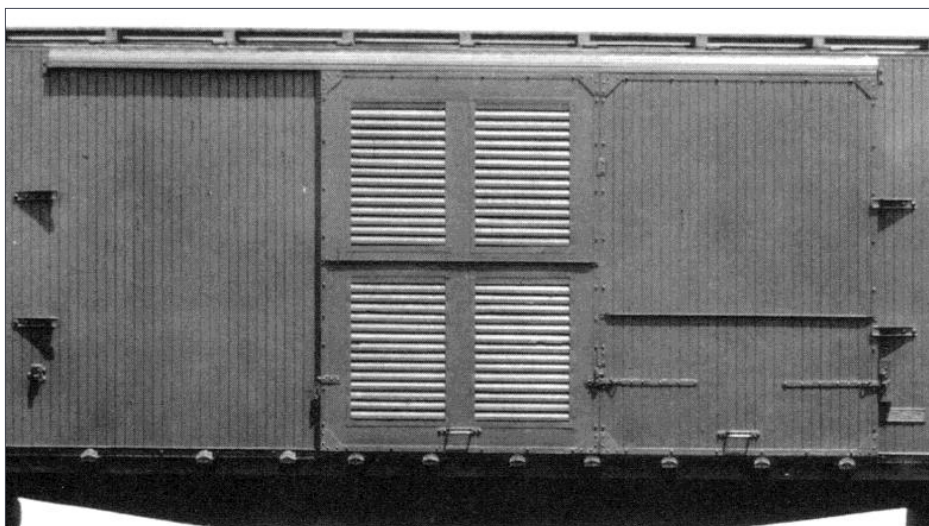

32. Combination vented door with stamped metal louvers and solid wood door.

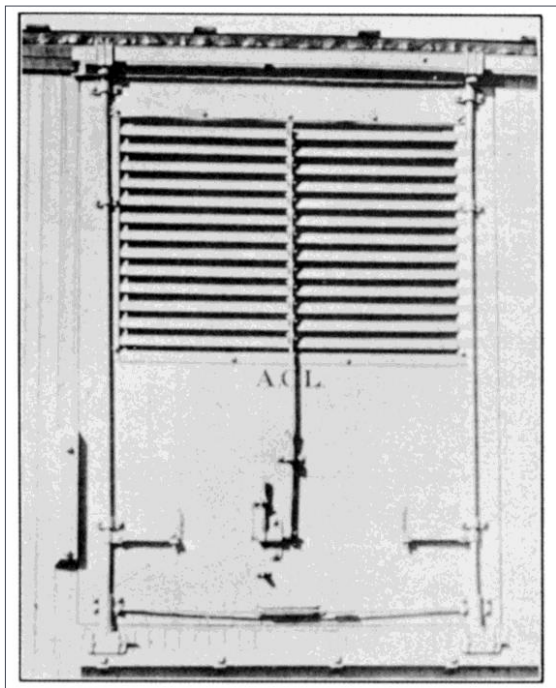

33. Kennedy vented sliding door with vertical locking rods, circa 1930s.

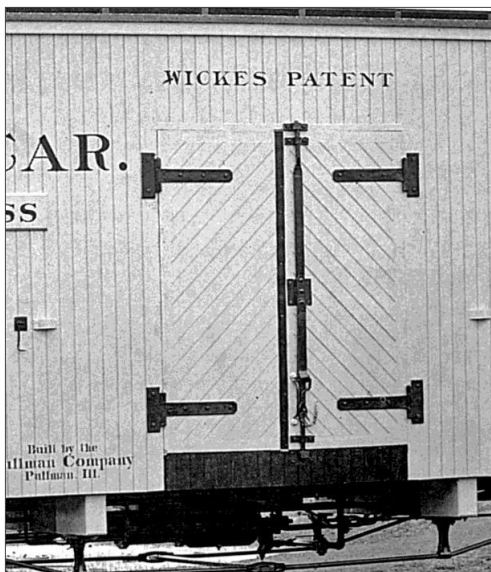

34. Four-hinged doors on an early Wicket ice refrigerator car.

BOXCAR AND REEFER DOORS | 27

Reefer doors were heavily insulated and required strong hinges to ensure reliability and a good seal to keep the cold in and the heat out. The number of hinges ranged from four [34] to eight [35] with six [36] being the more common. In the early 1930s Pressed Steel Car Co. built 40-ton refrigerator cars for NADX with just four hinges.

In an effort to limit the amount of cool air escaping an iced car, four feet remained the standard width for refrigerator door openings. A nominal 28-inch clearance between the loading platform and the car side was sufficient for each half of the thickly insulated doors to safely swing open.

To maximize the retention of chilled air, knee action hinges were used on some swing doors with a separate vertical cam-action locking rod on each door [38].

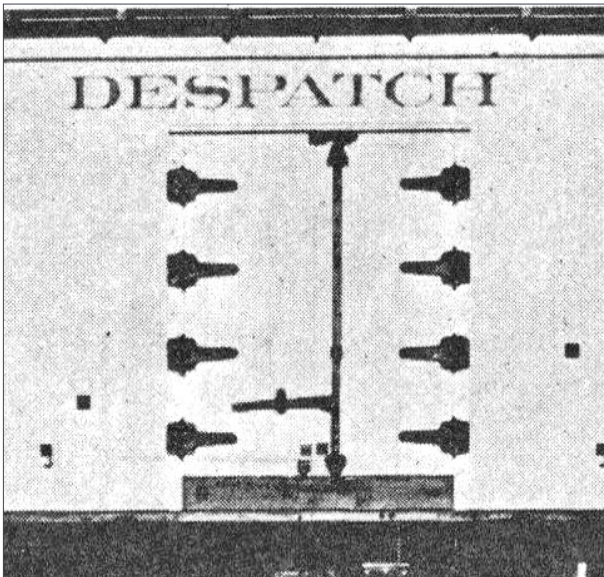

35. Swing doors on Merchants Despatch reefer built in 1917 had eight hinges.

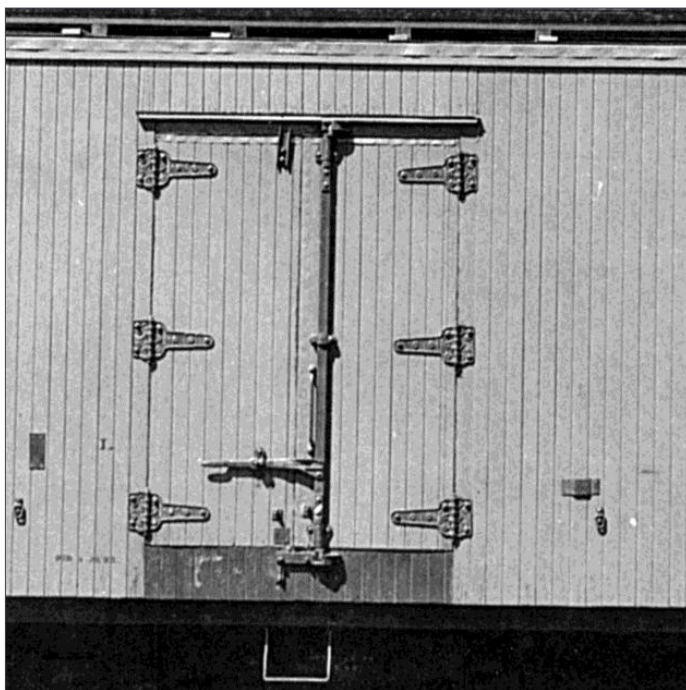

36. USRA reefer built in 1926 has six hinges on doors.

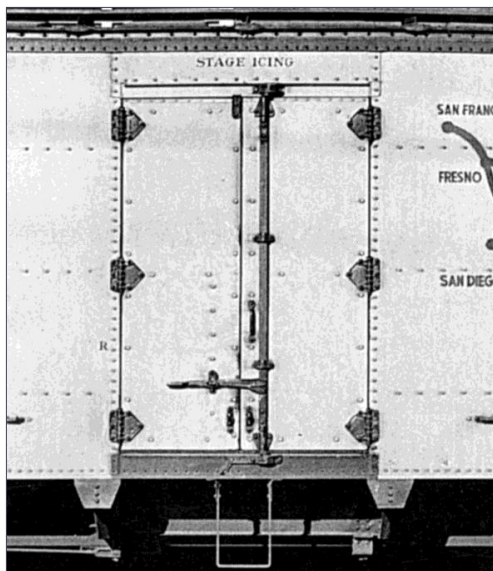

37. Doors on some reefers such as this SFRD car had short hinges.

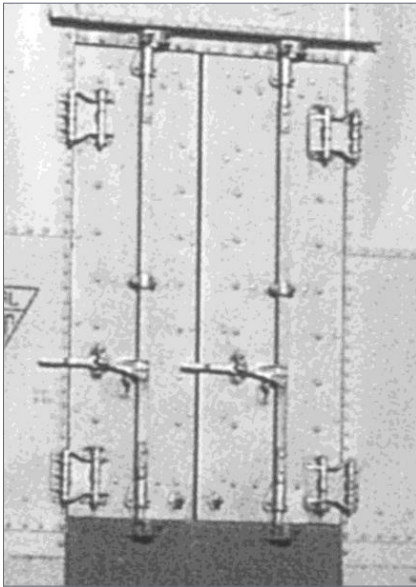

38. Dual cam-action locking bars on steel reefer built in 1937 with double-acting knee hinges.

ADVERTISEMENT

END OF TRAIN DEVICE

NEW ORANGE CASE!

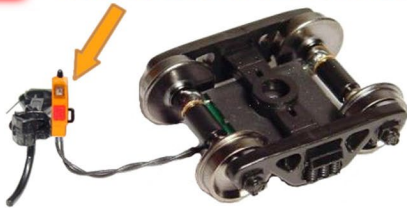

Bright Red Flashing Light!

Installs in minutes!
No freight car modification required!

RE RING
ENGINEERING™

[Click Here to Learn More](#)

Patented Technology - US Patent 7,549,609

Does not affect Load!

↓ Car without Load ↓



↓ Car with Load ↓



A few mechanized refrigerator cars built in the early 1950s continued to be fitted with four-foot swing doors, but to facilitate pallet loading, the majority of new cars of the period had plug doors at least six feet wide. Eight-foot plug doors appeared on PFE reefers built in 1954, and by the early 1960s some 52-foot reefers were being built with nine-foot plug doors. By the 1970s plug doors up to 10 feet wide were in use.

Plug doors

Refrigerator cars, especially those fitted with brine tanks or ice bunkers, required extensive cleanup at the end of each run. During the war years end-of-run maintenance was often incomplete which resulted in thousands of worn out cars after WWII. During the 1946-1950 recovery era many older reefers had their four-foot hinged plug-doors replaced with six- or eight-foot sliding plug doors.

Although introduced in the 1920s, widespread use of power lifts manufactured by Towmotor and innovative material handling equipment developed by Yale & Towne slowed during the Great Depression when the cost of labor was at an all-time low. However, by the late 1930s battery powered lifts in combination with hydraulic equipment and the increased use of standardized pallets began to significantly change the way both reefers and boxcars were loaded and unloaded.

The direct influence was the demand for cars with wider doors to facilitate mechanized loading equipment. Larger door openings in reefers meant an increased loss of chilled air during the loading process, but the loss was offset by reduced loading time using powered forklifts.

Sliding doors, which move longitudinally only, were always problematic because shifting lading could wedge against the

BOXCAR AND REEFER DOORS | 31

back of the door making it difficult to open without damaging the lading or the door itself – sometimes both. Since the initial movement of a sliding plug door is to pull away from the opening, there is less chance of damage to the lading. Sliding plug doors also are more adaptable to insulation. Despite their shortcomings, non-insulated sliding doors continued to be used on new boxcar construction. By the mid-1950s the eight-foot sliding door had become a virtual standard in new boxcars with the move to 10-foot doors following within a few years.

Most sliding plug-doors were top-hung and used elbow brackets [45] that, when rotated, forced the door into the opening flush with the inside of the car. Variations on the old Miner-type vertical rod with locking cams at top and bottom provided both security and a tight seal.

Some AAR rule modifications in the mid-1950s changed the appearance of car doors.



39. Note the clearance needed between the loading dock and car to safely open swing doors.



40. To limit the escape of chilled air some reefer doors were just five feet in height.

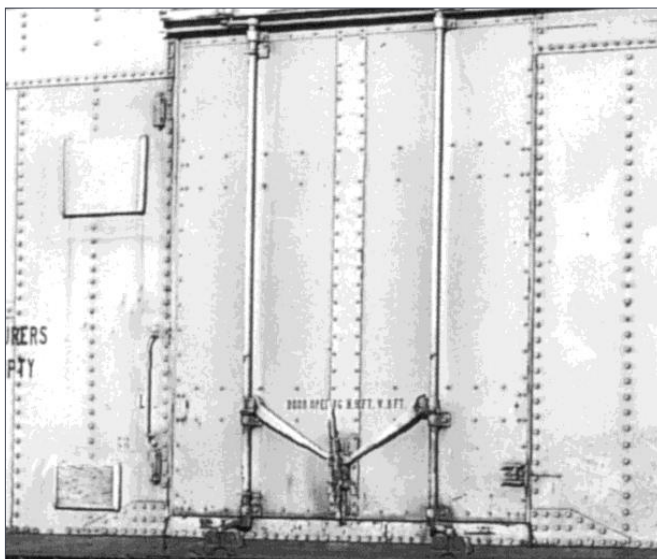

41. Youngstown sliding plug-door from 1953.

BOXCAR AND REEFER DOORS | 33

Tack boards on car ends and doors were moved from up high [13] where they could be read from a loading dock or brakeman on the ladder, to down low [19] where they were more convenient for a trainman on the ground. The move was seen as a safety measure for trainmen.

Although sliding plug doors were not new, Youngstown, the biggest name in the freight car door business, made a big splash in 1952 with an advertising campaign that touted the “The first complete, ready-to-hang sliding flush door for refrigerator and insulated box cars” [41]. The outside of Youngstown doors had a flat surface with two vertical locking rods. When in the locked position the two actuating bars near the bottom were secured in a chevron position.

Superior’s 6-foot sliding plug-door introduced in 1958 [42] is similar to a Youngstown door. It is distinguished by the paired vertical locking rods at each side of the door.

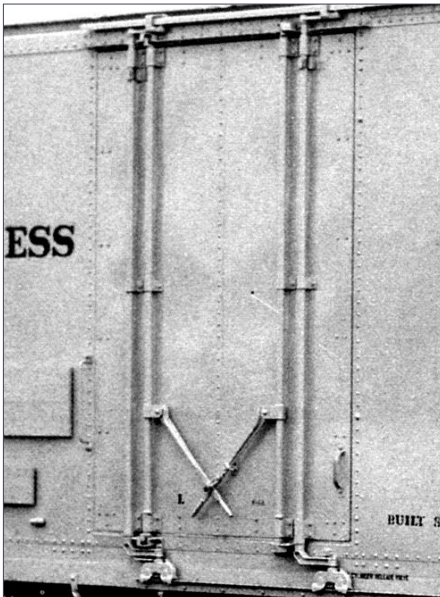

42. Superior sliding plug door has a pair of locking rods at each side of the door.

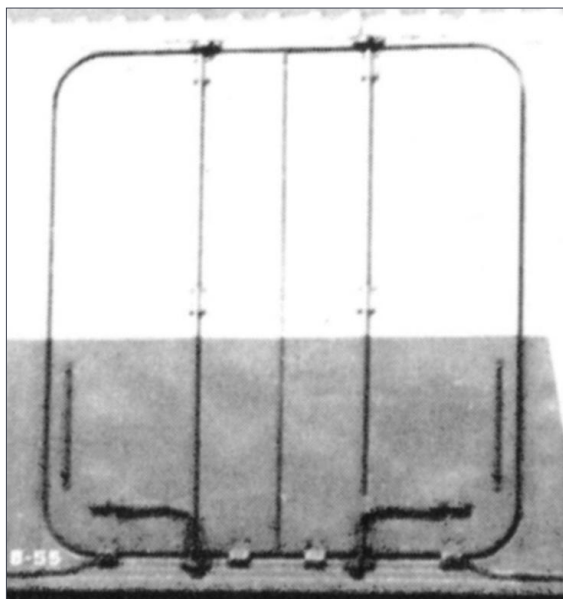

43. EMD rounded corners on 1956 Frigifrater car.

In 1955 Electro-Motive Division of General Motors (EMD) built a green and white mechanical refrigerator car called the Frigifrater [43] with two-piece sliding plug doors that had distinctive round corners. Although tested by various operators including FGE, SFRD, and PFE, the Frigifrater did not receive any production orders.

Pacific Car & Foundry of Seattle, WA, parent company of Kenworth and Peterbilt motor trucks, introduced the Landis “leverless” sliding plug-door in the mid-1960s [44]. The door used an internal chain drive to operate the locking bars. The door was applied to a large group of 50-foot insulated boxcars PC&F built for Southern Pacific, Cotton Belt, New York Central, Santa Fe, and Pacific Fruit Express (R-70-17 and -18). The Landis door did not achieve wide acceptance and was generally regarded as somewhat unreliable.

BOXCAR AND REEFER DOORS | 35

RBL boxcars (heavily insulated cars without ice bunkers) required insulated plug doors capable of sealing a car from exterior temperature changes for up to 10 days or more. Insulated plug doors made by Evans Products of Des Plaines, IL, [45] used four cam-actuated locking bars on each door to ensure a tight seal.

Equipco Division of Unarco Industries offered sliding plug doors with levers [46] as well as a leverless type [47]. A spotting feature is a third locking crank centered at the top of the door. In 1974 AAR addressed the problem of doors falling off with a ruling requiring a third upper crank arm assembly to act as a safety hanger.

In 1953 the Santa Fe Railroad launched a program to promote their reefers equipped with a new mechanical temperature control system (MTC). The campaign linked to the reefers themselves which had eye-catching blue Youngstown doors



44. Landis leverless doors circa 1969.



45. Evans double sliding plug doors circa 1980s. Note the paired locking rods at the side of each door.

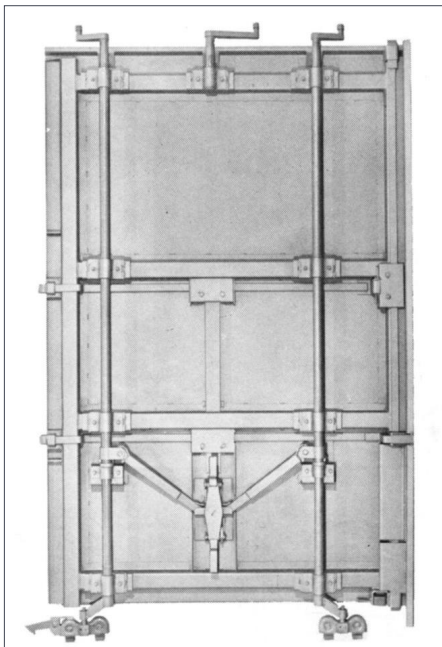

46. Equipco auxiliary lever sliding plug door with safety hanger at the top of the door.

decorated with a white icicle logo [48].

Pullman-Standard offered car builders a 10-foot insulated sliding plug-door [49] as a standard off-the-shelf component in the mid-1960s. It was big and heavy and could be a challenge to open.

In the 1970s Youngstown introduced a new outside framed insulated sliding plug-door that was 10 feet and six inches wide. Promotional literature for the door said the new and improved operating mechanism was so well balanced one man could handle the huge door. It is shown in figure 50 on a PFE class R-70-23 reefer.

PFE fitted some reefers with a combination of a four-foot sliding plug-door and a two-foot hinged door [51].

Visual inspection of the lading was accomplished with a minimal loss of chilled air by using the diminutive swing door.

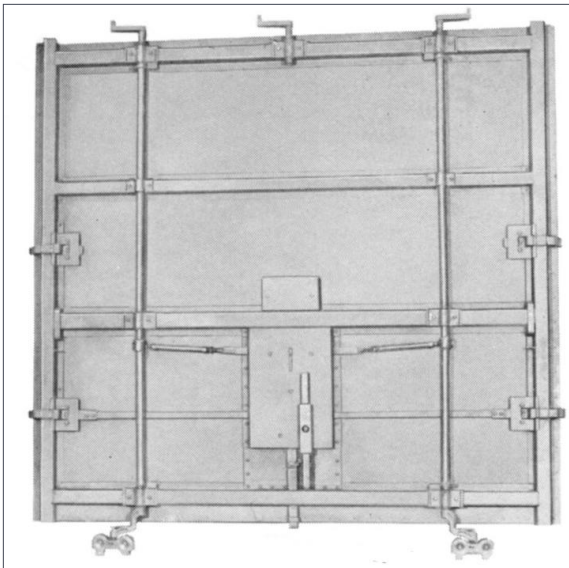

47. Equipco leverless sliding plug door, circa 1980.



48. Youngstown 10-foot leverless sliding plug door with Santa Fe MTC logo.



49. Pullman-Standard 10-foot insulated sliding door from the mid-1960s.

BOXCAR AND REEFER DOORS | 39

Loading lumber with a forklift required cars with a wide opening with double doors and no center post between the doors. Lumber tended to shift in transit often jamming conventional sliding doors. To overcome this problem, some lumber-carrying railroads, including the Great Northern, ordered cars with a Youngstown sliding door as well as a sliding plug door [52].

Shifting lumber could not jam a sliding plug door since the initial opening movement of such a door is to pull away from the car side. A second benefit of cars equipped with both types of doors came during the grain season. With the plug door locked in place and the sliding door open, standard grain boards could be fitted inside the opening.

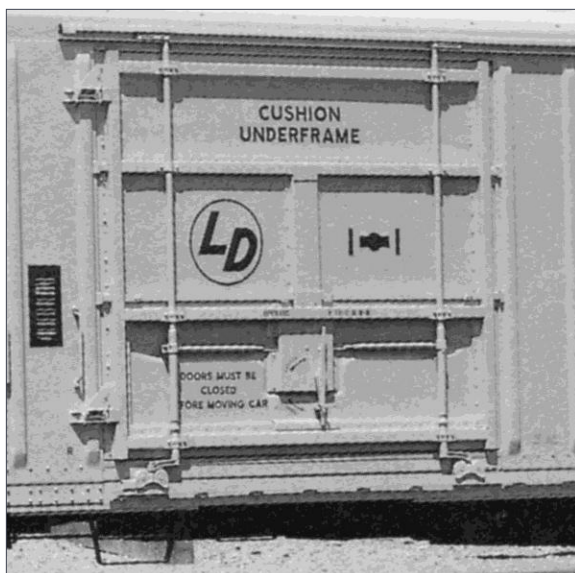

50. Youngstown 10-foot 6-inch "one man" car door on PFE reefer from early 1970s.

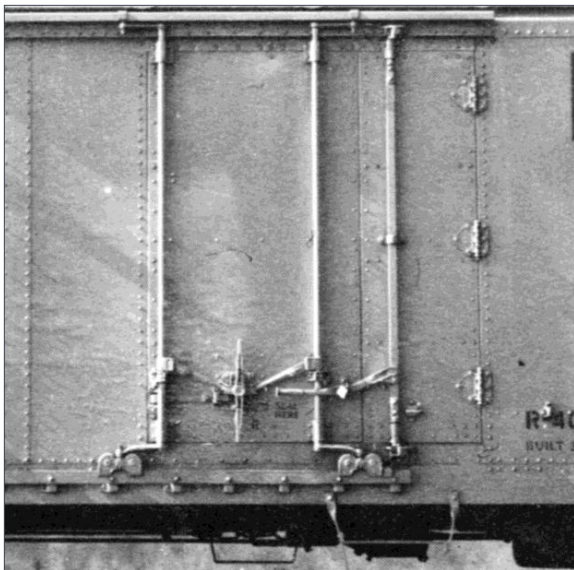

51. Combination of a four-foot Youngstown sliding plug door and a two-foot hinged swing door on PFE R-40-27 reefer built in 1963.

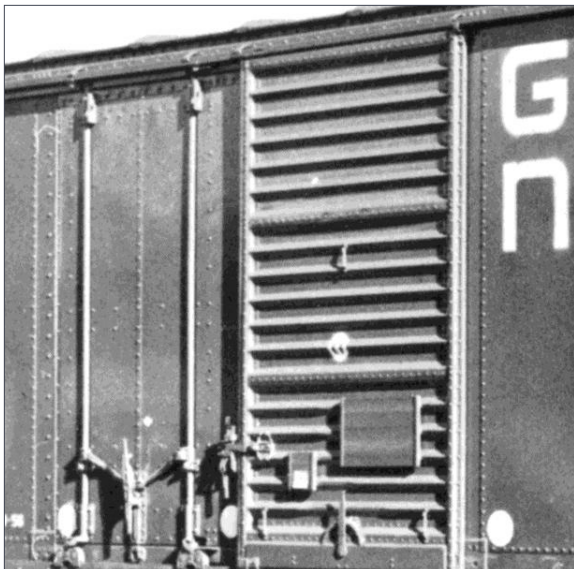

52. Combination plug door and Youngstown door.

Grain doors

Prior to the popularization of covered hoppers, general purpose boxcars were used to transport grain. At peak season regular boxcars deemed clean enough to haul grain were fitted with temporary wood boards across the door opening [53]. The boards facilitated loading, unloading and inspection, as well as minimized loss of grain in transit. In the early 1960s a few Midwestern railroads modified some of their boxcars with new combination doors that could handle regular loadings as well as grain without the need for troublesome boards.

In 1964 the Minneapolis, St. Paul & Sault St. Marie Railroad (Soo Line) rebuilt some of their 50-foot exterior-post boxcars with a 10-foot sliding plug-door that had a pair of grain doors in the top panel [55]. The message stenciled on the door reads, “Grain loading and inspection doors. Doors open inward.” The car could be used for regular service after the grain season.



53. Boxcar fitted with boards for hauling grain.

BOXCAR AND REEFER DOORS | 42

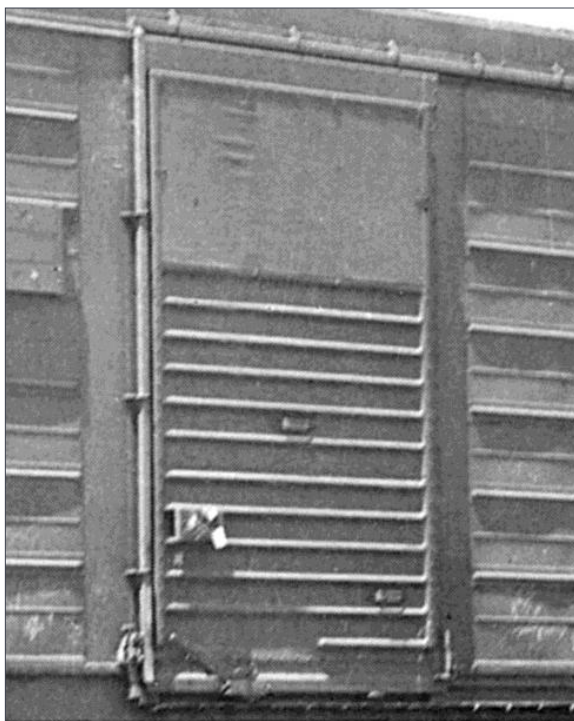

54. Milwaukee rib-side car has a Youngstown door with plywood grain door at the top.

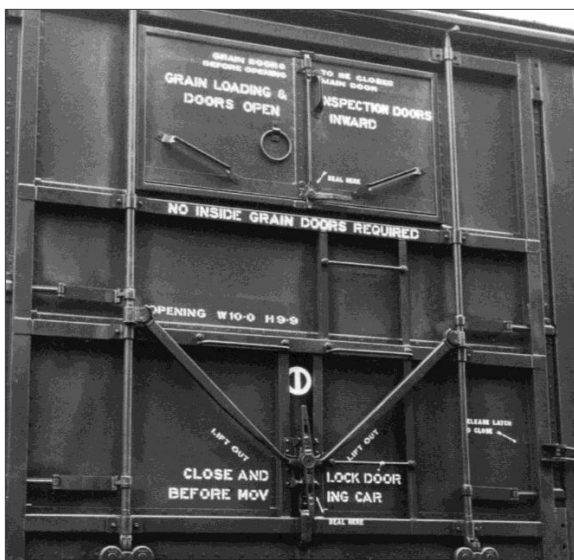

55. Soo Line 10-foot plug door with two small grain doors at the top.

Specialty doors

Prior to the development of auto carriers, new automobiles were transported in boxcars with double sliding doors [14, 25]. Cars designed to carry automobiles were often built with full-width hinged end doors [57] usually stamped with a Dreadnaught pattern. Both interior and exterior locking hardware was used.

The small lumber doors on the ends of boxcars [58, 59] were not for inserting or withdrawing lumber. Long pieces of lumber were loaded through the regular side door, then poked out the lumber door as far as required for the lumber to clear the jamb of the side door. The piece of lumber was then backed into the car. The procedure was reversed to unload. Most lumber doors provided an opening 18 inches square. Generally lumber longer

than 24 feet was not loaded into 40-foot boxcars.

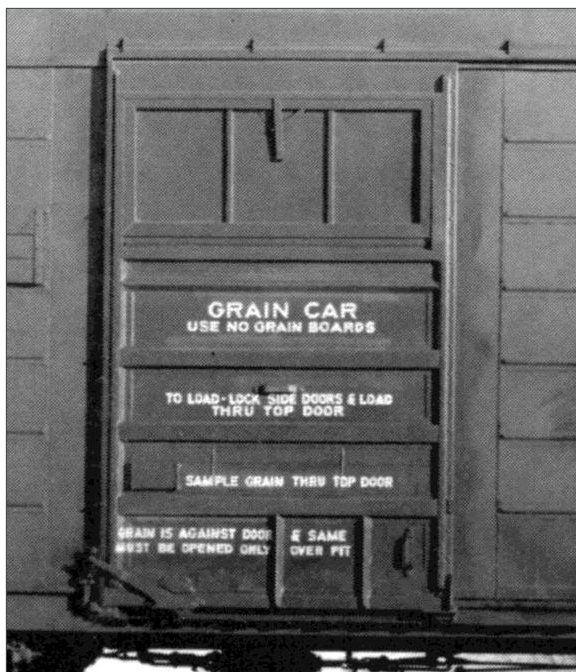

56. Milwaukee Road postwar rib-side car with grain door in upper panel of door.

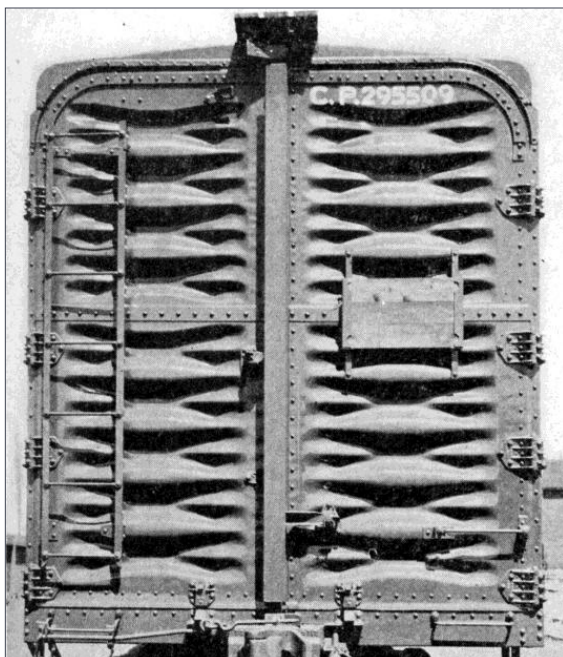

57. Full-width hinged end door.

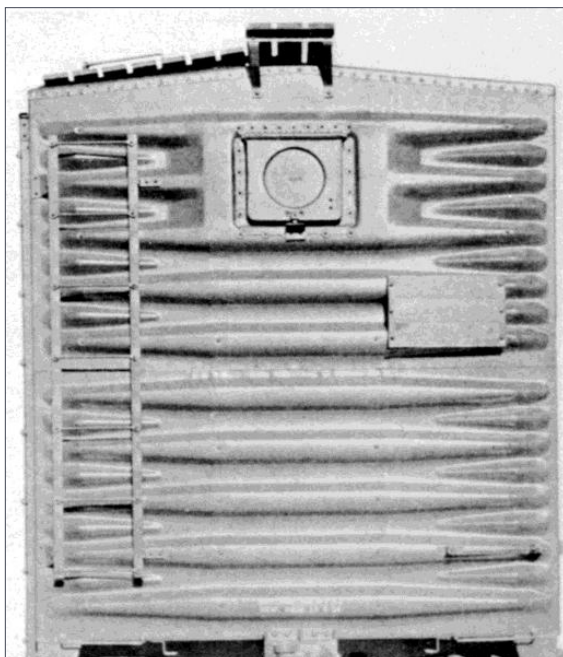

58. Boxcar end with small lumber door.

Door hardware

In the early development of refrigerator cars, locking doors for security as well as to prevent loss of chilled air over a prolonged period was a challenge. In 1910 Miner began selling door hardware with the familiar locking rod invented by a fellow named Calvin Patch. The inventor's basic idea of a sturdy vertically rotating rod with dogs or cams that engaged top and bottom clamps is used to this day on railroad cars as well as on containers and highway trucks.

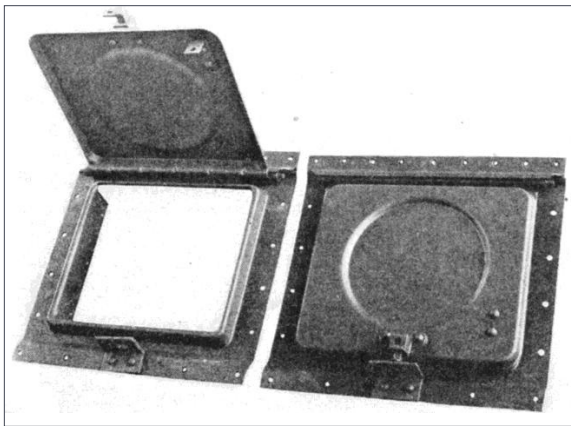

59. Bettendorf lumber door.

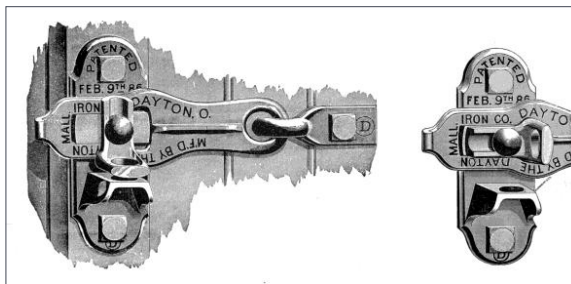

60. Freight car door lock made by Dayton Malleable Iron Co. circa 1900.

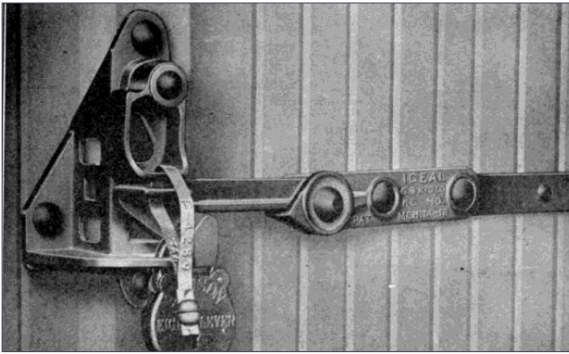

61. Automatic freight car door lock by Gustin-Bacon Co. circa 1910.

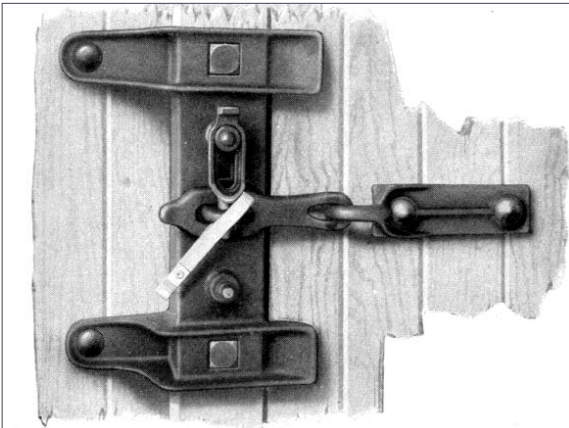

62. Combined door stop and lock from National Malleable Castings Co., circa 1920-1935.



[Click here for reader comments](#)

DAVE PETTY'S MIDWEST CENTRAL

BY DAVE PETTY AND
THE MRH STAFF



1. An A-B F-unit set, in the latest Midwest Central paint scheme, emerges from a tunnel with a coal train bound for Divide Yard. Below, a local freight on the Wabash Line heads east.



[Click here for
reader comments](#)



*Also coming to
TMTV in March*

• INDEX

• TABLE OF CONTENTS



• INDEX

• TABLE OF CONTENTS



2. Dave likes building structures and this view of Tunnelton downtown displays his work nicely – his attention to detail really brings the town alive. On the left just past the bridge is the Shakey Chair main factory, Tunnelton’s largest employer. Back on the sky backdrop you can see Dave’s faint clouds done using a foam brush technique with white and blue paint – subtle but very effective!

MRH: HELLO, DAVE. INTRODUCE US TO WHAT you’re building here.

Dave: My layout represents southern Indiana and all the little towns in that area. I especially like modeling rural scenes, so you’ll see quite a few barns here. I’m modeling June 3rd, 1954 and it’s always this date. This gives me an advantage when somebody

says, “Why don’t you do this?” I say, “I’ll do it tomorrow” – and I can keep my promise!

For instance, I have a factory on the layout called Wood’s Furniture. However, it’s been bought out by Shakey Chair, but the sign still says Wood’s Furniture. If you’ve got a boxcar to deliver and it says Shakey Chair, then it goes to Wood’s Furniture. The Shakey Chair sign is being delivered tomorrow!

MRH: What’s the history of your freelanced line?

Dave: The railroad started out as the Badland & Upton Divide. They were two competing railroads, both losing money. Then they merged. They kept the same management, kept all the equipment and became the Budlines.

Now they were losing money faster.

They reached a point in 1953, June the 3rd in fact, when they were \$50 million in debt and no one would finance them any further.

The Midwest Central came along and says, “Tell you what. We’ll buy the railroad and all the equipment for a dollar.” Budlines says, “Okay, as long as you take all the the debt, too,” which they did.

One year later they had paid off the entire \$50 million and had one dollar left. They managed this feat by selling off everything possible they felt they could do without.

In a way, that’s not unlike the real history of my model railroad. When DCC became available, I had a lot of locomotives that weren’t worthy moving to DCC, so I sold them. I got more than enough money to pay for the DCC conversions for the rest of my loco fleet.

So it’s a similar story. I got rid of the stuff I didn’t need to get the things I wanted.

DAVE PETTY'S MIDWEST CENTRAL | 5

MRH: Why this region?

Dave: Southern Indiana appeals to me because I live here and have traveled the area extensively. I just like the look of the region. I have traveled the 48 states and there's beauty in every one of them, but this is what I know best.

My thinking is to model what I know and it will likely come out looking better than if I try to model something I've only seen briefly and I'm trying to model from vague memories.

MRH: How did you plan the layout?

Dave: I started drawing up plans for the railroad. The difficulty is deciding what to do and what not to do. The temptation is to incorporate everything.

If you had the biggest basketball arena in the world, then you might be able to design a railroad for it, but of course you need the time to build it. I focused on what I thought would be practical and I drew up that railroad. I had some flexibility with my space, so I made the layout room the size it is on paper and then went to a craftsman to design a bathroom and other adjoining rooms to go along with the railroad.





3. Here's a close-up view of the family-owned Shaky Chair main factory in Tunnelton. The Shaky Chair Company has a small fleet of boxcars to receive and ship by rail. Recently, the Shaky family began expanding by purchasing another furniture factory along the Midwest Central railroad, Wood's Furniture.



4. Badland is one of the original two lines, merging with the Upland & Divide, to form the Bud Lines and finally the most recent financial reorganization into the Midwest Central. The financial struggles and multiple reorgs have all happened so fast this F unit has not yet been repainted into the new Midwest Central scheme. In this scene, the Badland diesel is on the point of a local freight as it passes over a muddy river on its way to Tunnelton.

MRH: How did you get into the hobby?

Dave: There's never been a time in my life when there wasn't a train around. My older brother got a Lionel train and Dad provided room for our model train. So I always had access to a model train while growing up. When I got married, I had to have a model train around, so I got an HO train.

DAVE PETTY'S MIDWEST CENTRAL | 8

I bought one of those locos with the rubber band drive. Obviously, it didn't run worth a darn, so I had the HO train a while but didn't do much with it. I did buy a few other things, but was very space-constrained. Then N scale came along and I got some more space, too. I figured I could try building a layout because it wouldn't take nearly the space a larger scale would need.

MRH: How did you do going from O to HO and then to N?

Dave: My change to N scale was in the early '70s, probably about '71 or '72. I started with an N scale train set. I still have this original train set, not in its original condition of course because I ran the wheels off of it!

Performance was marginal because in that day, N scale just didn't work as well as HO did. I had great fun with the N scale train and even built a four foot by three and a half foot railroad.

In N scale I was doing more than I could do in HO and was having a lot of fun doing it. I started some scenery and then got even more space for the railroad when we added onto our house.

MRH: What's modeling in N scale like now, compared to then?

Dave: In those days, the engines would run, but they had basically two speeds: fast and way too fast. Now, the N scale locos are so smooth running. They're quiet and run reliably, which is something that was hard to come by in the early days of N scale.

MRH: Scenery and structures: What is it that motivates you to do that part of the hobby?

Dave: I didn't want trains to go around a bend on every peninsula. If there is a reason for the track to go around a curve, like the prototype, it needs a good reason. At Buzzard's Roost for instance, I have a curve around the town, but I followed a

prototype example of a railroad curving around a town and then going upgrade like I do here on the model. I also did not want to see a train coming in one direction, and then going back the other direction through the same scene. That's why I used so much hidden trackage in my layout design.

MRH: How has the hidden track worked out?

Dave: On my hidden track, for the most part, I avoid having turnouts. That cuts down a lot of your problems right there. I do have turnouts at the entrance to my storage tracks where the trains come forward and backward, but I make sure they do it reliably.

I take the turnouts and manicure them before I put them in. I'm doing things like taking any edges off the points so things won't pick on and derail. The goal is absolutely no derailments. Have I ever achieved that goal? No, but derailments are rare and it's usually when somebody new is operating.

MRH: Did you go through a layout shakedown process before you started scenery?

Dave: I did an extensive shakedown. The track, especially the turnouts, needs to be manicured to avoid problems. I tested with 20 car coal trains, took my fastest locomotive, and would run forward and backward through the turnouts until I had 100% reliability while I was testing. Now, I didn't do this testing without having the floor protected in case something came off. Durability of your turnouts is the key to reliability.

MRH: How do you do your trees?

Dave: I make my trees look as real as possible, but I don't spend my life on them because my railroad needs a bunch of them to properly represent Indiana. If I was modeling Utah, I would not need too many trees. So it just depends on where you're modeling.

“My railroad needs a bunch of trees to properly represent Indiana. If I was modeling Utah, I would not need too many trees. It just depends on where you’re modeling.”

For my pine trees, I didn't make any of those myself. I use a supplier that makes trees. He makes pine trees in various sizes and they look very good. I also used a lot of the Scenic Express trees and there's also many Woodland Scenics trees that a friend of mine made – I'd say maybe 800-1,000 of those. I've got a few trees that I super-detailed. One has a tree house in it – some visitors catch it but a lot of visitors don't.

MRH: How did you do your sky backdrop and your clouds?

Dave: The clouds were very simple. I bought white paint, blue paint – I used the same brand because I didn't know how well different brands of paints mix with each other. I took the white paint, streaked it on, smeared it on really. Then I put some blue paint on and rubbed it in over the white using a paint pad and it gives a very light effect of clouds.

MRH: That's an interesting approach, did you have something specific in mind with this method?

Dave: No, I simply wanted more than a plain blue sky. It's just luck because I had never painted clouds before. I was lucky.

MRH: How did you end up doing DCC and having what looks like a DC control panel. And what's this wire hanging on the panel?

Dave: When I started the railroad, DCC was established, but there were not many decoders small enough to go into N scale. I like the ability to walk around untethered with your controller. In regular DC, there wasn't much available for untethered control. DCC wireless just operates that way automatically. But with N scale and the challenge of no space for decoders, how do I get the DCC signal to the track?

A friend devised a system he called an "expendable decoder." The idea is you hook the decoder output to the track like a conventional DC power pack. Then you just turn everything on and you have wireless DCC control of your loco.

So I could then get the wireless walk-around ability and with no need to have to have plug-ins all over the place. And I didn't need to have long wires on a tethered controller either.

So I put a panel that had six positions on it to give me six different DCC decoder-based throttles. I could run trains like conventional DC with the whole railroad wired not unlike a conventional DC railroad.

Each decoder actually became the power pack. It's actually less expensive because a good power pack isn't cheap. A nice HO decoder cost about \$25 then, so this method was not that expensive.

A few years later, decoders are now small enough to fit N scale easily, so I would not need this approach. As it was it solved my problem then and it still works now.

I have thought about taking out the panel because it blocks my view. But there's a million wires connected back there! In order to

DAVE PETTY'S MIDWEST CENTRAL | 12



5. Union Station serves the busy metropolis of Oolitic. Across the street, in the foreground, is a small park with a retired Upland & Divide steamer preserved for posterity. This is the roadway entrance side of the station. On the other side the station serves the Midwest Central railroad tracks with a nice covered platform.

get rid of the panel, I'd prefer a remote system for throwing turnouts from a throttle but not all my turnouts are powered. Many are hand-operated, but I'd need to unwire the panel and wire up many turnouts. I have no energy for that now. Maybe 20 years ago, but not at this point.

The wire on the panel is my way of throwing the turnouts. I use conventional solenoid coil throws – each throw has a wire going to one contact point, a wire going to the other contact point, and third wire that activates it.



Yes, I could use push buttons to make a nice, neat looking control panel. But I have friends who used push buttons that were often replacing push buttons because the solenoid current was more than most push buttons could handle. Somebody gave me the idea of using a wire and a brass nail. I've used that since 1970 and I've never had a brass nail fail – so it's 100% reliable.

6. An A-B set of Midwest Central F3s lead a coal drag under the wooden bridge at Tunnelton while laundry air-dries at a nearby house. Just beyond the bridge, the three tracks narrow into two, and the double track continues for some distance.

MRH: What do you like most about this layout?

Dave: I don't have a single most-liked thing. I set out to create a layout that resembles what's now in this room, so I like that.

MRH: Is there anything you would change if you could do it all again?

Dave: If I could change anything from the get-go, and keep my body from getting any older, it would be to extend the layout all the way down the street to the end of the block! There's so many things that you can do in a very, very large railroad room. I started building a railroad and I knew I was going to get older. I tried to analyze how much I would need to do. I was newly retired at the time, so I didn't have to worry about going out for the day job. I could play trains any time I wanted to and I just tried to anticipate what amount of time would I have to build this railroad.

MRH: Isn't that what retirement is for?

Dave: That's right! We should retire when we get out of high school because then we got the energy to do all the fun things.

MRH: How do you motivate yourself to do those things you don't like to do?

Dave: I don't like building the benchwork. It's vital, but I don't like doing it. It's good it doesn't take all that long either, and then you're done with it. I don't like running wires either, and DCC means if I were wiring the layout today, I would need thousands of feet less wire.

MRH: Were there any surprises or things you didn't expect along the way?

Dave: Well, I don't like wiring. I understand it though. I know what to do and how to do it, but I don't like doing wiring. I've



7. There are still a number of steamers on the roster and number 26 has just been repainted into the new Midwest Central scheme with a bold gold logo emblazoned on the tender sides. There's still a lot of life left in this 2-10-2 that is performing an air test. It will soon depart Divide and haul another days' freight over the Midwest Central line.

probably started 10 model railroads in my lifetime, so I don't think I have experienced anything that I hadn't already been frustrated by previously on a prior layout project.

MRH: How high is the layout and why did you choose that height?

Dave: I don't recall exactly, I think it's about 38 inches.

MRH: Yes, it's about 40 inches.

Dave: I've helped people with various model railroads and I've seen a lot of different heights. Some have been so low I would need to get down on my hands and knees to work on some parts.



8. Here's one of three experimental paint schemes the Midwest Central is trying on its hopper fleet. This hard-working cement hopper didn't take long to get a fresh coat of grime over the new paint. It's nice how the weathering brings out the details, even in N scale. Dave painted and re-lettered this car with decals produced on his ALPS printer.

Then there's some where they were at my chin level. I just chose a height to fit my body height better. The higher the railroad gets, the shorter your arms become and I wanted to be able to reach far enough, without throwing my back into a medical fit.

MRH: Yes, you may not be able to reach in four feet forever.

Dave: That's right. Also, I didn't want to crawl under anything.

MRH: Do you host op sessions and what are they like?

Dave: For an operating session, we've had as many as five different people plus me. Things work extremely well with five



9. Take note of all the small details Jeff's added to his steam donkey scene. There's a Cat diesel pulling a log, the hillside is riddled with stumps, there's a loading ramp for bringing in needed supplies for the camp, and there are many figures moving about in a beehive of activity. And of course, there are a number of spindly cables and pulleys around the centerpiece spar pole.

although four is a good number, too. I designed the operation so you could stay in one place and your operating points would be in fairly close proximity. With my somewhat narrow aisles, people don't need to squeeze by each other. When we have an operating session, everybody has their spot and they're not bumping into each other because they don't have to move around.

MRH: So the design is not walk-around?

Dave: I did that once. I had a model railroad in a basement and I made it walk-around. But then I couldn't sit down and just run trains. I had to walk along with the train all the time. Sometimes I'd be tired and I didn't want to do that – and I was a lot younger then. I changed that railroad to have continuous running. I can run this layout point to point, but it takes more than one operator in order to do that. I can run them from one staging yard, around the railroad, and back into the other one just like it was point-to-point. But that's complicated to do on this layout and it needs a good team of operators.

MRH: Would you ever consider changing scales?

Dave: If Z had more equipment available, I could see making a Z scale railroad. In fact, I sent out an email for fun saying I was changing the whole railroad to Z scale and they thought I was nuts!

MRH: What advice would you give to someone who is just starting out in the hobby?

Dave: Make sure that whatever you do, it's fun. Don't take your hobby to the point it has so many rules that you can't have fun while you're doing it. It only is a hobby!

MRH: How do you keep it fun?

Dave: By not taking anything too seriously.

MRH: What has this layout and your hobby done for you?

Dave: It's given me a lot of friends. It's allowed me to think up something, and then see if I can do it. If I can do it, that's exciting! If I can't succeed at it, then maybe I'll learn how later. Sometimes it seems totally impossible, but it's actually only impossible for a while.

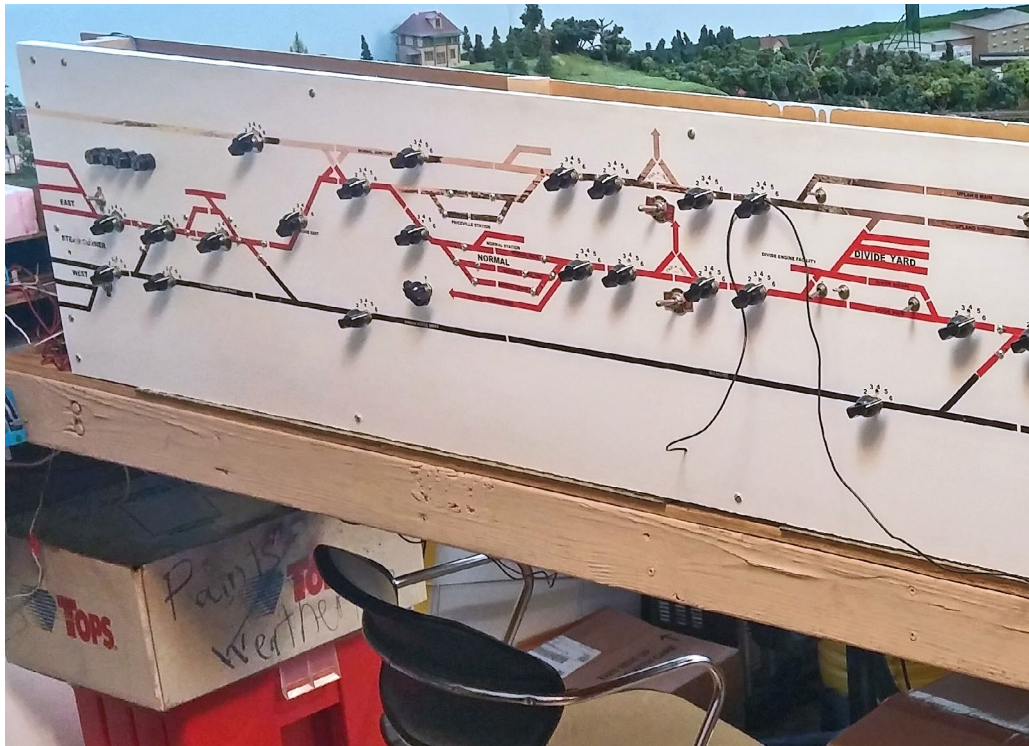

10. Dave's old DC block control panel remains in use long after he converted all of his locos to Digitrax DCC decoders. Dave no longer uses the rotary switches – he just leaves everything set to one cab that is connected to his Digitrax command station. Notice that Dave still employs the age-old brass nail and ground-lead wire technique to activate solenoid switch motors by a touch on the panel – that's what the wire hanging on the panel is for.

DAVE PETTY'S MIDWEST CENTRAL | 20

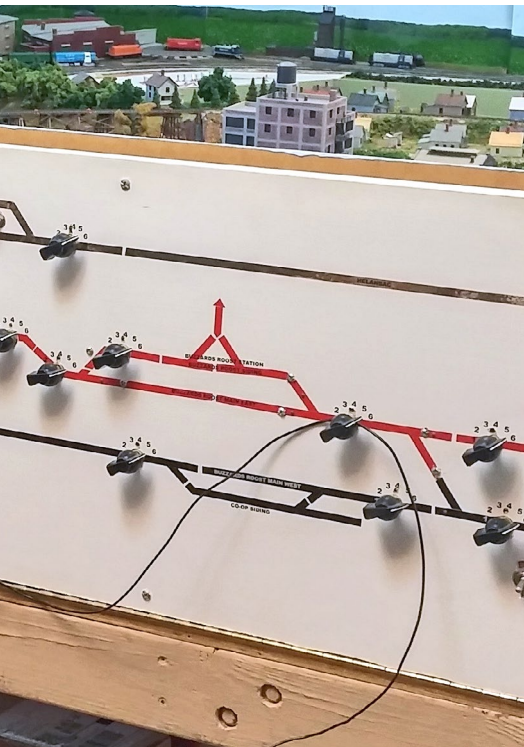

MRH: What do you hope convention-goers take away from their visit here?

Dave: I do hope they enjoy it. One of the nicest compliments I got was from a newspaper reporter. She said, "What place is this a model of? I've been there!" ☑

You can see Dave's layout at the Indianapolis NMRA Convention this July ...



Also coming to TMTV in March



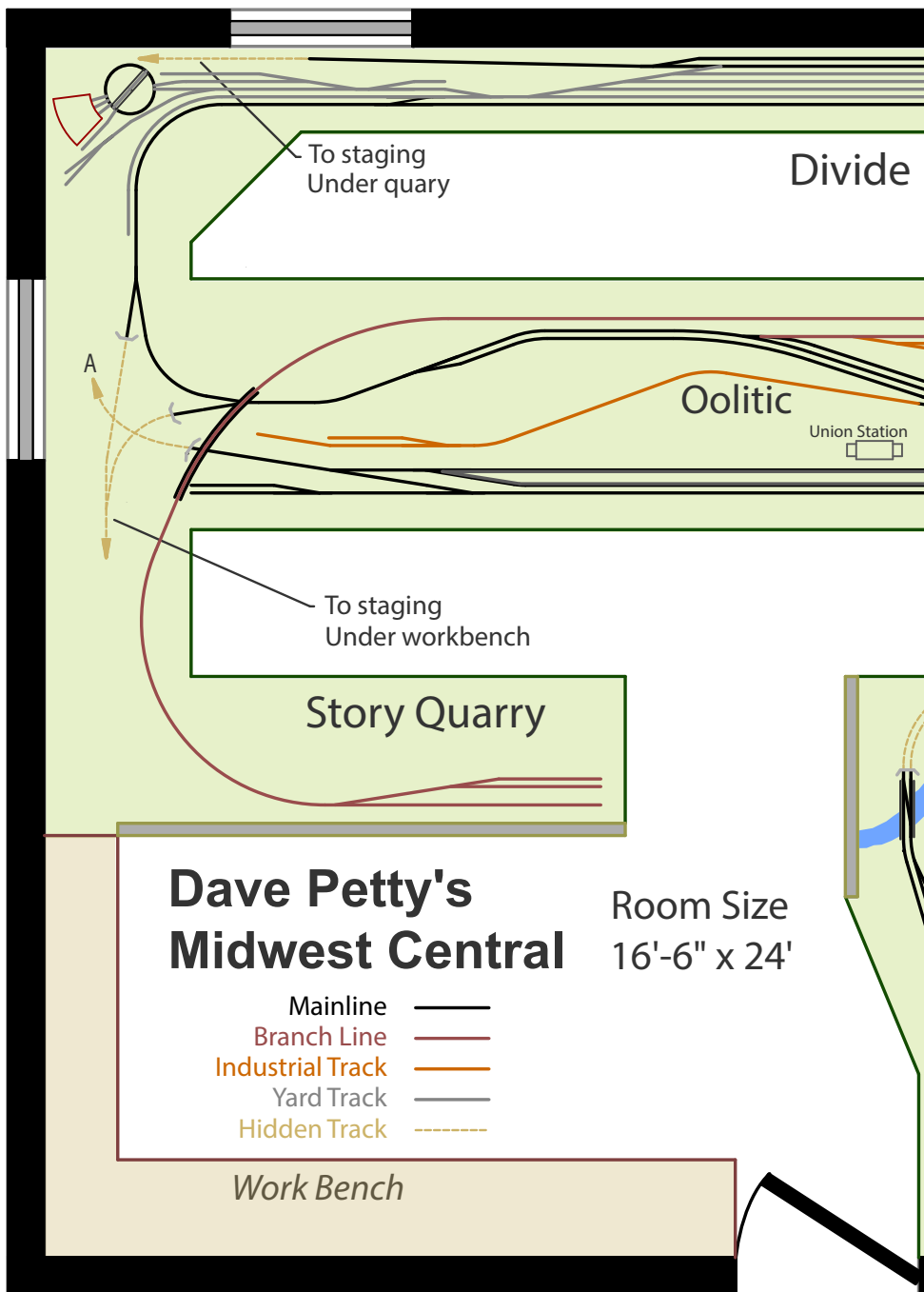

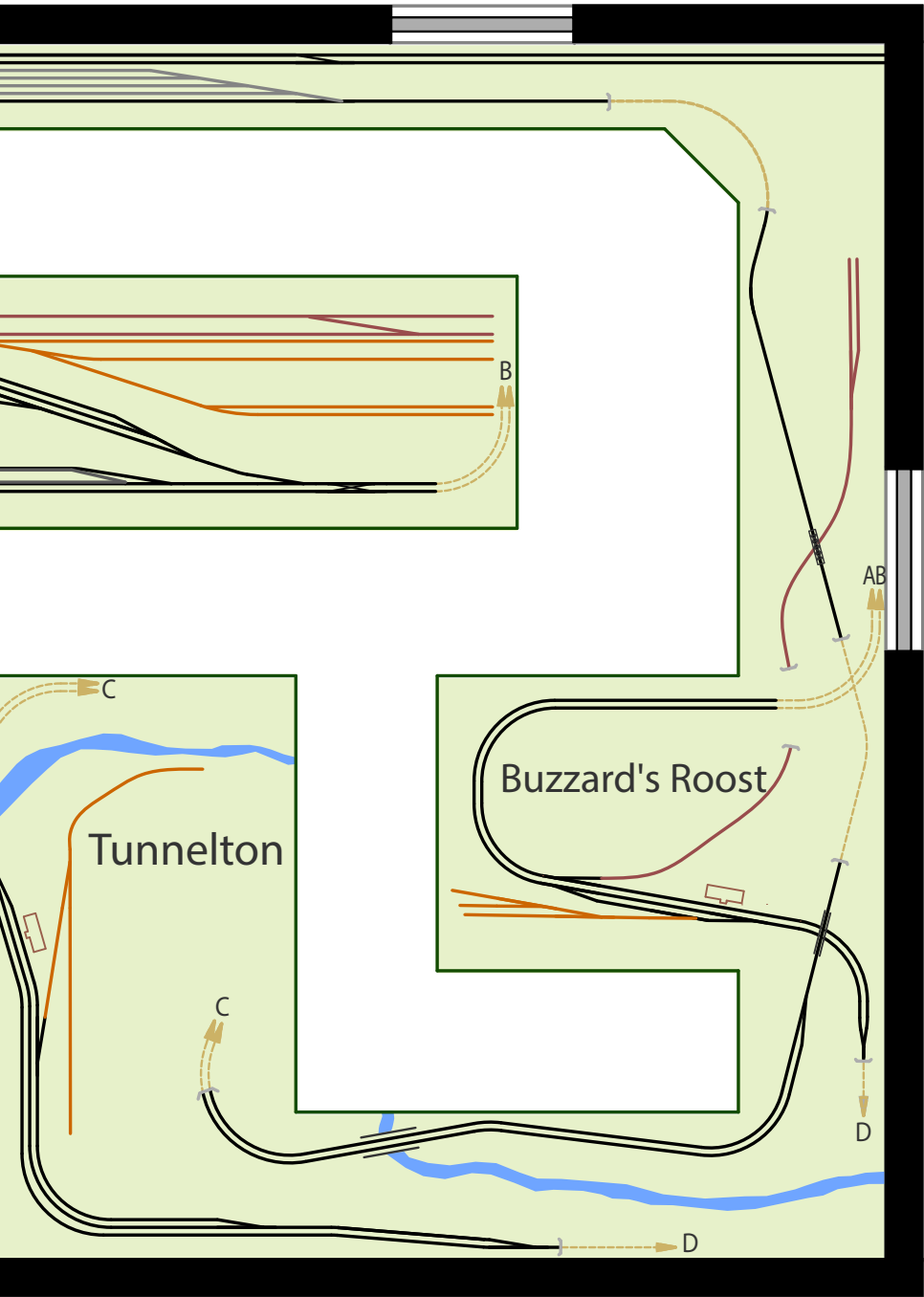

DAVE PETTY

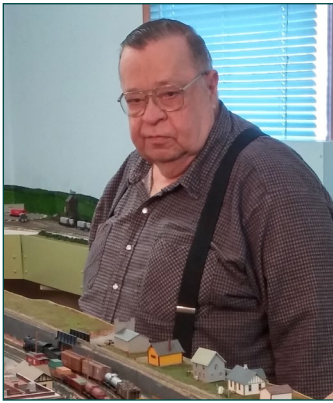

Dave shared a Lionel train set with his older brother as a child. Dave's dad made sure the boys always had a place for the train, so Dave grew up used to having a model train around.

Once Dave got married and had a home of his own, he again wanted a model train like he was used to having, so he got an HO train set. He didn't have room to do much with it. Once

N scale came on the scene and could do a lot more in a small space, Dave was hooked!

Dave has built several N scale layouts. He started his latest layout shortly after DCC was introduced, and he devised, along with a friend, a unique way to power his cab-control wired layout with DCC decoders so he could take advantage of Digitrax wireless walkaround throttles.

Today, with N scale decoders becoming small enough to easily fit into an N scale loco, Dave now runs his Midwest Central with decoders in the locos and has fully converted to DCC. Dave also likes building structures, so his layout has a lot of examples of his work.

Dave is retired and lives a few miles from his son and daughter. Dave enjoys photography and plays keyboard and loves to travel the United States. He has visited 48 states and slept in 47! ■



[Click here for reader comments](#)

TRAINMASTERS.TV

Dave Petty layout tour



Brought to
you by

MRH
MODEL RAILROAD HOBBYIST

Non-members can watch for
only \$1.49 per segment



**Coming
later in
March!**

Visit the TrainMasters TV website



Introduction to the puzzle of switching

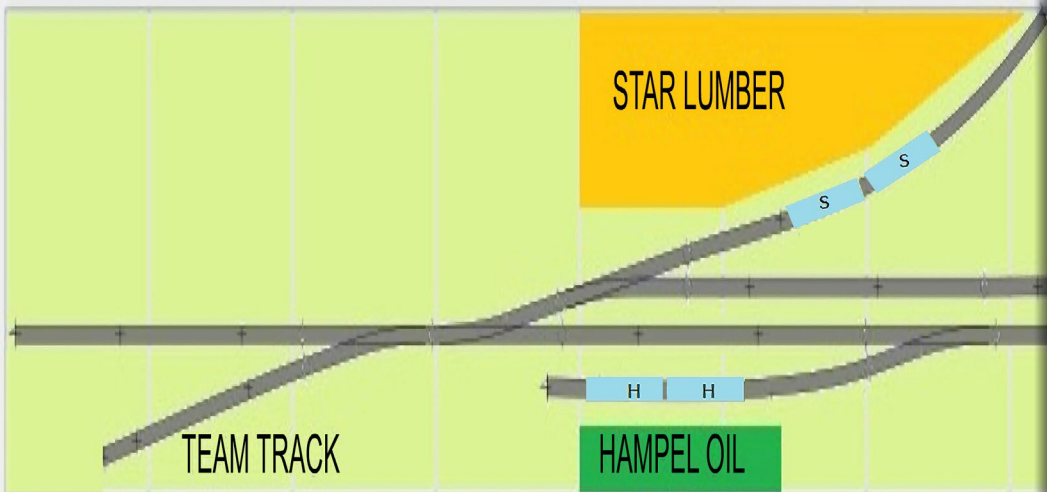

BY GREG BAKER

Can you solve it? ...

ONE THING THAT ALWAYS FASCINATED ME about railroading was figuring out why railroads did what they did. Before I worked for the railroad it seemed like a big puzzle that had no real answer to explain it all. I could assume things were done because of this or that, but not until I started my career as a railroader did things really start to make sense.

Once working for the railroad I learned who makes the decisions to spot cars, what order they are spotted, why some locations are switched daily and some may see a car a couple of times a year. Now I cannot speak to every situation or to every railroad practice, but there are some basic operations that occur on all railroads that can help the modeler make more realistic moves when switching on their layouts.



[Click here for
reader comments](#)

In my professional career as a Manager of Safety and Training, my main purpose is to promote safety through initial and continued training. This means that I get to take people from off the street and teach them the basics of the safety rules, railroad operations, and switching safely and efficiently. Now, I know most people who have a model railroad do not want to get bogged down in a rules classes and exams but adding some of the practices from the prototype can increase the challenge of switching a layout.

After safety, efficiency is the most important thing on the railroad. For many on the railroad the safety part is easy to understand – follow the rules. When it comes to efficiency many people get hung up on the concept and fail to see the “smart move.” There are many ways to switch every location, but usually there is one way that optimizes the moves, which include not having to walk excessively, tying unnecessary handbrakes, or throwing switches.

With all these things in mind I tend to look at track arrangements in a different way than a model railroader does. Although things may appear to be simple, it does not take much to complicate matters in a realistic manner. By following the safety rules and best practices, something as simple as a runaround and a few spurs can keep someone busy for a very long time.

Star Lead

In this planned first installment of Prototype-Based Switching Puzzles I wanted to take a minute to show how simple and how complicated the same track arrangement can be. In both scenarios you will be handling the same number of cars, but as you will see, one takes quite a few more moves than the other. Every day on the railroad is different and even though you may have switched this area the day before, a new puzzle awaits you every time you lace up your boots and come to work.

The Star Lead is in Wichita KS and was part of the Atchison Topeka and Santa Fe route from Wichita to Kingman KS. The line was sold off in the 1990s to a short line and soon after the sale the line between Kingman up to its current location was removed. It currently serves two regular customers but has been used for a few special moves on a short spur track. The two customers served along the track are Star Lumber, which receives loaded centerbeams and boxcars. The other customer is Hampel Oil which ships tank cars of oil.

To get to these customers the train leaves the Orient Yard and heads out the north leg of the wye that originally connected with the Missouri Pacific. This is now all owned by the same short line. They then cross over the old MP branch line, which is protected by a swinging gate. The tracks then cross over a four-lane divided highway out to the location shown in the drawing below.

Rules of the Game:

With anything on the railroad there are rules that must be followed. These puzzles are no exception.

THE PUZZLE OF SWITCHING | 4

- 1) No kicking, dropping or gravity switch moves allowed.
- 2) The runaround will only hold four cars in the clear.
- 3) The distance between the end of track and the runaround switch is five car lengths.
- 4) Between the opposite runaround and over the crossing at grade is five car lengths.
- 5) Do not leave cars fouling the crossing at grade.

The BLACK box represents the locomotive, the ORANGE boxes are for Star Lumber, GREEN boxes for Hampel Oil, and BLUE boxes are cars that need to be pulled. The letters in the BLUE box represent what track they were released from.

Scenario 1: Switching basics

In this scenario we will introduce the basics of running around, spotting and pulling cars. The train consists of a locomotive and four cars. There is one boxcar and one centerbeam that will need to be placed on spot at Star Lumber. The two empty oil cars will need to be spotted at Hampel Oil.

Along with spotting cars, there are cars at both locations that are released that need to be returned to the yard. On spot at Star Lumber are two empty centerbeams, and at Hampel two loaded hazmat tank cars. When the train is complete the locomotive must be on the end nearest the crossing at grade with the hazmat cars at the rear of the train.



[Click here for
reader comments](#)

THE PUZZLE OF SWITCHING | 5

See how many moves it will take you to complete the job.

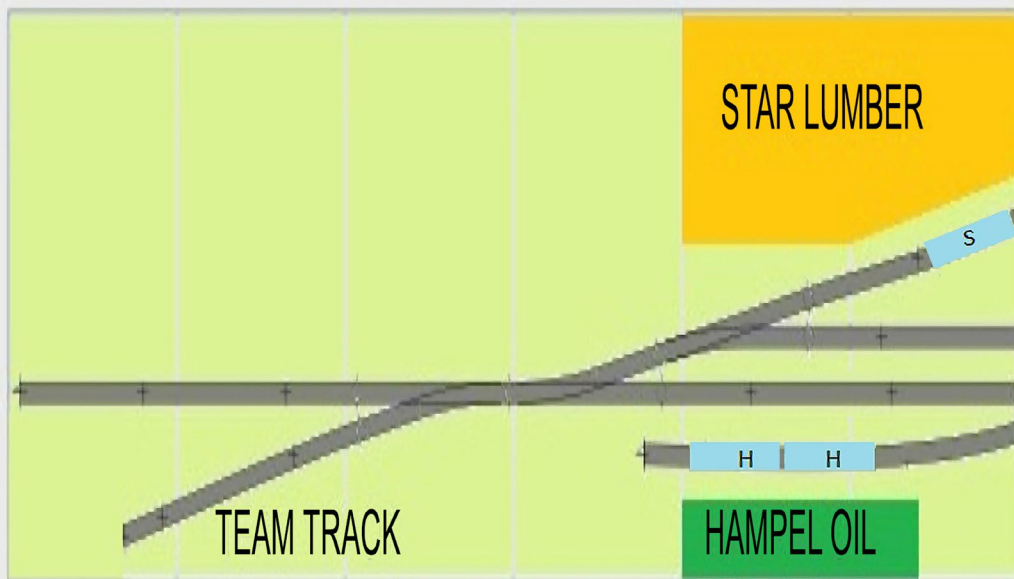

I was able to complete the job in 19 moves. How about you?

Scenario 2: Something a bit more

One thing that train crews have to contend with is train placement. Without bogging things down in regards to regulations I will keep things clearly defined in the rules.

Again there are four cars to spot. This time they include two Star Lumber cars, one Hampel empty and one empty flat car. There are also four cars that need to be picked up. They include two empty cars from Star, one loaded hazmat car from Hampel, and one loaded flat from the team track. The one wrinkle is that the load from the team track is a shiftable load and must not be placed next to the hazmat or next to engine. Also, the hazmat cars must be as far from the head end of the train as possible.

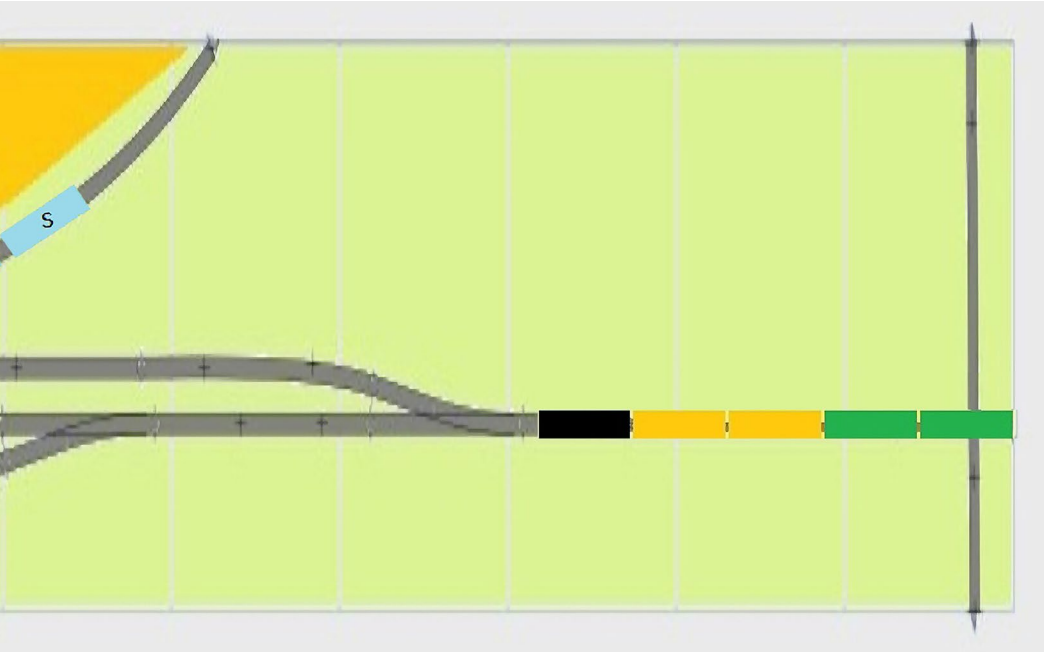

**Want to help keep
MRH free?**

Then *click* on ads!

THE PUZZLE OF SWITCHING | 7

I was able to complete the job in 31 moves, how about you?

Scenario 2 setup: Pick-up the light blue cars and spot the colored cars at the industry matching the colors of the cars (turquoise car goes to the team track). The answer will be in the subscriber downloads for March. When done, make sure the loco is on the far right front of the train and the H car is on the back end. The T load is shiftable and must not be next to the loco or the H load.

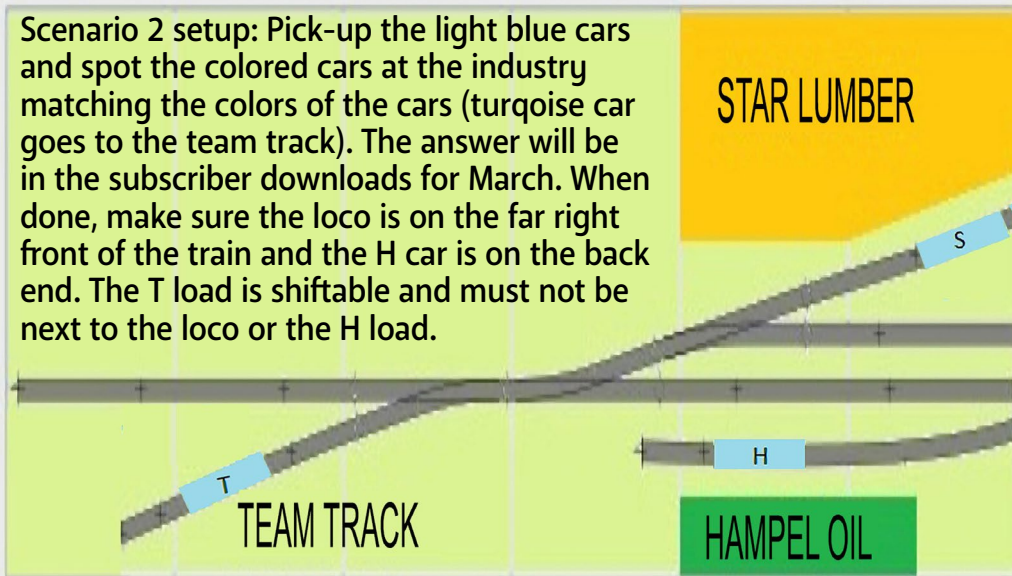

GREG BAKER

Greg Baker has been serious about model railroading since 2000, but as long as he can remember he has been fascinated by trains.

Greg's main interests are the railroads of Central Oregon in 1968, with the focus on the Spokane, Portland & Seattle, Great Northern, and the Union Pacific along the Oregon Trunk. He is also interested in the City of Prineville Railway and its connection to the Oregon Trunk.

THE PUZZLE OF SWITCHING | 8

Note: We will post the answers in the March subscriber bonus downloads.

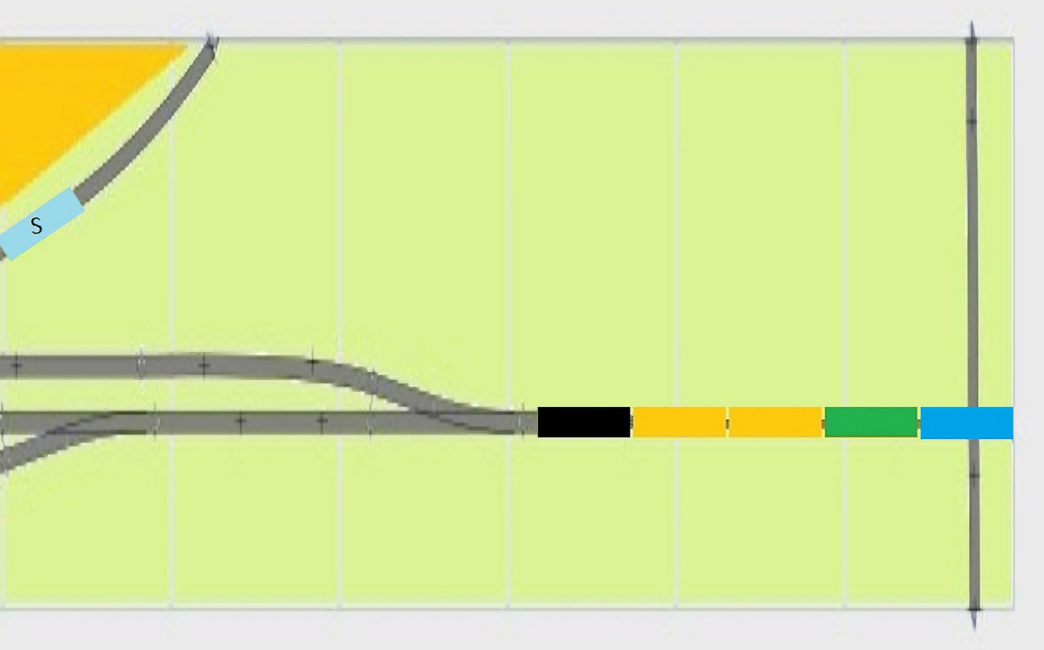

.....

He currently resides in Lewiston, Idaho, with his wife and two children as he continues his career in railroading. He is actively involved in promoting Free-mo and has created an Idaho Free-mo group. ■



**Click here for
reader comments**

**The Fine Scale
Model Railroader Expo**

DANVERS, MA

2016

MARCH 31 - APRIL 2*

***VENDOR SHOW 4/1-4/2**

**FIND OUT HOW TO WIN
\$1000 CASH**

IN THE EXPO MODEL CONTEST

CLICK HERE FOR MORE INFO

**CLINICS - LAYOUT TOURS - DISPLAYS
VENDOR SHOW - AWARDS DINNER**

MODELRAILROADEXPO.COM

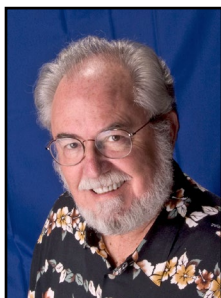

Model Railroad Hobbyist | March 2016 | #73

MARCH NEWS

column

RICHARD BALE *and* JEFF SHULTZ



**Click here for
reader comments**

Berkshire Junction Electronics For Sale

The owners of Berkshire Junction of Adams, MA, are selling the electronic portion of their specialty business. Product lines for sale include operating traffic lights, FRED units, block occupancy detectors, auto reversing unit, arc welding light, campfire light, and a three-way turnout matrix. Berkshire Junction will continue to supply the EZ Line of flexible thread popular with hobbyists for use in simulating rope, ship rigging, electric lines, and telephone lines. For additional information phone 413-743-3960 or send an inquiry to info@berkshirejunction.com ...

Call for Clinicians

Sponsors of the New England/Northeast Prototype Modelers meet scheduled for June 3-4, would like to hear from any

▶ THE LATEST MODEL RAILROAD PRODUCTS, NEWS & EVENTS

• INDEX

• TABLE OF CONTENTS

MARCH NEWS | 2

experienced modeler interested in presenting a clinic at the event which will be held this year in Enfield, CT. Qualified individuals can obtain additional information by contacting Dave Owens at neprotomeet@gmail.com ...

End of the Line for RMT

RMT - Ready Made Trains, a supplier of O gauge and O-27 rolling stock and accessories has announced that it will cease all operations by the end of April. The shutdown is prompted by the retirement of Walther Matuch, president and founder of the company. All existing orders and any new orders placed online through the end of March will be honored. Some one-of-a-kind items including more than 10 years of RMT pre-production samples, product test shots, and samples from other model train manufacturers are also for sale on line. For additional information visit readyma-detoys.com.

NEW CLUB CARS



NMRA Cincinnati Division 7 is selling a kit for this Chesapeake & Ohio 40-foot USRA single-sheathed wood boxcar. The prototypes were built with Murphy 5/5/5 corrugated steel ends, and 6-foot National wood doors. C&O rebuilt many USRA cars in 1931 including those represented by this model. The HO scale kit is based on Accurail's 4300 series. For ordering information visit cincy-div7.org/projects.html.

MARCH NEWS | 3



The Richmond, Fredericksburg & Potomac Railroad Historical Society is selling custom decorated HO scale Kadee boxcars.

Items currently available include a 40-foot steel boxcar with 6-foot Youngstown doors. The ready-to-run model is available in the 1960-era scheme with the map herald on the right and the full road name spelled out on the left side. For more information go to rfandp.org/companystore/#kadee40.

.....

NEW PRODUCTS FOR ALL SCALES

The **Anthracite Railroads Historical Society** is selling *Central Railroad of New Jersey Steam Locomotive Planbook-Postwar Power*, by V.S. Roseman. The 110-page book contains HO scale diagrams, plans, and related photos of every class of CNJ steam engines operating in the post World War II period. Tenders are shown for each class. The author has included lettering information and a 1945 roster of CNJ steam motive power. The book is available at \$25.98 plus \$6.00 shipping direct from ARHS, PO Box 519 Lansdale, PA 19446.

.....

Morning Sun Publications has released a digital reprint of *Detroit, Toledo & Ironton Railroad*, by David Hickcox and Dale A. DeVene Jr. The publication was originally released as a hardback in 2001.

New hardback books available now include *Western Canada Rails* by Bob Davis, *Milwaukee Road Locomotive Portfolio* edited

MARCH NEWS | 4

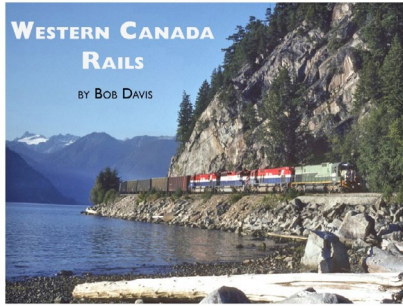
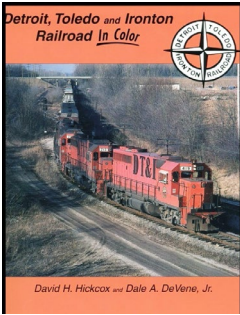

by Stephen Timko, and *Chicago & North Western Power 1963-1995 Second Generation Roadswitchers*,

also by Timko. *Trackside Around Rochester 1970-1980* by Daniel Orr and Greg Marling, and *Logging Railroads of the Pacific Northwest: Volume 1 Washington State* by Gary Durr have also been released. The books are available through dealers or direct at morningsunbooks.com.

.....

Atlas Model Railroad Company has issued a comprehensive 275-page catalog titled *The Ultimate Guide to Atlas Model Railroad Products*. In addition to new product information, the 275-page publication contains a complete visual guide to Atlas track, layout plans, and accessories. It is available at \$9.95 from Atlas Model Railroad Company, 378 Florence Ave., Hillside, NJ 07205. A PDF version of the catalog is also available online at atlasrr.com.

.....

O SCALE PRODUCT NEWS

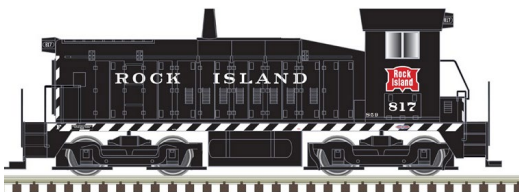

Atlas O has scheduled the release of an Electro-Motive SW locomotive during the fourth quarter of this year. Road names for the SW-8 include

Canadian National and Rock Island. The SW-9 will be available

MARCH NEWS | 5

for Indiana Harbor Belt, M-K-T, and Santa Fe. The SW-900 will be available decorated for Raritan River. Road names for the SW-1200 will for Southern Pacific and Cotton Belt. Each version of the O scale ready-to-run model will be available for either two-rail or three-rail operation.



New Atlas O rolling stock due for release during the third quarter includes a group of 50-ton twin-bay war emergency composite

hopper cars. Road names with new road numbers will be Pennsylvania, Santa Fe, Atlantic Coast Line, Burlington, Illinois Terminal, and Union Pacific.



Also scheduled for release during the third quarter are 40-foot 1937 AAR boxcars. The O scale ready-to-run models will be equipped

with double Youngstown sliding doors. Road names will be Canadian National, Santa Fe, Soo Line, Southern Railway, Southern Pacific, and Union Pacific. All Atlas O rolling stock is available for either two-rail or three-rail operation. For additional information contact a dealer or visit atlaso.com.



Bachmann Trains' recent release schedule includes an On30 Whitcomb 50-ton center-cab industrial diesel. The model comes DCC-equipped with a dual-mode NMRA-compliant decoder

MARCH NEWS | 6

for speed, direction, and lighting. The ready-to-run locomotive is available decorated for Midwest Quarry. Painted but unlettered models are available in orange and cream, yellow with black stripes, and red and yellow. Sound can be added with the installation of Bachmann's 16-bit Tsunami sound module that is sold separately. For additional information contact a dealer or visit bachmanntrains.com.

.....

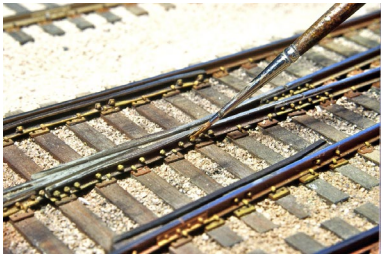

Red Cliffs Miniatures sells prototypically accurate cast-brass ¼-inch scale P:48 turnout components including frogs, point sets, and guard rails in code 83, 100 and 125. For additional information visit redcliffsminiatures.com.

.....

HO SCALE PRODUCT NEWS



model is based on a prototype built in 1977. The kit has an MSRP of \$18.98.



New kits available from **Accurail** include this Montana Rail Link Pullman-Standard 4750 cu.ft. triple-bay grain hopper. The HO scale

Also new from Accurail is a kit for this Soo Line 70-ton triple-bay open hopper with offset sides. It is based on a Soo Line

MARCH NEWS | 7

car built in 1948 and rebuilt in 1959. The model is representative of the more than 32,000 prototypes built to AAR standards by several car builders between 1938 and 1960.



In addition to the Pittsburgh & West Virginia version shown here, Accurail is offering a kit for this twin-bay hopper decorated for Maine

Central. The distinctive feature of this coal car are the offset sides. The hard-working P&WV car was built in 1947 and rebuilt 13 years later.



Accurail's current availability list includes a kit for this Santa Fe 40-foot six-panel single-sheathed wood boxcar. Like the prototype,

Accurail's HO scale version has a steel fish belly underframe, steel Dreadnaught ends, and Youngstown steel doors. It follows a prototype rebuilt during WWII.



This Northern Pacific 40-foot PS-1 boxcar has Pullman-Standard ends and doors. The kit is available in a 3-pack at an MSRP of \$49.98.



Accurail is selling a kit for this 41-foot AAR 11-panel steel gondola decorated for Detroit, Toledo & Ironton.

The HO scale model is based on a prototype built in 1925

MARCH NEWS | 8

and rebuilt in 1932. The same car is also available decorated for M-K-T. All Accurail kits include appropriate trucks and Accumate couplers that are compatible with Kadee-type couplers. Unless noted otherwise, the above Accurail kits have an MSRP of \$16.98 each. More information on these products can be found at accurail.com.

.....

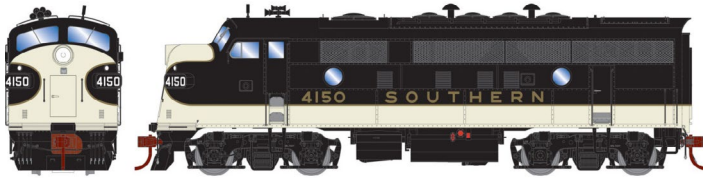

Athearn reports that a new production run of EMD

F3 and F7 diesels has been scheduled for release next January. Both A and B units will be produced. Road names will be Chicago Great Western, Southern Pacific, Santa Fe, and Southern Railway.



Road-specific features on the Genesis series models include pilots

with foot boards on SF units and a unique MU hose arrangement on Southern models. CGW locomotives will be available in both red freight and maroon passenger livery. SP models will wear the road's black, silver, and orange freight scheme.



Also coming from Athearn next January are SD38 diesel units. The HO scale models will be produced from new body tooling and will be

MARCH NEWS | 9

available with onboard sound by SoundTraxx. In addition to the Conrail unit shown above, the HO scale Ready-to-Roll model will be available decorated for Elgin, Joliet & Eastern; Penn Central; Norfolk Southern; and CSX.



Athearn's December release schedule

includes a 60-foot ICC boxcar with separately applied ladders and stirrup steps, and photo-etched crossover platforms. In addition to the CSX car shown here, road names will be Missouri Pacific, MP/UP repaint, Norfolk & Western, L&N and Chessie.



Also due in December is a 50-foot FMC boxcar with a combo door arrangement consisting of a plug door and sliding door. Road names will be Minnesota, Dakota & Western; BC Rail; Missouri Pacific; Canadian National; and RailBox.

arrangement consisting of a plug door and sliding door. Road names will be Minnesota, Dakota & Western; BC Rail; Missouri Pacific; Canadian National; and RailBox.

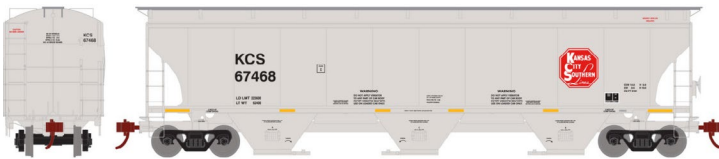

Completing Athearn's December rolling stock release is

a Trinity triple-bay covered hopper. Road names will be Union Pacific, Norfolk Southern, CPR/Soo, CMO/GATX, BNSF, Arkansas-Oklahoma Railroad, and Kansas City Southern as shown here.

A nicely detailed Ford Model A pickup truck is set for release in January. In addition to the dark green scheme shown here, the

MARCH NEWS | 10

.....



model will be available in dark blue, tan, cream, burgundy, and black.



Athearn's Roundhouse series of products scheduled for release next January includes this steel wide-vision caboose. Road names for the HO scale ready-to-run model will be

UP (shown here from a previous production run), Soo Line, CSX, Burlington Northern, BNSF, and Santa Fe.



This 34-foot twin-bay hopper car with offset sides is set for release next December in four-packs with different road numbers. The Roundhouse series model will be decorated for Northern Pacific,

Lehigh & New England, Delaware & Hudson, Chesapeake & Ohio, Chicago North Western, and Baltimore & Ohio. For additional information on all Athearn and Athearn-Roundhouse products contact a dealer or visit athearn.com.

.....

Atlas plans to blend the recently acquired BLMA signals into its existing line of HO scale signals. Atlas signals employ proprietary common-cathode circuitry while BLMA's signal system is based on a common-anode standard. Atlas is designing a control system that will support both types.

MARCH NEWS | 11

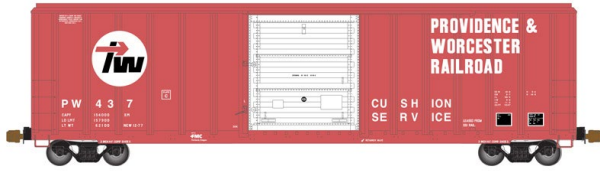

Atlas is developing a new HO scale FMC 5347 cu. ft. plate C boxcar with a single sliding door. The

initial release of the Master Line series model is scheduled for the third quarter of this year. The model features etched detail parts and separate wire grab irons. Road names on the brand new ready-to-run model will be Apalachicola Northern, CNW-Union Pacific, Delta Valley & Southern, Georgia Ports Authority, Mississippi Export, Providence & Worcester, and New Orleans Public Belt Railway.



Items scheduled for release during the fourth quarter include this Atlas H24-66 Train

Master locomotive in new paint schemes and road numbers. Built by Fairbanks Morse, the big six-axle 2,400 hp prototype was used in both passenger and freight service. New road names on the Atlas HO scale version will be Chicago & North Western, Milwaukee Road, New Haven, and Southern Railway. Previously released road names due at the end of the year in new numbers are Pennsylvania, Virginian, and two Southern Pacific schemes: dark gray with a scarlet face; and black, silver and orange. Atlas Master Silver series models will be available with an NMRA eight-pin plug to accommodate an aftermarket DCC decoder (not supplied). The Atlas Master Gold series version comes with a LokSound select dual-mode decoder that allows operation on DCC- or DC-powered layouts.

MARCH NEWS | 12

.....



Additional new models due to be released during the third quarter include a Trainman

series Thrall 4750 cu. ft. triple-bay covered hopper. Road names will be Richmond, Fredericksburg & Potomac; The Andersons; Chicago & North Western; Milwaukee Road; Route Rock; BNSF (wedge), Chicago Freight Car-Ann Arbor; CSX; and Norfolk & Western.



Atlas has included a kit for an HO scale 1937 AAR 40-foot boxcar in its second quarter release. Features of

the easily-assembled model include a one-piece underframe with full brake detail, prototypical decorating schemes, and molded-on ladders and grab irons. Road names with multiple numbers will be available for Chesapeake & Ohio, Ontario Northland, Pittsburgh & Lake Erie, Santa Fe, Seaboard Air Line, and Southern Pacific. The kit will have an MSRP of \$22.95. Information on Atlas products can be found at atlasrr.com.

.....



Bachmann Trains has an HO scale EMD GP38-2 decorated for Santa Fe, Norfolk Southern, CSX, Alaska, and Canadian

Pacific. The ready-to-run model is equipped for DCC that includes

MARCH NEWS | 13

a SoundTraxx 16-bit diesel sound package that provides prime mover, three air horns, and a bell. An analog DC version of the model is also available. For additional information contact a dealer or visit bachmanntrains.com.

.....

Bowser owner Lee English provided MRH with a progress report on the HO scale Alco RS-3 project. The basic body design is done but considerable research remains to finalize all the different versions. Tooling for the RS3 body and details will be completed at Bowser's Pennsylvania plant. The electronics and chassis, which must accommodate both CP's chop nose as well as standard bodies, is being developed at the factory in China. No dates yet but the Phase 3 body version is scheduled to be released first. Eventually all Canadian and US versions will be offered.



Meanwhile, work continues on Bowser's HO scale Alco Century C-636 with a release date set

for October. Reservations are being accepted through March 11. DCC/Sound versions will be equipped with a LokSound Select decoder. Standard DC versions of the C-636 will have a 21-pin plug to simplify installation of an aftermarket decoder (not supplied). Legitimate road names will include the Alco demonstrator shown here; Spokane, Portland & Seattle; Burlington Northern; Illinois Central; and Penn Central. Bowser will also offer the C-636 in a series of fantasy road names including Delaware & Hudson, Lehigh Valley, Pennsylvania Railroad, Union Pacific, Erie Lackawanna and Milwaukee Road.



Bowser will release another run of its popular class H30 triple-bay covered hopper car next December.

Advance reservations are scheduled to close on March 25th. The HO scale ready-to-run model will have separately applied grab irons, detailed underframe and piping, and appropriate trucks with metal wheels. Additional details include either the original style of roofwalk or the later raised roofwalk as appropriate to the individual decorating scheme. Road names with original roofwalk will be PC (MOW yellow), PRR (gray with circle keystone), PRR (red with circle keystone), PRR (gray, keystone), and PRR (gray, shadow keystone, above). Models with raised roofwalk will be available for PC (green), PRR (gray with circle keystone), PRR (gray, no keystone), PRR (gray with shadow keystone), and PRR (red with circle keystone). For additional information contact a dealer or visit bowser-trains.com.

.....

The Coach Yard is taking reservations for future delivery of several versions of Baldwin 2-8-8-2 steam locomotives. The HO scale models will be hand-crafted in Korea. The production schedule calls for Union Pacific class MC-1 number 2000, Oregon Railroad & Navigation class MC-1 numbered 450-452, and Norfolk & Western class Y-1 numbered 995-99. For details visit thecoachyard.com.

.....

Fos Scale Models is selling a craftsman-style kit that builds into Carter Supply, a small dealer of paint and hardware. Features include scribed walls, laser-cut clapboard walls, Tichy plastic windows and doors, rolled and corrugated roofing material, metal and plastic details, and color signage as shown in the above

MARCH NEWS | 15



photo. Figures are not included. The assembled model has a footprint of 5 by 6 inches. For additional information visit fosscalemodels.com.



Firecat Designs has resin kits for three modern HO scale 100-ton log cars. The kits include cast-resin components,

3D-printed detail parts, hardware, and custom decals. Trucks and couplers are not included. Currently available are kits for National Steel Car (originally used by BC Rail/Pacific Great Eastern, above), Portec (for pulpwood service), and Evans Manufacturing (originally in service for Federal Paperboard). For additional information visit firecatdesigns.com.



Hornby America has two new HO scale Rivarossi 50-foot boxcars available. Cars with a Youngstown

sliding door are decorated for Chicago, Burlington & Quincy and Great Northern.



Road names on Rivarossi boxcars with a plug door and no running board include

MARCH NEWS | 16

Reading, Soo Line, and Union Pacific. For additional information contact a dealer or visit hornby.com.



InterMountain is producing an HO scale EMD GP16 from all new tooling. The initial release is

expected in August or September of this year. The prototype GP16 resulted from rebuilding aging GP7, GP9, and GP18 units. The essential changes involved rebuilding the underframe, replacing the dynamic brakes and DB housing with a type 26L brake system, lowering the nose to improve visibility, and replacing the prime mover with an EMD 1600 hp model 645 diesel engine which gave rise to the GP16 designation. Road names on InterMountain's HO scale version will be Aberdeen, Carolina & Western; Burlington Junction Railway; South Carolina Public Railways; Santa Fe Southern (modified Kodachrome scheme); Buckingham Branch Railroad; and South Central Florida. Both DC and DCC versions of the ready-to-run model will be available.

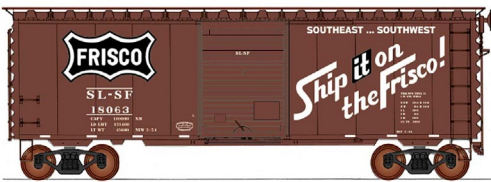

Also due from InterMountain late this summer is a group of 40-foot PS-1 boxcars. Pullman-Standard built thousands of

PS-1s from the late 1940s through the early 1970s with large numbers of the iconic car continuing in service for many years. The HO scale ready-to-run model will have etched-metal running boards, Kadее couplers, and appropriate trucks with metal wheelsets. Road names will be SL-SF Frisco, Ann Arbor, M-K-T, Lake Superior & Ishpeming, Norfolk & Western, Mississippi Central Railroad, Port Huron & Detroit, Central of New Jersey, and

JMARCH NEWS | 17

four variations of Santa Fe – Grand Canyon, El Capitan, Chief, and Super Chief.



Due this fall is a new run of InterMountain SD40-2 locomotives in ten new paint schemes.

In addition to Illinois Terminal shown here, road names will include Union Pacific, Canadian Pacific, Soo Line, FURX-First Union Rail, G&W/Indiana Southern, Foster Townsend Rail Logistics, SKOL-South Kansas & Oklahoma, SLWC-Stillwater Central Railroad, and HLCX-Helm Leasing.



Also due this fall is a release of HO scale stock cars produced from Red Caboose tooling. Southern Pacific cars will

be available in the pre-1946 scheme (above) and the 1946-47 scheme (below).



A 1952 SP stock car both with (below) and without an extended letter board are also in the mix.



Additional road names on this release will be Northwestern Pacific, Texas & New Orleans (pre-1946 scheme and post-1956 scheme), and Western Pacific. The HO scale ready-to-run model will have Kadee couplers and metal wheelsets.

MARCH NEWS | 18

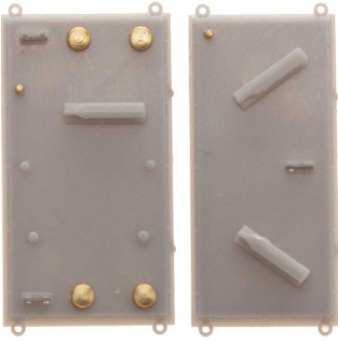

InterMountain is now selling the PTC antenna array used on its UP ES44AC locomotive as a separate detail item. In accordance with government-mandated regulations that become effective in late 2018, a PTC-compliance antenna will be required on all locomotives operating within the US. InterMountain's PTC Antenna Array,

item P44701, is available now at an MSRP of \$6.95. For more information on all InterMountain Railway products, contact a dealer or visit intermountain-railway.com.



New HO scale freight cars coming from Kadee Quality Products in May include a 40-foot PS-1 boxcar decorated for Richmond, Fredericksburg & Potomac. The HO scale model represents a prototype car with 10-panel welded sides, narrow bolster tabs, and 6-foot Youngstown doors.

& Potomac. The HO scale model represents a prototype car with 10-panel welded sides, narrow bolster tabs, and 6-foot Youngstown doors.



Also due from Kadee in May is a SSW 40-foot PS-1 boxcar with a wide bolster tab and an 8-foot 6-panel Superior doors.

The car is decorated with a Cotton Belt Blue Streak Fast Freight slogan. A car commemorating Kadee's 70th Anniversary will also be released in May. For more information contact a dealer or visit kadee.com.

MARCH NEWS | 19

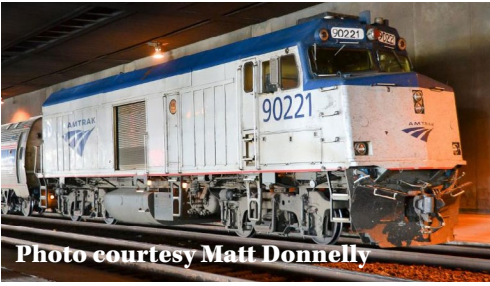
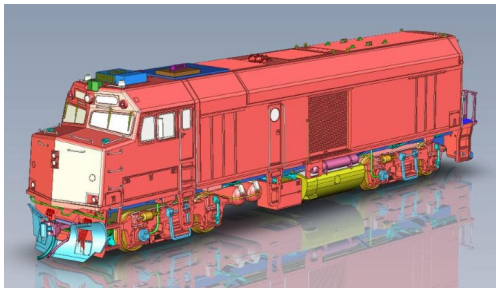

Photo courtesy Matt Donnelly

Rapido Trains has announced plans to produce an HO scale Amtrak ‘Cabbage’ – a nickname applied to an F40PH that has been converted to a combination cab control unit and baggage car. In the

1990s Amtrak removed the prime mover, generator and traction motors from some F40PH locomotives converting them to cab units. Designated NPCU (non-powered control units) they were employed in push-pull service, and eliminated the need to turn a train at terminals, yet still provided the front-end beef to protect operating crews. The conversion included the installation of a large roll-up baggage door on each side. As a cab-baggage combo unit they quickly acquired the nick name Cabbage. Prototype 90221 is shown above in Amtrak Phase 5 scheme.



Unlike the prototype, Rapido’s HO scale version will be fully powered with operating ditch lights, enlarged marker lights, supplementary air reservoirs and other details unique to NPCU. Five decorating

schemes will available including Amtrak Phase 3, Phase 4, Phase 5 (Swoosh), Amtrak California, and undecorated.

Also under development at Rapido is an HO scale FL9 rebuild decorated for Amtrak Phase 3, Maine Eastern, Metro North (silver/blue/red), Metro North (silver/blue), ConnDOT (New Haven), and Metro North (New York Central). The prototypes’ diesel units

MARCH NEWS | 20



were rebuilt for HEP service in the 1980s. Rapido's version will reflect all of the changes including correct HEP roof details, front and rear HEP receptacles, and optional operating ditch lights. Air horns will be appropriate to road

names. Delivery is planned for the first quarter of 2017 with an order deadline of July 1, 2016. Both DC and DCC models will be available. For additional information on all Rapido products, contact a dealer or visit rapidotrains.com.



ScaleTrains.com is selling two types of HO scale 53-foot CIMC-China International Marine Containers. Both corrugated dry containers and refrigerated containers are in this initial release from the company's Operator line of products. Each road name is available in 12 numbers. Dry containers are available decorated for Marten, EMP, Fedex, Schneider, and J.B. Hunt.



Reefer containers are available for J.B. Hunt, J.B. Hunt Intermodal, Canadian National, C.R. England, and Quiktrax. Reefer containers are also

available with the digitally recorded sound of a Thermo-King

MARCH NEWS | 21

refrigeration unit. For more details including ordering information visit scaletrains.com.

.....

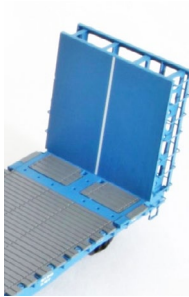
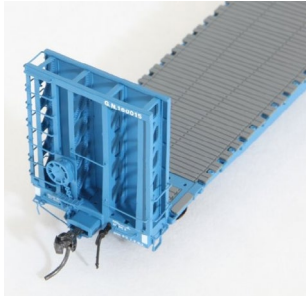

Tangent Scale Models has released a bulkhead version of its highly regarded General Steel Castings 60-foot flatcar. The HO scale model faithfully replicates prototypes of a 1969 Great

Northern rebuild program. In addition to Tangent's usual attention to detail, notable features of the ready-to-run model include wire grab irons, coupler lift bars, air hoses, Kadee couplers, and trucks with metal wheels. Variations appropriate to the prototype being modeled include end of car cushioning devices or standard draft gear. Decorating schemes include Great Northern (1969-era Sky Blue) and Atlantic Coast Line (1964 black). Additional options include an undecorated model in primer gray, and an unpainted kit. For additional information including ordering instructions visit tangentscalemodels.com.

.....



Walthers has completed a new production run of its popular 53-foot steel gondola with corrugated sides. Two car num-

bers each are available for Santa Fe, Great Northern, Burlington Northern, Southern Pacific, Conrail, Union Pacific and Conrail. The HO scale ready-to-run model comes with appropriate trucks with 36-inch turned metal wheels.



Two types of pre-painted and weathered scrap loads for the above gondola are available separately. They include baled scrap (left) and rusted heavy scrap metal.

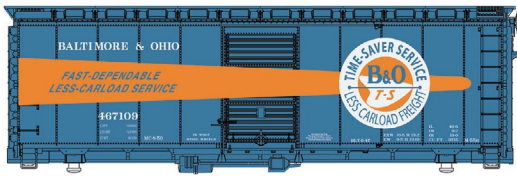

Walthers is quoting a June release date for a 40-foot AAR 1944 boxcar. Features include 4/4 Improved Dreadnaught ends and 6-foot Youngstown sliding doors. Road names for the Mainline series ready-to-run model will be Elgin, Joliet & Eastern; Central Railroad of New Jersey; Chesapeake & Ohio; Minneapolis & St. Louis; Southern Pacific; and Baltimore & Ohio.



A new group of 53-foot Singamas containers are scheduled for release next month. In addition to APL shown here, decorating schemes will be Alaska Marine Lines, Canadian National, Canadian Tire, Crowley, Matson, Sea Star, and C.H. Robinson. These containers are compatible with Walthers 53-foot well cars (sold separately). For additional information on all Walthers products contact a dealer or visit walthers.com.

N SCALE PRODUCT NEWS

Athearn has projected a late-December release date for a new production run of N scale 50-foot FMC boxcars with both a plug and

MARCH NEWS | 23



sliding door on each side of the car. Road names for the ready-to-run

model will be MD&W-Minnesota, Dakota & Western; BCR-Bay Coast Railroad; MP-Missouri Pacific; and CN-Canadian National. Also both early (above) and late RBOX-RailBox schemes. For additional information on Athearn products contact a dealer or visit athearn.com.

.....



Atlas is planning to release its N scale Train Master locomotive in new paint schemes and road numbers during the third quarter of this year. Built by Fairbanks

Morse, the big six-axle 2,400 hp prototype was used in both passenger and freight service. Road names on the Master Line ready-to-run model will be Pennsylvania, Virginian, Chicago & North Western, Milwaukee Road, New Haven, Southern Railway, and two Southern Pacific schemes: black, silver and orange, and dark gray with a scarlet face. The model will be available for standard DC operation. It will also be available equipped with a decoder for DCC operation.



Atlas has scheduled a second quarter release for a 40-foot PS-1 boxcar with a sliding 7-foot Pullman-Standard door. The Master

MARCH NEWS | 24

series model comes with Barber S-2A 50-ton trucks with metal wheels, separately applied ladders, and an etched-metal running board. Road names will be Akron, Canton & Youngstown; Bangor & Aroostook; Maine Central; New Haven; Nickel Plate Road; Rio Grande; and Western Pacifics.



The first new Atlas product to be produced from tooling acquired from BLMA will be an N scale 3500 cu. ft. triple-

bay Dry-Flo covered hopper. Features include separately applied brake detail, chemically etched brake platform, and 70-ton ASF Ride-Control trucks. In addition to the Dow car shown here, road names scheduled for release during the third quarter will be Chicago, Burlington & Quincy; Chicago Great Western; Louisville & Nashville; Northern Pacific; and Santa Fe. For additional information contact a dealer or visit atlasrr.com.

.....

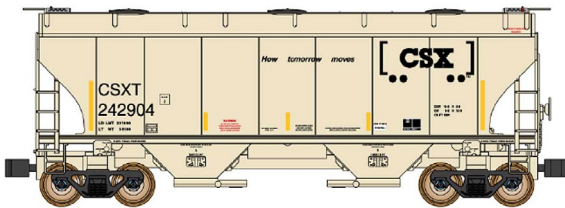

InterMountain reports that a new production run of N scale Trinity 3281 cu. ft. covered hoppers will be released some-

time in August or September. Features of the N scale read-to-run model include etched metal roofwalks and metal wheelsets. Road names will be Iowa, Chicago & Eastern; General American; Norfolk Southern; Suntrust Leasing-SRFX; Winchester & Western; Cemex-CMEX; Trinity Industries Leasing; Chicago Rail Leasing-CRDX; First Union Rail-WSOX; and CSXT. An undecorated model will also be

MARCH NEWS | 25

available. For information on all InterMountain products contact a dealer or visit intermountain-railway.com.



KatoUSA is developing N scale versions for two European high-speed Bullet train sets. The models represent the “Duplex” double-decker TGV (above right) and the “Lyria” single-level TGV. Both will be decorated in their 2011 “Carmillon” paint schemes with a contrasting black, white, and gray profile. The models will come in 10-unit consists, each with a powered motor car and a matching dummy on each end of the train. The end cars have been modified from previous versions with a removable coupler cover allowing the attachment of a drawbar (included with each set) for prototypical double heading. The M1 and M2 end cars are DCC-ready with six-pin decoder slots for installation of an aftermarket DCC decoder (not supplied). Delivery is expected early this summer. Reservations are required, and Kato is accepting reservations only from established hobby retailers that support the full Kato line of products. To locate a participating dealer go to katousa.com and click on Purchase then scroll down to Find a Hobby Store.



Kato has shared an early look at its N scale SDP40F. The new model is based on a prototype built by EMD in 1973/74. It was the first locomotive built specifically to Amtrak

MARCH NEWS | 26

specifications. The model will be available in Amtrak Phase I and II paint schemes beginning in April or May. To see an early production model in action, go to [youtube.com/watch?v=zIX4Afw5lJE](https://www.youtube.com/watch?v=zIX4Afw5lJE).

.....

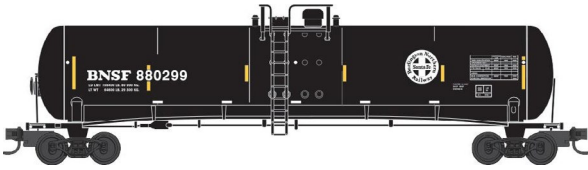

New N scale items from **Micro-Trains Line** include a BNSF 56-foot general-service tank car with

Barber roller bearing trucks. The ready-to-run model is based on a 1983 prototype.



Also new from Micro-Trains Line is a Canadian National 60-foot heavyweight Railway Postal Car. The

model, like the prototype, rides comfortably on six-wheel trucks which made it easier for postal workers sorting mail while the car was underway.



This 50-foot rib-side boxcar is decorated for DVS-Delta Valley & Southwestern, a two-mile shortline that

interchanges with BNSF in central Arkansas. Additional new N scale cars from Micro-Trains include a heavyweight RPO car decorated for Ringling Bros; A Seaboard Air Line 60-foot double plug-door boxcar, an Ontario Northland 50-foot rib side boxcar with plug doors, and a Lehigh Valley 40-foot 1½-door double-sheathed wood boxcar. For additional information on Micro-Trains Line products contact a dealer or visit micro-trains.com.

.....



Rapido Trains has announced another production run of its 52-foot 8-inch, 70-ton bulkhead flatcars. The model is based on a lumber-hauling

prototype built by Hawker Siddeley in the mid-1970s. Features of the N scale ready-to-run model include etched ladders, weighted diecast underframe, body-mounted Micro-Trains couplers, and blackened metal wheelsets. Road names include Finlay Forest Industries, and multiple schemes for BC Rail, Montana Rail Link, and Ontario Northland. Rapido is producing these cars exclusively for Prairie Shadows, an established retailer in Winnipeg, Canada. For additional information visit prairieshadows.com.

.....



ScaleTrains.com has introduced two types of N scale 53-foot CIMC-China International Marine Containers. Both corrugated dry containers and refrigerated containers (HO version shown above) are in this initial release from the company's Operator line of products. Twelve numbers are available for each road name. Reefer containers are available decorated for Tiger Cool Express,

CR England, Canadian National (green wave), JB Hunt, JB Hunt Intermodal, and Quicktrax.



Dry containers are available for Schneider, Marten, EMP, Fedex, JB Hunt, and JB Hunt

Intermodal. For more details including ordering information visit scaletrains.com.

Z SCALE PRODUCT NEWS



New ready-to-run Z scale models from **Micro-Trains Line** include this 50-foot Ontario Northland

boxcar. The ready-to-run model has plug doors and no running board. It is based on a prototype built in Hamilton, Ontario in 1990 by National Steel Car Company.



Also new is a 33-foot Western Pacific twin-bay covered hopper decorated for Western Pacific. The same model is also available

decorated for Canadian National. Other new Z scale cars from Micro-Trains Line include a group of heavyweight passenger equipment decorated for Baltimore & Ohio. A sleeper, coach, baggage car, and a dome car are all available now. For additional information about Micro-Trains Line contact a dealer or visit micro-trains.com.

NEW DECALS, SIGNS AND FINISHING PRODUCTS

Mask Island Decals is selling two new HO scale lettering sets for Rock Island freight cars. They include boxcars for hide

MARCH NEWS | 29

loading, and a 50-foot insulated boxcar with a cushion underframe. For additional information visit maskislanddecals.com.

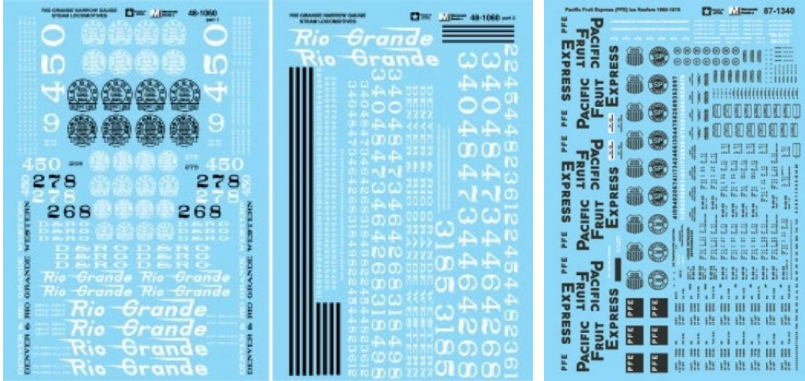

Microscale Industries has reissued some popular decals that have been out of stock for sometime. They include lettering sets for Pacific Fruit Express refrigerator cars from 1960 to 1978. Also back in stock are decals for Rio Grande narrow gauge steam locomotives and cabooses. The two-sheet NG set covers both early and late schemes. For additional information contact a dealer or visit microscale.com.



Minuteman Scale Models has a quick-acting bonding fluid that is specifically designed to weld styrene, butyrate, ABS and acrylic plastic. Called Probond, the solvent-type cement uses capillary action to weld plastic materials. It comes in two-ounce bottles with an application brush in the cap. For additional information visit minutemanscale-models.com.



Rapido Trains is now supplying the Proto-Paint line of railroad colors formerly sold by George's Trains. Forty-seven colors are currently available. Although

the emphasis is on colors used by Canadian railroads, many are also suitable for application on models of American prototypes. Additional colors are planned. It is worth noting that the item number and color are identified on the cap, which simplifies selection when jars are stored in a box or drawer. For additional information contact a Rapido dealer or visit rapidotrains.com.

.....



SEND US YOUR PRODUCT ANNOUNCEMENTS

If you are a hobby manufacturer with a product announcement, just [click here](#) and submit your announcement to us. Our web site and free magazine reach continues to grow, so get on board this new media train! ■

.....



**Click here for
reader comments**

DISCLAIMER

The opinions expressed in this column are those of the writer and do not necessarily reflect the opinion of *Model Railroad Hobbyist* or its sponsors. Every effort is made to provide our readers with accurate and responsible news and information, however, neither *Model Railroad Hobbyist* or the writer of this column can be held responsible for any inaccuracies or typographical errors that may inadvertently appear in this column.

Did you see this MRH video?



**A full-sized F7
cab in the
layout room?**

Watch the video now





BRIEFLY NOTED AT PRESS TIME ...

Jordan Jackson 1943-2016

Jordan Stanley Jackson, of Jordan Highway Miniatures, passed away February 18, at his home in Brighton, Michigan following a brief illness. He was 73 years old. The firm manufactures a popular line of HO scale plastic kits that focuses on early automobiles. The company was founded in 1955 by Jordan's father, the late Harvey W. Jackson, who named the business after his first son. The firm is expected to continue under the direction of Jordan's brother Ralph Jackson.

Rapido RDC Roadnames At Risk

According to Rapido Trains there is both good news and bad news regarding their HO scale RDC project. The good news is that preorders are strong which tends to assure that the model will generate substantial sales. The bad news is that the preorders are heavily skewed in favor of specific road names which puts less popular decorating schemes at risk of being cancelled. Road names in jeopardy are PGE, Amtrak, B&M (McGinnis), CNJ, MBTA, and PRSL. Anyone interested in these roads should reserve quickly since the window for preorders closes March 7, 2016. The models may be reserved through a dealer or direct at rapidotrains.com.

New N scale Tie System from CVM

Central Valley Model Works has introduced N scale mainline tie strips for code 55 rail. The new 1/160th scale ties offer the same opportunities for replicating authentic trackwork as CV's highly-regarded HO ties. The new self-gauging N scale ties present the accurate appearance and spacing of

prototype mainline trackwork. Although the CV ties do not include rail, the manufacturer says it is faster and easier to install the rail than any code 55 flex track currently available. The new 3001 N-scale CVT Code 55 Mainline ties are packaged as 6-piece sample packs containing 6 feet of code 55 tie material with an MSRP of \$9.85. Package of 50 feet of code 55 tie material have an MSRP of \$46.18. For additional information visit cvmw.com/cvt.htm.

Lee Riley 1947-2016

Harry Lee Riley, vice president of product development at Bachmann Trains, died suddenly on March 4. He was 69 years old. He had been active in the hobby industry for more than 50 years and planned to retire at the end of this month. Widely known in the model railroad community as an innovator, Riley was responsible for introducing numerous successful products at Bachmann including the Big Hauler large scale line, the Spectrum series of upscale models, and EZ Track for which he was awarded several patents. He will perhaps be best remembered for spearheading On30 models at Bachmann and helping that relatively new scale develop into a viable segment of the hobby.

Prior to joining Bachmann Riley was associated with Pro Custom Hobbies, and Associated Hobby Manufacturers. Riley served as a consultant for numerous manufacturers including GSB, Lionel, Life-Like Products, Model Die Casting, Model Power, TYCO, and Westside Models. As a longtime activist in the NMRA, he served on the DCC Working Group. Riley's many awards include the Model Railroad Industry Association Hall of Fame, the Narrow Gauge Hall of Fame, the Merit Award of the United Kingdom's 7mm Narrow Gauge Association, and the NMRA Pioneer Award. ■





SELECTED EVENTS

March 2016

(Please note that many events charge a fee. Check individual info website for details.)

CANADA, ALBERTA, CALGARY, March 11-12, Prototype Modelers Meet, at St. Andrew's Presbyterian Church, 703 Heritage Drive SW. Info from Dave Audley at daudley@telus-planet.net.

CALIFORNIA, BAKERSFIELD/TEHACHAPI/LANCASTER, March 12-14, Self-Guided Tour of area layouts. Info at [groups.yahoo.com/neo/groups/Model Railroads Of Southern California/info](http://groups.yahoo.com/neo/groups/Model_Railroads_Of_Southern_California/info).

CALIFORNIA, BELLFLOWER (metro Los Angeles), April 30, WPM Meet hosted by Western Prototype Modelers, at Encounter Christian Church, 10012 Ramona Street (new location). Info at railroadprototypemodelers.org/sbdmeet.htm.

CALIFORNIA, HEMET, March 5, Self-Guided Tour of area layouts. Info at [groups.yahoo.com/neo/groups/Model Railroads Of Southern California/info](http://groups.yahoo.com/neo/groups/Model_Railroads_Of_Southern_California/info).

CALIFORNIA, PERRIS, March 5, Spring Railroadiana Swap Meet at Orange Empire Railway Museum, 2201 South A Street. Info at oerm.org/events.

FLORIDA, LAKELAND, March 19, 26th Annual Train Show & Swap Meet, sponsored by H.B. Plant Railroad Historical Society, at Highland Park Church of the Nazarene, 4730 Lakeland Highlands Road. For information contact Gilbert Thomas at thomas_12399@msn.com.

SELECTED EVENTS | 2

IOWA, OTTUMWA, March 5-6, 25th Annual Train Show, sponsored by Great River Railway Club, at Quincy Place Mall. Info at trc.trains.com/events.aspx?page=info&eventid=15850.

MISSOURI, JOPLIN, March 26, Spring Model Train Show, at Joplin Museum Complex, Schifferdecker Park, 7th & Schifferdecker. Info at tristatemodelrailroaders.com/NewSite.

NEW JERSEY, CLARK, March 6, Train Show, sponsored by Jersey Central Railroad Historical Society, at Mother Seton High School, at Valley road and Clark Circle. Info at jcrhs.org/rrshow.html.

NEW YORK, ROCHESTER, March 5-6, 77th Anniversary Celebration Rochester Model Railroad Club, First Universalist Church (basement), 150 Clinton Avenue South. Not wheelchair accessible. Info at rocmmrc.com.

OKLAHOMA, TULSA, March 18-20, Layout Design & Operations Weekend, hosted by NMRA Indian Nations Division, at Shriner's Temple, 28th & Sheridan. Info at ldopsigmeet.tul-sanmra.org.

OREGON, CORVALLIS, March 19, Winterail Railroad Photography Exposition & Railroadiana Show, at 1400 NW Buchanan Ave. Info at winterail.com.

OREGON, ELSIE, March 5, 12th Annual Pacific Model Loggers' Congress, at Camp 18 Restaurant & Logging Museum, 42362 Highway 26. Info at pacificmodelloggerscongress.com.

PENNSYLVANIA, MALVERN (metro Philadelphia), March 18-20, Seventh Annual Valley Forge Railroad Prototype Modelers Meet, at Desmond Hotel. Info at rpmvalleyforge.com.

SOUTH CAROLINA, COLUMBIA, March 12, Columbia Train Show, at National Guard Armory, 1225 Bluff Road. Info at south-carolinatradeshow.com.

SELECTED EVENTS | 3

UTAH, OGDEN, March 4-6, Model Railroad Festival, sponsored by Hostlers Model Railroad Club, at Ogden Union Station, 25th Street and Wall Avenue. Info at hostlers.info.

WASHINGTON, BURIEN (metro Seattle), March 19, 17th Annual Northwest Santa Fe Mini-Meet, sponsored by Boeing Employees Model Railroad Club, at Pacific Northwest Railroad Archive, 425 SW 153rd Street. Info from John Thompson at JThomp1945@aol.com.

WISCONSIN, MADISON, March 6, NMRA South Central Wisconsin Division Meet, at Zor Shrine Center, 575 Zor Shrine Place. Info at nmra-scwd.org.

April 2016

AUSTRALIA, CANBERRA, April 2-3, 28th Annual Model Railway Expo, hosted by Canberra Model Railway Club, at University of Canberra High School, 104 Baldwin Drive, Kaleen. Info at canberra-model-railway-club-webs.com.

CANADA, ONTARIO, LINDSAY, April 2-3, 42nd Annual Model Railroad Show, at Victoria Park Armoury, 210 Kent Street West. Info from Eric Potter at annualshow@ldmr.org.

CANADA, ONTARIO, LONDON, April 23, Home Layout Tours, sponsored by London & District Layout Tour Group. Info from Bob Shiell at shiellb@gmail.com.

CANADA, ONTARIO, TORONTO, April 9, Toronto Railway Prototype Modellers Meet, at Humber College, North Campus, Building B, rooms B201-B202, 23 Humber College Boulevard. Info at torontoprototypemodellers.wordpress.com.

CALIFORNIA, OCEANSIDE, April 9, 2nd Annual Railroad Swap Meet, hosted by North County Model Railroad Society, at Heritage Park, 230 Peyri Drive. Info at ncmrs.org.

SELECTED EVENTS | 4

FLORIDA, LARGO, April 23-24, Train Show & Open House, hosted by Suncoast Model Railroad Club. Show at MINNREG Hall, 6340 126st Avenue N. Open house at 12355 62nd Street N. Suite A. Info from Jerry Bock at prrailfan@gmail.com.

GEORGIA, PORT WENTWORTH (Savannah area), April 1-2, Savannah RPM & Gun Shoot, at Port Wentworth Community Center, 103 Turnberry Street. Special rates available at Holiday Inn Express, 7210 Georgia Hwy 30. Info from Denis Blake at dblake7@columbus.rr.com.

INDIANA, MARTINSVILLE, April 2, Spring Train Show, sponsored by NMRA Central Indiana Division, at 2182 Burton Lane, in Martinsville Plaza. Info from Dan Goins at santafedangoins@comcast.net or Trevor Jones at trevjn@sbcglobal.net.

MASSACHUSETTS, WALTHAM, April 3, Spring TRAINing Model Train Show, hosted by NMRA HUB Division, at Embassy Suites, 550 Winter Street. Info at hubdiv.org.

MICHIGAN, MUSKEGON, April 24, Spring Model Train & Hobby Show, at Veteran's Museum Ship LST 393, 560 Mart Street. Info at mrhs-online.org.

MICHIGAN, WYOMING, April 9, Spring Train Show, sponsored by Grand River Valley Railroad Club, at Home School Building, 5625 Burlingame Avenue SW. Info at grandrivervalleyrrc.org.

MISSOURI, SPRINGFIELD, April 16, 38th Annual Ozarks Model Train Show, at Springfield Expo Center, 635 St. Louis Street. Info at omraspringfield.org.

OHIO, DUBLIN (metro Columbus), April 28-May 1, Rails To The Capitol NMRA MCR Division 6 Regional Convention, at Embassy Suites Hotel, 5100 Upper Metro Place. Info at 2016convention.div6-mcr-nmra.org/home_B.html.

SELECTED EVENTS | 5

OHIO, MARION, April 28-30, Central Ohio RPM Meet, at Marion Union Station, 532 West Center Street. Request info from Denis Blake at dblake7@columbus.rr.com.

PENNSYLVANIA, MONACA, April 3, Spring Model Train Show, sponsored by Beaver County Model Railroad & Historical Society, at Center Stage, 1495 Old Brodhead Road. Info at bcmrr.railfan.net.

VIRGINIA, ROANOKE, April 2, O Scale Narrow Gauge Meet at Lions Meeting Hall, 4801 Merriman Road. Info from Rick Anderson at rickshobbyshop@verizon.net.

WASHINGTON, CHEHALIS, April 2-3, Spring Model Train Show and Swap Meet, sponsored by Lewis County Model Railroad Club, at Southwest Washington Fairgrounds, Blue Pavilion Building. Request info from tedstrains@lewiscounty.com.

Future 2016, by location

CANADA, BRITISH COLUMBIA, SALMON ARM, June 15-19, Selkirk Express NMRA Pacific Northwest Region Annual Convention & Train Show. HQ at Prestige Harbourfront Resort, 251 Harbourfront Drive NE. Show at Shaw Centre, 2600 10th Avenue NE. Info at selkirkexpress2016.ca.

CANADA, NEW BRUNSWICK, SAINT JOHN, May 19-22, Port City Rails 2016 Model Railroad Convention & Show, sponsored by Saint John Society of Model Railroaders, at Howard Johnson Fort Howe Plaza & Convention Center, 10 Portland Street. Info at portcityrails2016.org.

CANADA, NOVA SCOTIA, TRURO, June 16, Maritime Prototype Modellers Meet, at Recreation Centre, 40 Douglas Street. Info at facebook.com/MaritimePrototypeModellers.

CANADA, ONTARIO, BRAMPTON, October 1-2, Model Railway Show, at Brampton Fair Grounds, 12942 Heart Lake Road. Info at bramptonmodelrailwayshow.com.

SELECTED EVENTS | 6

CANADA, ONTARIO, OTTAWA, May 6-8, NMRA Algonquin Turn, Niagara Frontier Regional Convention, at Algonquin College. Info at algonquinturn.ca.

CALIFORNIA, LOS ANGELES, September 25, Self-Guided Tour of area layouts. Info at groups.yahoo.com/neo/groups/Model_Railroads_Of_Southern_California/info.

CALIFORNIA, RICHMOND, June 18, Bay Area Prototype Modelers Meet, at St. David's School Hall, 871 Sonoma Street. Info at bayareaprototypemodelers.net.

CALIFORNIA, SANTA CLARA, May 5-7, 26th Annual O Scale West and 11th Annual S West meets, at Hyatt Regency Hotel. Info at oscalewest.com.

CONNECTICUT, ENFIELD, June 3-4, New England/Northeast Prototype Modelers Meet, at Holiday Inn, 1 Bright Meadow Boulevard. Info at nprototypemeet.com.

ILLINOIS, COLLINSVILLE (metro St Louis), August 12-13, 10th Annual St. Louis Railroad Prototype Modeler's Meet, hosted by John Golden, Lonnie Bathurst, Dave Roeder, and Dan Kohlberg. Co-sponsored by NMRA Gateway Divison, at Gateway Convention Center. Info at icg.home.mindspring.com/rpm.

ILLINOIS, CHICAGO, October 1-2, Brass Expo, a juried show limited to pre-submitted items including brass models and items relevant to brass models. At The Westin Hotel (Chicago North Shore), 601 N. Milwaukee Ave. Wheeling, IL 60090. Info at brassexpo.com.

ILLINOIS, LISLE, October 20-22, RPM Chicagoland (formerly Naperville RPM), hosted by Mike Skibbe, at Sheraton Hotel. Info at rpmconference.com.

SELECTED EVENTS | 7

INDIANA, INDIANAPOLIS, July 3-10, NMRA National Convention and National Train Show. HQ at Westin Hotel, 50 South Capitol Avenue. Info at nmra2016.org.

INDIANA, INDIANAPOLIS, July 8-10, NMRA National Train Show, at Indiana Convention Center, 100 South Capitol Avenue. Info at nationaltrainshow.org.

INDIANA, MERRILLVILLE, Aug 11-14, Steel Mill Modelers SIG Meet, at Hilton Garden Inn, 7775 Mississippi Street. Info at smmsig.org.

KANSAS, WICHITA, June 22-26, Santa Fe Railroad Historical & Modeling Society 36th Annual Convention, at Wichita Marriott East, 9100 Corporate Hills Dr. Info at atsfr.com/convention/2016%20Wichita/Index.htm.

MAINE, AUGUSTA, Sept. 7-10, 36th National Narrow Gauge Convention. Info at nngc2016.org.

MISSOURI, JEFFERSON CITY, October 6-9, Missouri Pacific Historical Society Annual Meeting, includes modeling clinics and swap meet. Info at mopac.org/corporate-history/73-missouri-pacific-railroad.

NORTH CAROLINA, DURHAM, October 20-23, Mid-Eastern Region Fall Convention, sponsored by NMRA Carolina Piedmont Division, at Marriott at Research Triangle Park, 4700 Guardian Drive. Info at mer2016.org.

TENNESSEE, JOHNSON CITY, June 3-4, George L. Carter Railroad Museum Train Show, at East Tennessee State University, Memorial Center Mini-Dome, 1081 John Robert Bell Drive. Info from Mark Woomer at markwoo1969@hotmail.com.

VIRGINIA, FISHERSVILLE, May 1, 30th Annual Shenandoah Valley Model Train & Railroading Show, sponsored by Augusta County Model Railroad Club, at Augusta Expo, 277 Expo Road. Info at acmrrc.org. acmrrc.org/%20.

SELECTED EVENTS | 8

VIRGINIA, FREDERICKSBURG, September 23-24, Mid-Atlantic Prototype Modelers Meet, at Wingate by Wyndham Hotel, 20 Sanford Drive. Info at marpm.org.

WISCONSIN, WAUPACA, June 18-19, 27th Annual Strawberry Fest Model Railroad Show & Model Contest, sponsored by Waupaca Area Model Railroaders, at Waupaca Recreation Center, 407 School Street. Info at wamrltd.com.

Future, 2017 and beyond by location

AUSTRALIA, VICTORIA, GEELONG, April 14-16, 2017, 13th Annual Australian Narrow Gauge Convention. Info at austnarrowgaugeconvention.com.

COLORADO, DENVER, August 30-September 2, 2017, National Narrow Gauge Convention, at Marriott Denver Tech Center Hotel.

FLORIDA, ORLANDO, July 30-Aug 5, 2017, NMRA National Convention.

MISSOURI, KANSAS CITY, August 5-12, 2018, NMRA National Convention. ■



**Click here for
reader comments**

Clickable advertiser index – 1

[Accu-Lites](#)

[American Eagle Railroad Group](#)

[American Ltd \(San Juan\)](#)

[ANE Models](#)

[Archer Fine Transfers](#)

[Athearn](#)

[Atlas Model Railroad Co.](#)

[Bachmann](#)

[Backdrop Junction](#)

[Berrett Hill Trains](#)

[Black Cat Publishing](#)

[Blair Line](#)

[BLMA](#)

[Bowser](#)

[Caboose Hobbies](#)

[Canyon Creek Scenics](#)

[Clever Models](#)

[Coastmans Scenic Products](#)

[Coffman Graphics](#)

[Con-Cor](#)

[Credit Valley Railway](#)

[DCC Hobby Supply](#)

[Digitrax \(2 page spread\)](#)

[ESU LokSound](#)

[Fast Tracks](#)

[Fifer Hobby Supply](#)

[Fine Scale MR Expo](#)

[Fox Valley Models](#)

[George's Trains](#)

[GLX Scale Models](#)

[Great Decals](#)

[HO Diesel Supply](#)

[Indianapolis National Train Show](#)

[Iowa Scaled Engineering](#)

[Iwata-Medea](#)

[Jelsma Graphics](#)

[KC's Workshop](#)

[Ken Patterson.com](#)

[Lights 4 Models](#)

[Litchfield Station](#)

[Logic Rail Technologies](#)

[Main Street Heritage Models](#)

[MinuteMan Scale Models](#)

[Model Railroad Benchwork \(1\)](#)

[Model Railroad Benchwork \(2\)](#)

[Model Rectifier Corp. \(1\)](#)

[Model Rectifier Corp. \(2\)](#)

[Monster Modelworks](#)

[Motrak Models](#)

[Mountain Subdivision Hobbies](#)

[MRH Store \(1\)](#)

[MRH Store \(2\)](#)

[MRH Store \(3\)](#)

[Mr. Detail Parts](#)

[Nano-Oil](#)

[NCE \(2 page spread\)](#)

[Nick & Nora Design](#)

[North American Railcar Co.](#)

[Oak Hill MRR Track Supply](#)

[Pre-Size Model Specialities](#)

[Precision Design Co.](#)

[Rapido \(1\)](#)

[Rapido \(2\)](#)

[Ring Engineering \(1\)](#)

Clickable advertiser index – 2

[Ring Engineering \(2\)](#)

[RsLaser Kits](#)

[Rulers-of-the-World](#)

[Rusty Stumps](#)

[Scale Trains](#)

[Scotty Mason Show](#)

[Signature Press](#)

[Soundtraxx \(Blackstone\)](#)

[Southern Digital](#)

[Streamlined Backshop](#)

[TAM Valley Depot](#)

[Tony's Train Exchange](#)

[TrainMasters TV \(1\)](#)

[TrainMasters TV \(2\)](#)

[TrainMasters TV \(3\)](#)

[Traintek](#)

[TSG Multimedia](#)

[Vector Cut](#)

[Westerfield Models](#)

[Yankee Dabbler](#)

[Yarmouth Model Works](#)

Clickable “other” index

[Other – Cover](#)

[Other – Derailments](#)

[Other – Hobby Marketplace](#)

[Other – MRH Sponsors](#)

[Other – Staff Notes](#)

[Other – Table of Contents](#)

DOWNLOAD ISSUE



DOWNLOAD PORTRAIT



DOWNLOAD LANDSCAPE

• INDEX

• TABLE OF CONTENTS



REVERSE RUNNING

commentary

JOE FUGATE
.....



[Click here for
reader comments](#)

MODEL RAILROADING IS GOING TO THE DOGS

We've all heard it – the hobby of model railroading is going to the dogs.

Pick your favorite complaint: the hobby is getting too pricey, kids today don't see trains in real life any more, model railroading is just a hobby full of old guys, rivet counters are ruining the hobby ... and so it goes.

I read a lot of old model railroading magazines and the current hand-wringing by modeler railroaders is just the latest in a long series of previous “the hobby is going to the dogs” scenarios.

Back in the late 40s and early 50s, it was plastic is going to kill the hobby – soon it's going to be filled with cheap junk and the hobby will lose its appeal. Plastic simply can't be used to make nicely detailed models like cardstock, wood, and metal can. Yep, they

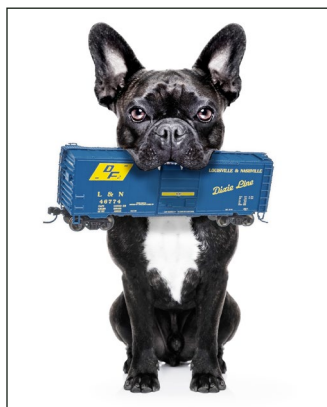

▶ **STEPPING OUTSIDE THE BOX WITH A CONTRARY VIEW**

were right, there's no way model trains made with plastic could ever hold up to model trains made with cardstock, wood, and metal. Just look at today's plastic models and their sparse, crude detail.

Then as the 1950s wore on, the gloom-and-doom prophets said the proliferation of ready-to-run was going to kill the craftsmanship in the hobby. Nobody was building models by hand any longer, and that's going to kill the craftsmanship side of the hobby industry. Sound familiar?

In the 1960s, the hand-wringing fears moved to slot cars. Slot cars were all the rage and they would soon eclipse the popularity of model trains with the young. Model railroading was certainly on the way out. Yep, slot cars killed model trains, most definitely.

In the 1970s, the demise of the train set spelled certain doom for the model railroading hobby. Without train sets, there would be no way for the young to get introduced to the hobby, and the hobby was for sure on the way out. Yep, today's model train shows look like the proverbial ghost town, thanks to the train set no longer being a popular fad toy like it was in the 1950s and 60s.

And in the decades since, the hobby prophets continue to gaze into their crystal ball and remind us all how unaffordable the hobby of model railroading keeps getting.

After all, you can't get \$25 locomotives or \$2 freight car kits any longer. Why today, \$25 is a cheap freight car – and a low cost loco is \$100-\$150. Outrageous!

So I guess all those gloom-and-doom prophets were right. The hobby of model railroading has gone to the dogs.

And those dogs are enjoying better models *made of plastic* and unprecedented availability of used affordable model trains from sources like eBay that didn't even exist back then (600,000+ model train items listed for sale as of last look).

We dogs never had it so good. Bark, bark! ☑



DERAILMENTS



NEIGHBOR'S CAT VISITS GARDEN RR

Here's a YouTube video (enhanced with sound effects) of the Havellender Denver & Rio Grande Western Railway, the German garden model railroad of Elke and Jens Handro that had a visit from the neighbor's cat during an operating session.

For more on this nice looking garden layout, visit their website at: havellender.de

Note: This video and website are in German, so to view the website in another language, you will need to translate the site using Google Translate: translate.google.com.

► BIZARRE FACTS AND HUMOR (SUPPOSEDLY)

YOU MIGHT BE A MODEL RAILROADER IF ...

- Brass isn't something you polish, it's something you paint and weather.
- Your family has eaten in the den because the kitchen table was buried in train decals, tools, and detail parts.
- You've run two identical cars in a train and hoped no one noticed the road numbers were the same.
- It annoys you that the kits for model airplanes, cars, and boats aren't made to scales like 1:87 or 1:160. ■

GET PAID ...

If you're the first to submit a bit of good humor or bizarre facts and we use it, it's worth \$25! Just send to derailments@mrhmag.com ■

Coming next issue ...

- Jack Burgess explores building a Proto:48 diorama
- Estaban Martinez's HO BNSF layout
- Build a BC Rail CRS20
- B&O passenger car modeling
- Monster Modelworks brick, part 2
- And lots, *lots* more!

