

HAVING FUN WITH TRAINS

JANUARY 2016 | FREE

# MRH

MODEL RAILROAD HOBBYIST

**ALSO:**

- Steel-making railroad
- Sound decoder insights
- Structures with character
- Modeling palm trees
- DIY wheel painting mask

*... and lots more inside!*

## Joe Fugate's Siskiyou Line Celebrates 25 years

» **READ NOW**

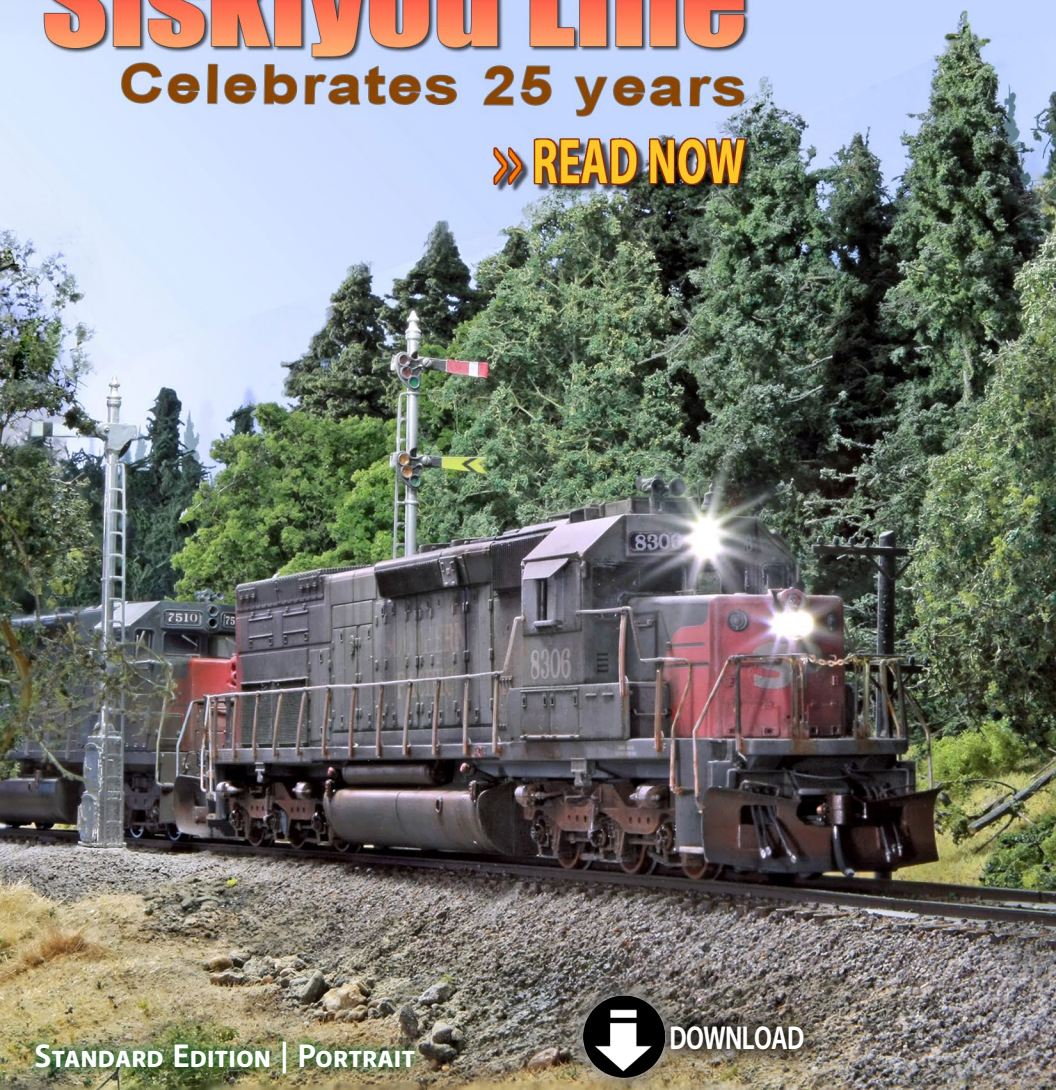

STANDARD EDITION | PORTRAIT



DOWNLOAD

# BLMA MODELS



HO & N

## HERE COME THE REPAINTS

3 NEW BNSF SCHEMES



## PRE-ORDER MODELS

BNSF  
*Bx-166*  
60' Double-Door Box Car

• 24 Unique Road Numbers •

ORDERS DUE: Jan 15, 2016

DELIVERY: Summer 2016

# *BLMAmodels.com*

BLMA  
BLOG



• INDEX

• TABLE OF CONTENTS





# STAFF CREDITS

**Front cover:** Joe Fugate's Siskiyou Line home layout is 25 years old this year. We take a look back over those 25 years (and a bit more) with MRH's publisher in this issue.

**ISSN 2152-7423**

## Editorial Staff

Joe D. Fugate, Publisher and Editor

Don Hanley, Assistant Editor

## Production

Patty Fugate, pasteup and layout

Joe Brugger, copy editing

Mike Dodd, copy editing

## Technical Assistant

Jeff Shultz

## Advertising

Les Halmos, Account Manager

Daniel Nava, Advertising Assistant

Jean-François Delisle, Marketing Assistant



## Columnists

Richard Bale, News and events

Jeff Shultz, News and events

Les Halmos, Modular railroading

Larry Smith, Narrow Gauge/Shortlines

Bruce Petrarca, DCC

Ken Patterson, Reporter at large

## Special Correspondents

Joe Brugger, Questions & answers

Charlie Comstock, Contributing editor

Issue password: Jan2016

Published for the glory of God. [What's this?](#)



Model Railroad Hobbyist | Jan 2016 | #71

# MRH SPONSORS

## A - E



[acculites.com](http://acculites.com)



[americanlimitedmodels.com](http://americanlimitedmodels.com)



[railroadhobbyshow.com](http://railroadhobbyshow.com)



[anemodel.com](http://anemodel.com)



[archertransfers.com](http://archertransfers.com)



[athearn.com](http://athearn.com)

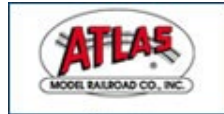

[www.atlasrr.com](http://www.atlasrr.com)



[bachmanntrains.com](http://bachmanntrains.com)



[bachrus.com](http://bachrus.com)



[backdropjunction.com](http://backdropjunction.com)

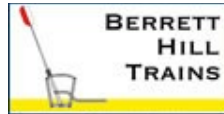

[berrethill.com/trains](http://berrethill.com/trains)



[blairline.com](http://blairline.com)



[blmamodels.com](http://blmamodels.com)



[bowser-trains.com](http://bowser-trains.com)



[caboosehobbies.com](http://caboosehobbies.com)



[coffmaneng.com](http://coffmaneng.com)



[cvrco.com](http://cvrco.com)



[www.digitrax.com](http://www.digitrax.com)



[esu.eu/en](http://esu.eu/en)

[Vendors: Get your clickable logo here ...](#)



# MRH SPONSORS | 2

## F - R



[www.handlaidtrack.com](http://www.handlaidtrack.com)



[fiferhobby.com](http://fiferhobby.com)



[foxvalleymodels.com](http://foxvalleymodels.com)



[glxscalemodels.com](http://glxscalemodels.com)



[georgestrains.com](http://georgestrains.com)



[www.iascaled.com](http://www.iascaled.com)



[iwata-medea.com](http://iwata-medea.com)



[litchfieldstation.com](http://litchfieldstation.com)



[model-trains-video.com](http://model-trains-video.com)



[model-trains-video.com](http://model-trains-video.com)



[stores.ebay.com/Motrak-Models](http://stores.ebay.com/Motrak-Models)



[modelrectifier.com](http://modelrectifier.com)



[nano-oil.com/Model%20Railroad.html](http://nano-oil.com/Model%20Railroad.html)



[ncedcc.com](http://ncedcc.com)



[nickandnoradesigns.com](http://nickandnoradesigns.com)



[www.pwrs.ca/main.php](http://www.pwrs.ca/main.php)



[railmasterhobbies.com](http://railmasterhobbies.com)



[rapidotrains.com](http://rapidotrains.com)



[ringengineering.com](http://ringengineering.com)



[rustystumps.com](http://rustystumps.com)

[Vendors: Get your clickable logo here ...](#)

# MRH SPONSORS | 3

## S - Z



[sanjuancarco.com](http://sanjuancarco.com)



[scaletrains.com](http://scaletrains.com)



[signaturepress.com](http://signaturepress.com)



[soundtraxx.com](http://soundtraxx.com)



[sodigi.com](http://sodigi.com)

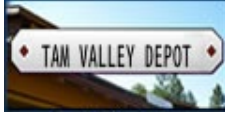

[tamvalleydepot.com](http://tamvalleydepot.com)



[tonystrains.com](http://tonystrains.com)



[traintekllc.com](http://traintekllc.com)



[tsgmultimedia.com](http://tsgmultimedia.com)



[walthers.com](http://walthers.com)



[yankeedabblers.com](http://yankeedabblers.com)

[Vendors: Get your clickable logo here ...](#)

Looking for something? Check our Hobby Marketplace!

The screenshot shows a grid of advertisements for various model railroading products. Advertisements include:
 

- Trees!**: A collection of model trees for sale.
- coastmans**: A collection of model coasters or buildings.
- MRH MARKETPLACE | 2**: A central banner for the marketplace.
- WESTERFIELD**: Advertisement for a new available agent kit.
- CLEVER**: Advertisement for a new product.
- SUGAR CUBE SPEAKERS**: Advertisement for a speaker product.
- TrainShow.com**: Advertisement for finding the nearest train show.
- BenchWork**: Advertisement for a benchwork product.

Take me there!





## DAYLIGHT DELIGHT: SP MT4 MOUNTAINS IN SEMI-DAYLIGHT!



ATHG97057



- Skyline casing
- Late headlight with visor
- Laird multiple bearing cross head
- Factory applied detail parts
- Illuminate number boards

- Front coupler pocket can be inserted to mount operating coupler
- Builder's plates
- Universal or spoked drivers per prototype
- Plus much more!

### HO 4-8-2 MT-4

Twenty-one Southern Pacific MT-4 4-8-2 "Mountains" were built between 1926 and 1929 by Southern Pacific. The Mountains were workhorses of both fast passenger and freight duties. In the late 1940's, five of the SP Mountains were repainted in a "Daylight" paint scheme for use on trains number 51 and 52 of the San Joaquin Daylight.

DCC Ready	DCC+Sound		
ATHG97056	ATHG97006	HO 4-8-2 MT-4 w/Skyline Casing, SP #4358	In Stock
ATHG97057	ATHG97007	HO 4-8-2 MT-4 w/Skyline Casing, SP #4360	In Stock
ATHG97058	ATHG97008	HO 4-8-2 MT-4 w/Skyline Casing, SP #4350	Due 3/2016
ATHG97059	ATHG97009	HO 4-8-2 MT-4 w/Skyline Casing, SP #4361	Due 3/2016
ATHG97060	ATHG97010	HO 4-8-2 MT-4 w/Skyline Casing, SP #4352	Due 3/2016
ATHG97061	ATHG97011	HO 4-8-2 MT-4 w/Skyline Casing, SP #4354	Due 3/2016
ATHG97062	ATHG97012	HO 4-8-2 MT-4 w/Skyline Casing, SP #4363	Due 3/2016

### DON'T FORGET THE ATHEARN GENESIS 77' CHAIR CAR!

The MT-4 Steam Locomotives were a common sight pulling the SP Daylight passenger trains. Be sure to add-on to your train with these Genesis Passenger cars.



VISIT [ATHEARN.COM](http://ATHEARN.COM) FOR MORE DETAILS



ATHG97107 and ATHG97108



VISIT  
Your Local Retailer

CLICK  
Atearn.com

CALL  
1.800.338.4639

SERIOUS FUN™

©2015 Horizon Hobby, LLC. Athearn, Genesis is a registered trademark of Horizon Hobby, LLC. All other trademarks, service marks and logos are property of their respective owners. Final models may vary slightly from photos shown. SH67



# TABLE OF CONTENTS

## FEATURES

### Joe Fugate's Siskiyou Line at 25 years

JOE FUGATE

Our publisher reflects on this layout milestone

.....



### How to make palm trees

TIMOTHY DUDLEY

Easily made trees with paper, paint and wire

.....



### How to model working cranes: 2

GEOFF BUNZA

Put these animated cranes to work on your layout

.....



### Do-it-yourself wheel mask

RONALD BRILL

A simple wheel painting mask you can make

.....



### MRH Product Showcase

compiled by the MRH STAFF

Exceptional products past, present, or future

.....



**ALSO:** MRH Marketplace | Bonus extras



# TABLE OF CONTENTS | 2

## COLUMNS

**MRH Q-A-T: Sticky figures, module track joints, ...**

*compiled by JOE BRUGGER*

**DCC Impulses: Econami decoder + RS3 sound install**

*BRUCE PETRARCA*

**Getting Real: Remodeling the layout, next chapter: 2**

*MIKE ROSE*

**Lite & Narrow: Woodward Iron Railroad**

*LARRY SMITH*

**What's Neat: Installing SoundCar decoder, and more ...**

*KEN PATTERSON*

**Imagineering: Modeling structures with character**

*DAVE MEEK*

**Photo feature: Yes, it's a model**

*compiled by DON HANLEY*

**Derailments: Bizarre facts & humor**

*compiled by the MRH STAFF*

## NEWS and EDITORIAL

**Ass't Editor's Thoughts: Know where your layout is?**

*DON HANLEY*

**Staff Notes: Weathering with Mike Confalone ...**

*compiled by the MRH STAFF*

**News & Events: January 2016**

*RICHARD BALE & JEFF SHULTZ*

**Reverse Running: The boys at the club**

*JOE BRUGGER*



# SEE THE DIFFERENCE NOW!



## UP GTEL 8500 HP "Big Blow" Turbine



## Trinity 31K Crude Oil Tank Car With Head Shields

See all models and preorder now at [www.ScaleTrains.com](http://www.ScaleTrains.com) and Select Retailers.



## Union Pacific Post-2006 Water Tender Set

FEF-3 #844, Challenger #3985, and Big Boy #4014 owners...  
Give your excursion steamers a tall drink of water.







# ASSISTANT EDITOR

editorial

DON HANLEY  
.....



[Click here for  
reader comments](#)

## DO YOU KNOW WHERE YOUR LAYOUT IS?

**IT'S JANUARY 2016 AND THE HOLIDAYS ARE** over. Forget about the New Years resolutions. If you think about it, more often than not resolutions are a source of grief because you aren't able to follow through. If you are among the 99.9% of the population, within a month you have forgotten them, so why waste the energy and time? Instead, look for something that you can do on your layout.

The new year is a good time to seriously assess where your layout is, where you would like it to be, and determining the steps to get it there. Here are some general questions that are good starting points to ask yourself.

1. How often do I go into my layout room or space?
2. Do I enjoy going there?
3. Am I happy with my layout overall?
4. Are there sections of the layout that I would like to do differently?
5. What do I need to do to make the changes?

## ASSISTANT EDITOR'S THOUGHTS | 2

The answers to these questions will say a lot about where you need to go with your layout.

Next, make a serious assessment of your rolling stock. If it is derailing continually, your layout won't be a lot of fun to operate no matter how well it has been detailed. Start by making a list of the cars that don't run well, and what appears to be the problem. Then pull the cars from the layout.

Develop a standard for your fleet; the NMRA standards are a good place to start. Begin by checking that all of the wheels are in gauge, and coupler heights are correct. Next make sure that car rolls freely. A car that doesn't roll freely can not only be a source of derailments, it will also reduce the pulling ability of your locomotives.

### ADVERTISEMENT

# GET ON THE RIGHT TRACK...WITH ATLAS!

**For over 60 years, Atlas has been THE source for model railroad track & accessories. We're proud to continue the tradition as your one-stop source for realistic and reliable track, locomotives, rolling stock and accessories!**



**BEFORE** using ATLAS Track



**AFTER** using ATLAS Track

**SHOP NOW!**





# The Amherst Railway Society Railroad Hobby Show

Our 2016 Show will be

# January 30 & 31, 2016

Save the dates!

## About The Show

Every year late in January or early in February, the Amherst Railway Society holds its Railroad Hobby Show at the Eastern States Exposition Fairgrounds (The home of The Big E) in West Springfield, Massachusetts. More than 25,000 railfans and public attended the Show each of the past three years.

The event features real life railroads and scale model railroads, historical societies, travel agencies, art shows, flea market dealers, importers, manufacturers and photographers. You have to see it to believe it!



**Click  
to learn  
more ...**



**Backdrop Junction**  
Your Stop for Railroad Backdrops

**Click Here** →

**For the Finest in Custom  
Designed backdrop**



[www.backdropjunction.com](http://www.backdropjunction.com)

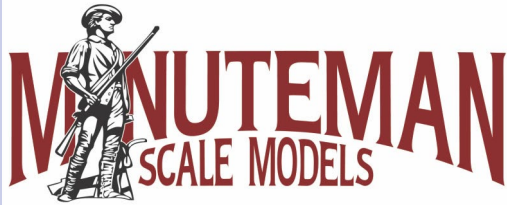

**The New Home of...**



**Scalecoat Model Paint**

Phone: (603) 921-5139  
[Info@minutemanscalemodels.com](mailto:Info@minutemanscalemodels.com)

## ASSISTANT EDITOR'S THOUGHTS | 3

Finally check the weight of each car. While there are the NMRA recommendations, there is also a lot of discussion in the MRH forum ([mrhmag.com/node/15331](http://mrhmag.com/node/15331)) about adding weight above those. If you are still not sure where to begin, publisher Joe Fugate is putting together a how-to titled *Make It Run Like a Dream* that will be out soon as an eBook or hardcopy book.

So what if you don't have a layout? How about entering the MRH Contest: THE "ONE MODULE" CHALLENGE. ([Click here to read the contest details](#)) You can submit your entry as late as January 31. This is a great way to get started on a layout. Let your imagination go to work. Even if you don't win, you have a design that you can start to build.

Coming **SOON**  
*exclusively*  
from **RAPIDO**

\*Pre-production sample shown.



**HO**  
SCALE

READ OUR ONLINE NEWSLETTER  
FOR MORE INFORMATION



[www.rapidoitrains.com](http://www.rapidoitrains.com)

RAPIDO





## Looking For a Bargain? Look No Further!

*(while supplies last)*

**HO**

- *Digitrax*
- *SoundTraxx*
- *Kadee*
- *NCE*
- *And more!*

**DCC**

**ALL SCALES**



**HAPPY NEW YEAR**

**2016**

OK, so you don't want to want to enter the contest because you don't think that you can come up with a design that would interest the judges. That's fine. Go to the MRH track plan database ([mrhmag.com/track-plan-database](http://mrhmag.com/track-plan-database)) and look over the plans that fellow hobbyists have submitted. While there may not be a specific plan you like, there may be parts of different plans that you can combine.

Once you have a plan, select a portion of it to build on one module. You may find this takes more than you might think but that's all part of the learning process.

Be sure to include a section of runoff track (also called staging) on one or both ends. This gives you the ability to have trains arrive and depart from the finished portion of the layout. Once you have finished the first module, then start on the second.



## ASSISTANT EDITOR | 5

There are many things that you can do in the hobby depending on your circumstances. I have mentioned a few. But above all, remember Nike's motto: ***Just Do It!***



**Click here for  
reader comments**



**Take the MRH  
2016 Reader Survey ...**

... and get a chance to win a 10"  
Kindle Fire tablet!

**amazon**



fireHD10  
OUR LARGEST  
DISPLAY  
— ON OUR —  
THINNEST TABLET

**TAKE THE SURVEY >>**

## Combo Right Clamp™

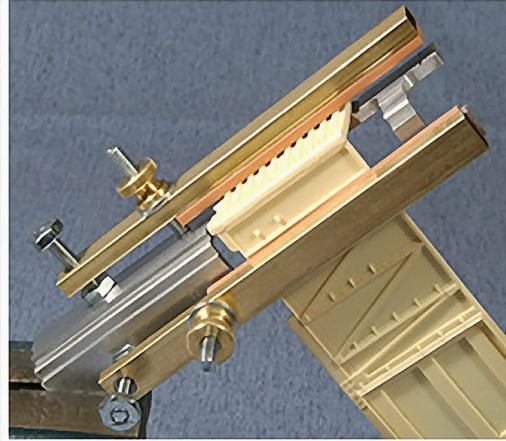

**Combo Right Clamp™**  
with cast resin boxcar

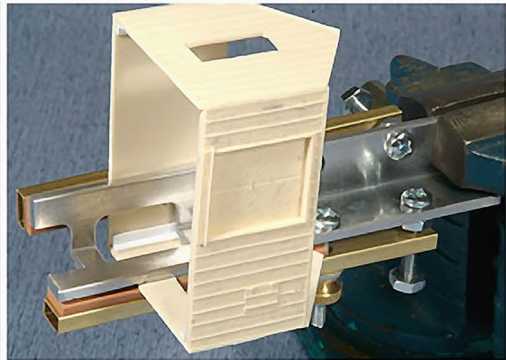

**Combo Right Clamp™**  
with Wolf Design Pump House

**Click here for  
all our products ...**

**Tools for Modelers**

Coffman Graphic Solutions Co.  
1500 River Circle, Richmond,  
KY 40475-7907

# MRH CONTEST: THE "ONE MODULE" CHALLENGE



**GOAL:** Design the first "module section" for a sectional home layout design.

Hypothetical room is 12' x 15'

NOTE: This is a sectional home layout design, no modular standard required.

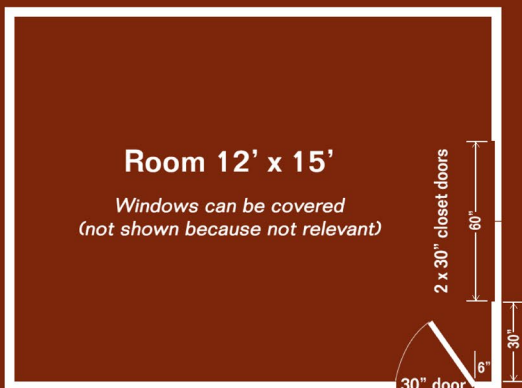

## CONTEST RULES

**ENTRY DEADLINE: January 31, 2016**

- Module must be 18"-24" in depth and 60"-84" in length.
- Scale: Z, N, TT, HO, S, O - standard and/or narrow gauges.
- Connectable to a flattop staging section (or additional layout sections later) at each end. Design the two flattop staging yards with 3 to 8 staging tracks of at least 70" long.
- Rough out the outlines of the other layout module sections to be built for the entire room. No track plan needed, just an outline of the modules in the room is sufficient.
- Describe the theme, era (if any), and rationale for the module and its place in the layout that would eventually fill the room.
- Can follow a specific module standard (like Free-Mo) if desired, but that is not a requirement. Each module can be custom and only mate with an adjacent module.
- Module support method and height is up to you, but please describe it.
- Must be wired for either DC or DCC. Describe how you would interconnect the wiring.
- As the first module of a sectional home layout design, making the module removable once completed is not required, but innovation here will get extra points.
- As to construction methods & materials, surprise us. Extra points awarded for innovation.
- Include pricing for the module. There's no need to build it, this is a design contest. This includes module benchwork, legs, backdrop, roadbed, trackwork, wiring, scenery materials, structures, and details. Do not include a DCC system, rolling stock, or locos.
- The best submissions will be published, so extra points will be awarded for high quality text, illustrations, photos, and captions. Winners will get a bonus payment rate.

**SUBMIT ENTRY (Choose "Contest entry")**

• INDEX

• TABLE OF CONTENTS



# STAFF NOTES



[Click here for  
reader comments](#)



## WEATHERING WITH MIKE CONFALONE ... AND MORE

### WE'VE BEEN PROMISING A MIKE CONFALONE

weathering video series for a while now. Well, Mike has delivered on this series, and how! We got a lot more than we expected: six hours of step-by-step video already, with another four hours expected over the next few weeks.

Mike has done a great job explaining what he does in all the how-to videos he's done for us over the years, but he's hit one out



## STAFF NOTES | 2

of the park in this new series. We're excited to be bringing this video series to TrainMasters TV, and to be making it available through the MRH Store as download-to-own and on DVD.



Mike takes one piece of equipment at a time and goes through the entire process on camera so you can see how it's done. He does this real-time, so you can watch the weathering develop and evolve, step-by-step. All without ever needing to use an airbrush!

Because Mike does this in real time, on a few occasions (rare, but it does happen) things don't work out quite the way he expects. So you get to see how Mike adapts the weathering effect on the fly to get what he is after. This should give you the confidence to see how *you too* can fix any mistakes along the way. Mike shows it's just not a big deal to adapt and correct things as you go!

Watch for this awesome new series coming later in January from Mike Confalone on TMTV, or as download-to-own video, or on DVD! It's expected to be over 10 hours of video in all.

### ***Run Like a Dream* series pre-order available**

Joe Fugate's new *Make it Run Like a Dream* book series [is available for pre-order](#). While we expect the entire series of three books to take about 18 months to release (with each book about six months apart), those who pre-order get sneak peeks along the way of chapters as they're finished. Plus, those who



# LAST ISSUE'S RATINGS

The five top-rated articles in the [December 2015 issue](#) of *Model Railroad Hobbyist* are:

4.7 What's Neat: Reminiscing with Ken

4.6 Derailments

4.5 Southern Pacific's passenger cars, part 8

4.4 DCC Impulses: Details of DCC consisting

4.4 Publisher's Musings: Looking back with Ken Patterson

Issue overall: **3.9**

**Please rate the articles!** Click the reader comments button on each article and select the star rating you think each article deserves. Thanks! ■

## ADVERTISEMENT

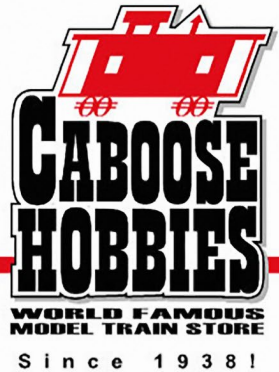

# The World's Largest Model Train Store!

Model trains G to Z, DCC, brass models, kits, RTR, collectable models, scenery, structures, books, magazines, DVD's, hobby tools & supplies and a full service repair department.

[WWW.CABOOSEHOBBIES.COM](http://WWW.CABOOSEHOBBIES.COM)



• INDEX

• TABLE OF CONTENTS

Make it run like a  
**Dream**  
By Joe Fugate



TRACKWORK

Make it run like a  
**Dream**  
By Joe Fugate



ROLLING STOCK

Make it run like a  
**Dream**  
By Joe Fugate



LOCOMOTIVES

pre-order will get access to some special how-to supplemental videos to go with the series. We'll be making the series available either as eBooks or as hardcopy print books, your choice.



**Take the MRH  
2016 Reader Survey ...**  
... and get a chance to win a 10" Kindle Fire tablet!



**amazon**  
fire HD10  
OUR LARGEST DISPLAY  
ON OUR THINNEST TABLET



**TAKE THE SURVEY >>**

ADVERTISEMENT



Uniquely inspired craftsman kits

Come visit us at the  
Amherst Railway Society Show,  
Springfield, MA  
Jan 30 & 31 2016



Craftsman Structure Kits,  
Detail Parts, Shingles & More!  
[www.nickandnradesigns.com](http://www.nickandnradesigns.com)





## STAFF NOTES | 5

Joe will be doing three titles in the series. The first book covers trackwork, the second rolling stock, and the third, locomotives. Joe describes in some depth the tips and tricks he's relied on over the years for getting things to run better and to perform as good as possible.

Joe is the first to admit he keeps on learning, so some of the methods he shares have come from very recent discoveries. These include some of the latest new clever technological tricks, so get the latest insights on making things run well!

The eBooks will cost \$12.99 each, or you can get the entire three volume set as a pre-order special for \$29.99. The hard-copy books will cost \$25.99 each, or you can pre-order all three for \$59.99 plus shipping and handling.

## “ONE MODULE” CHALLENGE BONUS PRIZE!

### GET YOUR MODULE *FREE* FROM [modelrailroadbenchwork.com](http://modelrailroadbenchwork.com)

“We would like to offer the winner a free module meeting their design's size criteria with legs. This means you'll win a benchwork module with a value of up to \$150 shipped free to your home.

(In the US only, however.)”



And remember, if you pre-order, you essentially subscribe to getting regular sneak peeks on chapters and some special sneak-peek only how-to videos.

The books cover preventative best practices to help avoid ever facing many performance issues. Joe also presents common problems he's encountered and how he corrected them. Finally, Joe discusses in depth how to achieve quality running, and how to save yourself a lot of work by focusing on what matters most and not wasting time with unimportant things.

We don't know of any model railroad publications that have ever gone into this much depth by an expert modeler on how to get your railroad to run better.

[Go to the MRH Store now](#) and pre-order the *Make it Run Like a Dream* series and start getting your sneak peeks on this landmark new how-to book series from MRH.

### What's new on the MRH website?

This month, we focus on the popular ***Weekly photo fun*** threads on the MRH website. Each week the forum regulars kick off a recurring thread full of show-and-tell photos of what they're up to in the hobby. Here are the most recent ones.

Dec 25-31: [mrhmag.com/node/24744](http://mrhmag.com/node/24744)

Dec 18-24: [mrhmag.com/node/24662](http://mrhmag.com/node/24662)

Dec 11-17: [mrhmag.com/node/24601](http://mrhmag.com/node/24601)

Dec 4-10: [mrhmag.com/node/24525](http://mrhmag.com/node/24525)

Nov 27 - Dec 3: [mrhmag.com/node/24449](http://mrhmag.com/node/24449)

# STAFF NOTES | 7

Nov 20-26: [mrhmag.com/node/24389](http://mrhmag.com/node/24389)

Nov 13-19: [mrhmag.com/node/24312](http://mrhmag.com/node/24312)

Nov 6-12: [mrhmag.com/node/24224](http://mrhmag.com/node/24224)

Oct 30 - Nov 5: [mrhmag.com/node/24138](http://mrhmag.com/node/24138)

Oct 23-29: [mrhmag.com/node/24066](http://mrhmag.com/node/24066)

Oct 16-22: [mrhmag.com/node/24009](http://mrhmag.com/node/24009)

Be sure to check out these photo fun threads. They help pass the time with interesting hobby photos between issues of MRH!



**Click here for  
reader comments**

## ADVERTISEMENT

**Lasercut structures. Highway, storefront and billboard signs.**

**NEW KIT in HO & N!**



**WHAT'S  
NEW?**

**HO-N-O scales**

**Blair Line**

## ADVERTISEMENT

**George's Trains**

EST. 1962

**PROTO-PAINT**



**20 NEW Colours  
Just added!**

**ACRYLIC-Air Brush Ready**  
NOW OVER 45 Canadian Railway Colours!

Dealer inquiries welcome.

PP-001 CNR Green #11	PP-020 TH&B Maroon	PP-038 TTC CREAM
PP-002 CNR Imitation Gold	PP-021 Primer	PP-039 TTC Maroon
PP-003 CN VIA Blue #16	PP-022 Reducer	PP-040 Warm BLACK
PP004 CN Via Yellow #18	PP-023 Flat Finish	PP-041 Grimy Black
PP-005 VIA Grey	PP-024 Stencil White	PP-042 Anti-Glare Black
PP-006 CN Red/Orange #11	PP-025 Loco Black	PP-043 Slag Brown
PP-007 CN Lettering Grey #17	PP-026 Flat Haze	PP-044 GO Green
PP-008 CN Grey #11	PP-027 ONR LT BLUE	PP-045 GO White
PP-009 CNR Red #12	PP-028 ONR DK BLUE	PP-046 CONRAIL Blue
PP-010 CPR Tuscan	PP-029 ONR YELLOW	
PP-011 CPR Diesel Grey	PP-030 ONR Post 2000 Yellow	
PP-012 CPR Diesel Yellow	PP-031 ONR GREEN	
PP-013 CPR Steam Grey	PP-032 BCR/PGE DK GREEN	
PP-014 CPR Mineral Brown	PP-033 BCR RED	
PP-015 CP Action Red	PP-034 BCR Blue	
PP-016 CP Action Yellow	PP-035 BCR Yellow	
PP-017 CP Action Green	PP-036 BCR/PGE LL GREEN	
PP-018 CP Bright Red	PP-037 GTW Blue	
PP-019 TH&B Cream		

**\$8.98 each  
Canadian**

**ORDER  
NOW!**

550 Alden Rd. Unit 101 Markham, On, Canada L3R 6A8  
Tel: 905-470-6200 Toll Free: 1-877-8TRAINS (887-2467)  
[www.georgetrains.com](http://www.georgetrains.com)



# Heckman's Canadian Pacific

## A Photographic Journey

by Ralph Beaumont

Joseph Heckman was a pioneer photographer for the Canadian Pacific Railway. He photographed the line from coast to coast between 1898 and 1915, capturing the engineering works, stations, hotels, steamships, and the people who made the railway run. More than 4,000 of these historic images are preserved in the CPR's Corporate Archives, and 380 of them have been made available for this large format, hard cover book.

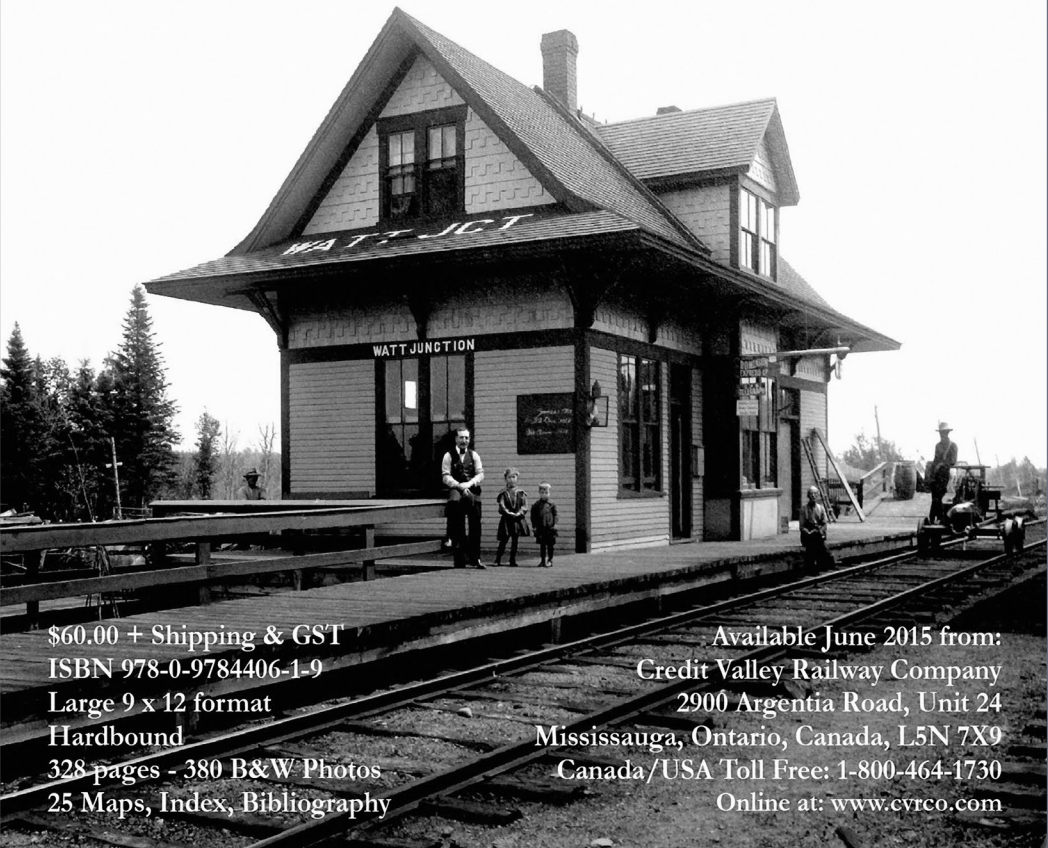
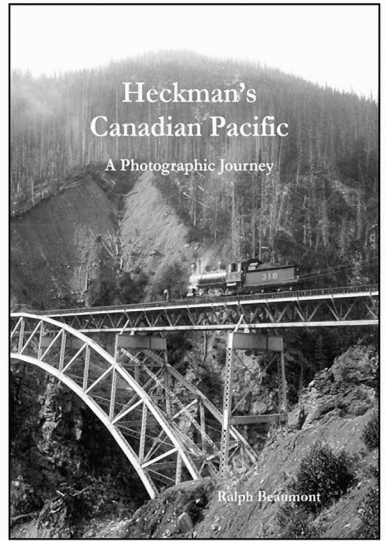

\$60.00 + Shipping & GST  
ISBN 978-0-9784406-1-9  
Large 9 x 12 format  
Hardbound  
328 pages - 380 B&W Photos  
25 Maps, Index, Bibliography

Available June 2015 from:  
Credit Valley Railway Company  
2900 Argenta Road, Unit 24  
Mississauga, Ontario, Canada, L5N 7X9  
Canada/USA Toll Free: 1-800-464-1730  
Online at: [www.cvrco.com](http://www.cvrco.com)

• INDEX

• TABLE OF CONTENTS

The Get the Latest Model Railroading News, Tips, Reviews & Opinions

# SCOTTY MASON

S H O W  
The Original Model Railroad Podcast

## -Monthly Interviews

- Modeler's Spotlight: Top Modeler's Talk
- Narrow Gauge Modeling w/Chris Lane
- Contemporary Modeling w/ Mike Rose

## -More Product Announcements & Reviews



Our feed has changed! To get the latest shows, Please search Scotty Mason and subscribe to the new feed!

[www.TheModelRailroadPodcast.com](http://www.TheModelRailroadPodcast.com)

Scott Mason Jimmy Simmons Mike Rose Joe Duckworth

### ADVERTISEMENT



## Archer

FINE TRANSFERS  
PROUDLY SERVING MODEL BUILDERS SINCE 1989

### THE ORIGINAL SURFACE DETAILS™

WE NOW HAVE MORE  
THAN 100 SHEETS OF  
RIVETS, LOUVERS,  
TREADPLATE AND  
MORE CAST ONTO  
MICROSCALE CLEAR  
DECAL FILM

### FREE SHIPPING:

- DOMESTIC USA ORDERS  
\$50 OR MORE
- INTERNATIONAL ORDERS  
\$100 OR MORE

CLICK HERE TO  
VISIT OUR WEBSITE!

*"Archer rivets  
are easy to apply  
and look great.  
To me, they are  
now a vital tool  
in building  
railroad models."*

Tony Thompson, Model  
Railroad Author/Historian



Archer Fine Transfers • PO Box 1277 • Youngsville, NC 27596 • USA  
(919) 570-1026 • info@archertransfers.com • archertransfers.com

### ADVERTISEMENT

## TRINITY 3281 SUMMER 2016



Norfolk Southern -- 12 #s

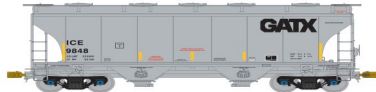

ICE-GATX -- 8 #s



Winchester & Western -- 12 #s



NRLX Ciment Quebec -- 12 #s

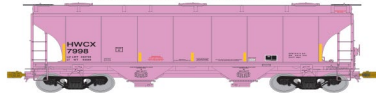

HWCX -- 7 #s

**American Limited**

[www.americanlimitedmodels.com](http://www.americanlimitedmodels.com)

• INDEX

• TABLE OF CONTENTS

# Bowser

## EXECUTIVE LINE

HO Freight Cars:

### F30a Flat Cars, 55 Ton Fishbelly & U-Channel Hopper Cars

Ready to Run with added brake wheel, under frame, air tank, brake cylinder, triple valve, free rolling trucks with metal wheels and knuckle couplers.

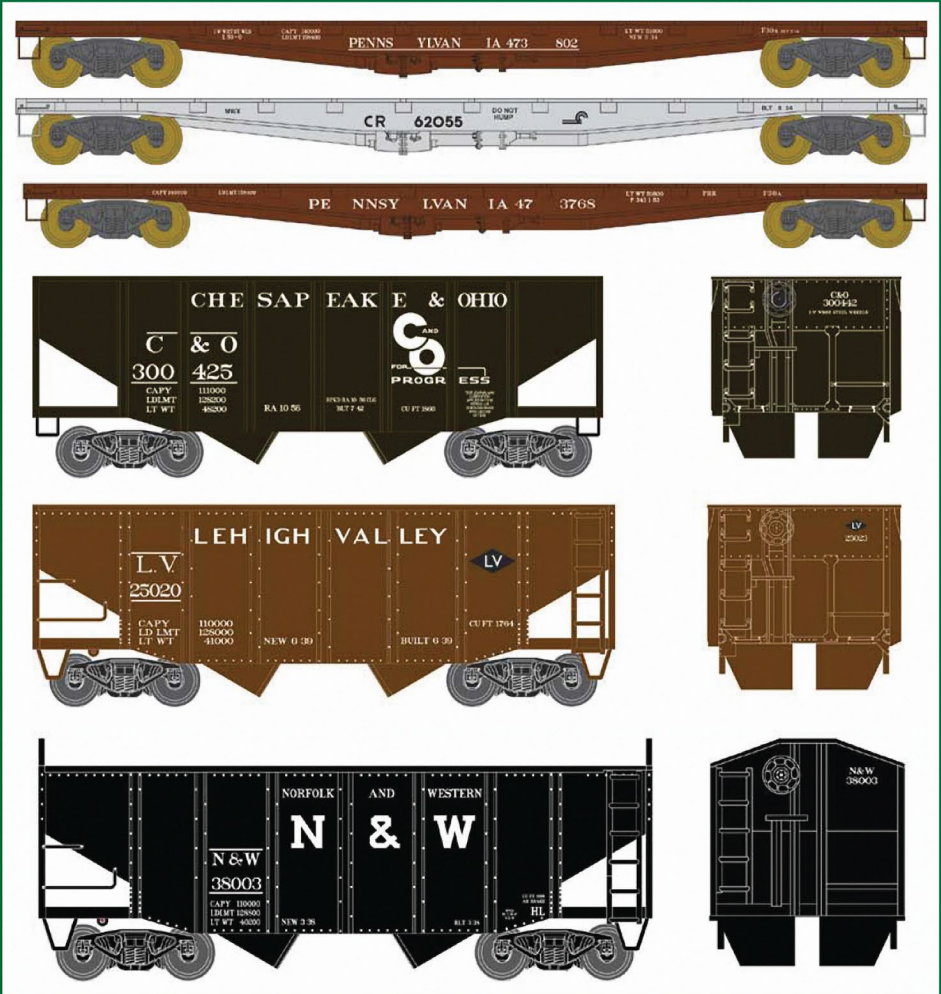

Click here to check out the details for these and other great Bowser products!

• INDEX

• TABLE OF CONTENTS





# MRH Q-A-T

column

compiled by  
**JOE BRUGGER**  
.....



[Click here for  
reader comments](#)

## QUESTIONS AND ANSWERS

### Sticky figures

**Q.** I want to glue some HO figures to a hard surface (styrene sidewalk). What is the best glue for this so they can be removed and then repositioned somewhere else?

—MSTSMAN

**A. Trainmaster247:** Some of the small double-stick dots might work. I don't see those being very obtrusive and they wouldn't be permanent. Or, mount your person to a movable sidewalk tile so they can be rearranged.

**Note:** One brand is "Glue Dots." Search for "double-stick dots" online, or look at craft and art stores. Whether you use glue, dots or poster putty, test a spot of the material on the scenery surface to assure yourself that it won't leave an unwanted grease spot.

▶ MRH QUESTIONS, ANSWERS, AND TIPS

## MRH Q-A-T | 2

**Rick Wade:** Rubber cement should work and is removable.

**Eric Warhol:** I have heard of poster putty being used to hold figures in place, allowing them to be moved later.

**Jimbob133:** I use Woodland Scenics Scenic Accents Glue. Put a dab on the bottom of the feet. It goes on white and dries clear. It stays tacky, so place the figure where you want. When it's time, pick them up and reposition where you want.

**Graham L.:** For temporary photo set-ups, I use UHU's glue stick, which is water-soluble.

**Bob Bochenek:** Aleené's Original Tacky Glue works for me. I have also used "ZOTS." ([amazon.com/Thermoweb-Adhesive-16-Inch-64-Inch-300-Pack/dp/B00161QK5Q](https://www.amazon.com/Thermoweb-Adhesive-16-Inch-64-Inch-300-Pack/dp/B00161QK5Q)) Both are available at craft stores.



1. Tacky glue and putties can eliminate the need for a plastic stand under movable figures.

**Santa Fe Willie:** Woodland Scenics Scenic Accents Glue works well until after you move a figure 10+ times! Then just rub it off and start again. I also use it to semi-attach roofs to structures if I may want to add interior lighting later.

Read the whole thread at [mrhmag.com/node/24346](http://mrhmag.com/node/24346).

## Spanning the gap

**Q.** Does anybody have experience with Gapmasters? My odd-shaped railroad room is causing me all sorts of design headaches. A portion of my layout will have to be disconnected and moved when the layout is not in use. I'm looking at five track breaks, all at different elevations on the layout.

For modules, Fremo segments, and layout elements that must be moveable, this would seem to be a way to go. I'm curious to hear from experienced users of the product.

—dkaustin

**A.** A Gapmaster is made of an engineered composite and allows creating perfect electrical gaps while eliminating derailments or misalignment. Solder rails down and cut electrical gaps in the rails afterward. Gapmasters are made to match flex track and handlaid ties in several scales and gauges. See [americantieandtimber.com/index.html](http://americantieandtimber.com/index.html).

BNM Hobbies end tie plates are machined printed circuit board material dimensioned to replace the standard Free-mo interface joints which use a 2" fitter rail. They are available in versions to be used at any module end and can also be used with drop, lift, and removable layout sections to maintain rail alignment. See [bnm-hobbies.com](http://bnm-hobbies.com).

The engineered parts from both companies replace wood or plastic ties at the gap to better resist handling damage.



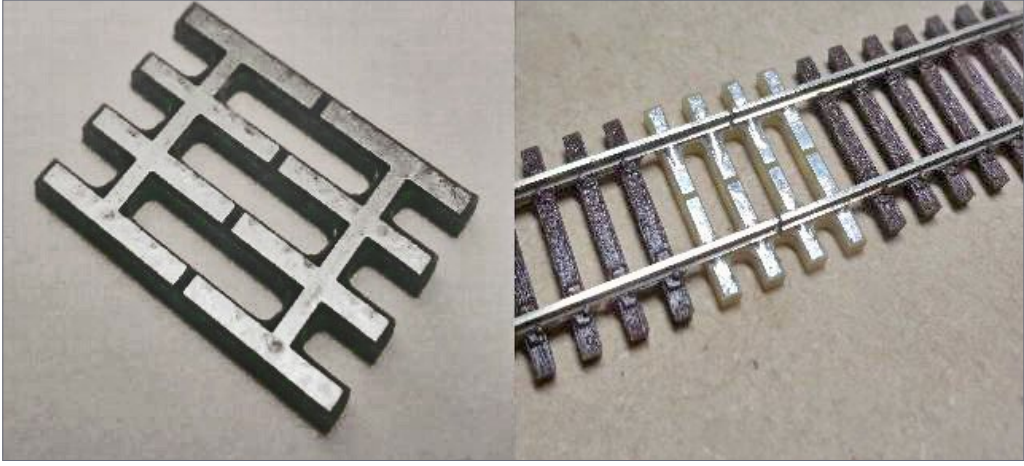

2. This Gapmaster is installed on N scale Micro Engineering Code 55 flex track. *American Tie & Timber Co. photo*

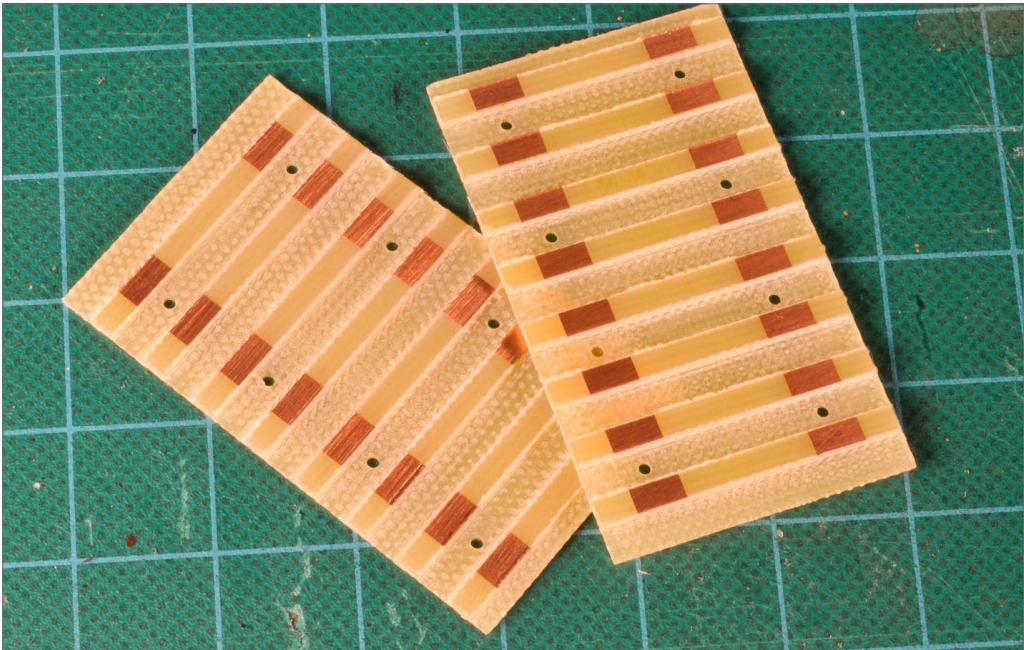

3. BNM Hobbies ([bnm-hobbies.com](http://bnm-hobbies.com)) offers a gap-alignment product in several versions. *MRH photo*

**Rick Wade:** I used Gapmasters for my swing gate and I'm very happy with them. Everything is still in alignment and there are no problems with trains going over them. Here's the link to my blog: [mrhmag.com/node/16081](http://mrhmag.com/node/16081).

**Dave:** I use some Gapmasters in N scale and they work great and look good. Well worth the price, and great service.

**Rbrodzinsky:** A number of the newer FreeMoN modules for the Silicon Valley group are using them and they have been much more reliable than individual PCB ties. One big reason is that there is no height difference between the track ties and the Gapmasters, vs. the slight difference in the PC board thickness. Plus, it is easier to properly affix a single item at the end plate versus four or five individual ties.

**Umauma Railway:** Even though my tracks don't carry power, I have used FastTracks PC ties at joints instead of rail joiners. MC Fujiwara noted that he puts a solid backer at the ends of modules and then mounts the Gapmaster ties. I should have followed this advice, as the ends of my sections got some rough handling that resulted in having to shim under the roadbed where they meet.

The fact that Gapmasters makes ties for every conceivable scale and commercial track product as well as handlaid choices makes it an easy solution for your HOn3 joints. I say give it a try. Five times two-and-a-half bucks would be worth the small expense.

**Dave B.:** I get the same effect by gluing down a couple of PC board ties at the ends of removable sections. I'd either use the Gapmasters, PC board ties, brass screws set flush below the rails, or something similar to strengthen the end-of-section rails

against accidental bumps and to help keep the alignment of the joint when it's reassembled.

**Kevin Rowbotham:** Type Gapmasters into the MRH Forum search field at top right and click Search. It will bring up four or five threads where Gapmasters are mentioned. I have to agree with DaveB. If one has PC ties on hand, just use those. If not, perhaps Gapmasters make sense for you.

Look for more information at [mrhmag.com/node/24337](http://mrhmag.com/node/24337).

## Spur track problem...

**Q.** After gluing down a spur track and testing it with a free-rolling car, I noticed that the car wants to roll just enough out of the spur to foul the other track. There is just the slightest slope, of course in the wrong direction. I think I will need to remove the track, and rasp down the foam to give it a little slope in the other direction. That is going to be a pain so I thought I'd ask if anybody had a better solution. When laying spur tracks be sure they are either dead flat or sloping away from the switch. I really thought the track was flat before I glued it. Should have triple-checked.

—Randy Seiler

**A. Rob in Texas:** Unless your house has shifted or settled or your benchwork has sagged, your first solution is likely the best. You could check to see if there is some sag. I would check the other spurs in the area and see if it is just an oversight on one track, or if there is a sag in the area. If it is not a structural issue I would fix the spur.

**BARR CEO:** You can put a derail in before the fouling point. It can be as simple as a piece of wire stuck between the ties, or as detailed as a scale derail put on a working switch machine of some kind to set it. Make it part of "setting the brakes" on the car.





4-5. Here is a car holder built using a Caboose Hobbies ground throw. *Ray Schofield photo*

**Joe Atkinson:** Randy, I had a similar issue at the end of a double-ended yard track, but was surprised at how little it took to correct the issue. Try prying up a very short stretch of the track near the clearance point and sliding a shim (perhaps a spare tie sanded down a bit) under the existing ties.

**Bob Reck:** I had the same issue on two of my industrial tracks. It did not show up until after I switched over to metal wheels and tuned up my cars. The quick fix that Joe A. describes works great and is an easy solution.

**Shortliner:** A simple cure like sliding a short piece of .005” or .010” styrene (or both) under the track may raise it just enough. Use a thin metal spatula ( from an art store, or speak to your dentist nicely) to insert the styrene in the region of the clearance point to raise the track in a small hump so the cars roll away from it. Then cover it in ballast. Don't forget to put rail stops at the end away from the turnout!

**Rob in Texas:** The only issue with blocking up the clearance point area is the car will roll to the end of the grade and stay there instead of in front of the loading door where it was spotted. If accurate car spotting is important or more than one car will be on this siding, you might be happier that it was fixed in the best way possible rather than a shortcut.

See the threads at [model-railroad-hobbyist.com/node/24367](http://model-railroad-hobbyist.com/node/24367) and [model-railroad-hobbyist.com/node/21522](http://model-railroad-hobbyist.com/node/21522).



**Click here for  
reader comments**

# MRC's Light Genie™

**A Unique Radio Control Light System.  
Works with All Model Railroads.**

*No other lighting control system delivers all these advantages:*

- Light Genie's wireless, RC range of 90' puts an end to being tethered to a switch panel.
- Transmitter and receiver control 12 light outputs, including 3-way, automatic traffic lights, and deliver more than 20 different lighting effects
- Control on-off, brightness/dimming, flickering, flashing, strobe, beacon, sequential lighting, alternating flashing lights and fire-effect flickering

- Not just for buildings, Light Genie also handles traffic lights, street lamps, railroad signals, emergency vehicle flashers, road side flares, campfire vignettes and more

- Compatible with all scales and virtually all lighting accessory brands. Use with LED or incandescent bulbs



RAILROAD SIGNALS



BUILDING LIGHTS



STREET LIGHTS



TRAFFIC LIGHTS



WIRELESS REMOTE AND RECEIVER



Enjoy Railroading More. Easily.

**CLICK HERE**



MODEL RECTIFIER CORPORATION  
80 Newfield Ave. ■ Edison, New Jersey 08837 ■ Phone: 732 225 6360 [www.modelrectifier.com](http://www.modelrectifier.com)

TECHNOLOGY. PERFECTED.

Model railroads  Plastic model kits  Battery chargers  Radio control helicopters, planes, cars & boats  Slot Cars  Scenery  Die cast



 TIPS

## Sandpaper clog

I was building a road on my South Olympic Branch layout. Sanding plaster was filling up the grit on the sandpaper quickly. I wondered if a small soft metal brush would unclog the grit and make the sandpaper last longer. I tried it and found that lightly tapping the brush on the paper unclogged it.

—Larry Sloan



**6. Tapping clogged sandpaper with a wire brush does a good job of clearing clogged paper. *Larry Sloan photo***

## Recycled signs

I have been using snipe signs as material to build up temporary structures for a while now, so I thought I would share a picture. For those unfamiliar with snipe signs, they are also called bandit signs, Buy Your House signs, Sell Us Your Car signs, We Buy Junk Car signs, etc. etc. The material is called “fluted E board.” Where I live they are considered litter and can be removed from the side of the road by anyone. So I do.

# MRH Q-A-T | 10

For people who insist on paying, the signs are available at home improvement and hardware stores.

—John Buckley



7. John Buckley mocked-up a Morton Salt plant using sign board corrugated plastic to see how the space works and to have a place to operate to. When time and funds permit, he will replace it with an exact model. *John Buckley photo*

## GET PAID FOR YOUR TIP

We pay \$25 per tip we publish, or \$40 each if the tip also includes a photo or finished drawing. [Click here and select article type TIP.](#) ■

# From first train set to railroad empire...

*Our complete line of DCC products  
grows with you. Discover the fun!*

- Designed and manufactured in the U.S.A.
- Preferred for ease of use and ergonomic design
- Unlimited scalability for any size model railroad
- Plug-and-play means more time running trains
- Great customer service and excellent support



## See your dealer





## Visit our new and improved web site for all your DCC needs!

- Get the latest new product announcements
- Watch our detailed how-to videos
- Browse the all-new Information Station
- Enjoy secure online sales, day or night!

Visit **ncedcc.com**



# TONY'S TRAIN XCHANGE

*Committed to your DCC support!*

## NCE Power Cab & NCE SB5



Pair Them For The Perfect  
DCC System For Your Layout

NCE Power Cabs  
Starting at \$155.95

**Order Yours**

## CMX Cleaner Car



Superior, All-Brass Build Quality, Super  
Easy To Use & Cleans Exceptionally Well

Starting at \$149.95

**Order Yours**

**Find Us At The Amherst  
Train Show, Jan. 30 - 31!**

Call to place your orders now  
for pick up at the Big-E show!

## Broadway Limited HO GN S2 4-8-4



Expected  
in February!

Brass Hybrid Series,  
Synchronized Puffing Smoke,  
Paragon3 Sound & DCC  
Featuring Rolling Thunder

\$589.95

**Order Yours**

**Do you need a Sound or  
DCC Installation done?**

**Get a quote!**

**TONY'S  
TRAIN  
XCHANGE**  
DCC SPECIALISTS

Providing unmatched person to person  
DCC support for more than 20 years, the  
kind of service that has made us #1 in DCC.  
**DCC questions? CALL US! 1-800-978-3472**  
\*Mention this ad for \$5.00 off your next order over \$100!

*We'll get you on the right track!*

Jan 2016





# DCC IMPULSES

column

BRUCE PETRARCA  
.....



[Click here for  
reader comments](#)

## ECONAMI DCC + SOUND INSTALLATION INTO AN O-SCALE WEAVER RS3

### **THIS MONTH, I'VE DECIDED TO MERGE A**

review of the SoundTraxx Econami 4-amp (ECO-400) diesel decoder with an O scale installation example. While this is O scale, there are some hints and tips along the way that work in all scales.

This loco belongs to a friend. I operate on his O and On30 layout once a quarter or so. His On30 operators are having so much fun with wireless DCC and sound that he decided to convert his standard gauge to DCC by adding a booster and enhancing some of his wiring. He needs a DCC loco for the job. Since this loco [1] has been his workhorse, what better place to start than here?

Before jumping into this installation, I recommend you review my first few columns, starting in October 2011 ([mrhmag.com/magazine/mrh-2011-10-oct/dcc\\_impulses](http://mrhmag.com/magazine/mrh-2011-10-oct/dcc_impulses)). The first few

► DCC TIPS, TRICKS, AND TECHNIQUES



# DCC IMPULSES | 2

columns deal with tool selection and the necessary supplies and other aspects of DCC and decoder installation.

First thing, I opened the shell (remove six screws from near the trucks and under the fuel tank detail). I found two of my greatest no-nos [2] when I looked inside.



1. Starting point: a well-used Weaver Alco RS3 O scale locomotive.

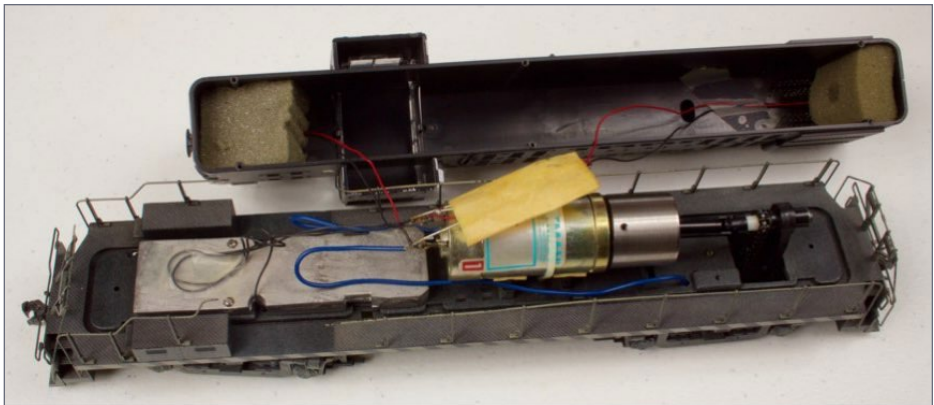

2. Inside of the Weaver RS3, getting ready to do a DCC installation.

## DCC IMPULSES | 3

The first no-no is using masking tape [3] to insulate the diodes that provide directional lighting. It has petrified. In the near future, I could anticipate the tape falling apart, possibly allowing the wires to short across the track. It appears that Weaver manufactured the loco this way.

A similar use of office supplies is the frosted-finish “magic” tape holding down the wires for the light bulbs [4]. The wiring run to the lights was so short that the shell could not be moved any further from the base than shown in photo [2]. I later learned from the owner that the idea was to pull the bulbs out of the lenses. Probably he used the “magic” tape when reassembling it from prior work. I place the engine on a small pottery wheel for this kind of work, using it as a lazy susan to rotate the model to reduce the amount of handling.

### ADVERTISEMENT



## Fun Features for a Fraction of the Cost!

As the most versatile, feature-packed sound decoder, **Econami** redefines *value*. Starting at \$79.95 and available now!



Hear how you can get more for less!

SOUNDTRAXX®

## DCC IMPULSES | 4

Why am I so harsh on these tape products? First, they are designed for use in an office environment: moderate temperature and humidity. They don't work well handling the high heat and reduced humidity found inside an operating loco. They deteriorate very quickly in harsh environments. Also, the "magic" tape is very easy to tear through, leaving pieces that stick to the shell and are hard to remove.

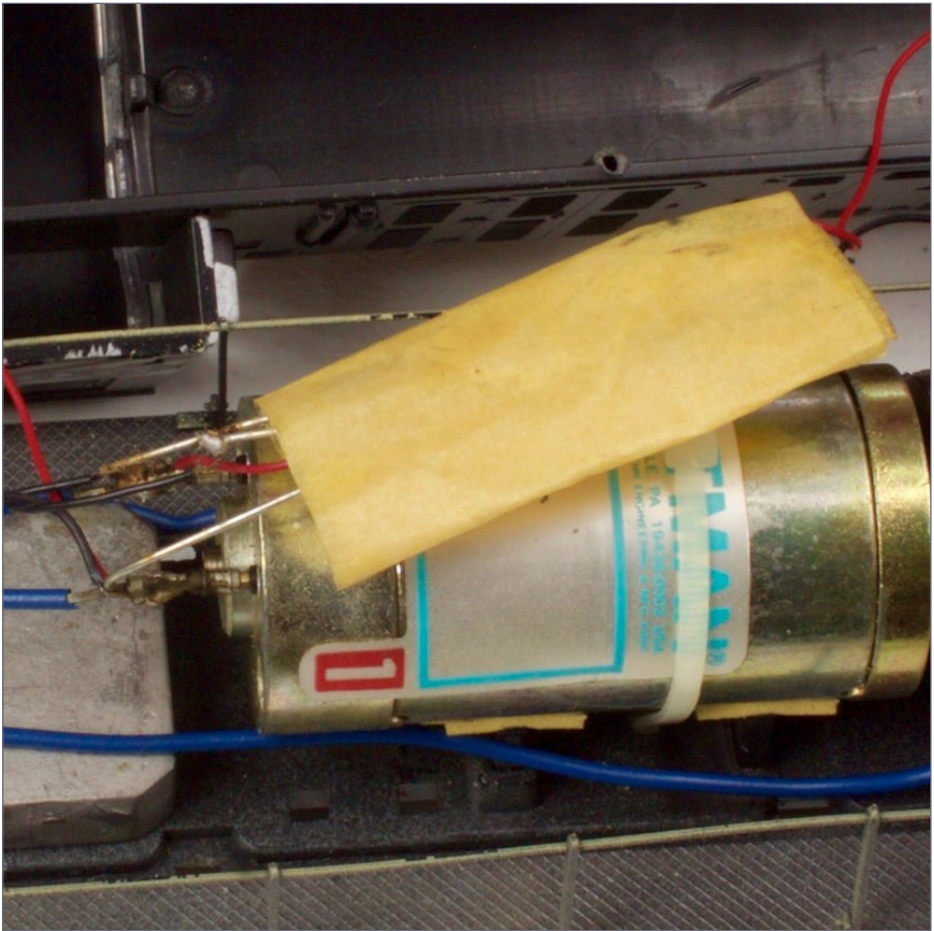

3. Close-up view of the interior, showing masking tape covering the light steering diodes.



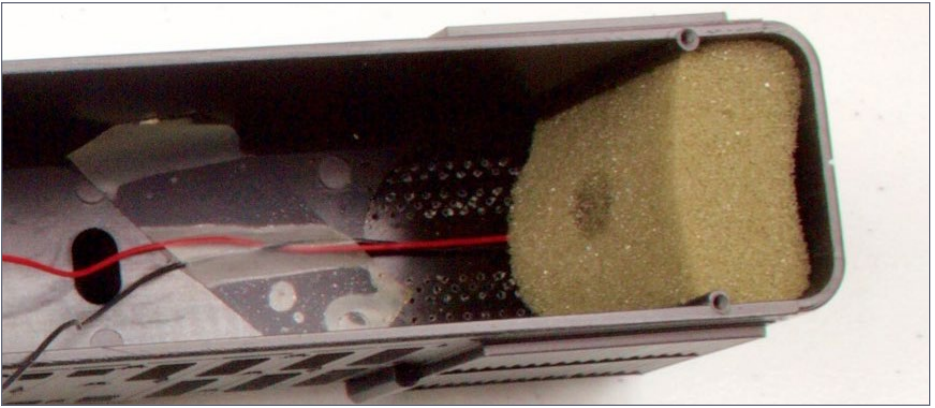

4. Close-up view of the interior, showing “magic” tape holding the bulb wires down. Also, notice the holes that the owner had drilled through the front fan grille.

Okay, back to the installation.

## Testing stall current

I didn't seriously test the loco's running status as I've seen it run under DC on the owner's layout several times. I recommend thoroughly evaluating any loco on DC before a DCC installation is begun.

I tested stall current ([mrdccu.com/curriculum/stall.html](http://mrdccu.com/curriculum/stall.html)) with a power supply adjustable from 0 to 3 amps and able to put out 0 to 18 volts. I set the current at maximum and the voltage at 12 V and stopped the motor by holding my finger on the flywheel. The power supply showed a stall current of about 2.75 amps, well within the 4 amp rating of the ECO-400. Running current was in the 1 amp range. The final installation runs fine on my PowerCab, drawing about .4 amps.

Before I opened the loco, I took time to clean the wheels. With the loco upside down in a foam cradle, I used clip leads to connect DC

# DCC IMPULSES | 6

power to the copper pickups in one truck. I applied power from my power supply (could be a power pack) such that the wheels turned at a modest rate. Denatured alcohol was applied with numerous cotton swabs until they came away clean. Then, I polished the wheels by turning them against a 600 grit nail polishing stick.

## How do I get the sound out?

Long time readers know that I eschew putting speakers in boxes. Well, the owner had drilled a lot of small holes in the front fan grille [4]. This is a perfect location for my “out of the box” speaker baffle design. All I needed to do was find a speaker to fit inside the opening, which measures about 30 mm.

ADVERTISEMENT

ADVERTISEMENT

HO GP60M, GP60B AND GP60 Locomotives

9747 Southern Pacific

9889 COTTON BELT

DC OR DCC WITH SOUND!

www.foxvalleymodels.com

Installing DCC sound just **NOT** your thing?  
Trust Traintek for sales and installation of sound decoders from these fine vendors!

ESU DCCtrax QSI SOUNDTRAXX DCC

RailPro™

"Taking model railroad control to the next level ..."

traintekllc.com

Click here for more details...

"Traintek was the way to go!"

*“Long time readers know that I eschew putting speakers in boxes.”*

I tried several candidates. It is always nice to have a selection of speakers available when you are doing an installation. It makes selection easier than trying to guess what size will work best and buy or order it.

I tried a 27 mm round high-bass speaker and found that it failed to cover all the holes that had been drilled in the grille. If there were no holes, I'd use that speaker and make sure that the holes were all inside the annular ring of the speaker mounting. In addition, this speaker would require a bit of shimming, as the cone can move in front of the mounting plane by about 0.04 inches.

Staying in the round high-bass vein, I tried a 32 mm round and found that it was just too big. It rode up on the rounded sides of the shell.

Next, I tried a 28 mm square high-bass speaker with a plastic frame. It fit nicely between the sides of the shell. The curvature of the shell held it off the roof, providing clearance for the cone.

The space between the speaker and the roof would eventually be filled with caulk [5]. The speaker was glued in place against the shell with MEK, but any styrene cement would suffice. For information on adhesives that I prefer, check out my web site ([mrdccu.com/curriculum/adhesives.htm](http://mrdccu.com/curriculum/adhesives.htm)).

The speaker selected was rated for 2 watts and the decoder will put out 3 watts. This could be a problem if you ran the volume



## DCC IMPULSES | 8

all the way up. This decoder/speaker combination is so efficient that, with the volume set at about one-quarter, it is still loud in the next room. This probably means that the actual power being delivered to the 2 watt speaker is  $\frac{1}{2}$  watt or less. Be cautious if you use a speaker rated less than the decoder. If you hear distortion, especially on the horn or whistle, turn the volume down until the distortion stops.

A word about the caulk: I like to use clear caulk. It less obvious from outside the loco than white or colored caulk. Thus, I had to shoot the photo [5] before the caulk dried, as it goes on white and dries clear. You can also see where the caulk is inserted into the mounting screw holes that are not used in this installation, but would be a sound leakage path from the front of the speaker to the back. Once the caulk dries, it will be almost invisible inside the loco. Only its shiny surface will give it away.

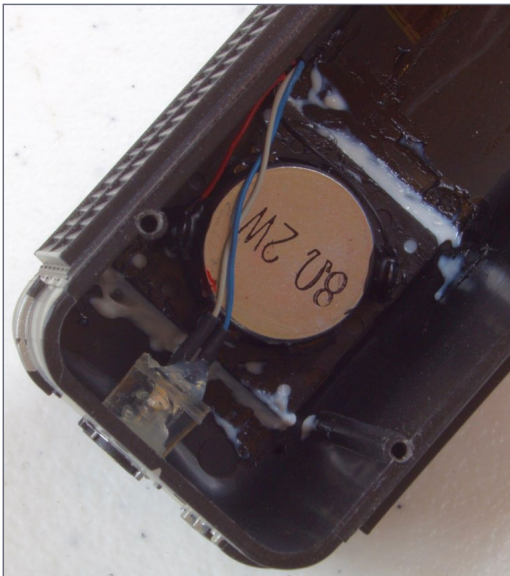

5. The 28 mm square high-bass speaker is mounted inside the shell under the drilled-out fan grille. It is sealed to the shell with clear caulk. The caulk is currently white, as it was applied just before this photo was taken. Note the white caulk plugging the mounting holes in each corner of the speaker. This keeps the sound confined to the side of the cone that generates it.



## LokSound L -Premium Quality Low Cost DCC and Sound in O Scale!

Coming Soon in "Atlas O"

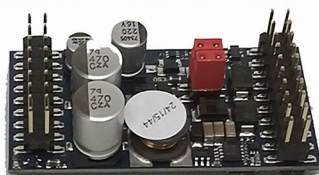

Each Decoder set  
comes with Decoder  
and Adaptor board



## FULL FEATURED "LOKSOUND L SELECT"

ESU Item# 73399 **\*\*ONLY \$149.99\*\***  
Shipping Now!

- Dimensions: 1 Inch x 2 inch
- Amperage: 3Amps continuous (up to 4Amps for a short time)  
Overload Protected
- Function Outputs: 11(!)
- Servo Outputs: 2
- And More Features!

- 
- Perfect for ESU Synchronized Smoke Units 54678 and 54679 with supported Sound Files
    - Smoke units will work with Steam and Diesel files
    - Smoke units can be set up to work with Smoke Chuff and Cylinder Steam!

**Click here for  
MORE FEATURES ...**

Also Available: 54399 Fully Programmable LokSound L V4.0 199.99

ESU LLC 23 Howard Street Montoursville PA 17754 - 1-570-980-1980

**[www.LokSound.com](http://www.LokSound.com)**

# DCC IMPULSES | 9

How does the sound actually get out? For background, see my August 2012 column and the accompanying video ([mrhmag.com/magazine/mrh-2012-08-aug/dcc\\_impulses](http://mrhmag.com/magazine/mrh-2012-08-aug/dcc_impulses)). In this case, half the sound goes up and out of the grille. The other half is forced down through the mechanism and out the truck opening.

## Lights?

Knowing how much I hate to dig back into locos after I've installed a decoder into them, you will probably be ahead of me and know that I would install LED lighting.

T1 (3 mm) LEDs fit nicely into the lenses where the bulbs came out. They can be held in place with either clear caulk or canopy cement. I chose warm-white 12 volt LEDs, as no resistors are

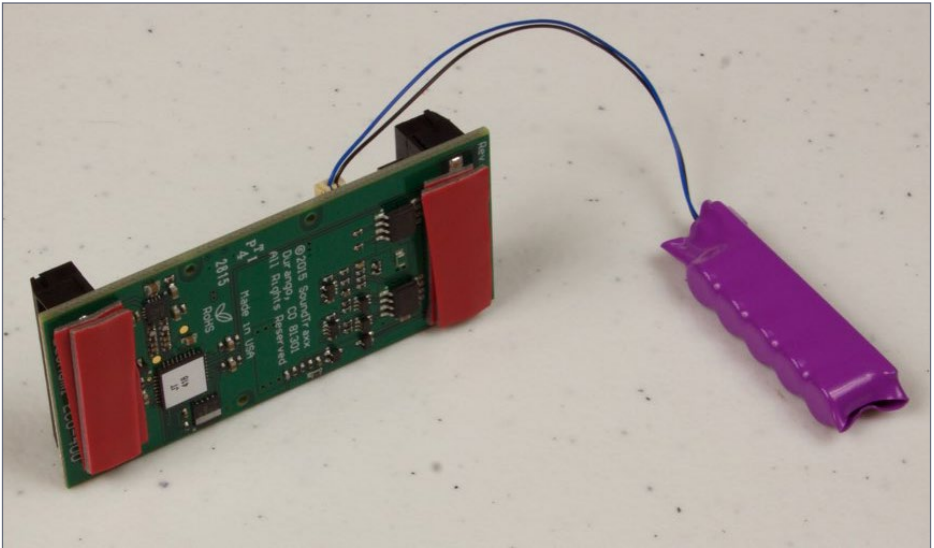

6. A double layer of gray tape (with red backing) on the decoder screw terminals raises decoder up from baseplate so chips don't contact the metal plate. The tape also insulates the screw terminals.



# DCC IMPULSES | 10

needed and they have a color consistent with the headlights of this loco's era.

## How to mount the decoder?

There was plenty of room for the decoder and a CurrentKeeper energy storage module under the cab end of the shell. The CurrentKeeper module (purple) plugs into the side of the decoder (green board) as shown in [6].

The decoder and CurrentKeeper were mounted [6] using gray tape. A double thickness under the terminal strips prevents contact between components on the decoder board and the metal weight. Covering the screw terminal contacts with tape insulates them and provides room for some free-air cooling of

ADVERTISEMENT

### DCC and Sound in N Scale?

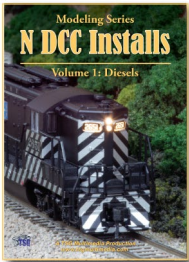

We'll show you how!  
*N DCC Installs*  
Examples with and without sound!

CLICK FOR DCC 

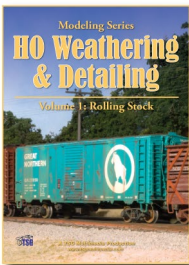

Want it now?  
Our titles are now available in digital download format!

CLICK FOR DIGITAL 

 **TSG Multimedia**

ADVERTISEMENT

### LC101 & LC201 (8 pin plug) DCC decoder



*High Performance*  
*High Compatibility*  
*Attractive Price*



- DCC standard decoder suitable size for HO scale locomotives
- Motor current 1.5 Amp continuous and 2 Amp peak
- 6x 100mA function outputs (For LC201 version)
- Back-EMF with silent motor control
- 28 step adjustable speed table
- Support long address



# DCC IMPULSES | 11

the components. The overall installation can be seen in [15]. The decoder will be a tight fit within the shell, especially with the CurrentKeeper connector on the side [13].

## Wiring

Before removing the DC wiring, I like to mark the side of the motor that is connected to the right rails. This will receive the orange (motor +) power connection, except in some G scale. I use a paint marker to put a + mark or red dot next to the proper motor terminal, as shown in [7].

I also found that the rear truck wires were inadequate. If left as is, and if the locomotive bridged opposite polarity – such as the right side wheels of one truck were on the left rail and the right side wheels of the other truck were on the right rail – the entire output of the DCC booster would be across the two wires between the trucks and the decoder until something tripped.

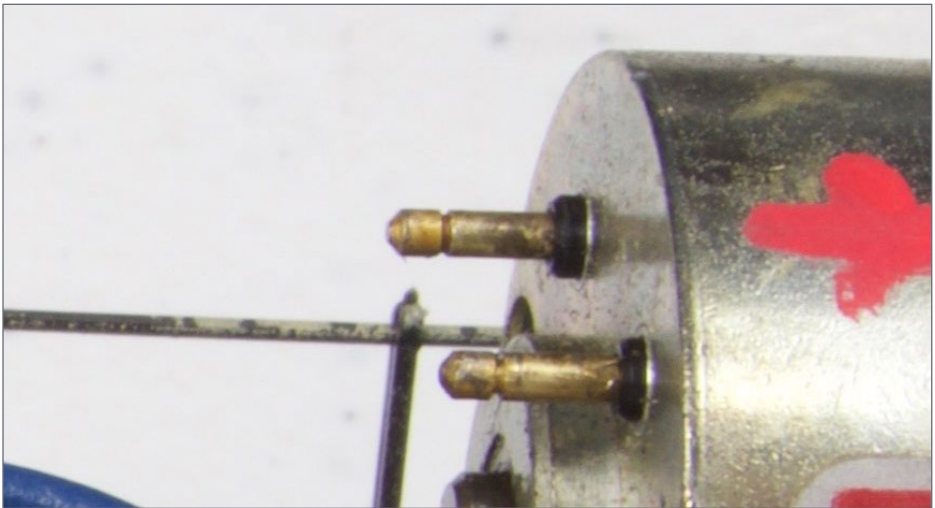

**7. Motor polarity mark: A red + mark next to the motor terminals that connect to the right rail when wired for DC.**

This could fry the smaller wire.

The wire from the front trucks was of adequate gauge, but very stiff and not to NMRA color code practices. I left it alone, but would probably replace it as part of a similar future installation.

The rear wire was replaced with 26 AWG wire of proper colors (red and black). I'd have liked a bit larger (22 AWG or so), but 26 was all I had between 30 and 18.

A friend with years of experience using screw terminals for low voltage applications (just what we are doing here) recommends against a practice that I've used in the past: tinning the stranded wire and inserting it into the screw terminal. He says that, over time, the tinned wire will relax and the screw tension will lessen. So, I've been using his ideas and adding solid sections to the stranded wire to make contact with the screw terminal.

So, the track connection to the decoder was made by twisting the two leads coming from the truck and soldering them to a piece of 20 AWG solid wire. The connection was covered with 1/16 inch shrink tubing [8].

Once the track wires were prepared [8], they were cut to length and connected to the decoder. A bit of Kapton tape was used to hold the wire from the rear truck into the space provided so that it won't be pinched by the shell [9].

I did the motor wiring with 26 AWG wire of the proper colors (orange and gray). The orange wire goes to the motor terminal identified by the + or dot. The decoder ends got 20 solid AWG tips, too. I connected the orange wire to the decoder on the motor terminal next to where the right rail had previously been connected.



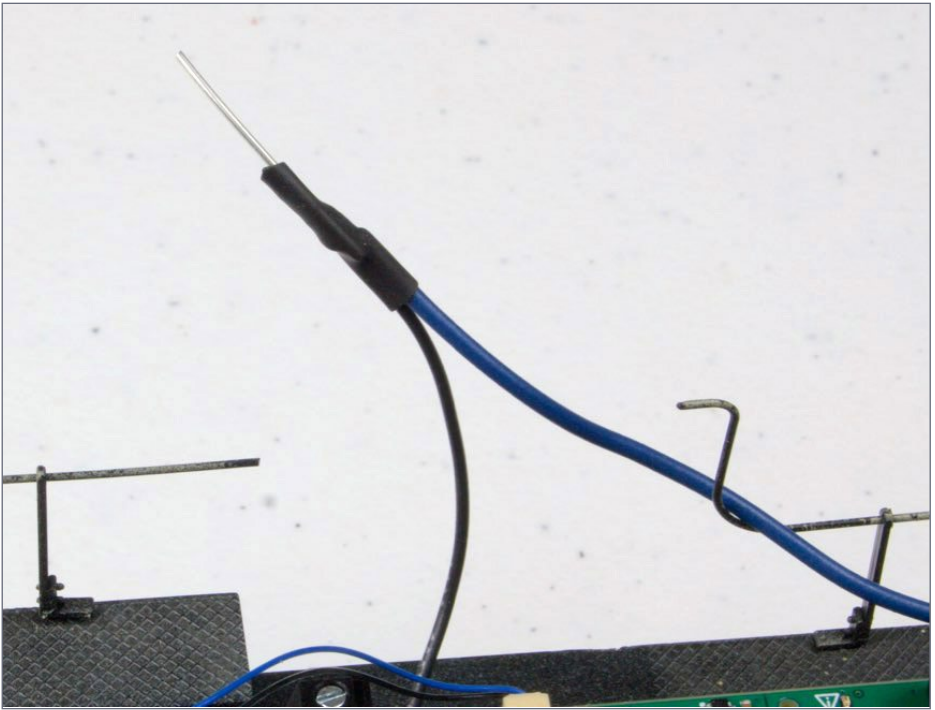

**8. Truck wires twisted and soldered to a 20 AWG solid wire for connection to the decoder screw terminals.**

LED assemblies were built by putting blue wire (30 AWG) on the long lead of the LED and covering the connection with 3/64 diameter shrink tubing. Similarly, a white or yellow wire was put on the other lead (white for headlight and yellow for rear light). Once the wiring was complete, the wires were twisted slightly with a power drill as shown in [10].

In a similar fashion, the speaker wires were extended using purple wire (30 AWG) and twisted. Since this is a single speaker installation, there was no need to keep track of polarity with respect to the speaker wiring.

## DCC IMPULSES | 14

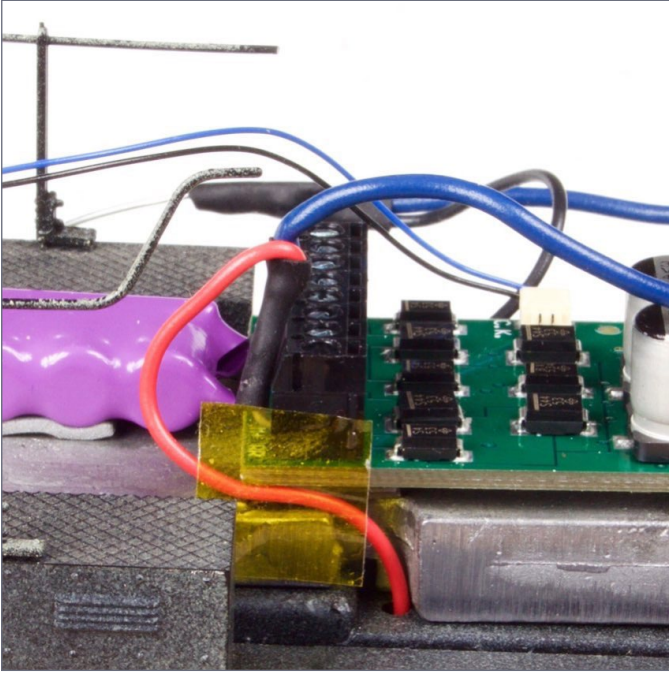

9. Side view of decoder with track wires attached. Kapton (yellow) tape was used to keep the wire in the groove while the shell was installed.

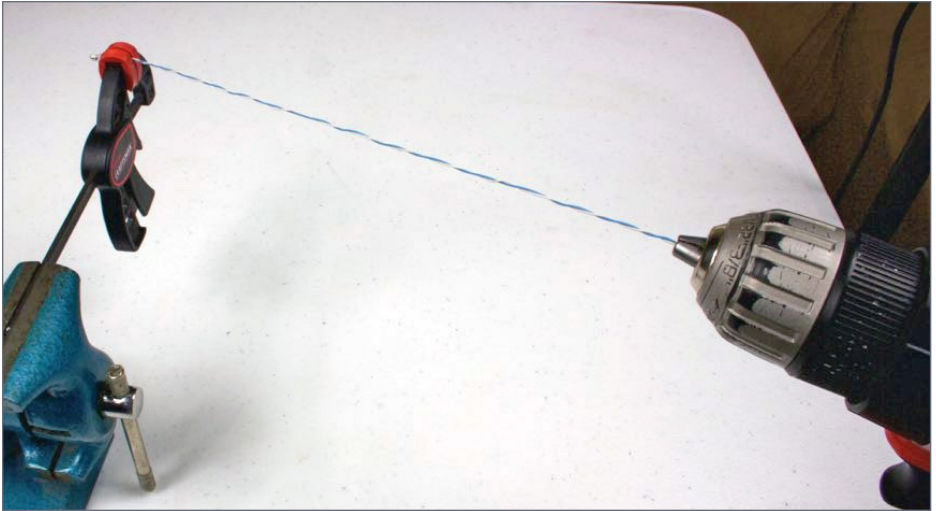

10. LED light wires being twisted with drill. LED is in a clamp attached to a vise on the left.

## DCC IMPULSES | 15

All of the wires in the shell [15] were routed inside 3/32 shrink tubing. Soda straws could have been used as easily, as the tubing wasn't shrunk onto the wires. The conduit created this way should be held in place with Kapton tape or caulk with the tubing held in place with masking tape until the caulk cures.

A 5-pin connector was made out of 50-pin header material by cutting into the 6th position. The pin or socket that came out was kept for another use later. A rotary tool with the sanding drum was used to square up the end of the connector.

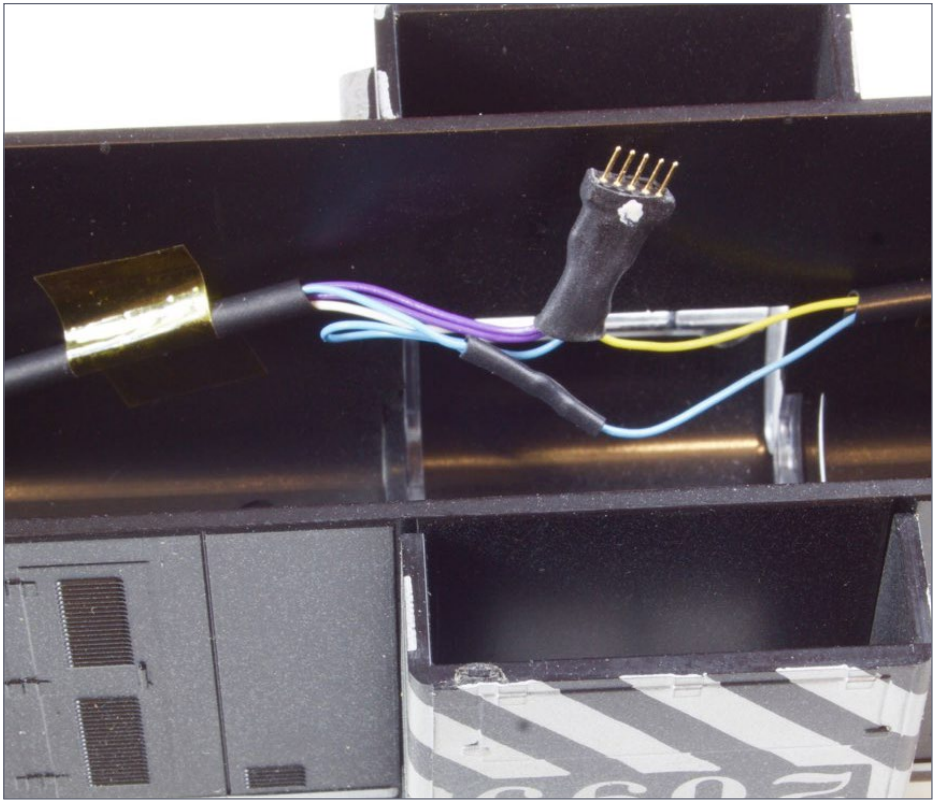

11. 5-pin connector in the shell to connect LEDs and speaker to the main frame. Note white dot to denote polarity.



# DCC IMPULSES | 16

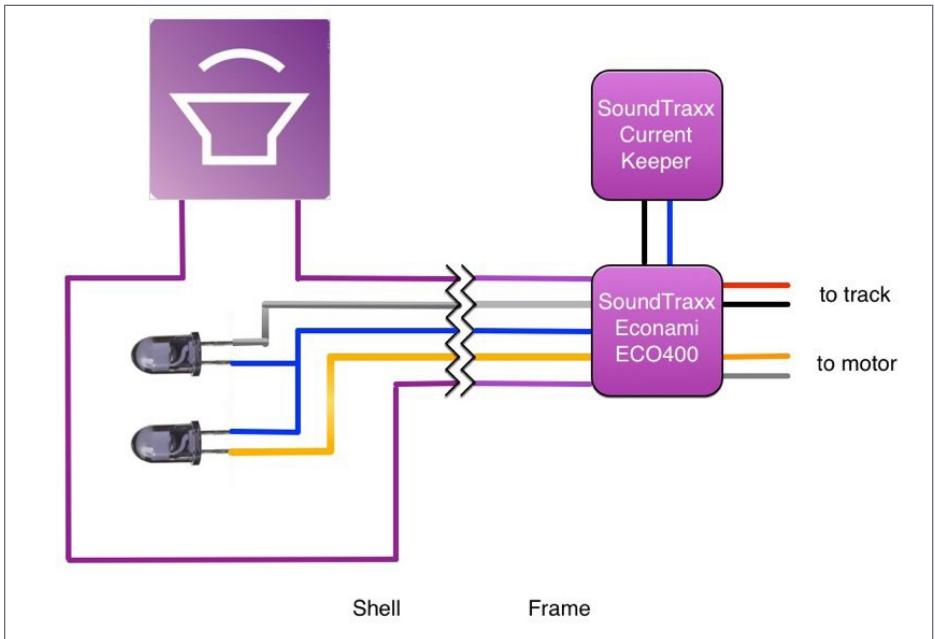

**12. Wiring diagram. Connect the female side to the decoder. Note that reversing the connection only exchanges the front and rear lights. No ill effects will happen if you rotate the connector this way. However, offsetting the connection by one position may damage the decoder, speaker or LEDs.**

The connector was wired per [12] with the male side in the loco shell. The smallest (3/64 inch) shrink tubing was used to insulate the white and yellow leads. Once all connections were made and tested, ¼ inch diameter shrink tubing was slipped over the entire assembly [11] and shrunk in place to provide insulation of all the wires and a neat appearance.

The female connector assembly was built to match the male assembly. The connector pins freed up from cutting the 50-pin header were used on the decoder ends of the wires. The wires were tinned and inserted into the female socket and then the

socket heated to melt the solder and make for a solid contact to insert into the decoder terminal. I keep these pins from installations and had enough in my box to do the installation. More sockets could be cut from the header if needed. Absent that, 20 AWG solid wire could be soldered to the decoder ends, as was done for the track and motor connections.

You will want to wire the female connector to the decoder: Blue to V+; White to HL; Yellow to RL; one purple to each of the speaker connections. Plug the male and female sides of the connection together and put a white dot on one side so that it will be easy to identify the mating sides when attaching the shell to the frame [10] & [15].

I've recently gone back to an ages-old electronic technique: waxed lacing cord. I found some on Amazon (see supplies list). This waxed product can be used to hold wires together in a bunch [13]. The heavy wires coming from the front truck to the rear of the decoder provide an excellent backbone for all the wires crossing the decoder. I wrap the cord around the bundle twice and tie it with a knot, either overhand or square. A quick touch of the soldering iron to the free end will melt it away and seal the knot -- no cutting required. In [13] you can see several knots. I tied them off as I went and then put a final pair on each side to neaten up the result.

### Finalizing the installation

Before assembly, there was one more issue. The owner wanted a figure installed in the engineer's seat. The Grizzly Mountain figure he supplied was glued (using caulk) inside the shell with his arm hanging over. It is slightly visible outside the loco. It is shown in [14] with the cab section of the shell removed to show details.

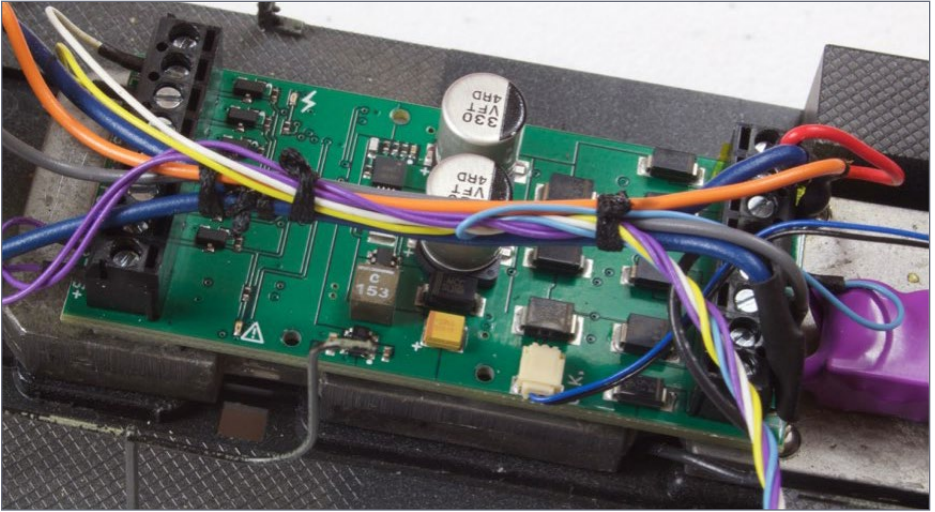

**13. Close-up of decoder area. Note routing of CurrentKeeper wires (small blue and black) to allow clearance for shell. Lacing cord is used to bundle the other wires together.**

Along the way all exposed friction points were lubed with Nano-Oil. The 5-weight product was used to seep into tight places. Once the 5-weight had soaked in, 10-weight was applied for permanence of lubrication. The 85-weight product was used on the chain and sprockets.

Never-Stall was applied to the sliding electrical contact between the pickup copper contact and the wheels. This will lubricate the contact and promote electrical conductivity.

The shell was set on top of the frame and the loco was tested. The programming track was the first stop. I verified that I could write and read by changing the address to 99 short and 2099 long with the long address active. Those changes showed that there was unlikely to be a major wiring error.



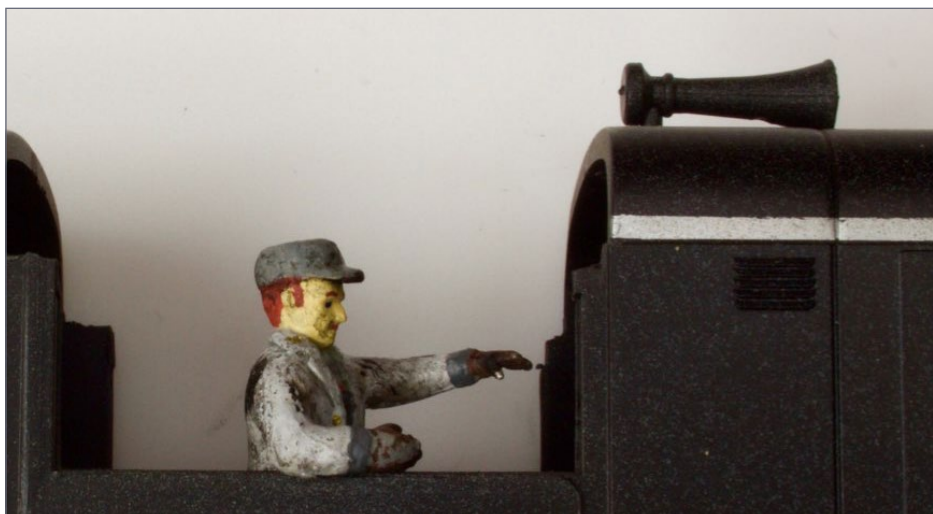

## 14. Engineer figure installed on the right side of the cab.

While I was there, I changed the motor sound to the Alco 244 by setting CV 123 to 4, as shown on the card accompanying the decoder.

## Econami evaluation

When the loco was closed and fired up, the full, rich sound of an Alco starting filled the room. I kid you not. It was devastatingly loud.

I hit speed step one on my PowerCab and the loco crept along the track in forward, then in reverse.

It was time to fire up DecoderPro ([jmri.sourceforge.net/download/index.shtml](http://jmri.sourceforge.net/download/index.shtml)) and make some adjustments. You will need version 4.1.1 or later to have the necessary Econami definitions.

I tamed the sound a bit. The adjustments shown in [16] were the first cut. I'll probably diddle a bit from there, perhaps taking the

# DCC IMPULSES | 20

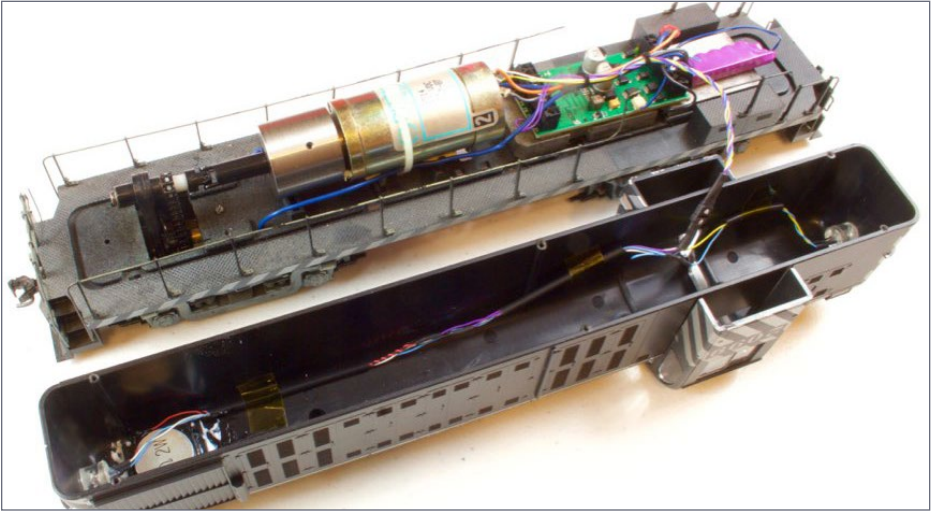

15. Overall view of completed installation.

## ADVERTISEMENT

**RailPro™**  
**NEW TECHNOLOGY**



**Click Here to Learn More**



**RE RING™**  
ENGINEERING

**NEW Starter Kit**  
**\$399.99 MSRP**

- Includes Wireless Color Touch Screen Handheld Controller and 56 Watt Power Supply
- Expandable to Virtually any Size Layout

**NEW Locomotive Module**  
LM-2 & LM-2S



- Direct Radio RF
- Sound and Non-Sound
- New Tiny Size
- 6 Light Outputs

For more information visit our Internet site: [www.RingEngineering.com](http://www.RingEngineering.com)

• INDEX

• TABLE OF CONTENTS

# DCC IMPULSES | 21

overall level down more to comply with the five-foot rule. With these settings, I can hear the loco in the next room.

## Equalizer

The equalizer is a fine feature, in my opinion. I've never adjusted individual levels in all of the Tsunamis and Econamis that I've installed. The presets are adequate. They are designed to adjust the low bass and treble to get the best sound out of various speaker sizes without overloading the speaker.

The equalizer is controlled with CV 225 [17]. I find that a setting of 1 to 3 in CV 225 gives the best sound for most speakers. This installation would up with CV 225 = 2. This makes sense as I'm using a speaker right at one inch, but it is a high-bass design and I find that you can go up one speaker size with high-bass speakers.

I had to look that up, as I used DecoderPro to set the CV and don't try to remember which CV does what for various decoders.

## Support documentation

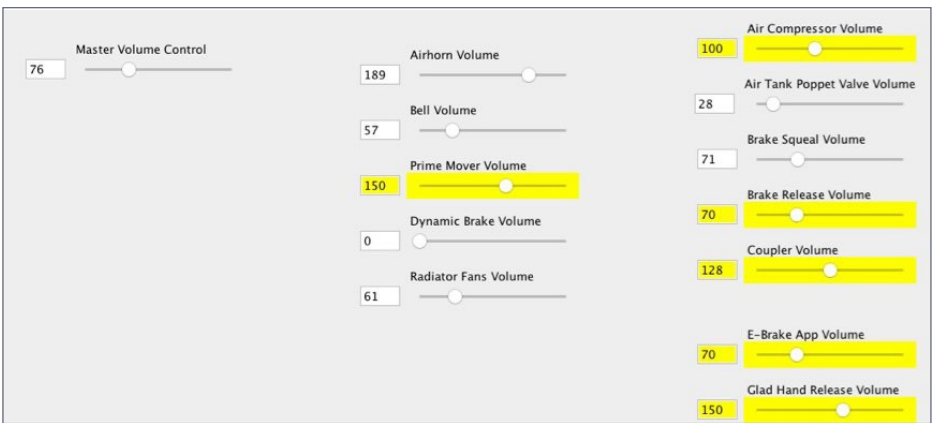

16. First cut at sound levels – DecoderPro screen shot.

## **EQ0-EQ2: Equalizer Presets**

- 0 = Flat (equalizer disabled)
- 1 = Micro speaker (smaller than 1")
- 2 = Small speaker (from 1" to 2")
- 3 = Medium speaker (from 2" to 4")
- 4 = Large speaker (larger than 4")
- 5 = Not used
- 6 = Not used
- 7 = User-adjustable (CVs 226-232)

**0:** Not used

### **Additional Information**

Setting CV 225 to a value from 1 to 4 will adjust the 7-band equalizer frequency response according to speaker size.

Setting CV 225 to a value of 7 allows the boost/cut levels of the 7-band equalizer to be adjusted using CVs 226-232. Setting CV 225 to a value of 0 will disable the equalizer, i.e., all frequency levels will be set to 0dB (flat).

## 17. SoundTraxx Econami Electrical Tech Reference information about CV 225.

The one-page card that accompanies an Econami decoder is barely adequate to show the connections and cover a few key CV settings. Full documentation is downloadable from the SoundTraxx web site at [soundtraxx.com/manuals.php](http://soundtraxx.com/manuals.php).

## Indexed CVs

The Econami introduced indexed CVs for the first time in a SoundTraxx product. Other manufacturers have used them for a few years, such as ESU (LokSound) and QSI. They are a way of overcoming an old DCC standard limitation of CVs at 256. Recent changes have expanded the total up to 512, but older systems still have the 256 limit.

In the literature you will find the normal CVs, such as CV 1, CV 29, and CV 123. But also, you'll find CVs such as 1.257. This is shorthand for indexed CVs. To set CV 1.257 to a value of 100



## DCC IMPULSES | 23

follow these steps. Set CV 32 = 1 then set CV 257 = 100. Once you try a few, you'll get the hang of it. Personally, I don't want to deal with the issue and I let DecoderPro do the work.

### Summary

I like the Econami and I like it in this loco. The sounds are crisp and accurate. It runs well at low speed without tweaking. It performed exactly as I expected, based on my experience with the ECO-100 product.

I did limit the top speed and the maximum volume for indoor use. Since this decoder will work with moderate garden locos, I expect the default settings are more in line with what would be needed in that environment.

Folks always seem to have additional ideas to share. Just click on the Reader Feedback icon at the beginning or the end of the column. While you are there, I encourage you to rate the column. "Awesome" is always appreciated. Thanks.

Until next month, I wish you green boards in all your endeavors.

*The next few pages have tables of parts, supplies and tools.  
Mr. DCC's Workbench follows the tables ...*



**Click here for  
reader comments**



# Southern Digital



**20% Discount  
on most Items!**

*Specializing in DCC Since 1992*



## DCC Conversions, Service & Support

Orders Received by 3:00 pm EST ship the same day

**WWW.SODIGI.COM**

E-mail: [sales@sodigi.com](mailto:sales@sodigi.com)

(770) 929-1888

*(Photo's are from our N-Scale layout)*

<b>PARTS</b>	
<b>Item</b>	<b>Part Number</b>
ECO-400 diesel DCC + sound decoder	SoundTraxx 678-882005
CurrentKeeper energy storage module	SoundTraxx 678-810140
High-bass speaker: 28 mm square plastic 8 ohms 2 watts	Litchfield Station SP-28SHB-08 or Railmaster Hobbies DHB-8
12 volt warm-white LEDs (qty 2)	Litchfield Station LED-3WW-12V
50 pin header stock (male and female)	Litchfield Station 575-500101 and 575-501101
Figure - Grizzly Mountain Engineering engineer	owner supplied

**When talking to hobby vendors, please remember to mention MRH.**

<b>SUPPLIES</b>	
<b>Item</b>	<b>Where I get it</b>
Clear caulk (Polyseamseal is my choice)	<a href="https://amazon.com/dp/B004Y6WWPW">amazon.com/dp/B004Y6WWPW</a> or home improvement store
Cotton swabs	<a href="https://amazon.com/dp/B00028LZOY">amazon.com/dp/B00028LZOY</a> or "Dollar store"
Denatured alcohol	<a href="https://amazon.com/dp/B0090QFFJQ">amazon.com/dp/B0090QFFJQ</a> or home improvement store
Nail polishing stick - 600 grit	<a href="https://amazon.com/dp/B0002C72BG">amazon.com/dp/B0002C72BG</a> or Sally Beauty
Emery boards	<a href="https://amazon.com/dp/B00LOL4QXG">amazon.com/dp/B00LOL4QXG</a> or dollar store
Kapton tape 1/2 inch x .001 inch thick	<a href="https://litchfieldstation.com/xcart/product.php?productid=999003138">litchfieldstation.com/xcart/product.php?productid=999003138</a>
Lacing cord, waxed	<a href="https://amazon.com/dp/B00NAOHSP8">amazon.com/dp/B00NAOHSP8</a>
MEK or other styrene solvent	<a href="https://amazon.com/dp/B00C1U2TYM">amazon.com/dp/B00C1U2TYM</a> or hobby shop or home improvement store
Nano-Oil: 5 weight, 10 weight, 85 weight	<a href="https://litchfieldstation.com/xcart/product.php?productid=999007592">litchfieldstation.com/xcart/product.php?productid=999007592</a>
Never-Stall	<a href="https://litchfieldstation.com/xcart/product.php?productid=999003384">litchfieldstation.com/xcart/product.php?productid=999003384</a>
Paint pen	<a href="https://amazon.com/dp/B002Q0S478">amazon.com/dp/B002Q0S478</a> or art supply store
Shrink tubing: diameters: 3/64 inch; 1/16 inch; 3/32 inch; 1/4 inch	<a href="https://litchfieldstation.com/xcart/product.php?productid=999002714">litchfieldstation.com/xcart/product.php?productid=999002714</a>
Tape - gray - 3M outdoor mounting tape	<a href="https://amazon.com/dp/B00004Z4BV">amazon.com/dp/B00004Z4BV</a>



## SUPPLIES

Item	Where I get it
Solder 60/40 rosin core	<a href="http://litchfieldstation.com/xcart/product.php?productid=999003041">litchfieldstation.com/xcart/product.php?productid=999003041</a> or electronics store
Wire 20 AWG solid (strip insulation off)	<a href="http://allelectronics.com/make-a-store/item/20gy-25s/20-ga-gray-hook-up-wire-25-solid/1.html">allelectronics.com/make-a-store/item/20gy-25s/20-ga-gray-hook-up-wire-25-solid/1.html</a>
Wire 26 AWG: stranded: red, black, gray, orange	<a href="http://allelectronics.com/make-a-store/category/825470/wire/cable/stranded-hook-up-wire-25-roll/1.html">allelectronics.com/make-a-store/category/825470/wire/cable/stranded-hook-up-wire-25-roll/1.html</a>
Nail polishing stick - 600 grit	<a href="http://amazon.com/dp/B0002C72BG">amazon.com/dp/B0002C72BG</a> or Sally Beauty
wire 30 AWG; white, yellow, blue, purple	<a href="http://litchfieldstation.com/xcart/product.php?productid=2450009">litchfieldstation.com/xcart/product.php?productid=2450009</a>



**DID YOU KNOW  
MRH  
SUBSCRIBERS  
GET FREE  
BONUSES?**

**CLICK TO SUBSCRIBE  
NOW - IT'S FREE!**

<b>TOOLS</b>	
<b>Item</b>	<b>Where I get it</b>
Diagonal cutters	<a href="https://www.amazon.com/dp/B0002BBZ4M">amazon.com/dp/B0002BBZ4M</a>
Foam cradle	<a href="https://litchfieldstation.com/xcart/product.php?productid=999005493">litchfieldstation.com/xcart/product.php?productid=999005493</a>
Heat gun	<a href="https://www.michaels.com/10107547.html?q=embossing+heat+gun">michaels.com/10107547.html?q=embossing+heat+gun</a>
Jeweler's screwdriver set	<a href="https://www.amazon.com/dp/B000NZ5QGK">amazon.com/dp/B000NZ5QGK</a>
Needle-nose pliers	<a href="https://www.amazon.com/dp/B004UNFE9U">amazon.com/dp/B004UNFE9U</a>
One-hand clamp	<a href="https://www.amazon.com/dp/B00002244V">amazon.com/dp/B00002244V</a>
Power supply, adjustable 18 V 3 A	<a href="https://www.mpja.com/0-18VDC-0-3-A-Variable-Benchtop-Power-Supply/productinfo/29600%20PS">mpja.com/0-18VDC-0-3-A-Variable-Benchtop-Power-Supply/productinfo/29600%20PS</a>
Rotary tool and sanding drum	<a href="https://www.amazon.com/dp/B008DRY5AI">amazon.com/dp/B008DRY5AI</a>
Soldering station	<a href="https://litchfieldstation.com/xcart/product.php?productid=999002741">litchfieldstation.com/xcart/product.php?productid=999002741</a>
Turntable for pottery making or sculpting – use to rotate locomotive and cradle for easier work	<a href="https://www.dickblick.com/products/activa-sculpting-wheel">dickblick.com/products/activa-sculpting-wheel</a> or <a href="https://www.dickblick.com/products/amaco-no-5-decorating-wheel">dickblick.com/products/amaco-no-5-decorating-wheel</a>
Tweezers: curved, straight, clamping	<a href="https://www.digikey.com/product-search/en?&amp;=4381&amp;FV=fff40013%2Cfff8034d%2Cfffc0048&amp;mnonly=0&amp;newproducts=0&amp;ColumnSort=0&amp;page=1&amp;stock=1&amp;quantity=0&amp;ptm=0&amp;fid=0&amp;pageSize=25">digikey.com/product-search/en?&amp;=4381&amp;FV=fff40013%2Cfff8034d%2Cfffc0048&amp;mnonly=0&amp;newproducts=0&amp;ColumnSort=0&amp;page=1&amp;stock=1&amp;quantity=0&amp;ptm=0&amp;fid=0&amp;pageSize=25</a>

# DCC IMPULSES | 28

## TOOLS

Item	Where I get it
Vise	<a href="https://amazon.com/dp/B005JVK1GS">amazon.com/dp/B005JVK1GS</a>
Wire strippers for 22 AWG to 30 AWG	<a href="https://litchfieldstation.com/xcart/product.php?productid=340001">litchfieldstation.com/xcart/product.php?productid=340001</a>

### ADVERTISEMENT



**IOWA SCALED**  
**ENGINEERING**

Master clock

Remote clock

8:26 AM  
FAST  
6, 8:1 7:23:36PM  
REAL HOLD RST CONF

8:26

Easiest-to-use, most advanced fast clock on the market

[LEARN MORE >](#)

### ADVERTISEMENT

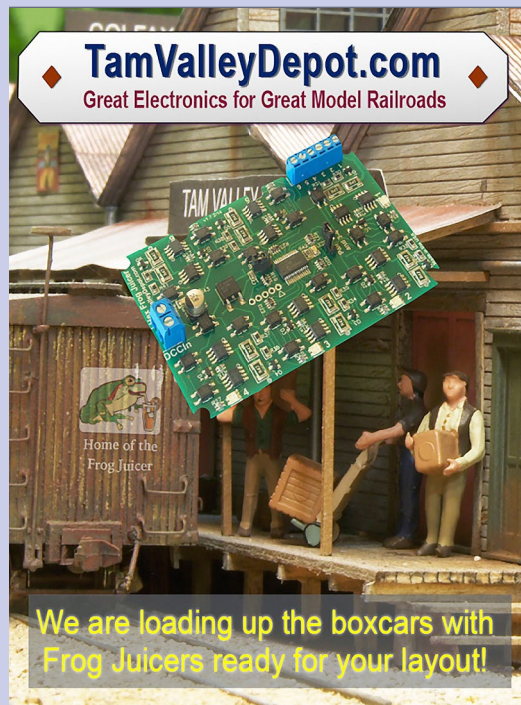

**TamValleyDepot.com**  
Great Electronics for Great Model Railroads

TAM VALLEY DEPOT

Home of the Frog Juicer

We are loading up the boxcars with Frog Juicers ready for your layout!

# Great control in a tiny package



**Original  
Touch Toggles**

- Touch Toggle™ plug in controls
- Bright clear indication
- Easy setup
- Flexible system

Stall Motors, Twin-coils,  
Power, and Servos

Now for Tam Valley Depot  
and MRservo too!

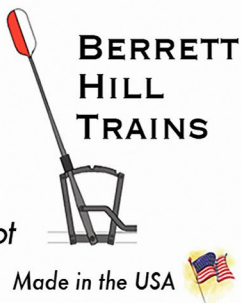

What will they think of next?

[www.berrethillshop.com](http://www.berrethillshop.com)

Make LocoNet wiring extremely simple!

**ACCU-LITES, inc**

Your DCC Center!

Dealer Inquiries Accepted



**PM42**  
breakout board

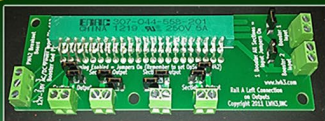

**BDL168**  
Multi-zone  
breakout board

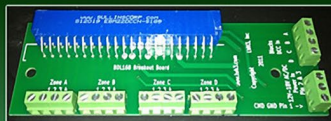

**SE8C**  
breakout board

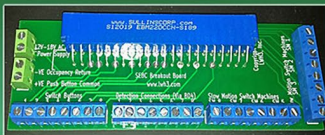

**BDL168**  
Single-zone  
breakout board

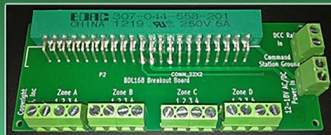

Now Offering SNAPS! in packs of 6 or 12 pieces! [CLICK TO LEARN MORE ...](#)



.....

## MR. DCC'S WORKSHOP

### KEEPING YOUR WIRE NEAT ...

It is great to have a choice of wires when you are installing decoders. Different sizes and colors make safe and professional-looking installations easier.

I buy larger gauge wires by the spool, but a spool of 30 AWG is a lot of wire. So I buy the 10- or 20-foot packages. They give me lots of wire for many installations and reduce the amount of space needed to store wire. But I've had a dickens of a time keeping them neat. Then I hit on an idea.



I wrap the wire around my hand and tuck the resulting hank into a piece of shrink tubing. I find that the 3/8 inch diameter gives a nice fit. I keep them in a storage tray and have all the colors together when I need them. ■



[Click here for reader comments](#)

**15**  
YEARS  
ANNIVERSARY 2016

Litchfield

STATION

[www.LitchfieldStation.com](http://www.LitchfieldStation.com)

623-298-7355

Everything Digital  
Command Control  
Command Systems  
Decoders,  
Layouts,  
Command Systems  
Accessories  
& More!

Making  
DCC FUN  
for 15 Years!

# ZEPHYR xtra™

\$255 MSRP



All-In-One Throttle / Command Station /  
Booster to run your layout!

# Super EMPIRE BUILDER xtra™

\$355 MSRP



Super Empire Builder Xtra has everything you  
need to get started in Advanced Digitrax  
Command Control.





Complete Train Control

# Digitrax Starter Sets for great operation!

View more at: [www.digitrax.com](http://www.digitrax.com)

*Super* **Chief xtra**™

**\$455 MSRP**



**Maximum capacity, maximum features.  
Take it to the Max with Super Chief Xtra!**



# Get Better Sound from your Locomotives

Can't get a good sound from your sound decoder?  
Give our speakers a test drive with your ears.



**RAILMASTER HOBBIES**  
**9812 BELMONT**  
**BELFLOWER, CA 90706**

Bass Reflex  
Speakers



High Bass  
Speakers



When it comes to speakers we have high quality speakers to fit many different applications.

We are also a full line hobby shop. Need anything? We are an authorized dealer for Soundtraxx, Digitrax, Athearn, Walthers and many others. We provide quality speakers for your DCC sound systems and quality service.

**Click here for  
the answer ...**

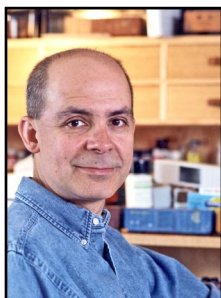

# GETTING REAL

column

MIKE ROSE  
.....



[Click here for  
reader comments](#)

## REMODELING THE LAYOUT, NEXT CHAPTER: PART 2 | FOCUSING ON TOWANDA CREEK, WITH A LITTLE TUNKHANNOCK THROWN IN

### LAST MONTH I STARTED THE PROCESS

of remodeling the Towanda/Tunkhannock area on my layout. In part 1, I completely revised the track arrangement here and built a new drop-down bridge to cross the aisle. Here, in part 2, I focus on the bridge and scenery at Towanda Creek.

**When talking to hobby  
vendors, please remember  
to mention MRH.**

▶ MODELING REAL RAILROADS AND WHAT THEY DO

## GETTING REAL | 2



62. I wanted this bridge to capture the feel of the prototype through girder bridge. To have the girders high enough to look “right” to me, I decided to thin the subroadbed under the girders. I made saw cuts with a Japanese dovetail saw, and then chiseled out the area in between.



63. Removing the subroadbed material made a big difference in terms of where the top of the girder sits in relation to the track.



64. The red Sharpie lines represent the approximate locations for the bridge abutments.





65. Russ Green of New England Brownstone custom-cast the abutments for this bridge. However, after I'd given him all the specs, I visited the prototype and decided that I'd like to replicate the double-track bridge that had been turned into a single track aspect, as it was very cool! Fortunately Russ always gives me more than enough material to work with and I decided to expand the abutments. The markings here indicate the material to be removed. Note the "x" on top of the inner triangles, and the vertical lines.

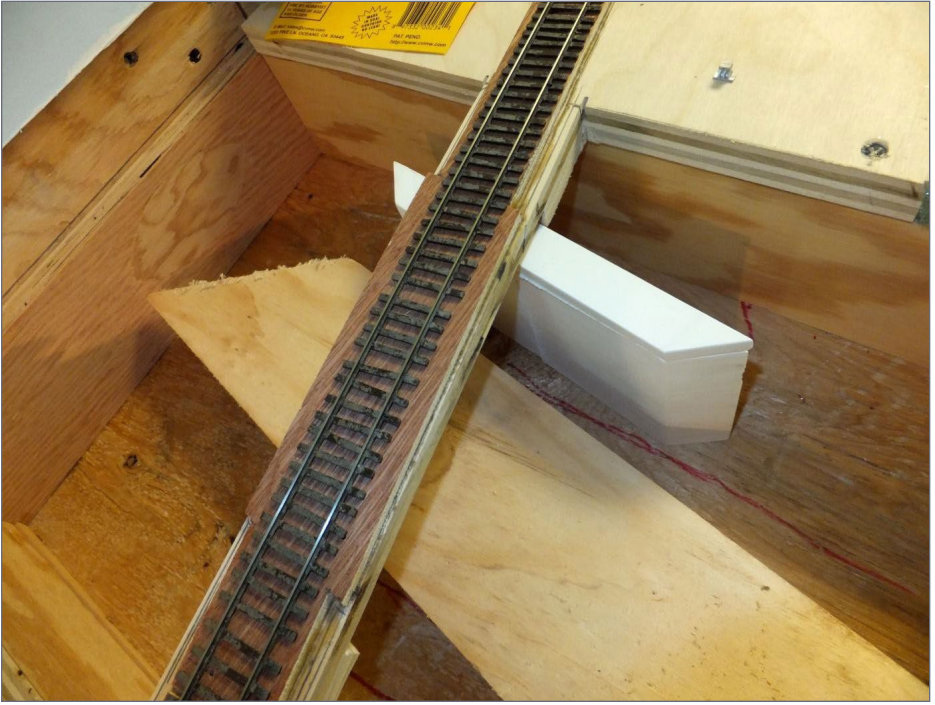

66. The abutments and the bridge needed to be skewed, so there was a lot of experimenting to get the look I was after. The 2x4 below the bridge is there to indicate the approximate water level.



[Click here for reader comments](#)



67. The design begins to take shape. Here I'm planning the wing walls and how they relate to the benchwork gap where everything will be installed.



[Click here for reader comments](#)



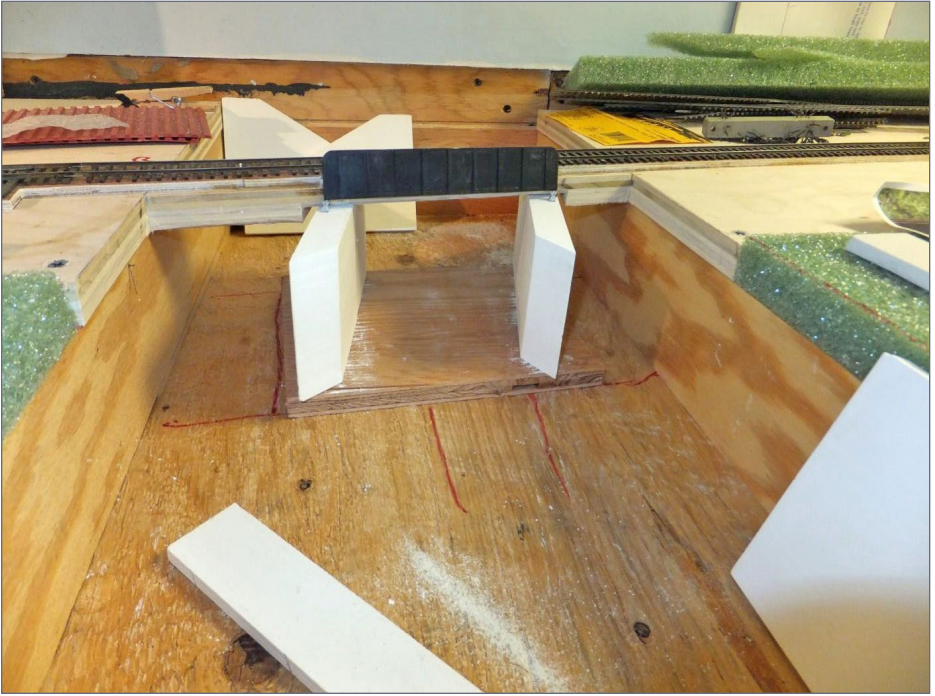

68. The first thing I needed to nail down was the correct abutment height. I set this by lining up the girder with the trimmed subroadbed bottom, adding bridge shoes, and shimming the abutments up to the bottom of the shoes. Fortunately a piece of 3/8-inch plywood was just right.



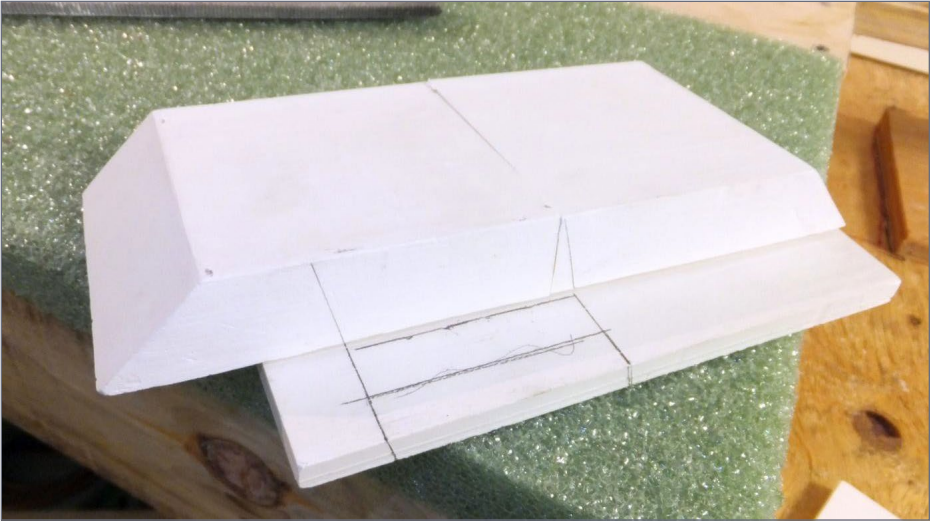

69. The two abutments have had their triangles cut off and are glued together with yellow carpenters glue. Cutting thick plaster can be a messy prospect and difficult to get right, with a lot of filing and file cleaning. One train night my friend Dave muttered “Why don’t you just use the band saw?” I immediately recognized the genius of that. Working carefully and cutting gingerly at first, I soon realized that the band saw was the ideal tool for this. I trimmed both abutments in something like two minutes flat with minimal mess and a near-perfect cut! The areas marked are removed so the abutment retaining wall can be cut to fit around the subroadbed. The abutment is upside-down in this view.



70. A lead weight holds the cut “retaining” portion of the abutment in place while it’s being glued to the abutment. This retaining portion holds back the land and ballast above the abutment height and is at the same level as the bridge shoes and the girder up to ballast level.



**DID YOU  
KNOW MRH  
SUBSCRIBERS GET  
FREE BONUSES?**

**CLICK TO SUBSCRIBE NOW - IT'S FREE!**

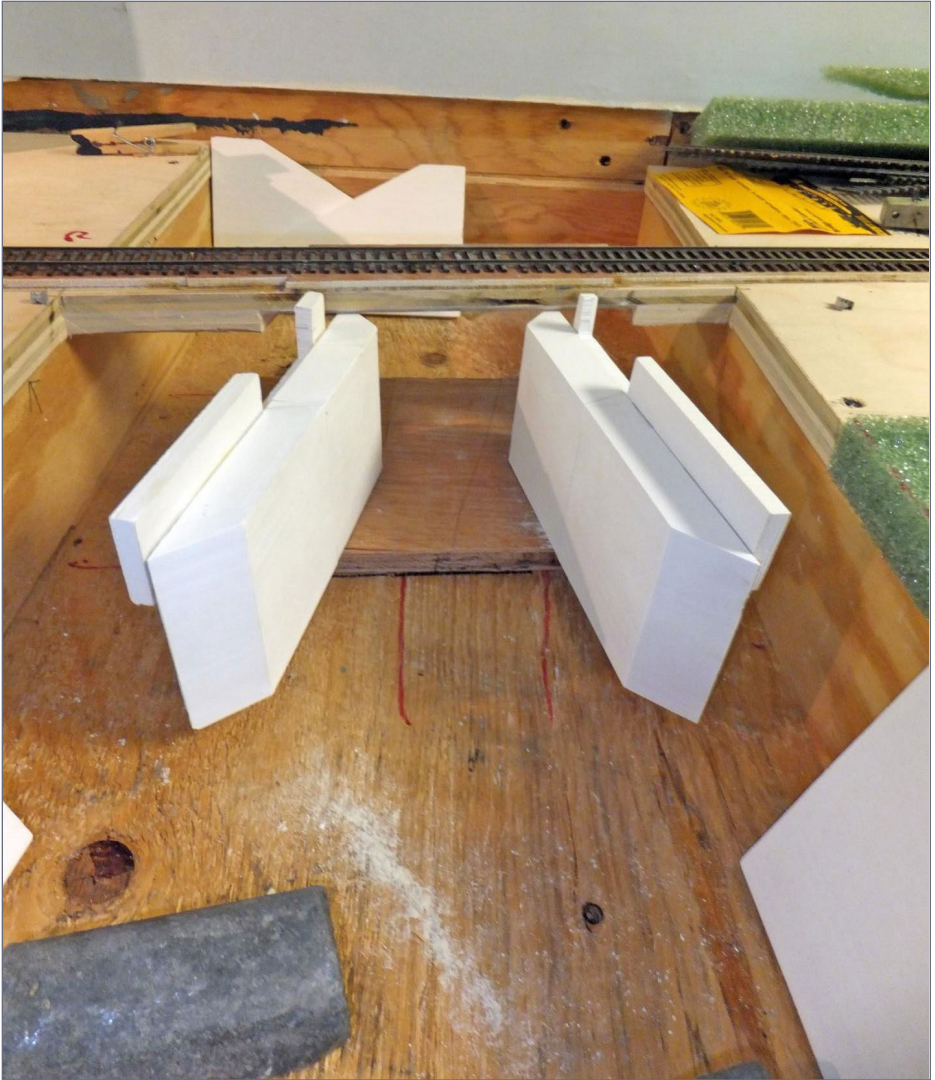

71. Both abutments have their trimmed retaining portions cut out and glued in place. I was wise not to attach the plywood shim piece to the bottom of the box – it needed to be removed, the abutments slid in and tilted up into place, and the shim carefully slid under them. It was a tricky procedure requiring lots of little adjustments.

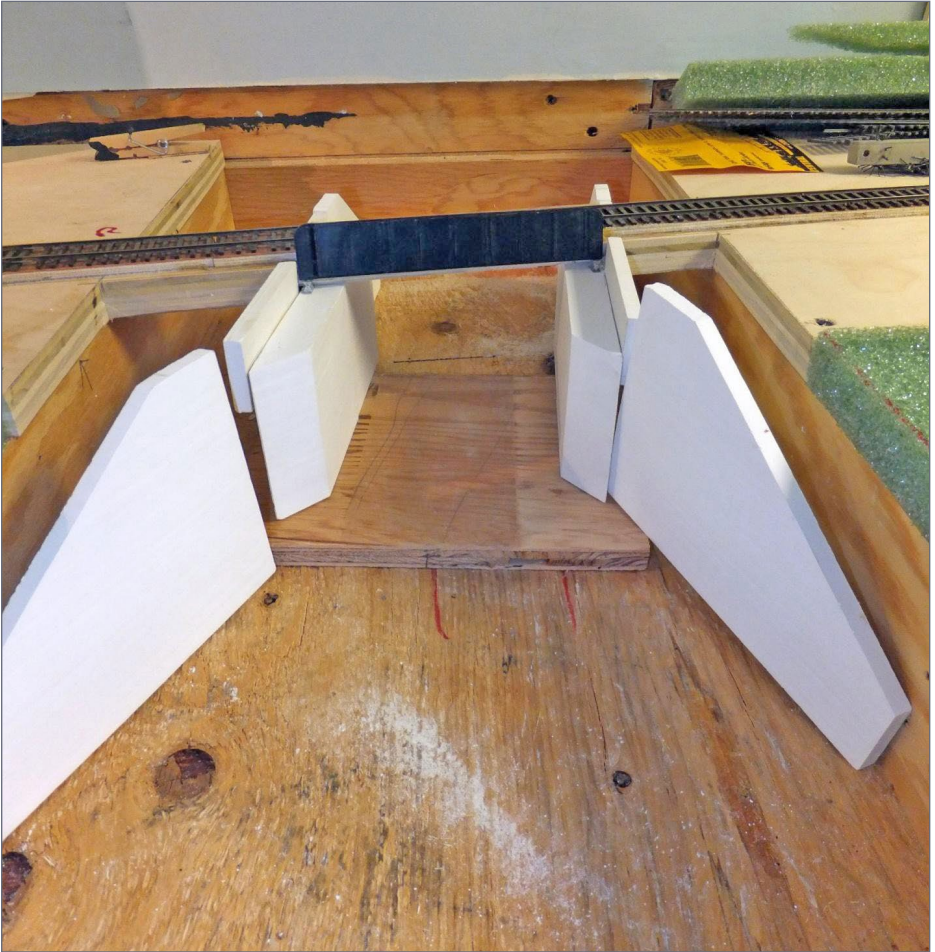

72. With the abutments in position, it was time to determine the nature of the wing walls and their positions.



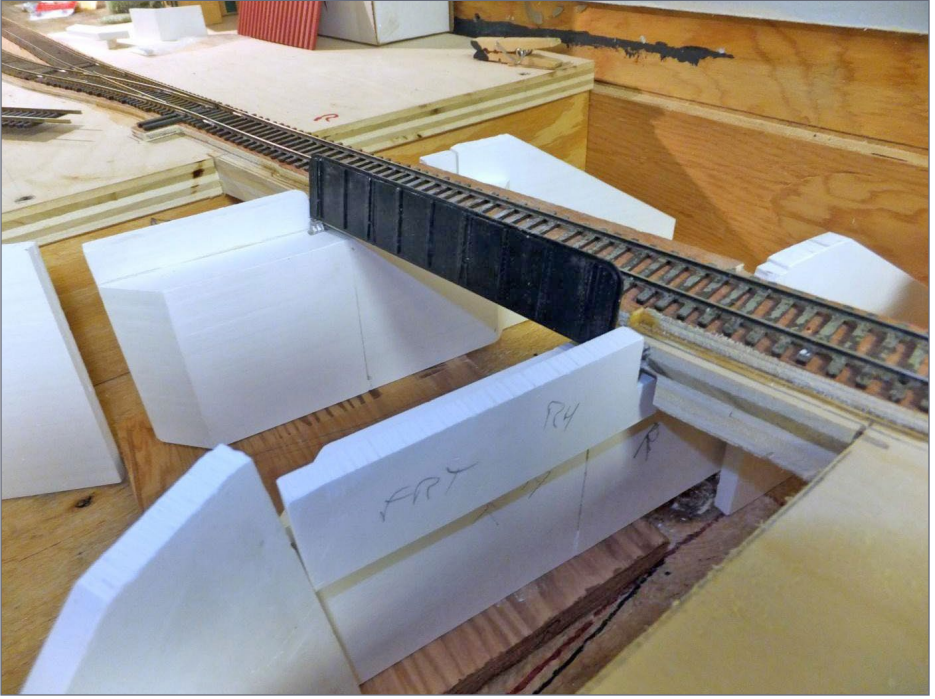

73. Looking at the abutment from the rear shows how its retaining portion fits around the subroadbed on either side of the bridge.



[Click here for reader comments](#)



74. To get the feel of what I was doing, I needed to build the abandoned second bridge span, which went together easily. The Central Valley kits are a breeze to assemble with a good bonder such as Pro Weld, and lend themselves to kitbashing. I shortened the girder quite a bit to fit this purpose.



75. This upper view shows how the abandoned bridge's inner girder is also part of the in-use bridge.



[Click here for  
reader comments](#)





76. I painted the entire portion of sub-roadbed under and around the bridge with a brush and Floquil Engine Black. In relation to the weathered ties and girders, the sub-roadbed will simply look like shadow. Having the dummy open bridge in front also helps to disguise the fact that there is no empty space between the ties of the track in back.

# Tell your friends about MRH!

**We depend on word-of-mouth to grow  
... if you don't share us, we don't grow**





77. With the abutments and wing walls in place, the shape of the waterway is beginning to become obvious.

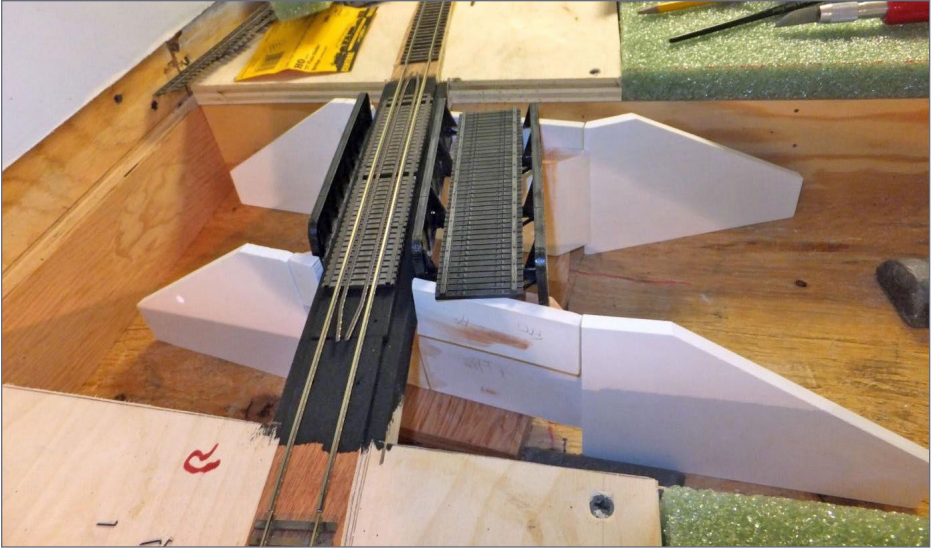

78. A piece of Walther's code 83 bridge track replaces the temporary flex track originally laid over the bridge. You can see how the "black black" of the sub-roadbed simply appears to be empty space.

**When talking to hobby vendors, please remember to mention MRH.**



79. With the stream bed properly defined, it is now possible to cut the front layout joist and to fill in the embankments with foam.





80. A new piece of plywood is installed to the proper height and will form the stream bed base. I don't like to use foam under Enviro-Tex as I've heard it can out-gas and cause bubbles. True or not, why take the chance?



[Click here for  
reader comments](#)





81. This view confirms my feeling for the proper height between the bottom of the girders and the eventual top of the water. A layer of Sculptamold plus the water thickness will go on top of this plywood. Having too much space under a through girder bridge is generally considered a no-no, although in my modeling area they allow plenty of room for spring flooding!



[Click here for reader comments](#)



82. The area is shaping up now with most of the foam in place on both sides of the stream bed.

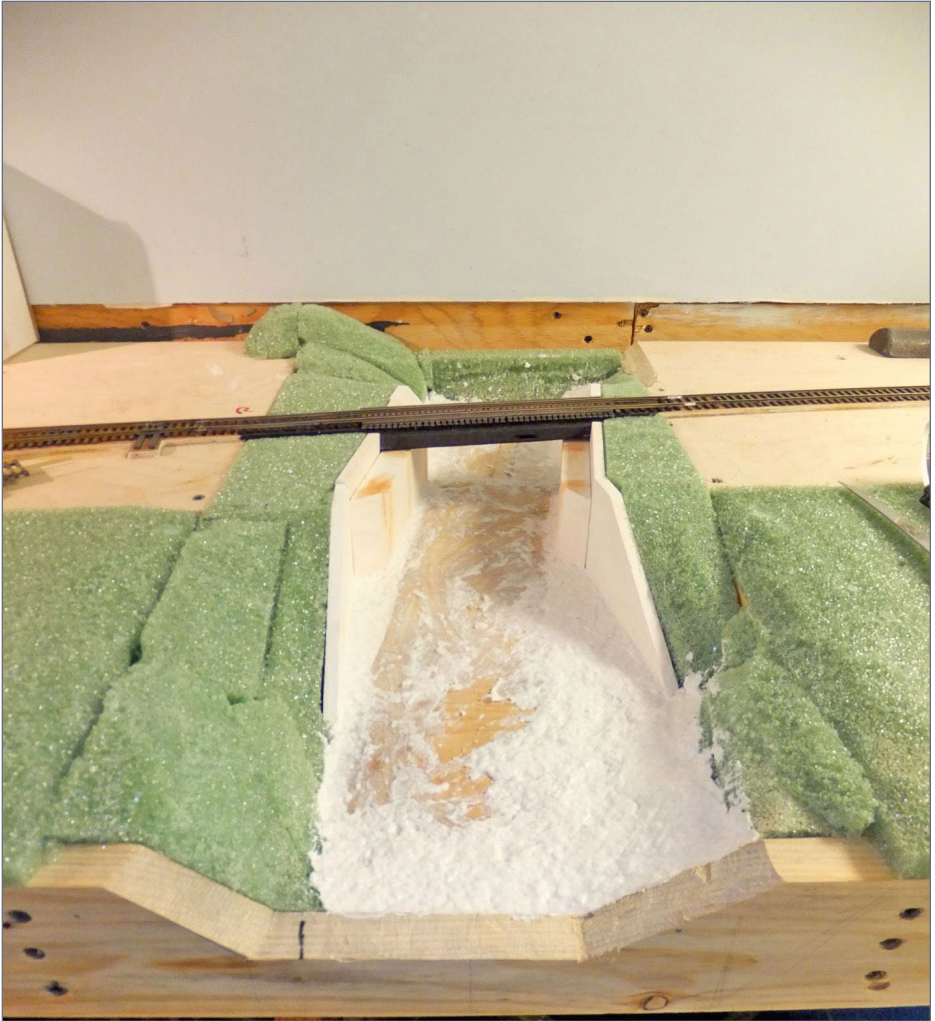

83. I filled in the remaining area with regular Sculptamold. It took so long to dry in the summer months that it actually grew colored mold, despite my basement central air conditioning and dehumidifier! A few sprays of Lysol took care of that.





# FAST TRACKS

## YOUR VERY OWN TRACK FACTORY

Make the most of your modeling experience.

Build perfect trackwork easily and inexpensively when YOU want it!



Check out our extensive (and growing!) online video library to learn how easy it is to hand lay your own trackwork with Fast Tracks tools and supplies.

*Play Video* 



shop online 24/7

1-888-252-3895

[handlaidtrack.com](http://handlaidtrack.com)

[service@fast-tracks.net](mailto:service@fast-tracks.net)







84. (Left) While the stream bed Sculptamold set up and I had my foam tools out, I decided to tackle the transition hillside in Tunkhannock that would disguise the existing viaduct from that side and form a nice base for trees. I use a Sharpie on a compass to scribe the line of the retaining wall onto the foam so I can cut it to a good fit. For those unfamiliar with this traditional woodworking technique, the sharp point of the compass is gently dragged against the retaining wall and the marker transfers this shape to the foam.

85. (Above) The bottom and second layer of foam are in place temporarily. I wanted to get used to this for a while before gluing it down in case I wanted to make any changes. I've already decided to move the whole thing to the right by at least an inch and a half to make room for a needed road in Tunkhannock.





86. From the Towanda side you can see foam visible under the bridge girders, once painted black, will just look like a void. With plenty of trees to block out Tunkhannock to the rear, the desired scene separation will be achieved.



[Click here for  
reader comments](#)



87. Adding the fascia really helps to neaten things up and provide more of a sense of how the finished scene will look. Sharp eyes will see the blue masking tape on the metal support leg and the Well-X-Trol, as I'm getting ready to paint the fascia.



88. The painted fascia totally changes the look of this construction zone and gives it a nice sense of inevitability! Black curtains will hang below once scenery is largely complete to block out the distractions below the layout.





ADVERTISEMENT

**Click Here**

**FIFER HOBBY SUPPLY LLC**

**Your Local N Scale  
Online Hobby Shop**

**575-523-9743  
fiferhobby.com**



89. (Left) This view from Tunkhannock shows how the fully-treed foam hillside will almost completely eliminate the view of Towanda. All you'll see is a distant treed mountain.

90. (Above) This overall view of most of Tunkhannock, Tunkhannock Creek, and Ransom (in the distance) shows just how long this overall scene is. The creek and surrounding trees and shrubs are a natural break between the two towns. The track arrangement is a condensed version of what the prototype did when it changed from double track to single track with sidings and how, if the sidings in both towns were continued and joined, they'd go right over the abandoned bridge span. That abandoned span on the prototype is protected with fences, signs and ballast piles. I'm really looking forward to doing that here!



91. The first siding in Tuckhannock (with the single boxcar on it) will be going to a decrepit wooden loading dock. MOW equipment and occasional team track freight were often spotted here. To the right, with the two grain hoppers, is the Agway spur. The two middle tracks above that are Tuckhannock Yard, which is mainly used as a team track where businesses formerly served on the abandoned Montrose Branch now receive their carload freight. The main and passing siding (where the boxcar cut is spotted) are next, and to the rear is the siding for Hall & Golden Feeds, yet another mill to be built. The scene will round out with a very cool brick freight house that still stands, and a coal and fuel oil dealer in the far corner that was served by rail but not in my era. Most of this was wiped out by the Route 6 bypass during the very late '80s or early '90s, but it will live on in my basement. I plan to spend many happy hours this winter creating this interesting town.

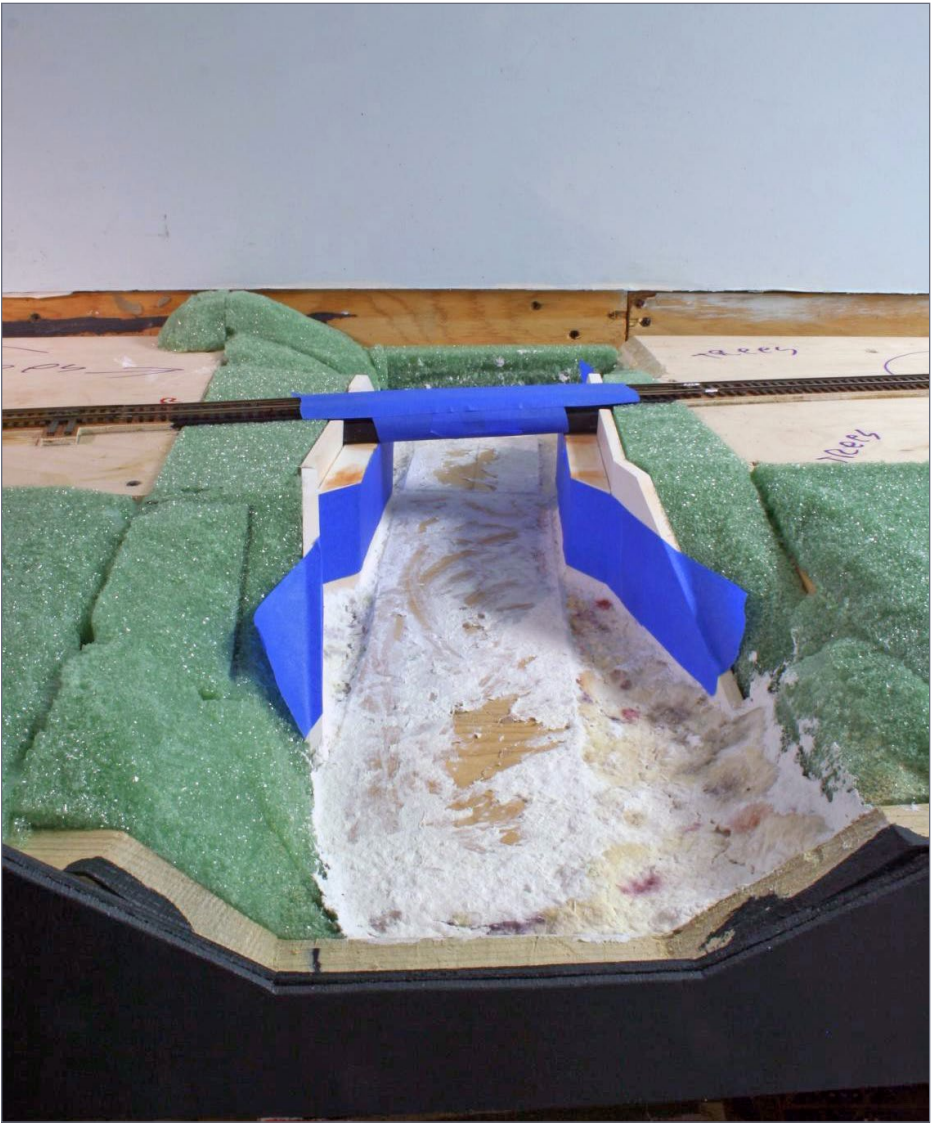

92. Now that the base Sculptamold is finally dry (you can see the dead mold spots to the right!), it's time to put the scenic layer in place. I do this with paint-colored Sculptamold. The blue painters tape is in place to keep the painted Sculptamold from staining the abutments and retaining walls.



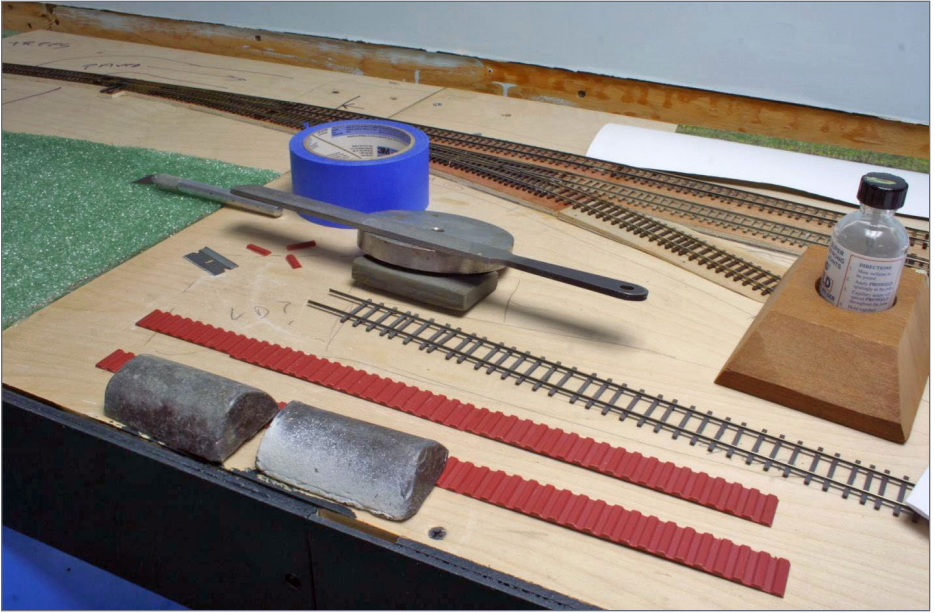

93. The prototype protected the base of the abutments with metal retaining walls. I'm not sure exactly when it was done, but it is cool enough that I decided to model it. I cut some Heljan steel siding material to the desired height on a Micro Mark table saw, and then joined them end-to-end with Pro Weld.

**Want to help  
keep MRH free?  
Then click on  
Ads!**



94. I learned the hard way, a long time ago, that it's a very good idea to wear disposable gloves when working with paint-mixed Sculptamold! Fortunately the gloves come in Conrail blue. A spoon is an ideal tool to persuade it into place and work out the general contour. Once the Sculptamold has set up just a bit, I press the retaining wall material into place and add more Sculptamold to fill between it and the abutments.

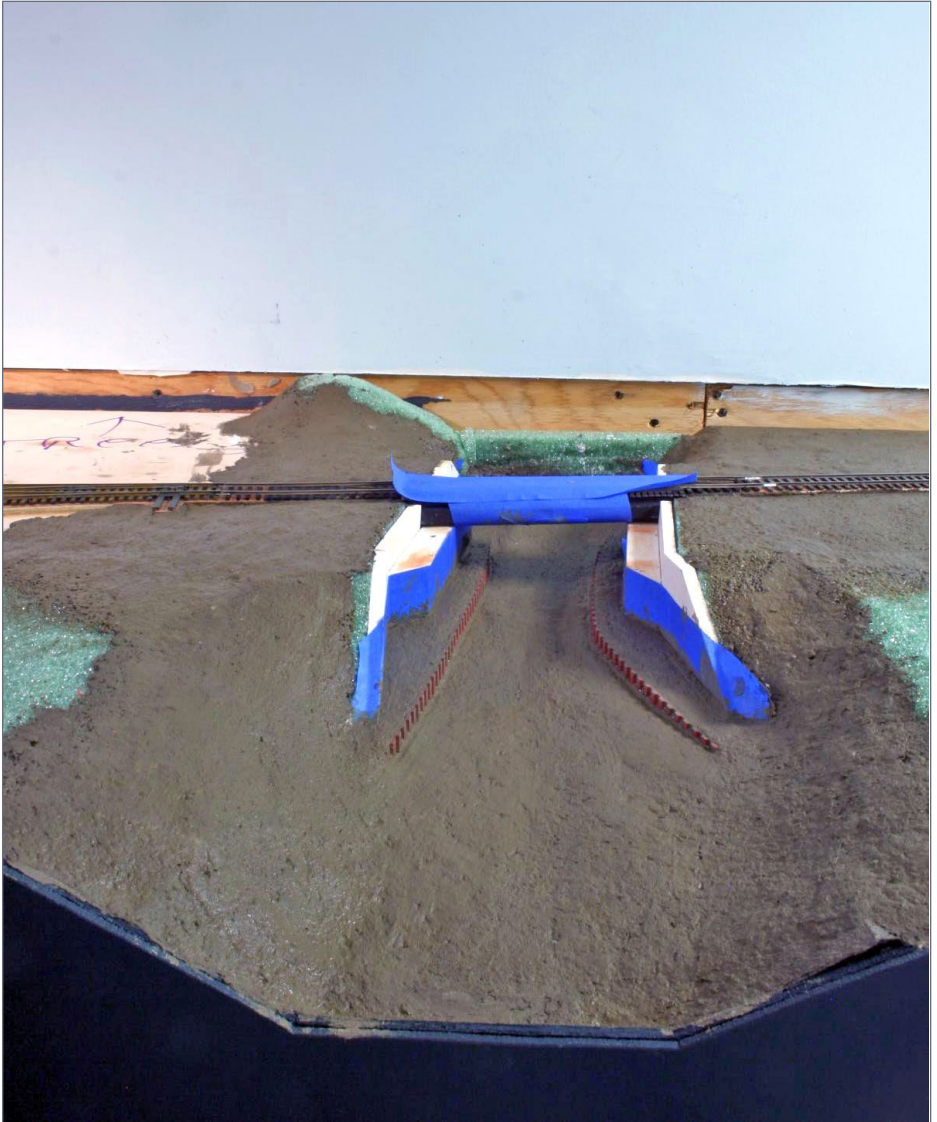

95. The second piece of retaining wall has been inserted but not backfilled, and the right-hand one is finished. The overall scene has its Sculptamold base fully installed. Using blue painter's tape to mask the bridge sub-roadbed saves having to touch up the black.



# ALLAGASH 2016 Calendar



Wallpaper  
photo downloads  
included!

Made especially for model railroaders by MRH

Mike Confalone's Allagash

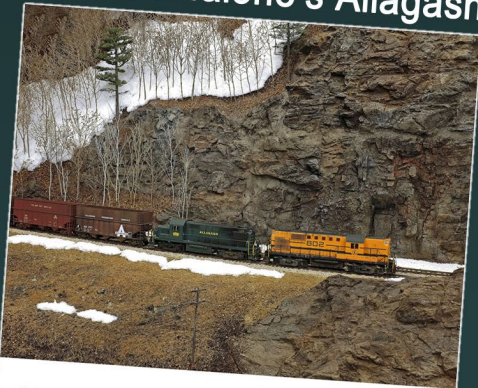

Major model RR  
event dates  
included!

Wall calendars:  
Open to 11" x 17"

2016 JUNE

Sunday	Monday	Tuesday	Wednesday	Thursday	Friday	Saturday
	1 <small>Mem. Day</small>	2	3	4	5	6
7	8	9	10	11	12	13
14	15	16	17	18	19	20
21	22	23	24	25	26	27
28	29	30	1	2	3	4

One half of Mike Confalone's "fleet" of two Alco RS1s teams up with an Allagash RS12 on an empty round-the-train run on the grade at White Mountain. The train is about to enter a deep rock cut as it struggles toward the summit in March 1994.

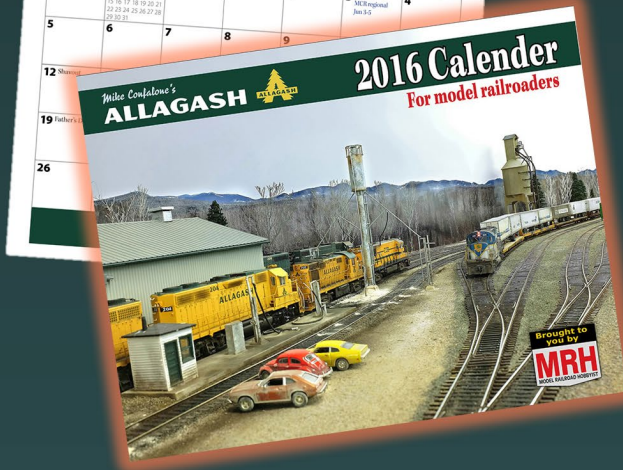

~~\$18.88~~

\$16.99  
+ S&H

GET YOUR CALENDAR TODAY >>

[store.mrhmag.com](http://store.mrhmag.com)

• INDEX

• TABLE OF CONTENTS



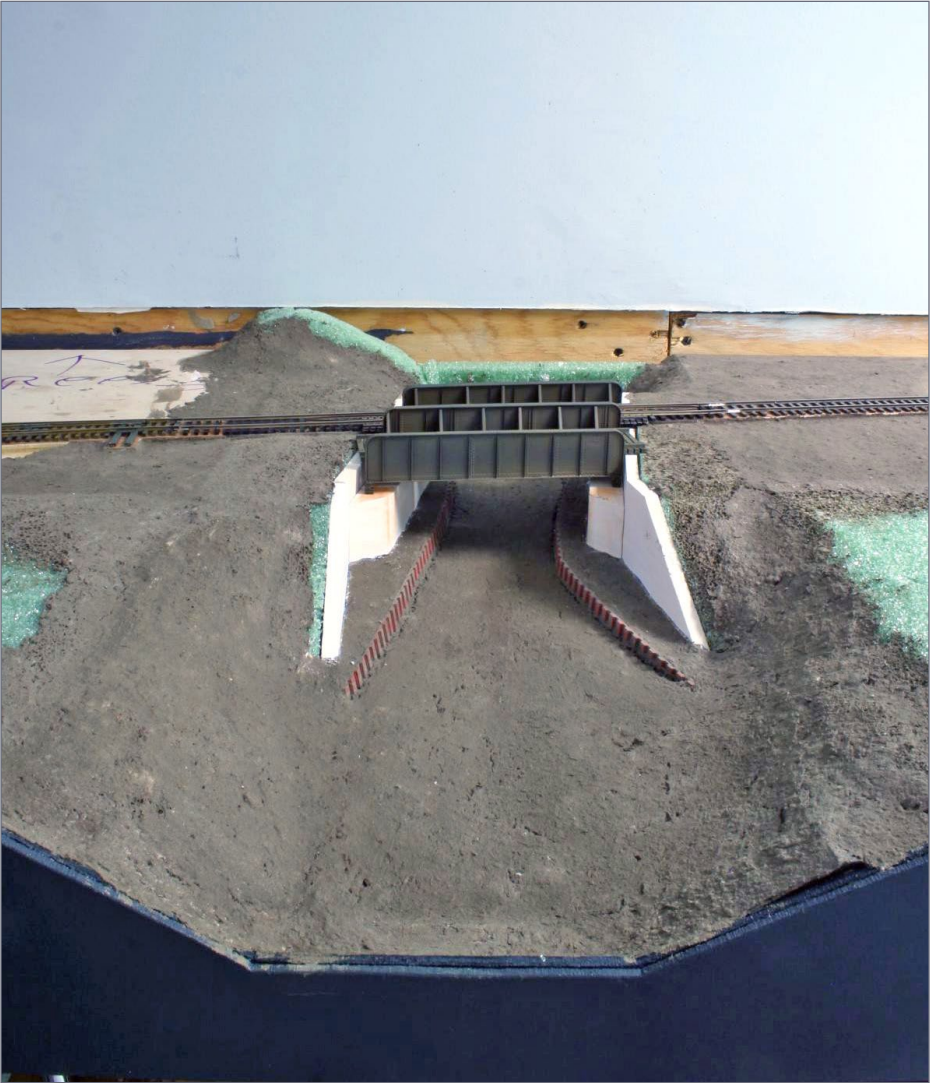

96. The Sculptamold dries to a less intense color that will serve as a nice base for the ground cover and the stream itself. Inner reinforcing members are added to the bridge before it is painted and weathered. I added some rust effects on the abutments. This scene will not take long to finish when the time is right.

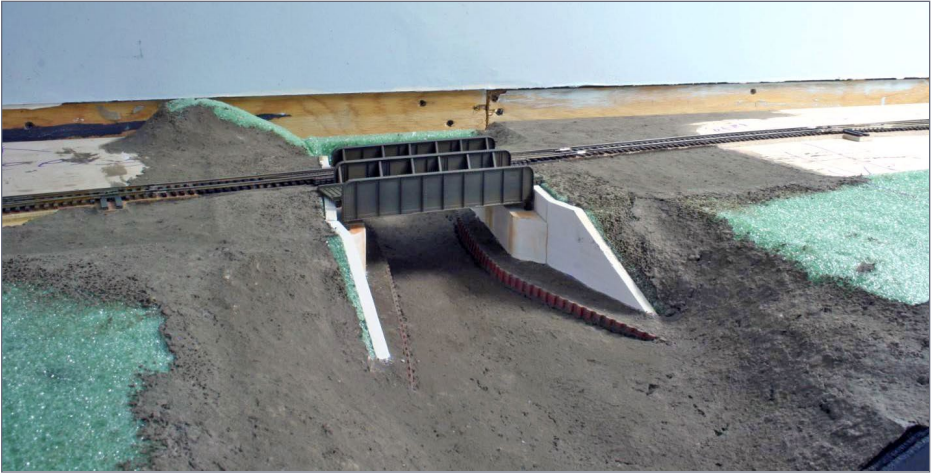

97. An alternate view assures me that the area is finally Getting Real! My next column, in a few months, will almost certainly feature the construction of the paper mill at Ransom, plus scenery for that area and this area as well. Stay tuned.



[Click here for reader comments](#)

## Take the MRH 2016 Reader Survey ...



... and get a chance  
to win a 10" Kindle  
Fire tablet!



fire HD10  
OUR LARGEST  
DISPLAY  
— ON OUR —  
THINNEST TABLET

amazon

[TAKE THE SURVEY >>](#)

# VICTOR ROSEMAN 2016 Calendar

Brought  
you by  
**MRH**  
MODEL RAILROAD HOBBYIST

Wallpaper  
photo downloads  
included!

Made especially for model railroaders by MRH

Vintage SP passenger trains



Major model RR  
event dates  
included!

Wall calendars:  
Open to 11" x 17"

2016

AUGUST

San Joaquin Daylight behind three F7 units, arriving in Fresno en route to Los Angeles, 1955

Sunday	Monday	Tuesday	Wednesday	Thursday	Friday	Saturday
1 July	2 One Day (Canada)	3	4	5	6	
7	8	9	10	11	12	13

14

21

28



~~\$18.88~~

\$16.99  
+ S&H

GET YOUR CALENDAR TODAY >>

[store.mrhmag.com](http://store.mrhmag.com)

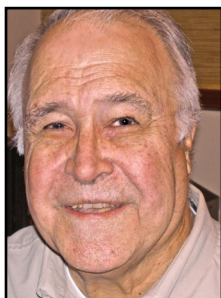

# LITE AND NARROW

column

LARRY SMITH  
.....



[Click here for  
reader comments](#)

**THE WOODWARD IRON RAILROAD | IT'S  
NOT LITE OR NARROW BUT VERY SHORT. A  
SPECIALIZED RAILROAD YOU CAN MODEL ...**

**NOT MANY REALIZE THE BIRMINGHAM,**  
Alabama area was, and still is, a major railroad city. Seven major carriers and a multitude of shortlines served it: Woodward, TCI, Birmingham Southern and others, at one time or another.

Today, it is still served by three of the big four, along with the KCS and CN. There are still some shortlines left, but they are falling under the mega shortline owners, same paint scheme, just different names. There are three major rail yards, east (Norris Yard, NS), north (Boyles, CSX), and west (East Thomas, BNSF) all of which are operated by the Birmingham Terminal Railroad, formally the Birmingham Southern. This makes for interesting railfanning in the area.

▶ **RAMBLINGS ON THE NARROW GAUGE**



Backdating into the steam era when there were numerous blast furnaces and open hearths operating, you can quickly see how Birmingham received the nickname of “the smoky city.” The competitive nature of the various iron and steel companies to acquire the mineral resources of the area and to control the supply to their plants with their own railroads probably makes this the most interesting era to model a Birmingham area railroad.

### Required elements

To effectively model Woodward Iron or any other industrial-based railroad, you have to identify key structures. In Woodward’s case, these are blast furnaces, coke ovens, and by-products plants. If you are modeling in N or HO, you are in luck,

as Walthers has produced models for two, with the third made from another kit.

### Blast furnace

The Walthers’ blast furnace kit



1. Walthers blast furnace retrofitted with new top works to backdate to the era John is modeling. *John Glaab photo*

## LITE AND NARROW | 3

was introduced in 1996, making it much easier for those who model the iron and steel industry. It was re-released in 2009 with some upgrades from the previous kit. Although massive when built, Walthers compressed the HO blast furnace to 77' tall, making it 25% undersize for a 1910-built furnace, and 35% for a 1940s built furnace.

To model an older furnace of comparable size, the Walthers kit needs to be modified. John Glaab, Peach Creek Shops, makes a backdating kit for the furnace which is mainly in the headworks.

There is a complete article on the website [peachcreekshops.com/steelarticles.php](http://peachcreekshops.com/steelarticles.php). With an iron furnace, you also need to change the pouring floor – the section next to the furnace with the troughs, so that it slants to the ground, as the real iron furnaces did. This is so the molten iron can run into the sand molds, forming pigs.

2. Closeup of new top works retrofitted to the Walthers blast furnace. *John Glaab photo*

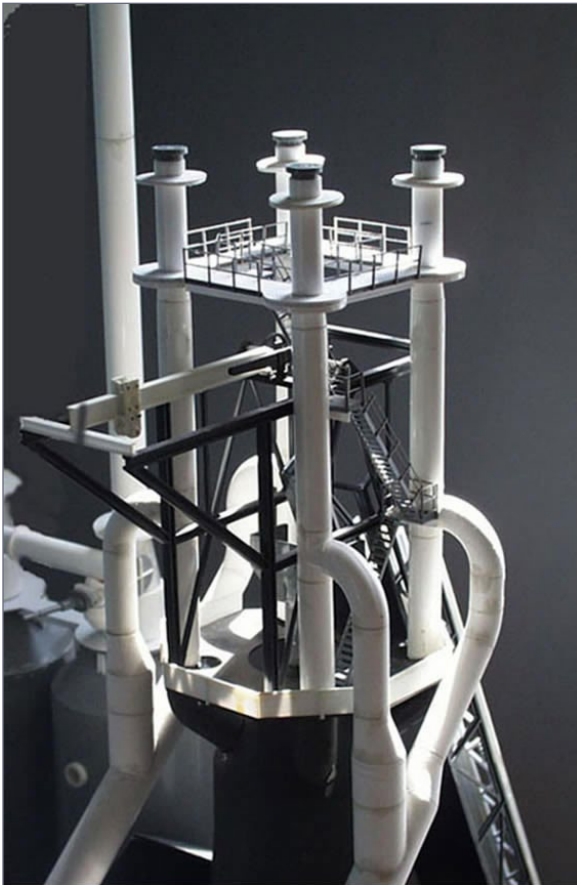

## LITE AND NARROW | 4

For the adventurous individual who desires a more accurate model of the furnaces and support structures, I suggest looking at the plans drawn by Michael Rabbitt. Listings of his plans are on the Peach Creek Shops website. Plans for the Cranberry Furnace were published in *The Blueridge Stemwinder*, Volume 14, Number 2, Fall-Winter 2003 (out of print).

### Coke ovens

These can be either the modern coke battery, (Walthers, 933-2972, Coke Oven & Quench Tower) or beehive ovens, (Scale Model Masterpieces, SMM3115). Both can be in operation on the layout



3. Cranberry Furnace represents an early blast furnace and supporting structures. The model is S scale and built from Michael Rabbitt plans, and is on John Waite's layout. John Waite photograph. *Chris Ford collection*

by modeling a period when the beehives were being phased out and the modern ovens were being phased in. The coke ovens do not have to be next to the blast furnace operation. There are two existing coke operations in the Birmingham area, and they are nowhere near any steel operations.

### By-products plant

Woodward and most coke operations had a by-products plant close to the coke operations. By-products are gasses and tar that are released by the coal as it is cooked at high temperatures. These can be refined and distilled into a secondary market



4. Cranberry Furnace end view showing the stock house tracks and boiler house. John Waite photograph. *Chris Ford collection*



product. This operation can be modeled using Walthers 933-3705, United Petroleum Refining and 933-2907, gas storage tank. Michael Rabbitt has plans for a full by-products plant from Thomas, if you are so inclined to build an accurate model.

## REQUIRED ELEMENTS SPECIFIC TO THE BIRMINGHAM DISTRICT

### Coal tipple

Located at the tail of the Appalachian Mountains, the Birmingham area was blessed an abundance of coal. *The Directory*

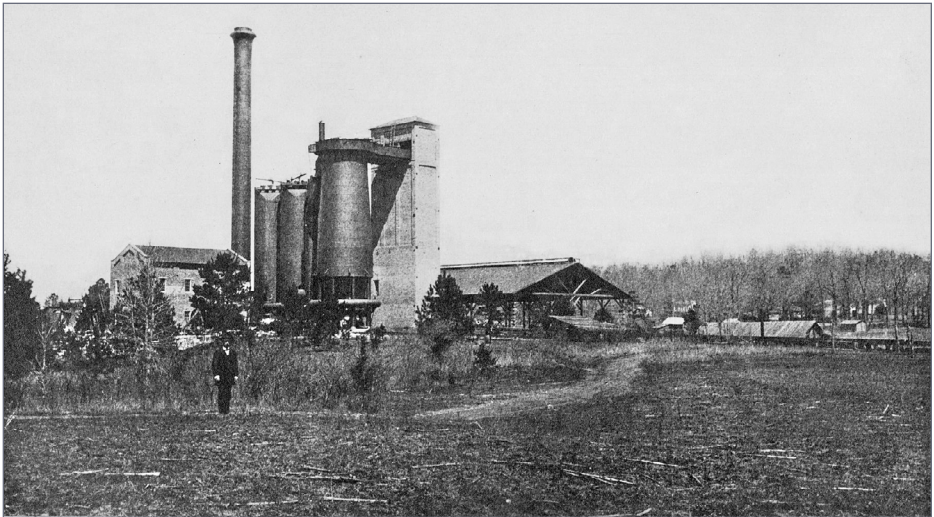

5. Woodward Iron Number 1 Furnace. Notice the resemblance to the Cranberry Furnace. Both furnaces were designed by the same individual in Pittsburgh, PA, as were other furnaces at the time. They were modified only to meet the space requirements of the company they were designed for. Woodward Family papers, University Libraries Division of Special Collections, The University of Alabama. *John Stewart collection.*

*of Mines for the State of Alabama* listed 83 mines for Jefferson County in 1911. Of these mines, 33 of them were drift mines, five shaft, and 45 slope mines. The three Woodward mines, including the soon to-be-acquired Mulga mine, were Dolomite 1 and 2, slope mines and Mulga, a shaft mine.

Neither of these mine types is easy to model. Kibri makes a European-style tower for the shaft mine that also includes the hoist and power house, but it might be easier to fabricate your own using Plastruct or Evergreen structural shapes. If this route is taken, you will need a hoist house, along with other support structures.

### Red iron ore mines

The iron mines for Woodward were unique in design. As previously discussed in part one, they were of two different kinds. Pyne and Redding were both shaft mines, and all of the others were slope mines. Pyne and Redding could be modeled similar to Mulga Mine, and the others can be scratchbuilt following the photographs. You will need a hoist house at all mine sites.

### Modeling the Birmingham district

John Stewart, a local modeler, has amassed a great deal of historical material on the steel and iron operations in the Birmingham area. He has shared many of his photos with me and I have shared them with you in several of the columns. With his love and research of the industry, John has created a model railroad based upon the steel railroad operations, with a good portion of it dedicated to Woodward Iron.

Called the Birmingham District Model Railroad, planning began in 2007, with construction starting in September, 2008.

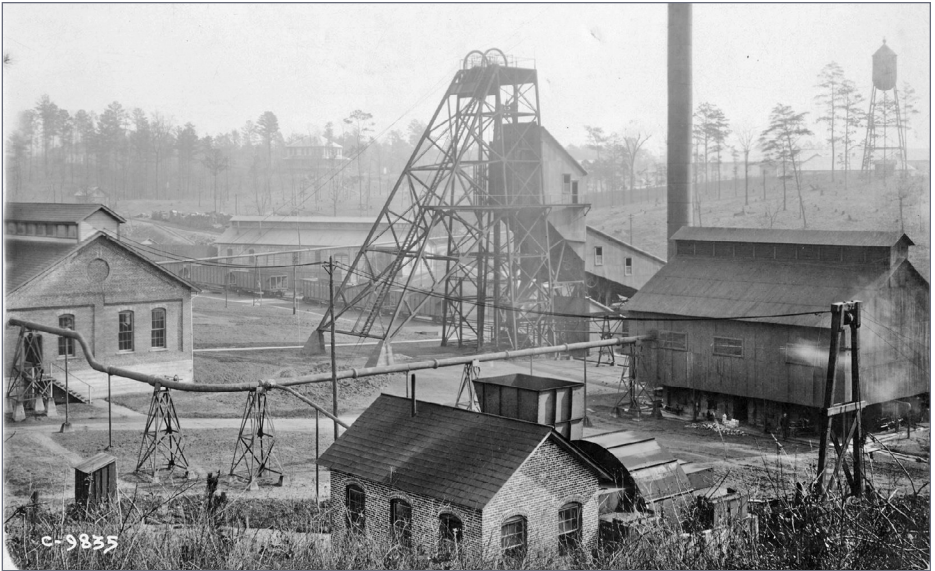

**6. Prototype Mulga Mine.** There is a lot of good modeling information in this photo. Note the blower house in the front of the photo, and the steam pipe running from the boiler house to the hoist house. Woodward Family papers. University Libraries Division of Special Collections, The University of Alabama. *John Stewart collection*

Craig Gardner, an outstanding modeler with an excellent layout based on the Birmingham Southern, assisted John in the construction of his layout.

The railroad is located in two rooms, and features around-the-wall construction with a peninsula representing Red Mountain with the ore mines and TCI sintering plant. Benchwork is L-girder and open grid. It was designed using 3rd PlanIt software from Eldorado Software, [TrackPlanning.com](http://TrackPlanning.com).

The software allows you to start with an empty railroad room and work to a completed three-dimensional layout. The



7. Woodward Iron tipple, either No.1 or No.2. Note the overhead cable sheaves that pulled the cars to the top of the incline for dumping. Photo from *Mine, Mill and Microchip, a chronicle of Alabama enterprise*, Wayne Flynt, Windsor Publications, 1987.

program also allows you to operate the layout three-dimensionally when you are finished with the design, eliminating any possible glitches. Another feature of the program is the ability to create templates for your roadbed and, then transfer them to the plywood or other material used for construction.

By its very name, you can determine what the railroad represents, The Birmingham Industrial District. This was the name given to the overall industrial district of the Birmingham area. The district was discussed in the first article on Woodward Iron and, while compact, still covers several counties in north-central Alabama.





8. Pyne Mine, headframe and bath house with storage facility. HAER, ALA, 37-BES.V, 9A-1 photo. *John Stewart collection*

Using this as the theme for the railroad, key elements representative of the iron and steel industry and the railroad's role in that industry will be featured. This includes a steel mill, coke ovens, iron ore mines on Red Mountain, coal mines, a limestone quarry, and related industries.

The layout also features the downtown grade-separation area that elevated the rail lines of the L&N and AGS to separate rail and street traffic. In the early 1930s a grade-separation project was undertaken through downtown Birmingham. Until this time, there was a four-track mainline for the L&N and AGS at street level. In addition, the L&N maintained its own station, a through train shed, while all other railroads used Terminal Station, located several blocks north and east of downtown.

## LITE AND NARROW | 11

The grade-separation project elevated these tracks along with the platforms of the L&N and building three underpasses and three overpasses in the process. These tracks are still in use today with the north-south CSX lines running parallel to the east-west tracks of the NS. The station platforms serve Amtrak, and at one end is a corn syrup-unloading facility. This grade separation is a feature of John's layout.

CSX and NS still use these tracks today, creating what looks like a four track mainline running through the center of Birmingham, while Amtrak uses the passenger facilities.

The railroad is able to run as a continuous loop, for visitation, but when in operational mode, it is operated in an out-and-back



9. Red Mountain as seen from the TCI sintering plant location. The entire peninsula was covered with cardboard strips and masking tape to develop the landforms. *John Stewart collection*



10. Red Mountain seen from the Woodward mine end of the peninsula. *John Stewart photo*

format. A formal staging yard accesses the mainline, which is a large folded dog-bone configuration. There are four branch lines – Red Mountain, coal district, industrial district, and the steel mill complex.

This type of operation is consistent with the location of the actual Boyles Yard (CSX, L&N) north of Birmingham. Trains working the industrial areas of the city would head south and return north to the yard.

This is the second layout John has constructed, and many of the design flaws that existed on his first layout have been eliminated in this version of the BID. Duck-unders and doorway bridges have been eliminated, as has hidden trackage,



11. Limestone quarry developed using the same methods as those used for the landforms on Red Mountain. *John Stewart photo*

excluding tunnels,. Staging is in the open and easily accessible. The desirable features of the previous layout have been carried over to the new layout; sky backdrops and coved corners using Masonite. Valence lighting was also installed.

Construction of the landforms and scenery base on Red Mountain began by using cardboard strips and hot glue as described in Trainmaster.tv 4.4: *Siskiyou Line – Terrain landforms*. John applied 2” masking tape over the cardboard strips as described in the segment. Earth-colored paint was applied over the surface. John also completed a limestone quarry using the same methods.



# LITE AND NARROW | 14

Most of the railroad action in the downtown area of Birmingham took place south of the grade-separation area. The Atlantic Coast Line's yard and mainline, so to speak, ran

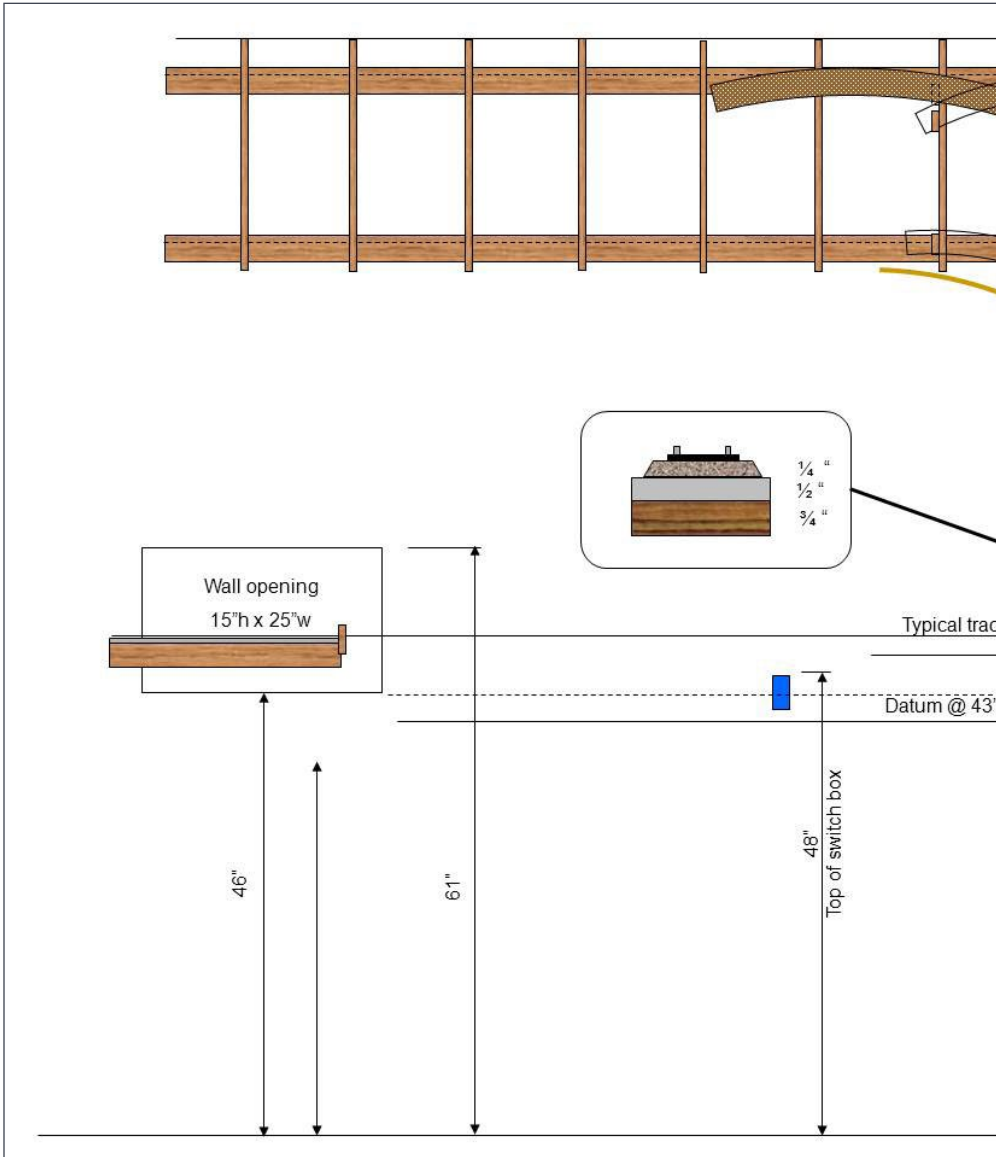

# LITE AND NARROW | 15

very close to grade-separation area and then continued west to Bessemer. This was the old AB&C mentioned in part 1 of the Woodward story.

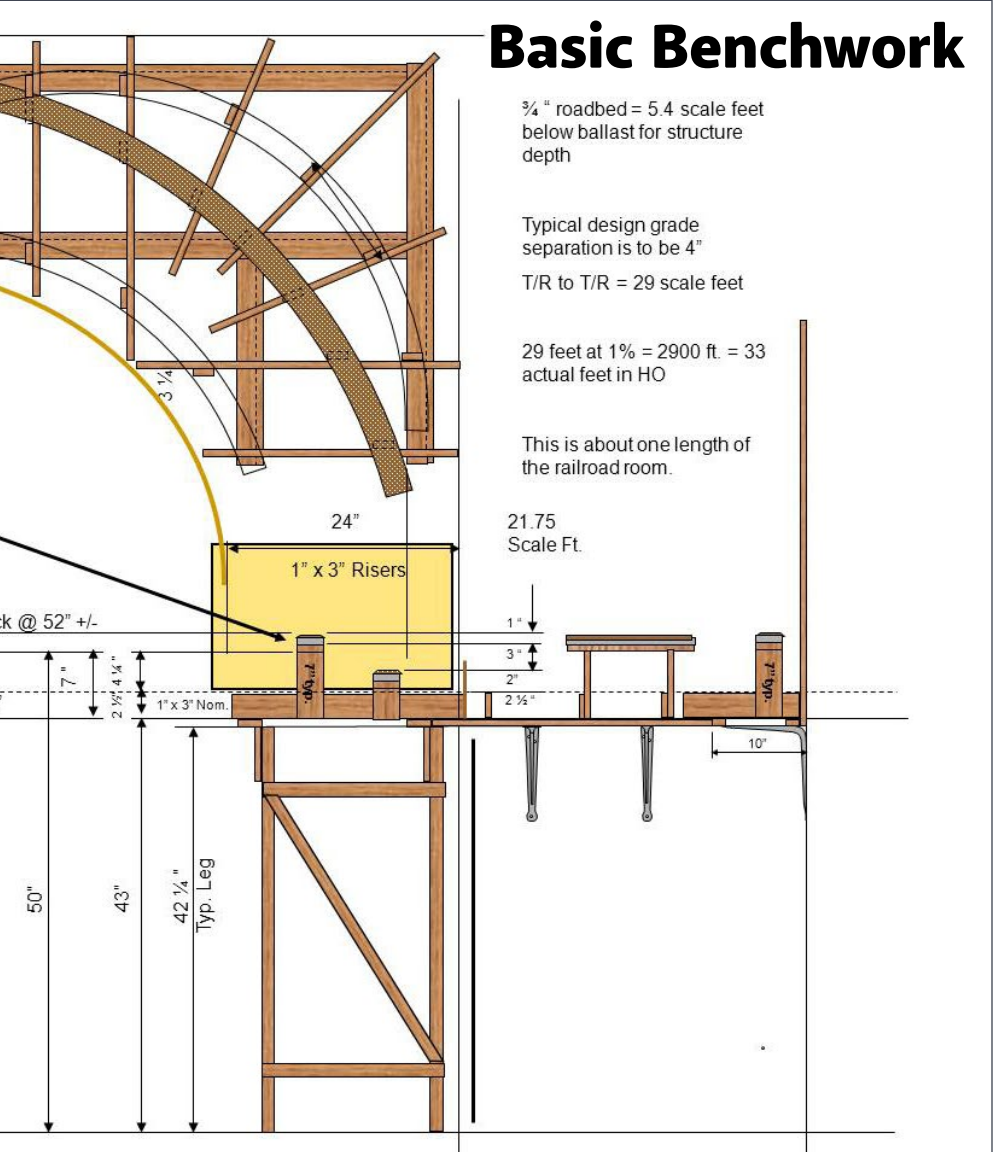

## Basic Benchwork

3/4" roadbed = 5.4 scale feet  
below ballast for structure  
depth

Typical design grade  
separation is to be 4"

T/R to T/R = 29 scale feet

29 feet at 1% = 2900 ft. = 33  
actual feet in HO

This is about one length of  
the railroad room.

21.75  
Scale Ft.

...k @ 52" +/-

7"

2 1/4" x 1/4"

1" x 3" Nom.

1"

3"

2"

2 1/2"

10"

50"

43"

42 1/4"

Typ. Leg

24"

1" x 3" Risers

1"

3"

2"

2 1/2"

10"

21.75

Scale Ft.

50"

43"

42 1/4"

Typ. Leg

24"

1" x 3" Risers

1"

3"

2"

2 1/2"

10"

21.75

Scale Ft.

50"

43"

42 1/4"

Typ. Leg

## LITE AND NARROW | 16

The western end of downtown was switched by the Frisco, and that included a lot of street running. For a very good look at how this was operated, see “Taking it to the Streets,” by G. Warren Reed, October, 1991, *Model Railroader* (out of print). This article describes in detail many of the industries that occupied the area from 1st Avenue, south to 3rd Avenue, south and 12th Street to 16th Street. By the time this article was written, the ACL had abandoned the line through downtown into Bessemer, and operated out of Boyles yard as part of the Family Lines.

John has chosen the ACL as the prototype for his layout through the downtown area. Currently many of the structures are mockups so the layout can have operations, an area of model



12. Sloss Furnace on the old layout. This has been carried over to the new layout and is being installed as TCI. *John Stewart photo*



### 13. Mockup of the coke ovens. *John Stewart photo*

railroading John enjoys. He is a member of the OpSig modelers, and at conventions you won't see John for days as he attends all of the OpSig meets. He has implemented and given clinics about the JMRI computer operations program. For his clinics on this subject, visit [bhamrails.info](http://bhamrails.info).

## The great flood of 2013

Another area where John successfully used mockups and partial models was the coke and furnace operations. He has the Walthers coke plant and the blast furnace kits; however other more pressing issues have intruded on his model building time.

John and his wife were away from home, visiting their son, when the telephone rang. Answering it, they discovered that their house sitter was calling and telling them that the washing machine's hose had broken and that water was all over the main floor of their home. She had stopped the water, but the damage had been done to the floor and water gone down into the basement where the layout is located.



## LITE AND NARROW | 18

Arriving home, John discovered that the layout had been spared, with some minor water damage, but the carpeting on the floor had not. The insurance company was willing to replace the carpet, but the big question was, how to do it under the layout.

Fortunately the around-the-walls sections of the layout had been cantilevered from the walls, leaving that space clear to replace the carpet. Not so fortunate was the Red Mountain peninsula with legs resting on the carpet. A decision had to be made as to how to get the layout off the carpet so that it could be re-laid.

The solution; John and Craig attached hooks to the ceiling joists, and attached cables from them to the peninsula. They lifted the entire section, suspending it high enough off the floor to allow the floor to dry and have clearance for carpeting. For several weeks, the section hung suspended above the floor, and some of us were beginning wonder if John had discovered a new



14. Mockup of coke ovens in the background and by-products plant in the foreground. *John Stewart photo*

way of supporting benchwork, prior to his announcement that everything was back to normal.

John Stewart's layout will be on tour for the Southeastern Region's annual convention in Bessemer in 2017. If you would like to visit this layout and at least 20 others, please come and sit for a while.

*See the videos on the following pages ....*



**Click here for  
reader comments**

**Take the MRH  
2016 Reader Survey ...**



**... and get a chance  
to win a 10" Kindle  
Fire tablet!**



**fire HD10**  
**OUR LARGEST  
DISPLAY**  
— ON OUR —  
**THINNEST TABLET**

**amazon**

**TAKE THE SURVEY >>**



Playback problems? [Click here ...](#)

15. A tour of the Birmingham District layout. This video was taken five years ago, before scenery was installed.



**Click here for  
reader comments**



Playback problems? [Click here ...](#)

16. A video tour of the downtown lead showing how the railroad gets to various industries, and identifies the location of the over-passes and structures.

**Want to help keep  
MRH free?**

**Then *click* on ads!**





**FT SANTA FE #163**  
(war bonnet)  
Item No. 68901



**GP35 BNSF #2520**  
Item No. 68801



**RS-3 SANTA FE #2099**  
Item No. 68605



Click to watch video

# TOUCH-SCREEN TRAIN CONTROL IS HERE! HO E-Z APP™-EQUIPPED LOCOMOTIVES HAVE ARRIVED

Enjoy wireless touch-screen control of E-Z App™-equipped locomotives through your Bluetooth®4-supported Apple® smart device. Now you can have speed, direction, lighting, and sound control at your fingertips using your Apple® iPhone®, iPad®, or iOS device and the FREE E-Z App™-download. Your choice of three E-Z App™-equipped engines is available: EMD FT, GP35, and Alco RS-3. Get ready for wireless touch-screen control with Bachmann's E-Z App™!

**Features of E-Z App™ Touch-Screen Train Control include:**

- wireless control with any Bluetooth® 4-supported iPhone®, iPad®, or iOS device (includes iPhone® 4s, 5, 5c, 5s, 6, and 6 Plus; iPad Air® and iPad mini™, 3rd and 4th generations; iPad Pro®; and iPod touch® 5 or newer)
- operates from up to 100 feet away with Bluetooth® Smart technology
- realistic, dynamic engine sound broadcast through your Bluetooth® 4-supported smart device
- requires 16 volt DC or DCC track power for operation
- ready to launch and use instantly after downloading the FREE Bachmann E-Z App™ from the Apple App Store™
- no configuration or additional equipment required



**SHIPPING NOW!**

**FT with E-Z APP™ TRAIN CONTROL**



**NEW YORK CENTRAL® #1600**  
(lightning stripe)  
Item No. 68902



**LACKAWANNA #604**  
Item No. 68903



**SOUTHERN #6100**  
Item No. 68904



**WESTERN PACIFIC #901**  
Item No. 68905

**EMD GP35 with E-Z APP™ TRAIN CONTROL**



**PRR #2252**  
Item No. 68802



**GREAT NORTHERN #3021**  
Item No. 68803



**RIO GRANDE #3044**  
Item No. 68804



**CANADIAN NATIONAL #4000**  
Item No. 68805

**ALCO RS-3 DIESEL LOCOMOTIVE with E-Z APP™ TRAIN CONTROL**



**PRR #8605**  
Item No. 68601



**RIO GRANDE #5202**  
Item No. 68602



**NEW HAVEN #543**  
Item No. 68603



**BOSTON & MAINE #1508**  
McGINNIS  
Item No. 68604



Bachmann Industries, Inc. • 1400 East Erie Avenue

Philadelphia, PA 19124 USA • www.bachmanntrains.com

Click to learn more.



# WHAT'S NEAT WITH KEN PATTERSON

KEN PATTERSON

column



[Click here for  
reader comments](#)

## NEW AUTO MODELS, AND INSTALLING SOUND CAR ...

**IN THIS MONTH'S VIDEO, WE LOOK AT USING** acid to weather corrugated roofing and siding material. This has been covered in printed magazine articles but has never been featured in a video that lets you watch the process. Mike Budde comes by with some new HO scale automobiles made by Dutch Art models.

We have a segment on a kid's push toy wooden train layout, and we do a Soundtraxx Sound Car decoder installation that includes making our own power pickup wipers. This wiper trick can also be applied to HOn3, HO, and N scale models. These power wipers are made from HO scale Kadee #5 coupler box springs.

Jon Dietzen provides us with some cool prototype drone footage from Saginaw MI, and I show you a clean, easy and fast way

▶ [PHOTOS AND VIDEO OF SUPERB MODELS](#)

## WHAT'S NEAT | 2

to stain large amounts of railroad ties for scratchbuilding and handlaying track. Add a few run-bys, and we have 27 minutes of material for this month's show.

### Etching segment



1. We use PCB Etchant Solution from Radio Shack to weather corrugated aluminum roofing material. This is some nasty acid, so wear chemical-resistant gloves and a respirator. Work outside if possible. Work with the material in a well-vented spray booth if you must perform the etching process indoors.



[Click here for reader comments](#)



## WHAT'S NEAT | 3



2. The corrugated metal is cut into 3x8 scale foot sections for HO. One bowl is filled with the etchant, and the other with water. The water stops the process.



Playback problems? [Click here ...](#)



## WHAT'S NEAT | 4



3. I place the metal in the bowl of etchant, and in 20 seconds the boiling process begins. Here you see the violent bubbles as the acid eats away at the metal's surface.



4. I use a pair of tweezers to remove the metal from the acid and place it in a bowl of water to stop the process. If you let it boil for more than 30 seconds the metal will dissolve completely.

## WHAT'S NEAT | 5



5. When the pieces come out of the water they are black. When they have dried for a few hours, they get this rusty brown appearance.



6. This is what the metal roofing looks like on the B.T.S. Hyde Pulp Mill kit. The varying shades of etching/rust effect make the roof look believable.



## WHAT'S NEAT | 6

### Dutch Art cars segment with Mike Budde



7. Mike Budde drops by with some amazing resin-cast vehicles sold by a company called Dutch Art Models. They come with cast glass inserts but you must supply your own wheels.

**Want to help keep  
MRH free?**

**Then *click* on ads!**



8. Mike finished five of the models with paint, decals and Bare Metal Foil. He even added license plates, making the models photograph-ready for any scene or layout. The '69 Chevy Nova rocks. Mike said all of the cars finish into very realistic looking models and have very accurate details.

## Take the MRH 2016 Reader Survey ...



... and get a chance  
to win a 10" Kindle  
Fire tablet!



fire HD10  
OUR LARGEST  
DISPLAY  
ON OUR  
THINNEST TABLET

amazon

**TAKE THE SURVEY >>**



# WHAT'S NEAT | 8

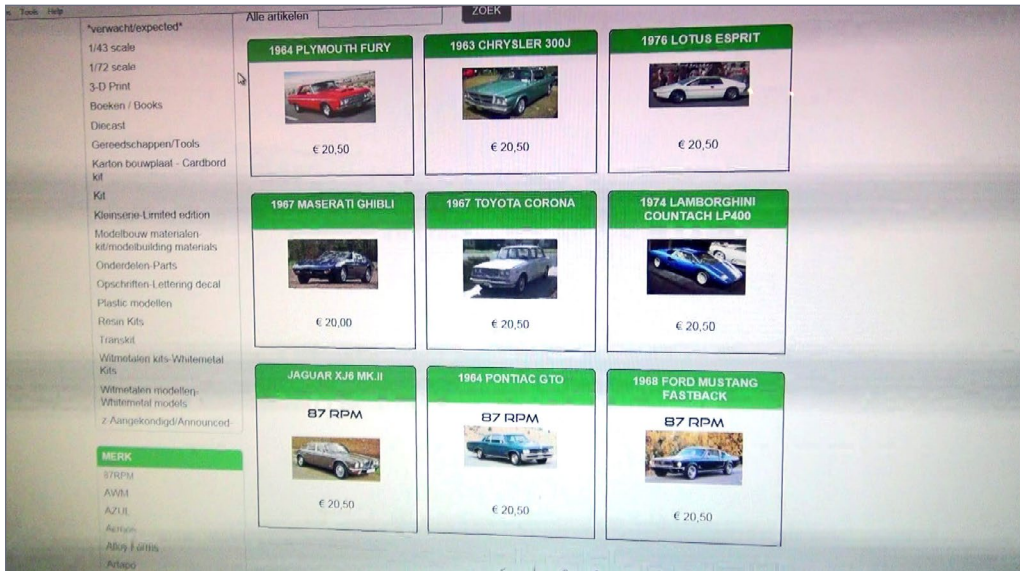

9. To find this company go to [dutchart-models.nl](http://dutchart-models.nl). They are in The Netherlands and the prices are in euros. They sell American and European models, and actually cars from all over the world.



[Click here for reader comments](#)

# KEN PATTERSON 2016 Calendars

Brought  
you by  
**MRH**  
MODEL RAILROAD HOBBYIST

Wallpaper  
photo downloads  
included!

Made especially for model railroaders by MRH

Best of Ken Patterson

Also available:

Ken Patterson's Colorado Narrow Gauge



A Union Pacific train rumbles across a river crossing on Ken's home layout, load by GP40 #5833. This is a BLMA bridge and location.

2016	MARCH						
Sunday	Monday	Tuesday	Wednesday	Thursday	Friday	Saturday	
1	2	3	4	5	6	7	
8	9	10	11	12	13	14	
15	16	17	18	19	20	21	
22	23	24	25	26	27	28	
29	30	31					

Major model RR event dates included!

Wall calendars:  
Open to 11" x 17"



~~\$18.88~~

\$16.99  
+ S&H

GET YOUR CALENDAR TODAY >>

store.mrhmag.com

Drone footage



10. Jon Dietzen provides us with some spectacular drone footage from the rail yards in Saginaw MI. This is a turntable scene that looks like a model, as this video provides us with modeling ideas in "Modeling Ideas From Above."

112,000 have seen this MRH video - *have you?*

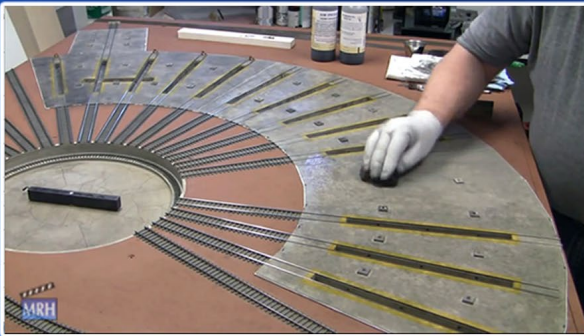

Watch the video now





## Push train layout



11. This month we look at a train layout that I built for my kids, to share the idea so you can build one for your children or grandchildren. These model trains are very popular with the kids and can make for hours of play.



[Click here for  
reader comments](#)





12. I built three drawers into the base to hold track and trains. Wheels on the base make for easy vacuuming under the table.

## Did you see this MRH video?



The ultimate “Yes, it’s a model” video as James McNab switches NW 86th

[Watch the video now](#)

## WHAT'S NEAT | 12



13. Industrial-strength drawer slides from Home Depot have a weight rating of 150 lbs., in case your kids decide to sit or stand on the table or drawers. It works well and makes things safe.



[Click here for  
reader comments](#)

# WHAT'S NEAT | 13

## Railroad tie staining



14. Rather than stain ties with a coffee can and a strainer the old school way, I like to place my ties 500 or 1000 at a time in a Ziploc bag and pour in about five teaspoons of tie stain.





15. Dump the ties on a paper towel and let them dry outside in the sun for five or six hours. Then you're ready to scratchbuild or handlay track. This technique is fast and there is zero mess.

***TrainMasters TV is part of  
the MRH product family.***

***TMTV members not only get great network TV level  
videos, they help pay for MRH and keep it free ...***



# WHAT'S NEAT | 15

## Soundtraxx SoundCar decoder installation



16. This month we are going to tackle the easy process of installing a Soundtraxx SoundCar decoder inside this Blackstone HOn3 reefer.



17. I used a screwdriver to carefully pry off the bottom of the reefer to reveal the speaker mount in the car's floor.

**Did you know  
there's an  
MRH index  
available?**

**CLICK TO FIND OUT MORE**

## WHAT'S NEAT | 17

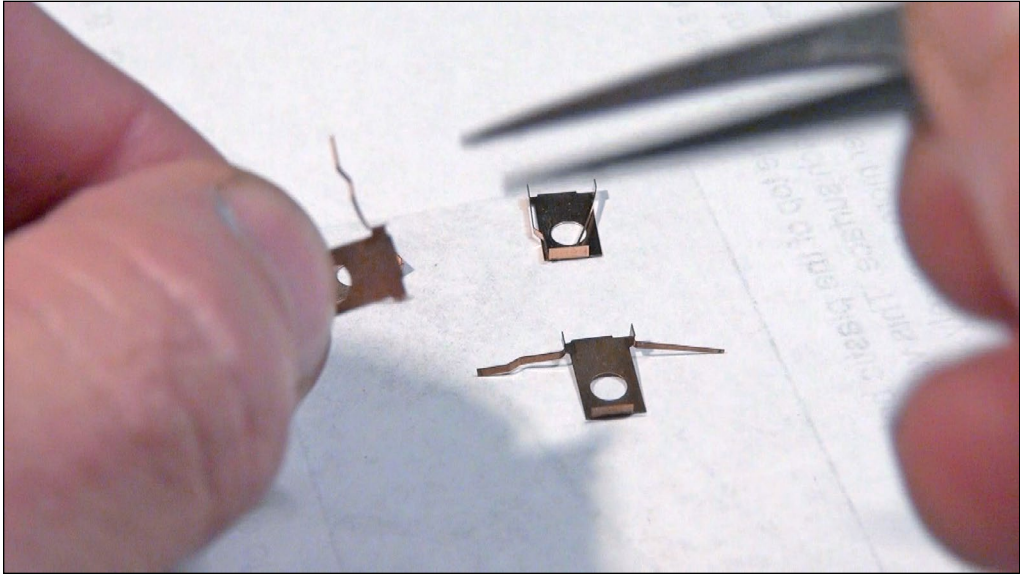

18. I bent Kadee HO scale #5 coupler box springs as shown in this photo to form the power wipers.



19. I cut the coupler box spring just beyond the punch hole and solder very fine stranded wire to these wipers.



## WHAT'S NEAT | 18

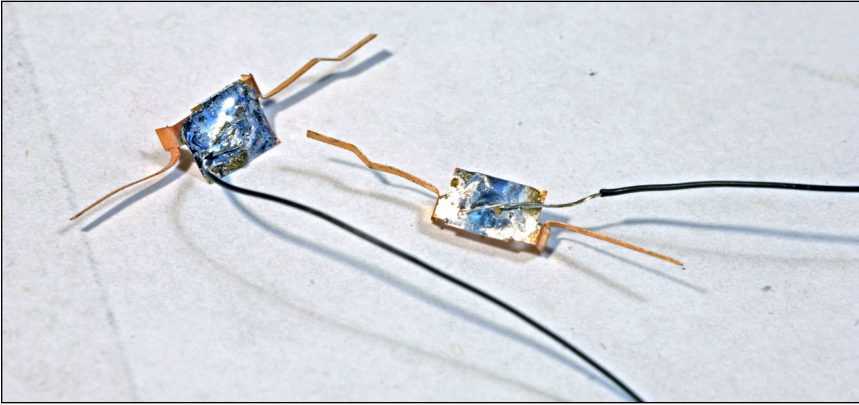

20. I glue the new wipers to the top of the truck bolsters with contact cement. This glue is flexible and will stick to the Delrin material the trucks are made from. Notice that I have good wiper contact with all four wheels.

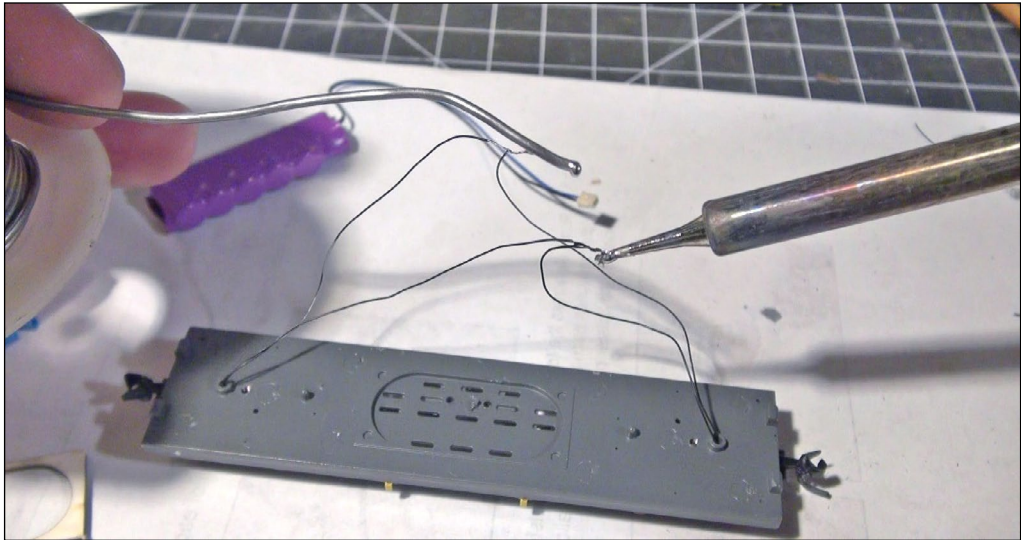

21. After reattaching the trucks to the car bottom, pull the wires through the holes next to the coupler boxes in the floor of the car. Solder the right side power feeds together, and then solder the left side power feeds together.



## WHAT'S NEAT | 19

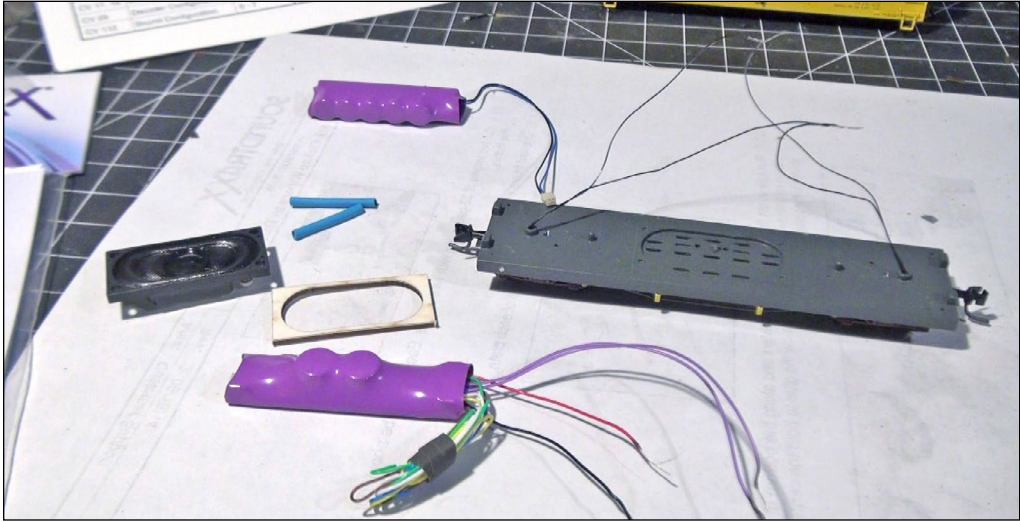

22. Here are all of the parts: the SoundCar decoder, the Current Keeper, the 35x16 mm speaker, and the foam self-adhesive speaker gasket. All of this is available from Soundtraxx.

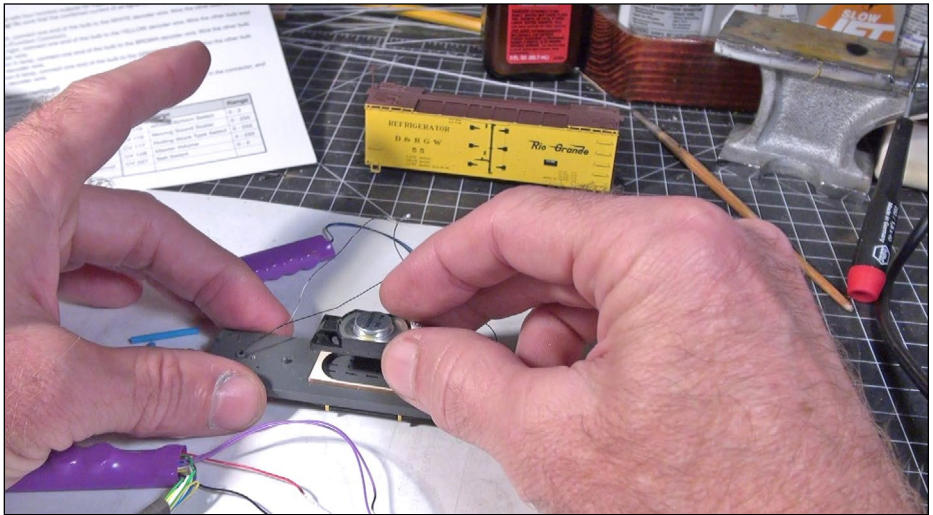

23. I mount the speaker gasket to the floor of the car, then press-fit the speaker on top of that.

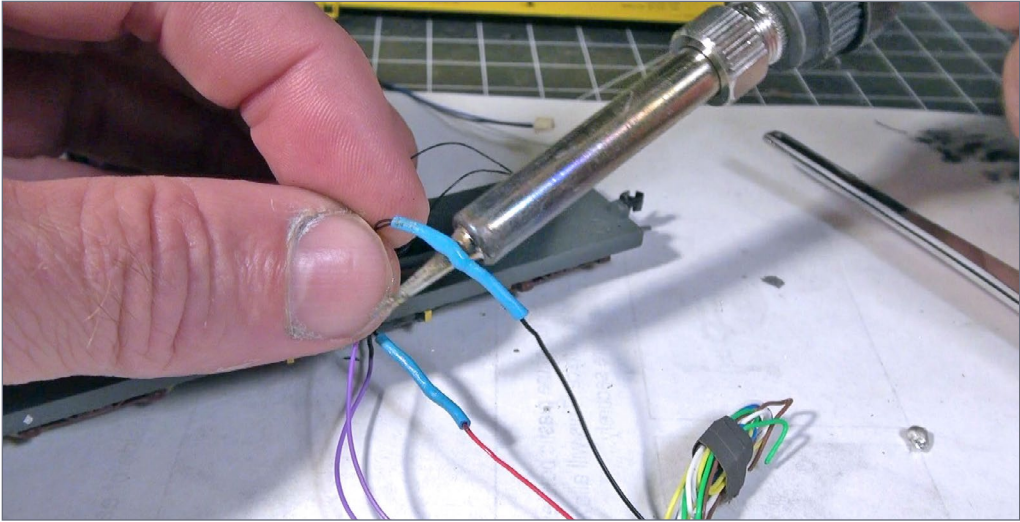

24. I use shrink tubing to insulate the solder joints as I solder the decoder to the truck power feed wires, red wire to the right side of the car and black wire to the left power pick-up wire of the car, as per the decoder instructions.

**Use our custom  
Google search on the  
MRH website to find  
topics of interest**

[CLICK TO FIND OUT MORE](#)

# WHAT'S NEAT | 21

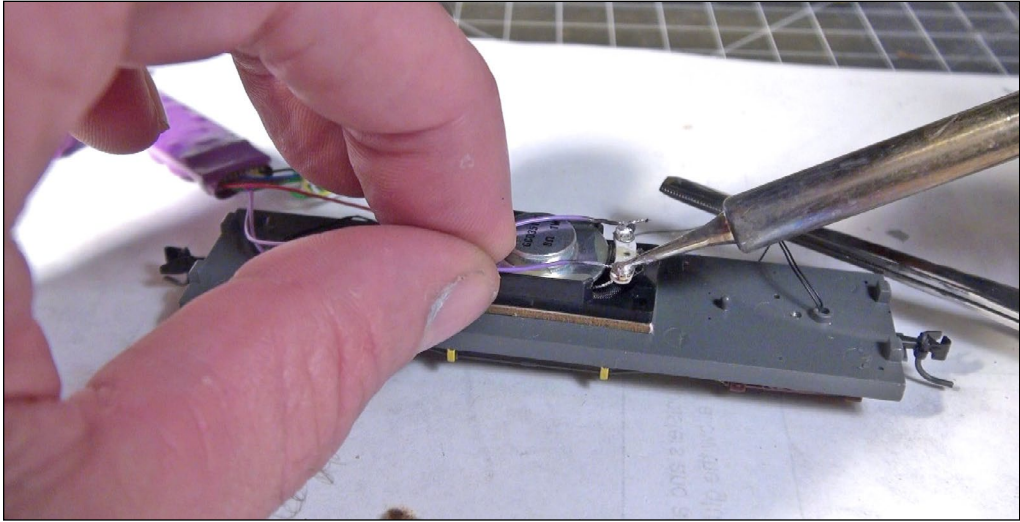

25. I solder the decoder speaker wires to the solder pads on the speaker.

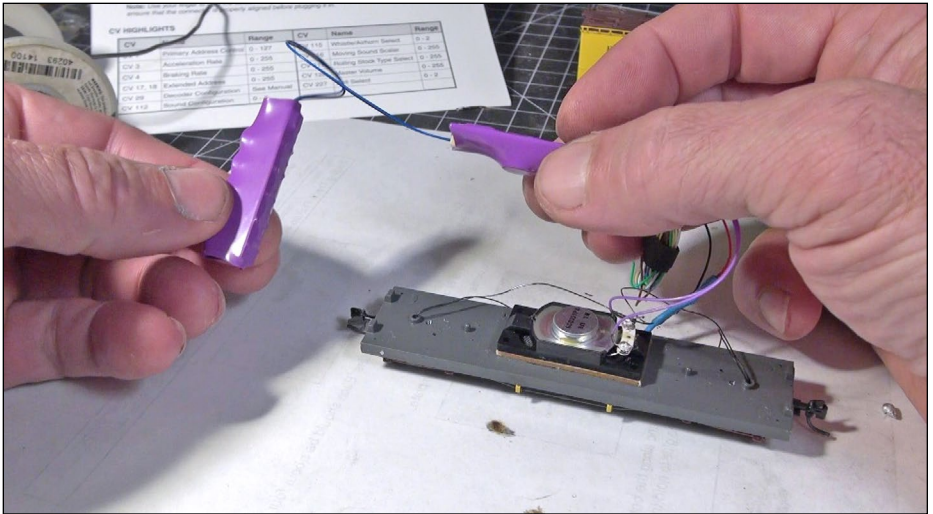

26. Installing the Current Keeper is easy. Simply plug it into the jack on the end of the Soundtraxx sound car decoder. This will ensure constant sound even when the power to the car is interrupted on dirty track.



## WHAT'S NEAT | 22



27. I use two-sided foam sticky tape to mount the decoder to the roof of the reefer, and more tape to mount the Current Keeper to the side of the car.



28. I reassemble the car, taking care to not pinch any of the wires. It is now ready for a test on the layout.



## WHAT'S NEAT | 23



29. A cutaway view of the car shows the decoder and Current Keeper installed along with the speaker. It all fits perfectly. I programmed the car to run a few times with flange squeal and rail joint sounds in combination. Then I programmed it to run with just joint bar click-clack sounds so you can hear the difference in the video.

# WHAT'S NEAT | 24



30. To test the sound car on the layout, I waved a magnet along the roof of the car so the decoder could find the locomotive's address and automatically consist with it as I pushed F8 on the throttle four times. Now the car is consisted with the locomotive and will run and give sound effects that match the speed of the locomotive. Don't forget to click on Reader Comments and rate this month's edition of What's Neat.



[Click here for  
reader comments](#)



31. To test that the Current Keeper is working, simply pick up the car from the layout. If everything is right, you will hear the sound effects for as long as 10 to 15 seconds without track power.

***Want to keep MRH free?***  
**CLICK on ads.**

*If ads in MRH don't get clicks, then advertisers won't advertise with us, it's that simple ...*



*Learn to solder track, wiring and  
brass models in this video!*

**CHECK IT  
OUT!**



**kenpatterson.com**

*click here to ...*

**Visit Ken's website**

**Ken Patterson shows  
you how to solder like  
an expert!**



# iwata

by ANEST IWATA

*Just Rolling By...*

Make It **REAL** With Iwata

*Climb Aboard!*



**Eclipse  
HP - CS**

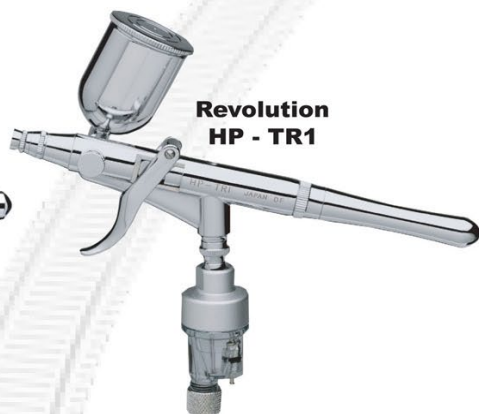

**Revolution  
HP - TR1**

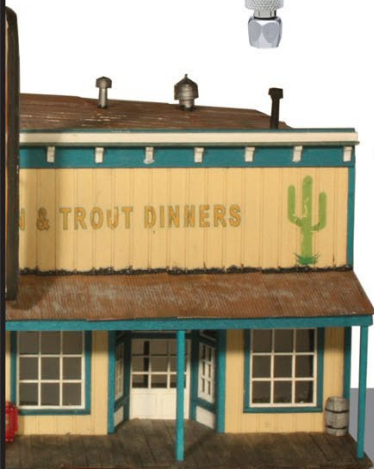

**Visit...**

**[www.iwata-medea.com](http://www.iwata-medea.com)**

**To Check Out Our  
Full Product Line!**

*Models By... Alan Houtz,  
North American Prototype Modelers*



DAVE MEEK  
.....

# IMAGINEERING

column



[Click here for  
reader comments](#)

## TEN TIPS FOR MODELING STRUCTURES WITH CHARACTER ...

**I LIKE MY MODEL RAILROAD STRUCTURES WITH** loads of character. To me, structures are not just background for the trains; they're supporting players that help move the story along and contribute to the overall entertainment value of the layout. Just about every structure on my On30 Thunder Mesa Mining Company is designed and scratchbuilt for a specific location. It has to be this way to get the look I'm after. But character can be elusive. We tend to know it when we see it, but how does it get there? Is it just architecture, paint and details, or is there more to it than that?

For me, it can be boiled down to a handful of broad design concepts. To illustrate, I'll take you through the design choices made for my scratchbuilt Olson & Furlow Saloon. As with most

▶ [EXPLORING THE CREATIVE SIDES OF THE HOBBY](#)

of the structures on the layout, the saloon is small and compact to fit the railroad's 19th Century "Wild West" design aesthetic. Still, it doesn't matter what era you model or what building methods you prefer; good design is good design. Whether you are scratchbuilding or choosing a kit, the following tips still apply. Even large, modern structures can benefit from a few tricks of the trade when it comes to guiding – and even fooling – the eye.

### 1. Know the backstory

Building models is a form of storytelling. Understanding this means that design choices are not arbitrary but are built on an underlying narrative. Whether a model is mundane or fanciful, character should arise from its place in the story. backstory should cover the all-important *who, what, where, when, and why* required to fuel your imagination and give direction to the model [1]. Here's the nutshell backstory of Olson & Furlow's.

*Deep in the canyons, about halfway down the line between San Lorenzo and Thunder Mesa is the whistle-stop burg known as Hanging Rock. It's a lonesome place, once a stronghold for the Indians and now a haunt for outlaws. There, on a small rise between the mainline and a weed-grown siding, stands the Olson & Furlow establishment. Part saloon, part store, the old place has a character born from its bawdy history and seasoned by the harsh climate of the desert. The adobe casita that forms most of the ground floor probably dates from the 1850s, but nobody can say for sure. The place was abandoned when Olson and Furlow took it over in 1878 and added the wooden upper story. They were railroad men who came west with the construction gangs to help build the bridges at Horse Thief and Coyote Canyons. That was*



1. The Olson & Furlow establishment is located in the former construction camp turned outlaw hideout known as Hanging Rock. Creating a backstory to establish the who, what, where, when, and why of a structure really helps build character right into the walls.

*backbreaking work, and so, as the story goes, they decided to go freelance and open a saloon.*

Knowing the backstory behind a model helps to answer the inevitable questions that arise during construction. Building on that knowledge virtually guarantees that a structure will have far more character than any random model plunked into a scene.



## 2. Know the people

Beyond the basic backstory, knowing a little something about the people who frequent your miniature scenes will contribute greatly to their overall believability and character.

For example: The pair of ne'er-do-well ex-railroad men who built the saloon at Hanging Rock were creative and resourceful fellows who had a way of making the most of whatever was at hand. Clearly they would have bashed together their new venture with materials scrounged, borrowed, or otherwise acquired from the railroad camp. Each was also known for having a certain sense of style, so the resulting structure would reflect that as well. Furlow was a capable carpenter, while Olson was handy with a paintbrush. Together they could doubtless cobble together a distinctive establishment that would make up for in personality what it might lack in refinement.

Patrons would naturally be of the rougher sort, starting with the railroad construction gangs, and on up through the local outlaws that hideout in the labyrinth of canyons nearby. Horse thieves, highwaymen, robbers, bunko artists, card sharps, freelancers, lawmen, and even one or two soiled doves would likely find their way to Olson & Furlow's place. All of them would leave their mark with wear and tear, stains, grime, posters, handbills, and even a few bullet holes. All of those characters would add character [2].

## 3. Know the era

Thunder Mesa exists in an inexact time period somewhere between 1890 and 1910ish. The railroad itself was completed in 1879, so most structures date from about that time (give or take a few years). Naturally, modeling even a broad historic period means research. It's important to understand the building



2. Who is this suspicious looking fellow standing by the window? By the looks of him, he's armed, dangerous, and probably hunting trouble. Knowing something about the people who built and frequent your structures does more than tell you what kind of figures to add; it informs everything about the model, from the architecture down to the smallest details.

techniques, styles and materials that were common at that time [3]. Even when working from a kit, I don't assume that everything is already period-correct. I always try to dig a little deeper.

For me, there are few things more enjoyable than thumbing through old books and periodicals about the Old West. I've also been lucky enough to travel to places like California's Gold Country, old Colorado mining towns, and the ghost towns of



3. Fancily painted false-front structures were a popular choice for commercial buildings in the Western U.S. during the period represented. The graphics, decor, and architectural details are all common design elements of the era. Along with the diamond stack and square headlight of the locomotive, they work together without contradiction to help establish the time setting of the story.

Arizona and the Mojave Desert. I take notes and hundreds of pictures when I'm there, to look through later when I'm modeling. Even if you can't travel or don't have access to a vast collection of books, there's still the Internet. Today, we are all fortunate to live in a world where a wealth of information exists right at our fingertips. Nearly everything you might want to



# IMAGINEERING | 7

know about architectural styles and period building techniques can be just a quick Google search away.

## 4. Know the country

No less important than when your structure was built, is where it was built, and again good research comes into play. Just because you really like the looks of that cut limestone structure kit you saw

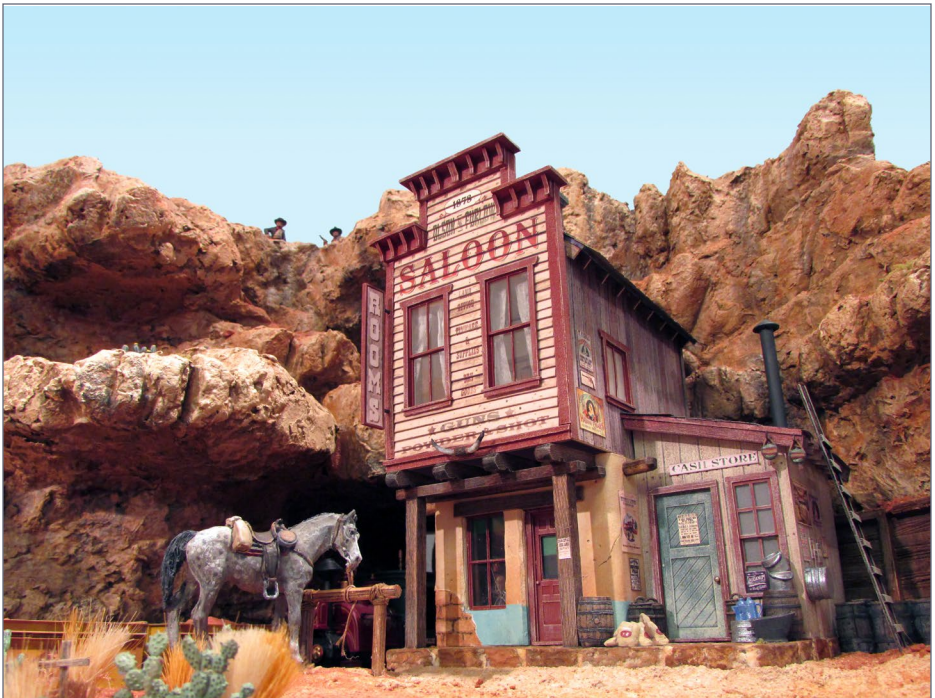

4. Olson & Furlow's may be built mostly from illustration board, but the look is pure Desert Southwest. From the flagstone foundations, to the lower adobe walls and upper wooden story, all materials represented reflect what would have reasonably been available to build from in that time and place. As a bonus, the character of locally sourced materials naturally complements the high desert locale.





5. I wanted to show the colorful history of the structure by placing a newer wooden story above an older adobe base. Adding the store addition and having the upper story overhang the porch are unique ideas gleaned from researching period photos.

advertised in a magazine doesn't mean it will necessarily fit in on your layout. Was limestone a common building material at that time and place? Could it have reasonably been quarried nearby? Is it likely to have been shipped in? Were there skilled stonemasons in the area who could have built it? You get the idea.

For the most part, Thunder Mesa represents the high desert canyon country of the American Southwest. The sandstone canyons can be hot and barren, but cool stands of Ponderosa pine often grow at the higher elevations. Most structures on the layout are modeled to represent the common building materials from this region: random sandstone, mud-brick adobe, and pine. Brick buildings are still a novelty around here. All the local materials are reflected in the construction of Olson & Furlow's: sandstone for the floors, and adobe and pine for the walls [4]. Knowing and using the common building materials for the region you are modeling adds another layer of authentic character.

## 5. Be different

For Olson & Furlow's, I wanted to dig past the usual clichés that come to mind when we hear the words, "western saloon." Through my research I discovered that not every frontier drinking establishment had butterfly saloon doors and painted windows. They came in all shapes and sizes and some, especially in smaller settlements, engaged in various other forms of local commerce beyond just whiskey and gambling. This gave me the idea of adding a small store to the building where dry goods and supplies could be traded (no questions asked). Adding the store also gave me an excuse to decorate the facade with colorful signs and period posters. Always a plus!

Knowing the history and local building materials got me thinking about mixing a Spanish-style adobe structure with a newer

Anglo-esque addition for something that would be truly different, yet still work within the larger story [5]. I'm not advocating modeling the quirky and unusual just for their own sake, but rather to embrace those opportunities as they come along, when a little something extra is right for the scene. Finding a different angle on things opened my mind to new ideas, helping to visualize a unique structure that would bring added dimension to the story I wanted to tell.

## 6. Use visual literacy

This is where things get artsy! Visual literacy means understanding how shape, color and texture work together to lead the eye and evoke emotion. Don't worry, you don't need to be an art school graduate to grasp the basics of this (but if you do understand it, it will help with a lot more than just structures). For color, texture and shape it really all comes down to a question of same vs. different.

For example, say you have two structures next to each other, both two-story, beige stucco with flat gray roofs. They are very similar in color, texture and shape. What happens when the eye passes over them? It keeps going! Why? Because everything is the same, there is nothing *different* for the eye to stop and consider. Now, change one variable – paint one of the structures red. Now the eye pauses for a moment. Change another variable – add a peaked roof to the red structure. It's taller now. The eye stays longer to examine the differences. Change the third variable – make the red structure wood instead of stucco. Now you have maximum interest in the change that occurs between the two structures and the eye comes to a full stop. Congratulations, you have led the eye of the viewer to what you wanted them to see. Artists do this in their work every day and so can you.

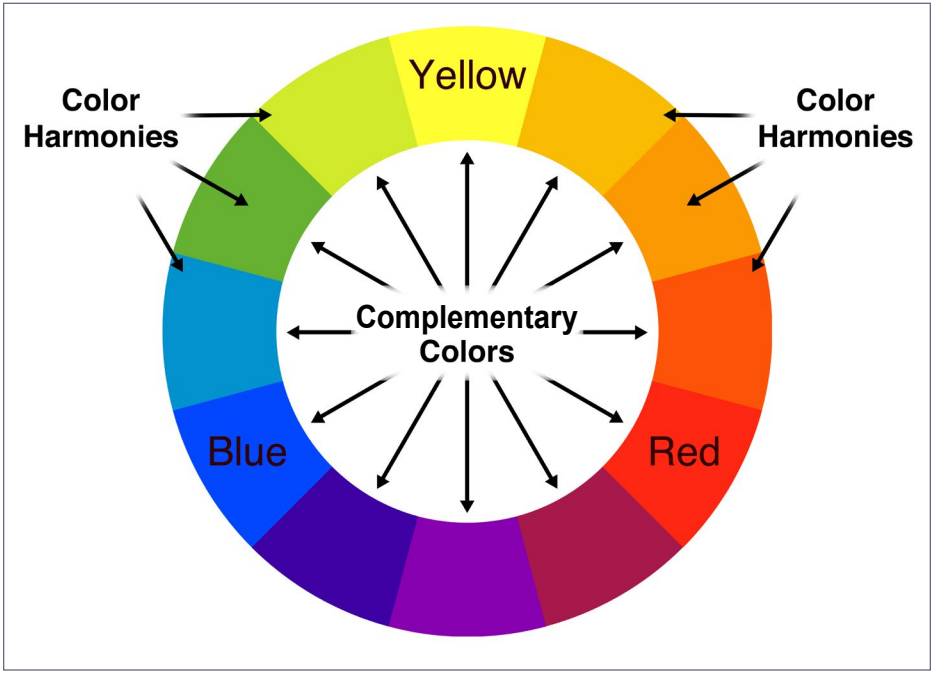

6. Understanding how color works is important in any modeling project. Basically, complementary colors are directly opposite each other on the color wheel while harmonious colors are directly adjacent. Complements create drama and interest while harmonies are generally soothing. Mixing complementary colors together will give you various shades of brown. Mixing adjacent colors will give you new harmonies.

To simplify: *same* keeps the eye moving and *different* slows it down or stops it.

Shapes that flow and lead into other shapes also keep the eye moving, as do harmonious colors placed next to each other. Contrasting colors, values, shapes and textures stop the eye. Evoking emotion with color is a huge topic in itself, and entire books have been written on it. For the purpose of this discussion, suffice to say that harmonies create areas of calm while



contrasting or complementary arrangements lead to drama and excitement [6].

## 7. Mock-up and test

I'm a great believer in using mock-ups to test how a planned structure might work in a given scene. In fact, building a mock-up has become standard procedure for just about every scratchbuilt structure project on Thunder Mesa. Mock-ups can be basic white cardstock, or more elaborate affairs built from the actual structure plans printed to scale. I tend



7. As you can see, the original paper model mock-up for Olson & Furlow's looks quite different than the final model. This is often the case as better ideas emerge through the design and building process. I find mock-ups like this to be invaluable tools for laying out and visualizing scenes.

to prefer the latter, and use these planning models to test not only the size and placement of a structure in a scene, but also things like color choices, architectural details, and even the placement of wiring for lights. Changes are almost always made to a plan during this stage and, as was the case with Olson & Furlow's, the final structures often look quite different than the original mock-ups [7]. Those changes prove the mock-up's value. Changes to a plan reflect lessons learned, and it's much better to learn them with inexpensive cardstock than on the final model.

## 8. Cheat the perspective

On a model, as in all art, the mathematically correct perspective does not always work visually. Perception is a funny thing. Due to vagaries of how the human mind processes visual input, what you see isn't always what you get. Sometimes it's better to just go with what feels right and focus on the emotion of a thing rather than the reality.

Like other structures in Thunder Mesa, Olson & Furlow's is small and tall. This fits the period look of the railroad, but it also reveals a favorite design trick of mine. Basically, I cheat the perspective by adding just a little extra height to the building, often just a scale foot or so. Too much results in an obvious caricature, while just a pinch of extra height contributes greatly to a structure's charm and appeal [8].

This is really a type of forced perspective, a concept many hobbyists are familiar with for creating the illusion of depth and distance in scenery. Usually we think of it in terms of things like trees getting smaller toward the top of a ridge to make the mountain seem higher. Here I'm talking about the opposite effect. Since we are usually looking slightly down

at our structures, subtly adding extra height can make them look just right to our 1:1 scale eyes.

## 9. Use weathering as a story point

Weathering is a way to add history to a model. It shows how well (or not) a structure has been cared-for over time. That's a story point. Choices on how to weather a structure all lead back to the established backstory. For example, I know that Olson & Furlow's is around 20 years old, with the adobe under-story being somewhat older. I know that it was more prosperous in the past during



8. Olson & Furlow's uses a visual trick I like to call "reverse false perspective." Simply put, a smidgen of extra height is added to the structure to make it look right when viewed from the usual angles. It's a cheat, but it works.





9. How much weathering is too much? Depends on the story! Here the tar paper roofing tells a story of age and neglect – and some signs of recent repair. Dust and dirt, rust streaks and faded paint, cracked plaster, and bullet holes all tell stories about the age and character of a structure.

the boom times of railroad construction. I know that it caters to a rough clientele. I know the materials it was built from, and I know that it exists in a place where the harsh desert elements can take their toll. Each of these points is instructive for how and where weathering should be added [9].

How different materials age and weather is another topic, but I find it handy to keep a file of photos showing the ravages of time on all sorts of structures and equipment. Good research again comes into play.



# IMAGINEERING | 16

Proper weathering can add an enormous amount of character to a model. Just keep in mind that every dab of grime, streak of rust, and dusting of chalk speaks volumes about the history of your structure.

## 10. Use informed detail

Detail does not mean clutter. By its very definition, detail is *specific*. Informed detail is *story-specific*. Just as with weathering, every detail added to a model should support the underlying



10. All the details in this scene were chosen to help tell the story. From the shiny new goods for sale at the Cash Store to the colorful signs and faded posters, everything is there for a reason. Even the broken boards and empty beer bottles are signs of life, left behind by the people who have passed through.

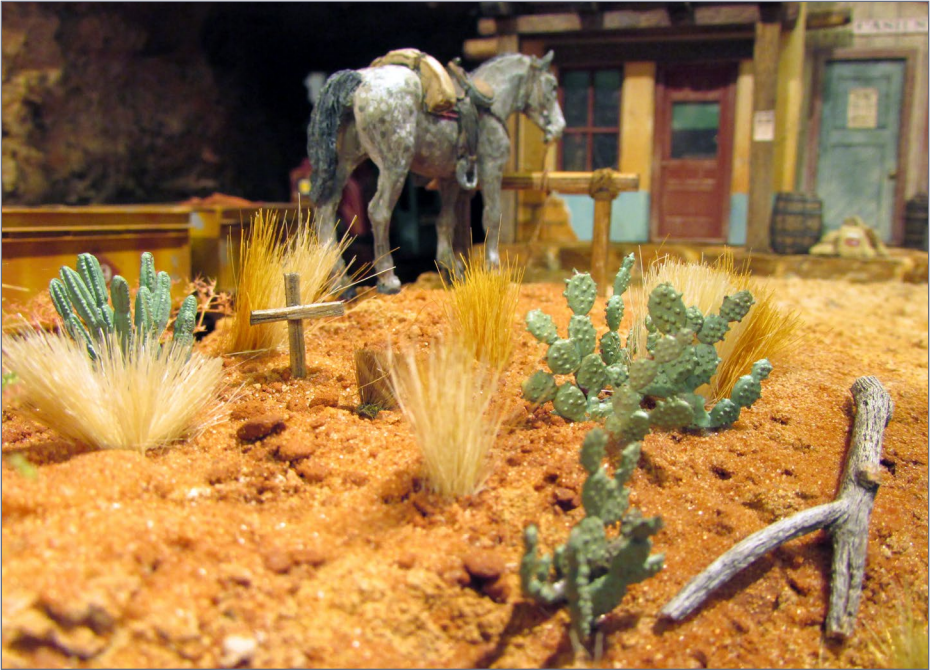

11. Details are signs of life – and sometimes of its passing. This little vignette in front of Olson & Furlow’s tells a story all its own.

narrative. For the most part, all those tiny details are signs of the comings and goings of people. It’s stuff they’ve left behind, stored for later, forgotten, worked on, used, or neglected. Details are signs of *life*.

Knowing well the people and the place they inhabit will tell you what kind of details to add and how much. For my saloon project I wanted to imply a lively black-market trade, and that is reflected in the selection of details around the store area. Weeds and discarded junk tell a tale of neglect. A few wanted-posters, bullet holes, and the placement of figures convey a sense of past and impending action [10].

Informed detail never contradicts the narrative with anachronistic or out-of-place objects that would take you out of the story. Everything belongs. Details are supporting players. Their role is to flesh-out the story, not distract from it [11].

## Summing up

So what is character in a model structure? I think it's a believable place for people to inhabit. It's research that pays off with scenes that take you away to a particular time and place and then show you something new. It's the artful use color, texture and shape to draw you in. It's history written on the walls by time and revealed in the smallest details. It's a pinch of magic. A structure with character has an illusion of life conveyed through a story well-told.



[Click here for reader comments](#)

**Want to help keep  
MRH free?**

**Then *click* on ads!**



# TRAINMASTERS.TV

*NEW Mike Confalone  
weathering series ...*



Brought to  
you by

**MRH**  
MODEL RAILROAD HOBBYIST

Starting in  
mid-January!

Non-members can watch for  
only \$1.49 per segment

**BEFORE**

**AFTER**

*No airbrush  
required!*

Visit the TrainMasters TV website 





# MRH MARKETPLACE

## Trees!



## coastmans



LED Lights and Accessories

[www.lights4models.com](http://www.lights4models.com)

614-296-8691

Lighted, Animated, Signs and Billboards for all your Modeling projects



P.O. Box 6 Paonia, CO 81428

Ph. 970 527 4586

Made in The USA

Cast resin items for All Scales.

Tunnel portals, bridge piers, abutments, culverts, and retaining walls.

Trackside details and sage brush tree armatures.

"FREE SHIPPING see website for details"

### STREAMLINED BACKSHOP

Sales  
... Services  
..... Solutions

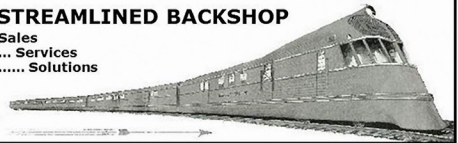

### "SUGAR CUBE" SPEAKERS...

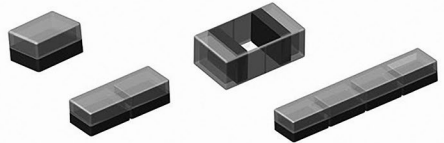

4 Sizes \* 4 Baffles

... "Sweet" Speaker Options!



JEFF OTTO  
TURNIN' IT OUT

414-915-4671

[ohrtracksupply.com](http://ohrtracksupply.com)

[jeff@ohrtracksupply.com](mailto:jeff@ohrtracksupply.com)

N36W23431 Oak Hill Ln.  
Pewaukee, WI 53072

### Freight Car Weathering



[Tsmokeboxgraphics.com](http://Tsmokeboxgraphics.com)



[www.SBS4DCC.com](http://www.SBS4DCC.com)



Now Available Again  
KIT #5761/5762 PRR GLA  
Modernized Hopper

Check our Website For  
List of Closeout Kits.  
[westerfieldmodels.com](http://westerfieldmodels.com)

LOOK  
at what's new at  
Black Cat this month

Click here for  
our website

Sinclair & Semet-Solvay  
Tank cars



Black Cat Publishing  
(204)489-5005  
[ajfergus@mymts.net](mailto:ajfergus@mymts.net)  
[blackcatdecals.com](http://blackcatdecals.com)



**CLEVER**  
models LLC  
Cardstock models & materials

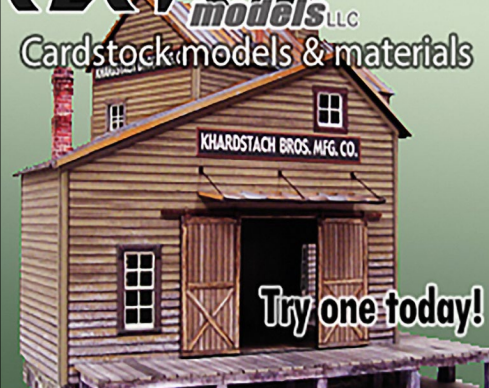

Try one today!

[www.clevermodels.net](http://www.clevermodels.net)

North Texas  
Council of  
Railroad Clubs



31st Annual Dallas Area Train Show  
January 16-17, 2016

Two full days of clinics,  
home layout tours, art,  
dealer tables, railroadi-  
ana, door prize draw-  
ings, a switching layout  
plus over 10 modular  
layouts on display rep-  
resenting G, O, S, HO  
and N scales as well as  
American Flyer, LGB,  
and Lionel.



Plano Centre, 2000 E. Spring Creek Pkwy., Plano, TX 75074

Saturday 10 a.m. to 5 p.m. and Sunday 10 a.m. to 4 p.m.

Admission \$8 per person (12 & under free with paid adult), Scouts in uniform FREE

**FREE PARKING!**



Find the Train Show Nearest You



Affordable built to order Benchwork  
starting at only \$20 a Sq Ft.



**MODEL RAILROAD**  
**BenchWork.com**  
 Affordable track planning  
 starting at \$250

**VectorCut.com**

— PRECISION —

**Laser Cut Details & Kits**

**Takoma Stores** Limited Production / Collaborative Kit  
 From Carolina Craftsman Kits & KC's Workshop

\$245.00

www.kcworkshop.com  
 www.carolinacraftsmankits.com

**CLICK HERE**

**CANYON CREEK SCENICS**

**Don't settle for lifeless signals!**  
**We've got signaling circuits!**

**LOGIC RAIL™ TECHNOLOGIES** "Sophisticated Model Railroad Electronics"

Please visit our website and online store!

21175 Tomball Pkwy Phone: (281)251-5813  
 Suite 287 <http://www.logicrailtech.com>  
 Houston, TX 77070 [info@logicrailtech.com](mailto:info@logicrailtech.com)

AMERICA'S NUMBER ONE RAILROAD PRINT SOURCE

**Jelsma Graphics**

*America's Railroad Embroiderer*

Railroad Art-Prints, Caps, Jackets, Shirts and More ...  
 Jackets starting at \$79.95

[www.jelsma.com](http://www.jelsma.com)  
 1-904-221-3513 • Jacksonville, FL.

**D hobby supply**  
 Your online source for:

**Quality DCC Equipment**

- Digitrax • TCS • NCE •
- QSI • SoundTraxx •
- Lenz • LokSound •

**Visit our website!**  
[dcchobbysupply.com](http://dcchobbysupply.com)

**Mr. Detail Parts**

**Bulk Packs Now Available**

**EXPLORE HERE**

Available Scales: HO - N - S - O - G - TT - 1:72

[www.mrdetailparts.com](http://www.mrdetailparts.com)

PRECISION DESIGN CO

Chains  
Flat Car loads  
Joint Bars  
Signs & Posts

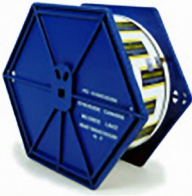

FREE SHIPPING



ATSP Bx-48

## Yarmouth Model Works

HO scale resin kits and detail parts



..... U.S.A. MAILING ADDRESS  
3560 Pine Grove Ave. Unit 617  
Port Huron, MI 48060

..... CANADIAN MAILING ADDRESS  
85 Hiawatha St.  
St. Thomas, ON N5P 2T5

Tel. 519-633-7574  
pierre.oliver@start.ca  
[www.yarmouthmodelworks.com](http://www.yarmouthmodelworks.com)

**MOUNTAIN SUBDIVISION HOBBIES**

[www.modelrrsupply.com](http://www.modelrrsupply.com)

FREE USA SHIPPING OVER \$29.00

NCE - SOUNDTRAXX - DIGITRAX - PECO - CIRCUITRON  
DCC SPECIALTIES - INTERMOUNTAIN - CMX - ATLAS  
BAR MILLS - BOWSER - KATO - MRC - TOMAR - RIX -  
PIKESTUFF - LOGICRAIL - CENTRAL VALLEY AND MORE!

## Your ad could be in this space for just \$58 a month.

Click to learn more ...

# HOBBY MARKETPLACE

ads are  
economical and  
effective.

Click [HERE](#) to learn more.

## Great Decals!™

FEC, Interstate, Virginian  
Railway, & L&N Titles  
After Hours Graphics Line  
Coupler Gages and More

In O, S, HO, and N Scales



## HO DIESEL SUPPLY

Are you serious about your HO Diesel fleet or just tinkering? Either way  
You probably bought just the right parts you needed from us already

**BACKSHOP HARD PARTS DIVISION**

Now Direct Personal Service

[www.hodieselsupply.com](http://www.hodieselsupply.com)

email: [TheBoss@hodieselsupply.com](mailto:TheBoss@hodieselsupply.com)

## RULERS-of-the-WORLD

Scale Rulers \$4 each  
Over 200+ scales!  
Metric or Imperial

[www.rulers-of-the-world.com](http://www.rulers-of-the-world.com)





• INDEX

• TABLE OF CONTENTS



*Joe Fugate's*

# **Siskiyou Line**

*Celebrates 25 years*

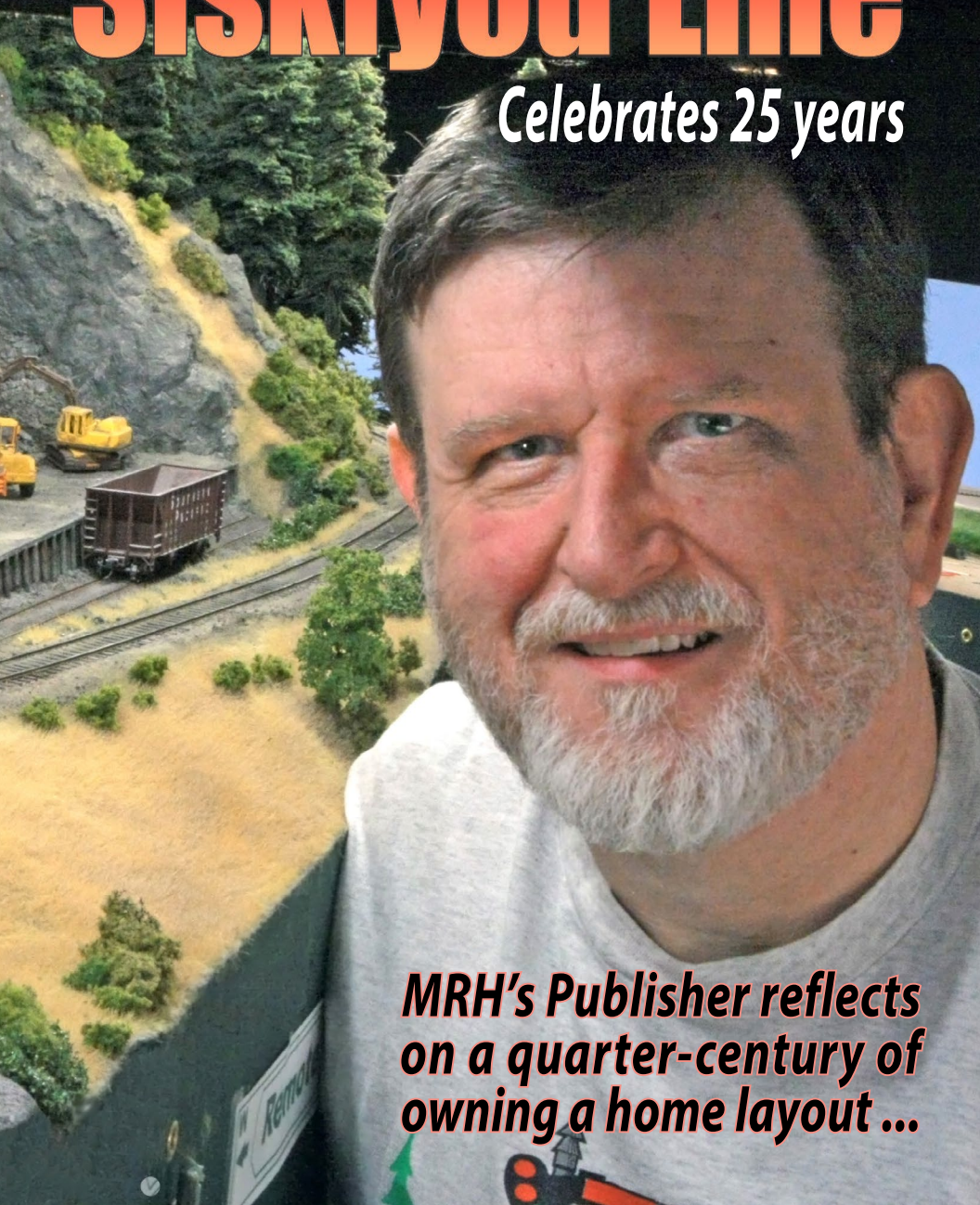

***MRH's Publisher reflects  
on a quarter-century of  
owning a home layout ...***

• INDEX

• TABLE OF CONTENTS

BY **JOE FUGATE**  
.....



[Click here for  
reader comments](#)

## I STARTED BUILDING MY HO SCALE SISKIYOU LINE

in 1991 and it's now 2016, so my Siskiyou Line is 25 years old this year. I think it's useful to look back at my layout through the years and see where it's at today.

This is my fourth layout. To put it all in context, I'd like to go back and briefly look at my journey in the hobby. Then, I will summarize how I designed and built my not-so-typical mushroom multi-deck layout configuration. Next I'll review how the layout looks today at 25 years old, and finally, I'll discuss what's ahead.

### Getting into the hobby

I got into the hobby in 1968 when I visited a hobby shop and bought my first copy of *Model Railroader* magazine, the June 1968 issue.

← [Previous page] 1. The newest finished scene on my Siskiyou Line layout is the gravel pit at Remote, Oregon, a tiny spot-in-the-road town high in the Oregon coast range between Roseburg and Coos Bay. On my freelanced Coos Bay branch, the rails run through Remote and there's a spur for the gravel pit that's actually in the real town of Remote. The railroad route was planned through this location by the prototype, but the route was changed when the SP built the Natron Cutoff out of Eugene in the late 1920s. So the rails never actually ran through Remote.

## SISKIYOU LINE AT 25 YEARS | 4

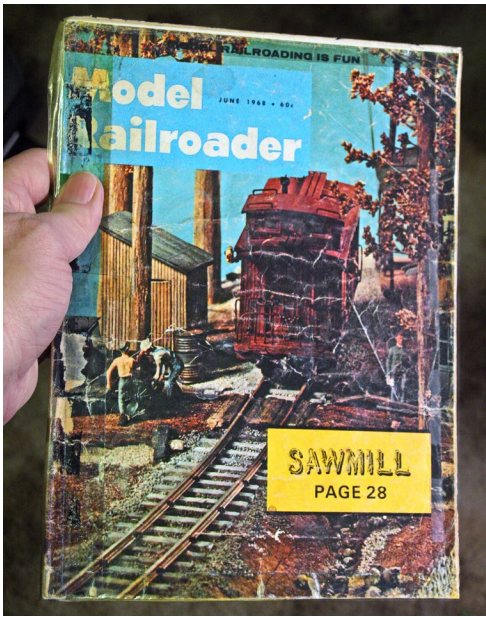

2. When I was 12, I wandered into a hobby shop and picked up my first copy of *Model Railroader*, the June 1968 issue. Sawmills were common where I lived in southern Oregon, so this issue grabbed my attention immediately. I also discovered HO scale, and became hooked on model railroading in HO.

I had some three-rail tinplate trains gathering dust, but once I discovered HO and the fine RP25 flanges on the wheels, I was hooked. Shortly after this, I joined a local model railroading club that displayed at the county fair every year, and I purchased a Tyco steam loco kit and some freight cars.

I was in high school at this time. The club, along with reading *Model Railroader* and *Railroad Model Craftsman* magazines, kept me intensely interested in the hobby. The janitor at my high school was also a model railroader and we became friends, swapping tales about our hobby projects.

As a kid, my friendship with janitor Tom was one of my first real peer-to-peer friendships with an adult, and it opened my eyes to relating to adults as equals instead of just authority figures. I have many fond memories of my hobby conversations with Tom the janitor. We shared a passion for model railroading and that was special.



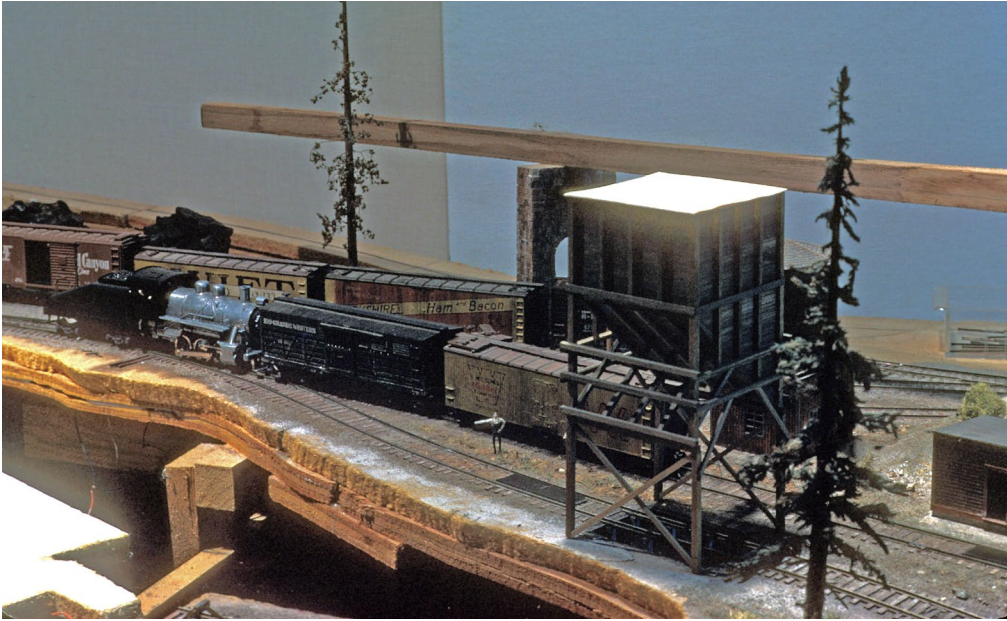

3. My second layout, the Morale Falls & Sadgino (pronounced sad'-jya-no), was a freelanced steam era layout inspired by John Allen's Gorre & Daphetid. This small small bedroom shelf layout occupied one wall in my bedroom while I was growing up and attending college. Once I got married, I sold the layout to a fellow model railroader.

I built a small layout in a spare room using bits of scrap lumber, and I did some handlaying using code 100 brass rail on wood ties with Railcraft spikes. This layout never really went very far, but I consider it my layout number one.

As I courted Patty Bell (destined to become my wife), I felt it important to find a girl who understood my passion for model railroading if she was to become my lifelong companion.

Patty was into crafts herself and she thought it was neat that I also had a "craft" pursuit. She genuinely wanted to learn more

about the hobby, so she would go with me when I would visit a layout, and she always had lots of questions.

### The pure freelance years

As I read the hobby magazines, I became a fan of John Allen's amazing Gorre & Daphetid, and wanted to do a freelance layout of my own. By this time I was entering college and pursuing a career in computers.

I came up with a name for my railroad, the Morale Falls & Sadgino (pronounced Sad'-jya-no). Of course, it was cutesy, after the spirit of the Gorre & Daphetid.

I built a small L-shaped shelf layout in my bedroom. I hand-laid some turnouts and I built a working turntable. This is my layout number two and was my off-and-on project all through my college years. Once Patty and I got married, I sold this layout to a friend.

By the late 1970s, John Allen had passed away and his G&D had faded from the hobby scene. Meanwhile, Allen McClelland started writing about his proto-freelance concepts and he talked about making a layout a part of the larger rail system in the nation using staging.

I started noodling on how I could build something more along these lines, since I had sold my freelanced MF&S layout.

### Moving to proto-freelance

Growing up in the Pacific Northwest gave me a love for mountain railroading. I won a book on the Great Northern at a meet. What if, I thought, the northern U.S. only had one railroad running through it instead of two, the Great Northern and the Northern Pacific? And what if it was simply called the Northern Railway?

## SISKIYOU LINE AT 25 YEARS | 7



4. My third layout, the Northern Railway, was a proto-free-lanced design based on an amalgamation of the Great Northern and the Northern Pacific, and ran through the northern U.S. states from Chicago to the Puget Sound area. This layout was another shelf layout and occupied one wall in our garage.

My Northern Railway could use the best of either the Great Northern or the Northern Pacific. I borrowed the highly stylized Rocky the Goat GN logo from the 1960s for my Northern Railway logo, and I borrowed NP's slogan and called my railroad the "Main Street of the North." This allowed me to do a lot with existing decals and not need custom decals, although I did get some custom decals printed up later.

I started another shelf layout that I hoped could eventually be incorporated into a larger layout. I wanted to model the Tacoma area with its ocean port, ferries, and the like, along with the grade over the Cascades. I also toyed with the idea of electrifying the grade, just like the Great Northern and later the Milwaukee Road. This became my layout number three.



## SISKIYOU LINE AT 25 YEARS | 8

5. In the 1980s, I started drawing a lot of hypothetical layout plans and exploring various track planning ideas. During one of my track planning sessions, I realized I could add a Southern Pacific interchange to my Northern Railway if I used a bit of modeler's license. That's when it dawned on me: If I was so determined to get the SP on my hypothetical plans for my proto-freelanced Northern Railway, why didn't I just model the SP instead?



6. The SP in Oregon book by Ed Austin and Tom Dill, published in 1987, helped rekindle my childhood fascination with the Southern Pacific and it taught me the detailed history of the Siskiyou Line, which ran right past my childhood home near Roseburg, Oregon. This book, along with discovering the Layout Design Special Interest Group in the late 1980s, helped put me on the course of the dream layout that eventually became my Siskiyou Line.

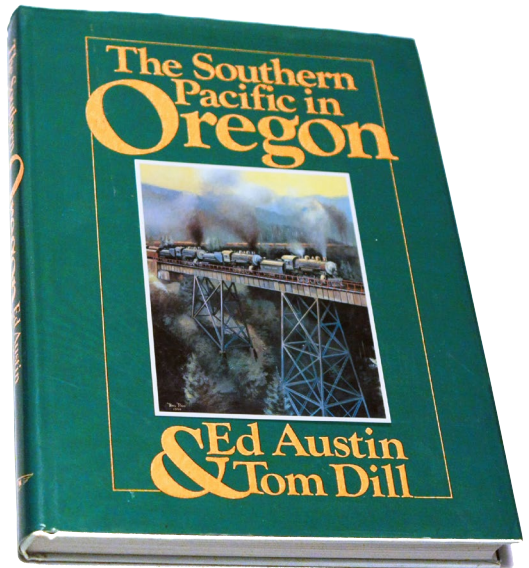

## The Layout Design SIG

By this time, it was the mid-80s and I had learned of an NMRA National Convention coming to Eugene, Oregon, very near where I grew up. I was living in Boise, Idaho, but my parents still lived in southern Oregon about 50 miles from Eugene so I could stay with them and attend the convention.

At the convention I met Doug Gurin and joined the Layout Design Special Interest Group. I also discovered Tom Dill and Ed Austin's new book, *The Southern Pacific in Oregon*. Having grown up next to the SP, I just had to get a copy of this book!

I had started drawing plans for a hypothetical home layout, aiming at 500-600 square foot rooms of different configurations. I drew these plans for my Northern Railway, with the main yard in Tacoma, WA and a long grade over the Cascades to eastern Washington and into staging.

After struggling to get a long grade into 500-600 square feet, I considered multi-decking the space. But I never have liked the visual clutter of multi-deck designs. I had seen some multi-deck layouts by this time, and I didn't really like the look.

What if I flopped the upper deck around in the middle of the room and put a raised floor on that side, to keep the relative height from the floor roughly the same? Without knowing it, I had invented what famed track planner John Armstrong would later dub the mushroom.

The Layout Design SIG (LDSIG) publications, especially the amazing Yards issue, helped me refine my hypothetical layout designs into something that had good reasons for every track on the plan. I can't recommend the LDSIG too highly for the great layout design insights they offer. Make sure you check them out online at [ldsig.org](http://ldsig.org). Get as many back issues of their publications as you can, and become a member.

*“I was thrilled to add an interchange with the SP on my proto-freelanced Northern Railway layout. Then it hit me: If I loved the SP so much, why wasn’t I modeling it?”*

While working on one of my hypothetical layout plans one day, the idea hit me to include an interchange with the Southern Pacific in Tacoma, WA. The SP never ventured that far, but what if the SP had decided to go north of Portland, OR and push into the Puget Sound area? This is proto-freelance after all, and how about scratching the freelance itch a little by bringing my beloved SP onto my layout?

I was thrilled with the idea of an interchange with the SP on my proto-freelanced Northern Railway layout. Then it hit me: If I loved the SP so much, why wasn’t I modeling it?

About this time, the LDSIG published a commentary about how to get the most satisfying layout design. The key, this commentary said, is to model what got you interested in trains in the first place because this goes to the root of your passion for the hobby.

The LDSIG article said to go back to your roots, and for me, my roots were growing up next to the SP Siskiyou Line.

That clinched it for me. Modeling the SP Siskiyou Line it would be!





7. I selected the northern, more industrial end of the Siskiyou Line to model because I wanted more interesting operation. The southern end has dramatic scenery, with its steeper mountain grades sporting numerous tunnels and bridges, but the lack of industry makes that end of the line less of an operational challenge. To add interest to my layout, I rerouted the Coos Bay branch to connect with Roseburg instead of Eugene, since Roseburg would be the layout's main yard.

## Designing my SP Siskiyou Line layout

By this time it was 1989. I continued drawing hypothetical layout designs, except now I was designing track plans for an SP Siskiyou Line layout.

I learned from Austin and Dill's SP in Oregon that the Siskiyou Line had been the original mainline out of California through southern Oregon, but with the construction of the Natron Cutoff in the late 1920s, the Siskiyou Line had become a secondary line.

Because the SP routinely ran several 100-car heavy lumber trains per day up the Siskiyou Line – pulled by a half dozen or more diesels and often with mid-train helpers -- I thought it was the SP mainline when I was a kid. Because this line had once been the mainline, it is essentially a branch line built and maintained to mainline standards because of all the heavy lumber traffic.

And, because the Siskiyou Line had become a branch, when the SP moved to CTC and searchlight signals in the 1950s the lower quadrant semaphore signals on the Siskiyou Line were never replaced. This gave the SP Siskiyou Line a distinct character, of rails through rugged terrain covered with Douglas fir, and operational lower quadrant semaphores! Capturing this look became a high priority for me, because it shouted Siskiyou Line like nothing else could!

While the southern end of the Siskiyou Line is the most spectacular scenically, with the Wolf Creek loop and trestle, and many tunnels and steep grades, there's not much industry. I preferred to model more of the northern end of the line, from Roseburg north.

Just south of Roseburg in Dillard is the huge Roseburg Forest Products complex, which by itself originated hundreds of

## SISKIYOU LINE AT 25 YEARS | 13

.....

loads per week. I just had to have that mill on my layout. But anything south of Dillard could be staging.

It might have been nice to push the layout farther south to Riddle, which hosts another smaller lumber mill and is the location of the Hanna Nickel mine, one of the only nickel mines that operated in North America. Unfortunately, that was just a bit too much layout to fit into my plans, so it moved to staging.

Remember my fascination with modeling rails and an ocean port? The SP in Oregon includes the Coos Bay branch that runs from Eugene to the Oregon coast at Florence, OR and then follows the coastline to Coos Bay. Coos Bay is the largest deep water ocean port on the Pacific Ocean between San Francisco and Seattle, which is not insignificant.

To scratch my freelance itch, could I run the Coos Bay branch out of Roseburg instead of Eugene? That's not much of a stretch. The Coos Bay rail line actually started in Coos Bay in the late 1800s, laying rails east out of Coos Bay for a line called the Coos Bay, Roseburg, and Eastern!

I just assumed they didn't run out of money, and actually managed to get most of the way to Roseburg by the time the SP got involved in the early 1900s. The SP finished the line to Roseburg before they built the Natron cutoff in the late 1920s.

### Doing the multi-deck track plan

In 1991, we moved from Boise, ID to Portland, OR to be closer to my aging parents. Patty also loved Oregon and all the green, so she fully supported the idea of moving into forested heaven, as she called it.

Patty also insisted (bless her heart) that we find a house with a nice basement for a layout. My goal of finding a lifelong partner with an appreciation for my hobby was paying off.

## Siskiyou Line - cutaway view (A-A)

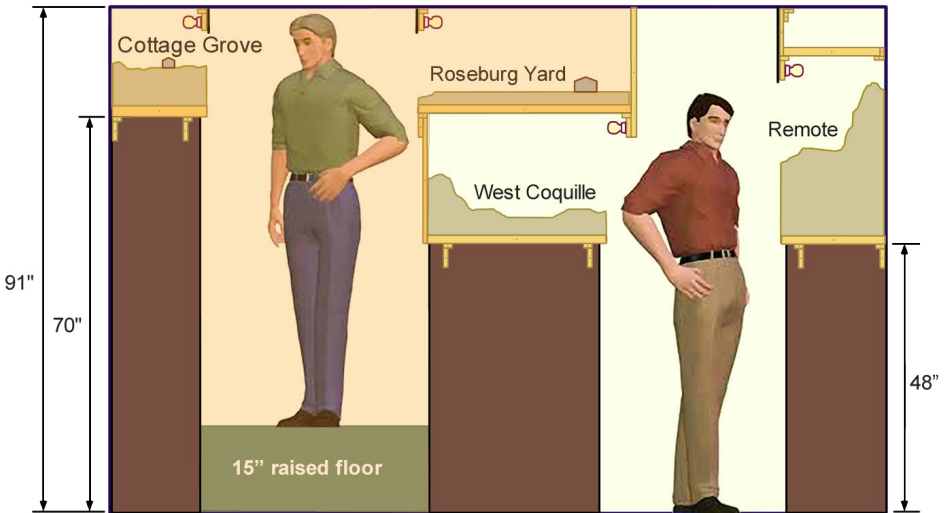

8. Here's a cutaway diagram of my layout at the area marked A-A on the track plan [9, 10]. Notice the side with a raised floor has been shaded orange and looks a bit like a lopsided T. To use John Armstrong's terminology, it's shaped like a "mushroom." Mushroom has become the official name for this kind of overlapped multi-deck layout configuration.

By February of 1991, we moved into our existing house and I started planning the track plan to fit into the basement space. Because I had already invested so much time into exploring my options with hypothetical track plans, it didn't take long to arrive at a final track plan.

Because I had never built a mushroom layout configuration before, I was apprehensive. Would it work?

I did a lot of mock-ups while designing the layout, to determine what was going to work. I used boxes, books, sheets of cardboard, and some track, along with locos and rolling stock.



# SISKIYOU LINE AT 25 YEARS | 15

9. Siskiyou Line lower deck track plan representing the Coos Bay branch. Cross-section A-A [8] shows how the mushroom configuration fits both the lower deck and the upper deck [10] into this 810 square-foot space. Notice the space is shaped roughly like an hour-glass, with the middle being the most narrow part of the room.

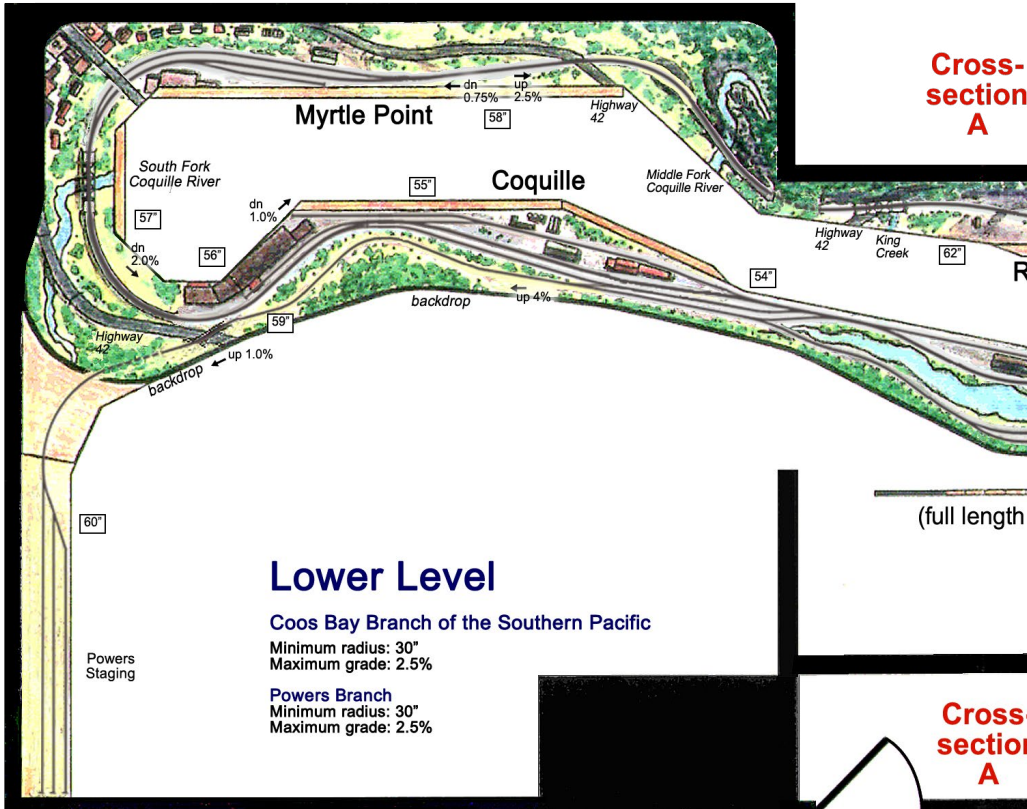

By doing mock-ups, I got a pretty good idea of these important dimensions:

- Base benchwork height from the floor
- Separation between the upper and lower deck
- Layout shelf width (how small could it be)
- Aisle width (how small could it be)
- Mushroom raised floor height

# SISKIYOU LINE AT 25 YEARS | 16

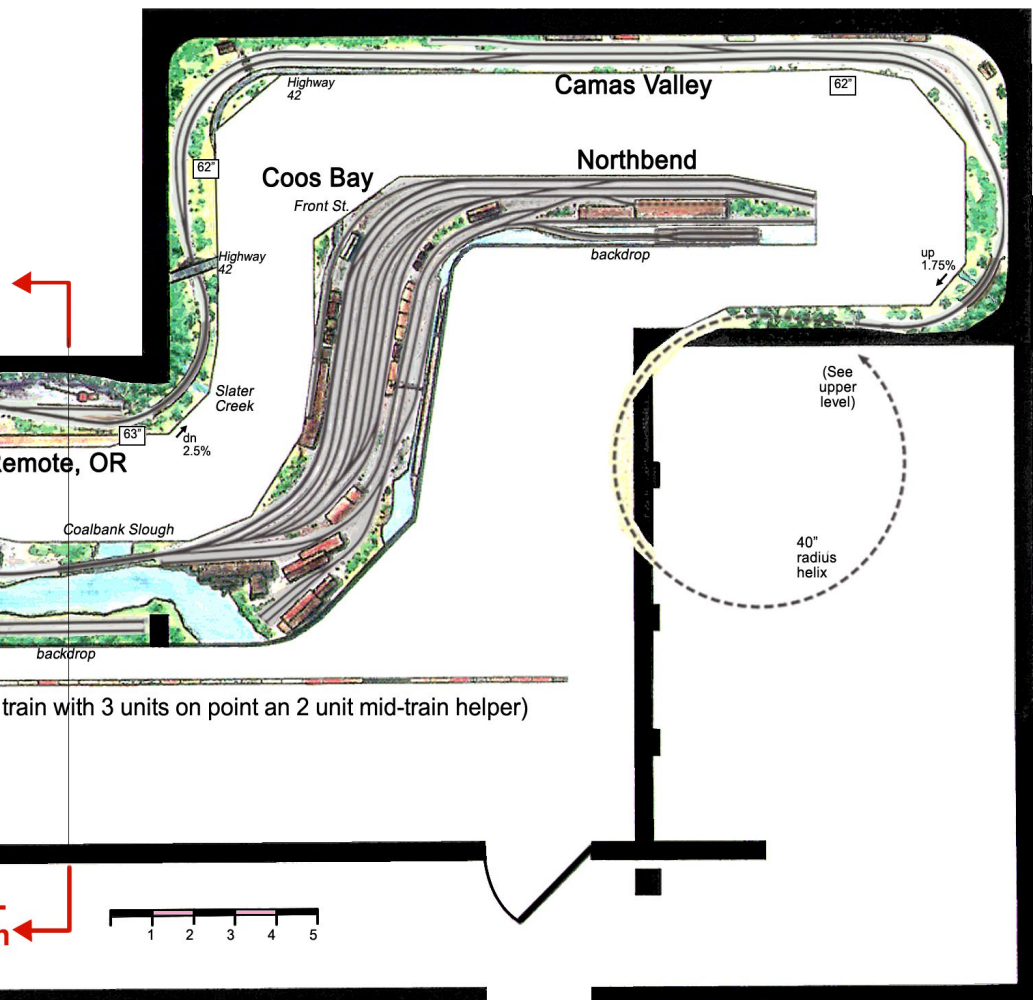

From the LDSIG publications, I learned most modelers felt they had built their layouts too low. Most would rebuild their layout at least six inches higher. From my mock-ups, I decided 54 inches was the perfect base level for me. This is 48 inches (four feet) plus six inches.

At this height, I get a good from-the-side view of the cars, yet can still see enough to tell what's on the rear tracks in a yard.

# SISKIYOU LINE AT 25 YEARS | 17

10. Siskiyou Line upper deck track plan representing the Siskiyou Line main. From Eugene staging to Medford staging is a mainline run of about 360 feet. To visualize how the upper deck fits into the room over the lower deck [9], see cross-section A-A [8].

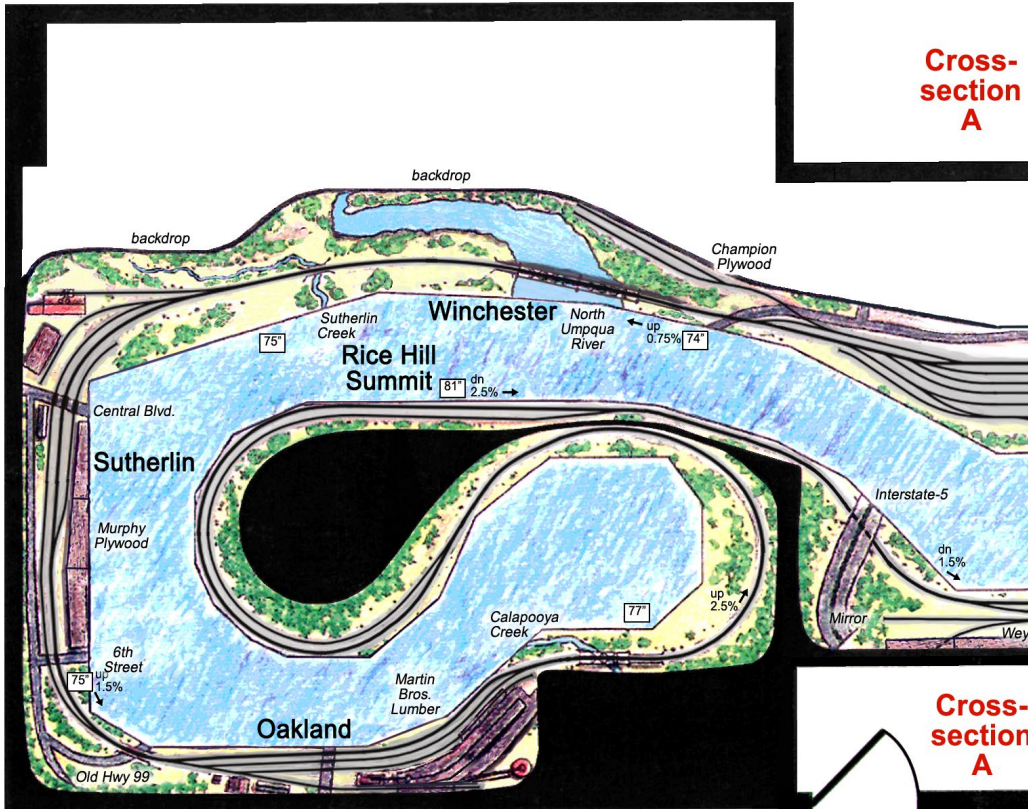

As for the other dimensions, I found 13 inches of deck separation worked great. (Note: This 13 inches is to the bottom edge of the upper deck, which is generally at least six inches thick.) The 13-inch deck separation works great because 67 inches (54+13) is the distance from the floor to the tip of my nose, allowing me to still view most of the lower deck if I step back a bit from the layout fascia.



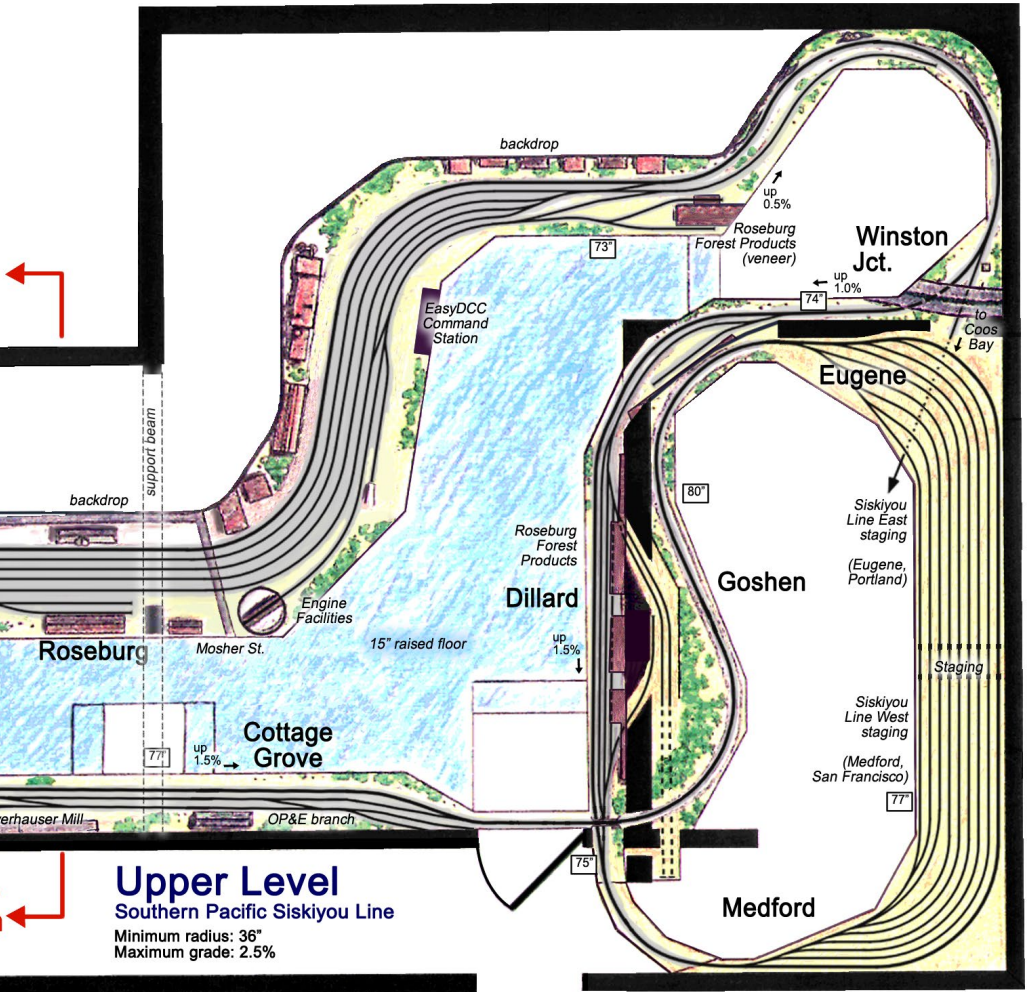

**Upper Level**  
Southern Pacific Siskiyou Line  
Minimum radius: 36"  
Maximum grade: 2.5%

From the LDSIG publications, I also learned about high narrow benchwork shelf and its advantages. With high narrow benchwork, you can get:

- A more realistic “railfan” view of the trains
- Less scenery to build
- More railroad in a given space
- More generous aisles





Playback problems? [Click here ...](#)

11. Video 3D fly-around to illustrate how I built the mushroom-configuration benchwork for my Siskiyou Line. The guy in the red shirt is my height so you can see how the dimensions work for me. This sample benchwork is 24 inches wide and uses a partial 15-inch raised floor in a room with a 91-inch ceiling height.

- Scenery behind the track can be compressed yet not look compressed
- It's easier to get under the benchwork to do wiring and maintenance

My mock-ups showed even a 12-inch deep shelf to be plenty wide in many cases for the layout. Now that I've had 25 years to experience my Siskiyou Line layout, I have to say the narrow shelf benchwork has worked out very well. If I had it to



12. By testing with mock-ups first, I determined the best height for the bottom back edge of my upper deck benchwork was at the end of my nose, which comes to 67 inches from the floor. This allowed me to see the lower deck all the way to the backdrop just fine, but kept the lighting out of sight. With the lower deck at 54 inches from the floor, this gave me a deck separation of 13 inches.

do over again, I would make some of my wider areas narrower as well. I'd rather give that space to the aisles than to a wider layout shelf.

The narrowest part of my layout aisle has a short 21-inch-wide pinch point. This isn't much of a problem, but it does require single-threading through that part of the layout near Tunnel 2 on the lower deck.

I found that aisles at least three feet wide feel the most comfortable for an operating railroad – that is, one where you expect to have regular prototypically-based operating sessions.

13. In my mock-up testing, I found three-foot aisles to be ideal. While I wasn't able to maintain this aisle width everywhere, I used it as my preferred aisle width when I could. The back of the upper deck on the top left has since been covered over with charcoal-painted hardboard to match the lighting valance on the right and give the layout a more finished look.



## Building and operating the Siskiyou Line

I had lots of help building my Siskiyou Line benchwork. I owe a lot of the actual execution of my benchwork design to my friend Al Ketchum.

Benchwork goes in fast – we filled my layout room with benchwork in a few months of working one Saturday per month. Along the way we discovered the greatest bane of my design, what I call my “helix from hell.” See [14] and [15] for the details.

I drove the golden spike on my layout in 1997 at the west end of Dillard. Shortly after that, I started hosting regular operating sessions. By this time, DCC was well established, so I have always used nothing but DCC on the layout, which made wiring a lot easier than resorting to cab control.





14. Here's the carpentry master-mind behind my mushroom benchwork, Al Ketchum (on the left). Al took my concepts and made them into something you could actually build, so I owe a lot to Al for his carpentry genius on the Siskiyou Line benchwork.







15. Here's an old black-and-white photo of my 24" radius "helix from hell." This sits behind the town of Camas Valley on my lower deck – on the lower right is Coos Bay / Northbend . Running up such a tight radius helix would stall trains. At the insistence of my operating crew, we ripped this helix out and replaced it with a 40-inch radius version in my workshop instead.

It's fun to see how far the layout has come since those early days of construction. In photos [17] through [25], I've collected some interesting then-and-now shots of my layout. I took the older photos with an early digital camera, so the quality isn't always the best.

For the "now shots," I just went into the layout room and tried to duplicate the camera angle to get a direct comparison.

## The Siskiyou Line at 25 years

Reflecting back over the 25 years that my HO Siskiyou Line has been in existence, I have to say I'm quite satisfied with the layout. I feel a lot of that comes from joining the Layout



16. Here's the 40-inch radius helix in my workshop that replaced the 24-inch radius helix. This much larger helix with a 1.75 percent grade operates far better than the other helix – the difference is like night and day. The cardboard along the outside protects derailing equipment from heading toward the floor, although derailments in the helix have been quite rare.

Design SIG and absorbing their layout design insights and applying them to my layout design. Getting a satisfying track plan and a layout theme that works well has contributed a lot to my hobby satisfaction.

The hobby has progressed a long way since I started the Siskiyou Line back in 1991. For example, the current Fast Tracks and Proto:87 Stores track products were not available then. Today, I'd do all my turnouts using my poor man's jig system as described in the [September 2011 issue of MRH](#), instead of using commercial turnouts. More about that later.

Also, if I were starting over, I'd build my layout using TOMA (The One "Module" Approach) [Text continues on page 33](#) →



17, 18. Here's the North Umpqua River scene before and after. This scene, just railroad east of Roseburg yard, is one of the signature scenes on my layout and those who know the area immediately recognize it. This two-span truss bridge took over a year at a few hours per week to kitbash from three Central Valley bridge kits. There's also easily 500 trees in this scene – if there's one thing that's true about modeling western Oregon scenery, you need a lot of trees!







[Click here for reader comments](#)

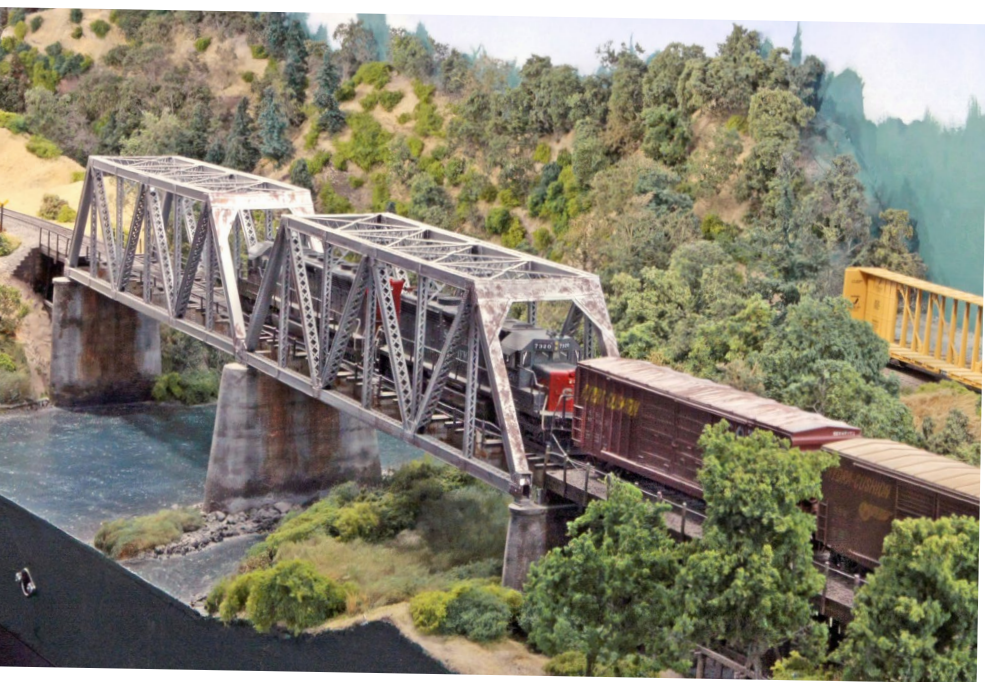





19, 20. Here's Slater Creek trestle on the Coos Bay branch before and after. The finished version of this scene was on the cover of the January 1997 *Model Railroader*. I scratch-built this curved truss bridge out of styrene (the center truss is a MicroEngineering 30 foot deck girder, however). Because I used styrene to build this trestle, it's nearly indestructible. When I have guest operators visit the layout, I notice a lot of cell phone camera shots get taken here when they're running the Coos Bay Hauler!



[Click here for reader comments](#)





21, 22. Here is Roseburg yard, then and now. Adding the full lighting and painting a nice backdrop helps give the layout a more finished look even if the scenery isn't complete. I still have some scenery work to do here, as well as several structures to build, but the yard is near 100% functional for operating sessions and that takes precedence for me. I've found once you get an operational railroad, the ops can get so fun that adding more details takes a back seat. But if you're having fun, is that so bad?



# SISKIYOU LINE AT 25 YEARS | 30



[Click here for reader comments](#)







23, 24. These views from the east end of Roseburg yard show then and now. I really like how the mushroom benchwork configuration allows for long uncluttered vistas along the railroad even though it's a multi-deck design. As the middle peninsula of my layout, there's actually another deck below this one, but you would never know it! Roseburg yard still needs some scenery and structures plus a few more backdrop details. But again, the fascia, valance, and backdrop help give the layout a finished appearance even if the scenery detailing is not yet complete.



[Click here for  
reader comments](#)





25. This panoramic view shows Tenmile Creek trestle on the Coos Bay branch. As the train rolls to the far right just past the conifer it will enter Camas Mountain tunnel 2, which is actually the bottom half of the helix between the lower deck and the upper deck. About halfway up the helix, the train pops out of tunnel 2 into a short shadow box scene and then enters tunnel 1, to go one more trip around the helix before it comes out at Winston Junction on the upper deck. I documented the entire process of building this scene from bare benchwork to the finished scene [here in my Tenmile Creek scenery step-by-step videos](#). Zoom into this photo to study the details. It's 300 DPI, so it should hold up well to 200-300% zooming.

since that would allow me to build the layout bit by bit and still operate it all along the way. In fact, my staging area could use an upgrade and I'm giving serious thought to using TOMA to replace it and build the sections at my workbench. Imagine the ease of being able to flip the ladder section over and wire the Tortoises / turnout servos without craning my neck!

To celebrate the 25 year anniversary, here are some all-new photos of my favorite finished scenes on the layout at the current time. [Text continues on page 39](#) →





26. It's just not the SP Siskiyou Line without lower quadrant semaphores. While the semaphore signals don't operate yet, most of them are now installed on the layout. It's really starting to look like the SP Siskiyou Line, as this shot of Rice Hill siding's west end demonstrates!



# SISKIYOU LINE AT 25 YEARS | 35





↖ 27. [Upper left] Speaking of semaphores, here is the east end of the same Rice Hill siding, with the trademark lower quadrant semaphores looming in the distance. Getting all the semaphores in place is the first step – the next step will be to get all these semaphores *operational*.

↙ 28. [Lower left] The latest new scene on the layout is this gravel pit at Remote on the Coos Bay branch. This scene has been semi-complete for years, but I had never finished the gravel pit area, the grade crossing, office parking lot area, or completed the vegetation here. With this scene finished, almost 40% of the Coos Bay branch's scenery is now done.

↑ 29. [Top right] I really like this close-up of GP40 TEBU mother 7966 rolling through the Remote gravel pit scene. The contrast of the massive locomotive to the smaller dump truck on the right feels like I'm really railroading. This, by the way, is my eye level view. Getting the track level up between elbow-to-shoulder height does so much to increase the enjoyment of running trains – another recommendation I got from the Layout Design SIG publications.



# SISKIYOU LINE AT 25 YEARS | 37







↖ 30. [Upper left] Few scenes say “Oregon SP coast branch railroad-ing” like this curved trestle over Slater Creek. While I freelanced this area (since there’s no railroad that crosses the real Slater Creek near Camas Valley), I used typical SP coast branch scenery as my guide for modeling this scene on my freelanced Coos Bay branch.

↙ 31. [Lower left] This high steel trestle scene is the first bridge completed and it crosses the Middle Fork of the Coquille River on my Coos Bay branch. As the first finished scenery on the layout, this bridge scene has been photographed from many angles, and it still gets a lot of visitors congregating around it during layout visits.

↑ 32. [Top right] Here SD40T-2 snoot tunnel motor 8306 exits Roseburg yard limits heading east on the point of a heavy lumber train. Ralph Renzetti weathered this new Athearn tunnel motor especially for the Siskiyou 25th anniversary celebration (thank you, Ralph). This loco has a TCS WOWsound decoder in it and a full working SP light set. SP 8306 runs every bit as realistically as it looks!



33. Roughly half the scenery on my Siskiyou Line is still brown plaster as seen here at Sutherlin Creek. I hope to make significant progress on the layout scenery by adding more grass, bushes, and trees – a process that goes fairly fast, actually. After that comes more time-consuming details like more structures.

## What's next?

Now that the Siskiyou Line has crossed the 25-year mark, what's next for the layout?

I want to get all the lower-quadrant semaphores installed and working. I'm planning to use TAM Valley servos and boards to drive the signal heads, and I will need to settle on some detection circuitry to manage the signal logic. I haven't decided just which signal logic circuitry I will use – I'm still doing my research.

I also want to upgrade my staging yard. I built the original staging yard in place and I have struggled with reach issues

Make it run like a

# Dream

*By Joe Fugate*

EBOOK SERIES:

First time these methods all collected in one place

**PREORDER  
SPECIAL**

**\$12.99**

**\$12.99**

**\$12.99**

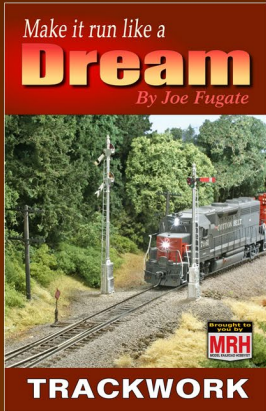

Est release: Jul 2016

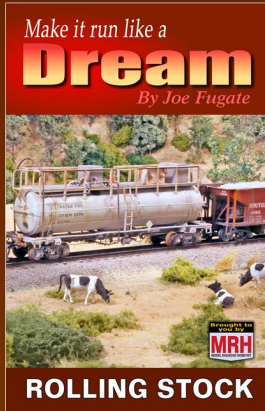

Est release: Jan 2017

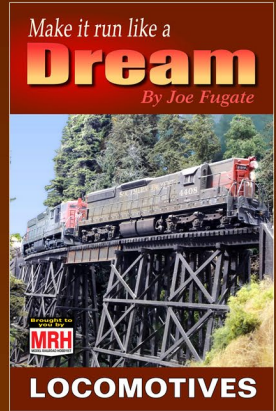

Est release: Jun 2017

*Pre-order customers get regular sneak peeks at chapters as they're finished, and get exclusive access to video shorts ...*

~~**\$38.97**~~

**\$29.99**

eBook ... hardcopy books  
pre-order coming soon

**PRE-ORDER EBOOKS TODAY >>**



**store.mrhmag.com**



and with minimal overhead clearance under furnace duct work, so the yard trackage has more derailment issues than I would like. As I've said earlier, I'd like to use TOMA (The One "Module" Approach) to build the replacement staging yard in sections at the workbench. Just thinking about being able to flip a module section over to install the turnout motors/servos is enough to get me excited about the much better job I could do on a rebuild like this.

Then there's finishing up the scenery with grass, bushes, and trees. Roughly half the layout scenery is still just brown plaster [32]. A couple of small areas are still bare benchwork, but they are less than five percent of the layout. I need to build more structures, but that will take a lot more time than adding the vegetation.

Adding vegetation makes a scene look finished even if there aren't many structures in the scene yet, so that's relatively quick to do in comparison to modeling structures. I'm expecting many years yet of structure building.

I'm also tweaking my layout fleet to run better, both the locos and the rolling stock. I'm calling this my "run like a dream" standard, and I will be writing about that in an upcoming book series, *Make it Run Like a Dream*. This book series will cover all my years of learning what it takes to make things run as well as possible and it will have three volumes: Trackwork, Rolling Stock, and Locomotives.

I'm expecting to also throw in some extra videos illustrating the most important points for those who pre-order this *Make it Run Like a Dream* book series (either as eBooks or hard copy books). I'm expecting roughly one volume every six months, so the entire series will take 18 months or so to complete. Those who pre-order will get advanced sneak peeks at chapters as I produce them.

# SISKIYOU LINE 2016 Calendar



Wallpaper  
photo downloads  
included!

Made especially for model railroaders by MRH

Joe Fugate's Siskiyou Line



Major model RR  
event dates  
included!

Wall calendars:  
Open to 11" x 17"

2016

MARCH

Two G40 members and a TBH (inactive after border exit) slug cross King Creek and Highway 42 on the way up the Crows Bay branch to Cannon Valley with the Header in line.

Sunday	Monday	Tuesday	Wednesday	Thursday	Friday	Saturday
1 2 3 4 5 6 7 8 9 10 11 12 13 14 15 16 17 18 19 20 21 22 23 24 25 26 27 28 29		1	2	3	4	5
6	7	8	9	10	11 Edison, NJ Hickory Grove Mar 11-13	12 Atlanta, GA Mud Run Mar 12-13 Columbus, SC Mud Run

13

13 (Holiday)

Spring Ho

20

27

27 (Holiday)

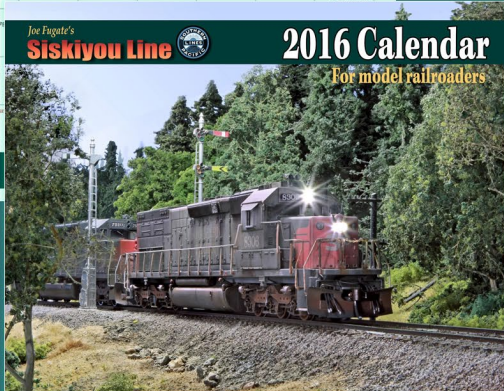

~~\$18.88~~

\$16.99  
+ S&H

GET YOUR CALENDAR TODAY >>

[store.mrhmag.com](http://store.mrhmag.com)

## SISKIYOU LINE AT 25 YEARS | 41

Finally, I would like to update my Siskiyou Line video series with new videos, especially the DCC volume. There have been a lot of developments in the hobby since the video series was produced about 10 years ago.

As part of updating the Siskiyou Line video series, I'd like to show the one remaining bare benchwork area (the bridge scene between Myrtle Point and Coquille) by doing another Tenmile Creek style step-by-step of the entire process. I would show a number of new techniques I'm using, build a steel through-truss bridge and model the water in this scene using a different technique.

As I continue working on the layout, I'll also share the progress on my MRH Blog and through the pages of MRH. Here's to many more years of Siskiyou Line layout development still to come!



***Watch for the 2015 NMRA Siskiyou Line layout tour video coming to TrainMasters TV this month!***

For more information on the prototype SP Siskiyou Line, visit these links ...

Siskiyou Line prototype photos:

[pnwr.qstation.org/USA\\_Railfanning/SP\\_Siskiyou/index.html](http://pnwr.qstation.org/USA_Railfanning/SP_Siskiyou/index.html)

Siskiyou Line prototype YouTube video:

[youtube.com/watch?v=hSdE0Ylq\\_n4](http://youtube.com/watch?v=hSdE0Ylq_n4)



**Click here for  
reader comments**



# TRAINMASTERS.TV

## *Siskiyou Line layout tour & op session*



*... at the 2015  
NMRA National*



## Coming in January!

Non-members can watch for  
only \$1.49 per segment

**Visit the TrainMasters TV website**



# “Yes, it’s a model” 2016 Calendars



Wallpaper  
photo downloads  
included!

Made especially for model railroaders by MRH

Major model RR event dates included!

Wall calendars: Open to 11" x 17"

## The Weathering Shop



**2016 JUNE**

Morning storm in SoCal at Southern California's Cabot Corporation in port town of Brea. Cabot's crew with it's intermodal train in town.

Sunday	Monday	Tuesday	Wednesday	Thursday	Friday	Saturday
1	2	3	4	5	6	7

## The Best of Jürg Ruedi



**2016 MARCH**

St. Lawrence & Madison 2142-2 #5488 leads a 10-car mixed freight train over the New Bridge near Buffalo, Oregon. Prof. W. R. (aka. Steve) Stiles photo.

Sunday	Monday	Tuesday	Wednesday	Thursday	Friday	Saturday
1	2	3	4	5	6	7

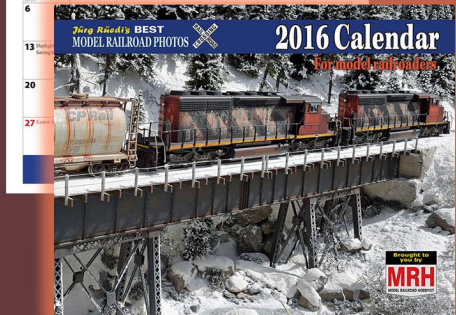
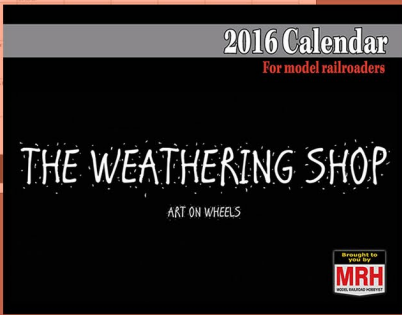

~~\$18.88~~ \$16.99 + S&H

GET YOUR CALENDAR TODAY >>

[store.mrhmag.com](http://store.mrhmag.com)



# YES, IT'S A MODEL

compiled by  
**DON HANLEY**  
.....

 [Click here for reader comments](#)



1. Bill Michaels shared these photos of his Deer Creek Mine model from Sierra West Scale Models. He used unsanded grout between the rails, with some dark brown chalk added to the grout to make it a little darker. Black chalk was blended down the center of the track with mineral spirits to simulate oil and grease drippings. Here at *MRH*, we say "great modeling, Bill."



▶ **MRH'S MONTHLY PHOTO ALBUM**



## YES, IT'S A MODEL | 2



2. Joe Atkinson shared this photo of UP 503 that he took on his layout. Joe shared his work in a post [mrhmag.com/node/24092](https://mrhmag.com/node/24092).

He added details, removed the factory lettering and relettered and renumbered the model. Joe faded the unit and weathered the trucks, fuel tank, pilots, and plow with Pan Pastels, but he faded the lettering and shields with yellow, gray, and white acrylics. After comparing the model to the prototype, it's safe to say "Joe, you nailed it".





3. Two Boston & Maine boxcars sit on a siding as a winter storm approaches. Mike Cawdrey posted this photo in the weekly photo fun. Mike lives in Queensland, Australia and models winter in New England. The Athearn boxcars represent Guilford paint schemes from 1984. Mike weathered one of the cars with oil paints using raw umber mixed with a little titanium white and thinned with some turpentine. The trucks are weathered in the same manner, with a little dab of red and blue added to the same mix. Mike posed the weathered and unweathered cars to check his results.





4. It is a late fall afternoon as Canadian National 6103 hauls boxcars through central Ontario. The SD40-2 was purchased by CN from the Union Pacific in the mid '90s and hasn't received its new coat of paint yet. Steve Juranics modified the SD40-2,





a Broadway Limited model. The Maple Leaf Trading company diorama was kitbashed from Downtown Deco kits. To see more, go to Steve's blog post [mrhmag.com/node/23608](http://mrhmag.com/node/23608).



5. It is summer and a BNSF coal train is on the east side of Bozeman Pass just outside of Livingston, MT. Zak Gardner took a photo of the prototype which was the inspiration. He weathered the models with a dark paint base wash, following with a brown mixture that he airbrushed on to replicate the dirt and fading of well-used units. Finally, he added soot and grime with standard art chalk powders.

The models are on a 2' x 4' modular layout section made to represent the Montana landscape. The backdrop is a piece of Masonite that has been painted, with the mountains cut from a photo he printed on his home printer. It's fair to say that Zak captured Montana's "Big Sky Country."



6. Mark Simpson posted "Water Train in Action." Expecting to see a video or models of a water train, we were treated to this lighthearted photo. As Mark said, "This train doesn't run very quickly but does a good job of holding the track in place while the glue dries." One forum member replied, "You got me LOL-Good one"! Thanks for the humor, Mark.



## GET PAID FOR YOUR PHOTO

We pay \$40 per photo we publish. If you'd like to get your modeling in our photo feature, just start posting your photos on the MRH website, especially in the Weekly Photo Fun thread created each weekend.

See [mrhmag.com/help](http://mrhmag.com/help) for more on how to post an image. You need to be an MRH subscriber to post photos to our website, and becoming a subscriber is free, [just fill out this form here.](#) ■



**Click here for  
reader comments**

## Take the MRH 2016 Reader Survey ...



**... and get a chance  
to win a 10" Kindle  
Fire tablet!**



fireHD10  
OUR LARGEST  
DISPLAY  
— ON OUR —  
THINNEST TABLET

**amazon**

**TAKE THE SURVEY >>**

Get the first 50 issues of  
**Model Railroad  
Hobbyist magazine™**

Save  
yourself  
endless  
hours of  
downloading

On a data DVD for \$10!

**Send me one!**

*(Sold by Model Trains Video)*

*Includes a coupon  
good for \$20 off on  
TrainMasters TV*

*Over 5000  
pages of  
how-to  
information  
on model  
railroading*



# Simple-to-make *PALM TREES*

BY TIMOTHY F. DUDLEY

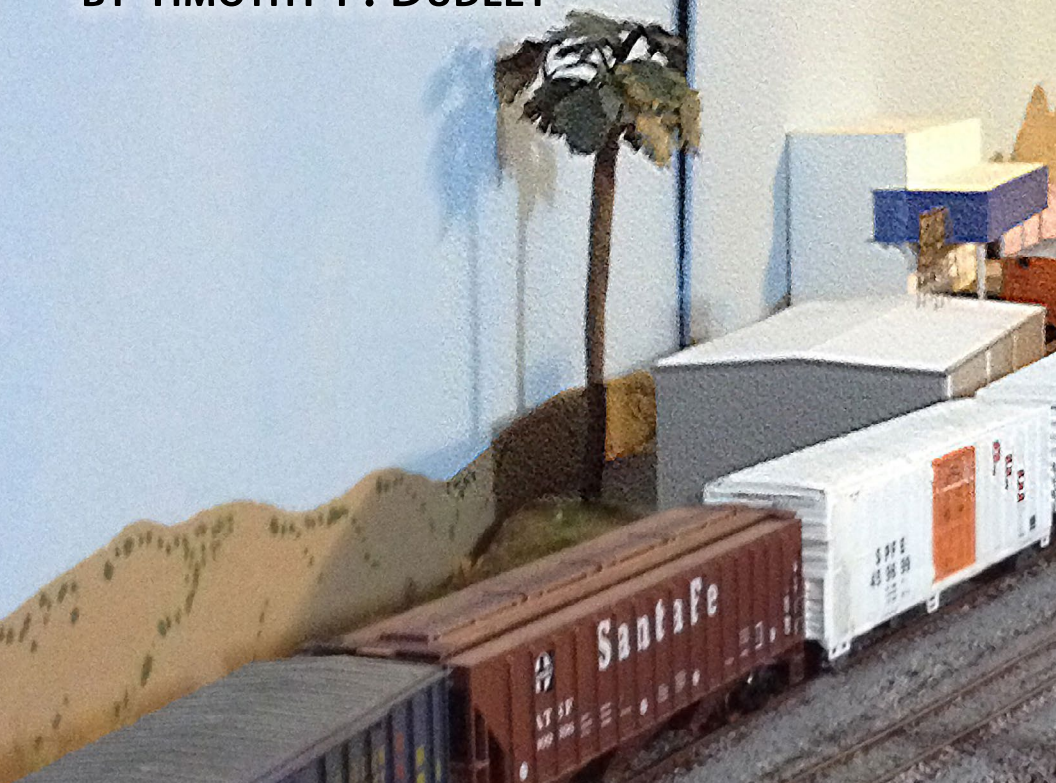

## *Use paper, paint and wire ...*

**I WANT MY SP SOUTHWESTERN RAILROAD TO** take on that “Southern California feel,” and I realized that something was lacking from its scenery.

Some type of palm tree would give the layout that look, I decided. The most common palm I found to represent Southern





*Follow along,  
step-by-step!*

California is the Mexican fan palm. Having no budget for trees, I scrounged up items from around my train room and devised a way to make a palm from materials I had on hand. The finished product is simple, inexpensive, and fairly lifelike.

Here is what I gathered for the project:

- **Krylon Satin Olive Green spray paint**
- **floral tape**



[Click here for reader comments](#)

- leftover green coated florists 22 gauge wire
- acrylic paints
- super glue (CA)
- loose ballast

... and the necessary tools to do the job.



1. The basic tools needed to create my palm trees.

## STEP 1: PREPARE THE TREE FRAME



Begin by cutting a dozen or so pieces of wire to the same length, in this case about 10 inches or so, and group them together.

2. Cut about a dozen pieces of florist wire to length.

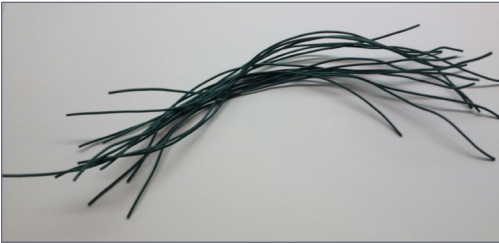

3. Group them together.

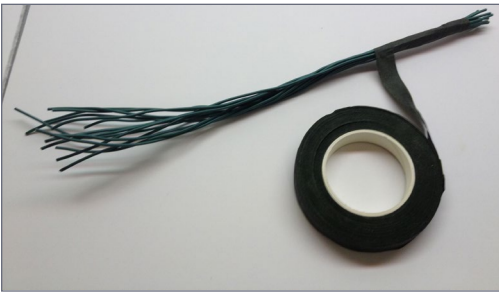

4. Wrap the wires with floral tape, beginning approximately 1/2-inch up from the bottom.

Wrap floral tape around the wires, starting at the bottom of the trunk and working about three quarters of the way up to the branches. Make sure to leave about 1/2" of wire exposed at the bottom of the tree trunk for mounting purposes.



**STEP 1: PREPARE THE TREE FRAME** *CONTINUED...*

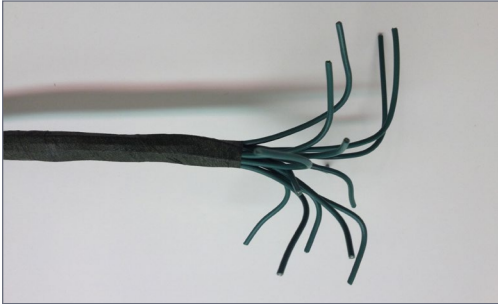

Bend the branches into a gradual 90 degree angle, spacing them around the top of the tree trunk. Set the tree aside.

5. Bend the tops of the wires outward to create the palm stem.

ADVERTISEMENT



**Rusty Stumps**  
Scale Models

WE ONLY SELL WHAT WE MANUFACTURE

**DETAILS** IN HO, O, S & N SCALES

LASER CUT SHINGLES, DOORS & WINDOWS, FENCES, SIDING, CRATES. Also RESIN and WHITE METAL DETAILING CASTINGS.

**CRAFTSMAN KITS**  
IN HO, O & S SCALES

CHECK IT ALL OUT AT  
**WWW.RUSTYSTUMPS.COM**

Send \$3.50 for Catalog - Specify Scale

**RUSTY STUMPS SCALE MODELS**

6785 Cherry Blossom W. Dr., Fishers IN 46038

Phone (317) 595-9489

## STEP 2: MAKE THE PALM FRONDS

Sketch or photocopy the palm frond template. Duplicate the fronds until you have enough for all of the branches. Cut them out with the scissors, and make a few extras.

Ensure that your fronds have a small stem on them; this will be attached to the tree branches using super glue. Glue each frond to a branch. Once the super glue has dried, spray the fronds with the olive spray paint and be sure to cover the undersides as well.



6. Palm frond example.

## STEP 3: PAINTING

Paint the tree trunk with medium brown acrylic paint. For more trunk detailing at the top, run Elmer's glue down about one inch all around the trunk top. While the glue is still wet, sprinkle on any type of ballast you have to represent undergrowth. This can be painted the same brown color as the trunk. When the paint and glue are dry, gently bend the palm fronds and the tree trunk into the desired tree shape you like. I highlighted the palm frond tips with a little yellow ochre paint to age them.



7. Place the palm tree in a scrap piece of foam for painting.



8. A finished palm tree.



.....

## TIMOTHY F. DUDLEY



When Timothy was a little boy, his dad hid an AHM train set so Timothy wouldn't find it until Christmas morning. That started his love affair with the hobby. He and his brother built a four-by-four foot oval layout on a piece of plywood that barely fit under their bunk beds.

Since then Timothy has built a dozen or so layouts in N and HO scales, and is currently working on an N scale switching layout. He is dedicating it to a longtime friend, Mike Pfulb, who recently passed away.

Timothy served in the U.S. Navy from 1984-1990 and is now a laboratory equipment engineer. He is also a licensed minister of the Gospel and serves part-time in his local church. He enjoys playing bass on the worship team, train watching, and writing. ■

.....



[Click here for reader comments](#)

# How to model Working cranes in HO scale

## Part 2

BY DR. GEOFF BUNZA

Photos by the author

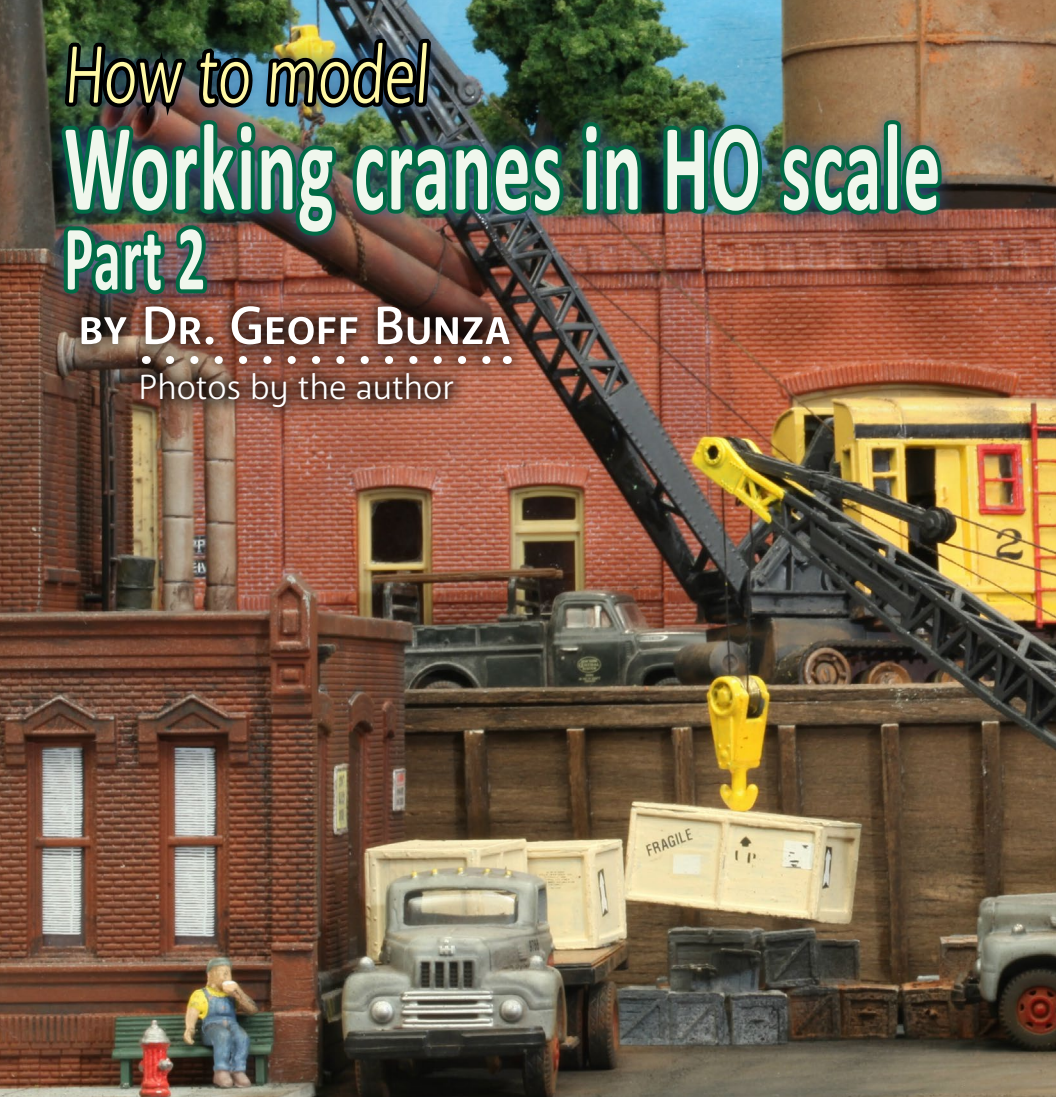

*More animated cranes for your layout ...*

**IN PART 1 I SHOWED YOU HOW TO BUILD THE** first two out of four working cranes. This month I will show you how to build the final two mobile crane projects with cranes on caterpillar treads and show how you can put them on your layout using two different control methods: one with

• [INDEX](#)

• [TABLE OF CONTENTS](#)





*Follow along,  
step-by-step!*

in-the-layout wire-guided control, and the other using wireless remote control.

## Building a working crawler crane (Crane #2)

While the “simple” truck cranes #18 and #19 work great for gathering attention, I wanted to tackle even more interesting and challenging models – mobile cranes with caterpillar treads.





[Click here for reader comments](#)

---

## STEP 1: GATHER THE PARTS



54. A stock 25-ton railroad crane.

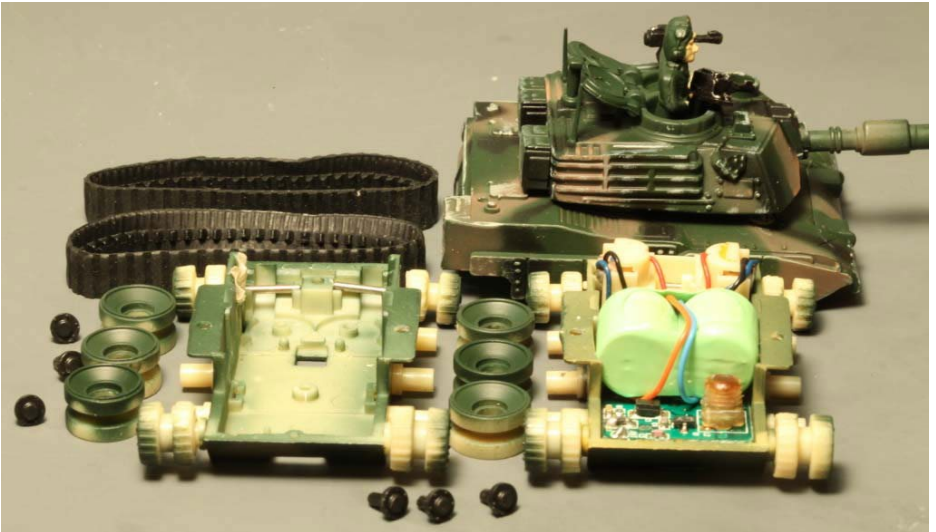

55. The RC mini-tank used for the chassis of the crane.

For crane #2 (and the next one, crane #3) I used the Walthers/ TrainMiniature/ TrueScale/ AmericanFlyer 25-ton crane cab and boom. I mounted these cranes on a heavily reworked set of caterpillar treads from a remote-controlled (RC) mini-tank (any of several brands will work).

I originally purchased this remote controlled tank years ago locally from Fry's, but they have been available for a long time on eBay. Search for "mini RC tank" identifiable by the 5-wheel tracked drives, less than 3" in length.

I was hoping I could use the motors, geared drives, and perhaps even the RC controller, but I ended up scrapping them all. The RC control was full-on/full-off, and limited to two channels, so I abandoned ideas of using it as built. I also found the gearboxes to be unreliable, so I set those aside also.

When talking to hobby vendors,  
please remember to mention  
MRH.

### STEP 2: PREPARE THE CHASSIS MECHANISM

The rollers are too large straight out of the box, so I turned them down on a lathe. If you don't have a lathe, they can also be chucked in a drill and filed or sanded to size. I reduced the middle rollers to about the same size as the end wheels.

This left the tracks with less tension on the rear drive wheel. So I made a cut in the side behind the front sprocket down to the floor without cutting the floor. I bent the front sprocket, axles and side walls forward to make a "V" in the side walls [57]. I cut a piece of 0.010" sheet styrene to fit, and glued each to hold the side wall in place.

This also leveled the rollers and sprockets for a more realistic look, and allowed for the proper tension for the track drive. The operating rubber caterpillar treads are the only piece of the model that I haven't succeeded in building from scratch to my satisfaction, although I've gotten close with liquid latex and tissue paper.

I built up the sides of the tank with strips of 0.040" plastic to form a level mount for the crane cab. I used the right-hand drive motors on Truck Crane 18 here in pairs.

First I cut, trimmed, and sanded the motor gearbox as much as possible, including beveling the corner near the last drive gear. I tried not to destroy the integrity of the case, nor to damage any of the gears. It took several tries for me to finally trim things down to my satisfaction without damaging the case or gears! After shaping the cases, take the gearbox apart.



## WORKING CRANES | 6

**Warning:** That the tiny black screw holding the last drive gear in place is a left-hand screw – to remove it turn it *clockwise*.



56. A stock roller on the left compares to a roller on the right that has been reduced in size.

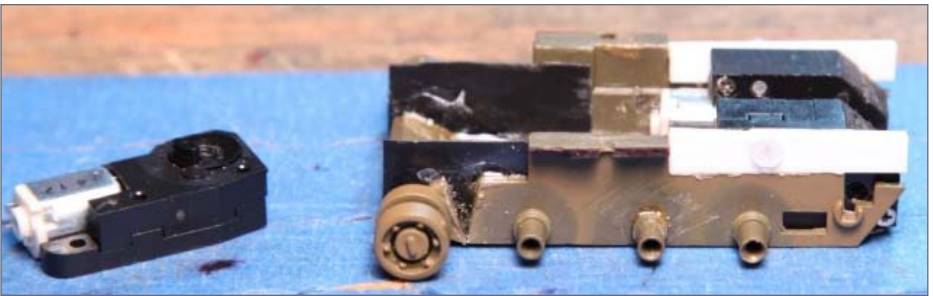

57. Chassis side-wall preparation for the motor drives.

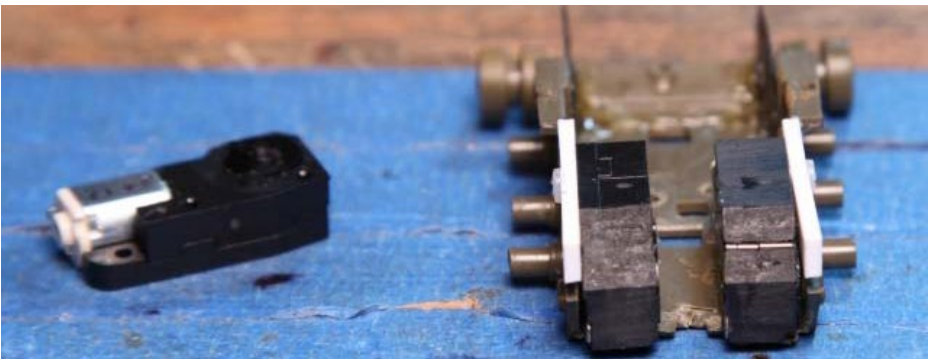

58. Mount the drives square to the chassis.

### STEP 2: PREPARE THE CHASSIS MECHANISM

#### CONTINUED...

I cleaned off all the grease and re-greased the mechanism with a high-quality lubricant like Nano-Oil (great stuff). The center of the last drive gear needs to be drilled for a friction-fit of the axle to the drive wheel axle for the treads.

Measure the diameter of the axle and use a smaller drill size than your measurement. These axles are not a standard size; mine were 1.5mm, so you will have to make your own measurement. I started with an obviously smaller drill and worked my way up until I got a good fit. Don't insert the axle all the way in yet.

One of the holes can be tapped for a 0-80 screw (mentioned previously) and used to mount each of the drives. I depend on the track and the motor mount to hold the gear and axle in place. It is important that the motor housings be mounted straight and vertical. File and sand the inside floor of the tank, and then reinforce the inside wall with some thin styrene sheet cut to fit.

I recommend attaching the motor wires before installing the motors. Again I used very fine wire—28 gauge or finer. After attaching the motors to the inside wall, I inserted the drive wheels/axles and tested the tracks. Each track should have enough tension to turn easily under power, and remain in place. The roller wheels help keep the tracks in place too. I also spent time correcting any alignment issues; it saved a lot of grief later.

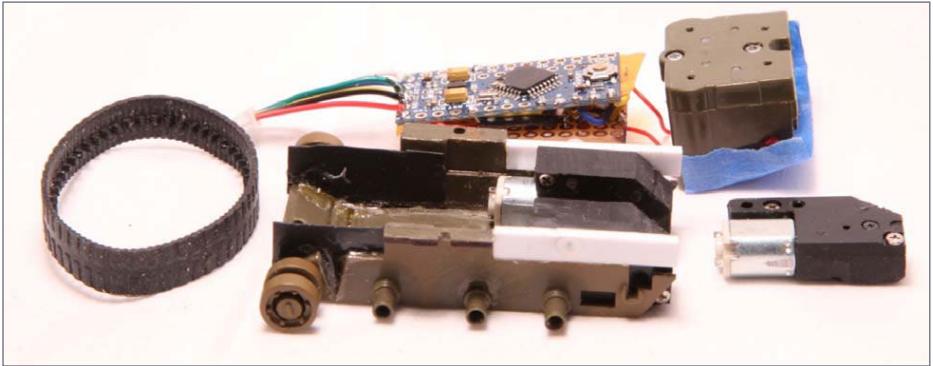

59. Chassis parts.

ADVERTISEMENT

**GLXSCALEMODELS.COM**

GLX SCALE MODELS - OTTAWA, ONTARIO, CANADA - 613-294-2276

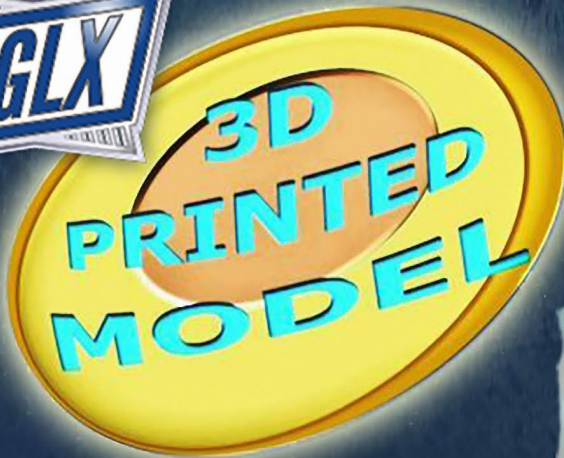

**NO  
ASSEMBLY  
OR  
PAINTING**



MOBILE LOADING RAMP



PORTABLE RAILCAR UNLOADER



RAILCAR INSPECTION TOWER

**BUY & DISPLAY NOW!!!**



## STEP 3: MOUNT THE CAB ON THE TREAD CHASSIS

I mounted the crane cab to the track chassis with two flat-head screws through the holes in the chassis tabs next to the motors. I glued thick plastic strips to the bottom of the crane cab and filed them to form an even surface to join to the chassis.

The chassis I used were of differing sizes. I cut and fit until it worked. By now you should be able to mount a cab to the unfinished chassis, with fully tracked caterpillar treads.



60. (Above) Level the cab bottom by filling in the raised portion under the door and window.

61. (Left) The cab has been mounted on the chassis with full caterpillar treads.

## STEP 4: BUILD THE GUIDANCE SYSTEM

To understand how this crane travels where intended, you need to understand a great little sensor called a Hall Effect Device.

The Hall Effect sensor is likely known to some, but perhaps not to most modelers. It is a three terminal device. In this case, it is powered by 3.5 Volts. There are two connections: plus (+) and minus (-).

The two types I use are the AH180-PL-A (the one with leads) and the TCS20DLRLF the surface-mount device (SMD). I show both in [63].

The AH180-PL-A can be powered with 5 Volts. It has a single output pin that will pull the line low (connect it to +3.5 to 5 Volts through a 4.7K resistor) when it detects a magnetic field – so it’s a magnetic switch. Big deal you say? Maybe, but consider the possibilities. These switches can be turned on by incredibly small magnets.

[Digikey.com](http://Digikey.com) and [Mouser.com](http://Mouser.com) are good sources for all sorts of Hall Effect sensors. Be careful though; there are several variations. Look for the one with an “omnipole” characteristic. This will activate with either the north or south pole of a magnet, which is the kind I used.

Either of these will react (turn on) in the presence of a magnetic field. They switch on when a magnet is near and switch off when the magnet goes away: very simple. Now for the best part – you can obtain tiny rare earth (incredibly strong) magnets from many sources, including online vendors.

## STEP 4: BUILD THE GUIDANCE SYSTEM *CONTINUED...*



62. The shoe that guides the crane can be seen between the tracks.

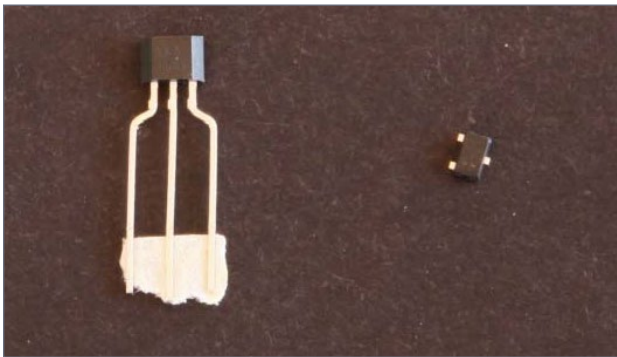

63. AH180-PL-A left and TCS20DL-RLF right.



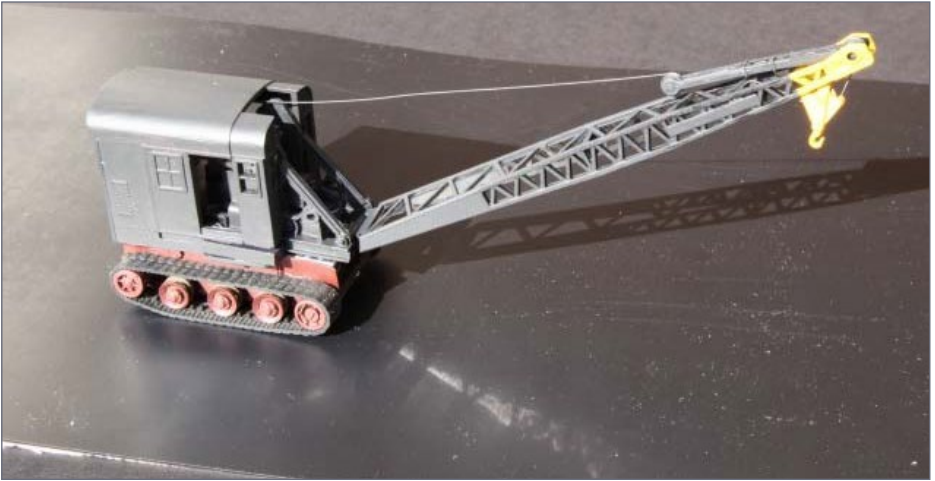

64. Wire guided crane ready to go to work.



65. Embedded wire in the foamcore base guides the crane on its route.

I insert an iron/steel/ferrous wire along the path of travel I want for the crane, much like the Faller car system (a great innovation in my opinion). I make a cut in the foamcore sub-roadbed I used and inserted the wire just below the surface [65].

### STEP 4: BUILD THE GUIDANCE SYSTEM *CONTINUED...*

I started with an old wire coat hanger, and it worked great. In the model shipbuilding section of hobby stores, I found black, annealed spools of wire. Be aware some may not be attracted to a magnet, so take a small magnet along with you when you look for them. I found these in 19 gauge, 21 gauge, and 24 gauge. All work, but in this case bigger is better (smaller gauge number).

I made the “shoe” [66] on the bottom of the crane from a small piece of styrene that freely pivots on one end via an 0-80 screw. The shoe is dragged from side to side as the crane moves along the embedded wire under the plastic top. I inserted two brass 0.020” wires as stops to limit the side-to-side travel of the shoe. The magnetic shoe is tapered on the front so it can go over mildly uneven surfaces.

The wire in the roadbed carries no electrical signals, and there are no special markings whatsoever on the surface. But in the crane chassis above the shoe on each left and right side, there are two Hall Effect devices, TCS20DLRLF.

When the crane deviates from the course set by the wire below, the shoe moves under one sensor, the sensor turns on, and the controller in the crane detects the change, and simply drives the treads to turn until the sensor switches off. All very neat and simple.

This is a very simple variation of a “line-following algorithm” used by all kinds of robots.

# WORKING CRANES | 14

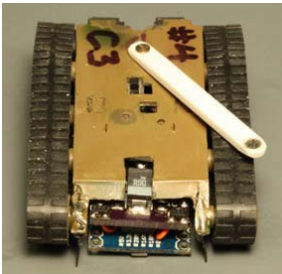
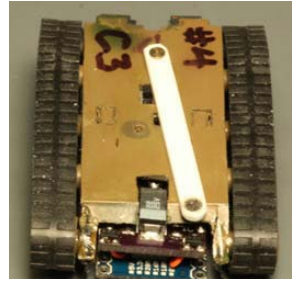
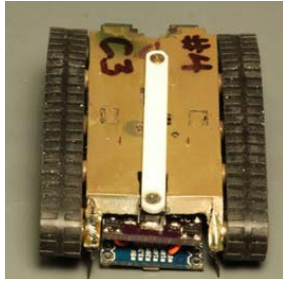
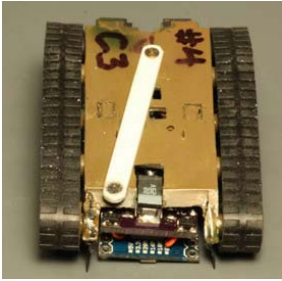

66a-d. Magnet in shoe on the bottom of the crane.

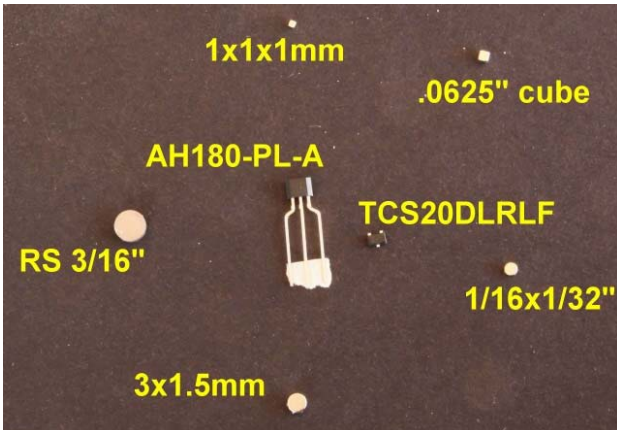

67. Hall Effect magnetic sensor parts.



68. Magnet sticks used to guide the crane.



## STEP 4: BUILD THE GUIDANCE SYSTEM *CONTINUED...*

It should be clear that there is no mechanical linkage as in the Faller car system for steering. A mechanical linkage isn't appropriate for a tracked vehicle anyway.

What happens in turning is really interesting. I laid out the first course as a decreasing-radius spiral following several "wiggles" left and right. This was an attempt to measure how sharp a radius the crane could take. Originally, it turned by stopping one track and driving the other to pivot around the stopped track. This worked, but on the decreasing-radius turn, it eventually went off course.

But a tread crawler can pivot in place by driving one track forward and the other backward – so why not here, too?

This method yields an amazing capability to (almost) make a 90 degree turn following the embedded wire. The modeling intent is to navigate through a forest, city streets, or a quarry. The treads also allow it to climb very easily.

In [68], all of the magnets shown are incredibly small and cheap. Other than the Radio Shack (RS) magnet, I purchased them from different sources like K&J Magnetics ([kjmagnetics.com](http://kjmagnetics.com)) and eBay. The bigger and stronger the magnet, the greater the distance away from the sensor it can be and still work.

If you have a moving apparatus, say a turntable, you can detect multiple positions with one sensor by secreting tiny magnets at all track alignments, with no mechanical connections or contacts – pretty neat if you think about it. You can glue one of each type magnet to a small stick and use the stick to determine the orientation of the magnet (pole position) and pick up the tiny magnets before they "launch" off your workbench!

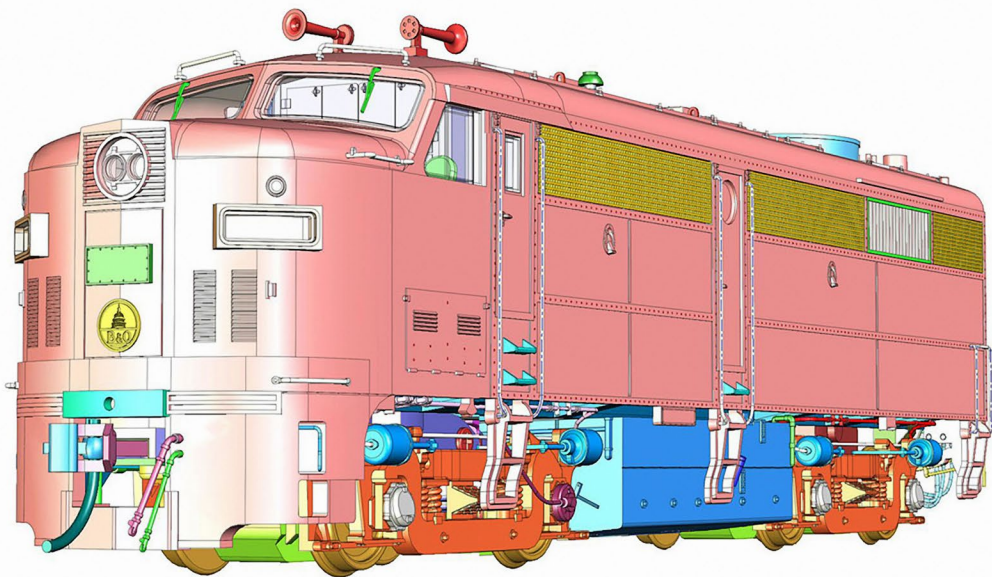

HO SCALE FA-2 / FPA-2  
IT'S TIME TO PUT YOUR  
OLD MODELS ON EBAY.

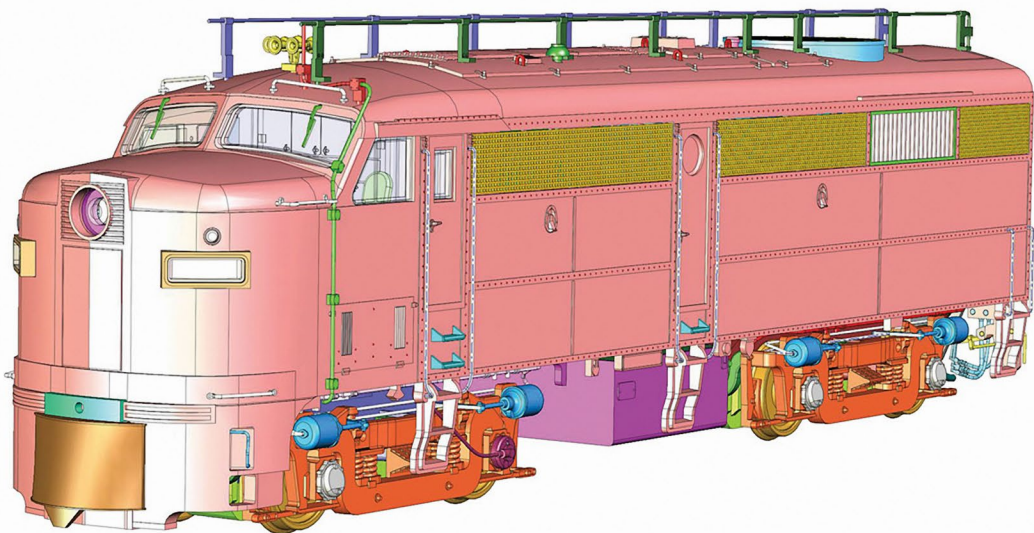

## STEP 5: INSTALL THE CONTROLLER

The controller in the wire-guided crane is a cheap Arduino Pro Mini controlling the two motors with an SN754410 dual H-Bridge integrated circuit [69]. I originally wired the little board by hand. It took quite a bit of fiddling to get the board to fit with the correct positioning of the tiny Hall Effect sensors.

The sensors must be just above the small (1.5x3mm) magnet in the shoe to work correctly, and as low in the chassis as possible. In the additional materials with this article is a printed circuit board (.brd) file and the accompanying Eagle schematic. With no foreknowledge, you can go online to OSH Park ([oshpark.com](http://oshpark.com)), create an account, upload the .brd file, and get your own tiny driver board made (three for about \$3.15) to save you some effort. This little board needs:

- 1 - SN754410 Dual H-bridge driver [Digikey.com](http://Digikey.com) part #296-9911-5-ND
- 2 - 22 uf SMD capacitors [Digikey.com](http://Digikey.com) part #399-3781-1-ND
- 2 - A1202LH Hall Effect sensors [Digikey.com](http://Digikey.com) part #AH180-WGDIDKR-ND  
(This is the surface mount type)

The driver board is laid out with provision for socketing or soldering directly to the Pro Mini. I found cutting and shaping the chassis bottom to be required to fit the pair, but you may prefer the printed circuit board to wiring your own and fiddling with the tiny sensors. Either way, you'll need some custom fitting and filing to make this work. You need to



tack-solder thin wire leads to pins 3 and 6, and 11 and 14 for the motor connections. Use the thinnest wire you can find. I used 30 gauge wire-wrap wire.

Also in the additional materials you will find the Arduino sketch (program) that is ready to load into your wire-guided crane controller. You can find an introductory tutorial on loading your Pro Mini in the November 2014 issue of Model Railroad Hobbyist “Starting from Scratch with an Arduino Pro Mini (or Moteino).” ([mrhpub.com/2014-11-nov/land/#83](http://mrhpub.com/2014-11-nov/land/#83)).

The sketch will move the crane along the wire path and stop every so often at random. In this way the battery life is extended and it makes an interesting animation of its own. This crane ran for several hours by itself on a full battery charge; your mileage may vary!

I used two 240 MAH LiPo batteries, each equipped with its own battery-management board. The batteries are wired in parallel (plus-to-plus, minus-to-minus) and are charged simultaneously only with a compatible LiPo charger. An ElectriFly Triton battery charger is more than capable in this case. The batteries connect directly to a tiny slide switch mounted above a small hole in the bottom of the chassis. You can see it in the rightmost figure [66] of the magnet “shoes.”

From the switch the power connects directly to VCC or +5V on the Arduino Pro Mini. Originally, I placed two motor drives in the cab for the boom and hook, but never powered them – another project to complete. It will require another

## STEP 5: INSTALL THE CONTROLLER *CONTINUED*...

motor drive board, and that would make for a tight fit in the cab. Originally, I had to take the cab off to recharge the batteries, which proved to be a bad idea. I added a tiny connector [80] and cabled it directly to the batteries to allow recharging without disassembly. I switched off the power, and connected the battery charger to the tiny connector for recharging.

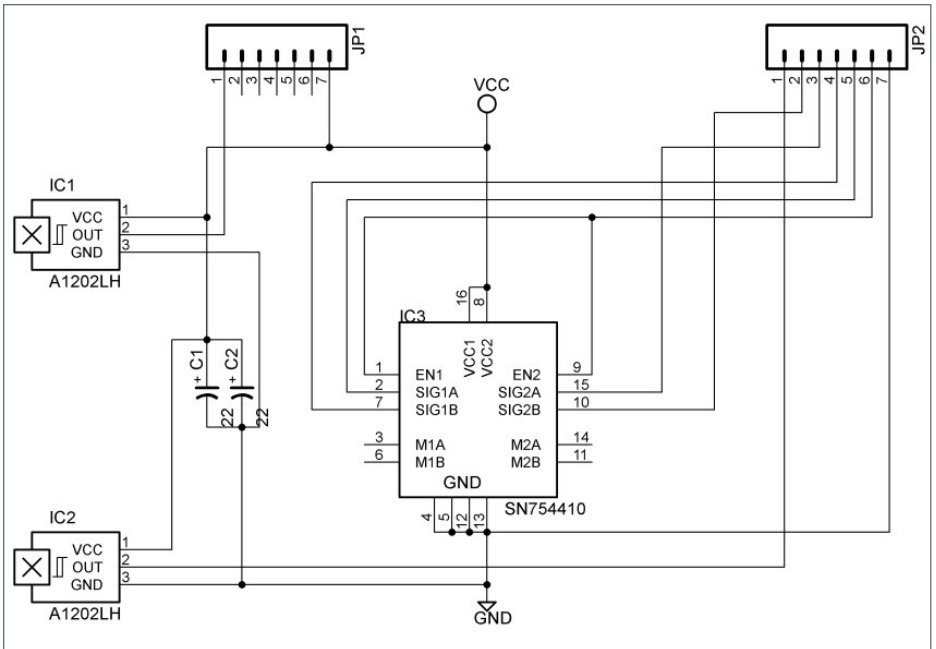

69. Dual motor driver schematic.

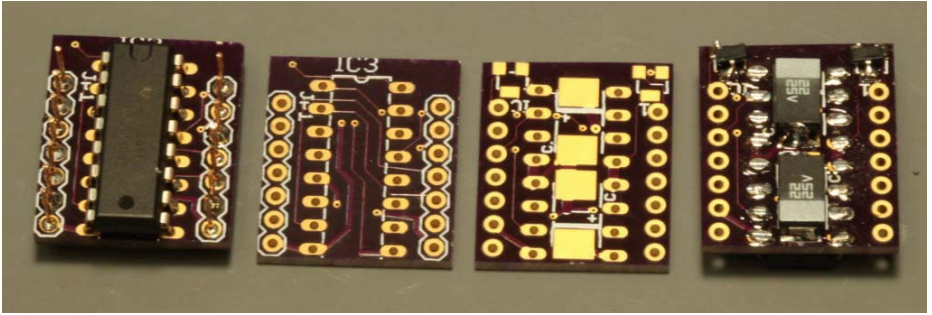

70. Dual motor driver PCB board.

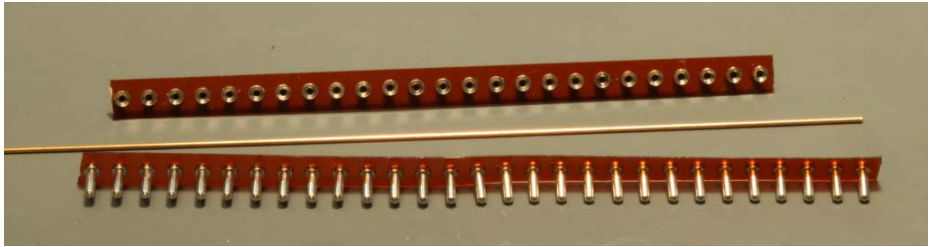

71. Sockets and 0.020" wire.

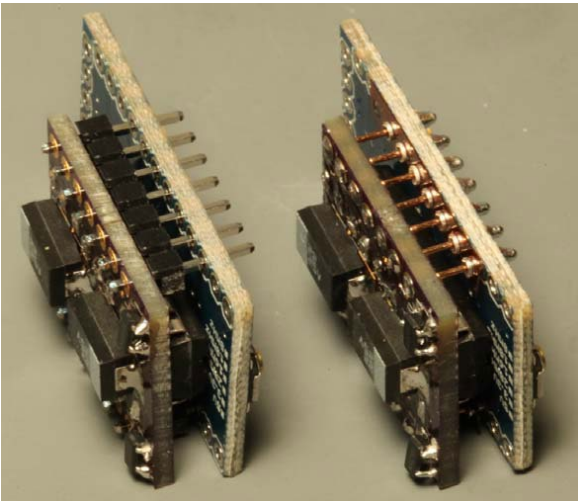

72. Motor driver attachment alternatives.



## STEP 5: INSTALL THE CONTROLLER *CONTINUED...*

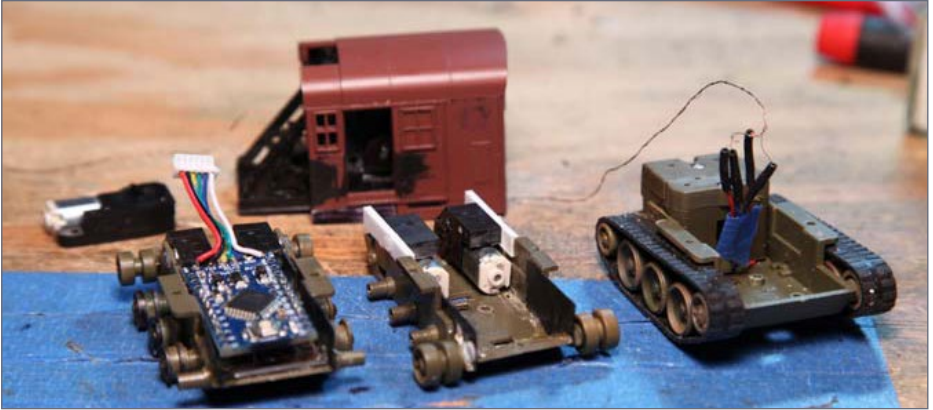

73. Progression of chassis construction.

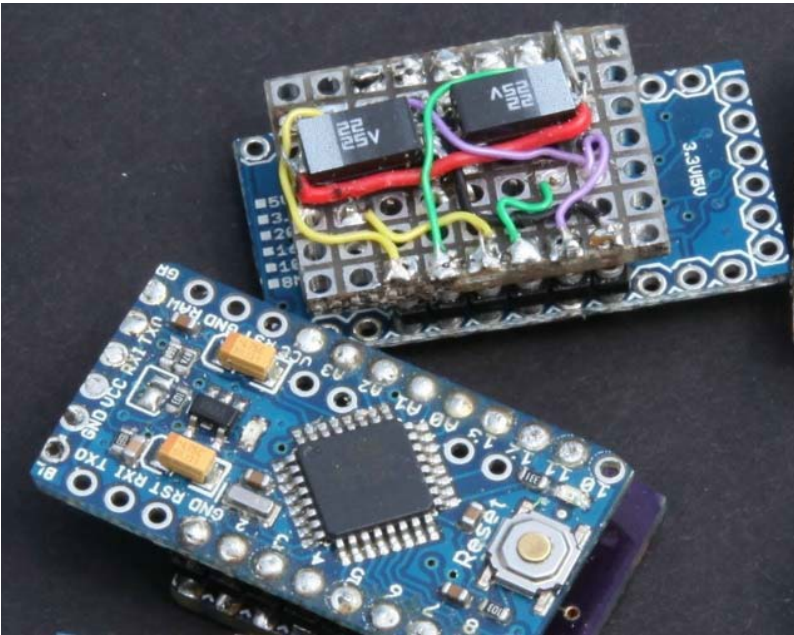

74. Hand-built driver board.

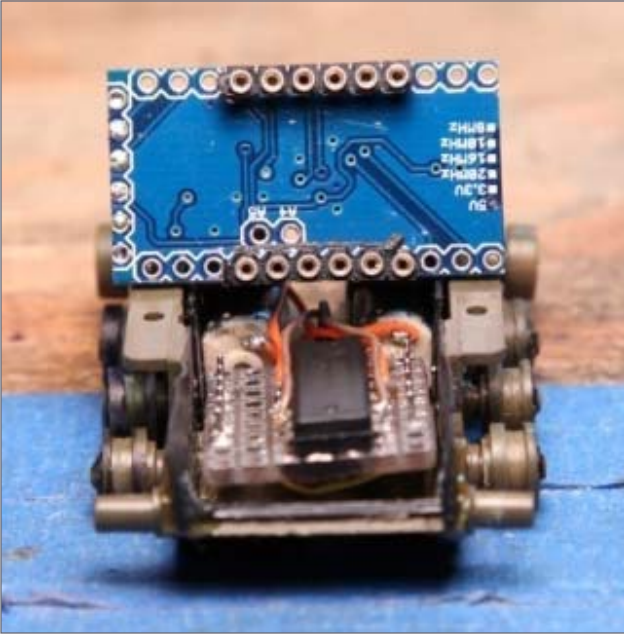

75. Hand-built driver placement in the chassis.

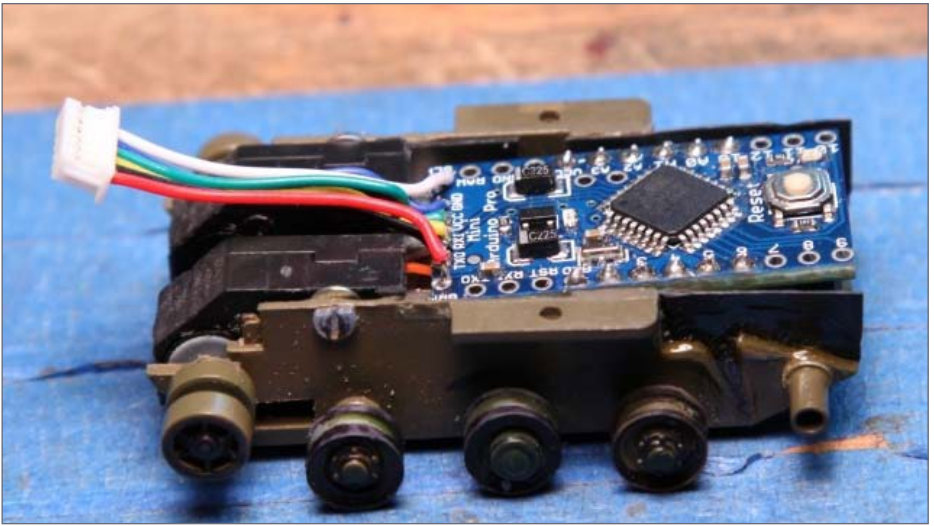

76. Progression of chassis construction.

## STEP 5: INSTALL THE CONTROLLER *CONTINUED...*

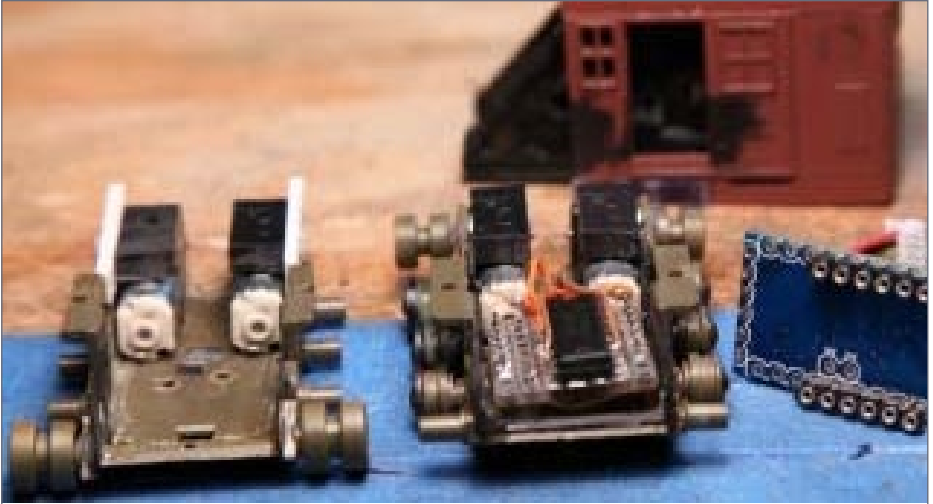

77. Assembly steps.

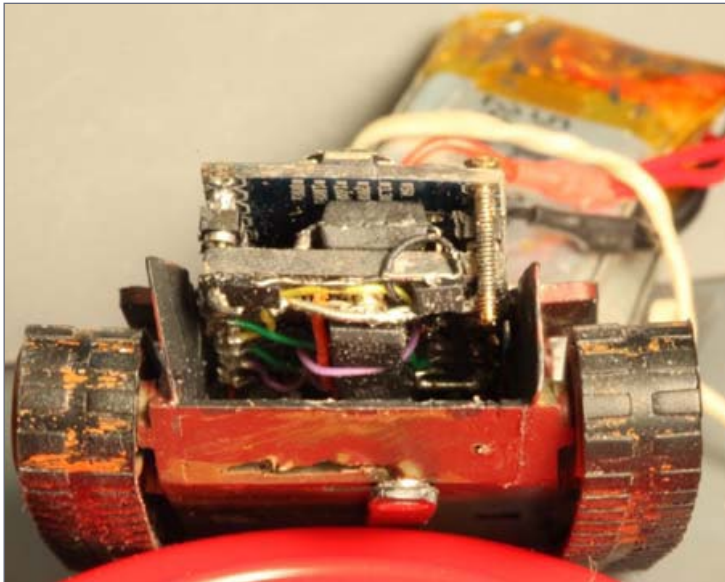

78. Sensors below the board.



### STEP 6: FINISH CRANE #2

I cut out the rear cab window openings and modified Tichy work car windows that I added and glazed. I also added an inside sliding door in a partly open position along with roof access ladders placed on each side.

I enclosed the chassis front with styrene strips, and placed an air tank in the front. I muddied the caterpillar tread tracks with appropriate colors, but I haven't decided how badly weathered the crane will be yet.

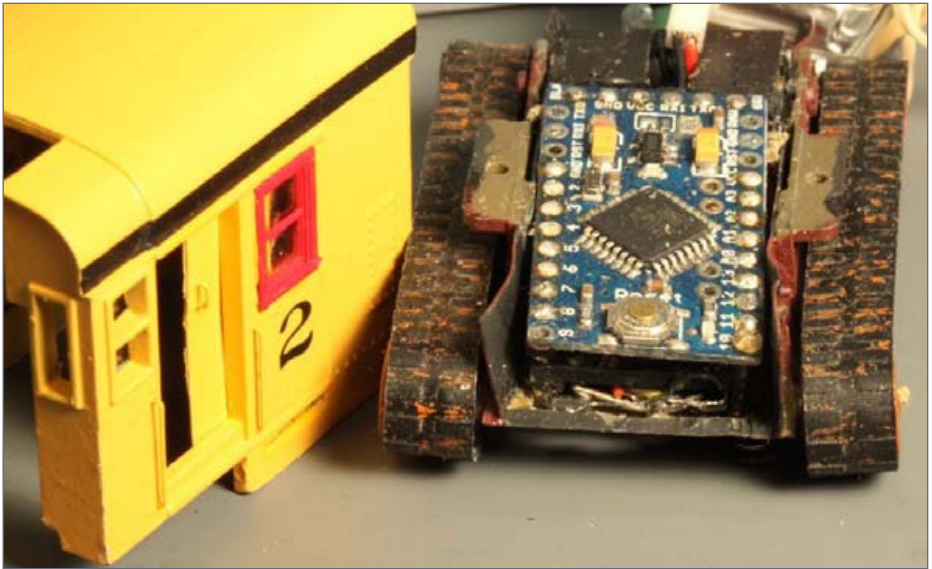

79. Pro Mini and sensor mounting in the chassis.

## STEP 6: FINISH CRANE #2 *CONTINUED...*

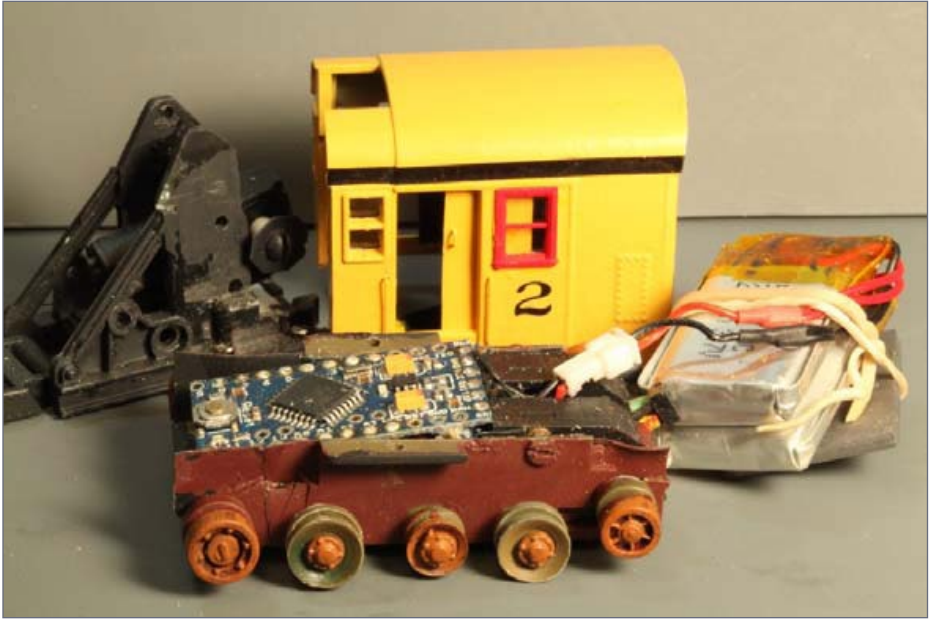

80. The cab is ready to be mounted.



81. Finished crawler crane 2.

## Building a remote crawler crane (Crane #3)

The last member of my animated crane set is almost identical to the mobile tracked crane #2, but is radio-controlled, and has an operable hook and light. I equipped this crane with a Moteino ([lowpowerlab.com/moteino](http://lowpowerlab.com/moteino)), an Arduino-like controller with a radio transceiver (transmitter-receiver). This is the same device used in the remote-controlled battery locomotives described in the November 2014 Model Railroad Hobbyist ([mrhpub.com/2014-11-nov/land/#83](http://mrhpub.com/2014-11-nov/land/#83)).

I followed the same caterpillar tread motor and chassis construction methods from the previous model, crane #2. However, I located all the electronics in the cab, not the chassis.

Because crane #3 construction is so similar to crane #2, I'm only going to focus on the steps in this animated crane project that are unique to building a radio-controlled animated model.

ADVERTISEMENT

## END OF TRAIN DEVICE

**NEW ORANGE CASE!**

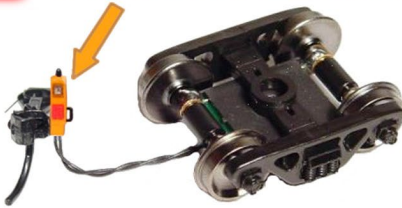

Patented Technology - US Patent 7,549,609

**Bright Red  
Flashing Light!**

Installs in minutes!  
No freight car  
modification required!

**RE RING<sup>TM</sup>  
ENGINEERING**

**Click Here to  
Learn More**

**Does not affect Load!**

↓ Car without Load ↓



↓ Car with Load ↓



## STEP 1: PREPARE THE ELECTRONICS

All the electronics are hand-wired on a small perf board incorporating two SN754410 Dual H-bridge drivers. I used Digikey.com part #296- 9911-5-ND to control the three crane motors that provide the animation.

Tiny wire connectors from LedBaron ([stores.eBay.com/ledbaron](https://stores.eBay.com/ledbaron)) are used to make assembly/disassembly easier. I used similar connectors for the battery charger connection. I stacked and glued two three-pin connectors to connect to the six programming pins on the Moteino. This makes reprogramming easier.

I selected the same LiPo batteries that I used in the previous mobile crane. However, I placed only one hoist drive, using the right-angle drive motor, forward into the cab to move the hook. I equipped this crane with a larger, heavier hook, Athearn part #17017.

I added a work light, an 0603 white LED, to the roof of the cab with a Cal-Scale #190-304 headlight casting. The crane cab has the same paint and detail as the previous crane, but I assigned a different company number. I placed a small “Radio Equipped” sign above the window – sorry, I couldn’t resist!

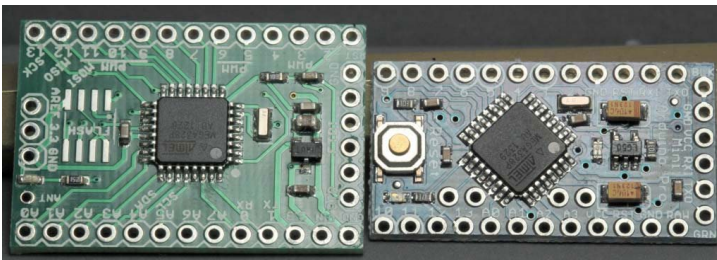

82. Arduino Pro Mini (right) vs. Moteino (left), top view.



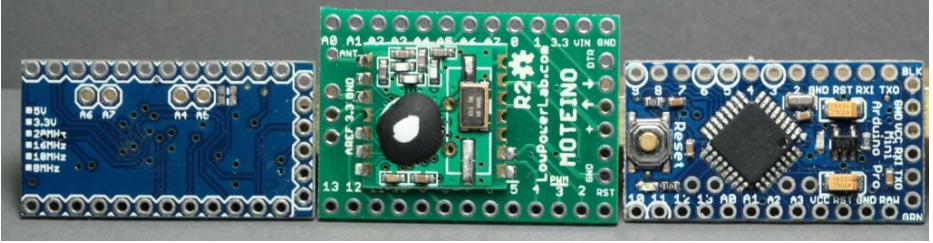

83. Arduino Pro Mini (left) vs. Moteino (right), bottom view.

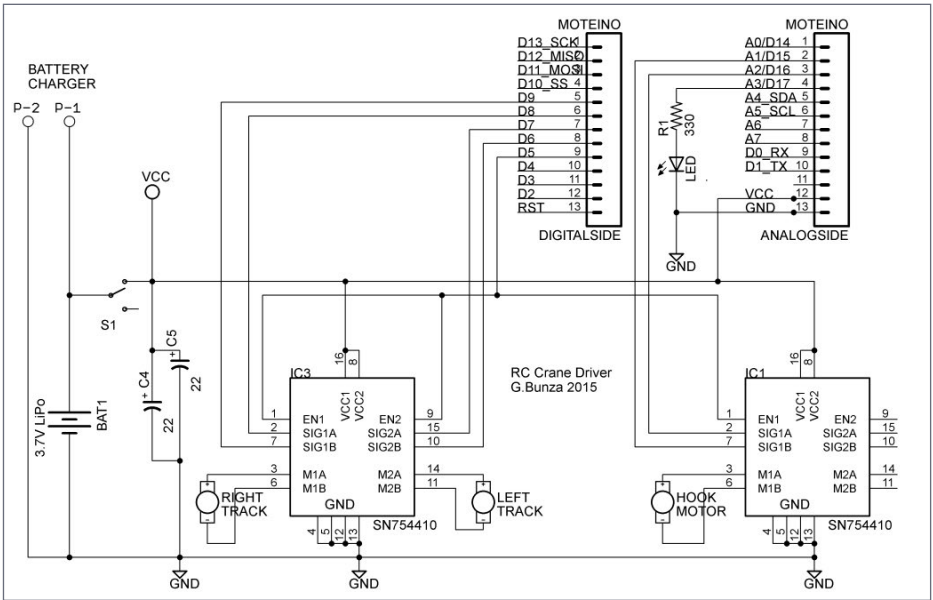

84. Crawler crane schematic.

## STEP 1: PREPARE THE ELECTRONICS *CONTINUED...*

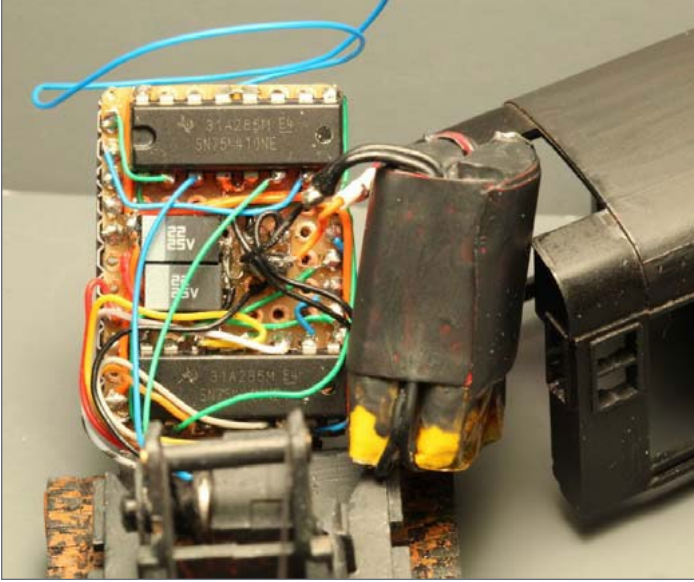

85. Crawler crane driver.

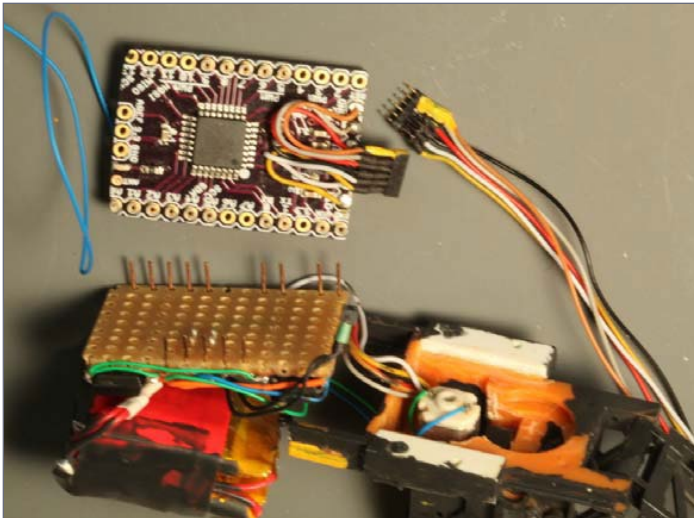

86. Moteino wiring harness.

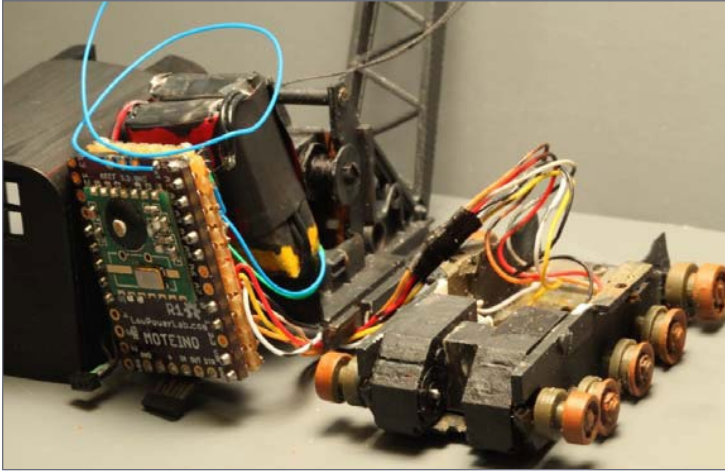

87. Crane 3  
internals.

## Take the MRH 2016 Reader Survey ...



... and get a chance  
to win a 10" Kindle  
Fire tablet!



fireHD10  
OUR LARGEST  
DISPLAY  
ON OUR  
THINNEST TABLET

amazon

**TAKE THE SURVEY >>**

## STEP 1: PREPARE THE ELECTRONICS *CONTINUED...*

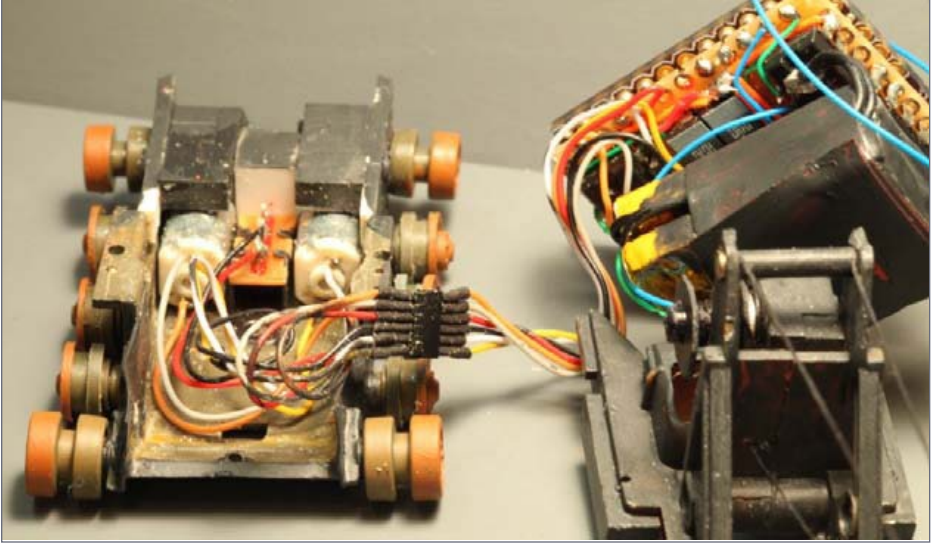

88. Crane 3 motors and wiring harness.

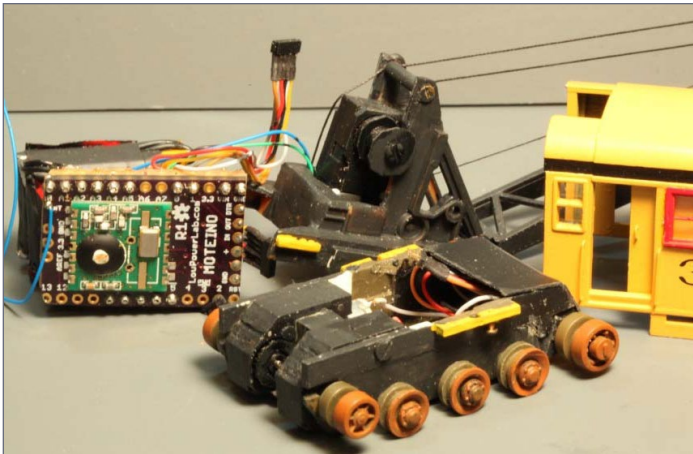

89. Crane 3 ready for assembly.



## STEP 2: BUILD THE WIRELESS CONTROLLER

The remote control box is essentially another Moteino, some switches and variable resistors, and a 9 Volt alkaline battery. Moteinos can be ordered using different radio frequencies, so check which frequencies are legal in your country. This crane uses the R2 version. The R4 version is available at the time of this writing. You will need to download the appropriate library from <http://lowpowerlab.com/moteino> to match the one you use. Today there are even more options from other vendors to choose from, but that is beyond the scope of this article.

If you follow both wiring diagrams, you should be able to load the sketches into the Moteinos and operate your remote-controlled crane. You can also consider using the controller to send a series of commands to perform an animated sequence. The commands sent from the controller to the crane are alphabetic characters that are interpreted by the crane:

- “f”: forward tracks
- “b”: backward tracks
- “r”: tracks turn right
- “l”: tracks turn left
- “s”: tracks stop
- “u”: hook up
- “d”: hook down
- “p”: hook auto down then up
- “w”: work light On
- “x”: work light Off

You can make up additional commands if you wish.

## STEP 2: BUILD THE WIRELESS CONTROLLER *CONTINUED...*

You can see how each of these cranes performs in the accompanying video, plus a great new capability to put your cranes to work. Check out the video below.



Playback problems? [Click here ...](#)

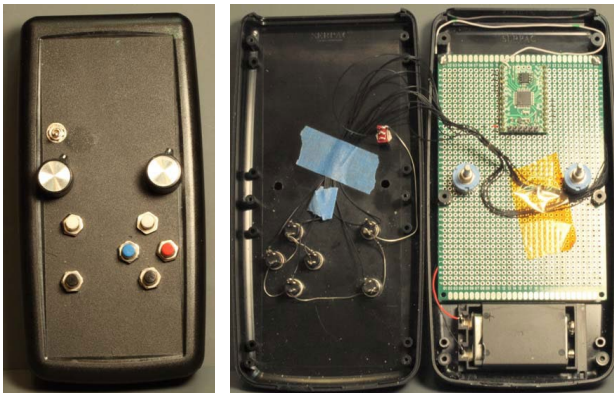

90-91. Remote controller front and insides.

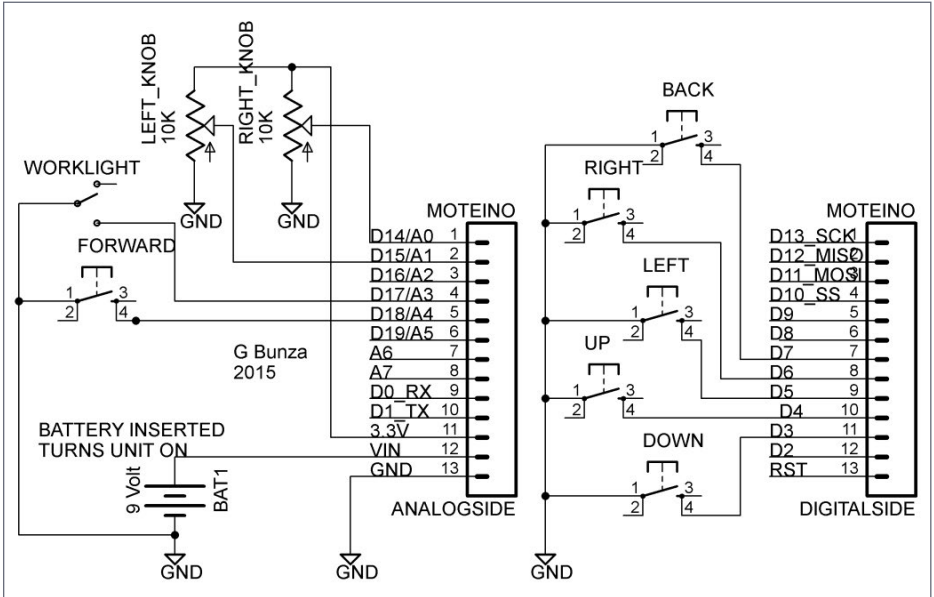

92. Remote controller schematic. Knobs are not used here.



93. Finished remote crane 3.

## Conclusion

These models represent a variety of animation drives and control methods, from easy to complex. They are offered here to stimulate your imagination, and give you some ideas to develop your own animation projects. Perhaps your own flock of cranes will gather on your layout soon.

Have fun!



[Click here for reader comments](#)



94. All of the animated HO scale cranes together. We could call it a "flock of cranes", no?



# MOVING CARGO WITH YOUR CRANE

Now that I equipped my HO scale empire with a contingent of operating cranes, it's time to move the goods. But one of the toughest things to tackle is the question of how. For realistic scale model animation, there are several issues to overcome. Let's tackle the basic problem of moving cargo, in this case crates, from one place to another, and of course by crane!

Realistic crates can be built with wood or plastic. A selection of crates can easily be had with crate set #8174 from Tichy Trains. Taking a lead from the old tinplate cranes, I use magnetism to pick up a crate with a small piece of iron or steel embedded or attached. But prototype electromagnets didn't usually lift many crates. However, one of the small rare earth magnets I used with the Hall Effect sensors can do the job.

These are available as small as 1x1x1 millimeter in size. By cutting out the bottom of the Athearn large hook, part #17017 used on tracked crane No.3, I can embed one of these small magnets in the bottom of the hook. An abrasive cutting disk in a Dremel Moto-tool does the job well. See if you can spot the magnet in [96] – it's barely visible. Epoxy or thick ACC will hold it in place. I completely covered the magnet with glue and then painted it.

For the first attempt at modifying crates for pick up, I used 0.001" steel shim stock, glued to the top of the crate. The modified hook easily lifted the crate – success! When glued to the underside of the top of the crate, the gap weakened the grip enough that the crate sometimes fell. A 0.005" piece of styrene substituted for the crate top narrowed the gap to allow the steel shim to be placed

# MOVING CARGO WITH YOUR CRANE

*CONTINUED ...*

inside the crate. I cut a tiny sliver of steel and attached it to the chains mounted across the top of the crate. This also worked well for pickup.

But how do I drop the crate, once the crane has transported it? Magnetism was the obvious answer again.

I placed an electromagnet under a model loading dock, and put a larger piece of steel on the inside bottom of the crate. Once the crane lowered the crate onto the dock, the electromagnet would grab the crate with a force greater than the small magnet in the hook. The crane could then simply pull the hook away, and continue on its way.

This worked, in part. When the crane pulled up and away, the tension applied made the boom act like a trebuchet and rocked the entire crane in an exaggerated manner – not the realistic effect I wanted. The answer came after quite a few engineering trials, resulting in a relatively simple solution.

The key was to use the “problem” described above to my advantage. By increasing the gap between the hook magnet and the crate steel insert, I was able to disconnect the hook. I could open the hook gap simultaneously with grabbing the bottom of the crate. The electromagnet I used was more powerful than the hook magnet by far, so it easily pulled the crate away from the hook. I also helped the electromagnet by making the steel at the bottom of the crate larger than the metal at the crate top.

Quite a few of my attempted mechanisms were poor or intermittent performers. The best solution I came up with is a spring-loaded column with a small steel plate on the top of a brass tube, attached to a larger steel plate on the bottom. The spring raises the column and the top metal pin to the underside of the top of the crate. This allows the hook magnet to grab it at will.

But if the crate is placed on top of a working electromagnet, the magnet grabs the bottom plate and pulls the column down, creating a gap at the top, and dramatically weakening the pull from the hook magnet.



95. Magnet-equipped hooks. The quarter gives you a good idea how small the magnets are.

**MOVING CARGO WITH YOUR CRANE**  
*CONTINUED ...*



96. The box and its parts.

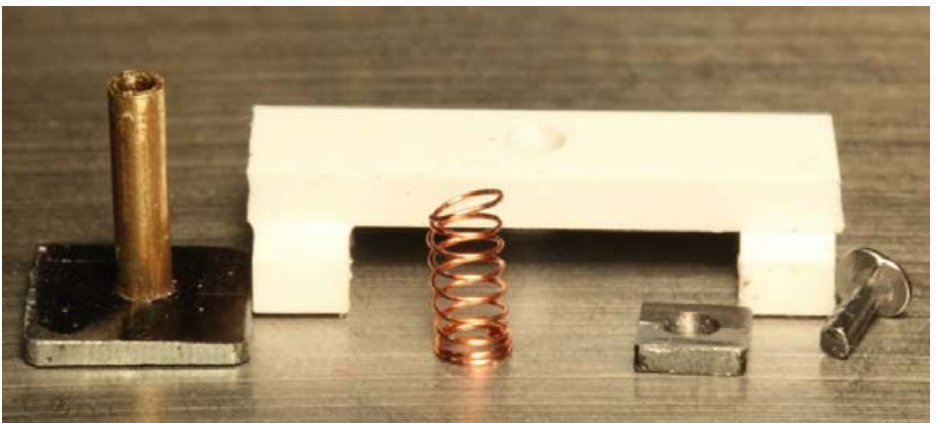

97. Putting the box together.



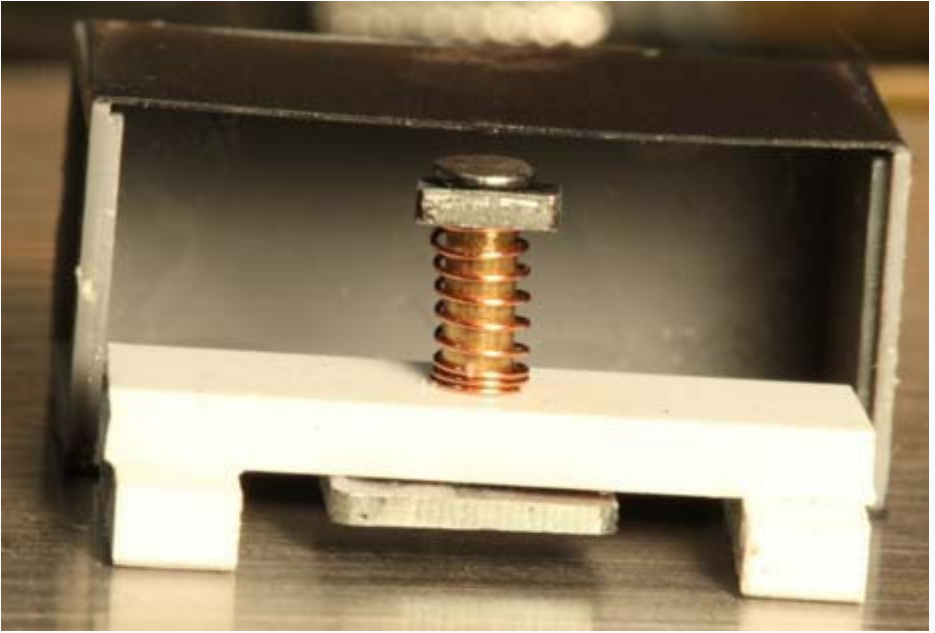

98. The constructed mechanism ready to place inside the box.

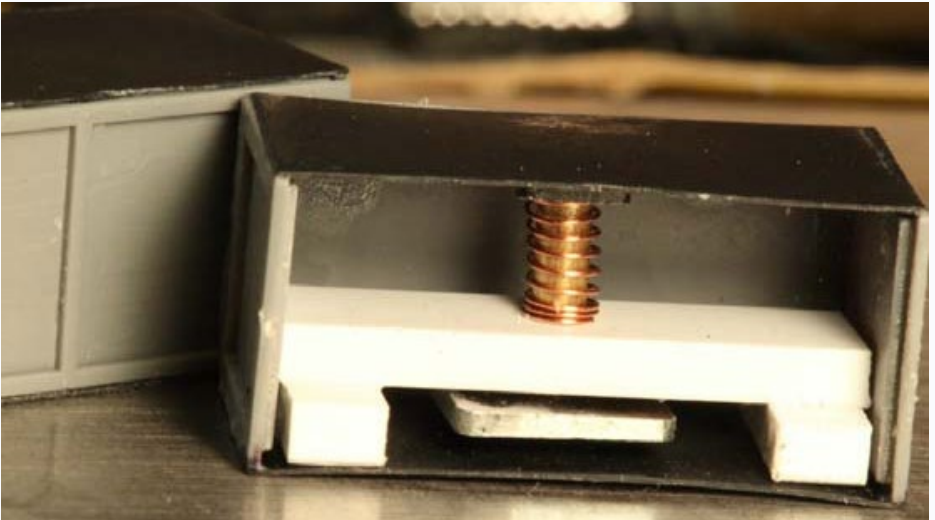

99. Mechanism inside the box.

**MOVING CARGO WITH YOUR CRANE**  
*CONTINUED ...*

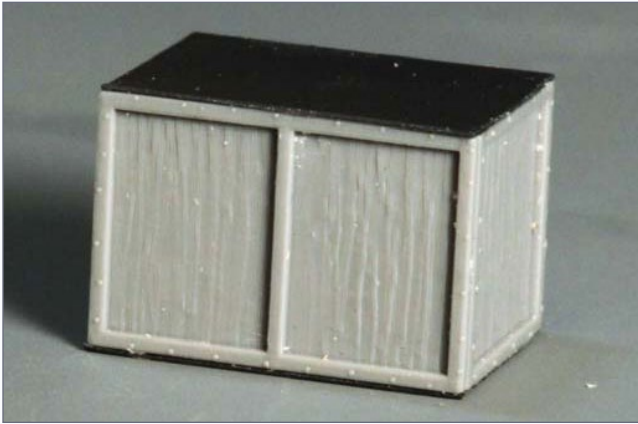

100. The box is ready for transport.



101. Lifting the crate with the crane.



102. The loading dock and crates.

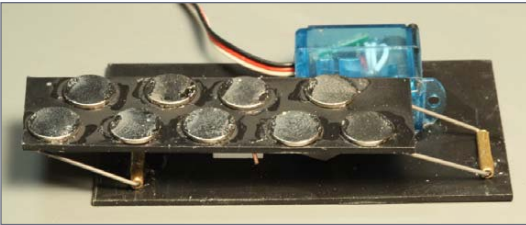

103. Magnet platform in the lowered position.

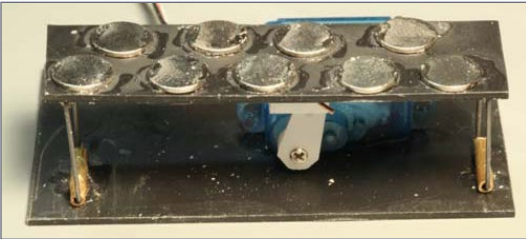

104. Magnet platform in the raised position

This effectively disconnects the hook. After the crane lifts the hook or boom up, the electromagnet can be turned off. Thus, the crate stays in place on the loading dock with no trebuchet effect. The top metal pin is made from a #14 nail/brad. A shortened Kadee #861 G-Scale Centering Spring supports the column. The top and bottom steel pieces are cut from steel key stock obtained at the local Ace Hardware Store. The top and bottom panels of the Tichy box were replaced with black 0.010 sheet styrene.

## MOVING CARGO WITH YOUR CRANE

*CONTINUED ...*

The last problem I had dealt with the use of the electromagnet. This solution worked, but the crate needed to be placed on the electromagnet with too much precision. I found this was a bit too limiting and would not permit dropping multiple crates on the same platform without providing an array of electromagnets.

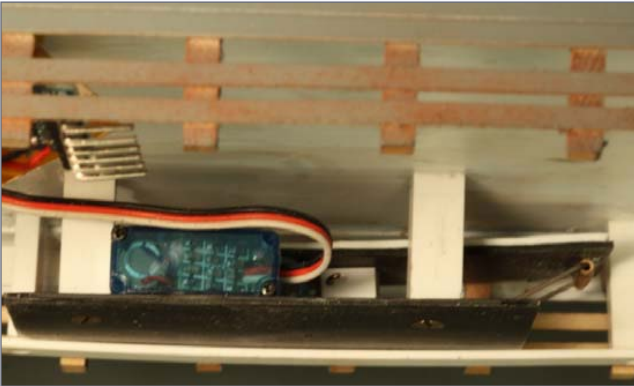

105. The dock platform with the magnets in the lowered position.

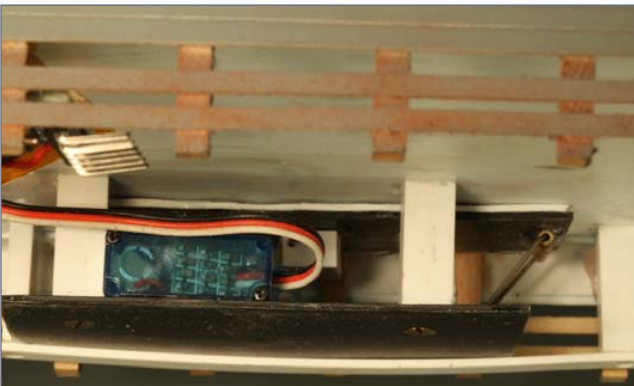

106. The dock platform with the magnets in the raised position.



Again the solution was to forcibly increase the gap mechanically, with a servo motor-driven platform covered with thin rare earth magnets (1/16 x 5/16). You can see the solution in [104 -107]. The “hinges” are made from stiff 0.025” wire (brass, phosphor bronze, or steel) formed into a rectangle and inserted top and bottom into 1/16 brass tubes glued in place.

The servo arm is attached to the underside of the platform and is controlled by an Arduino Pro Mini. I can even use the multifunction Arduino decoder described here: [mrhmag.com/node/20739](http://mrhmag.com/node/20739). Now instead of turning an electromagnet on and off, you simply raise or lower the magnet platform under your loading dock.

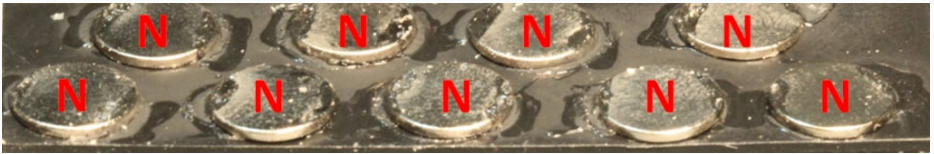

107. Weak field magnet grouping.

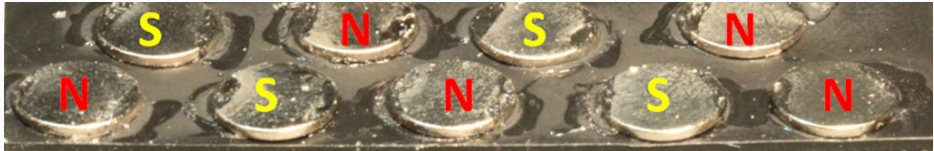

108. Strong field magnet grouping.



109-110. Inside the crate with the magnet in the up position on the right, and in the down position on the left.

# MOVING CARGO WITH YOUR CRANE

*CONTINUED ...*

As things would happen, there was one last problem to solve. When I made the first magnet platform, it worked very poorly. This made absolutely no sense until I happened to drop a crate on the edge of the platform and it grabbed the crate like glue. Moving the crate to the obvious middle of the platform had little effect. What was going on? The first platform had an even array of magnets placed so that all were mounted with the same polarization – all with the same pole up.

The resultant magnetic field in the middle of the array had only a weak interaction with the steel in the crate. The solution was to alternate the magnets' orientation in the array – north/south – across the platform. This worked very well. It also enables me to build as large a platform and “landing area” for my crates as I liked, allowing multiple crates to be placed and removed from the loading dock. However, these magnets are quite strong. When I place several crates across a large platform, I need a servo strong enough to pull the magnets down from all the crates above. Some experimentation is needed if you want a large platform capable of receiving many crates simultaneously.

The sequence of events would typically be: 1. Have your crane pick up and carry a crate to the loading dock, 2. Lower the crate onto the dock above the lowered magnet platform, 3. Raise the magnet platform under the loading dock, 4. Lift the hook away from the crate, 5. Lower the magnet platform, leaving the crate in place. The crate is ready to be picked up and moved somewhere else as well. Now you really can realistically move cargo on your layout! ■

## DR. GEOFF BUNZA



Geoff started as a Model Railroader when he received a Mantua train set for Christmas, at age 6. Interest in the New York Central was cemented when riding on a NYC fan trip to Harmon in November, 1966 behind S-Motor 110. He fed his interests through college becoming a member of the Tech Model Railroad Club (TMRC) at MIT while getting his doctorate and three other degrees in Electrical Engineering.

He models the New York Central Railroad, the Great Northern Railway, and Maine narrow gauge in HO<sub>n</sub>30. Scale model animation in HO is one of his great interests.

Geoff has authored numerous articles on animation for *Model Railroad Hobbyist*, the *New York Central System Historical Society Modeler Magazine*, and *Railroad Model Craftsman*. He has presented clinics for the NMRA at Division, Regional and National meets, and the National Narrow Gauge Conventions.

He is blessed with his wife, Lin, in marriage for 36 years and their two terrific sons. He is a life member of the NMRA and holds an Extra Class amateur radio license. ■



# A do-it-yourself HO scale wheel mask

BY RONALD I. BRILL

## *A simple wheel mask for your painting tasks ...*

**I HAVE TO CONFESS: I LOVE JIGS!** AS A GARAGE woodworker, I have made numerous jigs in order to make cutting, routing, and similar repetitive tasks easier and more uniform in result. As a model railroader, I have a similar interest in such aids for use with my benchwork efforts.

I recently completed the conversion of all of my rolling stock wheels from plastic to metal, specifically, the Intermountain brand 33" semi-scale wheels, which easily lend themselves to a variety of direct-fit applications and car-lighting projects. Much of my rolling stock comes from swap-meet purchases of both built and un-built Athearn blue box, Accurail, Bowser, and





[Click here for  
reader comments](#)

Roundhouse kits. I even have an old Mantua car here and there. Now they all have Intermountain metal wheels.

Many modelers paint and weather the faces of their wheels, giving them a more realistic rusty dirty appearance. I felt that I was ready to join them in this task, but I did not relish the thought of hand-painting each and every wheel for over 100 cars, as well as over 30 diesel units.

Several companies offer ready-made wheel masks, but I found these were limited by their capacity. I had over 400 wheels to paint! My solution was to design a jig, using easily available materials, which would enable me to speed up the task a bit.

The drawing on the next page shows the jig design.

The required materials are:

- 1 - 7"x12" x 0.060" styrene sheet (I used Plastruct item # 91105)
- 3 - Regular slotted or Phillips-head machine screws (#8), 1-1/2" in length ( fully-threaded/ coarse)
- 9 - flat metal washers, for #8 bolt.
- 12 nuts (coarse thread)
- double-stick tape
- 25/64" drill bit ( for Intermountain 33" metal wheels – size may vary for other types/sizes)
- 3/16" drill bit

# HO WHEEL MASK | 3

I started by measuring and cutting two 6" x 4" sheets from the larger styrene sheet. Using the reverse side of an X-Acto knife, I scored the cut lines about  $\frac{3}{4}$  of the way through the sheet and then snapped along the scored line to separate the pieces. I chose 0.060" styrene to avoid bending it with repeated use (spreading the two sheets apart to insert wheels) [1-2].

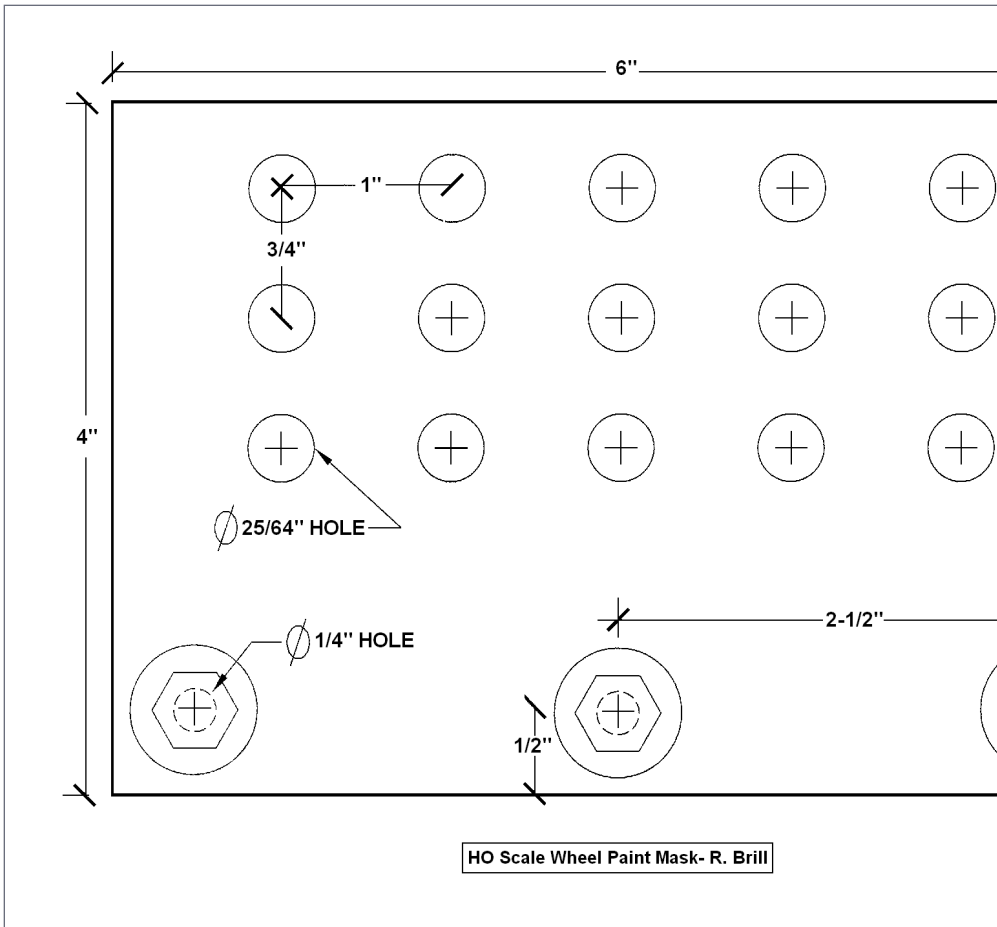

Wheel mask drawing.

## HO WHEEL MASK | 4

Next, I faced the inside perimeter of one of the 6" x 4" sheets with double-stick tape to attach the two sheets together temporarily for marking and drilling. This gave me uniform parallel holes in each sheet [3].

I used a drafting circle template with various-sized circles to determine the best hole size for the wheel cut-outs. In my case, a 25/64" hole worked best. I then located centers for a series of

three rows of five holes each on one sheet's face (you can vary both the size and the number of holes as well as their arrangement to suit for different-sized wheel diameters and gauges).

Here, it is best to put some masking tape on the sheet first, so measurement marks and pencil lines may be drawn easily. I measured and drew vertical and horizontal lines to locate evenly spaced center points. A drafting circle template has four tick marks at 90 degrees from each other on the edge of the circle cutouts. This enabled me to precisely line up the circle at each center, using the criss-cross lines I drew first [4].

I then located drill centers for the wheel and screw holes by

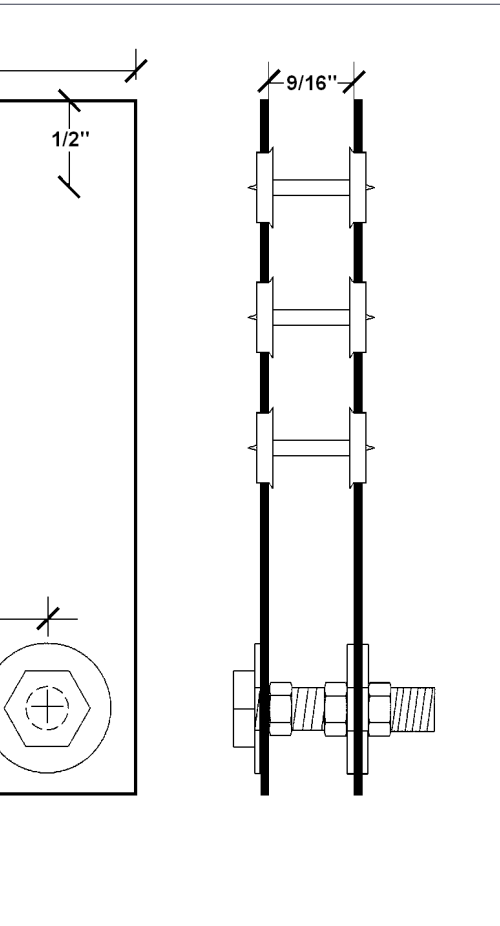

# HO WHEEL MASK | 5

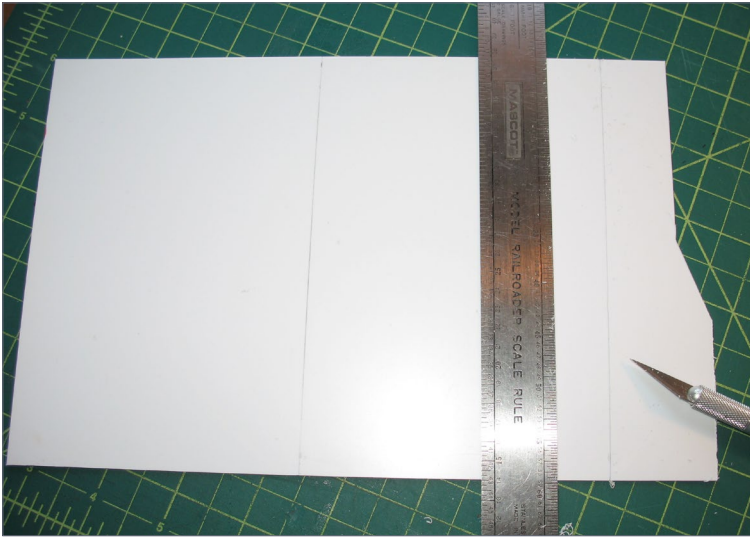

1. A plastic sheet is measured and cut with a hobby knife.



2. Both finished wheel mask sheet blanks, 4" x 6".



# HO WHEEL MASK | 6

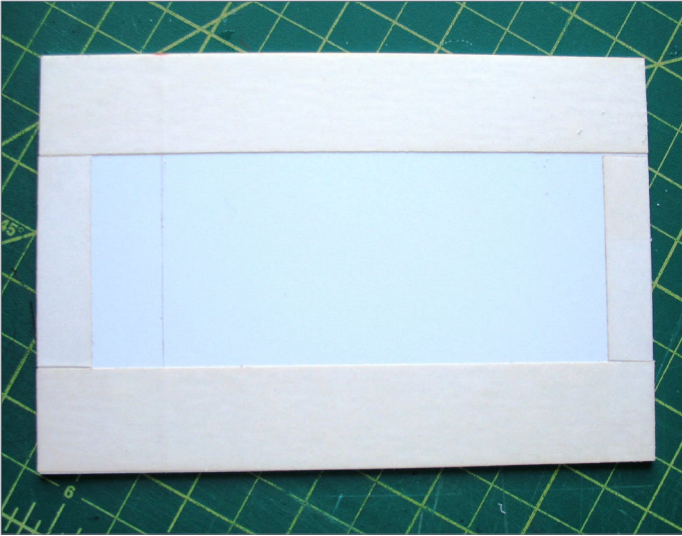

3. Double-stick tape applied to one sheet, to be attached to the other.

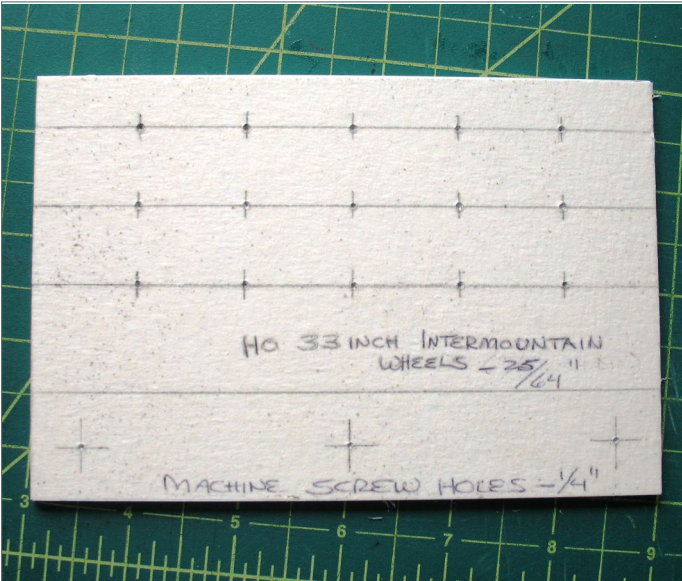

4. Top of one side of sheet set, covered with masking tape, measured and marked for drilling. Note small dimples at center points.

## HO WHEEL MASK | 7

using a pointed nail punch. If you don't have one, use a sharp-pointed drywall screw. Locating center points (dimples) for the drill bit in the plastic prevented the drill from wandering and ensured that the drilled hole was properly located, as measured.

I drilled a test hole with the 25/64" bit in a scrap piece of styrene and test-fit a wheel to confirm the correct hole size before starting on the jig sheets. The small 3/16" attachment screw holes were drilled separately. I used three #8 machine screws for my attachment holes, which require a 5/32" drill bit, a 3/16" will do just fine.

After sizing the drill bits for the holes, I then used double-stick tape again to cover the unmarked side of the plastic sheets, and carefully attached the two-sheet set on the scrap wood. A wood backer is needed to prevent the drill bit from tearing the plastic as it exits the second sheet [5].



5. Double-stick tape applied to full face of plastic sheet set, to be attached to scrap wood base.

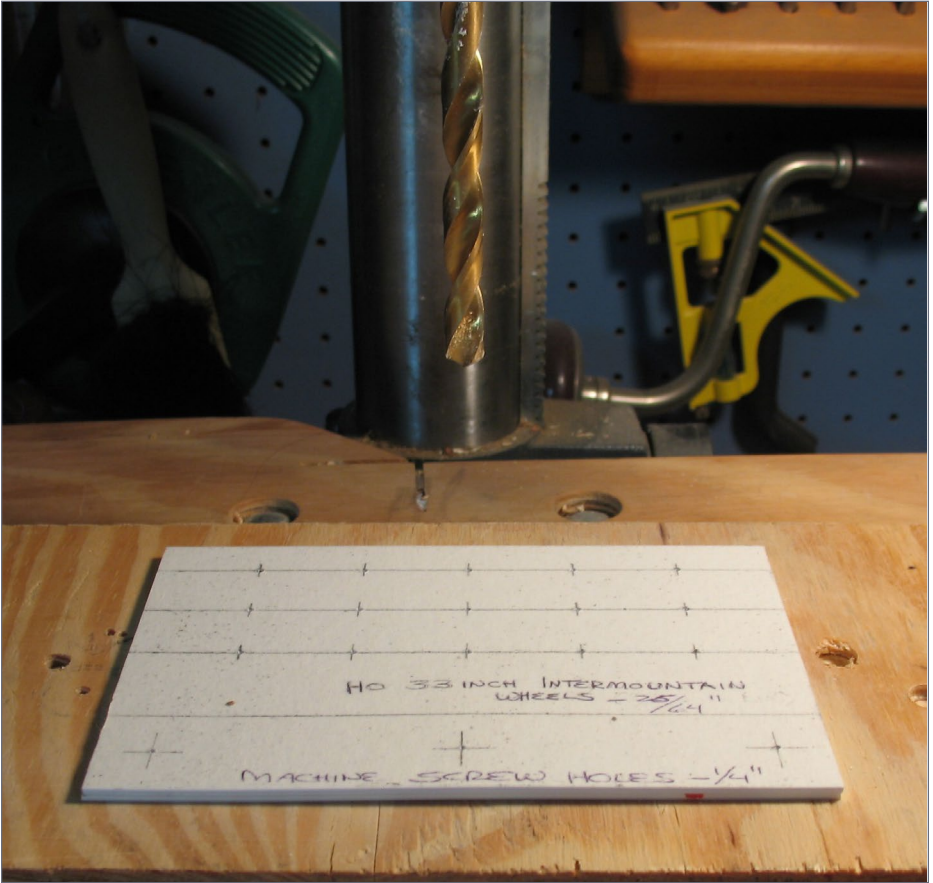

6. Marked sheet set positioned on scrap wood ready for drilling.

I then held the scrap piece positioned properly on the drill press table, as the double-stick tape worked well for keeping the sheet blanks attached to the scrap wood piece. I drilled all wheel holes in one operation, being careful to find each center mark before drilling. Be sure your scrap wood piece is not too large to enable you to re-position it to place each center mark directly below the drill bit [6-8].

# HO WHEEL MASK | 9

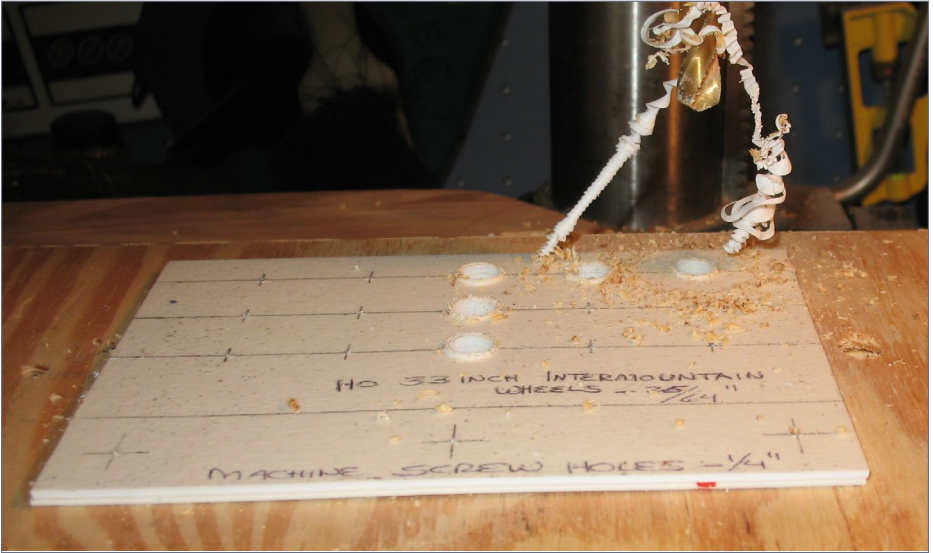

7. Drilling wheel mask holes.



8. Wheel mask holes completed.



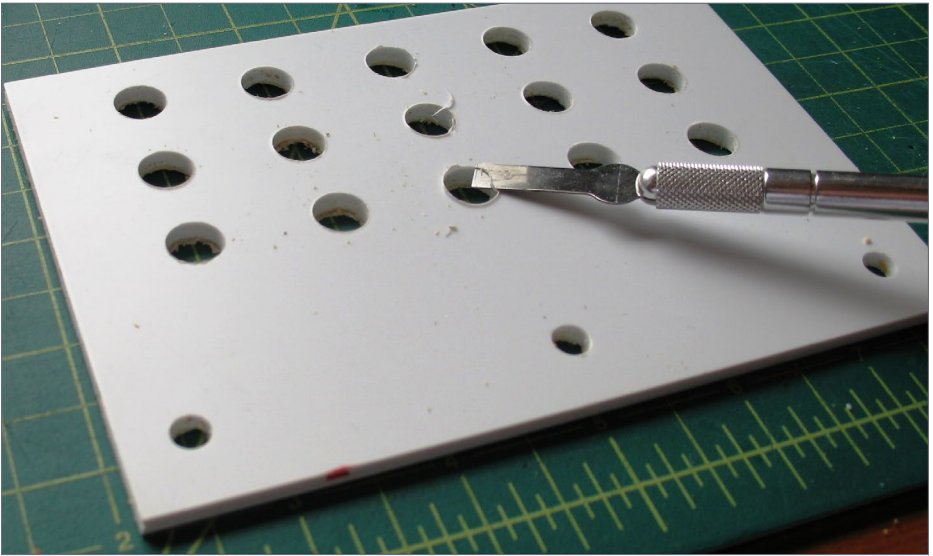

### 9. Removing drill ridges from holes with chisel-tip hobby blade.

Once I finished drilling all the holes, I peeled off the double-stick tape from the scrap wood side, the masking tape from the drilled side, and the remaining double-stick tape from the “sistered” sheets. I also carefully pried the styrene sheets apart with a narrow paint scraper, so as not to gouge them. The drilling of the styrene creates a slight raised rim around each hole on both sides of each sheet. I used an X-Acto chisel tip to cut the raised edge off each hole on each side of the plastic sheets.

I then gently cleaned the inside of each mask hole with the edge of a regular X-Acto blade from the interior side of each hole, enabling the wheels to slip into the holes more easily. Be careful so the holes are not enlarged. Finally, I used 120-grit sandpaper wrapped around a flat wood block to clean and even-up the edges of the sheets on all four sides and to remove any plastic shreds or burrs. [9]

## HO WHEEL MASK | 11

With the sheets ready, I assembled the machine screws, washers, nuts in the following order: machine screw – washer – 1st plastic sheet – nut – nut – washer – 2nd plastic sheet – washer – nut. I spaced the two internal nuts for the proper thickness required for the mask to hold the wheels at the lowest line of mask holes, about 9/16”, then hand-tightened the last nut.

I recommend only hand-tightening of the jig, so it can be disassembled if necessary and to avoid putting stress on the plastic sheets where the fasteners are. Once I was sure that this width had been obtained, I test fit wheels into the holes. The reason for choosing .060” thick material is so the tire of each wheel is covered by the thickness of the plastic [10].

The spacing and the material thickness of the styrene are sufficient to allow for slightly bending the sheets to place and

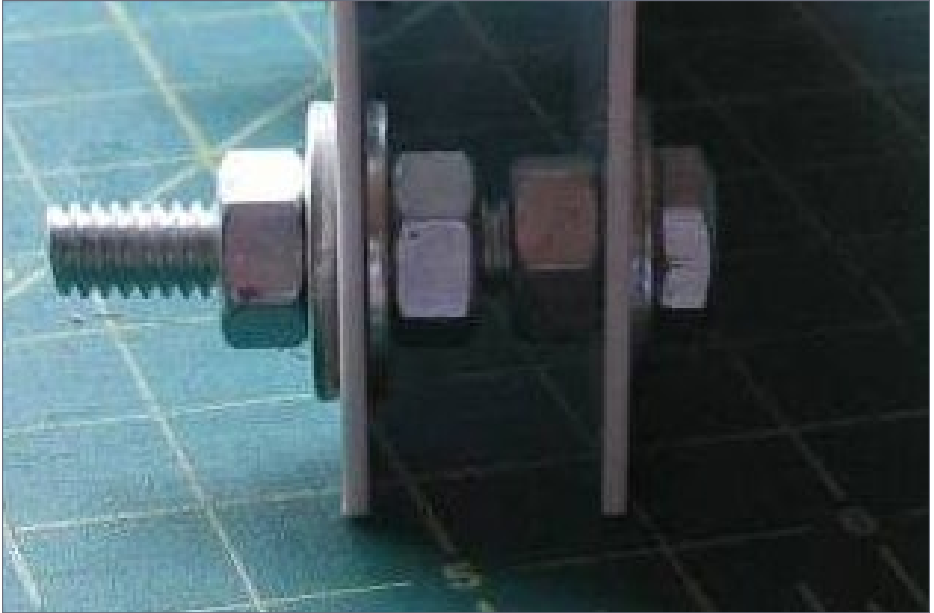

10. View of fastening parts order of assembly.

# HO WHEEL MASK | 12

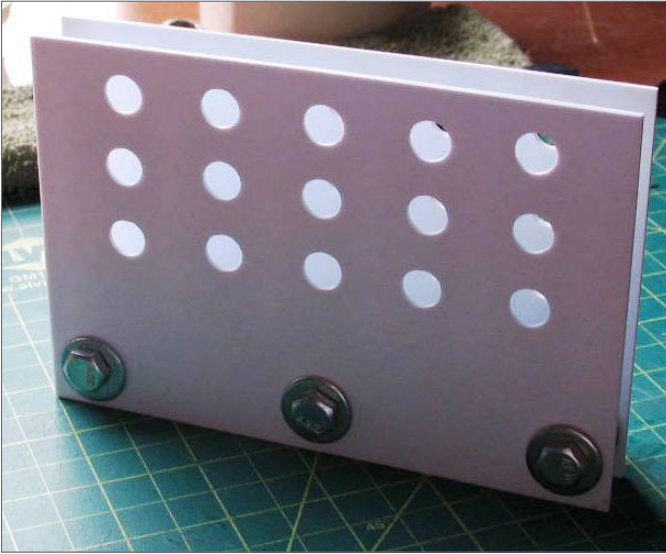

11. Assembled wheel mask front view.

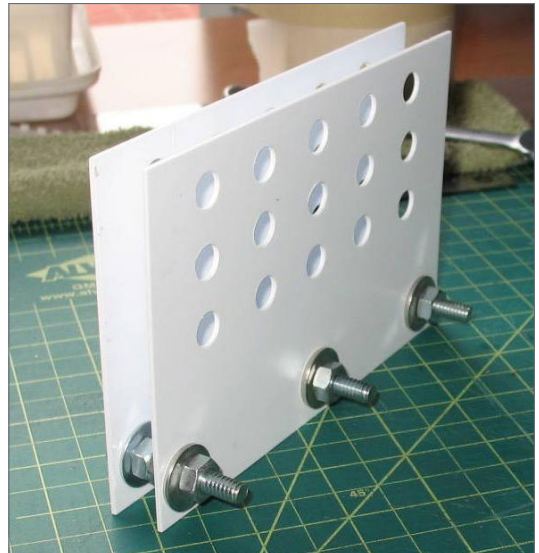
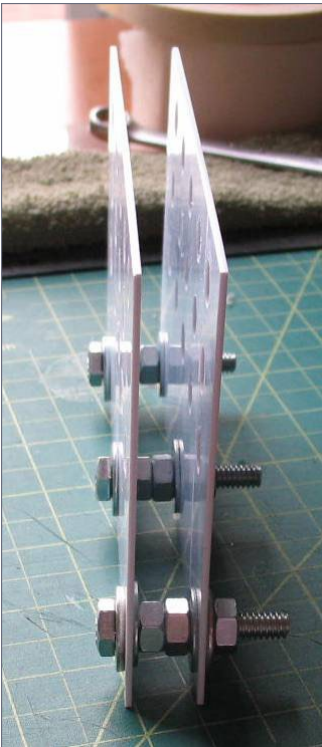

12. (Left) Assembled wheel mask side view.

13. (Above) Assembled wheel mask rear view.

## HO WHEEL MASK | 13

remove the wheels without breaking the plastic. Also the washers provide additional reinforcement in this regard. The distance between the internal nuts can be varied, with some disassembly, to more accurately secure the wheels in place for painting and weathering.

For best practice, place the wheels in each hole, starting from the bottom row if using all holes, or just those near the top if a smaller number of wheels are to be painted. On my configuration, the top portion of the sheet flexed a bit outwards when wheels were inserted in the lower two rows, despite some changes in the distance between the two internal nuts. So I secured the top of the jig with some small pieces of masking tape and then made sure all 15 wheels were properly seated. I



14. Wheels inserted into wheel mask ready to paint, front view.



## HO WHEEL MASK | 14



15. Wheels inserted into wheel mask ready to paint, side view.

can use the two lower rows without using the tape, but with a lot of wheels to paint, doing fifteen of them at one time is faster.

Although I made this jig for HO scale, it can easily be modified for use in other scales as well. The jig can be modified both in terms of the number of wheels and the size of the holes. I recommend a thicker plastic be used for larger scales, along with a wider space between the two mask sheets, and a wider distance between holes so as to properly cover the tire of the wheel.

Enjoy your wheel mask jig; happy painting and weathering!



[Click here for reader comments](#)

# TrainMasters TV ...

Cast your vote for *MORE* Network-TV level video programming for model railroading from MRH



**Become a TMTV member today**



Brought to you by



**MRH** *Exceptional Model Product* **PRODUCT SHOWCASE** 

→ Visit [ExactRail.com](http://ExactRail.com)



**Click here for  
reader comments**

## N Scale: TTX Trinity 6275 Plug Door Box Car



1. Beginning in 2004, TTX began receiving Trinity Industries Inc. 50'-6" Hy-cube boxcars. With a fleet of over 600 Trinity-built cars, and over 1100 similar cars built by NSC and Gunderson, this 1995+ era car is everywhere.

Features Athearn 100-ton trucks and ExactRail's N-scale 36" wheels.

▶ **EXCEPTIONAL MODEL PRODUCTS PAST, PRESENT OR FUTURE**

• [INDEX](#)

• [TABLE OF CONTENTS](#)

→ Visit [ExactRail.com](http://ExactRail.com)



Click here for  
reader comments

## HO Scale: TTX Trinity 6275 Plug Door Box Car



2. TTX Company began receiving Trinity Industries Inc. 50'-6" Hy-cube box cars in 2004. Trinity built over 600 cars. There are over 1100 similar cars built from NSC and Gunderson, so this 1995+ era car can be found everywhere.

ExactRail's model features stand-off detail, including separate door tracks, separate plug door bars, etched stainless steel cross-over walks, and wire formed grab irons. Furthermore, the car features steel nailable flooring that is recreated with ExactRail's narrow draft box with shank wedges, striker casting and full nut and bolt detail. The FBOX rides upon ExactRail's 100-ton ASF 'Ride Control' trucks.



→ Visit [AtlasTrainman.com](https://www.atlas-trainman.com)



Click here for  
reader comments

## HO Scale: WRWK Evans 52'6" Gondola



3. In 1975, the Southern Iron and Equipment Co. started building a 52'6", 100-ton gondola. Evans took over SIECO and continued building the cars through December 1981. A total of 1,730 cars were built with three minor body variations. This model represents the second version, and the most common.

The Atlas Trainman line model, features molded-on details on the car sides and underframe. The car comes equipped with AccuMate knuckle couplers and with trucks having 36" metal wheels on plastic axles in plastic sideframes.

This car is decorated for the Worcester Model RR club, WRWK.

→ Visit [ExactRail.com](http://ExactRail.com)



[Click here for reader comments](#)

## HO Scale: UP PS 7315 Waffle Box Car



4. In 1974 Pullman-Standard's Bessemer, Alabama plant began to manufacture the 7315 cubic capacity "waffle" boxcar for the Norfolk and Western Railway. Production continued with additional deliveries to the Santa Fe, Milwaukee Road, Union Pacific and Detroit, Toledo and Ironton. The P-S Waffle Box Car continues to serve Class 1 railroads to the present.

ExactRail's model features stand-off detail, etched stainless steel cross-over walks, and wire formed grab irons. The car also features steel nailable flooring using ExactRail's narrow draft box with shank wedges and full nut and bolt detail. The car rides on ExactRail's 100-ton ASF 'Ride Control' trucks.

# Take the MRH 2016 Reader Survey ...



fireHD10  
OUR LARGEST  
DISPLAY  
— ON OUR —  
THINNEST TABLET

amazon

... and get a chance  
to win a 10" Kindle  
Fire tablet!

**TAKE THE SURVEY >>**

## ADVERTISEMENT

### An excellent new book about freight cars!

#### American Car & Foundry Box Cars, 1960-1981



Edward S. Kaminski

Ed Kaminski, noted freight car historian, presents a rich collection of build-er and in-service photos for ACF box cars built from 1960 to 1981.

How can I learn more about this book?  
How can I buy it?

**Click here for  
the answer ...**

*SIGNATURE PRESS*

• INDEX

• TABLE OF CONTENTS

**The Fine Scale  
Model Railroader Expo**

DANVERS, MA

**2016**

**MARCH 31 - APRIL 2\***

**\*VENDOR SHOW 4/1-4/2**

**FIND OUT HOW TO WIN  
\$1000 CASH**

**IN THE EXPO MODEL CONTEST**

**CLICK HERE FOR MORE INFO**

**CLINICS - LAYOUT TOURS - DISPLAYS  
VENDOR SHOW - AWARDS DINNER**

**MODELRAILROADEXPO.COM**



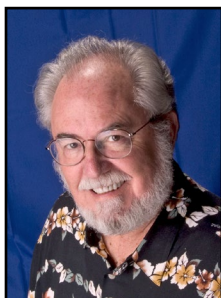

# JANUARY NEWS

column

RICHARD BALE *and* JEFF SHULTZ



Click here for  
reader comments

## Industry news



**Stanley Rydarowicz**, a well-known prototype modeler and parts supplier, died of a heart attack December 4, 2015. Stan, a native of Youngstown, OH, was 64 years old. He was a long-time activist in prototype modeling and offered a distinctive assortment of cast resin specialty items for modifying selected HO scale freight car kits. Although future availability is pending, Stan's product line continues to be listed at <http://www.sunshinekits.com/stanpage.html>. Stan frequented numerous prototype modeler's events and was scheduled to make a presentation in Florida this month at the Cocoa Beach meet. In addition to model railroads, Stan was an avid gardener and fan of old cars. He frequently displayed his restored 1954 Packard

► THE LATEST MODEL RAILROAD PRODUCTS, NEWS & EVENTS

## JANUARY NEWS | 2

Clipper at car shows. He held a master's degree in business management from Youngstown State University. Stan worked as a driver for the Coca-Cola for 46 years. He loved to drive, and after retiring from Coca-Cola in 2013, he continued his passion as a driver for O'Reilly Auto Parts. Stanley was a bachelor and leaves no immediate family members ...

**M.T.H. Electric Trains** has issued a recall on the 2015 production run of O gauge RailKing Smoking Tank Cars. The problem involves potentially defective circuit boards that can overheat, and may cause failure to the car, the track, and the layout. The products are identified as MTH item No. 30-73431 and No. 30-73432. If you own either of these two cars M.T.H. has requested that you, 1) cease using the car immediately, 2) remove the car from your model railroad layout and, 3) return or ship the car back to the M.T.H. Authorized Retailer from whom it was purchased for a full refund. Previously released RailKing Smoking Tank Cars with different item numbers are not affected by this recall. The availability of replacement cars is expected to be announced in mid-2016 ...

The **RailPro User Group** has a new forum at [rpug.pdc.ca](http://rpug.pdc.ca). The group provides a place for users of Ring Engineering's RailPro wireless control system to offer peer support and share ideas with other RailPro users ...

**Digitrax** has reorganized the hours and operation of its user help desk. The regular hours of the help desk are Monday through Friday 8 a.m. to 12 p.m. (closed one hour for lunch) and 1 p.m. to 5 p.m. Central Standard Time. To contact the help desk go to [helpdesk.digitrax.com](http://helpdesk.digitrax.com) ...

.....

## NEW CLUB PRODUCTS



The **New York Central System Historical Society** is selling N and HO scale kits for a standard NYCS Signal Station (above left). The design is based on an early 1900s structure with 13 trackside windows. The kits feature laser-cut vinyl brick work, mat board concrete sections, and laser-cut basswood upper sections. Stairs and landings, window glazing and other details are all included. The kits are produced under contract with The N Scale Architect with technical and historical guidance from the NYCSHS Modeling Committee.

The Society is also selling a wooden tower (above right) based on an NYCS/B&A standard from the late 1800s. Variations of the tower were used on the Boston & Albany and several New York Central System divisions including the Harlem, Putnam, West Shore and Hudson divisions. For additional information visit [nycshs.org/2015/12/14/nycs-lines-east-brick-towers-in-ho-and-n-scale](http://nycshs.org/2015/12/14/nycs-lines-east-brick-towers-in-ho-and-n-scale).

.....

## NEW PRODUCTS FOR ALL SCALES

**Brunel Models** sells lots of interesting tools for hobbyists including a Corrugated Iron Maker. This simple tool can be used

# JANUARY NEWS | 4

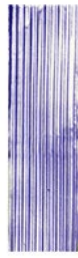
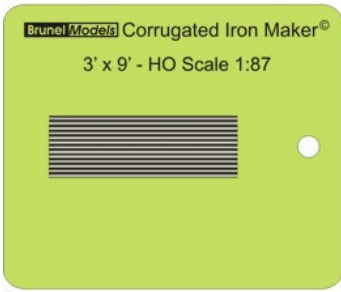

to make sheets of corrugated iron using aluminum foil. The two-part tool consists of a base with a corrugated iron profile cut into it and a mating surface tool. The item is available in appropriate sizes for N through G scale. For complete information visit

[brunelhobbies.com.au/ironmaker/ironmaker.htm](http://brunelhobbies.com.au/ironmaker/ironmaker.htm).

---

**Dallas Model Works** is selling custom laser-cut signs that are



suitable for identifying an industry, a retail store, the name of your railroad, or a train station. They can accommodate from 3 to 15 characters. The custom signs can be finished to look like

wood, concrete, or steel. The assembled signs are 0.44-inches high and range from 1.5 to 5.625-inches long, depending on the number of characters. The signs are supplied as a kit and include a base, a sub-base, an outer lip, the letters, and a template to guide mounting the letters. For additional information visit [dallasmodelworks.com](http://dallasmodelworks.com).

---

Author **David Leider** has completed a book titled *Pickle and Vinegar Makers of the Midwest*. Leider has presented modeling clinics about pickle and vinegar cars and has written articles on the subject for several hobby magazines. The 8.5 by 11-inch



# JANUARY NEWS | 5

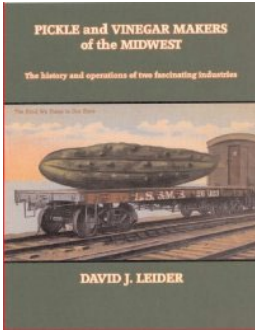

soft-cover book presents the history of the pickle and vinegar industry in the United States including the rise, fall and merger of numerous companies.

A description of the manufacturing process of both pickles and vinegar is detailed along with chapters and plans on pickle and vinegar cars. The 140 page book has over 190 photos, 31 maps and 68 drawings and illustrations. The book is available at \$32.95 plus \$4.25 for shipping and handling from David Leider, 601 N. Elmhurst Road, Prospect Heights, IL 60070. For additional information visit [vinpic.dhke.com](http://vinpic.dhke.com).

.....

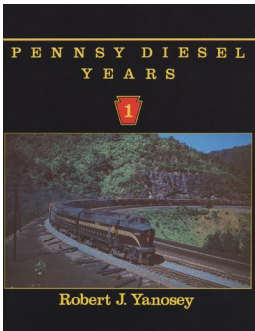

**Morning Sun Books** has released *Pennsy Diesel Years Volume 1* as a PDF digital reprint. Originally released as a traditional paper book in 1988, author Robert Yanosey examines the PRR diesel fleet in operations from North Jersey to Chicago. This 160 page book covers everything from the smallest switchers to the PRR's amazing

Baldwin Centipedes.

Also re-released as an e-book is *Milwaukee Road Power in Color* by Steve Timko. The book presents both color and black-and-white photos of the diesel and electric fleet of the Chicago, Milwaukee, St. Paul & Pacific Railroad. Timko presents more than 300 images of the Milwaukee Road's fleet in both action and roster views. For additional information visit [morningsun-books.com](http://morningsun-books.com).

.....

## O SCALE PRODUCT NEWS

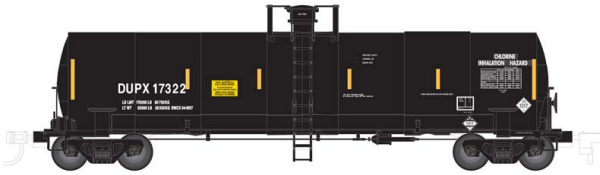

**Atlas O** plans to deliver this ACF 17,360 gallon tank car in six decorating schemes during the third quarter

of 2016. The O scale ready-to-run model is based on a general service insulated tank car built by American Car & Foundry primarily for transporting chlorine. Road names will be Dow Chemical (shown here), ACFX (ex-ARIL repaint), Dana Railcare, E.I. DuPont, Occidental, and General American. Each scheme will be available in two road numbers.



Also due from Atlas O in the third quarter is a Trainman series 40-foot boxcar based on an all-steel car American Car & Foundry introduced in

the late 1940s. Like the prototype, the O scale model is equipped with Youngstown sliding doors, diagonal paneled roof, and Improved Dreadnaught ends.

In addition to the New York Central “Pacemaker” scheme shown here, the ready-to-run model will be available decorated for Southern Railway, Rutland, CP Rail, Santa Fe “Grand Canyon Line” and “Ship & Travel Santa Fe,” and U.S. Air Force. Two numbers will be available for each road name. Atlas O rolling stock is available for both 2-rail and 3-rail operation. For additional information visit [atlaso.com](http://atlaso.com).

.....

**Rusty Rails** is selling a new cast resin junk pile for use in O scale scenes. All of the junk pictured is a one-piece casting mounted

# JANUARY NEWS | 7



on a base that measures 3.75 by 2- inches. The casting comes unpainted. For additional information visit [rustyrails.com](http://rustyrails.com).

## HO SCALE PRODUCT NEWS

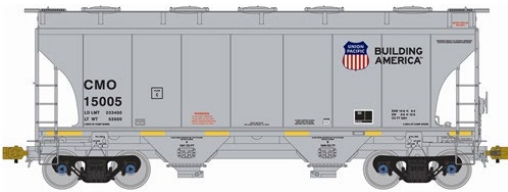

**American Limited Models** is booking reservations for a second production run of its highly rated Trinity 3281

cu. ft. two-bay covered hopper car. Spotting features that distinguish this car from earlier Trinity designs include the overhanging arched roof, heavy top reinforcement chord, and folded jack pads at the bolsters. Features of the HO scale ready-to-run model include wire formed grab irons, photo-etched roof walk and coupler platforms, and scale-size working lower-shelf couplers. Road names on this run, which is due late this summer, will be ICE-GATX, NRLX-Ciment/Quebec, WW-Winchester & Western, and HWCX (pink scheme). The above image is from a previous run. Products manufactured by American Limited Models are distributed by InterMountain Railway. For additional information contact your dealer or visit [intermountain-railway.com](http://intermountain-railway.com).

**Athearn** has announced their production schedule for models scheduled for release next October. Heading the list is a

# JANUARY NEWS | 8



group of Genesis series GP7/GP9 A and B diesel locomotives. The HO scale GP7/GP9s will be decorated for Erie, Santa Fe, Western Maryland, and Denver & Rio Grande Western.



The production run includes a cabless Santa Fe GP9B unit (above).



Athearn's list of HO scale Ready-to-Roll motive power coming next October includes five P40DC/P42DC locomotives. Phase V units with a bolted-on nose will be available for Amtrak and Amtrak Big Game Train (above). Units with a standard nose will be available for Amtrak Phase III, Amtrak Phase III with fading stripes, and a former Amtrak Phase V locomotive decorated for Connecticut Department of Transportation.



Several versions of a Ready-to-Roll SD39 diesel are also on the October schedule. Decorating schemes include Illinois Terminal



# JANUARY NEWS | 9

(above), Norfolk & Western, Southern Pacific, Santa Fe (blue and yellow), and Minneapolis, Northfield & Southern. All Athearn locomotives are available for standard DC operation or with factory installed sound and DCC decoder.

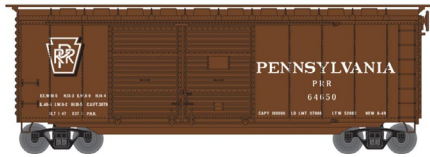

HO scale rolling stock coming next October includes a pre-war 40-foot boxcar designed for automobile service with two Youngstown sliding doors. In addition to the PRR car shown here, road names will be Great Northern, Burlington Northern, Milwaukee Road, Soo Line, Western Pacific, and Union Pacific. Also three Santa Fe cars with Super Chief, El Capitan, and Grand Canyon schemes with Santa Fe's Ship & Travel slogan on the opposite side.



North American Car Corporation's unique 8,000 gallon tank cars were specifically designed for transporting smaller batches of various liquid commodities. They were regularly spotted across the nation from the 1960s through the 1990s. In addition to the American Maize car shown here, Athearn's HO scale version will be available next fall decorated for Emery, Hercules Powder Company, Wyandotte Chemicals, GATX, and Shell Oil.



A GATC 2600 cu. ft. single-bay Airslide covered hopper car will also be

# JANUARY NEWS | 10

released in October. The HO scale Ready-to-Roll line model represents one of the original 1953 General American Transportation Airslide 70 ton cars. Road names will be Domino Sugar, Santa Fe, Southern Pacific, Soo Line, and Chicago South Shore & South Bend.



Also shown on Athearn's October release is an HO scale NACC 1960s-

era 50-foot outside-post insulated boxcar. Road names will be Central Railroad of New Jersey, Chicago & North Western, Hamm's Beer, Trona Railway, and Denver & Rio Grande Western.



A 20-foot double-axle container chassis is also set

for release in October. They will be sold in pairs and decorated for OOCL (above), P&O, Flexivan, TRAC, K-Line, and P&O Nedlloyd.



Athearn-Roundhouse brand items due next fall include this 5283 cu. ft. FMC

50-foot double sliding-door boxcar. Decorating schemes include Minneapolis, Northfield & Southern; Arkansas & Missouri Railroad; Bangor & Aroostook; Burlington Northern; BNSF Railway; Canadian National; CIT Rail Leasing; Dakota, Minnesota & Eastern; and Southern Pacific (ex-Golden West).

Completing the list of items set for release in October is an Athearn-Roundhouse 50-foot flat car with stake pockets.

# JANUARY NEWS | 11



Road names will be Rock Island,

Santa Fe, Central Railroad of New Jersey, Chesapeake & Ohio, Southern Pacific, and Union Pacific. For additional information on all Athearn products contact your favorite dealer or visit [athearn.com](http://athearn.com).

.....

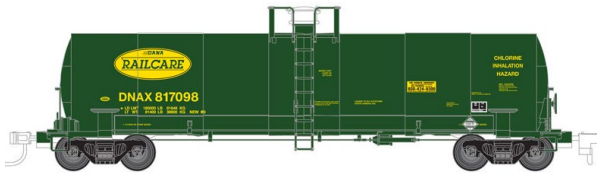

**Atlas** plans to deliver this ACF 17,360 gallon tank car in seven decorating schemes

during the third quarter of 2016. The HO scale ready-to-run model is based on a general service insulated tank car built by American Car & Foundry primarily for transporting chlorine. Road names will be ACFX (ex-ARIL repaint), Dana Railcare (shown here), Dow Chemical, E.I. DuPont, Occidental (7800 series), CIT Group (TTC conversion car), and General American. Three road numbers will be available for each scheme.



Also coming late this summer is another release of the Atlas Master Line series 1932 ARA boxcar.

Decorated versions will be available for Erie (1945 scheme), Pennsylvania Railroad, Missouri Pacific "Route of the Eagles" slogan, Western Maryland, Soo Line (modern scheme), and Seaboard Air Line Railway (1934-37 scheme).

## JANUARY NEWS | 12

Five undecorated versions will also be offered including long-tab body with a Murphy panel roof and 4/4 Dreadnaught ends (item 20000170), with an 11-panel flat riveted roof and flat riveted ends (item 20000171), and with a Murphy panel roof and flat riveted ends (item 2000915). Also a short tab body, with Viking corrugated roof and Buckeye ends (item 20000321). More information on these products can be found at [atlasrr.com](http://atlasrr.com).

.....



**Bowser** plans to release its new GMD SD40-2 diesel locomotives next month. Eleven iterations of the HO scale model will be available including two Ontario Northland versions with special ONR fuel

tanks, and two British Columbia Railway versions with sun shades and snow plows. These photos of undecorated models highlight some of the variations in Bowser's GMD locomotive.

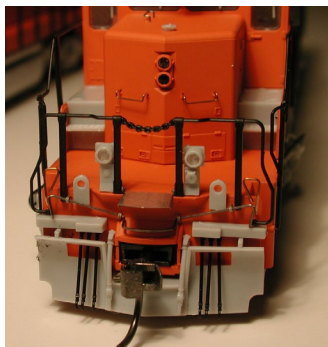
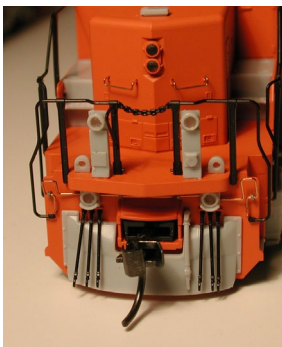

Six different CP Rail versions of the SD40-2 will be available with variations in paint schemes, equipment, and nose length (81- and 102-inch lengths).

A blue and yellow Dakota, Minnesota & Eastern locomotive with working ditch lights and distinctive roof cooling pipes is included in this initial release. For complete details contact



your dealer or visit [bowser-trains.com/history/sd402locoinstock.html](http://bowser-trains.com/history/sd402locoinstock.html).

Long-range plans at Bowser include HO scale versions of an Alco C-415 high-visibility center-cab locomotive. Also the familiar round-nosed Alco RS-3 road switcher, of which more than 1300 were built in the 1950s, including 98 that went to Canadian roads. Tooling for the RS-3, which will have multiple inserts to facilitate different versions of the locomotive, will be cut in Pennsylvania. Pre-tooling design work is almost completed on the C-415. It's OK to get excited but customer-ready models of both locomotives are a couple of years away.

.....



**InterMountain** has tooled a new cushion underframe for its 50-foot PS-1 boxcars. Road names scheduled for release this

month with the new underframe are Detroit, Toledo & Ironton (“Hydroframe-60” slogan); Atlantic Coast Line (“Another Cushioned Load” slogan); Bangor & Aroostook, Chesapeake & Ohio (“Cushion Underframe” slogan); Missouri Illinois (“Cushion Car” slogan), New Haven, TLCX-Transport Leasing (“Cushioned Newsprint Car” slogan); Milwaukee Road (yellow with “Hydroframe 60” on gray door); Milwaukee Road (“Hydroframe-60, 100,000th PS-1” car scheme); Clinchfield, M-K-T (“Hydroframe-60” slogan). The car in the above photo is from a previous run.

InterMountain has modified the tooling on its HT-C diesel trucks to show the traction motor. The new truck with a visible traction motor will be included on all future HO scale

# JANUARY NEWS | 14

releases of InterMountain's SD40-2, SD40-2W, and SD40T-2 diesel locomotives. Information on all InterMountain products can be found at [intermountain-railway.com](http://intermountain-railway.com).

.....



New ready-to-run HO scale freight cars coming from **Kadee** in March include this Vermont Railway 40-foot boxcar with a 6-foot Creco sliding door. The prototype, built in 1955, received this bright red repaint in 1964.

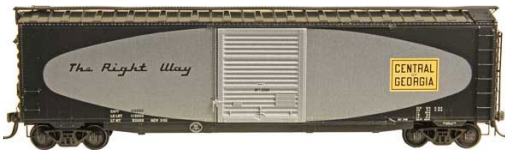

Also due in March is this Central of Georgia 50-foot PS-1 boxcar. It is equipped with a 9-foot Youngstown sliding door. The HO scale ready-to-run model is decorated in the 1956 as-delivered black and silver scheme.



This HO scale SHPX-Shell Chemical model replicates an 11,000 gallon insulated tank car built by American Car & Foundry in 1948. For additional information on Kadee products contact your favorite dealer or visit [kadee.com](http://kadee.com).

.....



Work continues at **Rapido Trains** on the development of accurate HO scale models of the RDC self-propelled rail cars introduced by Budd

# JANUARY NEWS | 15

in 1949. Nearing completion is the RDC-1 (coach), which will be followed closely by the RDC-2 (coach-baggage combine), and RDC-3 (baggage-mail-coach combine). Delivery is anticipated this summer with the reservation/order deadline set at March 1.

Jason Shron of Rapido reports that sales will determine the fate of other RDC models. “If the RDC-1, RDC-2 and RDC-3 sell well, the RDC-9 (trailing coach unit with no cab) will also be produced,” said the Rapido executive. “If the RDC-1, RDC-2 and RDC-3 sell exceptionally well, we will also produce an RDC-4 (shorty RPO/baggage).” Reservation information and a list of paint schemes in the first production run can be viewed at [rapidotrains.com](http://rapidotrains.com).



**Resin Car Works**, a part-time enterprise composed of a group of like-minded prototype modelers, is working on several new HO scale kits for release this year. Projects

include an express box car, at least two tank cars, and a coal-hauling hopper car. A second version of the hopper will have cast-in grab irons (above) to facilitate building a fleet in a reasonable amount of time. Also under consideration are some mini-kits with decals to upgrade Accurail models to follow specific prototypes. For additional information visit [resincar-works.com](http://resincar-works.com).



**Summit USA** is selling an HO scale laser-cut acrylic kit for this Polk County Court House. The assembled structure is 6.75 inches high and has a footprint of 14.5 by 10 inches.



Summit also sells a similar kit for this First State Bank that when assembled measures 4 inches high and has a footprint of 14.5 x 6.5 inches. Both kits are based on actual buildings in Livingston, Texas. All

building parts on the models shown are included in the kits. The kits are composed of laser-cut acrylic, self-adhesive card stock, and milled styrene. Ordering information and a preview of downloadable assembly instructions are available at [summit-customcuts.com](http://summit-customcuts.com).



**Tichy** has introduced four new HO scale fences molded in ABS plastic. Three styles of 4-foot high fences include a picket fence, fancy picket fence, and a rail fence. Also available is a



# JANUARY NEWS | 17

6-foot high board fence. Each section is 6.5-inches long. The fencing comes in packs of five at \$5.00, and in a package of 20 pieces at \$16.00. For information on all Tichy products contact a dealer or visit [tichytraingroup.com](http://tichytraingroup.com).

.....



**Walthers** is selling an HO scale version of a Russell snow plow for several road names including the Maine Central scheme shown here. Other roads include Burlington Northern (box-

car red), Chicago & North Western (yellow), Conrail (yellow), Milwaukee Road (yellow, silver), Pan Am Railways (black), Alaska Railroad (boxcar red), Boston & Maine (blue, black), Canadian National (black), Denver & Rio Grande Western (yellow), and Wisconsin Central (maroon, yellow). The ready-to-run model has positionable side wings and a unique front truck to handle tight curves. Road specific details include wood or see-through metal running board, three styles of headlight, and a solid or roller bearing rear truck.



Walthers plans to release a few Proto series Phase 1 SD9 road diesels in late February. In addition to

the Southern Pacific gray and red bloody nose scheme shown here (1958-65 with hood forward operation), a second SP unit will be available in the road's familiar black widow scheme (1954-61).



The late February SD9 release includes Phase 2 locomotives decorated

# JANUARY NEWS | 18

for Duluth, Missabe & Iron Range (late 1950s to early 1970s with hood mounted bell), and Burlington Northern (1970-1990 green scheme).



Walthers will deliver this classic 30-foot wood caboose in four different paint schemes for the Chicago, Burlington & Quincy Railroad. In addition to the design shown here with a

black boxed herald, the HO scale ready-to-run model will be available in caboose red with a white logo, in Cascade green, and in mineral red. Availability is expected late next month.



Also due from Walthers next month is a SceneMaster 35-foot trailer. This new model will be available decorated for Santa Fe, Bangor &

Aroostook, Chicago & North Western, Minneapolis & St. Louis, Pennsylvania Railroad, and Union Pacific.



Walthers has scheduled a late March release date for its Pennsylvania Railroad Broadway Limited series EMD E8A locomotives. The decorating scheme represents EP-22 units from 1959 with a single bold gold stripe and 17-inch non-extended serif lettering. The HO scale ready-to-run Proto series model will be offered as paired E8A-E8As as well as individual E8A units.

# JANUARY NEWS | 19



Listed on the same late March release date are several 85-foot

PRR Broadway Limited cars including a Budd kitchen/dormitory (above), a Budd 21-roomette sleeper, a Pullman-Standard plan 9009 12-4 sleeper, an ACF 4-4-2 sleeper, a P-S 5-bedroom/lounge, a Budd 68-seat diner, a Pullman-Standard plan 4129 10-6 sleeper, and a Pullman-standard bedroom/buffet/lounge observation car. Also a 70-foot class BM70n RPO/baggage combine. The ready-to-run cars will be available with and without interior lighting.



Several paint schemes have been added to the Mainline series 59-foot quad-bay cylindrical hopper cars

scheduled for release in April. They include Canadian Pacific (double wheat sheaf, above), Canadian Pacific (Canada), Canadian Pacific (blue, Alberta), Canadian National (Canada), Canadian National (single wheat sheaf), and Canadian National (blue, Alberta).

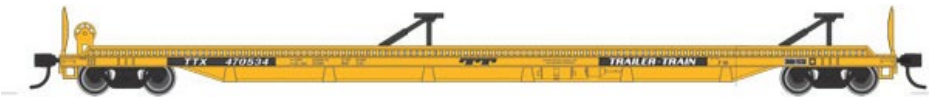

Also coming in April is a Walthers Mainline series 75-foot piggyback flat car. In addition to the Trailer Train/TTX car shown here, road names will be Trailer Train (brown), Trailer Train/ATTX, and Pennsylvania Railroad. For additional information on all Walthers products contact your favorite dealer or visit [walthers.com](http://walthers.com).

## N SCALE PRODUCT NEWS



**Athearn's** delivery schedule of N scale products due next October includes a GATC 2600 cu. ft.

single-bay Airslide covered hopper car. The model is based on one of the original 70-ton General American Transportation Airslide covered hoppers introduced in 1953. Athearn will offer the ready-to-run model decorated for Chicago South Shore & South Bend, Santa Fe, Southern Pacific, Soo Line, and Domino Sugar.



Also coming next fall is an N scale NACC

50-foot outside-post insulated boxcar as introduced in the 1960s. In addition to the Chicago & North Western car seen here, decorating schemes will be Central Railroad of New Jersey, Denver & Rio Grande Western, Hamm's Beer, Uniroyal, and Trona Railway. For more information see your local dealer or [athearn.com](http://athearn.com).

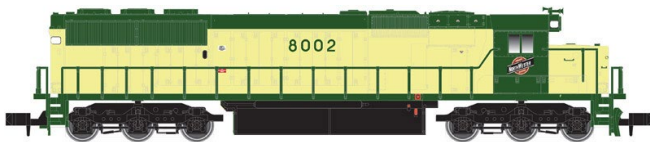

**Atlas** has scheduled a production run of SD60/SD60M diesel

locomotives for release during the third quarter of this year. The N scale SD60 with a three-piece windshield is based on a prototype EMD began delivering in June 1985. The SD60M, with a two-piece windshield and modified nose for improved visibility, was



# JANUARY NEWS | 21

introduced in 1989. Road names for the SD60 will be Chicago & North Western (above), CIT Leasing, GMTX (P&W/Vermont Railway), and Susquehanna.



The SD60M will be available decorated for Conrail, Union Pacific,

Burlington Northern, and Norfolk Southern (above). Undecorated models of both SD60 and SD60M locomotives will be available. The Master series models will be available for standard DC operation and equipped with an NCE DCC decoder.



Atlas is planning a third quarter release for this ACX 17,360 gallon tank car. The N scale

ready-to-run Master series model is based on a general service insulated tank car built by American Car & Foundry primarily for transporting chlorine. Road names will be ACFX (ex-ARIL repaint), Dana Railcare, Dow Chemical, E.I. DuPont, Occidental (7800 series), CIT Group (TTC Conversion car), and General American as seen here. Three road numbers will be available for each scheme. An undecorated model will also be offered.



Another release of the Atlas Master series 1932 ARA boxcar is also coming late this summer.

The N scale ready-to-run model will be available decorated

# JANUARY NEWS | 22

for Missouri Pacific (Route of the Eagles slogan), Erie (1945 scheme), Pennsylvania Railroad, Western Maryland, Soo Line (modern scheme), Roberval Saguenay, and Seaboard Air Line Railway (1934-37 scheme).

Several undecorated versions of the 1932 car are scheduled to be produced. Long-tab car bodies will be available with a Murphy panel roof and 4/4 Dreadnaught ends (item 50000114), with an 11-panel flat riveted roof and flat riveted ends (item 50000115), with a Viking corrugated roof and 4/4 Dreadnaught ends (50000515), and with a Murphy panel roof and flat riveted ends (item 50000516). Also in the mix is a short-tab body with a Viking corrugated roof and Buckeye ends (item 50000151).



A new production run of Atlas Trainman series PS-2 covered hoppers is scheduled for release during the second quarter of this year. Road names for the N scale ready-to-run models will be CSX, Frisco, Rock Island, Wabash, New York Central, and Santa Fe. For additional information contact your favorite dealer or visit [atlasrr.com](http://atlasrr.com).

Reservations are being booked now for fall delivery of two N scale passenger cars from **Centralia Car Shops**. The run includes the first release of a recently tooled Superdome car with individual wire grab irons and truck-mounted knuckle couplers. Road names will be Milwaukee Road, Milwaukee Road/Union Pacific, Great Northern (Empire Builder scheme), Great Northern (cascade green), Great Northern (Big Sky blue), Chicago & North Western, Amtrak (Phase 1 scheme), and Amtrak (fall foliage scheme). Also Holland America Westours,

# JANUARY NEWS | 23

VIA Rail, Canadian National, Ontario Northland, and CSX-Safety Train. An assembled but undecorated model is included in the release.

Scheduled for release in late summer is another run of N scale coaches with corrugated sides. Road names will be Chesapeake & Ohio, Denver & Rio Grande Western, Chicago & North Western, Delaware & Hudson, Seaboard Air Line, Atlantic Coast Line, Southern Pacific (Sunset scheme), Nickel Plate Road, Amtrak (Phase 1), and Norfolk & Western (Tuscan scheme). Products manufactured by Centralia Car Shops are distributed by InterMountain Railway. For additional information contact your dealer or visit [intermountain-railway.com](http://intermountain-railway.com).

.....



**Kato** has two-locomotive sets of EMD F2A and F2B units available now for Atlantic Coast Line, Chicago Burlington & Quincy, Chicago & North Western, and Rock Island.

The N scale models have

DCC friendly mechanisms with both A and B units powered. An introductory video can be viewed at [youtube.com/watch?v=VBKdFhIKohE](https://youtube.com/watch?v=VBKdFhIKohE).

Kato will offer paired sets of EMD F7A and F7B locomotives decorated for Great Northern and Northern Pacific. Single undecorated locomotives are included in the same production run. The closest thing we have to a release date is sometime between now and the end of June. Also in the works at Kato is another production run of SD70ACe locomotives. According to the manufacturer, this run of SD70ACe models will be released in

# JANUARY NEWS | 24

early to mid-2016 at the rate of one road name per month. We don't know the order of the release but the road names will be Union Pacific (flag), CSX (dark future), and BNSF (swoosh). Each will be offered in two road numbers.

The F7 and SD70ACe units will be available for standard analog DC operation. Units with factory installed DCC will be available as a built-to-order item through dealers only. Contact your dealer for details or visit [katousa.com](http://katousa.com).

.....



N scale ready-to-run models recently introduced by **Micro-Trains Line** include this Canadian Pacific 40-foot box car with

Youngstown sliding doors. M-T says it is based on a prototype built in 1937 and was later equipped with roller bearing trucks for passenger train service.



Also new from Micro-Trains is this Providence & Worcester

89-foot tri-level enclosed auto carrier. It follows a prototype built in 1975.

Micro-Trains Line provides a step back in time with a 36-foot wood reefer from the truss-rod era. The car rides on arch bar trucks and is decorated for Nestlé's popular Baby Ruth candy bar. Additional new N scale ready-to-run models from



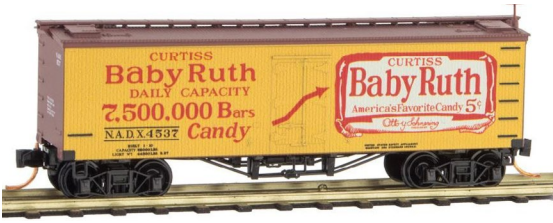

Micro-Trains include a 4-pack of D&RGW 100-ton triple-bay hopper cars with coal loads, and a Great Northern 36-seat

heavyweight diner decorated in Pullman green with gold lettering. Completing the list of recent releases is a group of five heavyweight cars decorated and weathered for MOW service. The 5-pack includes a bunk car (12-1 sleeper), kitchen car (diner), tool and shop cars (baggage cars) and a foreman's car (observation car). For additional information on all Micro-Train Line products contact your favorite dealer or visit [micro-trains.com](http://micro-trains.com).

.....



**Rapido Trains** has released a large selection of N scale 37-foot meat refrigerator cars. The well-executed N scale model faithfully replicates a prototype

built by General American between 1937 and 1941. Although the wood exterior made the prototype look like something from an earlier era, their steel roof hatches, steel underframe, AB brakes, Equipco geared hand brake, and Barber S-1 trucks were actually quite modern for their time. Some continued in service into the 1970s. The reefers were generally assigned to meat service only, providing service between packing houses and regional dealers throughout the U.S. and Canada.

# JANUARY NEWS | 26

In addition to the Oscar Mayer car shown on the prior page, decorating schemes in this first release include American Stores, Armour, Dubuque Packing, DMRX-Deckers, Dugdale, GARX (Abraham Bros, Esterville Packing), Hygrade's, Kingan, Morris Rifkin, NPKX-Nuckolls, Swift (red name block), Swift (red body), Tobin, URTX, and Wilson. Also available are undecorated kits, undecorated assembled cars, and assembled cars painted but unlettered. The N scale ready-to-run model comes with factory-installed Micro-Trains couplers and Rapido's new Barber S1-A trucks with in-line brake shoes and blackened metal wheelsets.



Additional reefers will be available in collector's packs of four cars featuring decorating schemes not

included in the general release. An example of the collector packs is a quartette of Swift reefers from the 1940s with two of the cars in red, white and blue with "*War Bonds*" slogans (above). For additional information on all Rapido products contact your favorite dealer or visit [rapidotrains.com](http://rapidotrains.com).

## NEW DECALS, SIGNS AND FINISHING PRODUCTS

**Dan Kohlberg** has HO scale decal sets for Gulf Mobile & Ohio PS-3 woodchip hopper cars. The decal set is intended for the ex-DT&I cars GM&O rebuilt at their Frascati Shops. For additional information visit [paducah@mindspring.com](mailto:paducah@mindspring.com).

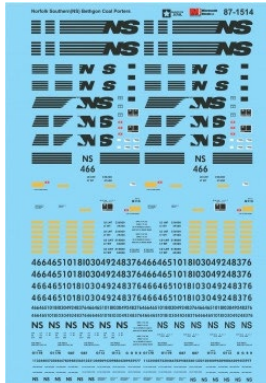
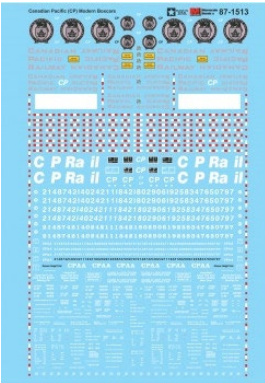

**Microscale** has released new decals for Canadian Pacific and Norfolk Southern. The CP Rail set will decorate a variety of modern boxcars both with and without the Beaver herald including former Rail Box Plate B cars

rebuilt to Plate C dimensions.

The new Norfolk Southern set covers a variety of NS Bethgon Coalporter paint schemes. Extra striping that matches the five paired stripes on variations of the horse head logo are included. They are especially convenient when positioning the NS logo over side ribs. Both of the new lettering sets are available in N, HO, and O scale.

Microscale is selling a special pack that contains 1 ounce bottles of the following eleven model finishing products: Micro-Set, Micro-Sol, Micro-Flat, Micro-Satin, Micro-Gloss, Micro-Weld, Micro-Mask, Micro-Metal Foil, Micro-Kristal Clear, Micro-Liquid Tape, and Micro-Liquid Decal Film. For additional information on all Microscale products contact your favorite dealer or visit [microscale.com](http://microscale.com).

**New England Rail Service** has HO scale decal lettering sets for New Haven non-Pullman passenger cars. These are suitable for coaches and headend equipment lettered with the New Haven's silver-gray lettering and numbers. NERS also has decals for Central Vermont steam locomotives. For additional information visit [newenglandrail.net/products.html](http://newenglandrail.net/products.html).

**i** SEND US YOUR PRODUCT ANNOUNCEMENTS

If you are a hobby manufacturer with a product announcement, just [click here](#) and submit your announcement to us. Our web site and free magazine reach continues to grow, so get on board this new media train! ■  
.....

DISCLAIMER .....

The opinions expressed in this column are those of the writer and do not necessarily reflect the opinion of *Model Railroad Hobbyist* or its sponsors. Every effort is made to provide our readers with accurate and responsible news and information, however, neither *Model Railroad Hobbyist* or the writer of this column can be held responsible for any inaccuracies or typographical errors that may inadvertently appear in this column.



**Click here for  
reader comments**



# Model Railroad Hobbyist *Store*

DVDs and downloadable videos from ...

## TRAINMASTERS.TV



**Titles include:**

- Streamliners at Spencer
- Layout tours-1 & Layout tours-2
- Backdrop painting how-to
- Extreme weathering how-to
- Best of TMTV 2014



Most common comment in our video survey last summer:

*"My internet bandwidth doesn't do streaming very well. Can I get TrainMasters videos on DVD or as a download instead?"*

Our answer: *Yes, now you can! Available from the MRH Store*



Visit [store.mrrhmag.com](http://store.mrrhmag.com)



From the Model Railroad Hobbyist STORE



# SELECTED EVENTS

## January 2016

*(Please note that many events charge a fee. Check individual info website for details.)*

**ARIZONA, TUCSON**, January 8-9, Winter Train Show & Meet, at Tucson Expo Center, 3750 East Irvington Road. Sponsored by Gadsden Pacific Division Toy Train Operating Museum. Info at [gpdToyTrainMuseum.com](http://gpdToyTrainMuseum.com).

**CANDADA, ONTARIO, PARIS**, January 17, Paris Junction Model Train Show, at the Paris Fairgrounds, 139 Silver Street. For more information contact Edward Howes, Train Show Coordinator at 519-442-7193 or email: [ehowes@boardresources.com](mailto:ehowes@boardresources.com).

**DELAWARE, DELMAR**, January 2-3, and 9-10, Open House and swap meet at DelMarVa Model Railroad Club, 103 State Street. Info at [delmarvamodelrailroadclub.org/events.html](http://delmarvamodelrailroadclub.org/events.html).

**FLORIDA, COCOA BEACH**, January 7-9, Prototype Rail Meet at Cocoa Beach Hilton, 1550 North Atlantic Avenue. Hosted by Mike Brock. Info at [prototyperrails.com](http://prototyperrails.com).

**GEORGIA, SAVANNAH**, January 23-24, 27th Annual Model Railroad & Train Show, at National Guard Armory, 1248 Eisenhower Drive. Info at [coastalrailbuffs.org/assets/CRBFlyer2016.pdf](http://coastalrailbuffs.org/assets/CRBFlyer2016.pdf).

**LOUISIANA, MATAIRIE**, January 9, Open House at Crescent City Model Railroad Club, 601 North Lester Avenue. Info at [ccmrc.com](http://ccmrc.com).

## SELECTED EVENTS | 2

**MASSACHUSETTS, WEST SPRINGFIELD**, January 30-31, Railroad Hobby Show, at Eastern States Exposition Fairgrounds, 1305 Memorial Avenue. Sponsored by Amherst Railway Society. Info at [railroadhobbyshow.com](http://railroadhobbyshow.com).

**MISSOURI, ST. CHARLES**, January 16, TrainFair, at Heart of St. Charles Center, 5th and Highway I-70. Presented by St. Charles Model Railroad Club. Info at [stcharlesrailroadclub.org](http://stcharlesrailroadclub.org).

**MISSOURI, ST. LOUIS**, January 9, Model Train Show & Swap Meet at Museum of Transportation, 3015 Barrett Station Road. Sponsored by Transport Museum Association, Info at [transport-museumassociation.org](http://transport-museumassociation.org).

**NEW JERSEY, CINNAMINSON**, January 9-10, 16-17, February 13-14, 20-21; Open House at Burlington County Model Railroad Club, 808 Pomona Road, (Basement of the Footlighter Playhouse). Info at [bcmrc.org](http://bcmrc.org).

**NEW JERSEY, NORTH HALEDON**, January 2-3, 58th Annual Model Railroad Show, at 575 High Mountain Road. Sponsored by Garden State Model Railway Club. Info at [gsmrrclub.org](http://gsmrrclub.org).

**NORTH CAROLINA, WILMINGTON**, January 30-31, Model Railroad Show & Sale, at American Legion Post 10, 702 Pine Grove Drive. Info at [capefearmodelrailroadsociety.org](http://capefearmodelrailroadsociety.org).

**OHIO, DAYTON**, January 17, All Trains Swap Meet, at Montgomery County Fair Grounds, 1043 S Main Street. For info send inquiry to [alltrains@att.net](mailto:alltrains@att.net).

## SELECTED EVENTS | 3

**OREGON, PORTLAND**, January 23, Railroad Swap Meet, at Airport Holiday Inn, 8439 NE Columbia Boulevard. Sponsored by Spokane Portland & Seattle Railway Historical Society. Info at [spshts.org](http://spshts.org).

**WASHINGTON, SEATTLE**, January 16-18, 42nd Annual Train Show, at Pacific Science Center, Denny and Broad Street. Co-sponsored by Pacific Science Center and NMRA PNR 4th Division. Info at [4dpr.com/pacific-science-center-show](http://4dpr.com/pacific-science-center-show).

### February 2016

**FLORIDA, INVERNESS**, February 20, Model Railroad Workshop, at Citrus County Fairgrounds, Horticulture Building, 3600 S. Florida Avenue. Hosted by Citrus Model Railroad Club. Info available at 352-746-4039 or send inquiry to [conductor@citrusmodelrrclub.org](mailto:conductor@citrusmodelrrclub.org).

**FLORIDA, THE VILLAGES**, February 6-7, Spring Rail Expo Sale & Show, at Savannah Regional Recreation Center, 1545 Buena Vista Boulevard. Info at [villagerailclubs.blogspot.com](http://villagerailclubs.blogspot.com).

**KANSAS, WICHITA**, February 6-7, Train Show & Swap Meet, at Cessna Activity Center, 2744 George Washington Boulevard. Info from Phil Aylward at [aylward1@cox.net](mailto:aylward1@cox.net).

**MARYLAND, TIMONIUM**, February 6-7, The Great Scale Model Train & Railroad Collectors Show, at Maryland State Fair, 2200 York Road. Info at [gsmts.com](http://gsmts.com).

**MINNESOTA, PLYMOUTH**, February 26-27, Railroad Modelers Retreat and Train Show, at Mount Olive Lutheran Church, 12235 Old Rockford Road. Sponsored by the Twin Cities Division NMRA. Get more info at [tcdnmra.org/railroad-modelers-retreat](http://tcdnmra.org/railroad-modelers-retreat).



## SELECTED EVENTS | 4

**WEST VIRGINIA, CHARLESTON**, February 20-21, 11th Annual Model Railroad Show, at Coonskin Park Lodge. Presented by Kanawha Valley Railroad Association. Info at [kvrailroad.org/UPCOMING\\_EVENTS.html](http://kvrailroad.org/UPCOMING_EVENTS.html).

**WISCONSIN, MADISON**, February 20-21, 49th Annual Model Railroad Show & Sale, at Exhibition Hall, Alliant Energy Center, 1919 Alliant Energy Center Way. Info at [nmra-scwd.org](http://nmra-scwd.org).

### Future 2016, by location

**CANADA, BRITISH COLUMBIA, SALMON ARM**, June 15-19, Selkirk Express NMRA Pacific Northwest Region Annual Convention & Train Show. Info at [selkirkexpress2016.ca](http://selkirkexpress2016.ca).

**CANADA, NEW BRUNSWICK, SAINT JOHN**, May 19-22, Port City Rails 2016 Model Railroad Convention & Show, at Howard Johnson Fort Howe Plaza & Convention Center, 10 Portland Street. Sponsored by Saint John Society of Model Railroaders. Info at [portcityrails2016.org](http://portcityrails2016.org).

**CANADA, NOVA SCOTIA, TRURO**, June 16, Maritime Prototype Modellers Meet, at Recreation Centre, 40 Douglas Street. Info at [facebook.com/MaritimePrototypeModellers](https://facebook.com/MaritimePrototypeModellers).

**CANADA, ONTARIO, TORONTO**, April 9, Toronto Railway Prototype Modellers Meet, at Humber College, North Campus, Building B, rooms B201-B202, 23 Humber College Boulevard. Request info from Brian Gauer at [bdgauer@yahoo.ca](mailto:bdgauer@yahoo.ca).

**CALIFORNIA, RICHMOND**, June 18, Bay Area Prototype Modelers Meet, at St. David's School Hall, 871 Sonoma Street. Info at [bayareaprototypemodelers.net](http://bayareaprototypemodelers.net).

## SELECTED EVENTS | 5

**CONNECTICUT, ENFIELD**, June 3-4, New England/Northeast Prototype Modelers Meet, at Holiday Inn, 1 Bright Meadow Boulevard. Info at [neprototypemeet.com](http://neprototypemeet.com).

**FLORIDA, LAKELAND**, March 19, 26th Annual Train Show & Swap Meet, at Highland Park Church of the Nazarene, 4730 Lakeland Highlands Road. Event sponsored by H.B. Plant Railroad Historical Society. For information go to [173.254.28.63/~hbplantr/2015/12/01/annual-trade-show-and-swap-meet-n](http://173.254.28.63/~hbplantr/2015/12/01/annual-trade-show-and-swap-meet-n).

**ILLINOIS, COLLINSVILLE (Metro St Louis)**, August 12-13, 10th Annual St. Louis Railroad Prototype Modeler's Meet, at Gateway Convention Center. Hosted by John Golden, Lonnie Bathurst, Dave Roeder, and Dan Kohlberg. Co-sponsored by NMRA Gateway Division. Info at [icg.home.mindspring.com/rpm](http://icg.home.mindspring.com/rpm).

**ILLINOIS, CHICAGO**, October 1-2, Brass Expo, a juried show limited to pre-submitted items including brass models and items relevant to brass models. At The Westin Hotel (Chicago North Shore), 601 N. Milwaukee Ave. Wheeling, IL 60090. Info at [brassexpo.com](http://brassexpo.com).

**INDIANA, INDIANAPOLIS**, July 3-10, NMRA National Convention and National Train Show. HQ at Westin Hotel, 50 South Capitol Avenue. Info at [nmra2016.org](http://nmra2016.org).

**INDIANA, INDIANAPOLIS**, July 8-10, NMRA National Train Show, at Indiana Convention Center, 100 South Capitol Avenue. Info at [nationaltrainshow.org](http://nationaltrainshow.org).

**INDIANA, MARTINSVILLE**, April 2, Spring Train Show, at National Guard Armory, 1900 Hospital Drive. Sponsored by NMRA Central Indiana Division. Request info from Dan Goins at [santafedangoins@comcast.net](mailto:santafedangoins@comcast.net).

## SELECTED EVENTS | 6

**IOWA, OTTUMWA**, March 5-6, 25th Annual Train Show, at Quincy Place Mall. Sponsored by Great River Railway Club. Info at [trc.trains.com/events.aspx?page=info&eventid=15850](http://trc.trains.com/events.aspx?page=info&eventid=15850).

**MAINE, AUGUSTA**, Sept. 7-10, 36th National Narrow Gauge Convention. Info at [nngc2016.org](http://nngc2016.org).

**MASSACHUSETTS, WALTHAM**, April 3, Spring TRAINing Model Train Show, at Embassy Suites, 550 Winter Street. Hosted by NMRA HUB Division. Info at [hubdiv.org](http://hubdiv.org).

**MICHIGAN, MUSKEGON**, April 24, Spring Model Train & Hobby Show, at Veteran's Museum Ship LST 393, 560 Mart Street. Info at [mrhs-online.org](http://mrhs-online.org).

**MISSOURI, JEFFERSON CITY**, October 6-9, Missouri Pacific Historical Society Annual Meeting, includes modeling clinics and swap meet. Info at [mopac.org/corporate-history/73-missouri-pacific-railroad](http://mopac.org/corporate-history/73-missouri-pacific-railroad).

**MISSOURI, SPRINGFIELD**, April 16, 38th Annual Ozarks Model Train Show, at Springfield Expo Center, 635 St. Louis Street. Info at [omraspringfield.org](http://omraspringfield.org).

**OREGON, CORVALLIS**, March 19, Winterail Railroad Photography Exposition & Railroadiana Show, at 1400 NW Buchanan Ave. Info at [winterail.com](http://winterail.com).

**PENNSYLVANIA, MALVERN (Metro Philadelphia)**, March 18-20, Seventh Annual Valley Forge Railroad Prototype Modelers Meet, at Desmond Hotel. Info at [rpmvalleyforge.com](http://rpmvalleyforge.com).

**PENNSYLVANIA, MONACA**, April 3, Spring Model Train Show, at Center Stage, 1495 Old Brodhead Road. Sponsored by Beaver County Model Railroad & Historical Society. Info at [bcmrr.railfan.net](http://bcmrr.railfan.net).

## SELECTED EVENTS | 7

**SOUTH CAROLINA, COLUMBIA**, March 12, Columbia Train Show, at National Guard Armory, 1225 Bluff Road. Info at [south-carolinatradeshows.com](http://south-carolinatradeshows.com).

**UTAH, OGDEN**, March 4-6, Model Railroad Festival, at Ogden Union Station, at 25th Street and Wall Avenue. Sponsored by Hostlers Model Railroad Club. Info at [hostlers.info](http://hostlers.info).

**VIRGINIA, FREDERICKSBURG**, September 23-24, Mid-Atlantic Prototype Modelers Meet, at Wingate by Wyndham Hotel, 20 Sanford Drive. Info at [marpm.org](http://marpm.org).

### Future 2016, by location

**AUSTRALIA, VICTORIA, GEELONG**, April 14-16, 2017, 13th Annual Australian Narrow Gauge Convention. Info at [austnar-rowgaugeconvention.com](http://austnar-rowgaugeconvention.com).

**COLORADO, DENVER**, August 30-September 2, 2017, National Narrow Gauge Convention, at Marriott Denver Tech Center Hotel. Info at [37nngc.com](http://37nngc.com).

**FLORIDA, ORLANDO**, July 30-Aug 5, 2017, NMRA National Convention. Info at [nmra2017orlando.org](http://nmra2017orlando.org).

**MISSOURI, KANSAS CITY**, August 5-12, 2018, NMRA National Convention. Info at [kc2018.org](http://kc2018.org). ■



**Click here for  
reader comments**



**Nano-Oil™**

Made in U.S.A.

**New  
Innovation**

## Nano Technology Lubricants

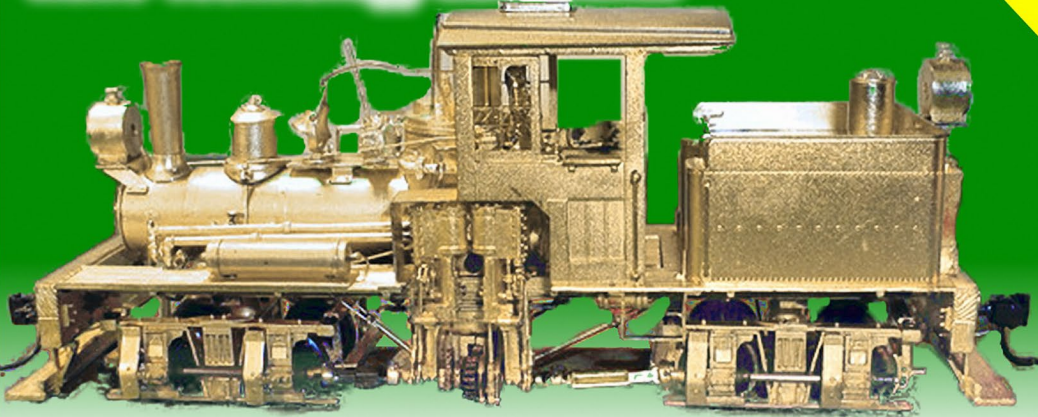

"After eight years of extensive testing, the only lubricants now used in my shop are Nano-Oils and Nano-Grease. The extreme reduction in power draw by mechanically minimizing friction is simply technologically superior."

- Phil Floyd, 'The Shay Fixer'

**Nano-Grease**

# For more details click here ...

**THE SHAY FIXER** 

VISIT US AT...

**SHAYFIXER.COM**

*Specializing in brass Pacific Fast Mail / United geared locomotives*

• INDEX

• TABLE OF CONTENTS

# Clickable advertiser index – 1

[Accu-Lites](#)

[American Ltd \(San Juan\)](#)

[ANE Models](#)

[Archer Fine Transfers](#)

[Amherst Railway Society](#)

[Athearn](#)

[Atlas Model Railroad Co.](#)

[Bachmann](#)

[Backdrop Junction](#)

[Berrett Hill Trains](#)

[Black Cat Publishing](#)

[Blair Line](#)

[BLMA](#)

[Bowser](#)

[Caboose Hobbies](#)

[Canyon Creek Scenics](#)

[Clever Models](#)

[Coastmans Scenic Products](#)

[Coffman Graphics](#)

[Credit Valley Railway](#)

[DCC Hobby Supply](#)

[Digitrax \(2 page spread\)](#)

[ESU LokSound](#)

[Fast Tracks](#)

[Fifer Hobby Supply](#)

[Fine Scale MR Expo](#)

[Fox Valley Models](#)

[George's Trains](#)

[GLX Scale Models](#)

[Great Decals](#)

[HO Diesel Supply](#)

[Iowa Scaled Engineering](#)

[Iwata-Medea](#)

[Jelsma Graphics](#)

[KC's Workshop](#)

[Ken Patterson.com](#)

[Lights 4 Models](#)

[Litchfield Station](#)

[Logic Rail Technologies](#)

[MinuteMan Scale Models](#)

[Model Railroad Benchwork \(1\)](#)

[Model Railroad Benchwork \(2\)](#)

[Model Rectifier Corp.](#)

[Mountain Subdivision Hobbies](#)

[MRH Store \(1\)](#)

[MRH Store \(2\)](#)

[MRH Store \(3\)](#)

[MRH Store \(4\)](#)

[MRH Store \(5\)](#)

[MRH Store \(6\)](#)

[MRH Store \(7\)](#)

[Mr. Detail Parts](#)

[Nano-Oil](#)

[NCE \(2 page spread\)](#)

[Nick & Nora Design](#)

[North Texas Council](#)

[Oak Hill MRR Track Supply](#)

[Pre-Size Model Specialities](#)

[Precision Design Co.](#)

[RailMaster Hobbies](#)

[Rapido \(1\)](#)

[Rapido \(2\)](#)

[Ring Engineering \(1\)](#)

[Ring Engineering \(2\)](#)

# Clickable advertiser index – 2

[Rulers-of-the-World](#)

[Rusty Stumps](#)

[Scale Trains](#)

[Scotty Mason Show](#)

[Signature Press](#)

[Smokebox Graphics](#)

[Soundtraxx \(Blackstone\)](#)

[Southern Digital](#)

[Streamlined Backshop](#)

[TAM Valley Depot](#)

[Tony's Train Exchange](#)

[Train Show Inc.](#)

[TrainMasters TV \(1\)](#)

[TrainMasters TV \(2\)](#)

[TrainMasters TV \(3\)](#)

[TrainMasters TV \(4\)](#)

[Traintek](#)

[TSG Multimedia](#)

[Vector Cut](#)

[Westerfield Models](#)

[Yankee Dabbler](#)

[Yarmouth Model Works](#)

# Clickable "other" index

---

[Other – Bonus Extras](#)

[Other – Cover](#)

[Other – Derailments](#)

[Other – Hobby Marketplace](#)

[Other – MRH Sponsors](#)

[Other – Staff Notes](#)

[Other – Table of Contents](#)

# DOWNLOAD ISSUE



DOWNLOAD PORTRAIT



DOWNLOAD LANDSCAPE

• INDEX

• TABLE OF CONTENTS



# REVERSE RUNNING

commentary

JOE BRUGGER  
.....



[Click here for  
reader comments](#)

## THE BOYS AT THE CLUB

### RECOGNIZE THESE MODEL RAILROADERS?

**“I’m Here for the Fun Phil”** — Has never been seen with a paint brush, car-building project or vacuum cleaner. Always first on the call board for the monthly op session. Also first in line for donuts and lunch.



**“Peter Pauper”** — Complains dues/new engines/swap meet admission/structure kits/free calendar prices are too high but rolls up to meetings in his fully restored mint muscle car. Likes to talk about all-brass layout at Palm Springs winter home.

**“Wayback Willie”** — Favorite phrase is “we never did it that way at the East Smogbank Model Engineers Society,” and bemoans the passing of outside third-rail O gauge model railroads. Is saving large collection

▶ **STEPPING OUTSIDE THE BOX WITH A CONTRARY VIEW**



of pinball machine relays and twin coil switch machines for planned home layout.

**“Myway Waylon”** — Fails to understand that an operations-based club dedicated by popular vote to 1979 freight running might not be charmed by repeated nagging to incorporate steam-hauled passenger trains into the operating scheme.

**“Gail Goodenough”** — Sees an entire evening as an excessive amount of time to devote to building the club’s centerpiece feed mill structure.

**“Warren Wiring”** — Takes care of all the layout electrics, but prefers to use only 16 gauge black wire (gotta great deal on that) and can’t be bothered with labels and diagrams. His twin, Wes Wiring, has in fact prepared a detailed color-coded multi-page proposed wiring schematic with provisions for adding CTC at a later date, but will not show it to Warren, who would not follow it anyway.

**“Paul Planning”** — Prepared and posted Gantt charts for coffee making and restroom duty; now working on procedure for sweeping stairs to layout room.

**“Quentin T. Questioner”** — Is building a layout in spare room at home. Visits work sessions to get solutions to his current wiring and benchwork problems. Allergic to hand saws, screwdrivers and most power tools.

**“Markus Metric”** — Grudgingly helps with HO track laying but bores everyone to tears with plans for detailed creation of Swiss narrow gauge layout using rolling stock handcrafted by Black Forest elves.

**“Arnie Absent”** — Appears in the club rooms only when no one else is present, then sends detailed emails on how new projects fall outside the scope of a master plan known mostly to himself.

**“Jeremy Jmri”** — Has plans to solve all stuttering engine and layout derailment problems with software he is developing with a circle of Web friends in Australia, Hong Kong and Denmark.

**“Eddy Editor”** — Writes snarky columns about fellow club members past, present, and future. Plans to quit the group, but never does because he would then have to build a layout at home. ☑



# DERAILMENTS



## HERZOG CARTOPPER

Because the the Herzog Cartopper is so flexible, experienced operators can dismount from the trains, reaching the ground safely with the utilization of some very skilled maneuvers. Amazing!

For more on the Herzog Cartopper, see [harsi.com](http://harsi.com).

► BIZARRE FACTS AND HUMOR (SUPPOSEDLY)

# YOU MIGHT BE A MODEL RAILROADER IF ...

- You see an empty room, and your first thought is to imagine what kind of layout could be built in it.
- You've gotten into a debate over whether Kato is pronounced "kay-to" or "kah-to."
- You name the places on your railroad after your wife and children to atone for spending so much time in the basement.
- You've ever told anyone, "I can quit buying freight cars any time I want!" ■

## GET PAID ...

If you're the first to submit a bit of good humor or bizarre facts and we use it, it's worth \$25! Just send to [derailments@mrhmag.com](mailto:derailments@mrhmag.com) ■

## Coming next issue ...

- Dennis Murphy models a branchline diorama
- Build an On30 wood hopper
- Building Beaver Creek bridge
- Emery Falls N scale modules
- Make your own ballast
- And lots more ...



[Click here for reader comments](#)