

HAVING FUN WITH TRAINS

DECEMBER 2015 | FREE

# MRH

MODEL RAILROAD HOBBYIST

## ALSO:

- Super-detailed turnout
- Make a DCC test track
- Cranes that really work
- Layout remodeling
- Details of DCC consisting

*... and lots more inside!*

Twenty+ years of

Ken  
Patterson

model  
railroad

photos » **READ NOW**



STANDARD EDITION | PORTRAIT



DOWNLOAD

# BLMA MODELS



HO & N

## HERE COME THE REPAINTS

3 NEW BNSF SCHEMES



## PRE-ORDER MODELS

**BNSF**  
*Bx-166*

60' Double-Door Box Car

• 24 Unique Road Numbers •

ORDERS DUE: Jan 15, 2016

DELIVERY: Summer 2016

***BLMAmodels.com***



MRHMAG.COM

- TABLE OF CONTENTS
- INDEX



# STAFF CREDITS

**Front cover:** Ken Patterson has been doing model railroad cover photos and articles for over 20 years now. We reminisce a bit with Ken in his column this issue.

**ISSN 2152-7423**

## Editorial Staff

Joe D. Fugate, Publisher and Editor

Don Hanley, Assistant Editor

## Production

Patty Fugate, pasteup and layout

Joe Brugger, copy editing

Mike Dodd, copy editing

## Technical Assistant

Jeff Shultz

## Advertising

Les Halmos, Account Manager

Daniel Nava, Advertising Assistant

Jean-François Delisle, Marketing Assistant



## Columnists

Richard Bale, News and events

Jeff Shultz, News and events

Les Halmos, Modular railroading

Larry Smith, Narrow Gauge/Shortlines

Bruce Petrarca, DCC

Ken Patterson, Reporter at large

## Special Correspondents

Joe Brugger, Questions & answers

Charlie Comstock, Contributing editor

Issue password: Dec2015

Published for the glory of God. [What's this?](#)



# MRH SPONSORS

## A - E



[acculites.com](http://acculites.com)



[americanlimitedmodels.com](http://americanlimitedmodels.com)



[railroadhobbyshow.com](http://railroadhobbyshow.com)



[anemodel.com](http://anemodel.com)



[archertransfers.com](http://archertransfers.com)



[athearn.com](http://athearn.com)



[www.atlasrr.com](http://www.atlasrr.com)



[bachmanntrains.com](http://bachmanntrains.com)



[bachrus.com](http://bachrus.com)



[backdropjunction.com](http://backdropjunction.com)

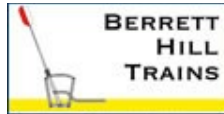

[berrethill.com/trains](http://berrethill.com/trains)



[blairline.com](http://blairline.com)



[blmamodels.com](http://blmamodels.com)



[bowser-trains.com](http://bowser-trains.com)



[caboosehobbies.com](http://caboosehobbies.com)



[coffmaneng.com](http://coffmaneng.com)



[con-cor.com](http://con-cor.com)



[cvrco.com](http://cvrco.com)



[www.digitrax.com](http://www.digitrax.com)



[esu.eu/en](http://esu.eu/en)

[Vendors: Get your clickable logo here ...](#)

# MRH SPONSORS | 2

## F - R



[www.handlaidtrack.com](http://www.handlaidtrack.com)



[fiferhobby.com](http://fiferhobby.com)



[foxvalleymodels.com](http://foxvalleymodels.com)



[glxscalemodels.com](http://glxscalemodels.com)



[georgestrains.com](http://georgestrains.com)



[www.hobby-on.com](http://www.hobby-on.com)



[www.iascaled.com](http://www.iascaled.com)



[iwata-medea.com](http://iwata-medea.com)



[litchfieldstation.com](http://litchfieldstation.com)



[microscale.com](http://microscale.com)



[model-trains-video.com](http://model-trains-video.com)



[stores.ebay.com/Motrak-Models](http://stores.ebay.com/Motrak-Models)



[modelrectifier.com](http://modelrectifier.com)



[nano-oil.com/Model%20Railroad.html](http://nano-oil.com/Model%20Railroad.html)



[ncedcc.com](http://ncedcc.com)



[nickandnoradesigns.com](http://nickandnoradesigns.com)



[www.pwrs.ca/main.php](http://www.pwrs.ca/main.php)



[railmasterhobbies.com](http://railmasterhobbies.com)



[rapidotrains.com](http://rapidotrains.com)



[ringengineering.com](http://ringengineering.com)



[rustystumps.com](http://rustystumps.com)

[Vendors: Get your clickable logo here ...](#)

# MRH SPONSORS | 3

## S - Z



[sanjuancarco.com](http://sanjuancarco.com)



[scaletrains.com](http://scaletrains.com)



[signaturepress.com](http://signaturepress.com)



[soundtraxx.com](http://soundtraxx.com)



[sodigi.com](http://sodigi.com)

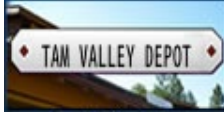

[tamvalleydepot.com](http://tamvalleydepot.com)



[tonystrains.com](http://tonystrains.com)



[traintekllc.com](http://traintekllc.com)



[tsgmultimedia.com](http://tsgmultimedia.com)



[walthers.com](http://walthers.com)

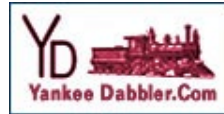

[yankeedabblers.com](http://yankeedabblers.com)

[Vendors: Get your clickable logo here ...](#)

Looking for something? Check our Hobby Marketplace!

The screenshot shows the MRH Marketplace website interface. At the top, it says "MRH MARKETPLACE | 2". Below this, there are several product listings and advertisements. On the left, there are ads for "Trees!", "coastmans", and "REFLECT". In the center, there are ads for "SUGAR CUBE" SPEAKERS, "True Scene Modeling", "Mr. Detail Parts", "Vector Cut", and "Precision". On the right, there are ads for "FREE SHIPPING!", "Yarmouth Model Works", and "BenchWork". A large green button with the text "Take me there!" is overlaid on the right side of the screenshot.

Take me there!



Item No. 54305 • MAINE CENTRAL #617 with MEDIUM TENDER • MSRP \$399.00

## MEET BACHMANN'S MIGHTY MIKADO IN DCC SOUND-EQUIPPED AND DCC-READY MODELS

The latest in Bachmann's USRA series of locomotives, the 2-8-2 is also known as the "Mikado" after Baldwin delivered the first engines with this wheel arrangement to Japan Railways in 1893. Our DCC sound-equipped USRA Light model includes our Sound Value *SoundTraxx*® steam sound package with authentic prototypical chuff, short and long whistles, bell, air pump, steam release and blower—all in 16-bit polyphonic sound. The DCC-ready version has an 8-pin socket for the DCC decoder installation of your choice. Visit your favorite hobby dealer to add the might of the legendary Mikado to your HO railroad!

DCC SOUND-EQUIPPED USRA LIGHT 2-8-2 • MSRP \$399.00 each



UNION PACIFIC® #2487  
with MEDIUM TENDER  
Item No. 54301



BALTIMORE & OHIO® #4508  
with MEDIUM TENDER (high headlight)  
Item No. 54302



PENNSYLVANIA RAILROAD® #9630  
with MEDIUM TENDER (high headlight)  
Item No. 54303



NEW YORK CENTRAL® #6405  
with MEDIUM TENDER  
Item No. 54304



Click for more info

SHIPPING NOW!

DCC-READY USRA LIGHT 2-8-2 • MSRP \$315.00 each

- Item No. 54401 PERE MARQUETTE #2378 (POST-MERGER NUMBER) with LONG TENDER
- Item No. 54402 ROCK ISLAND #2319 with MEDIUM TENDER
- Item No. 54403 SOUTHERN #4501 with LONG TENDER
- Item No. 54404 WESTERN PACIFIC™ #302 with MEDIUM TENDER
- Item No. 54405 FRISCO #4027 with MEDIUM TENDER

SHIPPING NOW!



Bachmann Industries, Inc. • 1400 East Erie Avenue • Philadelphia, PA 19124 USA • [www.bachmanntrains.com](http://www.bachmanntrains.com)

Click to learn more.

MRHMAG.COM

- TABLE OF CONTENTS
- INDEX



# TABLE OF CONTENTS

## FEATURES

### Detailed switch at Beaver Creek

ANDREW HALL

Proto:87 Stores turnout parts makes it easy

---



### How to model working cranes: 1

GEOFF BUNZA

Put these animated cranes to work on your layout

---



### GATX version 33.9K tank car

RICK UHLENKOTT

Kitbashing this N scale tank car

---

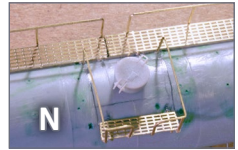

### Build a DCC test track

JERRY BENGTON

Test your DCC locos at your workbench

---



### SP passenger cars, part 8

VICTOR ROSEMAN

Kitbashing accurate lightweight cars finale

---



**ALSO:** MRH Marketplace | Bonus downloads



## TABLE OF CONTENTS | 2

### COLUMNS

**MRH Q-A-T: Lettering wear, curve radius, foam boxes ...**

*compiled by JOE BRUGGER*

**DCC Impulses: Details of DCC consisting**

*BRUCE PETRARCA*

**Getting Real: Remodeling the layout, next chapter: 1**

*MIKE ROSE*

**What's Neat: Reminiscing with Ken, and more ...**

*KEN PATTERSON*

**Photo feature: Yes, it's a model: Merry Christmas!**

*compiled by DON HANLEY*

**Derailments: Bizarre facts & humor**

*compiled by the MRH STAFF*

### NEWS and EDITORIAL

**Publisher's Musings: Looking back with Ken Patterson**

*JOE FUGATE*

**Staff Notes: MRH track plan database ...**

*compiled by the MRH STAFF*

**News & Events: December 2015**

*RICHARD BALE & JEFF SHULTZ*

**Reverse Running: Buy that old layout!**

*BEN KAUR*

# SEE THE DIFFERENCE

## Union Pacific GTEL 8500 Horn

What does it mean to "See The Difference"? For us, it means living up to the magnifying glass test. We invite you to inspect our first Museum Quality™ locomotive with the included magnifying glass. Notice the fidelity full-scale... the tiny details and fine printing... the quality workmanship. Suddenly, it becomes obvious the creators of this one-of-kind locomotive share the same passion as you.

See more of the difference  
and preorder now at  
[www.ScaleTrains.com](http://www.ScaleTrains.com).



© 2015 ScaleTrains.com, Inc. ScaleTrains.com, Museum Quality, and Horn are trademarks of ScaleTrains.com, Inc. This product is made under trademark of the Union Pacific Railroad. "LokSound" is a registered trademark of Eschscholtz. ScaleTrains.com, Inc. 7598 Highway 411 Benning, NE 68009

[MRHMAG.COM](http://MRHMAG.COM)

- [TABLE OF CONTENTS](#)
- [INDEX](#)

ADVERTISEMENT

# REFERENCE NOW!

## High-horsepower "Big Blow" Turbine

**HO**  
1:87 SCALE



Quality plus their respective logos and slogans  
license from General Electric (GE) and the Union Pacific Railroad Company.  
SU Electronic Solutions Ulm GmbH & Co KG.  
ton, TN 37307 844-9TRAINS 844-987-2467

Scene and photography by  
Ken Johnson. Actual model shown

[MRHMAG.COM](http://MRHMAG.COM)

- [TABLE OF CONTENTS](#)
- [INDEX](#)



# EMD 39 SERIES

DIESELS

ELECTRO MOTIVE V 12 LA GRANGE ILLINOIS

2300hp



## JUST ANNOUNCED AT MILWAUKEE TRAINFEST!

DCC-Ready	RTR-Sound	
ATH98773	ATH98873	HO RTR SD39, Undecorated
ATH98774	ATH98874	HO RTR SD39, SF #4001
ATH98775	ATH98875	HO RTR SD39, SF #4004
ATH98776	ATH98876	HO RTR SD39, SF #4005
ATH98777	ATH98877	HO RTR SD39, SF #4011
ATH98778	ATH98878	HO RTR SD39, IT #2302
ATH98779	ATH98879	HO RTR SD39, IT #2303
ATH98780	ATH98880	HO RTR SD39, IT #2304

### HO RTR EMD SD39

DCC-Ready: \$134.98  
RTR-Sound: \$184.98

DCC-Ready	RTR-Sound	
ATH98781	ATH98881	HO RTR SD39, MN&S #40
ATH98782	ATH98882	HO RTR SD39, MN&S #41
ATH98783	ATH98883	HO RTR SD39, N&W #2961
ATH98784	ATH98884	HO RTR SD39, N&W #2963
ATH98785	ATH98885	HO RTR SD39, N&W #2966
ATH98786	ATH98886	HO RTR SD39, N&W #2965
ATH98787	ATH98887	HO RTR SD39, SP #5302
ATH98788	ATH98888	HO RTR SD39, SP #5306
ATH98789	ATH98889	HO RTR SD39, SP #5310
ATH98790	ATH98890	HO RTR SD39, SP #5314

## JUST ANNOUNCED AT PORTLAND NATIONAL TRAIN SHOW!



### HO GENESIS EMD GP39-2

DCC-Ready: \$169.98 • Tsunami Sound: \$269.98



Phase I: SF, D&H, RDG, P&WR  
Phase II: BN  
Visit [Athearn.com](http://Athearn.com) for part numbers

The right phase for the right roadname...specifically! Both the RTR SD39 and the Genesis GP39-2 share a level of detail that have never been delivered in HO scale before. Our new RTR SD39 shares the same proven new mechanism from the popular SD40/SD45 and incorporates the DCC Sound Ready components including using the ATHG63839 Genesis motor retrofit kit for simplified speed matching with our Genesis models.



The brand new GP39-2 incorporates several body phases and many separately applied details that are specific to each road name. Built upon our popular GP38-2, GP40-2, GP50 Genesis mechanism, these models achieve an entirely new level of "As close to real as it gets"™

To learn more about the 39 series diesels, go to [Athearn.com](http://Athearn.com) or your local hobby shop today.

**HORIZON**  
H O B B Y

**VISIT**  
Your Local Retailer

**CLICK**  
[Athearn.com](http://Athearn.com)

**CALL**  
1.800.338.4639

**SERIOUS FUN™**

©2015 Horizon Hobby, LLC. Athearn, Genesis and McHenry are registered trademarks of Horizon Hobby, LLC. All other trademarks, service marks and logos are property of their respective owners. Final models may vary slightly from photos shown. 5384



# PUBLISHER'S MUSINGS

editorial

JOE FUGATE



[Click here for  
reader comments](#)

## LOOKING BACK WITH KEN PATTERSON

### IN DECEMBER OF EACH YEAR, MRH LIKES TO

be true to its name and put the hobbyist at center stage. In our cover story this month, we look back with Ken Patterson at what he has done in the hobby over the past 20 years or so.

As you know if you are been a longtime MRH reader, Ken approached us about three years ago about starting a video column in MRH.

Ken called me and pitched his *What's Neat* column idea to us. I especially liked his idea of doing an interactive column that included a video each month, which fits very well with our web media approach of doing MRH, so I said let's do it!

Ken's been doing his video colums with us for almost three years now. In my regular conversations with Ken, I asked him how many articles and covers he has done, and frankly, the numbers astound me!

Ken told me he's done 200 covers and 400 articles to date on model railroading. Wow! Who else on the planet can make

## PUBLISHER'S MUSINGS | 2

that claim? I don't know of anyone else, do you? That's simply amazing.

If you read and watch Ken's monthly *What's Neat* video columns (and if you're not watching Ken's videos, then you're missing out), you know Ken works fast and is a prolific modeler. Even though he's a fast worker, Ken's modeling is certainly not second-rate or slipshod. Ken's modeling has to be good, because the camera is one of the least forgiving critics.

Many of Ken's projects aren't just simple one-off photos either. They're destined to be cover shots or big promo product posters at train shows. You can't be in a much more critical spot than to be modeling for an advertiser!

### ADVERTISEMENT

**NOW AVAILABLE FROM**



Atlas Trainman® HO GP39-2  
Copper Basin Railway #502 - Item # 10 001 774

**For information on this and  
more recent Atlas arrivals**

**CLICK HERE**

**MRHMAG.COM**

- **TABLE OF CONTENTS**
- **INDEX**

ADVERTISEMENT

**CLICK HERE TO WATCH  
OUR NEW DOCUMENTARY!**



RDCs under construction

# ALL ABOUT THE RDC

[MRHMAG.COM](http://MRHMAG.COM)

- [TABLE OF CONTENTS](#)
- [INDEX](#)

**NICK & NORA DESIGNS**  
Uniquely inspired craftsman kits

PO BOX 174 21  
facebook



THE SOUTHERN RAILROAD  
SERVES THE SOUTH

Combination Depot - Ridgecrest, NC  
Model based on Southern Railway Engineering drawings (May, 1912)

Craftsman Structure Kits,  
Detail Parts, Shingles & More!  
[www.nickandnoradesigns.com](http://www.nickandnoradesigns.com)



**Archer**  
FINE TRANSFERS  
PROUDLY SERVING MODEL BUILDERS SINCE 1989

THE ORIGINAL  
**SURFACE DETAILS™**

WE NOW HAVE MORE  
THAN 100 SHEETS OF  
RIVETS, LOUVERS,  
TREADPLATE AND  
MORE CAST ONTO  
MICROSCALE CLEAR  
DECAL FILM

**FREE SHIPPING:**

- DOMESTIC USA ORDERS  
\$50 OR MORE
- INTERNATIONAL ORDERS  
\$100 OR MORE

CLICK HERE TO  
VISIT OUR WEBSITE!

Archer Fine Transfers • PO Box 1277 • Youngsville, NC 27596 • USA  
(919) 570-1026 • info@archertransfers.com • archertransfers.com

MADE IN THE USA

*"Archer rivets  
are easy to apply  
and look great.  
To me, they are  
now a vital tool  
in building  
railroad models."*  
Tony Thompson, Model  
Railroad Author/Historian

## PUBLISHER'S MUSINGS | 3

If Ken's modeling was second-rate, he'd never get another ad contract, that's for sure.

If you meet Ken and work with him, you quickly learn Ken isn't bashful about selling himself and his work. But then, being shy doesn't get you a personal visit from Phil Walthers or other industry "names." Ken still regularly has visits by industry leaders such as Chris Palomarez of Athearn.

Ken has so much work to his credit in the industry because he has the *guts* to approach hobby leaders and pitch ideas to them.

I can also tell you Ken is constantly pitching ideas to me as the publisher of MRH. Like most folks in the hobby industry, we



...Arriving Soon

# MRC's Light Genie™

**A Unique Radio Control Light System.  
Works with All Model Railroads.**

*No other lighting control system delivers all these advantages:*

- Light Genie's wireless range of 50' puts an end to being tethered to a switch panel.
- Transmitter and receiver control 12 light outputs, including two 3-way, automatic traffic lights.
- Control on-off. Control brightness/dimming. Plus control flickering, flashing, strobe and beacon.
- Not just for buildings, Light Genie also handles traffic lights, street lamps, railroad signals and more.

- Compatible with all scales and virtually all lighting accessory brands. Use with LED or incandescent bulbs.



Enjoy Railroading More. Easily.

RAILROAD SIGNALS



BUILDING LIGHTS



STREET LIGHTS



TRAFFIC LIGHTS



**CLICK HERE**



MODEL RECTIFIER CORPORATION  
80 Newfield Ave. ■ Edison, New Jersey 08837 ■ Phone: 732 225 6360 [www.modelrectifier.com](http://www.modelrectifier.com)

TECHNOLOGY. PERFECTED.

Model railroads  Plastic model kits  Battery chargers  Radio control helicopters, planes, cars & boats  Slot Cars  Scenery  Die cast

MRHMAG.COM

- [TABLE OF CONTENTS](#)
- [INDEX](#)

have a lot of projects in flight all the time, and to have someone who keeps bringing us new ideas is helpful.

Sometimes I say no, sure, but that doesn't faze Ken. He accepts a no without complaining or giving up, then goes off to cook up something else and comes back later with another idea. Often, the second time around a rejected idea gets a yes.

Our focus at MRH is doing the hobby. In online forums, a lot of modelers talk about doing the hobby, but may not always do much actual modeling. Ken is a doer. I really like that: the hobby needs more doers like Ken.

Because Ken is such a doer and he does work for hobby vendors from all scales and eras, his experience in the hobby is broad. He's worked in just about every scale and gauge.

Ken has been bitten by the Colorado HOn3 bug, and he's doing great work. Much of it is for Blackstone, the HOn3 manufacturer.

I keep encouraging Ken to share more of his methods, tips, and techniques in his column. Being such a prolific modeler means Ken is a font of great how-to information. I've picked up a number of great ideas from his columns myself!

A few modelers tell me they think Ken gets too much exposure or that his work needs more \_\_\_\_\_ (fill in the blank). To them, I say: "Okay, you go work with some of the larger hobby firms and you get them to run your cover photos, your product photos, and your articles and show us how it should be done. When will we see your first work?"

I feel privileged to have on the MRH team someone with such a rich heritage in the hobby industry and such a prolific doer in

## PUBLISHER'S MUSINGS | 5

the hobby as Ken Patterson. This month, check out Ken's What's Neat column and video, and let's enjoy looking back with Ken at his story and celebrating all he's done for our beloved hobby!



**Click here for  
reader comments**

ADVERTISEMENT

### Backdrop Junction

Your Stop for Railroad Backdrops

**Click Here** →

**For the Finest in Custom  
Designed backdrop**



[www.backdropjunction.com](http://www.backdropjunction.com)

**MRHMAG.COM**

# GREAT NEWS!



**More than 300 items  
at up to 40% Off**

**Start  
Saving  
Here**



**e-Auction-Club.com**

Where buyers and sellers both save money.



**Need some cash to buy the  
"latest" upgraded models with  
all the bells and whistles?**

**Sell off your older models on  
e-Auction-Club for only a 6%  
commission. Help budget-  
minded modelers to buy  
models at prices that they can  
afford.**

**Join today and  
Tell your friends!**



- **TABLE OF CONTENTS**
- **INDEX**

# MRH CONTEST: THE "ONE MODULE" CHALLENGE



**GOAL:** Design the first "module section" for a sectional home layout design.

Hypothetical room is 12' x 15'

NOTE: This is a sectional home layout design, *no modular standard* required.

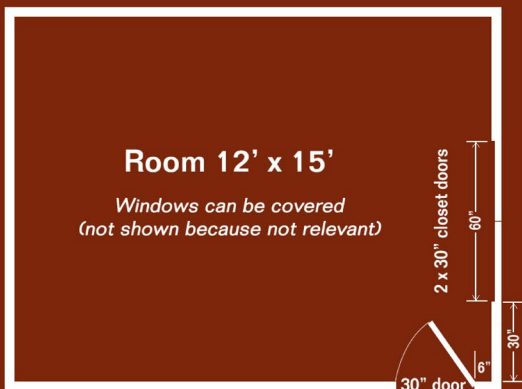

## CONTEST RULES

**ENTRY DEADLINE: January 31, 2016**

- Module must be 18"-24" in depth and 60"-84" in length.
- Scale: Z, N, TT, HO, S, O - standard and/or narrow gauges.
- Connectable to a flattop staging section (or additional layout sections later) at each end. Design the two flattop staging yards with 3 to 8 staging tracks of at least 70" long.
- Rough out the outlines of the other layout module sections to be built for the entire room. No track plan needed, just an outline of the modules in the room is sufficient.
- Describe the theme, era (if any), and rationale for the module and its place in the layout that would eventually fill the room.
- Can follow a specific module standard (like Free-Mo) if desired, but that is not a requirement. Each module can be custom and only mate with an adjacent module.
- Module support method and height is up to you, but please describe it.
- Must be wired for either DC or DCC. Describe how you would interconnect the wiring.
- As the first module of a sectional home layout design, making the module removable once completed is not required, but innovation here will get extra points.
- As to construction methods & materials, surprise us. Extra points awarded for innovation.
- Include pricing for the module. There's no need to build it, this is a design contest. This includes module benchwork, legs, backdrop, roadbed, trackwork, wiring, scenery materials, structures, and details. Do not include a DCC system, rolling stock, or locos.
- The best submissions will be published, so extra points will be awarded for high quality text, illustrations, photos, and captions. Winners will get a bonus payment rate.

**SUBMIT ENTRY (Choose "Contest entry")**



# STAFF NOTES



Click here for  
reader comments

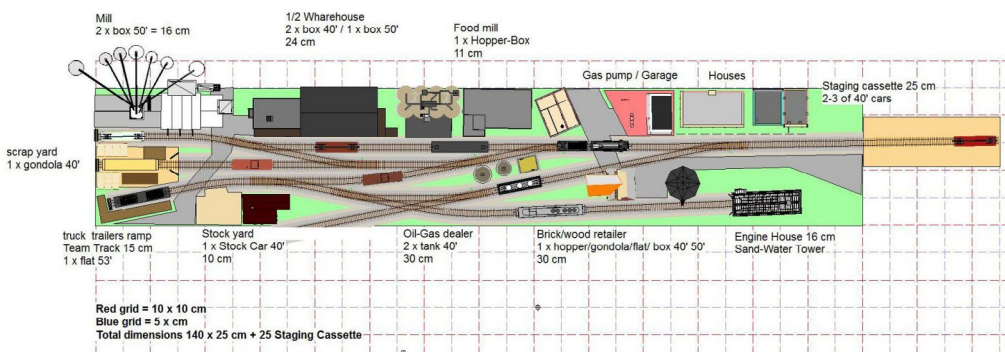

## MRH TRACK PLAN DATABASE ... AND MORE

**THE MRH FORUM IS LOADED WITH GOODIES,** which you will find if you spend some time on there. The forum regulars have created some wonderful resources there, one of which is an MRH Track Plan Database.

To find the MRH track plan database thread, just use this link:  
[mrhmag.com/track-plan-database](http://mrhmag.com/track-plan-database)

You can also find an index to the plans here:  
[mrhmag.com/track-plan-database-index](http://mrhmag.com/track-plan-database-index)

As of this writing, the track plan database has 164 plans in it – that's quite a collection! There's also discussion on these track

# STAFF NOTES | 2

plans available on another thread. To participate in the discussion about the posted track plans, go here:

[mrhmag.com/track-plan-database-discussion](http://mrhmag.com/track-plan-database-discussion)

To give you a flavor of the track plans that can be found in this online database, here are a couple more samples. There are lots more like this in the database on the MRH site – be sure to check it out! While you're at it, be sure to thank Bill Brillinger and all those who have posted their track plans for this great resource!





## LAST ISSUE'S RATINGS

The five top-rated articles in the [November 2015 issue](#) of *Model Railroad Hobbyist* are:

- 4.8 Imagineering: How to “think real”
- 4.8 Caldwell Boulevard
- 4.6 Yes, It’s a Model
- 4.5 DCC Impulses: What’s up with LCC?
- 4.5 Getting Real: Creating the “Ozark mountains”

Issue overall: 4.7

**Please rate the articles!** Click the reader comments button on each article and select the star rating you think each article deserves. Thanks! ■

ADVERTISEMENT



Your Local **N Scale**  
Online Hobby Shop

575-523-9743  
fiferhobby.com

MRHMAG.COM

- [TABLE OF CONTENTS](#)
- [INDEX](#)

# HO HARBOR SWITCHING LAYOUT

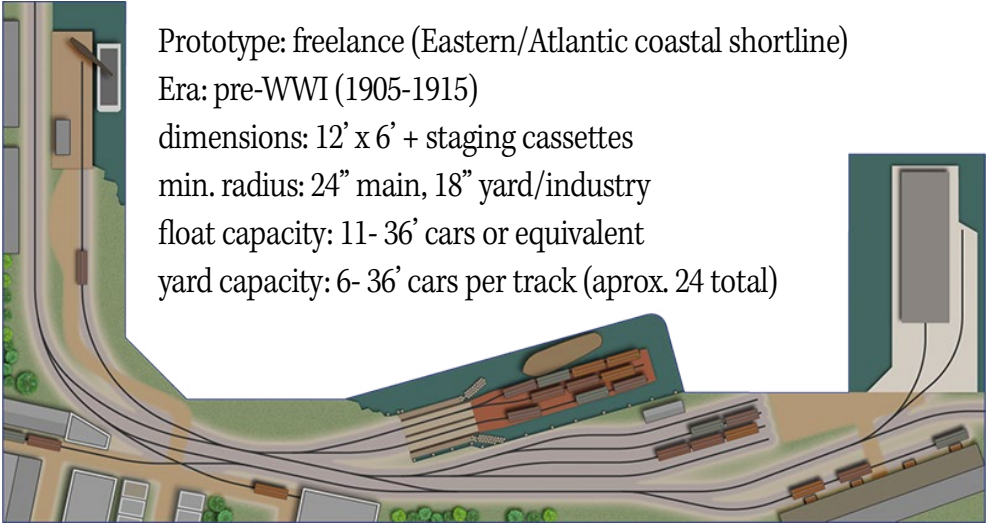

Prototype: freelance (Eastern/Atlantic coastal shortline)  
Era: pre-WWI (1905-1915)  
dimensions: 12' x 6' + staging cassettes  
min. radius: 24" main, 18" yard/industry  
float capacity: 11- 36' cars or equivalent  
yard capacity: 6- 36' cars per track (aprox. 24 total)

ADVERTISEMENT

ADVERTISEMENT

**ALL 20 YEARS PLUS OF  
CANADIAN RAILWAY MODELLER  
MAGAZINE ON DVD!**

- Contents Searchable • PC & Mac Compatible
- Includes All Ads, Photos, Interviews & Articles
- Every Issue from Track 1 – 116 Issues!

**Introductory Offer Extended**

**\$69.95**  
CDN

Order by Dec.15, 2015

**Click here to order**

Want to build better models?

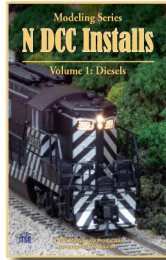

**N DCC Installs**

**CLICK FOR DCC** ↖

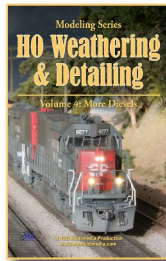

**HO Weathering & Detailing**

**CLICK FOR WEATHERING** ↖



**TSG Multimedia**



## Gang of six is now gang of five

Sadly, we must report that we lost one of our Imagineering columnists, Verne Niner, in November due to heart attack. You can find Verne's obituary at the end of the December news this issue. We will be discussing with the remaining columnists what they wish to do: become the gang of five or recruit a new columnist. Goodbye, Verne, and may you enjoy the Lord's train that fills the temple ([Isaiah 6:1, KJV](#)).

## TrainMasters TV and the MRH Media family

*Model Railroad Hobbyist* magazine ([mrhmag.com](http://mrhmag.com)) is part of a larger company now known as MRH Media. TrainMasters TV ([trainmasters.tv](http://trainmasters.tv)) is also a part of the MRH Media family, as is

# "ONE MODULE" CHALLENGE BONUS PRIZE!

## GET YOUR MODULE FREE FROM [modelrailroadbenchwork.com](http://modelrailroadbenchwork.com)

"We would like to offer the winner a free module meeting their design's size criteria with legs. This means you'll win a benchwork module with a value of up to \$150 shipped free to your home.

(In the US only, however.)"



the MRH Store ([store.mrhmag.com](http://store.mrhmag.com)). So in summary, there are three arms to the MRH Media family: MRH magazine, the MRH Store, and TrainMasters TV.

What's important here is to realize that your free magazine, *MRH*, gets support from these other two arms of the MRH media family.

We get emails from modelers sometimes saying they really like the free magazine and wondering if there's any way they can contribute? As it turns out, some of the profits from the MRH Store and from TrainMasters TV help fund MRH magazine and help keep it free.

So if you've ever wanted to say thanks to MRH magazine for being such a helpful free resource to you, go buy some product on the MRH Store or sign up for a TrainMasters TV membership. Not only will you get some great product to help you advance your modeling, you will also be helping keep MRH free!

### What's new on the MRH website?

Here's our monthly sampling of MRH website posts.

SPSF Meadow Subdivision: [mrhmag.com/node/24522](http://mrhmag.com/node/24522)

DCC bus wire termination needed? [mrhmag.com/node/1735](http://mrhmag.com/node/1735)

4-8-4 jumping Peco turnouts: [mrhmag.com/node/24524](http://mrhmag.com/node/24524)

Better flex track curves: [mrhmag.com/node/24443](http://mrhmag.com/node/24443)

Making control panels: [mrhmag.com/node/19594](http://mrhmag.com/node/19594)

The classic railcar kit is back: [mrhmag.com/node/24351](http://mrhmag.com/node/24351)

Using JMRI OperationsPro: [mrhmag.com/node/24516](http://mrhmag.com/node/24516)

My freight car and loco projects: [mrhmag.com/node/24155](http://mrhmag.com/node/24155)

# STAFF NOTES | 7

Reverse loop wiring help: [mrhmag.com/node/24451](http://mrhmag.com/node/24451)

SoundCar decoder in N scale boxcar? [mrhmag.com/node/24416](http://mrhmag.com/node/24416)

An extraordinary flat car load: [mrhmag.com/node/20932](http://mrhmag.com/node/20932)

Module alignment on section layouts: [mrhmag.com/node/24500](http://mrhmag.com/node/24500)

Naming and operating yard tracks: [mrhmag.com/node/24493](http://mrhmag.com/node/24493)

What happened to dumped loco ash? [mrhmag.com/node/24482](http://mrhmag.com/node/24482)

Enjoy the December MRH – and along the way, have a great Christmas and new year!



**Click here for  
reader comments**

## ADVERTISEMENT

HO GP60M, GP60B AND GP60 Locos



Now Available !



DC or DCC with Sound!



[www.foxvalleymodels.com](http://www.foxvalleymodels.com)

**MRHMAG.COM**

## ADVERTISEMENT

# American Limited

**HO AND N  
DIESEL AND PASSENGER  
CAR DIAPHRAGMS.**

**THE  
FINISHING  
TOUCH.**

**AT YOUR DEALER OR DIRECT,  
[www.americanlimitedmodels.com](http://www.americanlimitedmodels.com)**

- **TABLE OF CONTENTS**
- **INDEX**



**S T A T I O N**

**COOL**

**DCC Products & Service**

*with Prices that*

**DON'T BURN**

**623-298-7355**

**www.LitchfieldStation.com**



The Get the Latest Model Railroading News, Tips, Reviews & Opinions

# SCOTTY MASON

S H O W  
The Original Model Railroad Podcast

## -Monthly Interviews

- Modeler's Spotlight: Top Modeler's Talk
- Narrow Gauge Modeling w/Chris Lane
- Contemporary Modeling w/ Mike Rose

## -More Product Announcements & Reviews

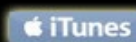

Our feed has changed! To get the latest shows, Please search Scotty Mason and subscribe to the new feed!

[www.TheModelRailroadPodcast.com](http://www.TheModelRailroadPodcast.com)

Scott Mason Jimmy Simmons Mike Rose Joe Duckworth

ADVERTISEMENT

ADVERTISEMENT

**George's Trains** EST. 1962  
Canada's Greatest Model Train Store

**20 NEW Colours Just added!**

**PROTO-PAINT**

**ACRYLIC-Air Brush Ready**  
NOW OVER 45 Canadian Railway Colours!

Dealer inquiries welcome.

**\$8.98 each Canadian**

**ORDER NOW!**

550 Alden Rd., Unit 101 Markham, On, Canada L3R 6A8  
Tel: 905-470-6200 Toll Free: 1-877-8TRAINS (887-2467)  
[www.georgestrains.com](http://www.georgestrains.com)

PP-001 CNR Green #11	PP-020 TH&B Maroon	PP-038 TTC CREAM
PP-002 CNR Imitation Gold	PP-021 Primer	PP-039 TTC Maroon
PP-003 CNVIA Blue #16	PP-022 Reducer	PP-040 Warm BLACK
PP004 CNVIA Yellow #18	PP-023 Flat Finish	PP-041 Grimy Black
PP-005 VIA Grey	PP-024 Stencil White	PP-042 Anti-Glare Black
PP-006 CN Red/Orange #11	PP-025 Loco Black	PP-043 Slag Brown
PP-007 CN Lettering Grey #17	PP-026 Flat Haze	PP-044 GO Green
PP-008 CN Grey #11	PP-027 ONR LT BLUE	PP-045 GO White
PP-009 CNR Red #12	PP-028 ONR DK BLUE	PP-046 CONRAIL Blue
PP-010 CPR Tuscan	PP-029 ONR YELLOW	
PP-011 CPR Diesel Grey	PP-030 ONR Post 2000 Yellow	
PP-012 CPR Diesel Yellow	PP-031 ONR GREEN	
PP-013 CPR Steam Grey	PP-032 BCR/PGE DK GREEN	
PP-014 CPR Mineral Brown	PP-033 BCR RED	
PP-015 CP Action Red	PP-034 BCR Blue	
PP-016 CP Action Yellow	PP-035 BCR Yellow	
PP-017 CP Action Green	PP-036 BCR/PGE LL GREEN	
PP-018 CP Bright Red	PP-037 GTW Blue	
PP-019 TH&B Cream		

**Lasercut structures. Highway, storefront and billboard signs.**

**NEW KIT in HO & N!**

**WHAT'S NEW?**

**HO-N-O scales**

**Blair Line**

MRHMAG.COM

- TABLE OF CONTENTS
- INDEX

# Available Now!





# MRH Q-A-T

column

compiled by  
**JOE BRUGGER**  
.....



[Click here for  
reader comments](#)

## QUESTIONS AND ANSWERS

### Lettering wear

**Q.** I'd like to weather my model, but would like to achieve a faded look with the numbers before I do. Any techniques and experiences by forum members will be appreciated.

—Deemiorgos

**A.** There are as many ways to fade lettering as there are projects and model builders. Decal lettering will generally be more fragile than painted lettering.

**Engineer:** I'm using some scrubbing powder for this effect, sometimes dry, sometimes with water. It's based on pumice powder. My attempt with a fiberglass brush scratched the surface too easily.

**Graeme Nitz:** Try a glass fiber brush. Use a light touch and work carefully! See Micro-Mark or [all-spec.com/products/267.html?gclid=CN-r\\_86hy8cCFZU2aQod\\_fgAqw](http://all-spec.com/products/267.html?gclid=CN-r_86hy8cCFZU2aQod_fgAqw).

▶ MRH QUESTIONS, ANSWERS, AND TIPS

## MRH Q-A-T | 2

**Matt:** I see two different things going on here. There is chipping, flaking etc. of the paint and then there is the fade. To get the chipping and flaking, I've used toothpaste, fine sandpaper, and fiberglass brushes. Try them on some junk cars to get a feel for what gives the effect you need. For the fade and change from white, I use transparent acrylics and washes. I'd try red oxide and white works pretty good on red or blue lettering. Some raw sienna can help get the dusty, dirty look.

**Deemiorgos:** I forgot to mention that my numbers are decals, not printed. I'll decal an old junk car, then experiment on the decals. It will certainly be a challenge on a caboose I have, as one side has the numbers sealed under a clear coat and the other side has unsealed decals. I guess the trick is not to tear the decal.

**Hobbez:** For decals or printed lettering, I mix up a shade of paint just a tiny bit lighter than the base car color, and airbrush



1. Here is lettering faded with an airbrush. For chipped and rusted lettering, sand the letters first or add rust colored spots during the weathering, as on this Union Pacific hopper. *Dave Branum photo*



it very lightly over the printing. Achieves the same effect as a wash basically, but I never seem to have good luck with washes.

**Joe Atkinson:** To add to what Hobbez stated, another option is to mix up that paint (thinned) and then dab it over the decal with a piece of foam like the inserts that used to come in blue box Athearn kits. This can represent either faded lettering, using the same paint as the base color, or a worn patch that's revealing old lettering beneath. That's how I faded the original larger cab numbers on my first iteration of IAIS 303 before applying the later touched-up numbers.

**Steve in Iowa City:** To weather the car, you don't necessarily have to worry about the numbers first. A fade with an airbrush can establish a lighter shade of the base color and dull the white letters simply with a thinned white or beige. Next, hit it with a thin wash, then another light subtle hint-of-an-airbrush pass of a thinned grimy (black/dark grey/umber) color. Add some very slight rust streaks and some dry-brushed highlights of the same rusty color lightened with a touch of white. Powders can work too, but I'd certainly do a slight fade with an airbrush before anything else. If you're going to "attack" the numbers decals, then do so lightly and check it often. It's hard to fix it if you do too much at first.

Many more weathering photos, much discussion, and Deemiorgos' successful experiments on his own projects, are at [mrhmag.com/node/23510](http://mrhmag.com/node/23510).

A couple of notes: Comet or Bon Ami abrasive cleansers are also worth an experiment. Work slowly and check your progress frequently to avoid overdoing the effect. If you use a fiberglass pen, use a damp cloth or small vacuum to clean up the fiber dust, which is a danger to your skin, eyes, and lungs.

## Radius of layout turns

**Q.** Now that I have found most of my trains are going to be about 30 to 40 cars, or about 30 feet long, I need some input on radius. My initial thoughts were for 36 inch but what is a reasonable radius without wasting space and for realistic running? Space is not so much an issue but just because it's there I don't want to waste it. What will allow for long trains but not waste basement space?

—blackandorange

**A. Dave Branum:** I'd go with as wide of curves as possible if appropriate based on the prototype you are modeling. Is it a straight railroad or a curvy location? Curves are not a waste of space if the modeled line is curvy; in that case they are more realistic than straights. My last O scale layout had a 46-inch radius mainline. If I build my new layout in S scale it will also have 46-inch radius, or, if I build in HO scale about 42-inch radius. HO trains look a lot better on 42-inch curves than the O trains do on 46 inches. My small N scale layout has 19 inches, which is also pretty decent looking.

**Rob in Texas:** Our club has curves that were initially set at 30-inch radius in HO scale. The temptation by some of the original builders to short-change this from time to time has resulted in some that are sharper.

I would ask what type of equipment you are planning. The longer the equipment, the better it looks on bigger curves. After running my 1950s era equipment with nothing over 85 feet in length, I would agree with 42-inch radius as a minimum. Articulated steam looks better on big curves and should you ever get the urge to move your era or time period back, you will

enjoy it. If you don't, your existing equipment will still look better and run better on the bigger curves.

If you only have space for 30-inch radius, build your layout and realize that it will not look as good as it could with the bigger curve but you might get much more railroad in the space you have.

Generally the biggest curves you can fit will be the most reliable and best looking. You can also use sharper curves once you leave the mainline and go to industrial tracks, as you will be using smaller cuts of cars and smaller engines generally to perform switching operations.

**Bill Brillinger:** If space is not an issue, make the curves as large as possible. It's more realistic, more pleasing to run on, operates better, and just plain amazing! My largest curve has a 61.6" radius and it's fantastic to watch trains on it.

**Daniel:** You can also get away with a tighter radius if you broaden the transition from curve to straight track with an easement. If your arc is say 30-inch radius, increase that radius to 36-inch as you ease into the 30-inch overall radius.

**Prof. Klyzlr:** I suggest a read of one of the earliest articles published in MRH: see [mrhmag.com/mrh2009-01/curve\\_insights](http://mrhmag.com/mrh2009-01/curve_insights).

**Joe F.:** Yes, check out the curve radius article in issue 1. It has exactly the answer you are looking for. It outlines how to set radius based on equipment length, and it works for all scales. You select the performance and realism you want for your equipment, and you know what radius you need. No guesswork. It is all there in black and white.

**D94R:** Viewing angle has a big part in how toy-like your curves make your equipment appear. From eye level a sharper curve isn't as noticeable.

Once you understand all the trade-offs involved, picking your radius as a multiplier of your equipment length is very simple. You now go into the selection of radius with both eyes open, knowing what to expect because you picked your radius based on your specific equipment, not some arbitrary number that just sounded good.

Read the full discussion at [mrhmag.com/node/23824](http://mrhmag.com/node/23824).



## TIPS

### Models in foam-lined boxes

Over more years than I care to count, I have seen friends pull a model locomotive or car out of a foam-lined box and toss away the clear plastic sheet that wrapped the model. Others rolled their model up in the plastic, folding over the ends. This made sense, for without the plastic sheet small protruding parts can catch on the foam and be damaged or broken off.

But then, in the 1970s I bought a Liliput (of Austria) plastic locomotive that came in a foam-lined box. A little instruction paper showed their recommended method of wrapping the model.

1. Lay out the clear plastic on a flat surface.
2. Place the model about in the center of the plastic sheet.
3. Take hold of the upper and lower edges of the plastic and lift, sort of like a little sling.
4. Lower this into the foam-lined box.
5. Fold over the excess plastic.
6. To remove the model, just take hold of the two plastic sheet “lips” (edges) and lift the model out of the box.

# MRH Q-A-T | 7

It is easy to pull the model out of the box, and there is virtually no rubbing of the model's finish. As far back as the 1970s,

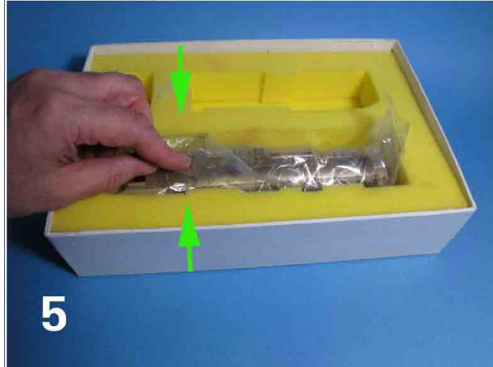
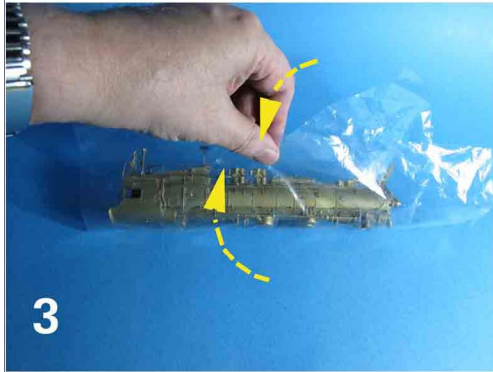
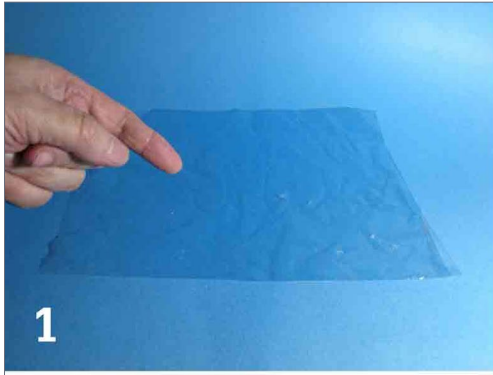

2. Six simple steps create a clear plastic cradle to wrap and handle brass models.

we began to see that some of the oldest foam used to line model boxes had deteriorated and crumbled, in some cases staining the model. Wrapping in plastic would have prevented the crumbling foam from damaging the model, and as more old foam-lined boxes now exhibit the crumbling problem, the plastic wrap has become even more important.

An engine I had wanted for a long time was shown on eBay at a good price, and I won the auction. When I received the box, I opened it with a cloud of dust rising from inside. Almost all the foam had dried out and crumbled. There was no plastic sheet. I brushed off the model, but the foam was all the way into the bearings and the open-frame motor. I invested a couple of hours trying to brush off the model which was full of foam, even inside the frame and boiler. I decided it wasn't worth the effort. I had to send the model

*Happy Holidays*

YD  
Yankee Dabblers.Com

**Greatest  
Year-End  
SALE**  
*(while supplies last)*

Click to see our ....

HO  
DCC  
All Scales

Click to see specials  
in these categories

- Digitrax
- SoundTraxx
- Kadee
- NCE
- And more!

**HOT!**

## MRH Q-A-T | 9

back, and advised the seller to carefully wrap his other models (from an estate sale) and not to ship them in bad foam.

There is often little warning that foam is deteriorating. [reboxx.com](http://reboxx.com) has packages of printed or unprinted clear plastic sheets at inexpensive prices. Otherwise, cut an inexpensive gallon-size plastic bag along its edges and use the plastic sheets to wrap models. Reboxx also sells foam blocks and pre-fitted foam in well-made replacement boxes for most brass models.

—Victor Roseman



**Click here for  
reader comments**

December 1906?  
CLICK TO KNOW MORE

**HAPPY  
HOLIDAYS**  
FROM OUR FAMILY  
TO YOURS

**M** **micro scale**  
**industries**

Proudly made in the U.S.A.  
Since 1933

[f](https://www.facebook.com/microscaleindustries) [www.microscale.com](http://www.microscale.com) [t](https://twitter.com/microscaleindustries)



## GET PAID FOR YOUR TIP

We pay \$25 per tip we publish, or \$40 each if the tip also includes a photo or finished drawing. [Click here and select article type TIP.](#) ■  
.....



**Click here for  
reader comments**

ADVERTISEMENT



Announcing  
***Motrak Models Flat Paint  
Made by Scalecoat:***

Rail Brown – White – Black - Silver  
Aluminum – Oxide Red – RR Grime #1  
RR Grime #2 – Boxcar Red – Roof Brown  
Aged Concrete – Dirt – Sand - Rust  
MOW Gray – Engine Black

Limited quantities - place your order now!

We still have other colors available from Scalecoat.

**Phone number: 813-476-4784**

**Email: [motrakmodels@centurylink.net](mailto:motrakmodels@centurylink.net)**

**CHECK  
IT OUT!**



**CORNERSTONE****YOUR SOURCE FOR  
REALISTIC BRIDGES****HO SCALE****NEW SINGLE-TRACK RAILROAD GIRDER BRIDGE KITS****MARCH 2016 DELIVERY (UNLESS NOTED)**

- Part of the new Cornerstone Engineered Bridge System
- Fits steam-, diesel- and modern-eras
- Available in four common lengths to match prototype practice
- Perfect as approach spans for bigger Cornerstone and other bridge kits
- Build with open or ballasted deck
- Add to new or existing scenery with Center Piers (933-4550) and Abutments (933-4551) available separately
- Use with Walthers Code 83 Bridge Track (948-886 or 948-899, both sold separately) plus flexible, sectional & hand-laid track or your own rail
- Detailed plastic parts molded in dark gray

**SINGLE-TRACK RAILROAD THROUGH GIRDER BRIDGE KITS  
JANUARY 2016 DELIVERY**

933-4501

933-4500

933-4500 30' \$17.98  
 933-4501 50' \$19.98  
 933-4502 70' \$24.98  
 933-4503 90' \$29.98

**SINGLE-TRACK RAILROAD BRIDGE  
CONCRETE PIERS**  
933-4550 pkg(2) \$19.98  
JANUARY 2016 DELIVERY**NEW DOUBLE-TRACK RAILROAD  
BRIDGE CONCRETE PIERS**  
933-4552 pkg(2) \$24.98**SINGLE-TRACK RAILROAD BRIDGE  
CONCRETE ABUTMENTS**  
933-4551 pkg(2) \$19.98  
JANUARY 2016 DELIVERY**NEW DOUBLE-TRACK RAILROAD  
BRIDGE CONCRETE ABUTMENTS**  
933-4553 pkg(2) \$24.98**NEW SINGLE-TRACK RAILROAD DECK GIRDER BRIDGE KITS**

933-4505 30' Standard Level \$17.98  
 933-4509 30' Low Level \$17.98  
 933-4506 50' \$19.98  
 933-4507 70' \$24.98  
 933-4508 90' \$29.98



933-4508

**NEW BRIDGE SHOES AND  
ADAPTER ASSORTMENT**  
933-4559 \$9.98

- Multiple styles of bridge shoes, pedestals & shims
- Simplifies aligning & combining Cornerstone bridge kits for more realism

Click here for  
 more information  
 on the Cornerstone  
 Engineered Bridge  
 System!

**WALTHERS**Support your local hobby shop • visit [walthers.com](http://walthers.com) • call 1-800-4-TRAINS

Delivery date, availability and prices as shown were accurate at press time, for updates visit [walthers.com](http://walthers.com).  
 Preproduction models shown assembled and painted, some details and colors may vary. ©2015 Wm. K. Walthers, Inc.

**MRHMAG.COM**

- **TABLE OF CONTENTS**
- **INDEX**

# ZEPHYR xtra™

\$255 MSRP



All-In-One Throttle / Command Station /  
Booster to run your layout!

# Super EMPIRE BUILDER xtra™

\$355 MSRP



Super Empire Builder Xtra has everything you  
need to get started in Advanced Digitrax  
Command Control.



# Get Better Sound from your Locomotives

Can't get a good sound from your sound decoder?  
Give our speakers a test drive with your ears.



**RAILMASTER HOBBIES**  
**9812 BELMONT**  
**BELLFLOWER, CA 90706**

Bass Reflex  
Speakers



High Bass  
Speakers



When it comes to speakers we have high quality speakers to fit many different applications.

We are also a full line hobby shop. Need anything? We are an authorized dealer for Soundtraxx, Digitrax, Athearn, Walthers and many others. We provide quality speakers for your DCC sound systems and quality service.

**Click here for  
the answer ...**



# DCC IMPULSES

column

BRUCE PETRARCA  
.....



[Click here for  
reader comments](#)

## DETAILS OF DCC CONSISTING

**IN A PRIOR COLUMN, I DISCUSSED A BIT OF** consisting in the *Mr. DCC's Workbench* segment. This month, I'm going to dig into it a bit more with specifics for different brands of DCC systems.

But first (insert trumpet fanfare here), this is a milestone for me. I have been writing this column for four years as of the October 2015 column. There were a couple of columns missed along the way, so this is my 48th column. Wow, time flies, doesn't it?

Let's get our heads out of the publishing world now and back to model railroading and DCC.

What is a consist? I was discussing this column with my wife, Linda, and she asked, "Do your readers know what a consist is? I really don't, but I hear the term all the time."

So, let's get this out of the way. Prototype practice refers to the make-up of a train as the consist. Model railroaders refer to

► DCC TIPS, TRICKS, AND TECHNIQUES

## DCC IMPULSES | 2

two or more locomotives that are running together as “a consist” or as being “consisted.” We also use “consist” as a verb: “I’ll consist the two locos.”

Okay, you want some locos to run together. How do we do this?

One thing to remember with consisting: the closer the match between locos (brand, model, decoder model, and settings), the more successful the consist. If you are having issues with locos not running well together in a consist, check out the characteristics of your various decoders. Some brands of decoders change their running characteristics when they are in a consist vs. when they run by themselves. And, yes, I use

ADVERTISEMENT



SOUNDTRAXX®

### Fun Features for a Fraction of the Cost!

As the most versatile, feature-packed sound decoder, Econami redefines *value*. Starting at \$79.95 and available now!



Hear how you can get more for less!



# DCC IMPULSES | 3

BEMF in my consists. If the locos are properly matched up, BEMF works just fine.

Some of these methods utilize the “consist address” stored in CV 19, per NMRA recommended practices. Frequently I hear about folks having a solo loco or two that they can control the sound and lights, but won’t run. If CV 19 is any value other than zero, the motor will only respond to commands on that consist address. To restore motor operation after CV 19 has been manipulated by you or a command station-assisted consist, go to the programming track and set CV 19 to zero.

## Basic Consisting – brute force

If you have a set of locos that you want to run together, you can give all the decoders the same address (whether it is a short or long address). If you want a loco to run backwards, change its direction of operation by adding one to CV 29, if it is even, or subtracting one, if CV 29 is already odd.

1. The DH83FX (blue wrap) was a flagship decoder from Digitrax until it was retired in 1998 - 17 years ago. The LE1000 (bare board) was an economy model when introduced in 2004. Both decoders support all consisting methods in this column. Neither supports CV21 or CV22 (consist function control).

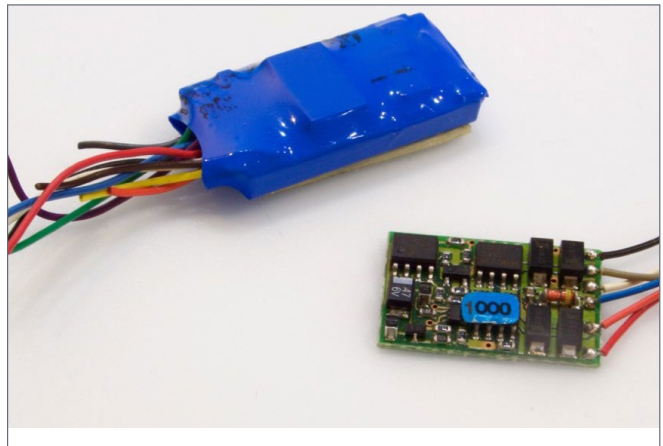

## DCC IMPULSES | 4

Basic consist doesn't require any special features in the decoders [1]. It creates a consist that is virtually bulletproof. It will work on any DCC system. It doesn't require any special input to the DCC system. Just dial it up and run. It only uses one location in the system memory, no matter how many locos are in the consist.

The downsides to basic consist include the fact that the setup is a bit complex, having to set the addresses and running directions in each of the locomotives individually. Also, it is not easy to add or subtract a locomotive from the consist, so you can't run one of the locos outside the consist without doing some basic programming.

Basic consist is, also, what you are doing when you install two decoders in the same locomotive and give them the same address. It is more difficult to do with two decoders in the same loco than it is with one decoder in each of several locos. With one decoder per loco, you can physically separate the locos to program them. When you install two decoders in the same loco, you need some physical or software method to divide them to program them individually. I discussed a software method to do this in my July 2012 column ([issuu.com/mr-hobbyist/docs/mrh12-07-jul2012-01?viewMode=presentation&mode=embed](http://issuu.com/mr-hobbyist/docs/mrh12-07-jul2012-01?viewMode=presentation&mode=embed)).

### Advanced consist – decoder-based

Most decoders these days [1] support the use of CV 19 as a way for the decoder to know that it should run on a consist address and which direction it should run. CV 19 consist is based on the NMRA standard practices. Most of modern decoders also support the use of CVs 21 and 22 to tell each locomotive which functions it should respond to from the consist address and which need to be addressed to the locomotive directly on its main address.



The screenshot shows the 'Consist' configuration panel in the DCC Impulses software. The settings are as follows:

Consist Address (0-127)	103	Consist Acceleration Rate (0-127)	0
Loco Direction In Consist	Reversed	Consist Acceleration Sign	Add value to base acceleration rate (increases acceleration delay)
		Consist Braking Rate (0-127)	0
		Consist Braking Sign	Add value to baseline braking rate (increases braking delay)

Will decoder respond to function requests at consist address?

Consist Address Activation for F0(f) in Forward	Respond to consist address
Consist Address Activation for F0(r) in Reverse	Respond to locomotive address only
Consist Address Activation for F1	Respond to consist address
Consist Address Activation for F2	Respond to consist address
Consist Address Activation for F3	Respond to consist address
Consist Address Activation for F4	Respond to consist address
Consist Address Activation for F5	Respond to consist address
Consist Address Activation for F6	Respond to consist address
Consist Address Activation for F7	Respond to consist address
Consist Address Activation for F8	Respond to consist address
Consist Address Activation for F9	Respond to consist address
Consist Address Activation for F10	Respond to consist address
Consist Address Activation for F11	Respond to consist address
Consist Address Activation for F12	Respond to consist address

2. DecoderPro screen shot – setting up CVs 19, 21 & 22 within the Consist panel from the PCMRC layout. Note that this decoder supports different acceleration and deceleration (braking) rates for the consist vs. the decoder alone. Also, note that Consist address response for F0R is disabled for the consist, but will still work when the loco is operating by itself. This is the trailing loco in the consist and runs backwards, so the Loco Direction box shows “Reversed.”

For example, we have double- and triple-headed power on the through-trains for our club ([pcmrc.org](http://pcmrc.org)). The through-trains have train numbers that are less than 127. So we’ve used the train number as a consist address and programmed it into CV 19. See [2] for the rear loco on train 103.

If the loco runs backwards in the consist, we tell the decoder that in CV 19, too. Then, in CVs 21 and 22 (bottom of [2]), we tell each loco what function commands they should respond to.

# DCC IMPULSES | 6

For example, we tell the loco at each end of a double-headed consist not to respond to the FOR (reverse light) function. That way, we don't have the lights on between units.

Units that are set up this way take only one system location, and they can be moved between systems with impunity, just like the basic consist. Once CVs 21 and 22 are setup, locos can be added to or taken out of the consist by merely programming CV 19 on the main.

Since our club uses Digitrax, we empty the slots after each operating session to minimize throttle conflicts. See Mr. DCC's Workbench from last month's column ([mrhpub.com/2015-11-nov/port](http://mrhpub.com/2015-11-nov/port)) for more info on that. Purging the throttle assignments

## ADVERTISEMENT

**RailPro™**  
**NEW TECHNOLOGY**  
DIRECT™  
RADIO

**RE RING ENGINEERING**  
RailPro™  
Power ON  
Main Page  
Handheld Controller Model # HC-2

Control Locomotive (CO) [Battery Icon] [Forward Arrow]

17.6% [Link Icon]

UP 5714 [Info Icon]

Frnt Light Dim Dilch Pop Off Next Page 1  
Horn Bell Engine Back Light Exit Page

**RE RING ENGINEERING**  
**NEW Starter Kit**  
**\$399.99 MSRP**

- Includes Wireless Color Touch Screen Handheld Controller and 56 Watt Power Supply
- Expandable to Virtually any Size Layout

**NEW Locomotive Module**  
LM-2 & LM-2S

**RailPro™**  
Model # LM-2  
RE RING ENGINEERING

- Direct Radio RF
- Sound and Non-Sound
- New Tiny Size
- 6 Light Outputs

**Click Here to Learn More**

For more information visit our Internet site: [www.RingEngineering.com](http://www.RingEngineering.com)

MRHMAG.COM

- [TABLE OF CONTENTS](#)
- [INDEX](#)

could drop Digitrax UniVersal consists, but these manually created advanced consists are unaffected.

## DCC system assisted consisting

Many DCC systems [12] help you to set up an advanced consist. Some merely lead you through setting the consist address in CV 19. Some assist with the break down as well, by resetting CV 19 to zero in all the decoders together with a few button presses. Some remember the consists built this way and others require you to remember what you did. The support varies between manufacturers. The realism of the running experience varies between DCC brands, too.

Some DCC systems [12] offer support for Universal (or old-style) consists. These euphemisms refer to how the command station remembers which locos run together, and sends the motor commands to all locos in the consist. This style became popular before the NMRA standardized on CV 19 as a consist address. Again the support varies by manufacturer. Most decoder and system manufacturers have trended away from universal consisting as advanced consisting has taken hold. Newer decoders support CVs 21 and 22 to separate function commands, thereby enhancing the operating experience.

I highly recommend you break down any consist on the system where it was built before moving the locos to another layout. Failure to do this may leave you with locos that you cannot talk to for no apparent reason. You may have forgotten that you had it in a consist. When all else fails, take your loco to the programming track and read CV 19. If CV 19 is not zero, then the loco still thinks it is in a consist. Set CV 19 to zero to remove the loco from the consist. This will not undo anything stored in the DCC system where you built the consist, but it will free up your loco.

# DCC IMPULSES | 8

In recent columns, I have discussed the features or drawbacks of two manufacturers' systems. This raised the hackles of some readers. So I contacted many manufacturers for input to this column and got varied responses from them. Let's look at the details of their systems.

Here are some different DCC systems and how they deal with consists. They are listed alphabetically.

## Digitrax

Digitrax only offers what it calls UniVersal (yes, that's the way they capitalize it) command station assisted consisting. It is easy to set up on their DT40x series throttles [3]. UniVersal consists can be built with the Zephyr system, too. However, due to the limited display and available buttons, it is more difficult to do there than it is on the DT40x throttles.

As previously discussed the Digitrax system will readily handle advanced consists that you create manually. We have been running advanced consists on our Digitrax club layout for years.

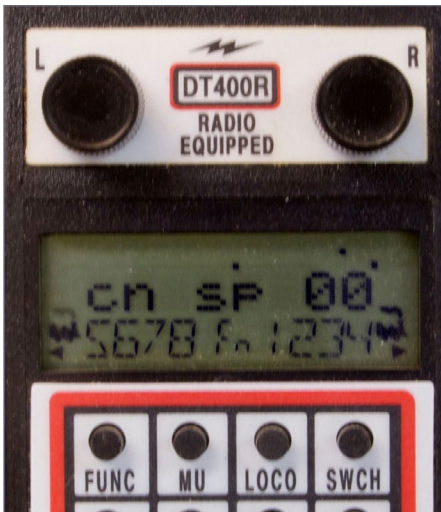

3. UniVersal consisting on a Digitrax DT400R throttle – 1234 is in the lead and 5678 is in the rear, with locos facing away from each other. Yes, they read from right to left. The right button is the “master” and that’s where the consist starts. This screen shot is what it looks like after pressing the MU button and then the + button.

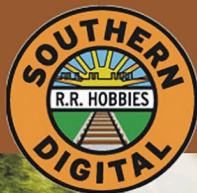

# Southern Digital



**20% Discount  
on most Items!**

*Specializing in DCC Since 1992*



## DCC Conversions, Service & Support

Orders Received by 3:00 pm EST ship the same day

**WWW.SODIGI.COM**

E-mail: [sales@sodigi.com](mailto:sales@sodigi.com)

(770) 929-1888

*(Photo's are from our N-Scale layout)*

# DCC IMPULSES | 9

To set up a UniVersal consist, select the lead loco on the right knob and the next loco on the left. Then adjust the direction of each loco until both are physically going the same direction on the track. Then, press the MU button then the + button (in the row below the MU key). To add more locos, select the new loco on the left knob and set its direction and repeat the MU and + button presses.

To remove a loco from the consist, select the consist on the right knob and the specific loco to be removed on the left knob and press MU then the - (next to the +) key.

While this is simple to use, it takes up a system slot for each loco in the consist. If you have a limited system like the Zephyr, with only 10 slots, you can run out of slots very quickly.

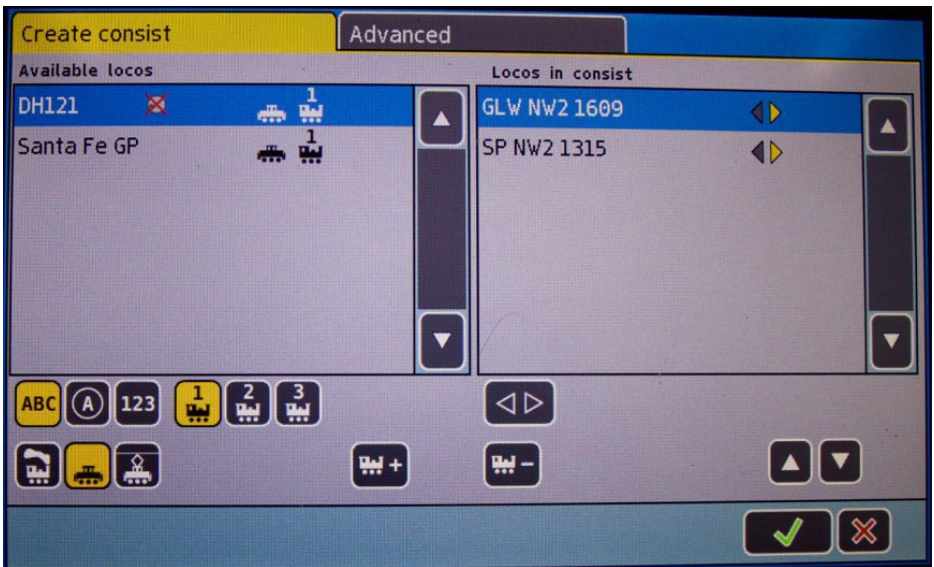

4. ESU ECoS system setting up a consist between two locos (1315 & 1609).

## Easy DCC

Yes, all you Easy DCC fans out there, I was looking out for you and contacted CVP for input to this column. As I am finishing this column in mid-November, they have not gotten back to me. Since I don't want to make unsubstantiated claims, I have nothing to share with you. Sorry.

## ESU

The ECoS system builds (universal) consisting. It is set up fairly easily using their color touch-screen command station [4].

The ECoS system does not assist the user in building advanced consists. As with any DCC system, it will support them if you build them manually, through programming CVs 19, 21 and 23.

ADVERTISEMENT



**IOWA SCALED**  
**ENGINEERING**

Enhance Prototype Realism  
Electronics for "Your" Model Railroad

- Switch Machines
- Time Lock Controllers
- Fast Clocks
- Sound Players
- Infrared Detectors
- Block Detectors
- And more!



LEARN MORE >

ADVERTISEMENT



**TamValleyDepot.com**

Great Electronics for Great Model Railroads



We are loading up the boxcars with  
Frog Juicers ready for your layout!

# DCC IMPULSES | 11











Once the consist is built, it is in the database in the command station and is selected in the same manner as any loco.

I haven't found a way to differentiate which locos respond to which function commands with the ECoS system.

Breaking down the consist is pretty straightforward. Once it is selected on a throttle, tap on the little wrench icon and tap on the DELETE LOCO pop up, exactly the same way you do when deleting a loco from the database.

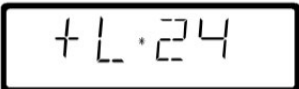
## Lenz

Lenz offers Universal consisting, called a double-header. It requires a LH100 throttle. Double-header, as the name implies, is only usable for two-locomotive consists.

Press	On the display you see	Explanation
	The most recently chosen menu is shown	
		The most recently selected locomotive address is displayed
		This is the prompt to enter the second locomotive address of the double header.
		Enter the number of the second locomotive. If you make a mistake when entering, you can clear the entry with 'Cl' and correct it.
		
		'Enter' combines both locomotives to a double header and returns you to the operation display

5. Excerpt from the Lenz LH100 manual - how to build a double-header, starting with loco 78 and adding loco 24.



# DCC IMPULSES | 12

Press	On the display you see	Explanation
		Call up the first of the locomotives that you want to include in a MU.
	Display shows the most recently selected menu	
		The prompt for entering the multi-unit consist address is shown
		Key in the number of the MU. This number can only have two digits.
		If a mistake is made, then you can clear the last digit with the 'Cl' key and make corrections.
		The direction arrow now blinks. At this point decide which direction the locomotive will enter relative to the consist direction.
		Pressing the '<>' key will change the blinking arrow to point down. This means that the locomotive will enter the consist in the reverse direction. Moving the consist forward will cause the locomotive to move backwards.
		Pressing the '<>' key again causes the blinking direction arrow to now point up or forwards. The locomotive will now enter the consist moving in the same direction as the consist.
		The "E" in the display now changes to a small "m" to show you that this locomotive is in a MU

6. Excerpt from the Lenz LH100 manual - how to build a Smart Consist (MU), starting with loco 1234. This process is repeated as many times as necessary to get both locos into the consist.

## DCC IMPULSES | 13

There are detailed instructions in section 7 of the Lenz LH100 manual ([lenz-elektronik.de/pdf/b\\_21100\\_e.pdf](http://lenz-elektronik.de/pdf/b_21100_e.pdf)), as shown in [5].

There are a few memory locations in the Lenz command station (in some cases only one) for double-headers. You may run out of capabilities if you want to run a bunch of double-headers.

Smart Consisting is the Lenz name for advanced consisting. It is also referred to as MU or multi-unit consisting within the Lenz documentation. Either the LH100 or the LH090 throttle can be used to set up Smart Consisting. All decoders must be in 28-speed step mode.

Smart Consisting uses one locomotive address in the command station for each loco consisted and one for the consist address. Fortunately, Lenz systems have 256 locomotive address slots, or registers. You are unlikely to overload your system's capabilities with a few Smart Consists.

There are 99 consist addresses (1-99) available. Any locos on the layout with short addresses will reduce your choices for the consist addresses. There cannot be any address conflicts, or you will end up running a loco and your consist at the same time. You get to choose the consist address as part of the setup process. Selecting any loco in the consist gets you to the stored data, so you don't need to remember (or write down) the consist address.

To set up a Smart Consist with your Lenz system, I refer you to the manual for the model of throttle you will be using. The LH100 and LH090 throttles both can set up Smart Consists. The methodology is much easier with the LH100 [6], so I'll talk a bit about that here.

The procedure covered in section 8 of the LH100 manual ([lenz-elektronik.de/pdf/b\\_21100\\_e.pdf](http://lenz-elektronik.de/pdf/b_21100_e.pdf)) shows how to add one loco (1234) to a MU, as the manual calls it. Note that you set the direction of

## DCC IMPULSES | 14

operation of the locos in the consist individually in this process, allowing back-to-back or elephant-style consists, or a mix of the two. The process is repeated as many times as needed to get all the locos into the consist.

Once you have the consist together, you can get it to move by calling up the consist address (33 in [5]) or the address of any loco in the group. If you want to activate functions (lights or sounds), you need to be addressing the specific loco that you want to change.

### MRC

The MRC Prodigy Express<sup>2</sup> system automates the advanced consisting somewhat [6]. It will set the consist address of your choice and the direction of running into CV 19 of the locos you select. However, this system does not remember consist addresses or their relationship to locomotives. As you can see in the instructions [7], the manual specifically tells you to write it down.

1. Press **PROG** until "Cons SET" flashes in the LCD display. Then press **ENTER**.
2. "Cons #" will display, prompting you to enter a consist number. Enter a consist number (a short address 1-127) followed by **ENTER**.  
*Write down the consist number. You will need it later to clear the Advanced Consist.*
3. "Add Loco" will display, prompting you to add a loco into the consist group. Enter the address of a loco you want to add. Press **DIRECTION** if you want the loco's direction reversed (forward is the default setting). Then press **ENTER**.
4. "Add Loco" will display again, prompting you to add another loco into the consist group. You can add as many locos into the consist as you would like. To end programming, press **ENTER**.

7. Instructions for setting up an advanced consist with the MRC Prodigy Express<sup>2</sup> DCC System.

# DCC IMPULSES | 15

The MRC system also automates breaking down the consist. All it takes is a few button presses, but you must manually enter the consist number. Hopefully, you wrote it down.

If you have a Prodigy Advance Cab, you can create within your Prodigy Express<sup>2</sup> system what MRC calls a Universal (Old-Style) consist. Universal consists are limited to one per system with up to four locos consisted. One loco is chosen as the master loco and the rest of the locos are piggybacked on that loco's address with motor commands being sent to all consisted locos. The Old-Style consists are broken down with a few button presses.

## NCE

NCE automates advanced consisting with some different wrinkles. If CVs 21 and 22 are already set up, they will help control the functions the decoders respond to. The system assigns the consist address automatically [8]. You needn't write it down, as the system will always get you to the consist by the loco numbers included in it. Note that you set the direction of operation of the locos in

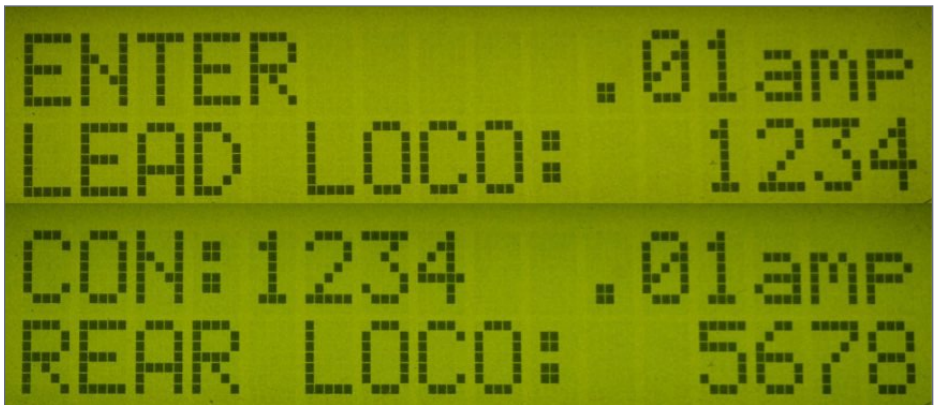

8. Setting up a consist with the NCE PowerCab: 1234 front, 5678 rear.



## 9. Killing a consist with the NCE PowerCab.

the consist individually in this process, allowing back-to-back or elephant-style consists, or a mix of the two.

Here is the slick part. Think about a consist with 1234 on one end and 5678 on the other. If you select 1234 and say, “Go forward,” the consist will move together with 1234 in the lead. When you reach the end of your turn, you run around the train and get set to run back. Selecting 5678, the train will run forward for 5678 (the opposite direction from earlier) when you select forward on the throttle.

You can press the DELETE (consist) button [9] and then enter 1234 or 5678 (or any other loco contained in the consist) and the consist will be removed, as long as the locos are still on the layout.

NCE recognizes any address from 0 to over its throttle capabilities (9999 maximum) as a long address. If you only run your locos on NCE systems, I recommend that you use long addresses for loco addresses, leaving all the short addresses available for the system to use as consists. For example, if you have a loco that has a cab number of 24, you enter 24 as the short and as the long address using the NCE system or DecoderPro and tell it you want to make the long address active. When you want to run the loco, just select 024 on your throttle. The leading zero tells the NCE system that you are asking for the long address of 24.

# DCC IMPULSES | 17

NCE supports (but seemingly discourages) old-style consists. They are set up and broken down similarly to advanced consists.

## Zimo

Zimo has brought out a new system recently. This system uses the MX10 box with the MX32 [10] throttle. This is the system that is currently available. Zimo has not finalized the firmware to allow this system to assist you in building consists. I've been told that it should be in the next one or two software updates. It is expected that the operations will be similar to the prior system, as the MX32 has a T P key on it.



The older system (MX1 box with MX31 [11] throttle) automates universal consisting. The key with the label T P on it is used to add the active loco to the consist or to remove it from the consist.

Addressing any loco in the consist will move the consist and allow control of the functions of that specific locomotive.

As with any DCC system, all Zimo systems will run basic or advanced consists that have been built manually.

10. Zimo MX32 throttle has the T P key (to the left of the slider) available, presumably for future universal consisting.

## Summary

All command stations will run basic consists and advanced consists that you create yourself. Command stations help automate the setup and breakdown of some types of consists. Table [12] shows what each manufacturer supports and what they call them.

With command station-assisted consists [12], loss of command station memory (changing battery for example), will drop the consist information. In this case, it is just as if you took the consist to a new layout; you start over from scratch.

I favor manually created advanced consisting. While it is a bit more difficult to create, it is system-independent and transportable. It uses only one system slot for the consist, no matter how many

locos are in it. If you set it up manually (instead of having the command station do it for you) it will work anywhere. It is impervious to Digitrax slot-purging. However, you lose some command station features, like NCE's ability to select the direction of the consist by using different loco numbers within the consist.



11. Zimo MX31 cab – locos are added to or removed from the consist using the T P key to the left of the slider.

Manufacturer	Advanced NMRA CV 19	Universal Old Style
<b>Digitrax</b>	Not assisted	UniVersal
<b>ESU ECoS</b>	Not assisted	Consisting
<b>Lenz</b>	Smart (MU)	Double header
<b>MRC</b>	Advanced	Universal
<b>NCE</b>	Advanced	Old Style
<b>Zimo</b>	Not assisted	Universal

12. Table showing command station assisted consisting types by DCC manufacturer. “Not assisted” means that the command station won’t walk you through setting up the consist. Any system will run a manually built advanced or basic consist.

## Thanks

Many folks contributed to this column with e-mail and phone support, and by proofreading what I wrote about their products. As you can tell by now, covering all the different ways folks attack consisting was a far bigger maze than I anticipated when I started this column. I didn’t want to make incorrect representations for various systems.

So a tip of Mr. DCC’s hat to the following folks who represent the manufacturers:

- American Hobby Distributors (Lenz Importer): Eric and John
- Digitrax: Dave



- ESU: Matt
- Lenz (Germany): Peter
- MRC: Doug
- NCE: Jim
- Zimo: Art

Folks always seem to have additional ideas to share. Just click on the Reader Feedback icon at the beginning or the end of the column. While you are there, I encourage you to rate the column. “Awesome” is always appreciated. Thanks.

Until next month, I wish you green boards in all your endeavors.



**Click here for  
reader comments**

## ADVERTISEMENT

# Great control in a tiny package



**Original  
Touch Toggles**

- Touch Toggle™ plug in controls
- Bright clear indication
- Easy setup
- Flexible system

Stall Motors, Twin-coils,  
Power, and Servos

Now for Tam Valley Depot  
and MRservo too!



Made in the USA



What will they think of next?

[www.berretthillshop.com](http://www.berretthillshop.com)

# From first train set to railroad empire...

*Our complete line of DCC products  
grows with you. Discover the fun!*

- Designed and manufactured in the U.S.A.
- Preferred for ease of use and ergonomic design
- Unlimited scalability for any size model railroad
- Plug-and-play means more time running trains
- Great customer service and excellent support



## See your dealer



## Visit our new and improved web site for all your DCC needs!

- Get the latest new product announcements
- Watch our detailed how-to videos
- Browse the all-new Information Station
- Enjoy secure online sales, day or night!

Visit **ncedcc.com**





# Announcing our next Limited Run PWRS / Micro-Trains® Cars!!!

**PWRS**

## Chicago Northwestern (CNW)

PS2 3-Bay  
High-Side  
Covered  
Hopper



4-pack

**COMING**  
June 2016

CLICK HERE FOR  
**CNW Hopper**

## Canadian Pacific (CP) & Canadian National (CN)



57' 6"  
Converted  
TOFC Flat Car  
3-packs

CLICK HERE FOR  
**CN/CP TOFC**

PACIFIC WESTERN RAIL SYSTEMS  
**SPECIAL RUN CAR**



## **Pacific Western Rail Systems**

**Check Back... Sale starts December 25<sup>th</sup>**

Earlier for PORTERS Members!



CLICK HERE FOR  
**N Scale**

CLICK HERE FOR  
**HO Scale**

MRHMAG.COM

- TABLE OF CONTENTS
- INDEX



MIKE ROSE  
.....

# GETTING REAL

column



[Click here for  
reader comments](#)

## REMODELING THE LAYOUT, NEXT CHAPTER!

### | GETTING MORE USABLE LAYOUT IN THE SAME FOOTPRINT

**IT WAS RIGHT AFTER A SUCCESSFUL OP** session in late March that I turned my thoughts to “what’s next” on my layout. Op sessions always stimulate creative thinking for me, and sometimes various thoughts from multiple threads coalesce into a minor “eureka” moment. I found myself standing in front of South Towanda, staring at my 25+ year old behemoth of an air conditioning air handler that looked over that entire aisle like a giant predator, hanging from the ceiling, with HO scale tracks timidly tip-toeing underneath, and these different threads started to converge.

My first thought was “Boy, if I have to replace that air handler this June when I turn on the A-C, it’s going to be a massive job and create havoc with the layout.” It was also not lost on me that I’d be going through a lot, and paying a lot, to install the replacement handler right where I did not want it. That got me

▶ **MODELING REAL RAILROADS AND WHAT THEY DO**

## GETTING REAL | 2

thinking about how I'd relocate it somewhere else. The desire to get out in front of this issue soon consumed the rest of March and early April. By that time I'd figured out what to do and tracked down the right A-C guy to work with. At the same time I realized that if I could relocate my water filtering equipment, I'd open up an entire wall of the basement for development!

During the end of April, all of May and early June, that's all I did. I learned how to do metal ductwork, built custom plenums, had half my suspended ceiling tiles out of place, cut out joist sections, opened up walls for new ducts, and worked side by side with my new A-C moonlighting technician friend to complete a massive job pretty much on time. The layout was entirely

### ADVERTISEMENT

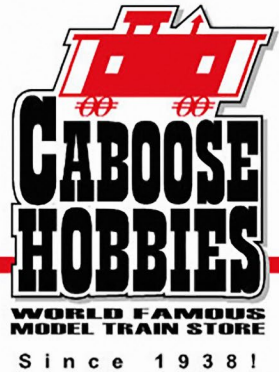

# The World's Largest Model Train Store!

Model trains G to Z, DCC, brass models, kits, RTR, collectable models, scenery, structures, books, magazines, DVD's, hobby tools & supplies and a full service repair department.



[WWW.CABOOSEHOBBIES.COM](http://WWW.CABOOSEHOBBIES.COM)

[MRHMAG.COM](http://MRHMAG.COM)

- [TABLE OF CONTENTS](#)
- [INDEX](#)



**1. What started as a house remodeling project turned into a layout remodeling project as well. Putting some extra thought into the house remodeling allowed layout changes to get more usable railroad space!**

covered with light plastic drop cloths due to the dust created, and it was quite a moment when the tarps finally came off. Those details of the story belong in a home improvement magazine and not a modeling magazine though, so let's zip to what was made possible as a result of this massive effort.

The first of two things I decided was that Grainzilla had to go. This big grain terminal elevator, located on my layout in Monroeton, was nowhere to be seen on my prototype. I was itching to creep closer to prototype modeling in terms of what towns and industries were on my layout. I decided that location would be an excellent place for the big paper mill in Ransom,

## GETTING REAL | 4



2. The air handler, water filters and associated piping. What's not to like?



3. The tarps were an excellent idea! They were removed very carefully after I used the vac with a brush attachment to get most of the fine dust off.





4. Removing South Towanda and related industries and scenery would be tricky to accomplish in a way that would not compromise Towanda itself. The new Tunkhannock scene needed to be completely disconnected since they were nowhere near one another. All of the lower tracks here need to be removed and terminate on the other side of the underpass they emanate from Towanda, off to the right. The rear, higher track is the Conrail main line. The area in the foreground will be moved up to match that height.

PA. It's gone through several owners and today is Cascade Tissue, but in my era it was Potlatch and it was Swanee Paper in Lehigh Valley and early Conrail days.

The second thing I decided had to go was South Towanda. A picture of Tunkhannock in a Mike Bednar book on the LV triggered a memory of a picture Wayne Sittner gave me long ago. I matched them up and sure enough, I had two views of a very interesting area. I saw Wayne at the New England Proto Meet

## GETTING REAL | 6

in June and he gave me a slew of other priceless pictures of Tunkhannock. That cemented the plan. South Towanda was the obvious location for the new town of Tunkhannock!



5. The old scene is almost gone, including the foreground water scene I'd slaved over. The aforementioned underpass is also viewable at the upper right.

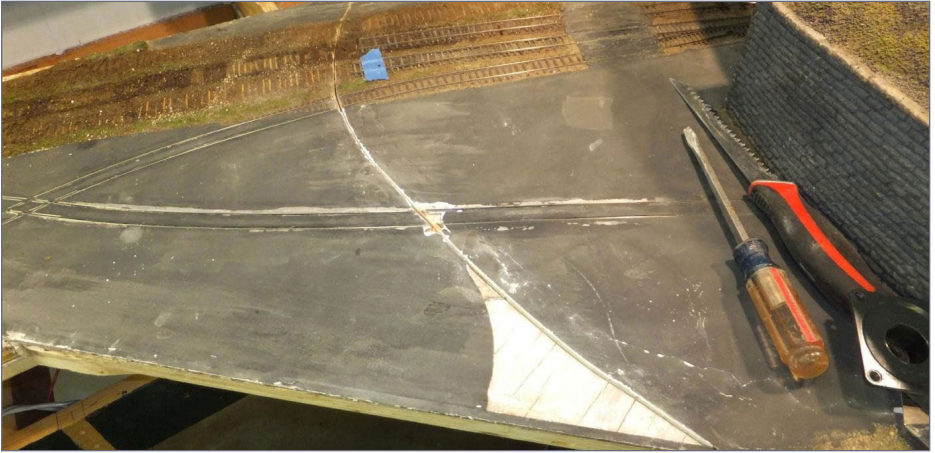

6. A stub of track from under the bridge, marked by the blue tape, is intended to be left as a run-around that won't be seen from this view. I have already started cutting.

ADVERTISEMENT



# Rusty Stumps

Scale Models

WE ONLY SELL WHAT WE MANUFACTURE

**DETAILS** IN HO, O, S  
& N SCALES

LASER CUT SHINGLES, DOORS & WINDOWS,  
FENCES, SIDING, CRATES. Also RESIN and  
WHITE METAL DETAILING CASTINGS.

**CRAFTSMAN KITS**  
IN HO, O & S SCALES

CHECK IT ALL OUT AT  
**WWW.RUSTYSTUMPS.COM**

Send \$3.50 for Catalog - Specify Scale

**RUSTY STUMPS SCALE MODELS**

6785 Cherry Blossom W. Dr., Fishers IN 46038

Phone (317) 595-9489



7. With a clear field of view, you can see the well salt bin and Welltrol pressure tank. Both are both below layout height. I look at that piece of benchwork and recognize wood that came from a house I lived in more than 30 years ago! The benchwork was salvaged when I moved to my present house.



8. I'm removing the former three-track yard at Monroeton, trying to salvage some material. A spray bottle, a wide putty knife, and careful work yielded mostly good results.



**DID YOU  
KNOW MRH  
SUBSCRIBERS GET  
FREE BONUSES?**

**CLICK TO SUBSCRIBE NOW - IT'S FREE!**



9. The former Fall seemed like a logical place to transition from existing benchwork to the area to the right that would connect to the former South Towanda area. With utilities removed, all new benchwork would be used to create the new layout section for modeling Tunkhannock and the area between it and Ransom.

# GETTING REAL | 11



10. I hosed off the gently removed track to remove the old ballast grains. Here it all is drying in the sun. I bought very little new track for this effort, mainly a few turnouts.

ADVERTISEMENT

## Railroad Explorer Magazine

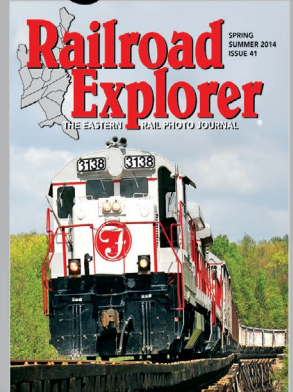
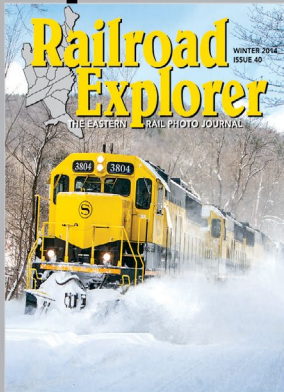
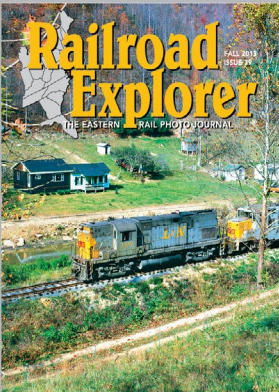

THE EASTERN RAIL PHOTO JOURNAL

- Three all-color issues per year. Exciting feature stories and spectacular photos of Eastern Railroading
- Best-in-class photo reproduction. Printed on heavy, glossy paper. Zero advertising.
- Three times per year - Winter, Spring/Summer and Fall editions.

**Subscribe today!**

[www.railroadexplorer.com](http://www.railroadexplorer.com)

[MRHMAG.COM](http://MRHMAG.COM)

- [TABLE OF CONTENTS](#)
- [INDEX](#)



11. Sometimes a piece of plywood needs to be custom-cut to connect different levels.





12. New benchwork is designed to be at the correct height and wrap around the Welltrol (blue cylinder) to permit its replacement in the future. The front member needed to be removable. You can see how the new benchwork connects to the former Monroeton and extends this level toward the former South Towanda.



13. The former South Towanda needed to be raised. The old benchwork ran off to the right and under completed layout areas, so it was easier to leave it in place and extend new risers and joists to support the new Tunkhannock.

# Tell your friends about MRH!

**We depend on word-of-mouth to grow  
... if you don't share us, we don't grow**

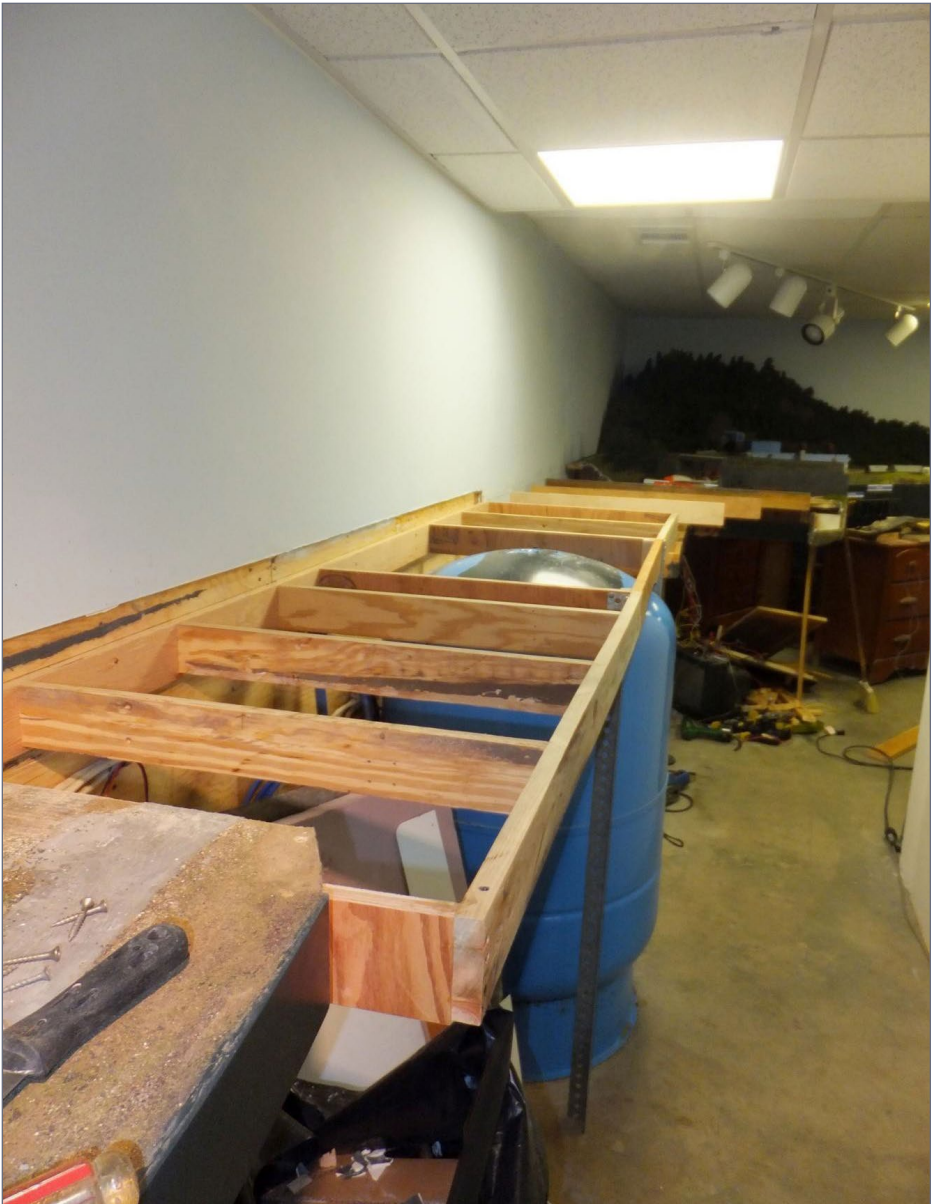

14. Here is the length of the new land to be developed. All of the wall to the left and ceiling and the recessed light fixture are new as well.



15. The pre-punched metal angle iron (one on each side of the Welltrol cylinder) proved to be a perfect small footprint support leg for the new bench work. I made a custom mounting bracket out of wood for the removable front piece. The bracket wrapped around each metal support leg on the left and right of the cylinder.



16. My friend Dave was alarmed when I took a Sawzall to the top of the Welltrol! I called the company on the phone to ask about this nut. It's used in the manufacturing process to allow them to transport the tank during construction and painting. Ask before you saw!



17. I salvaged old ground cover material that had been used at Monroeton. Portions of the road can be re-used it around the new paper plant.



[Click here for reader comments](#)

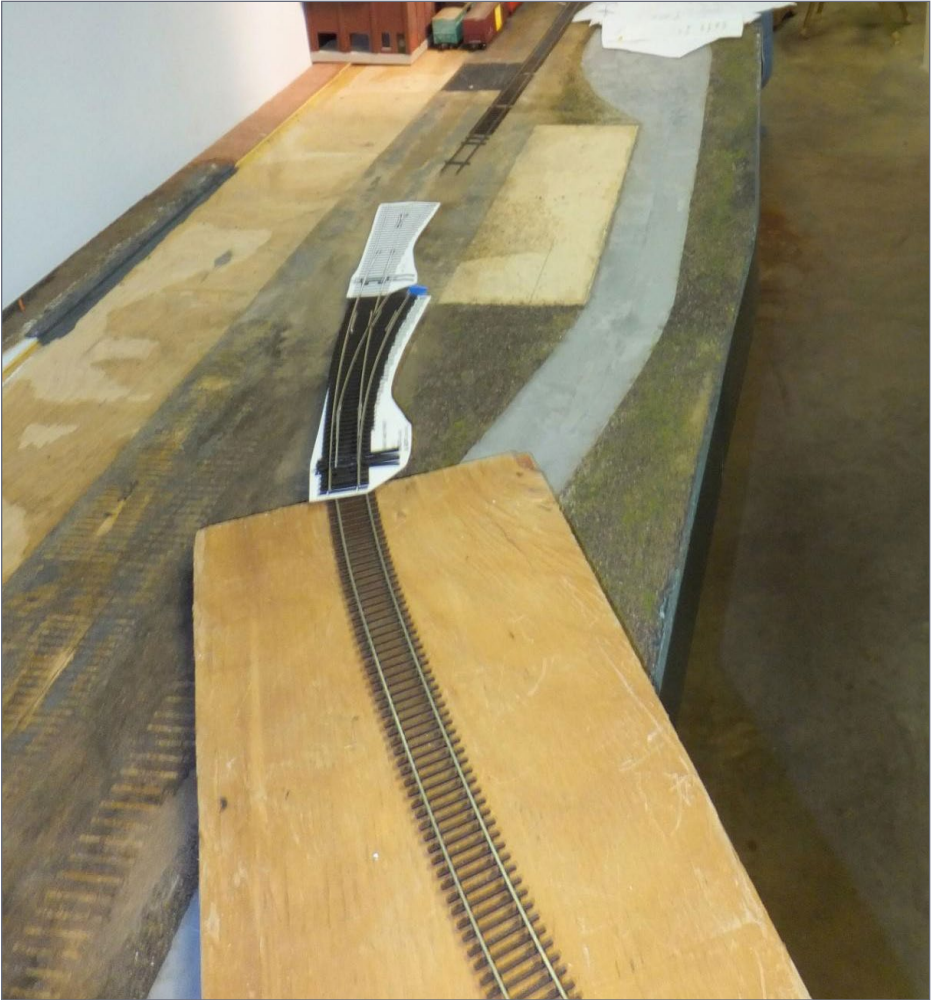

18. With plywood down I began to plan the new main line alignment. With a long straightaway like this, I was determined that the main line would not follow the bench but would meander a bit for better realism. The line I model is seldom straight. At the far end, I determined the way it will come out of the hidden track and into Tunkhannock. In the foreground I'm planning where the track will come ashore from the cross-aisle bridge I need to build.



19. The track arrangement at Tunkhannock is similar to the prototype in many aspects, but if I modeled it exactly, it would not fit. I realized that my available space was the inverse of the actual track layout, so I took the Conrail ZTS diagram, flipped it over, put it on my slide table with a piece of blank paper over it and then traced it. The layout of the track is almost ideal for my spot. I used prototype pictures to refine the track locations vis-a-vis the structures I needed there.



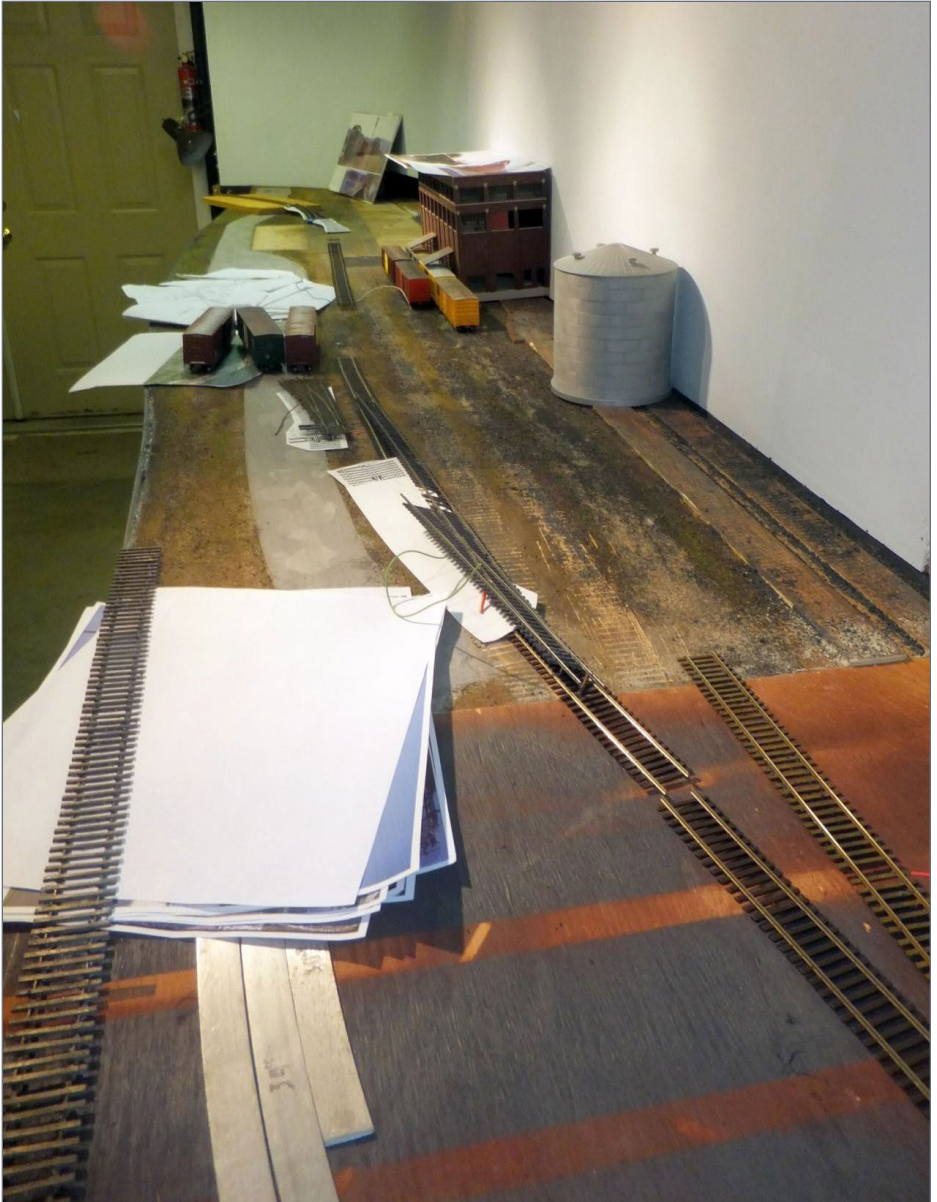

20. Flex track helps to plan the paper mill and its associated tracks at Ransom. Keep this view in mind as the scene develops.



21. This trackside view shows the gulf that needs to be bridged. Ransom is in the foreground, and to the left of the white dehumidifier is where the track needs to reach Pittston staging. The tan door on the right is the main entrance to the basement from my lower driveway. Everyone who attends an op session enters here, so a duckunder will not work.



[Click here for  
reader comments](#)



22. The footprint and shape of the actual bridge could not be totally straight and had to accommodate the curve coming off the existing benchwork. I chose cardboard to create a template for the needed plywood.

**When talking to hobby vendors, please remember to mention MRH.**



23. From staging, I needed a new alignment. The plywood that's clamped here will become the splice plate, and I'm moving some new 3/4" birch ply in from the right to get to the bridge location. Once that is in place, I'll clamp it, trace it onto the splice plate, and then remove excess material.

**Want to help  
keep MRH free?  
Then click on  
Ads!**



24. The new connecting track goes right through some existing shelving. This makes the shelving essentially non-removable, but it's the only choice.



[Click here for reader comments](#)



25. I am using a single piece of birch plywood to make not only the “mainland” portion needed but also the bridge itself. The extra material marked to be removed, and the cut line across show where the hinge will be. The half gallon of mineral spirits is a weight!



[Click here for reader comments](#)





28. The new sub-roadbed is now continuous from staging across the aisle onto the layout in the distance. Note that the bridge hinge and latch points have not been cut at this time.

ADVERTISEMENT

The ULTIMATE Model RR Railfan series!

DVD media

VOL 1 & 2  
DVD set

~~19.99~~  
**\$15.99**

+ shipping/handling

Instant download  
HD format

Volume 1 **\$4.99**

Volume 2 **\$4.99**

Get both  
VOL 1 & 2

**\$8.99**

**SAVE!**

**ALLAGASH**  
Railfan Video Series

VOLUME 1:  
Trackside at New Sharon



- Running time: 29 min
- New Sharon yard switching
- Working local industries
- Road trains through New Sharon



Railfan New Sharon yard for a day

**ALLAGASH**  
Railfan Video Series

VOLUME 2:  
Chasing coal trains



- Running time: 30 min
- Follow various Allagash coal trains
- See spectacular scenic Maine
- Witness dramatic Holman Summit



Railfan coal trains across Maine

from the  
**Model Railroad**  
Hobbyist *Store*



Get the ALLAGASH RAILFAN Videos





29. To prepare for laying the bridge track, I removed all of the scenic material to permit the track to lay perfectly flat coming off the bridge. My staging area is all Custom Trax. The product is no longer available – real wood ties glued to high quality cork roadbed, and ballasted and weathered with code 83 rail spiked in place with a Kadee spiker – so I wanted to use a few leftover pieces to continue the track out of staging and across the bridge.



30. My first step in creating the bridge footings was to make a couple of pieces using 2x6 material that would have the correct orientation to the bridge hinge, and also be firmly attached to the existing benchwork. I notched them around the existing 3/4" deep plywood supporting the plywood on top of the layout, and screwed them to that as well as to the support member.



[Click here for  
reader comments](#)



31. Next, I used a nice piece of vertical grain fir to form the attachment point. This type of fir has the smallest chance of warping of any wood I know.



32. With the fir trimmed, the land area is taking shape and ready for final assembly.

Almost 40,000 have read this MRH forum thread - have you?

[Home](#) / [Forums](#) / [Track and electrical/DCC](#) / [What DCC system do you use - and why?](#)

## What DCC system do you use - and why?

Mon, 2010-08-02 11:03 — [joef](#) [Track and electrical/DCC](#) [DCC - Electrical](#)

I'm curious what DCC system various modelers on here are using, and why? I think it's useful - so post a bit about the system you use and how you came to choose it. Also if you have any learnings, that's always helpful!

**Read  
now**



**Click here for  
reader comments**



33. After drilling all of the holes in the fir, I used high quality square drive woodworking screws to fasten everything together and to mount the hinge and bridge. The design permits the bridge to hang out of way when not in use.



34. On the latch side of the bridge, I needed a very solid support and plastic shelving would not work. I chose to add a piece of supporting plywood, notched as shown, mounted on the concrete floor, and screwed to each shelf on the way up. The plywood sub-roadbed going back into staging has a hefty "T" support.



35. The latch is a simple barrel-bolt type. I wasn't certain this would be sufficient and was prepared to have one on each side of the bridge, but the single catch proved to be very solid. Note how the swing-down bridge also has a supporting "T" member for no-sag performance over time.



[Click here for reader comments](#)

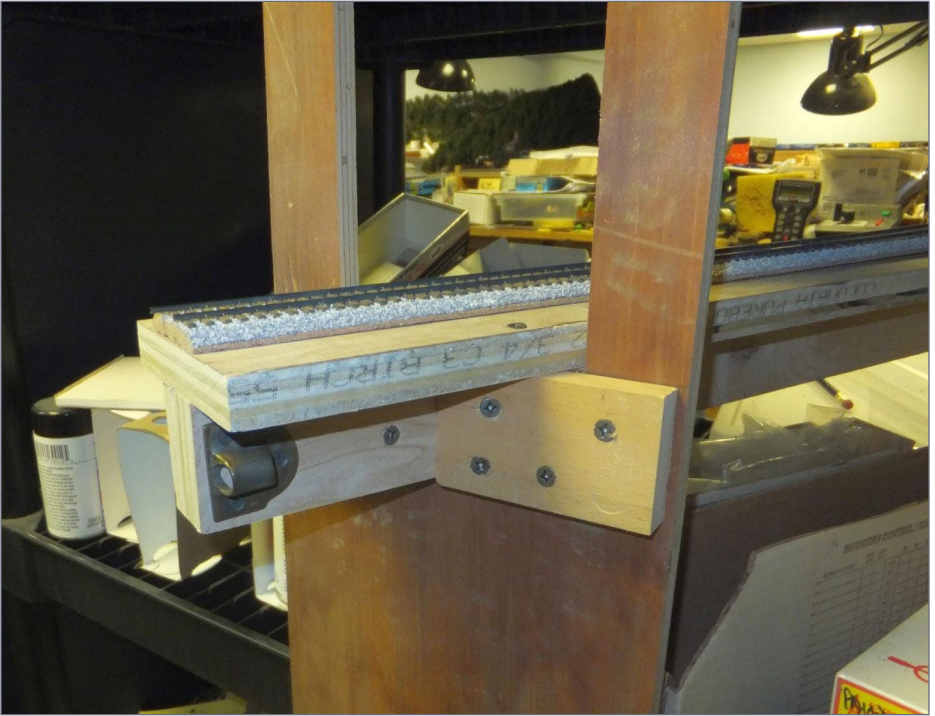

36. The catch is on the land side of the bridge. Supporting pieces are all screwed in place with high quality square-drive screws.



[Click here for reader comments](#)





37. To install the bridge track, I latched the bridge, put down track from staging across the bridge and into Ransom. Then I tested it, and finally cut through the rails and roadbed at the hinge and latch points

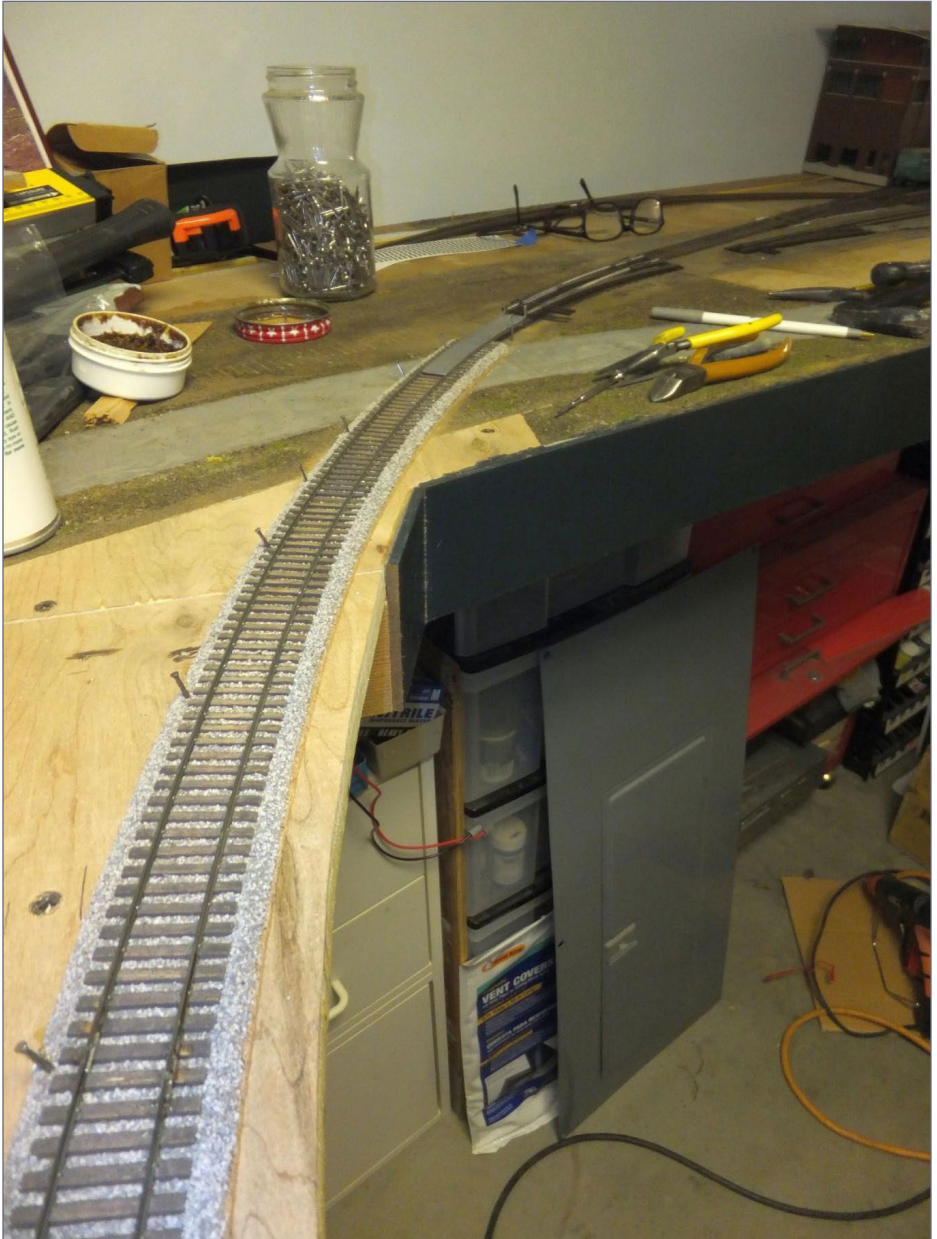

38. The tracks transition from the bridge to the mainland on a slight curve.



39. Test new track as soon as possible with real equipment. The cars in the distance are there to help get a feel for the proportions of the to-be-built plant and for track spacing/length decisions.

## GETTING REAL | 40



40. DAP acrylic adhesive caulk holds the Custom Trax down to the sub-roadbed. Lots of clamps and blocks give a nice smooth result.



DID YOU KNOW MRH  
SUBSCRIBERS GET  
FREE BONUSES?

CLICK TO SUBSCRIBE NOW -  
IT'S FREE!



41. Once I was sure of my track locations I slipped a sheet of 1/4" lauan plywood under the tracks, traced their locations, and cut away the unwanted material to make roadbed.



42. Remember the early view of Ransom? The tracks being placed were lifted from the old sections, hence the feeders all over the place! I'm using the warehouse on the right as a stand-in to plan some of the track spacing. It won't be part of the final scene.

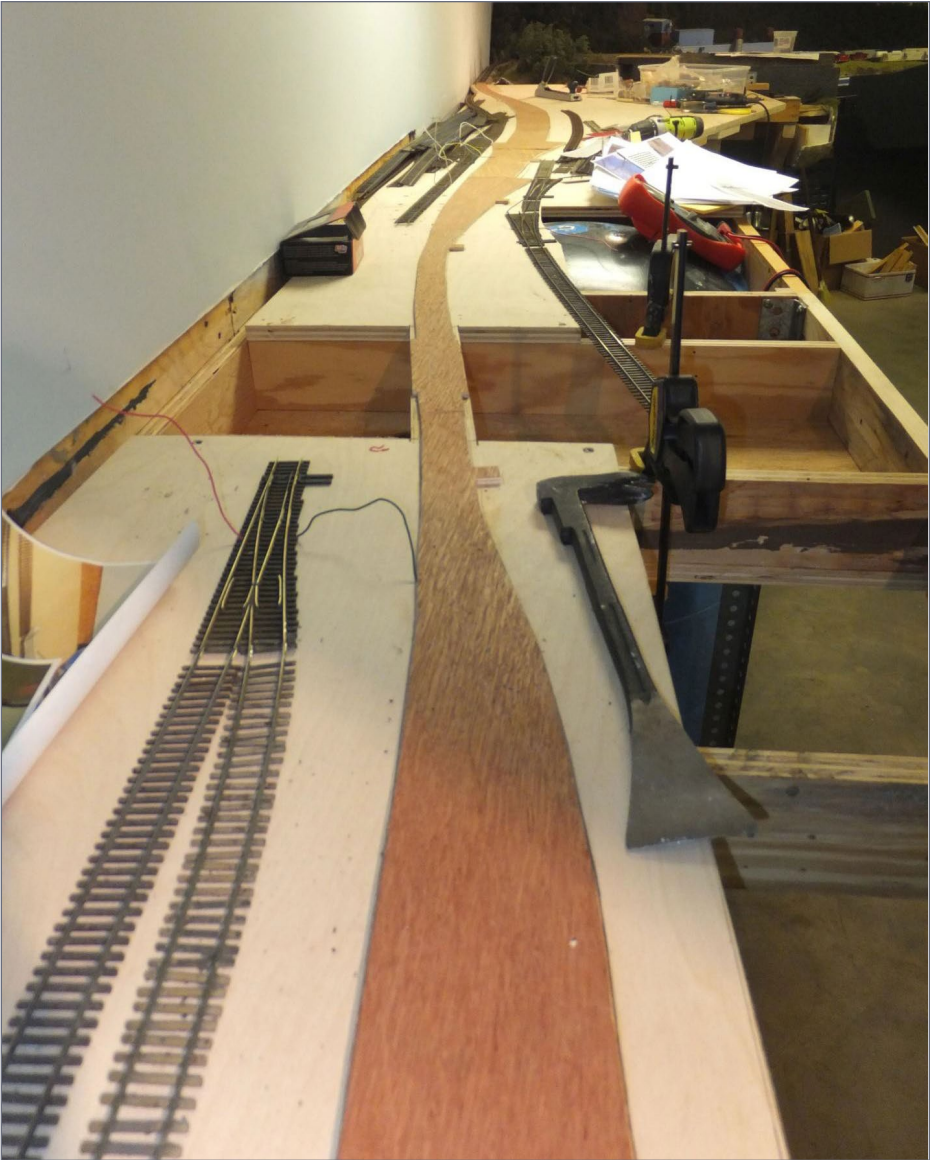

43. The roadbed process with lauan plywood continued all the way through Tunkhannock in the distance. The lowered area between Ransom and Tunkhannock will be Tunkhannock Creek and help to separate the two scenes.



44. The base for Tunkhannock Creek has a plywood floor to support the creek bed and bridge abutments.





45. One of the attractive things about the Ransom plant was that it was on both sides of the main line, with the buildings connected by an overhead pipe bridge. The pulp or stock prep portion of the plant was to be closest to the aisle. I needed a bump out to permit this. Benchwork joists are being extended to the proper length for support.



[Click here for  
reader comments](#)



46. The existing fascia is curved out to accommodate the bump-out, and it defines the areas to be filled.



47. With some plywood in place, I can plan the track locations. The pulp plant has a two-track siding that enters the building and takes four cars.

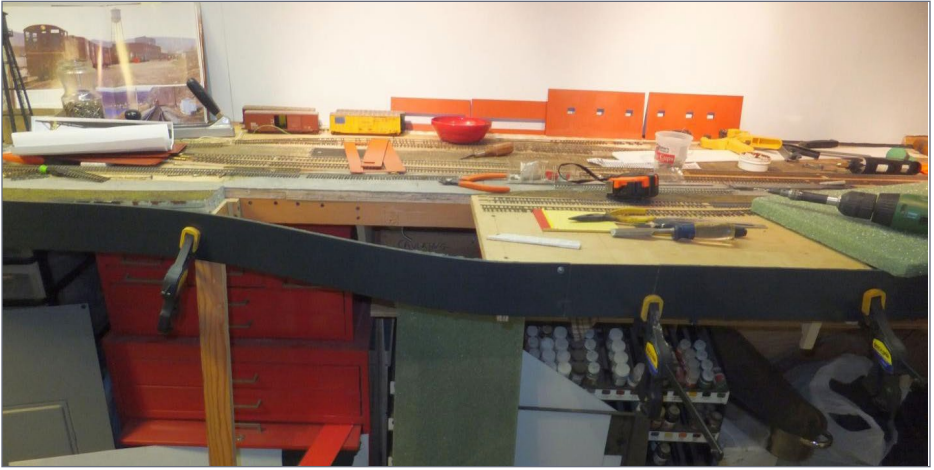

48. With the fascia clamped to the new bump-out, foam can be traced to fill in on either side of the plywood that supports the building and tracks.

## Did you see this MRH video?



**A full-sized F7  
cab in the  
layout room?**

**Watch the video now** 



49. This elevated view shows the process of cutting and fitting florist's foam for the fill-ins.



50. The track alignment in Towanda needs to be changed. The foreground siding to the scrap yard will be unchanged, but part of the track above it will be abandoned in place and severed. This means a turnout needs to be cut in, and I've positioned one in the proper place to determine where to cut the rails.



[Click here for reader comments](#)



51. Before remodeling, I soak the area with a liberal water spray to soften the ballast and ground cover for removal. Once things soften and I can remove the track and rails, I use a putty knife to scrape up ballast and ground cover and get down to bare plywood.



52. The area is now cleaned up and is ready for new track.





53. The “new” used Micro Engineering turnout is in place with the connecting rails. Note the severed track leading off to the rear. This will be heavily rusted and planted with weeds to look abandoned. *Continued next month ...* ✓

# TRAINMASTERS.TV

*Matt Herman of LokSound  
on DCC sound ...*



Brought to  
you by

**MRH**  
MODEL RAILROAD HOBBYIST

## Coming in December!

Non-members can watch for only \$1.49



**Special  
Holiday  
pricing in  
effect!**



**Visit the TrainMasters TV website**





# WHAT'S NEAT WITH KEN PATTERSON

KEN PATTERSON

column



[Click here for  
reader comments](#)

## REMEMBERING 20+ YEARS OF KEN'S WORK, AND LOTS MORE ...

**THIS MONTH I WORK WITH THE NEW 3-D** printer from Dremel. There is also some great drone video in this month's video, and we complete part 2 of my layout construction by wiring blocks, laying track and finishing scenery for the area around the B.T.S. Hyde Pulp mill complex and wharf scene.

But first, let's look back and reminisce about my work in the hobby over the last 20+ years.

### Reminiscing with Ken

Joe Fugate asked me about my modeling from the very beginning, and wondered how my work has evolved over the years. In

▶ [PHOTOS AND VIDEO OF SUPERB MODELS](#)

## WHAT'S NEAT | 2

the video, I look back over the last 20+ years and reminisce with 130 photos over about 10 minutes. That is far too many photos to publish in this online portion of the magazine, so I've shortened the history and show just a few of the photos I've had published in the model press, I also take you behind the scenes to see how I set them up.



1. It all started because I was born in a household with a father who was a model railroader.

## WHAT'S NEAT | 3

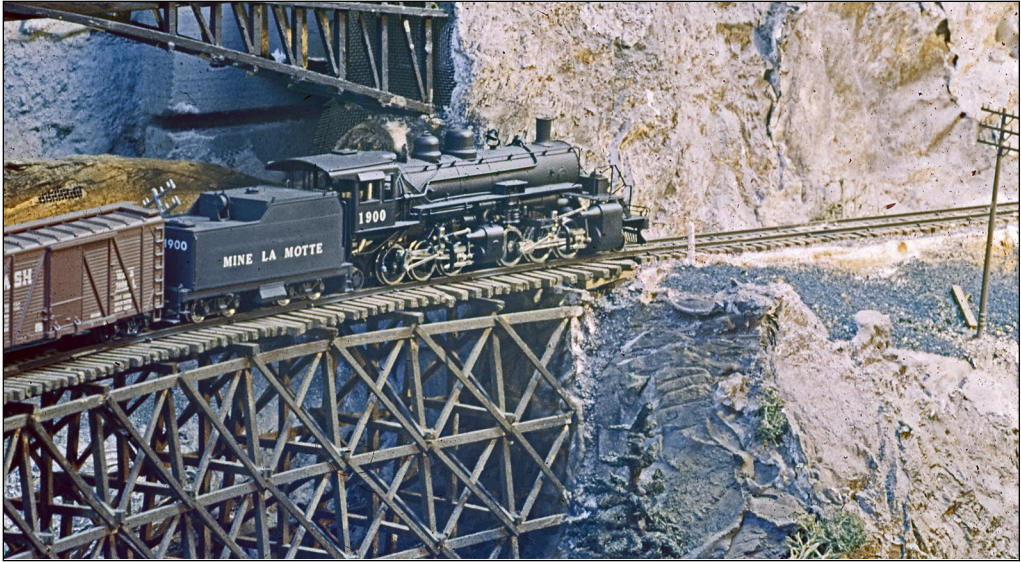

2. In a cigar box, I found a few photos of my dad's layout from the '60s. I watched him build bridges and do hardshell scenery the old school way.



[Click here to play video.](#)

Playback problems? [Click here ...](#)



3. He also took me on railfanning excursions around town and I learned a lot about the prototype at an early age.



[Click here for reader comments](#)



4. When I was adopted by my grandparents in the early '70s, they gave me a Tyco train set as a homecoming gift. I quickly graduated from a 4x8 layout to a plywood central layout wrapping around the room. I used scrap wood from subdivisions being built in the area.



5. About this time I started trying to shoot model photos of my layout – like this shot with cotton clouds on a blue cloth background. Not a great shot, but it was a beginning. In the video we have 10 or so of my very early photos.



[Click here for  
reader comments](#)





6. After I saw the 1979 Walthers O scale catalog cover featuring Vic Roseman's work, shot outdoors with good depth of field, I started building dioramas and shooting my photos outside.

**Want to help keep  
MRH free?**

**Then *click* on ads!**



7. Again, my results were not that great, as you can see in this MoPac shot with the Rico station. The photo was made with my grandpa's Pentax ME around 1981.



[Click here for reader comments](#)

# KEN PATTERSON 2016 Calendars



Wallpaper  
photo downloads  
included!

Made especially for model railroaders by MRH

Best of Ken Patterson

Also available:

Ken Patterson's Colorado Narrow Gauge



A Union Pacific train rumbles across a river crossing on Ken's home jagged lead by GP60 #5835. This is a BLMA bridge and is

2016	MARCH						
Sunday	Monday	Tuesday	Wednesday	Thursday	Friday	Saturday	
1 February	1	2	3	4	5	6	
7	8	9	10	11	12	13	
14	15	16	17	18	19	20	
21	22	23	24	25	26	27	
28	29	30	31				
13	14	15	16	17	18	19	
20	21	22	23	24	25	26	
27	28	29	30	31			

Major model RR event dates included!

Wall calendars:  
Open to 11" x 17"

~~\$18.88~~

\$16.99  
+ S&H



GET YOUR CALENDAR TODAY >>

store.mrhmag.com

MRHMAG.COM

- TABLE OF CONTENTS
- INDEX



8. I did finally shoot a good model photo with this creek scene in HO scale, modeled around 1986. I entered this in my local NMRA photo contest.

111,000 have seen this MRH video - *have you?*

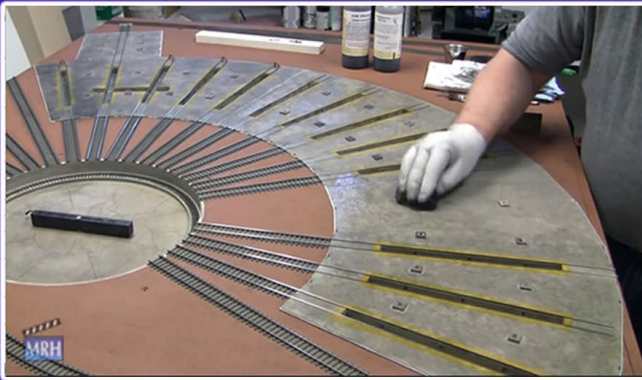

Watch the video now





9. For seven years I shot clean unweathered brass models in my scenes, but when I met Mike Budde everything about my model photos changed. Mike taught me the art of oil paint weathering for railroad models.



[Click here for reader comments](#)

## WHAT'S NEAT | 11



10. Now I was shooting models that were weathered to look realistic in photos. I did contest photos, and started weathering models to appear in the manufacturers' ads that ran in the model press. This added credibility to the models and to my photography.

11. Let's talk about some of my photo designs, starting with this Walther's 2002 cover of the Rivarossi Allegheny project.

# WHAT'S NEAT | 12



*The* ALLEGHENY  
Lima's Finest

By Eugene L. Huddleston  
Thomas W. Dixon Jr.

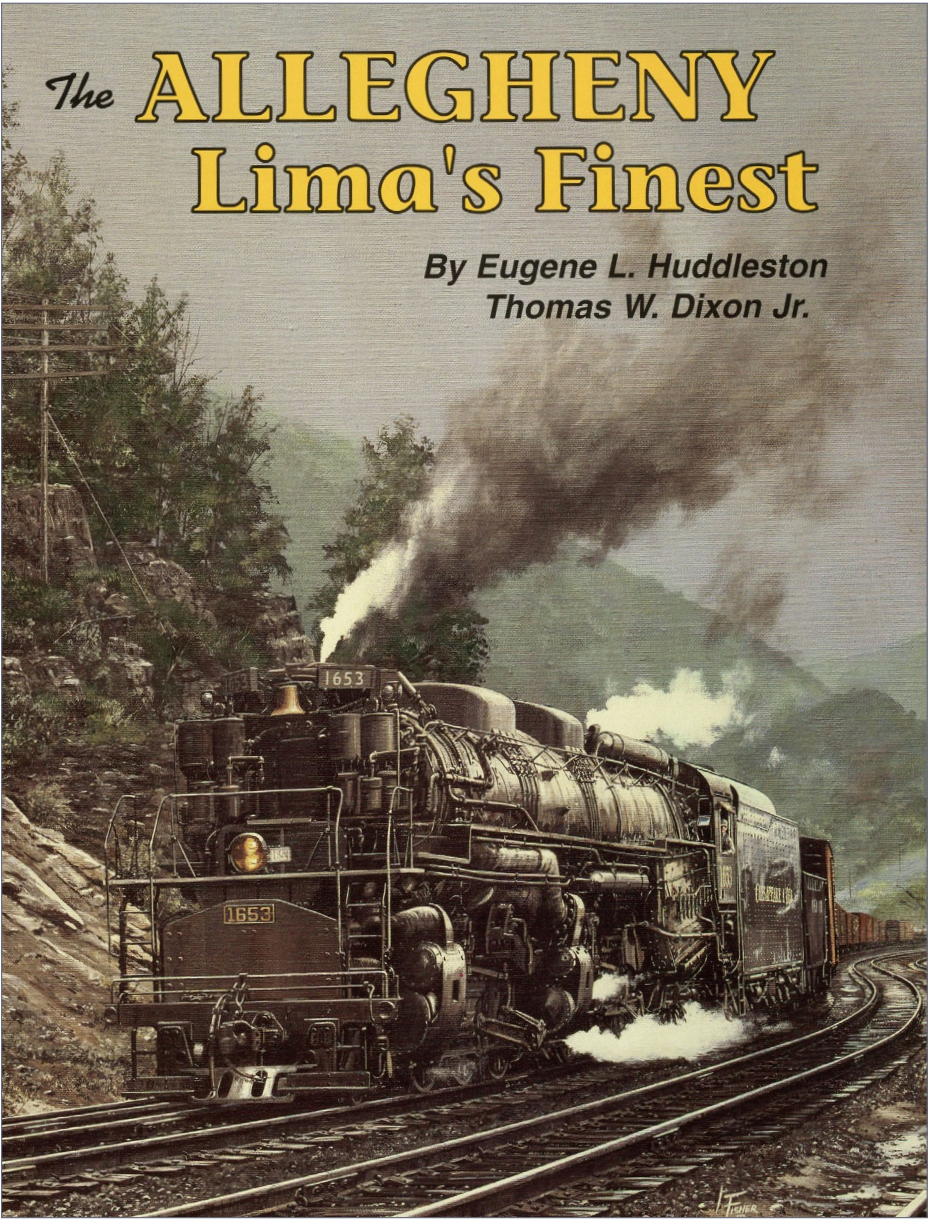

12. My assignment was to copy the cover of the Hundman publication "Allegheny: Lima's Finest," and reverse it so the locomotive was coming towards the opening of the book.





13. Phil Walthers flew his private plane to St. Louis to deliver the pre-production models and give me instructions on the photo. It was a nice break from the normal routine.

***TrainMasters TV is part of  
the MRH product family.***

***TMTV members not only get great network TV level  
videos, they help pay for MRH and keep it free ...***



14. I laid the scene out on nine feet of foam and built scenery to match the scenery to the book's cover.

**Did you know  
there's an  
MRH index  
available?**

**CLICK TO FIND OUT MORE**

## WHAT'S NEAT | 16



15. I made the Allegheny Mountains out of foam covered with processed lichen, and set the whole scene up outside over a period of a month to get the photos.



[Click here for reader comments](#)



16. Here is one of the final photos from that shoot. The weathering on the train was done with oil paints and an airbrush.







17-18. This shot for Atlas is one of my favorites. I used N scale and HO scale models to create this forced perspective shot of the train's tail snaking into the distant curve. I used an electric chainsaw to speed up carving this large two-piece foam scene.

**Use our custom  
Google search on the  
MRH website to find  
topics of interest**

**CLICK TO FIND OUT MORE**

## WHAT'S NEAT | 21



19-20. I have always had good luck painting backgrounds, like this Bachmann N scale ad shot of F units pulling a train through snow-covered hills. And yes, the models are weathered with oil paint.



[Click here for reader comments](#)





Layout tours - Trackwork - Structures - New - Planning - Contrarian Opinions - DCC - Ballast - Multi-deck designs - ering - First looks - Rolling stock - guidelines - Clickable links - Video - Prototype modeling - Lighting - MRH forum - active reader feedback - Questions Answers and - Upcoming events - signs - Scenery - tuning - The Tool Shed - Layout owner interviews

# Model Railroad Hobbyist magazine™

**YES, subscribing MATTERS!**  
(even though it's free)

**It helps MRH get more  
advertisers**

[Click here to subscribe!](#)



21-22. Another interesting photo is this Bachmann shot. The crane was the product to sell so I put one of Bachmann's best K4s models in the dirt just to be rescued by the train crew.



[Click here for reader comments](#)



## Did you see this MRH video?



The ultimate “Yes,  
it’s a model” video  
as James McNab  
switches NW 86th

**Watch the video now**



23-24. Everyone remembers this Bachmann E-Z Track ad. It has been running in the model press for 15 years. I always wanted the caption to read "From the carpet to your imagination, Bachmann E-Z Track will take you there." It is the realistic scenery that captures my imagination in this photo.

Let me end this short overview of my work by asking you to check out my two new calendars, new for 2016, available at the MRH Magazine store. In them, I share inspirational model photography each month, in both narrow gauge and standard gauge HO scale models.

[store.mrhmag.com/store/p110/2016 Ken Patterson Narrow Gauge Calendar.html](http://store.mrhmag.com/store/p110/2016%20Ken%20Patterson%20Narrow%20Gauge%20Calendar.html).

[store.mrhmag.com/store/p107/2016 Best of Ken Patterson Calendar.html](http://store.mrhmag.com/store/p107/2016%20Best%20of%20Ken%20Patterson%20Calendar.html).



56,000 have seen this MRH video - *have you?*



Watch the  
video now



Click here for  
reader comments



25. Because it's December I will end this story of my modeling over the past 42 years with the Christmas shot I did for Mainline Modeler in 2004. It's a gas station on a cold Christmas Eve, with snow, decorations, and lighting to create the mood – along with Santa getting a cold one. All the joy to you and yours this Christmas season.

## The Dremel 3D Printer

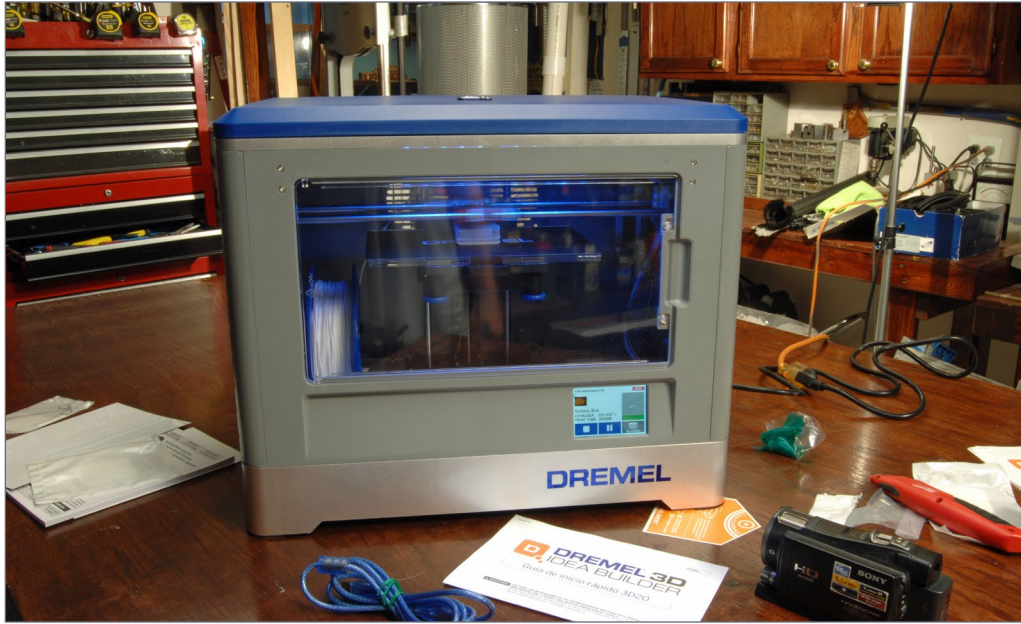

26. In the next video segment, we look at the Dremel 3D Idea Builder printer and take it through its paces.



[Click here for reader comments](#)

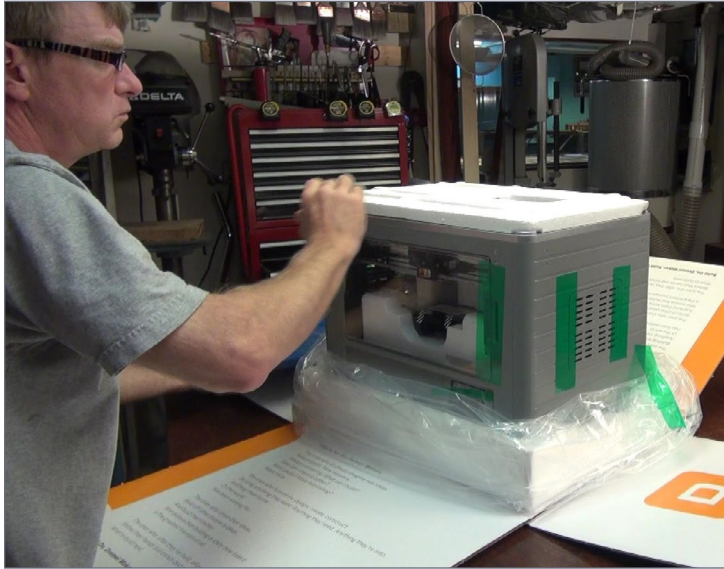

27. The printer came in a well-packed box that is a presentation by itself, adding to the excitement of working with this new tool.

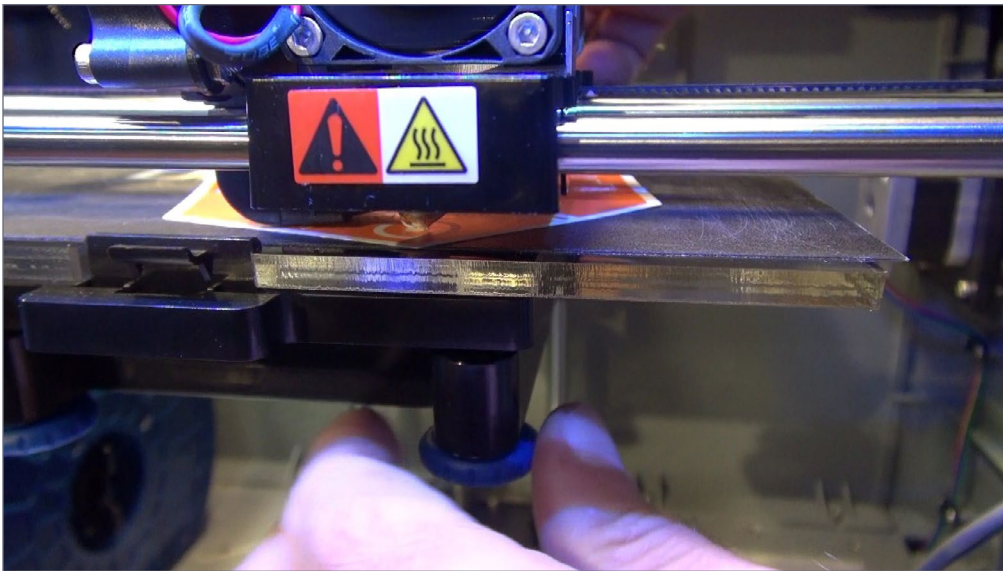

28. One of the first steps in setting up is to level the printer table to the head position in three locations, using a gap tool supplied in the package.



## WHAT'S NEAT | 30

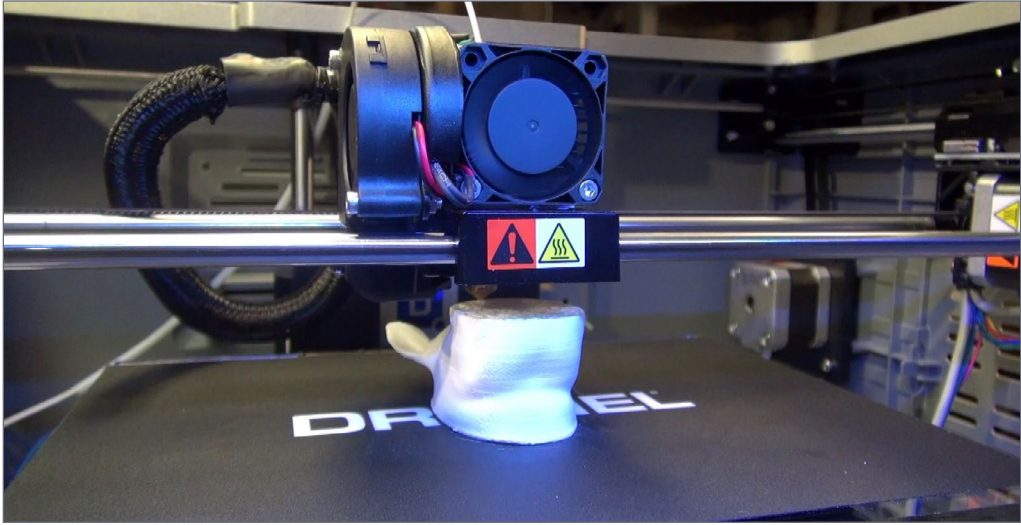

29. It only took 20 minutes to set up and print my first model from the internal memory. Here is a rhino head being made layer by layer over a period of one hour.



30. I also made a toy school bus that took two hours to print. The models were printed cleanly with smooth lines and an internal webbing that added strength to the semi-hollow toys.

# WHAT'S NEAT | 31

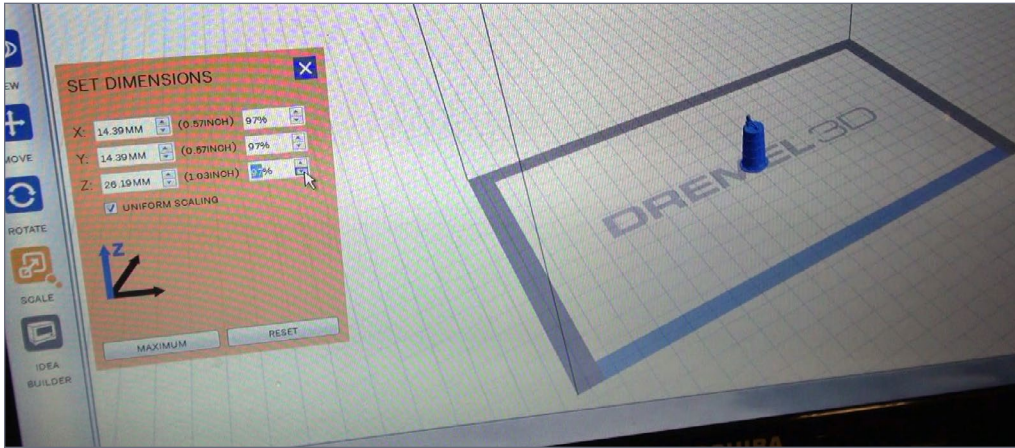

31. I downloaded Dremel 3D software from Dremel 3D.com. We will use this software to scale a model downloaded from the Internet to any size we want. Here I am scaling a highway department barrel to HO scale to be printed.



32. The HO scale figure, standing next to two barrels I printed, took only two minutes to print. In the video you can watch and hear the entire process in real time as we print these items, and use in SketchUp software to design a house to be printed in HO scale.

*Learn to solder track, wiring and brass models in this video!*

**CHECK IT OUT!**



**kenpatterson.com**

*click here to ...*

**Visit Ken's website**

**Ken Patterson shows you how to solder like an expert!**

## WHAT'S NEAT | 32

### Layout construction continued

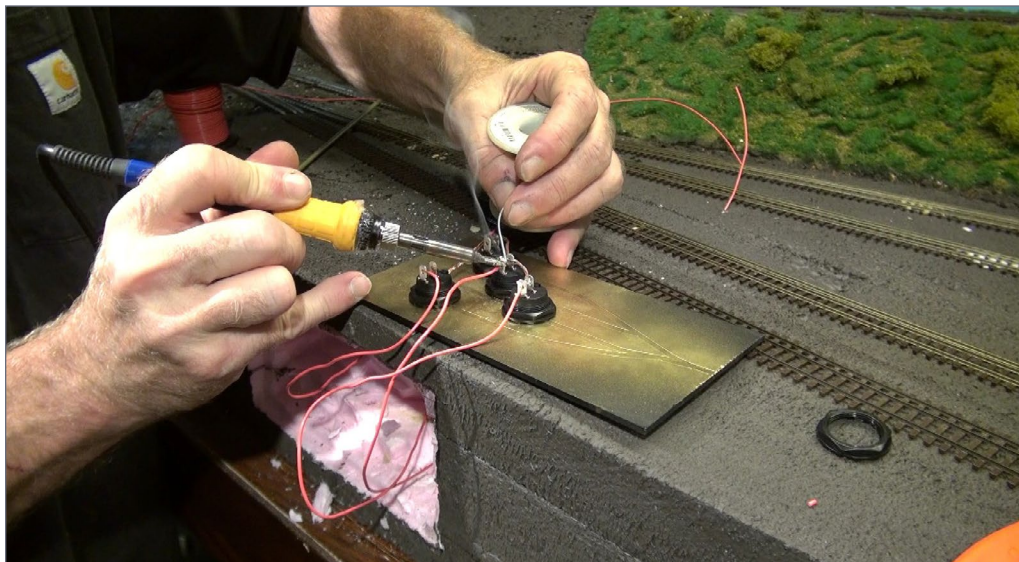

33. In this month's layout construction segment, we pick up where we left off last month with the wiring of track power blocks to my new wharf scene.

I make Plexiglas panels and add rocker switches to control the blocks' power. I run a power wire from the rocker switches to the inside rail of each of the four tracks before gapping them.



[Click here for  
reader comments](#)



34. I fasten the panel to the foam with Gorilla Glue. Push pins keep everything in place as the glue cures over a period of 25 minutes.

*Want to keep MRH free?*  
**CLICK on ads.**

*If ads in MRH don't get clicks, then advertisers won't advertise with us, it's that simple ...*



35. Quarter-inch oak plywood cut to shape and stained with red oak stain covers the sides. It is finished with three coats of polyurethane varnish, sanded between coats with 1500 grit wet sandpaper.



36. I glue fake fur to the foam with Great Stuff Pro Foam and press it into the areas where wild grass would grow.

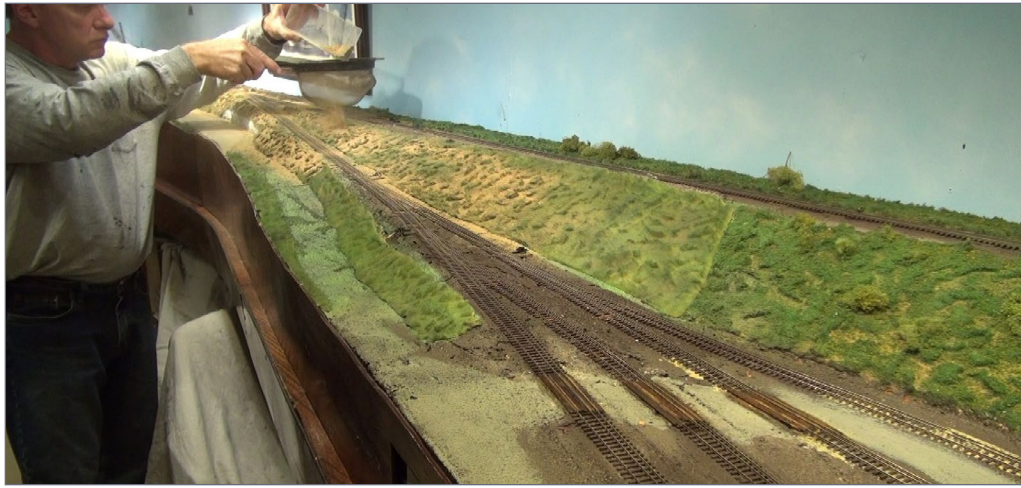

37. After painting and trimming the fur, I cover the entire scene with back yard dirt sifted through a fine screen, then teased the fake fur so the dirt would settle down and the grass tufts would stand up.



38. Using a fan brush and a straight one-inch artists brush I groom the ballast, dirt and rip-rap stones over the scene before gluing everything solid with Woodland Senics Scenic Cement.



39. I further enhance the scene with grass tufts from Silflor along with static grass to blend the yard trackage with the fake fur. I also use ground foam in light green and medium green to blend the lines between the dirt and fake fur edges.



[Click here for reader comments](#)





40. With all the scenery in place and The B.T.S. Hyde Pulp Mill kit and dock scene 95% finished I only need to add bushes and trees as time permits. It took 22 days to build the kit and finish the scenery. I am very happy with this new signature scene on the layout. The benchwork curves make the isle space bigger and shorten the reach across the tracks. It is an interesting operating portion on the layout with both narrow gauge and standard gauge and a water tie-in.

This month's video covers the layout construction in about 18 minutes. Add lots of snowplow action in G scale, various Christmas-themed scenes, the Dremel 3D segment, my modeling story and the drone footage, and we are up to 45 minutes of video this month. 2016 will start our 4th year of making the "What's Neat with Ken Patterson Video Show" for Model Railroad Hobbyist magazine every month. Happy New Year!

# 2016 CALENDARS!

Wall calendars: Open to 11" x 17"



Gary Christensen

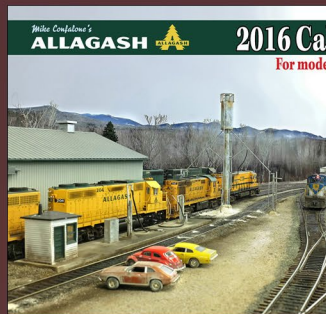

Mike Confalone's Allagash

2016

JUNE

Morning silence is broken at Southern California's Caldwell Boulevard as point locomotive BNSF C44-9 669 crosses with it's intermodal train in town.

Sunday	Monday	Tuesday	Wednesday	Thursday	Friday	Saturday
	1 2 3 4 5 6 7		1	2	3 Memphis, TN MLB Inaugural Jun 5-5	4
5	6	7	8	9	10	11
12 Shawnee	13	14 Flag Day			17	18 Richmond, CA Bay Area RPM Jun 18
19 Father's Day	20 First day of summer	21	22	23	24	25



2016 Calendar

For model railroaders

THE WEATHERING SHOP

ART ON WHEELS



Best of the Weathering Shop



Best of Ken Patterson

Made especially for you

~~\$18.88~~

\$16.99

+ S&H

Major model RR event dates included!

Wallpaper  
photo downloads  
included!



Railway



Rob Spangler's WP 8th Subdivision



Victor Roseman's Vintage SP Trains



n



Ken Patterson's Colorado Narrow Gauge



The Best of Jürg Rüedi

ially for model railroaders by MRH



GET YOUR CALENDAR TODAY >>

store.mrhmag.com

MRHMAG.COM

- TABLE OF CONTENTS
- INDEX



# MRH MARKETPLACE

# Trees!



# coastmans

## STREAMLINED BACKSHOP

Sales  
... Services  
..... Solutions

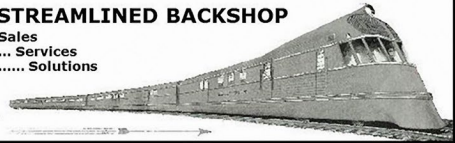

## "SUGAR CUBE" SPEAKERS...

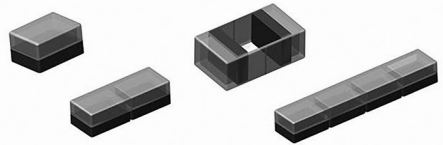

4 Sizes \* 4 Baffles

...*"Sweet"* Speaker Options!



[www.SBS4DCC.com](http://www.SBS4DCC.com)

PRECISION DESIGN CO

Chains  
Flat Car loads  
Joint Bars  
Signs & Posts

FREE SHIPPING

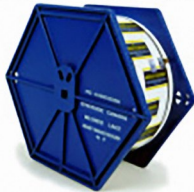

# Reflectors that Actually REFLECT

[smokeboxgraphics.com](http://smokeboxgraphics.com)



# HOBBY MARKETPLACE ads are economical and effective.

Click HERE to learn more.



P.O. Box 6 Paonia, CO 81428

Ph. 970 527 4586

Made in The USA

Cast resin items for All Scales.  
Tunnel portals, bridge piers, abutments,  
culverts, and retaining walls.  
Trackside details and sage brush tree  
armatures.

"FREE SHIPPING see website for details"



ATSF Dv-4B

## True Scene™ Modeling



**FusionFiber™**

Scenery Base Material for the 21st Century!

**SATISFACTION GUARANTEED!**

[www.truescene.com](http://www.truescene.com) or 716-523-7305

## Yarmouth Model Works

HO scale resin kits and detail parts



..... U.S.A. MAILING ADDRESS

3560 Pine Grove Ave. Unit 617  
Port Huron, MI 48060

Tel. 519-633-7574

[pierre.oliver@start.ca](mailto:pierre.oliver@start.ca)

[www.yarmouthmodelworks.com](http://www.yarmouthmodelworks.com)

..... CANADIAN MAILING ADDRESS

85 Hiawatha St.

St. Thomas, ON N5P 2T5



## Mr. Detail Parts

Bulk Packs Now Available



**EXPLORE HERE**

Available Scales: HO - N - S - O - G - TT - 1:72

[www.mrdetailparts.com](http://www.mrdetailparts.com)

## FREE SHIPPING!

... on all USA orders over \$29

**CLICK HERE**

Mountain Subdivision Hobbies



Railroad Art-Prints,  
Caps, Jackets,  
Shirts and More ...  
Jackets starting  
at \$79.95

[www.jelsma.com](http://www.jelsma.com)

1-904-221-3513 • Jacksonville, FL.

**Vector Cut**  
.com

PRECISION  
Laser Cut Details & Kits



Affordable built to order Benchwork  
starting at only \$20 a Sq Ft.

**MODEL RAILROAD**  
**BenchWork**.com  
Affordable track planning  
starting at \$250



**FREE SHIPPING** 

GET FREE SHIPPING ON ORDERS OF \$10 OR MORE

**LIGHTS**   
**MODELS**  

AVAILABLE IN  
NOVEMBER  
&  
DECEMBER

[Click Here](#)

UNIQUE PRODUCTS FOR UNIQUE LAYOUTS

**HAPPY HOLIDAYS FROM**  
**KC'S WORKSHOP**  
CRAFTSMAN MODEL KITS



Use Code MRHMAG  
At Checkout For 10 %  
Off Your Total Purchase  
of \$50 or More

[www.kcworkshop.com](http://www.kcworkshop.com)

**CLICK HERE**



**CANYON CREEK**  
**SCENICS**

**Don't settle for lifeless signals!**  
**We've got signaling circuits!**



**LOGIC RAIL**™ "Sophisticated  
**TECHNOLOGIES** Model Railroad  
Electronics"

Please visit our website and online store!

21175 Tomball Pkwy Phone: (281)251-5813  
Suite 287 <http://www.logicrailtech.com>  
Houston, TX 77070 [info@logicrailtech.com](mailto:info@logicrailtech.com)



**TrainShow.com**

**Find the Train Show Nearest You**

**CLEVER**  
models LLC

The hottest trend in  
modeling... Is also the  
least expensive.



Try one today!

[www.clevermodels.net](http://www.clevermodels.net)

**LOOK**  
at what's new at  
Black Cat this month

[Click here for  
our website](#)

**Quebec Central stock cars  
&  
Quebec Central Cabooses**



**Black Cat Publishing**  
(204)489-5005  
[ajfergus@mymts.net](mailto:ajfergus@mymts.net)  
[blackcatdecals.com](http://blackcatdecals.com)



## 2016 Trolley Calendar

Color cover, 13 B&W photos with descriptive captions from mid-Atlantic area:  
PTC, PST, SEPTA, LVT,  
H&F,Scranton, D.C. Transit,  
and others.

\$10 +\$2 S&H

To order the calendar by check or money order (payable to East Penn Traction Club), please send it to:

East Penn Traction Club  
c/o Charles Long  
227 Locust Road

Fort Washington, PA 19034-1425

[click HERE to learn more](#)

## MOUNTAIN SUBDIVISION HOBBIES

[www.modelrrsupply.com](http://www.modelrrsupply.com)

FREE USA SHIPPING OVER \$29.00

NCE - SOUNDTRAXX - DIGITRAX - PECO - CIRCUITRON  
DCC SPECIALTIES - INTERMOUNTAIN - CMX - ATLAS  
BAR MILLS - BOWSER - KATO - MRC - TOMAR - RIX -  
PIKESTUFF - LOGICRAIL - CENTRAL VALLEY AND MORE!

Your ad could  
be in this space  
for just \$84 a  
month.

[Click to learn more ...](#)

## Great Decals!™

FEC, Interstate, Virginian  
Railway, & L&N Titles  
After Hours Graphics Line  
Coupler Gages and More  
In O, S, HO, and N Scales



## HO DIESEL SUPPLY

Are you serious about your HO Diesel fleet or just tinkering? Either way  
You probably bought just the right parts you needed from us already

BACKSHOP HARD PARTS DIVISION

Now Direct Personal Service

[www.hodiesupply.com](http://www.hodiesupply.com)

email: TheBoss@hodiesupply.com

## RULERS-of-the-WORLD

Scale Rulers \$4 each

Over 200+ scales!

Metric or Imperial

[www.rulers-of-the-world.com](http://www.rulers-of-the-world.com)

GOLDEN AGE LINE  
**WESTERFIELD**  
MODELS, LLC

NEW N.A.R. STK CAR KIT!



RESIN KITS, DECALS,  
DATA DISKS & DETAIL  
PARTS AVAILABLE.

[westerfieldmodels.com](http://westerfieldmodels.com)

# *Building a turnout with Proto:87 Stores parts ...*

BY ANDREW HALL  
.....



# THE SWITCH AT

[MRHMAG.COM](http://MRHMAG.COM)

- [TABLE OF CONTENTS](#)  
.....
- [INDEX](#)





# BEAVER CREEK

[MRHMAG.COM](http://MRHMAG.COM)

- [TABLE OF CONTENTS](#)
- [INDEX](#)



**Click here for  
reader comments**

**AN AREA I CALL BEAVER CREEK CORNER IS MY** latest next on the construction schedule for my Nelson and Fort Sheppard Railway. The spot is just outside of the upper yard and will include a turnout from the main line to the arrival-departure tracks. In addition to the switch, I will need to install signals, and a bridge over Beaver Creek.

Now I have a turnout to build!

I am using a Proto:87 Stores Ultimate Turnout kit from Proto 87 ([proto87.com/accurate-track.html](http://proto87.com/accurate-track.html)). The turnout is a No. 10 left-hand turnout using the “manganese frog” option. I began by laying out all the parts to be sure I had everything needed. Then



1. This is the inspiration for the Beaver Creek turnout and bridge on my Nelson and Fort Sheppard Railway.

# THE SWITCH AT BEAVER CREEK | 4

I test-fitted the ties in the jig over the template to familiarize myself with the beastie.

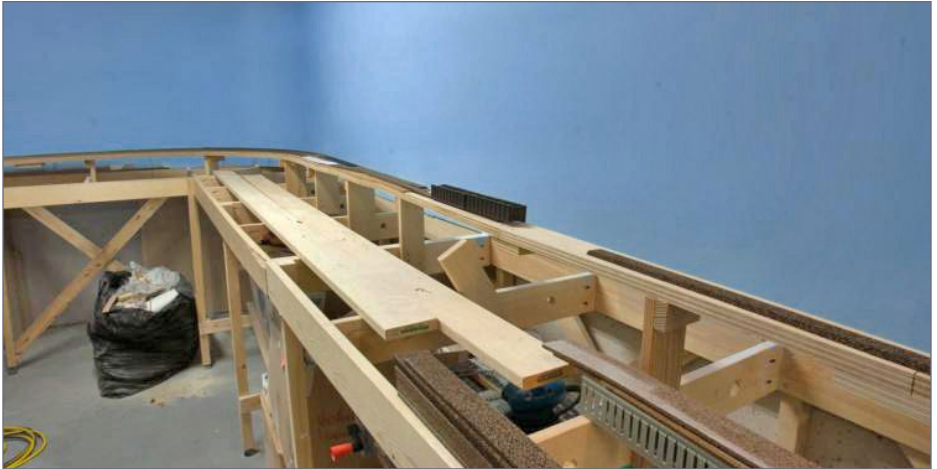

2. The area as it stands.

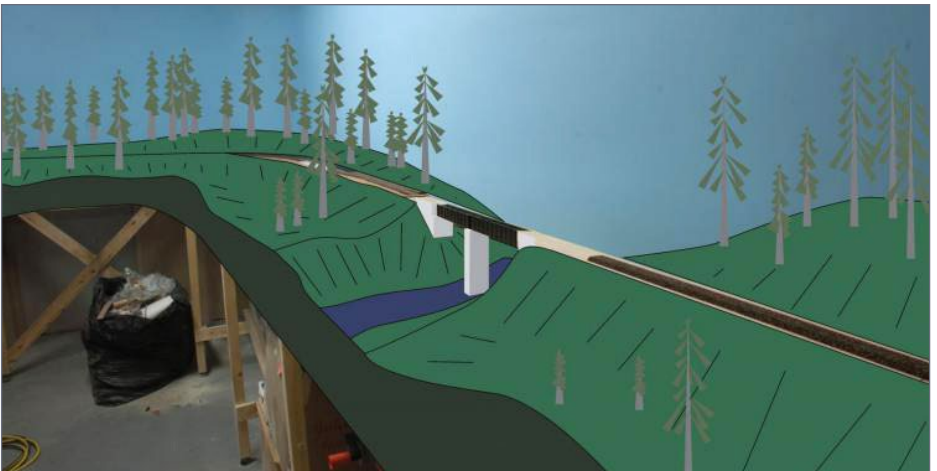

3. I have created this masterpiece to guide my thinking/planning process.

## Time to get started

Before going ahead, I made up two mixes of India ink and 70% isopropyl alcohol, one using the Higgins black ink and the other mix with the Higgins sepia ink. The ties went into the mix in random batches and times. Some went in twice! I was going for a fairly new look so most of the ties are in the black to black brown color range.

When the ties were dry, I taped the provided plastic sheet to the template and then fixed the tie alignment templates to the plastic sheet. Using a medium viscosity CA, I glued the ties to the plastic sheet.

The head block ties are not in place [4]. For a better appearance, I chose to use full-length ties instead of using two shorter add-on tie bits. I will install them after the tie plates are installed. After the CA set up, I checked and re-glued any that were loose. There is always one.

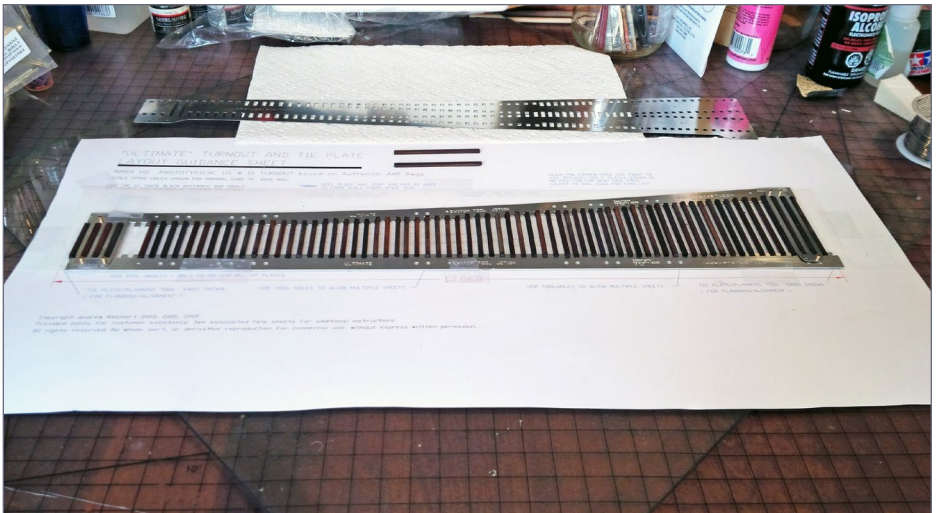

4. Ta-da! Here they are – all the ties glued down!

## THE SWITCH AT BEAVER CREEK | 6

The tie plate guide is placed on the template using the guide pins. That was easy! The tools needed to install the tie plates are:

- A toothpick with a pointy end and a blunt end
  - Small scissors\*
  - Tweezers
  - Medium viscosity CA
  - Some Green Masking Tape. It has a higher adhesion than the normal blue tape.
- \*A note on scissors:** Use your own. Do not use your wife's or mother's fabric scissors lest you need your SHED (Scared Husband Emergency Domicile).

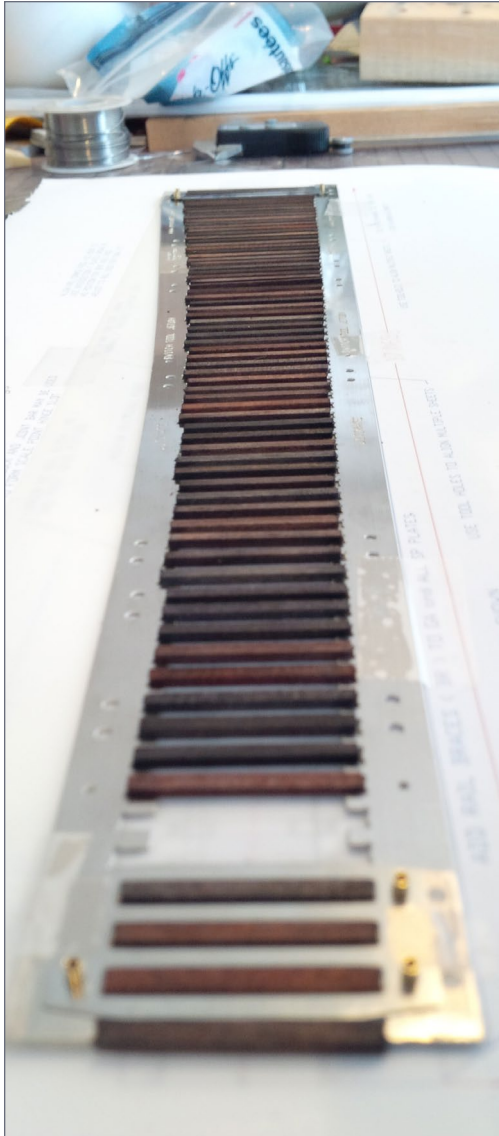

Using scissors, cut the tie plates from the etchings one strip at a time. That way, the remaining tie plates are in one big piece rather than a pile of millions.

With a spare copy of the turnout template for reference, place the cut-out tie

5. Here's the turnout viewed from the end that shows the tie color.



## 6. The tools used for installing the tie plates.

plates in their correct orientation. There is a tiny D shaped hole in the tie plate. The curved part of the D points out and the flat part of the D faces to the inside.

Place a bubble of medium viscosity CA on the tape. This is safer and more economical than trying to get the correct amount out of the bottle. With a toothpick point, place a small drop of CA into the hole of the template on the tie where the tie plate will go. Using tweezers, pick up the tie plate and place it into the hole, pressing it down with the blunt end of the toothpick. Then lift the tie plate template to ensure two things – that the template will come off without ripping the tie plate off, and to be sure the template is not glued to the turnout.

Install the rest of the tie plates, working from one end of the turnout. I just do a few ties at a time, as my mood suits me.

You may notice that the tie plates and frog strips aren't installed yet. I am using the magnesium insert type frog and the instructions say to leave them for later.



7. I was also careful to note where the cosmetic pieces on the sides of the etching were when welding the scissors about.

At this point, I experienced momentarily palpitations about the guardrail plates. The instructions say to cut the guardrail tie plates in half. I worried for no reason – my template is for HO, and I'm building the turnout for an HO layout, not for fine scale P:87. The tie plates I had worked perfectly without cutting.

Some CA leaked onto the ties and I used a chisel blade to scrape it off. A dab of the India ink wash used to stain the ties completed the repair.

To install the longer head block ties, remove the curvy tie template by cutting the tape holding it down and remove the spacers that hold it to the other side of the template. This gives room for the longer ties while leaving the guide pins in place for the tie plate template. Glue the longer ties down as before using the paper template as a guide. Trim them to length and apply the India ink wash to cover the cut ends.

## THE SWITCH AT BEAVER CREEK | 9

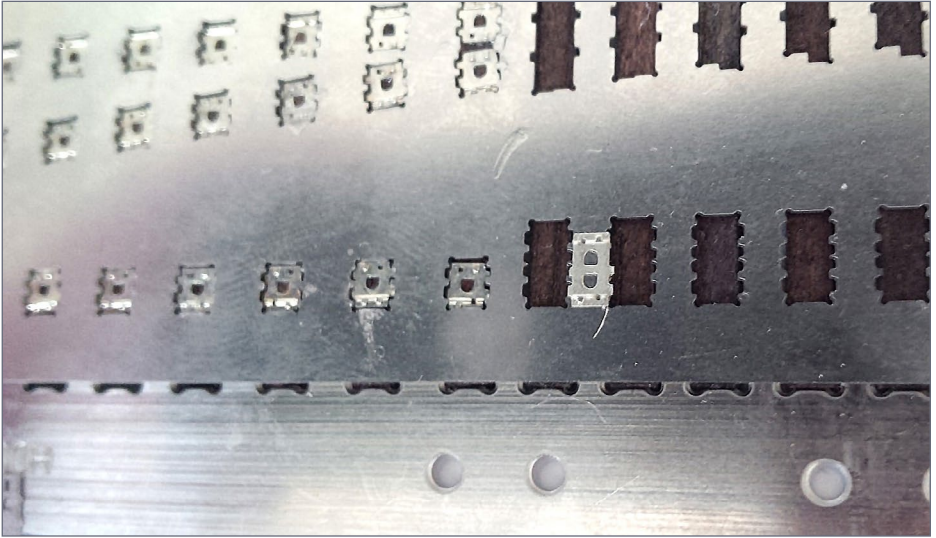

8. Here's a guard rail tie plate as it comes in the kit. Note the hole is bigger for the wider flange ways that HO requires instead of the Proto:87.

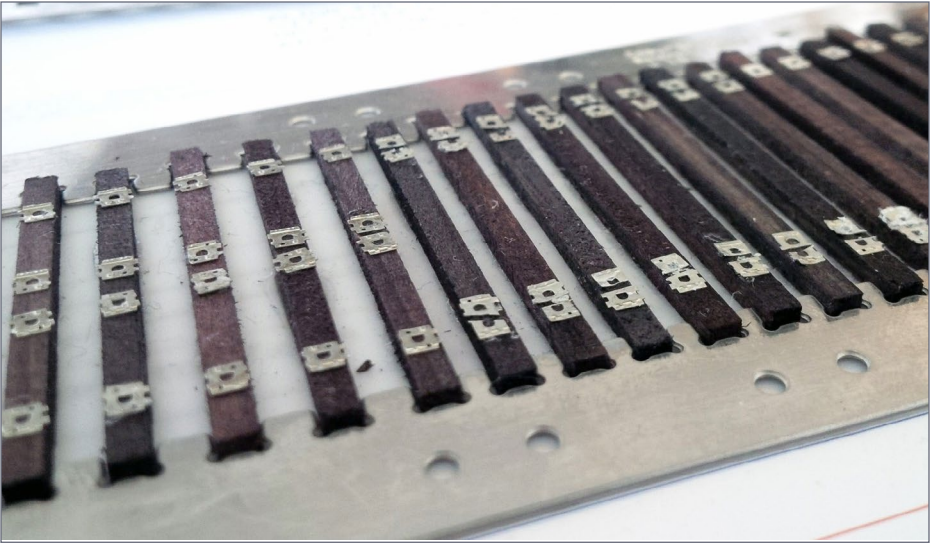

9. The installed guard rail tie plates on the ties.



## THE SWITCH AT BEAVER CREEK | 10

I took time to test the moving throw bar piece to be sure it would fit and slide between the head block ties. This is when I realized that I had glued the gauge plates to the wrong tie. Oops.

The misplaced plates were popped off with a chisel blade and the tie scraped clean. It also took the CA off the back of the

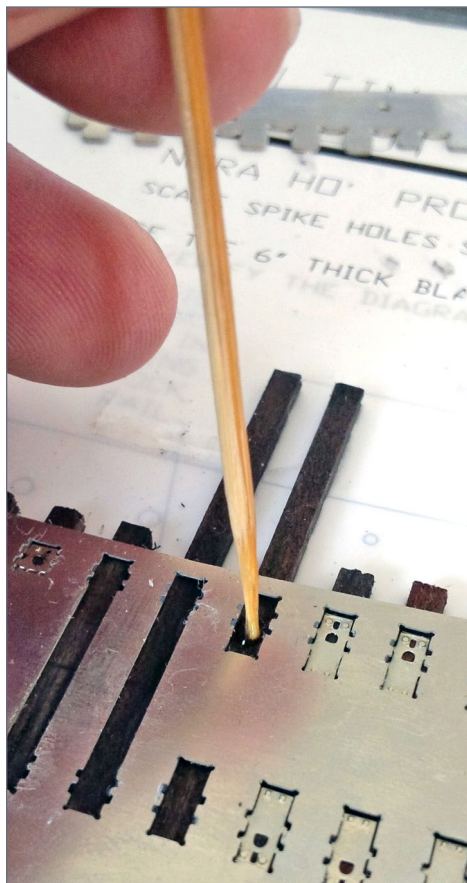

10. The progress after a few days.

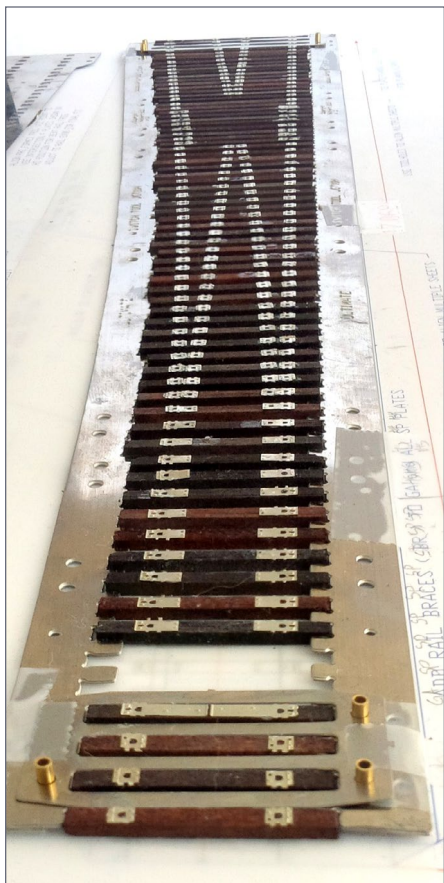

11. And here it is! All the tie plates in the correct locations and ready for some rail.

## THE SWITCH AT BEAVER CREEK | 11

plates – that will be our little secret. I let the ink wash dry for a few hours before adding the final tie plates.

After installing 250-ish tie plates, here is the method I developed:

**Step 1:** Apply little drop of medium viscosity CA with the pointy end of a toothpick.

**Step 2:** Use tweezers to drop in the tie plate.

Alternatively, moisten the blunt end of the toothpick and pick up the tie plate.

**Step 3:** Press the tie plate down and hold it using the blunt end of the toothpick.

**Step 4:** Carefully lift the template up over the tie plate to ensure that the template is not glued down. Then put the tie plate template back down. Survey your tie plates and re-glue any that get knocked off. They tend to fall in between the ties so that's a good place to start to looking for them.

## Ribbit! Ribbit! Time to build the frog

To build the frog use some 1/8" copper tubing, the bolt detail bars and the frog itself. Cut the frog into its parts using a Dremel tool. There are three parts to the frog. Test fit the copper pins in each hole, and then test the three pieces. When everything fits properly, clean the parts of the frog using 99% isopropyl alcohol and a paper towel and set them aside.

Then it's time to prep the frog wire. Use a piece of 12 gauge stranded wire. Is 12 GA wire too big for HO? Of course it is! I strip it and use only a strand.

## THE SWITCH AT BEAVER CREEK | 12

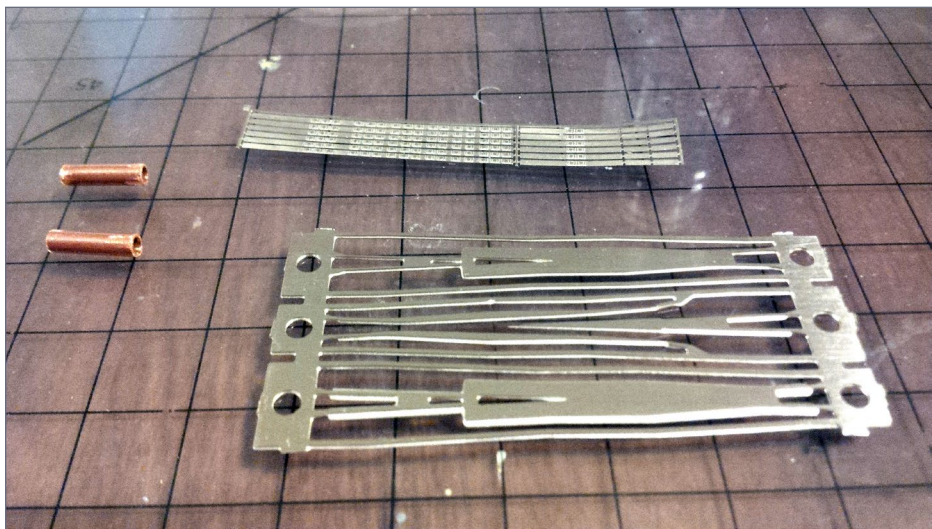

12. Here are the parts needed to build the frog: 1/8" copper tubing, the bolt detail bars, and the frog itself.



13. Here are the three parts of the frog, separated and ready to be stacked.

## THE SWITCH AT BEAVER CREEK | 13

Clean the wire and with a small set of pliers bend a 90 degree angle into the end of the wire. To locate the frog wire on the frog, place the bottom frog part on the ties upside down. With an X-Acto knife, scribe a mark on the frog to indicate where the frog wire will clear the ties.

To assemble the frog, place an alignment pins in the hole. Mine were too loose so I soldered them in place. A thin layer of flux is applied as well to the surface of the frog. To hold the pieces in place, I glued some scrap strip wood onto the end of my clamps' plastic jaws to protect the frog surfaces and prevent the plastic clamp from melting.

Test fit the frog wire, trimming it to fit. Tin the frog wire and apply flux to the frog. Some solder will get into the flange ways. Clean it up with a needle file. Once I was satisfied with the



14. Test fit the copper alignment pin in each hole.



15. Clean the parts of the frog using 99% isopropyl alcohol and a paper towel and set them aside.

results, I cut the frog from the support framework using a Dremel tool.

Because the turnout is directly under a heating register, I chose to use solder instead of CA to attach the detail strips. Add flux and tin the sides of the frog to receive the bolt details. After cutting out the bolt detail strips, clean, flux and tin the back of the bolt detail strips. Using a clean dry tip, solder the detail strips to the frog.

I was not completely happy with this detail. I built another one and used the better of the two. Good thing I ordered a spare! The second time I used less solder. Ahhh ... the “more care and patience” approach works every time.

### Holes made, turnout freed, a rail is bent

To install the parts on the layout, I gathered a fine felt pen and a fresh set of X-Acto blades [20]. Reinstall the curved tie spacing jig, trace a line, and mark where to trim the excess base plastic away from the turnout. Place one of the throw bars and move it back and forth to determine the access area for the Tortoise throw wire and mark out the material to remove.

## THE SWITCH AT BEAVER CREEK | 15

Place the frog onto the turnout and mark where the frog wire will go. Mark the area for the frog wire, and mark the area where the jumper wires between the stock and closure rails will go.

Remove the turnout from the paper template. Reinstall the tie spacing template and use it as a guide to trim the excess plastic [21]. Cut or drill holes for the frog wire, jumper wires that go between the stock and closure rails, and the Tortoise switch motor lever.

With all the holes cut, set the turnout aside and go back to the paper template. Using the template and felt pen, mark where to bend the curved stock rail [22]. After double checking, score the base of the rail with a needle file and bend the rail with your fingers. Repeat the process to put the bend in the curved closure rail.

Test fit the stock rail on the turnout. When the fit is good, its time to glue the rail down. Clean the rail with acetone and a



16. Frog parts assembled and ready to be soldered.

## THE SWITCH | 16

paper towel. Then mix a bit of Pliobond with acetone – two parts of acetone to three parts glue. The ratios don't have to be exact, but it should be thinned so it's workable. Be careful with the acetone and take precautions when using it or any chemical. Be sure your work area is well-ventilated.

Using a scrap piece of stripwood, apply Pliobond to the bottom of the rail. Put the rail aside to get tacky. Use a bamboo skewer to drip drops of the thinned glue on the tie plates where the rail will. Be careful of any "strings" created by the Pliobond.

Put the rail in place and use a dry soldering iron to heat the rail to set the Pliobond. I use just enough heat to cause the solvent to evaporate, for only a second or two at most. I have used the technique on my CVT plastic ties as well with no ill effects.

### Combo Right Clamp™

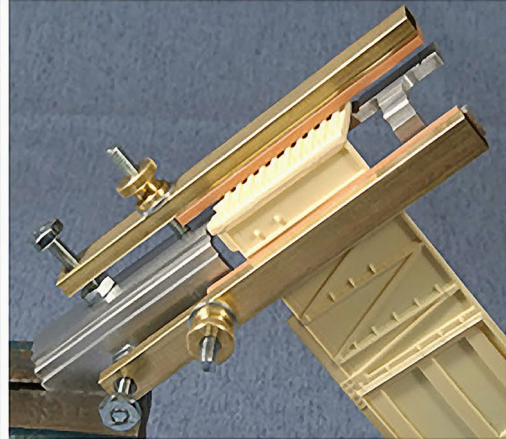

**Combo Right Clamp™**  
with cast resin boxcar

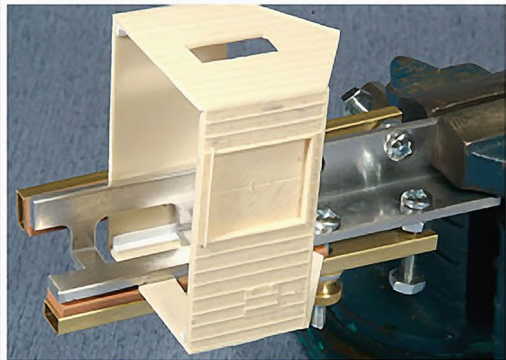

**Combo Right Clamp™**  
with Wolf Design Pump House

**Click here for  
all our products ...**

### Tools for Modelers

Coffman Graphic Solutions Co.  
1500 River Circle, Richmond,  
KY 40475-7907

## THE SWITCH AT BEAVER CREEK | 17

As a final step, I will install the second rail on the ties and then cover them with a piece of paper to protect them from scratches. Place weights on the switch to hold the rails down for at least 24 hours to let the Pliobond cure.

### More rails are added

Time to install the frog. Place the frog on the switch to ensure that the frog wire is in the correct place and no ties must be cut to make room for the wire. Success!

Next, place the tie plate template on the turnout using the existing tie plates as a guide and use the fine-tip pen to mark out where the frog tie plates should end. I should have thought of this before installing the curved stock rail.



17. Frog clamped and ready to go.

Locate the frog tie plates and cut them out using scissors. They are the three rows in the middle of the fret. Note that some of the tie plates have holes for spikes and some have none. Use the paper template to find out how many are needed and cut them off the fret. This is the fiddly bit. De-nub the frog tie plates by trimming away the two little bumps on the sides.

Using an NMRA standards gauge, place the frog on the



## THE SWITCH AT BEAVER CREEK | 18

turnout and check the pen marks. Glue the plates at the end of the frog first. Then work along the frog area attaching tie plates. Place the frog, check location of dots to get a feel of where the ends will go, take the frog off, glue plates on, and repeat.

Cut two lengths of rail for the frog extensions and cut some 0.010" styrene. Using medium viscosity CA, glue the styrene to the end of the rail that goes next to the frog and set the assembly aside to dry.

While the styrene insulator bits dry, tape the straight stock rail in place to help align the frog. Clean the base of the frog and the frog tie plates with acetone to remove any flux and oils. Mix up a small batch of my diluted Pliobond/Acetone mix, and

apply the glue to the base of the frog and to the tie plates with a scrap piece of stripwood.

Position the frog using a NMRA standards gauge. After you are satisfied with the frog's location, gently heat it with a dry soldering iron. Too much heat will cause the solder to melt. Apply just a couple of seconds of heat in one spot and then move along the frog. Cover the turnout with paper to prevent scratching the rails and place a brick on top of it while the glue cures.

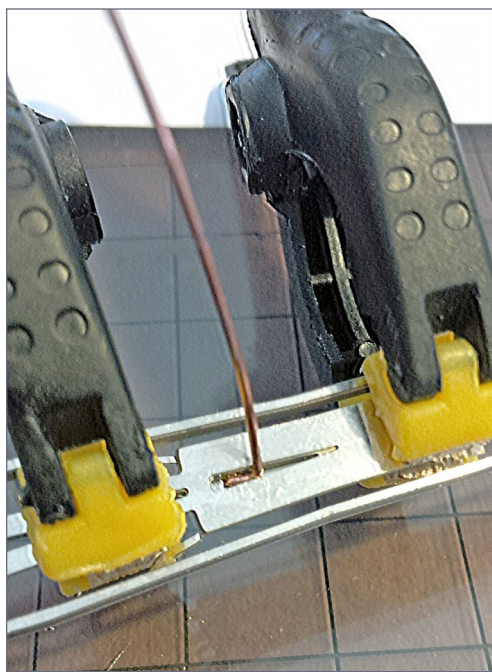

18. Test-fitting the feeder wire on the frog.

## THE SWITCH AT BEAVER CREEK | 19

While the frog is under pressure from the brick, turn to the frog extension rails. Trim the styrene with an X-Acto knife and file it to shape to match the rail head. After more gluing and gauging is performed, install the frog extension rails and cover it back up with the paper and brick.

Using the paper template, cut the closure rails to length and test fit them. Next, tin the turnout end of the rail and add styrene insulators to the frog end of the rails.

After locating and removing the switch hinge plate on the fret, clean and tin the back of the hinge. With the closure rails in the correct orientation, solder the hinge plate to the ends of the closure rails [32].

Clean the closure rails and glue them in place using thinned Plibond. Check the position with an NMRA gauge. Heat the rails with the dry soldering iron to set the glue. Finally, place a piece of paper over the turnout and put the weight on top to let the glue cure.



19. My second attempt at the frog. Much better.



# FAST TRACKS

## YOUR VERY OWN TRACK FACTORY

Make the most of your modeling experience.

Build perfect trackwork easily and inexpensively when YOU want it!



Check out our extensive (and growing!) online video library to learn how easy it is to hand lay your own trackwork with Fast Tracks tools and supplies.

*Play Video* 



shop online 24/7

1-888-252-3895

[handlaidtrack.com](http://handlaidtrack.com)

[service@fast-tracks.net](mailto:service@fast-tracks.net)

[MRHMAG.COM](http://MRHMAG.COM)

- [TABLE OF CONTENTS](#)
- [INDEX](#)

# THE SWITCH AT BEAVER CREEK | 20



20. The tools used for the next phase of the turnout construction.

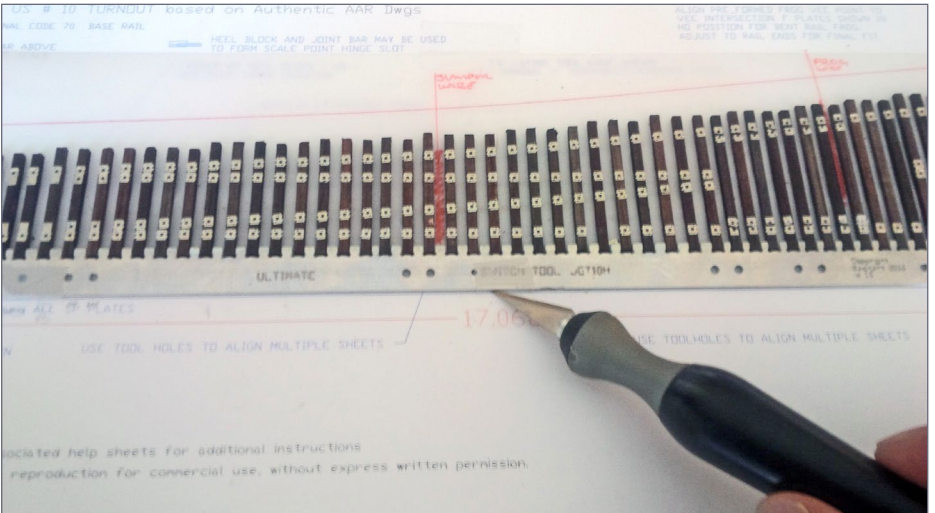

21. The location of feeder wires are marked on the plastic. The red line is the where the excess plastic is to be cut away.

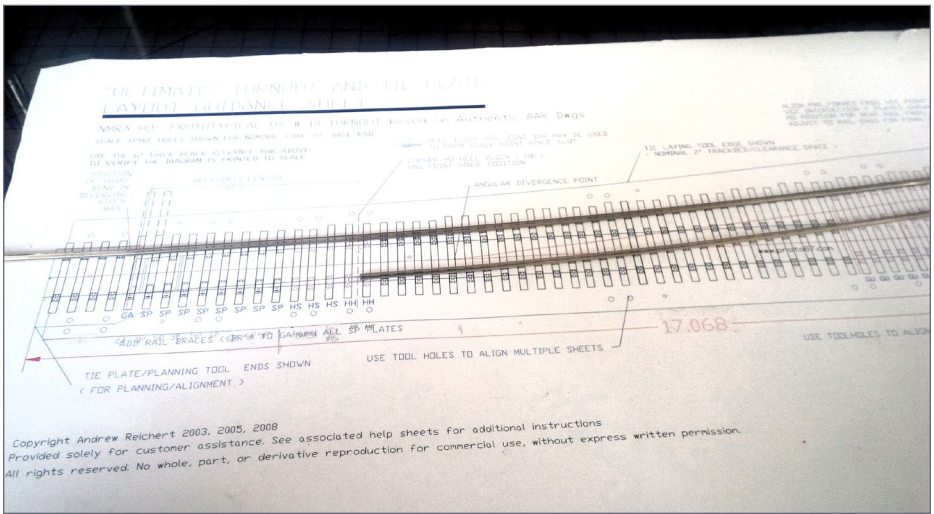

22. The template is used to mark the bends in the rail of the diverging route.

## The 'point' of the matter

Identify the parts required for the points [33]. There are two turnout bars. One does a pushing action and the other hooks into the point rails to do the pulling action. Trim the pull bar but leave it long enough to remain trapped under the stock rails. Test fit the push and pull bars in the turnout, filing them to ensure that they do not bind.

Remove the push and pull bar etchings from the small fret and use a pair of flat-nosed pliers to push them into the mounting holes [34].

Using the paper template, mark and cut the points to length. Leave them a bit long to trim after final placement is determined. After tinning the rails and the back of one of the hinge blocks, solder it into place, ensuring that it is flat and snugged down on the top of the rail base.

## THE SWITCH AT BEAVER CREEK | 22

Assemble the parts to check if any trimming of the point rail is required and to ensure that none of the parts will bind. After cleaning the flux off of the joints, move the point rail into final position to have the hinge plate soldered to it.

Install the pull bar into the little hole that's pre-drilled in the point rail and slide the push bar into place. Then install the other point rail. Getting the push bar into the other hole while everything is loose is a bit tricky, but I got there in the end. Use stripwood as blocking to hold the remaining point rail in place to solder the other hinge plate to it. Solder the pull bar hook to the point rail.

**WARNING: Do not use acetone near plastic as it melts it. I got some under both the pull and push bars. Luckily I noticed in time, and managed to flip the turnout over, cut**



23. Test fit the rail on the tie plates to make sure that it will sit properly. By carefully using the templates the rails fit perfectly.

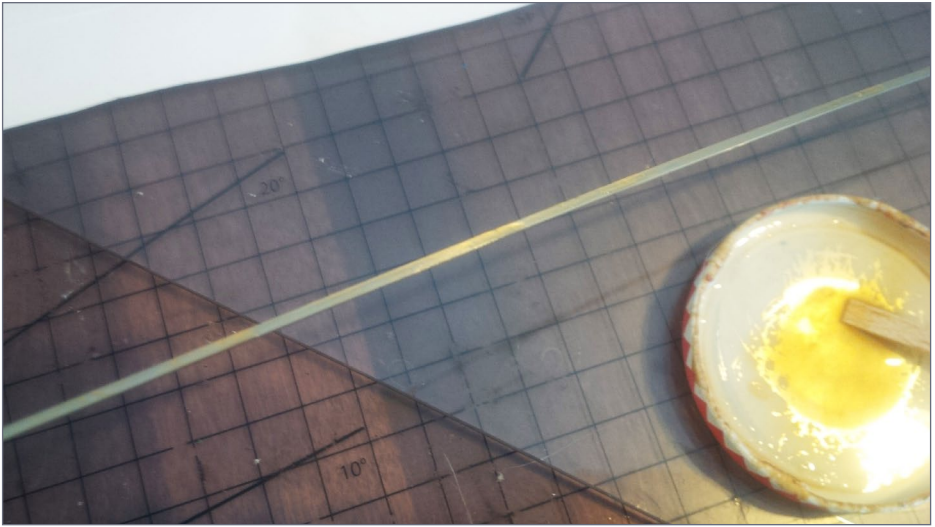

24. Pliobond has been applied to the bottom of the rail. The rail needs to be set aside till the glue becomes tacky.

**the plastic underneath the ties away, and run the X-Acto knife between the wood ties to release everything. Better to use alcohol to clean up in this area in the future.**

Clean the straight stock rail and glue it in place with thinned Pliobond. Again, cover the turnout with a piece of paper and place a weight on it while the glue cures.

While the straight stock rail is weighted down, cut some rail to use as guard rails, filing a bevel on the ends. Set the correct flangeway width with an NMRA standards gauge and glue them in place, The turnout is functionally complete at this point but there are more parts to install.

## Adding details

The kit includes rail braces for the outsides of the stock rails. Drill a #78 pilot hole in the ties where they are to go. Cut the

## THE SWITCH AT BEAVER CREEK | 24

braces from the fret. Pick them up with tweezers, being very careful not to lose them. After losing a couple small parts, I installed the larger ones on the back side of the turnout away from the viewer and put the smaller ones on the viewer's side of the turnout. Finally, solder the point rail bolt detail strips and the turnout point details in place and add an .020" x .030" styrene strip.

The backs of the connection plates have a slot etched into them. That allows them to sit on top of the metal push/pull bar parts. Cut two pieces of .020" x .030" styrene to fit between the point rails and test fit them. I would have preferred to use .010" styrene, but I didn't have any on hand.

Next, apply medium viscosity CA to the top of the metal parts of the point push and pull bars. Place the styrene strips on the push and pull bars and spray some CA accelerator to speed up the glue.



25. Pliobond is added applied to the tie plates. Be careful of the strings created by the Pliobond and remove them.



## THE SWITCH AT BEAVER CREEK | 25

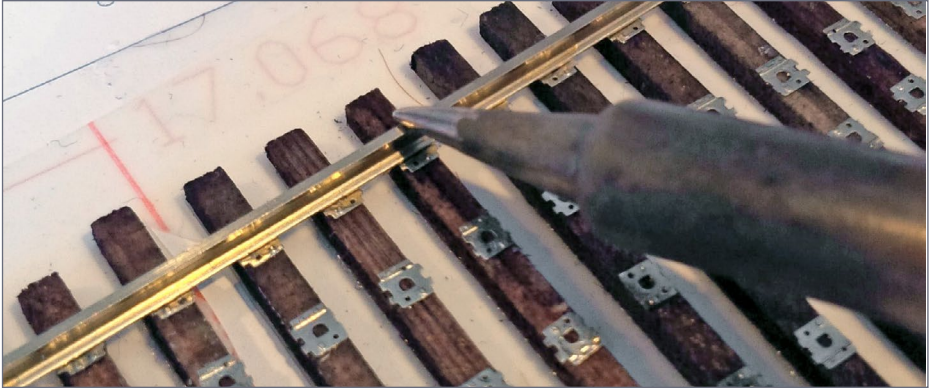

26. A soldering iron is used to heat the rails and set the Pliobond.

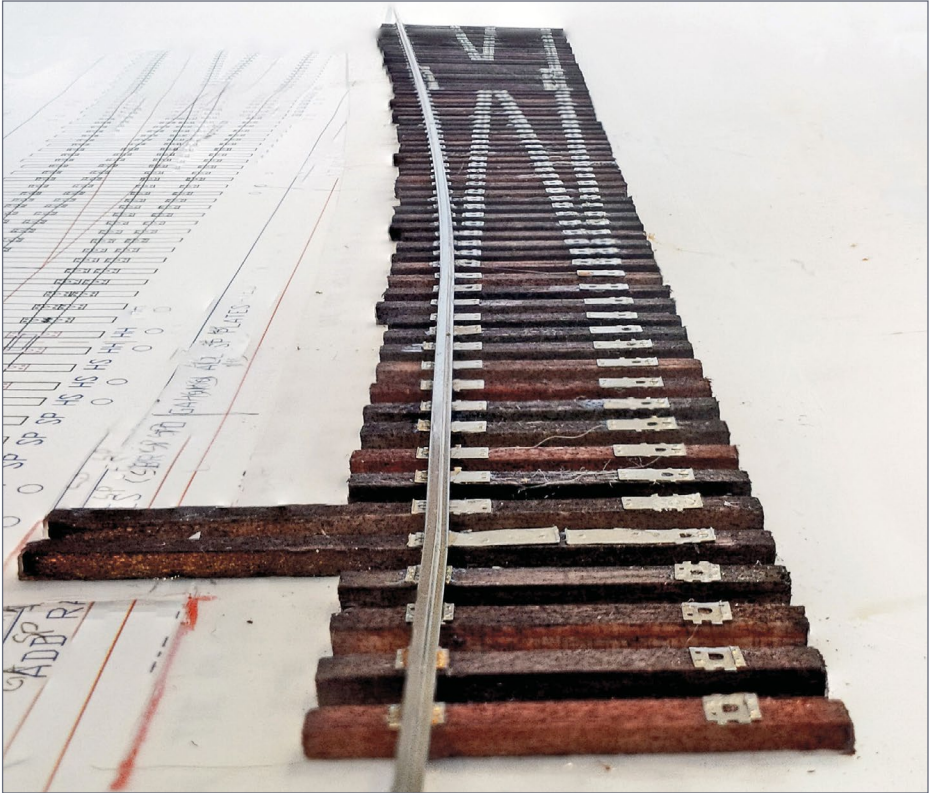

27. The first rail in place.

## THE SWITCH AT BEAVER CREEK | 26

Trim the styrene to allow the point bar adjustment plates to fit between the styrene strip and point rail, then secure them with CA. I didn't get them perfectly installed but I did ensure that they would not interfere with RP25 wheel flanges. Cut the nut and bolt details from the fret and after losing and finding the parts, glue them to the styrene using CA. Once they are in place, hit the CA with some accelerator so they will not move if bumped accidentally. The parts are so small that manipulating them is tricky.

One of the point rail detail strips came loose. With tweezers, a bit of flux and solder I quickly fixed it. While the iron was hot, I installed the jumpers for the closure rails. Clean the Pliobond off the bottom of the rails with a bit of acetone and scrape it with a knife. Then apply flux and tin the rail bottoms.

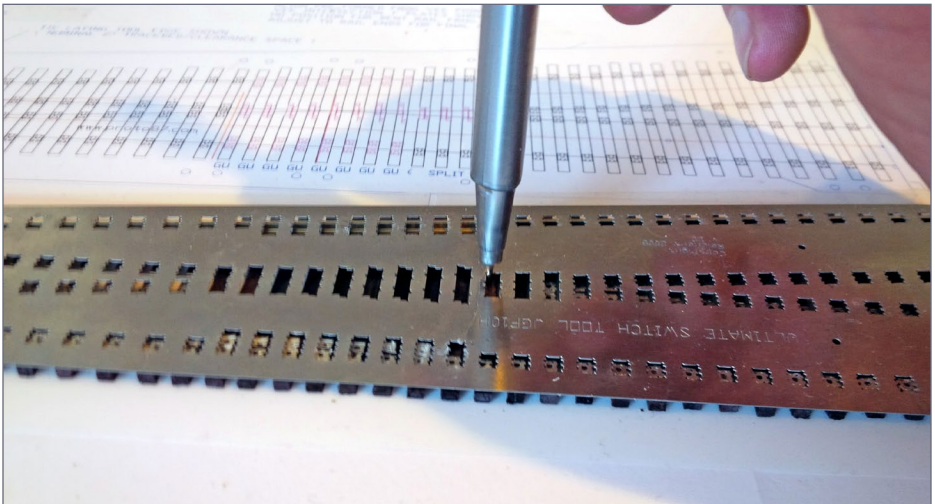

28. The template is placed back on the ties and the locations for the frog tie plates are marked directly on the ties.



29. The frog tie plates have been cut out and readied for installing.



30. Styrene is added to the ends of the rails to electrically isolate the frog from the closure rails.

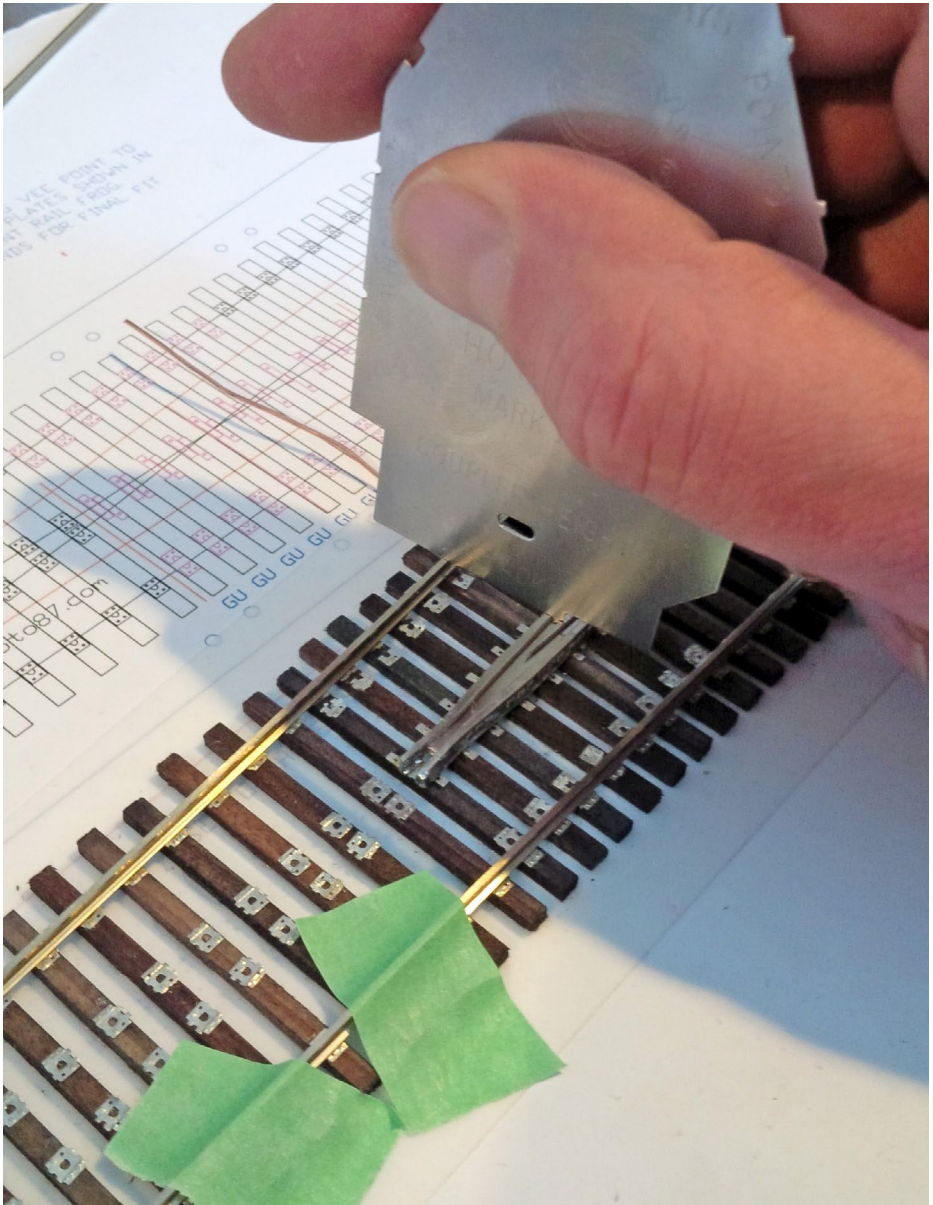

31. The frog is glued into place and the gauge is checked with my NMRA gauge. I taped the through route stock rail in place to check the gauge of that route also.

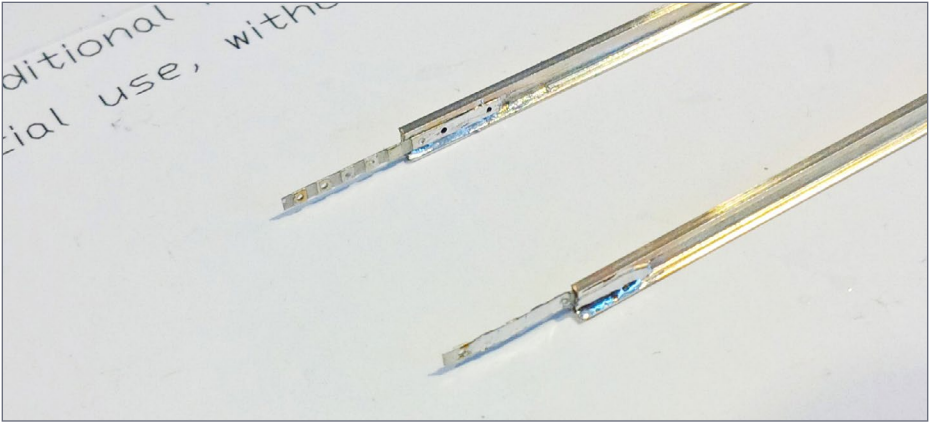

32. The hinges are soldered to the closure rails prior to installation.



33. The parts laid out and identified for the points.

Select a single strand of wire and tin the end before soldering it into place. Form the jumper wires in U shape so the wire is below the rail bottom level. When the track is ballasted the jumpers will disappear under the ballast. Finally, clean the area with acetone and a toothbrush to remove the flux.

After turning the turnout back over, use tweezers to get the jumpers below the tie tops. Then, clean again with acetone and toothbrush to remove the flux. Is it perfect? Nope. Did I make errors? For sure. Am I happy with it? Yes.

# THE SWITCH AT BEAVER CREEK | 30

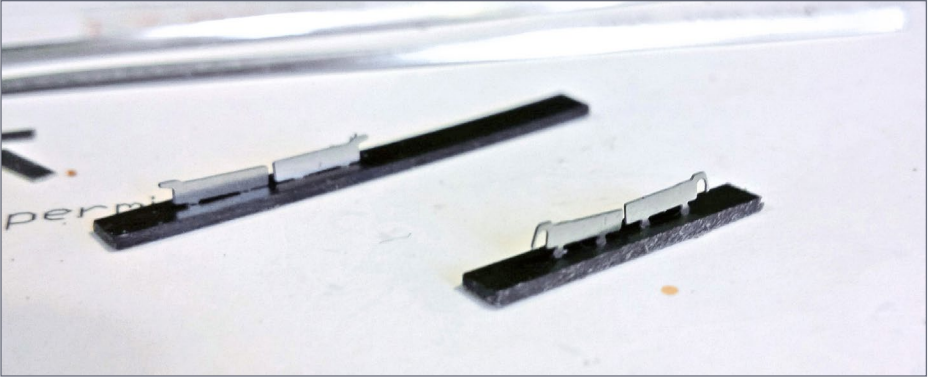

34. Here are the completed push (rear) and pull (front) bars.

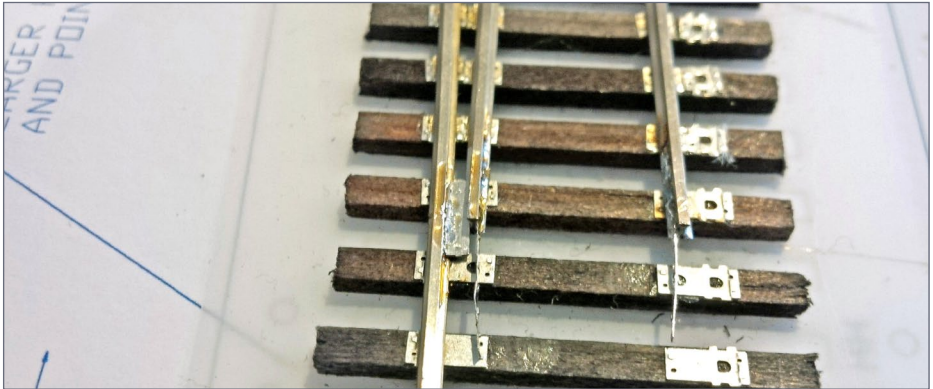

35. The hinge block is soldered in place. It is important to make sure it's sitting on the top of the rail base.

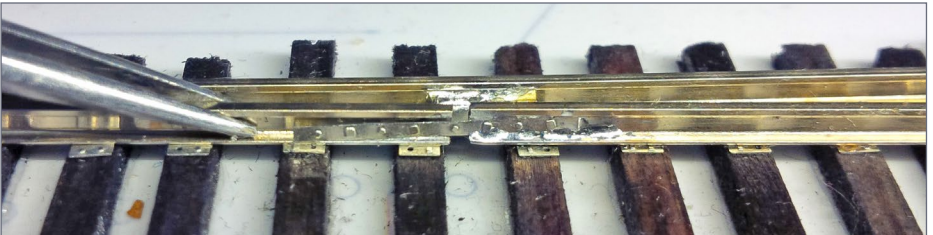

36. I assembled the parts to check if any trimming of the point rail was required and to ensure that the parts did not bind. I moved the point rail into final position to solder the hinge plate to it.

## THE SWITCH AT BEAVER CREEK | 31

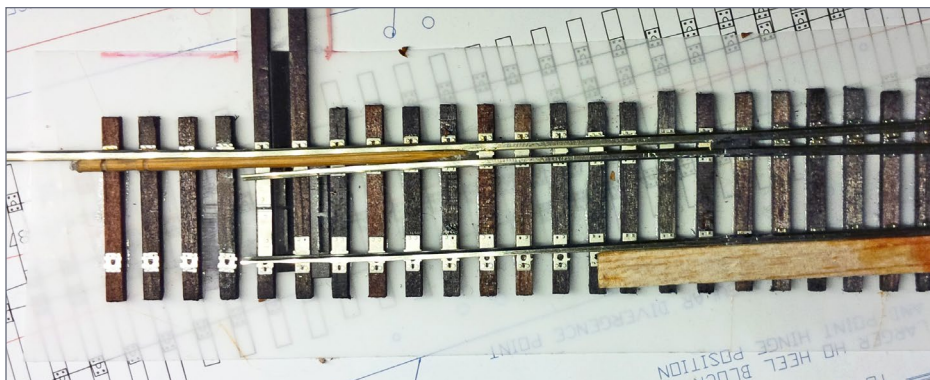

37. The push/pull bars are in place and the other point rail is installed.

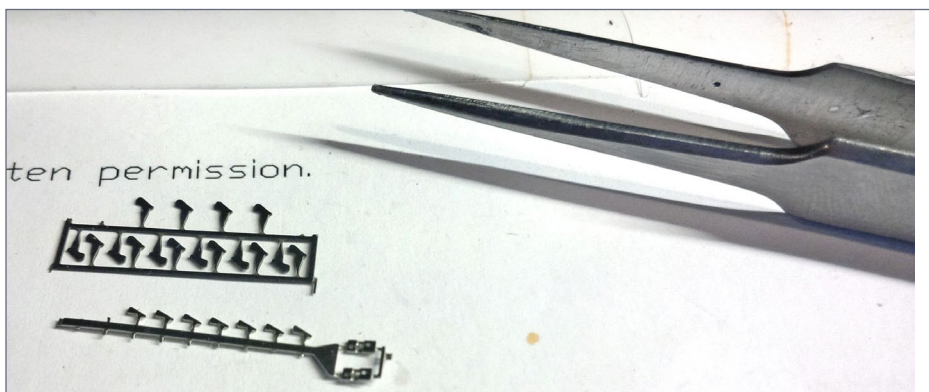

38. The rail braces on are on the fret.

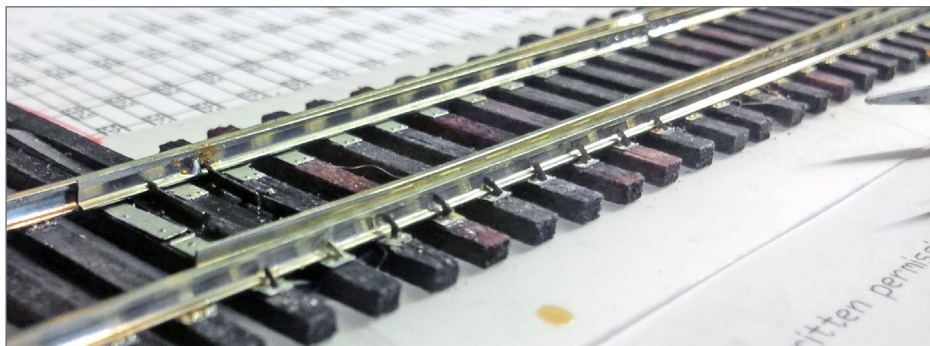

39. The rail braces are installed on the turnout.

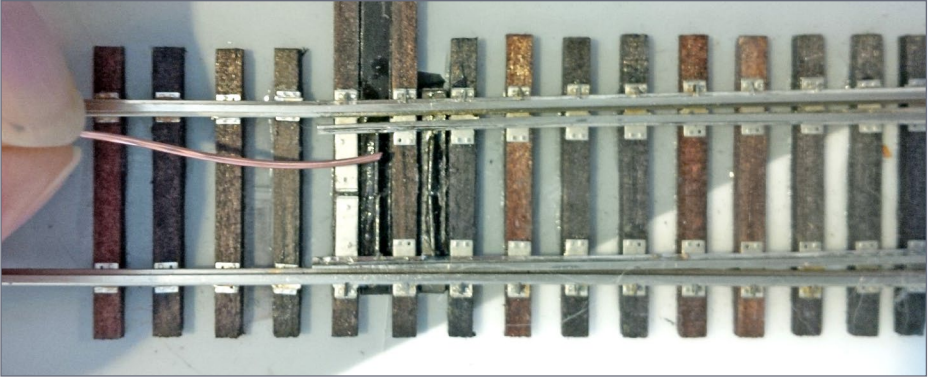

40. Carefully apply some CA to the push/pull bars. Check that the points still move after adding the .020" x .030" styrene.

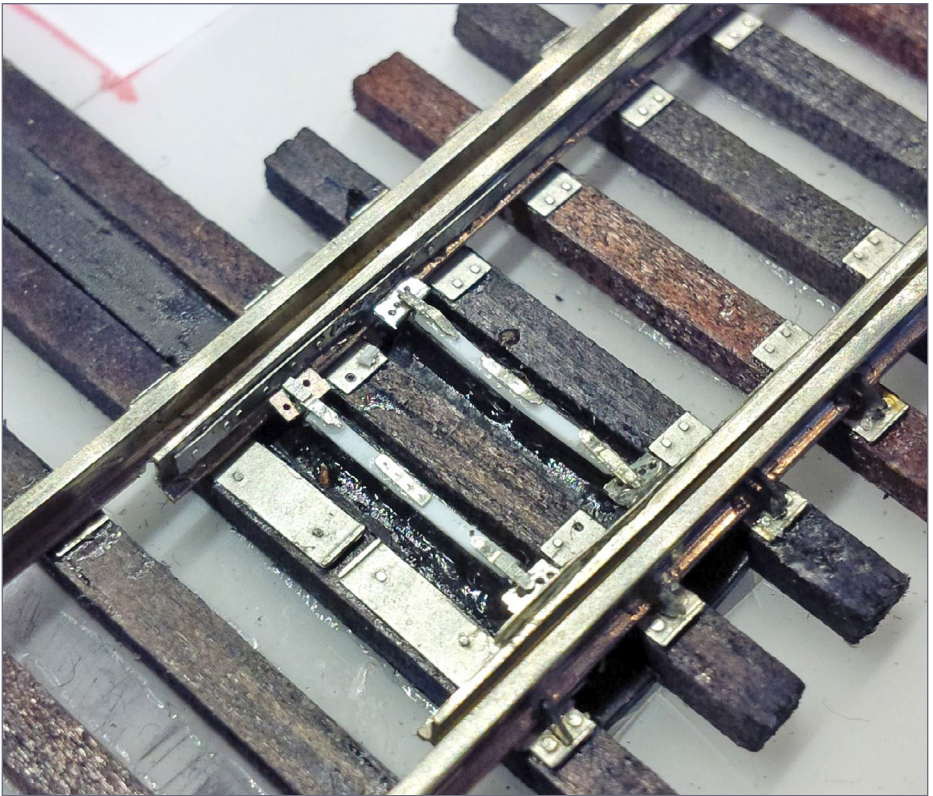

41. The point detail is complete.



## THE SWITCH AT BEAVER CREEK | 33



42. I turned the assembly over, cut away some of the plastic sheet and soldered on jumper wires between the stock rail and the closure rail on both sides of the turnout.

Building the turnout took about seven full days. I worked on it only one day a week and taking pictures slowed things down a bit. Waiting for glue to dry also took some time. It is one of those kits that requires some patience and you have to plug away at it.



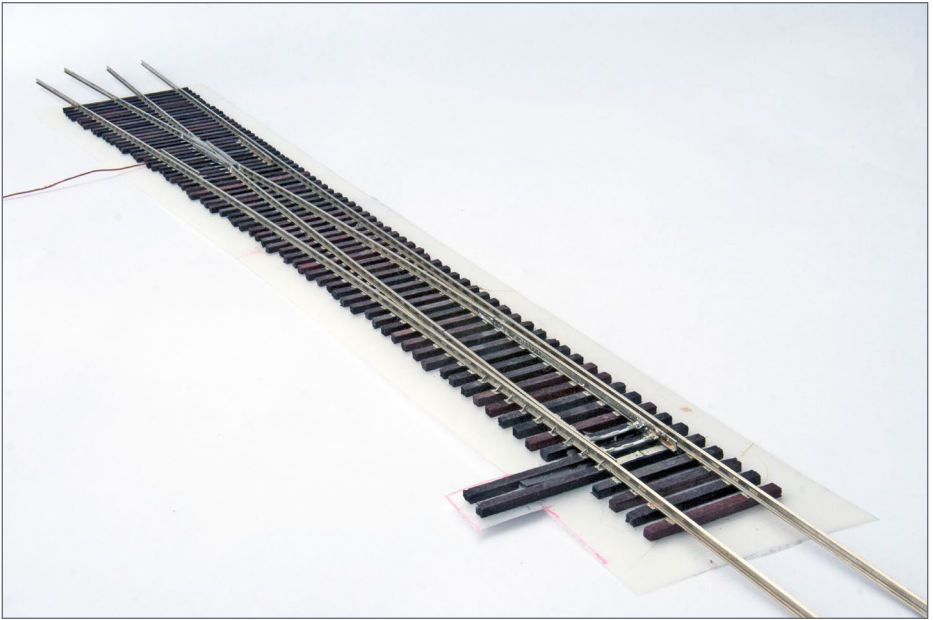

43. Construction is complete on the turnout.

## Painting and a sneak peek

Micro Engineering rail weathering solution works to blacken the flange ways of the frog. Mix a small batch and apply it to the area with a small brush. I used chemical weathering for this step because paint gets worn off over time.

Clean the rails with acetone and use alcohol around the plastic parts. I mixed my own rail brown color paint using Model Masters Enamel paints.

I used:

- 1 part Model Master Rust
- 1 part Model Master Raw Umber
- 1 part Model Master Dark Drab

# THE SWITCH AT BEAVER CREEK | 35

44. The Model Master paints I use to paint the rails.



45. Micro Engineering rail weathering solution darkens the rails in the frog and guard rail areas.

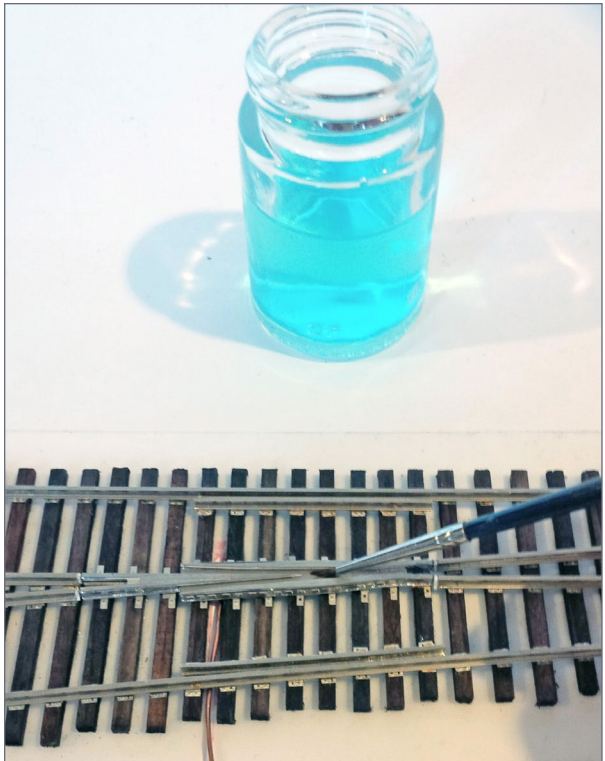

This is just the base layer of color. Paint the rails and tie plates with a small brush. Don't expect to cover it all in one coat. After all the rails are painted but before the paint cures, use an X-Acto knife to scrape the paint from the rail heads.

Polish the rail head with a small piece of 1000 grit wet/dry sandpaper to remove scratches and remaining paint. I applied a bit of NO-OX and used a metal wheelset to spread it around. I let the NO-OX sit overnight and the next day wiped it off with a paper towel.

Using a small brush, I randomly apply rusts, blacks, and dirt colors of weathering powders to the rails and joint bars. They look bright and harsh, but when the ballast is glued down, the colors are muted and merged together. As a test to see how it will look, I applied some loose ballast.

### I make life difficult for myself

After aligning the turnout, some of the plastic CVT ties may have to be moved ever so slightly. Use a knife to cut them free of the caulk. On the bridge side of the turnout, glue down some 1/8" sheet cork using carpenters glue and lay the road bed cork, using a straight edge to keep it straight. Park the brick train on the cork while the glue sets.

Never underestimate the ability of a frog wire to position itself above a benchwork support. I marked an offset turnout throw rod hole for the Tortoise and the angled hole for the frog wire and built a headblock support bit out of cork around the throw rod hole.

After the glue has set up on freshly laid sections, sand any high spots and round the sides of the cork to take off the rough edge from separating the two cork pieces.



**46. Add some ballast to see how the finished and weathered turnout will look once it is in place on the layout.**

Next, glue two sections of CVT tie strips together using plastic cement. Use them to align the turnout and set the easement into the curve. Get down to track level and sight along the rails or molded tie plates for this.

Fit a piece of ME code 83 flex track to go between the completed section and the turnout. Slip some ME ties onto the end of the turnout and mark the area with a letter E as a reminder not to solder this joint since this is an expansion joint.

With all the rails cut to length and test fitted in place, mark where the feeder wire holes are to be drilled. Solder the feeders to the bottom of the rails by cleaning the bottom of the rail, applying a bit of rosin flux and then tinning the rail. Do the same for the wire, bend it into a shape of an “L” and test fit the feeder. Solder the two together. Clean the area with alcohol and a toothbrush to remove any remaining flux.

## THE SWITCH AT BEAVER CREEK | 38

Apply a thin layer of caulk to glue the tie strips down. When the ties are fixed in place, solder the new rails for the main line together and curve them into position, checking for any kinks.

Make up a batch of thinned Pliobond and coat the bottom of the rail. Apply the Pliobond mixture to the tie plates on the CVT ties. Apply caulk under the turnout, keeping it away from the moving parts, and press everything down with weights.

Apply caulk to the roadbed on the bridge side of the turnout and glue down another CVT tie strip.

After it sets up, remove the weights and with a temporary rail in place, sight down the rails, making any small adjustments needed to straighten the rail.

When all looks as good as it can be, glue the final rails in place using the dry soldering iron to heat the rail and cure the Pliobond.

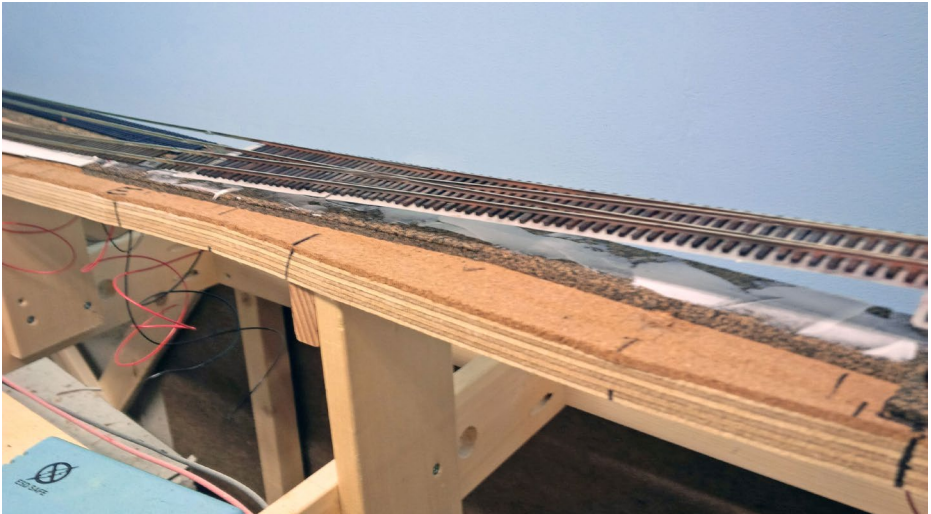

47. Caulk was applied to the cork roadbed under the turnout and the turnout set in place.

The next day I removed the bricks and ran a car through the switch. It derailed. I was miffed. Upon further inspection I discovered that the points were sitting higher than the rail head because the push bar was warped. To remedy this, I glued an .030" square styrene bit under each stock rail to hold the bar flat, and filed the tips of the points a bit. Things run much better now.

### Tortoise time

To locate the hole for the Tortoise throw wire, center the points in mid-throw over the center of the throw bar hole in the benchwork and drill a #61 hole in the turnout throwbar.

Substitute an .037" throw wire for the thinner wire that comes with the Tortoise. Mount the Tortoise using screws. Line up the wire and the turnout throw bar. I added a six-position euro connector on the benchwork to receive the wires from the switch machine.

When I ordered edge connectors for the Tortoises, there were no eight-position ones in stock. I blanked the unneeded

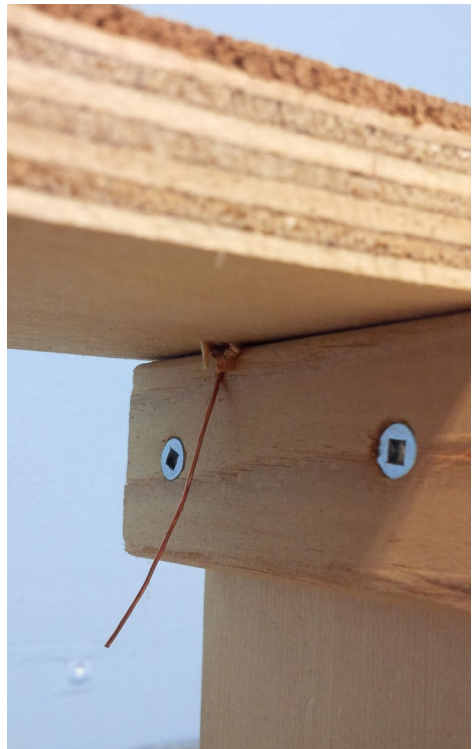

**48. Never underestimate the ability of benchwork to get in the way. The feeder wire from the frog is directly over a riser. I was able to get around it by drilling the hole at an angle.**



49. A piece of rail was set on the CV ties and used as a sight line to make sure that the CV ties are straight.



50. Looking down the rails of the completed installation.

positions on a 10-connector switch using styrene, and added a block at the other end to maintain alignment.

The main turnout control panel has a terminal block for the second Digitrax SE8C board made up of DIN rail cut to fit and Phoenix Connector Terminal blocks.



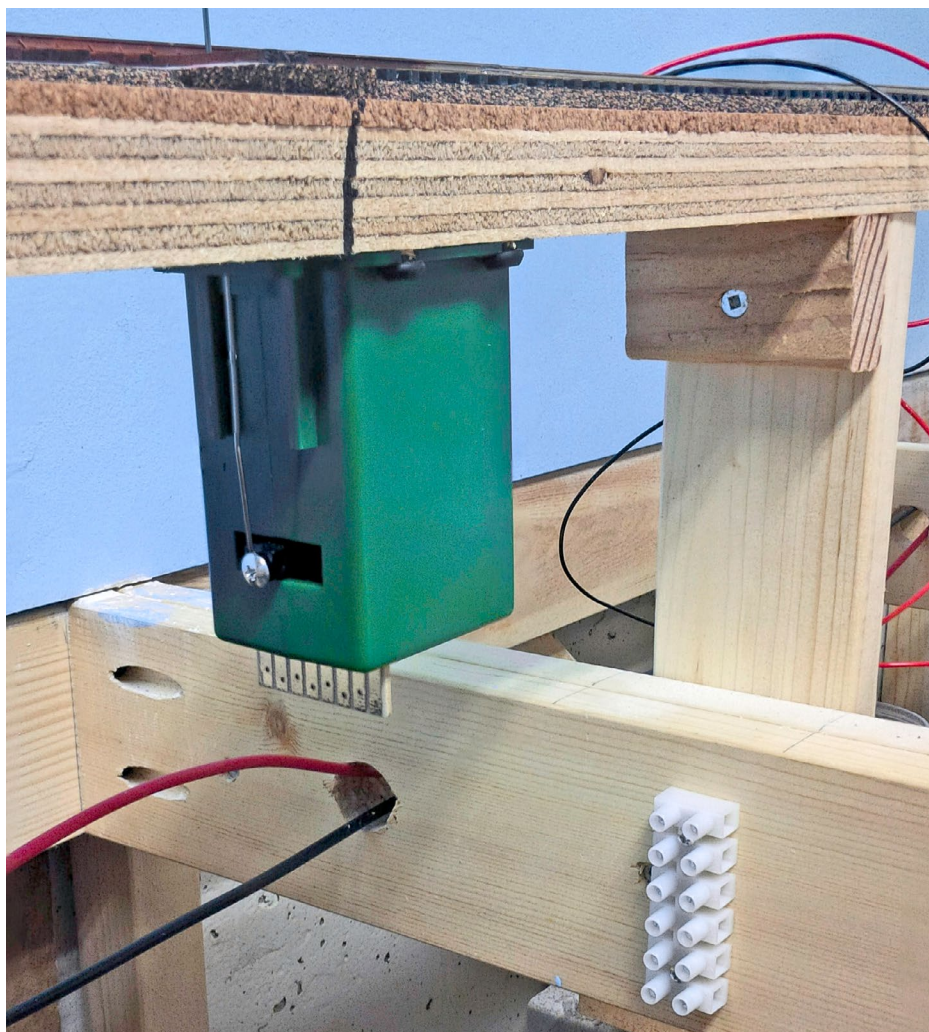

## 51. The Tortoise is installed.

A push button on the fascia allows local control of the turnout. All of the push buttons have a common connection so a jumper strip joins five blocks together.

I laced up a bundle of four wires, two purple for the turnout motor and two orange for the local control push button. The

# THE SWITCH AT BEAVER CREEK | 42

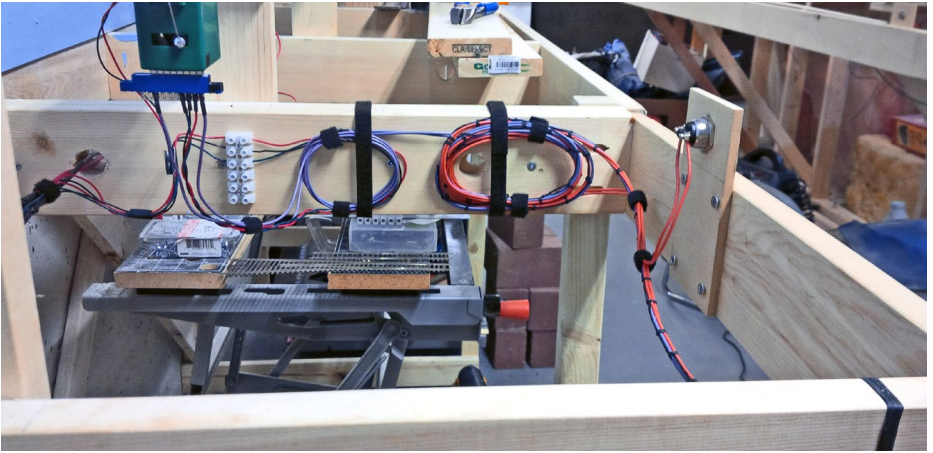

52. The Tortoise is wired and the push button for control is on the right. You can see the loops of wire that I added to allow for future maintenance if needed.

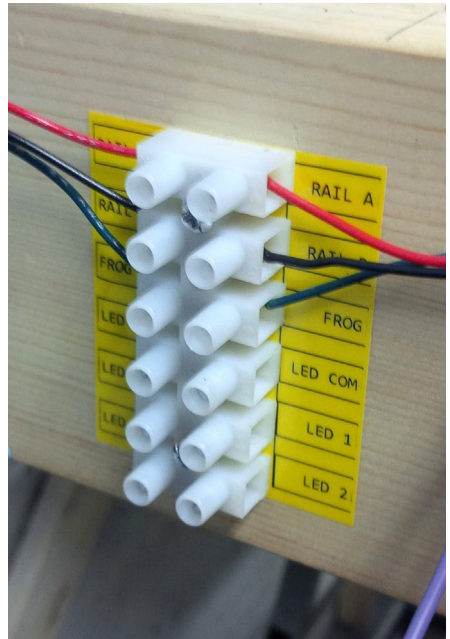

52, 53. I apply a label on the Tortoise marking the purpose of each connection and then duplicate the labeling at the terminal strip.

cable is secured to the benchwork with Velcro and cable lacing twine.

Solder the two purple wires to the edge connector for the motor, and red, black and green wires for the frog. I added heat shrink tubing but only shrank the purple ones because I wasn't sure if I had the black and red wires in the correct locations.

Hook up the Rail A and B wires from the track bus to the euro connector, and then connect the feeder wires from the track above.

Install the push button panel. With a continuity tester, check that the frog wires on the edge connector are wired correctly by manually moving the Tortoise between the normal and diverging positions. I had the Rail A and Rail B wires reversed, but it was easy to disconnect and re-solder them to change the wire positions.

At the control panel, locate the turnout's position on the terminal block and connect the purple and orange wires. Jumper the newly installed wires to an unused position on an unused SE8C board and push the button. It's alive! As a final step, label all the connections on the Tortoise and the euro connector.

This turnout can now be controlled by a push button, a Digitrax throttle, or a computer via JMRI.

This is not a one-evening project. I began building a Proto:87 turnout at the end of November of 2014 and finished installing its Circuitron Tortoise turnout motor in January of this year. My goal was to have the track ready for running trains by February, so I beat my deadline.

In February, we'll do the bridge for Beaver Creek.

## ANDREW HALL



He has always liked trains and has had a few layouts throughout the years. Growing up next to the Burlington Northern line in Fruitvale, BC and having CP Rail “next door” in Trail, provided ample rail fanning opportunities.

He has returned to the hobby in the last two years and is currently building a freelance HO scale model railroad located in the southern Alberta/British Columbia area. Based on the mod-

ern Canadian Pacific, with an occasional throwback to the 80s Burlington Northern. ■

---



[Click here for  
reader comments](#)

When talking to hobby vendors, please remember to mention MRH.



# The Amherst Railway Society Railroad Hobby Show

Our 2016 Show will be

# January 30 & 31, 2016

Save the dates!

## About The Show

Every year late in January or early in February, the Amherst Railway Society holds its Railroad Hobby Show at the Eastern States Exposition Fairgrounds (The home of The Big E) in West Springfield, Massachusetts. More than 25,000 railfans and public attended the Show each of the past three years.

The event features real life railroads and scale model railroads, historical societies, travel agencies, art shows, flea market dealers, importers, manufacturers and photographers. You have to see it to believe it!



**Click  
to learn  
more ...**



*Joe B*

*Jeff*

# *Merry Christmas*

*Richard*

*Char*

*Bruce*

*Mike*

# My Amas

Les

Patty

Jean-François



lie

Joe F

Don

Ken

Daniel



Jim F

Larry

YES, IT'S A MODEL



[Click here for reader comments](#)

# How to model Working miniature cranes Part 1

BY DR. GEOFF BUNZA

.....  
Photos by the author

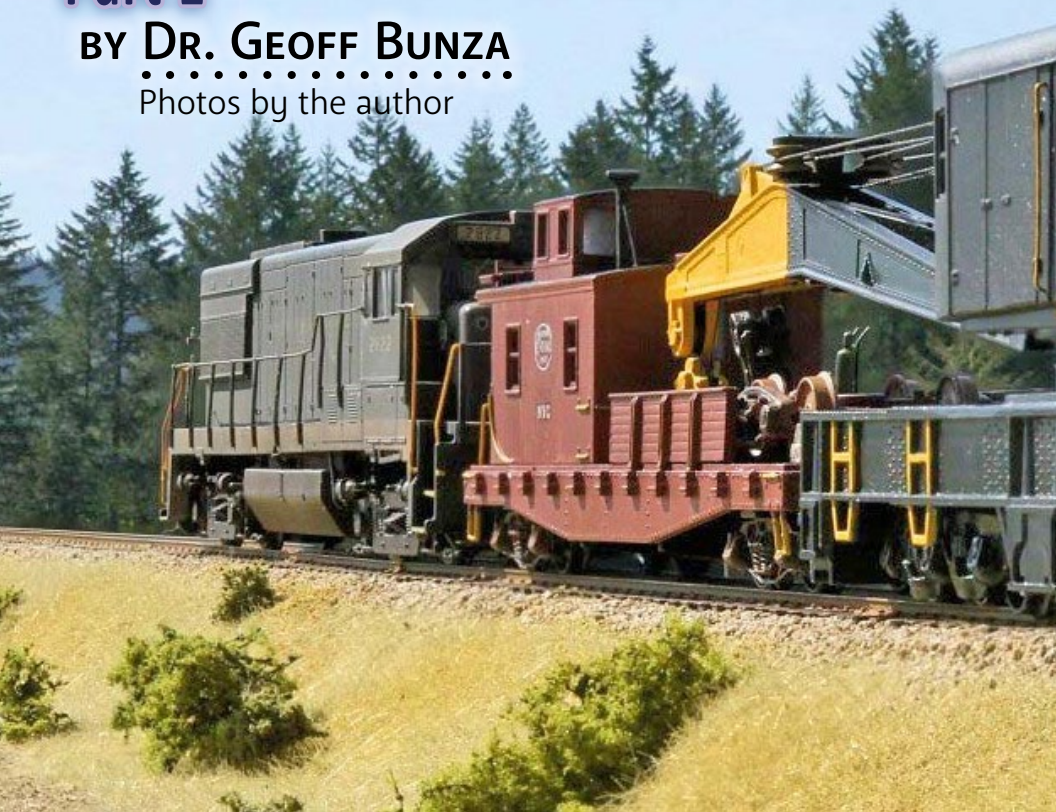

***Put these animated cranes to work on your layout ...***

**THE 250-TON CRANE I DESCRIBED IN THE August 2012 *Model Railroad Hobbyist* ([model-railroad-hobbyist.com/magazine/mrh-2012-08-aug](http://model-railroad-hobbyist.com/magazine/mrh-2012-08-aug)) whetted my appetite for**

**MRHMAG.COM**

- **TABLE OF CONTENTS**
- **INDEX**





## 1. Animated Athearn DCC crane.

additional animated cranes. Cranes make a great interest-grabber on any layout or module, particularly for a club or show. There are many prototypes available to choose from, either older, truck-mounted cranes or newer self-propelled cranes on caterpillar treads.

Cranes are a great place to start putting animation to work on a layout. They open possibilities for movement, lighting, and even sound to enhance a scene.



[Click here for reader comments](#)

I will detail how to build four low-cost animated cranes with simple hand tools most modelers have. I'll start with a truck-mounted crane that uses two DC motors, then I will do a multi-featured DCC controlled truck-mounted crane model with three motors and lights.

After that, I'll do two mobile crane projects with cranes on caterpillar treads and show how you can put them on your layout using two different control methods: one with in-the-layout wire-guided control, and the other using wireless remote control, ending with a special "moving" animation.

## Gathering the resources

The crane-equipped truck shown in [2] was a 1940s-era model mounted on a 6x6 frame built by White, Corbitt, and Brockway,



for the U.S. Army, and shipped all over the world. I used a similar approach for modeling the truck-mounted cranes I build here.

**2. Military truck crane.**

## WORKING CRANES | 4

Commercial cranes obtained as military surplus were often heavily modified, and of course re-lettered and repainted. These saw service in many places for decades.



3. Herpa/Roco trucks M-923, M-54 and M-35A2 left to right used for this project.

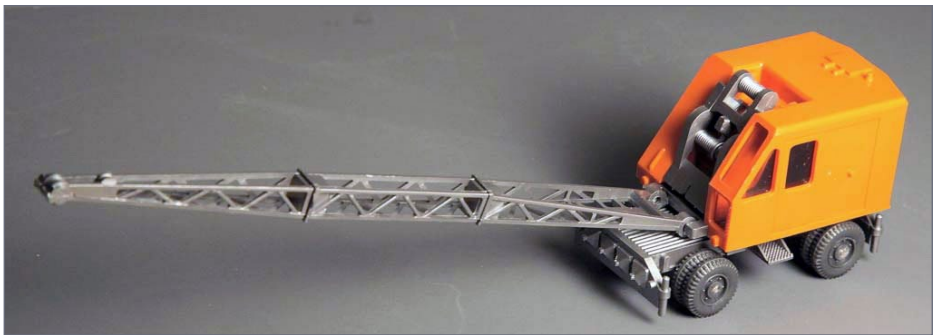

4. Original Wiking wheeled crane used to make the truck crane.



5. Original Wiking crane with caterpillar treads.

## Building a truck crane (Crane #18)

For the first crane, we'll start with a Roco model of an M-35, M-35A2, M-54, or an M-923 depending on the era you are modeling. The model crane cab and boom in the models come from a Wiking wheeled or tracked tread crane. Together, they make quite a presentable truck-mounted crane. The Wiking crane cab has the distinct advantage of being a hollow shell, which allows for added mechanisms inside.

## STEP 1: PREPARE THE TRUCK BED

First, disassemble the truck body and frame. Remove the chassis floor, then cut the floor so as to preserve the flaps around the rear wheel mount [6]. Next, use styrene strips 0.08" x 0.03" and glue to extend the chassis an additional length 0.45" [7]. I chose to attach the strips to the outer and inner sides, and fill in the extension to provide strong continuous support. I have observed that over the many years these trucks were made, there seem to be small variations in the mounts, so check your dimensions and the mounting method for your particular model.



6. M-54 and M-35A2 trucks disassembled.

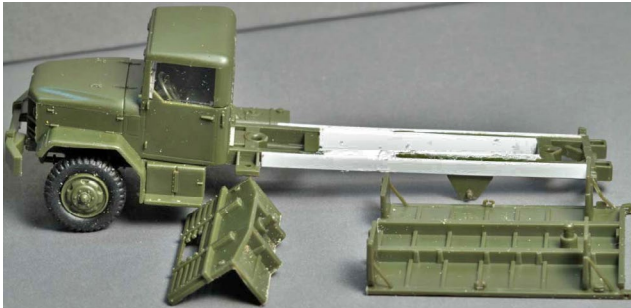

7. Starting to extend truck bed.

## STEP 1: PREPARE THE TRUCK BED *CONTINUED* ...

Re-mount the flatbed parts and measure a small piece of 0.040" styrene (I used black styrene) and glue to the top of the bed in place, forming the basis of the new bed. After the glue dries, remove the bed and fill in from below with additional styrene strips to make the width continuous when viewed from the bottom [7 – 10].

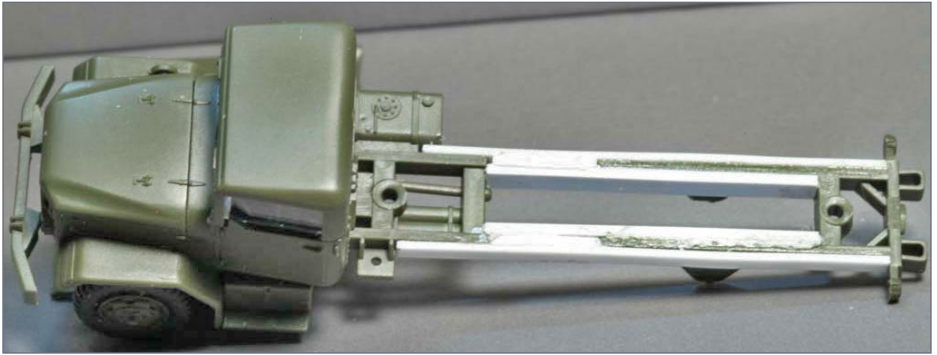

8. Truck frame extension.

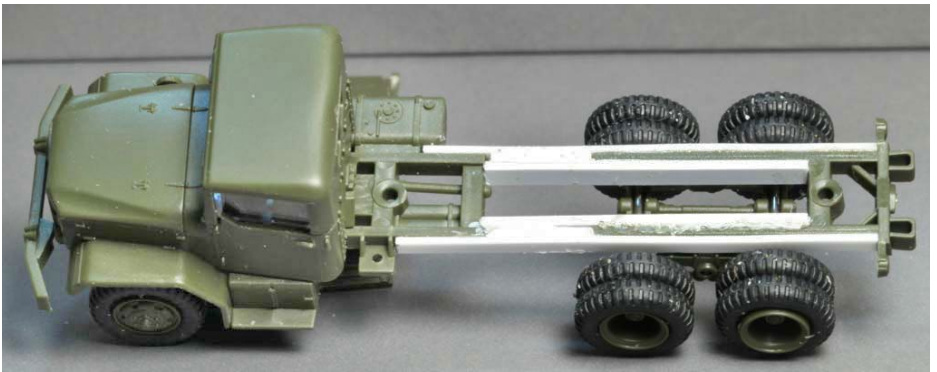

9. Truck frame extension with the wheels added.

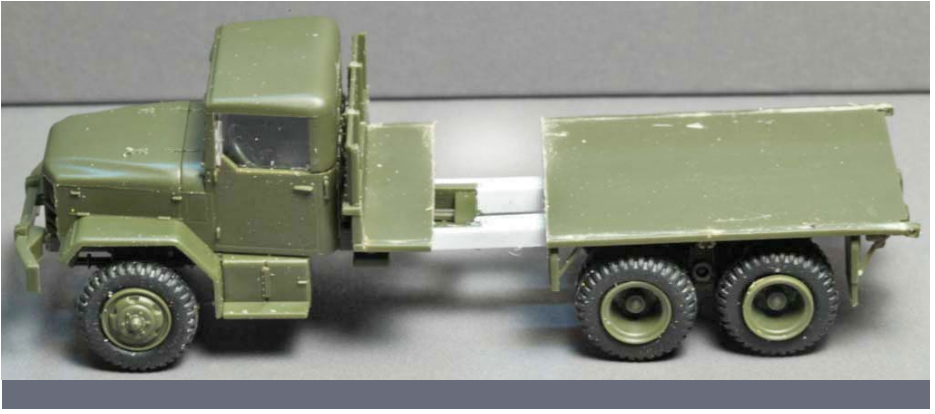

10. The original flatbed separated.

Mount the new flatbed, and drill a #52 hole in the center of the flatbed in the middle of the pair of rear axles [11]. This will provide the mounting point for the crane cab.

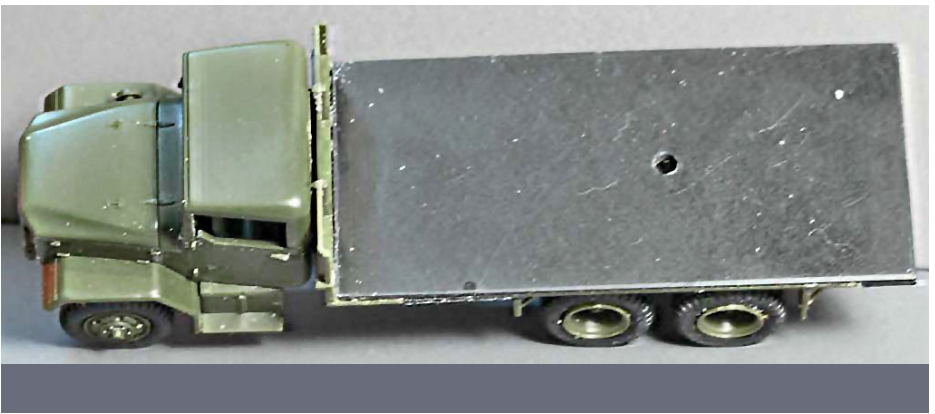

11. Flatbed extension with pivot hole drilled.

### STEP 1: PREPARE THE TRUCK BED *CONTINUED...*

While focused on the chassis, disassemble the truck cab and fill in as many open, hidden spaces as possible with pieces of lead sheet, or lead shot, to weight the cab and chassis as far forward as possible in front of the rear wheel set. This helps stabilize the truck as you move the crane boom around. Finish the truck bed by cementing 1/16" Evergreen styrene channel around the edges of the bed. Miter the corners to give it a sturdy, professional look. Before gluing the channel edging, paint it with the trim color of your choice, leaving the back bare for gluing. I chose a yellow and black scheme for the company colors.



12. Weights added between the truck frame and in the cab body.



## STEP 2: PREPARE THE CRANE CAB

Next disassemble the Wiking crane cab carefully from the base of the cab and remove the “glass” windows. Trim the window material to give more wiggle room inside the cab. Some models I have were glued in place and some were not. If you damage the window material, you can substitute clear styrene later. Preserve the cab and floor.

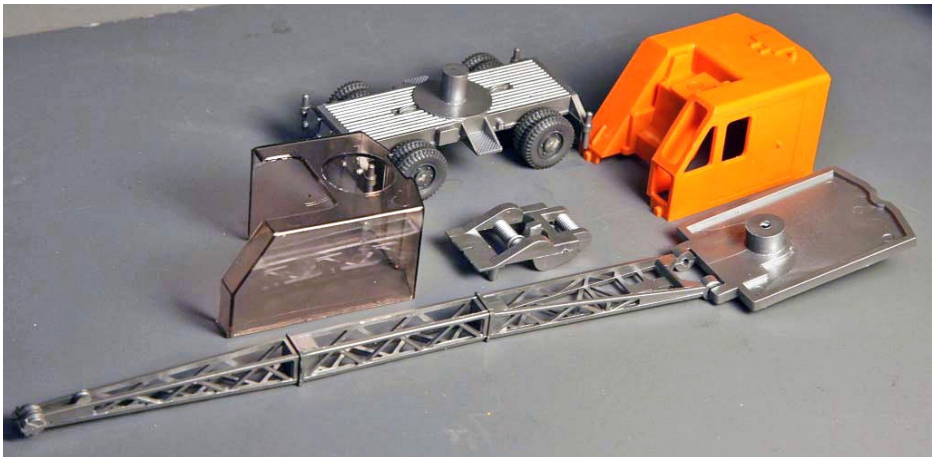

### 13. Wiking wheeled crane disassembled.

On the base of the cab, cut flat the internal hub, and widen the hole to  $11/32$ ". Next, fill in the floor with small pieces of 0.040" styrene. This creates a flat mounting surface for the cab motor and the spindle motor.

## STEP 2: PREPARE THE CRANE CAB *CONTINUED...*

Glue a small piece of 0.125" x 0.156" x 0.25" styrene to the inside of the cab where the motor would be, as a screw support to hold the cab to the floor. Drill and tap for a 0.25" 0-80 flathead screw from the floor bottom.



14. The original cab shell on the left and the modified cab shell on the right.

15. Hiding the front cut with the hoist drums.



16. Trimmed glass is on the left and the stock glass is on the right.



17. Parts for the cab-turnstile drive and mounts.

## STEP 3: MOUNT THE MOTOR DRIVES

The 90-degree-drive geared motors are available from several vendors on eBay for less than \$1.50. Search for “DC 3v 5V Worm Gear Motor” or try: [eBay.com/itm/121230293476](http://eBay.com/itm/121230293476). The drives can be trimmed by cutting and filing the excess plastic from the cases. Small protrusions can also be filed off, but make sure that the corners remain intact, leaving two small mounting holes. Tap these two remaining mounting holes for a 0-80 thread.

I found the center drive hole, [24] to be perfect for threading with a 2-56 bottoming tap. In [24], you can see the cable hoist for the “boom cable” made from a 3/16” length of 3/16” tube sandwiched between two 5/16” disks cut from 0.010” sheet styrene, and held in place with a 2-56 screw.

After smoothing/flattening the final drive, make a bushing slightly smaller than its width. I made mine starting with 1/8” Evergreen #224 styrene tube, glued in a 3/16” Evergreen #226 styrene tube, glued in a 1/4” Evergreen #228 styrene tube, with a



center clearance hole widened for a 2-56 screw with a #43 drill [18]. Flatten the ends of the hub square.

Test the angle of the mount by screwing

18. Forming the drive hub from tube styrene.

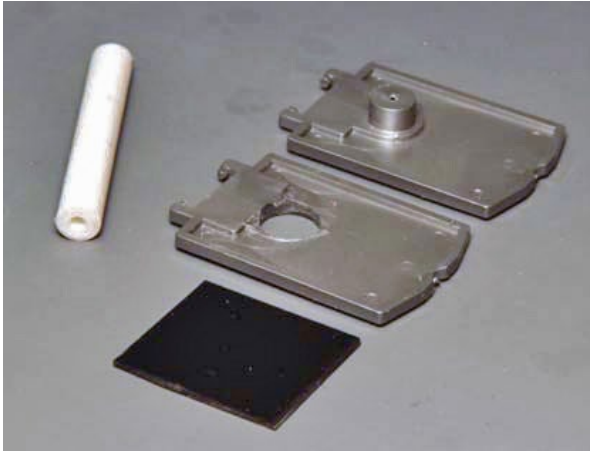

19. The new hub ready to be sized.



20. Gear motors.

the drive housing to the flatbed with a 2-26 screw from the bottom of the bed, through the bushing you just made, into the tapped 2-56 hole in the motor drive. A plastic or nylon screw can be cut to exact length to make sure you have just the right length for a tight fit. Once leveled, glue the bushing to the motor drive with a tiny amount of ACC. Use the glue sparingly. Do not get any glue on the gear teeth or on the screw threads. This is only to make the assembly and disassembly easier. The mounting screw will provide the strength for the connection.

## STEP 3: MOUNT THE MOTOR DRIVES *CONTINUED...*

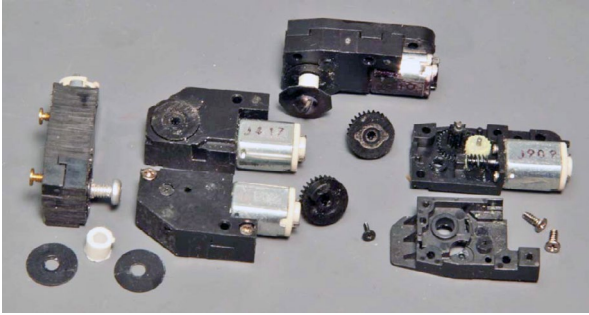

21. Motor and drive parts.

Position the bushing and level it, then attach the motor drive to the cab floor either with a 0-80 flathead screw from the bottom, or carefully glue it in place with a small amount of CA glue or epoxy. Next glue the hoist motor to a thin styrene strip and then screw the strip down to the floor next to the cab-drive. This was done for ease of future modification and maintenance.

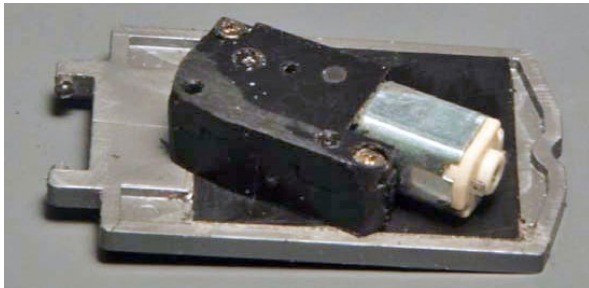

22. Cab-turnstile drive motor mounted.

Next I attach very thin, VERY flexible wires to each motor. The ones used were in my stash, but you can get equivalent, 30 AWG, ultra-flexible wire from



23. Cab turntable drive viewed from the bottom.

# Nano-Oil™

Made in U.S.A.



**New  
Innovation**

## Nano Technology Lubricants

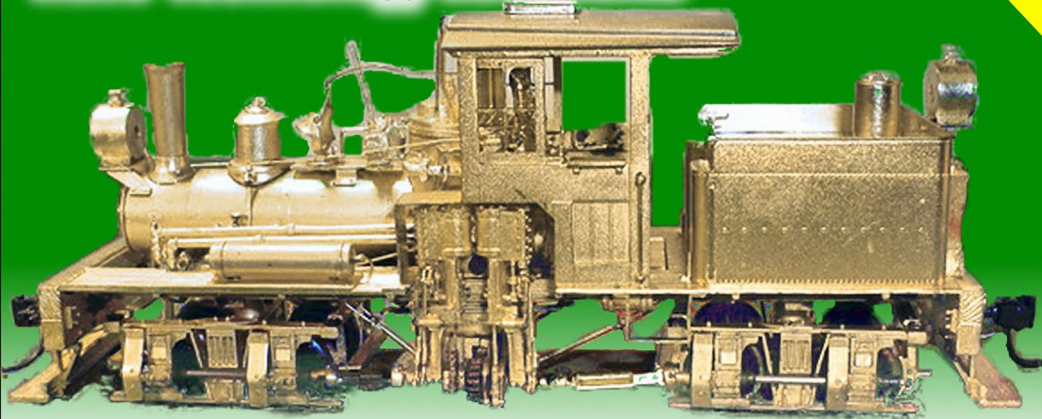

"After eight years of extensive testing, the only lubricants now used in my shop are Nano-Oils and Nano-Grease. The extreme reduction in power draw by mechanically minimizing friction is simply technologically superior."

- Phil Floyd, 'The Shay Fixer'



**Nano-Grease**

**For more details  
click here ...**



**THE SHAY FIXER** 

VISIT US AT...

**SHAYFIXER.COM**



*Specializing in brass Pacific Fast Mail / United geared locomotives*

**MRHMAG.COM**

- [TABLE OF CONTENTS](#)
- [INDEX](#)

## STEP 3: MOUNT THE MOTOR DRIVES *CONTINUED...*

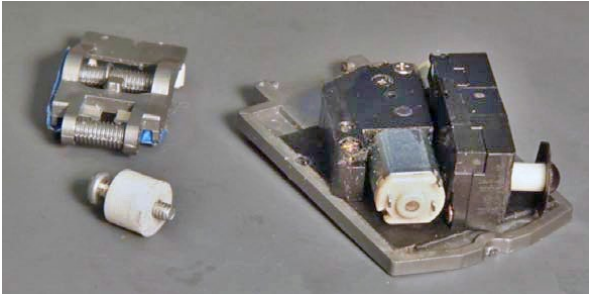

24. Cab turntable and cable drum motors.

Miniatronics Corp [miniatronics.com](http://miniatronics.com). I use permanent markers to color the leads for later reference. You may find it easier to attach the wires before securing the motor drives.

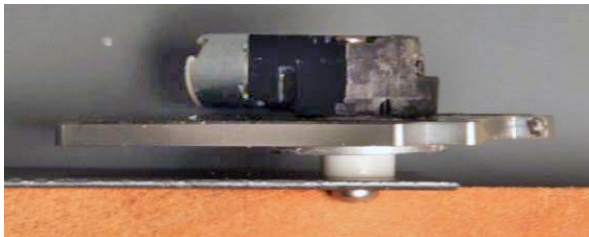

25. Crane cab turntable drive bushing test. I checked the hole to make sure it was centered and perpendicular to the drive.

It is my intent to face the crane toward the rear for operation. Once assembled, I attach the motors onto the cab floor. The hole on the bottom of the cab is enlarged toward the front of the truck.

Clearance is needed for lots of movement with the wires. This allows or limits the maximum turn of the crane cab and easy clearance of the motor wires. The cab motor and the cable drum drive barely fit inside the cab, once angled properly. A small hole is drilled in the cab floor as close as possible to the drive hub for the motor wires. I route the wires down through the cab floor behind the cab-drive hub protruding below.



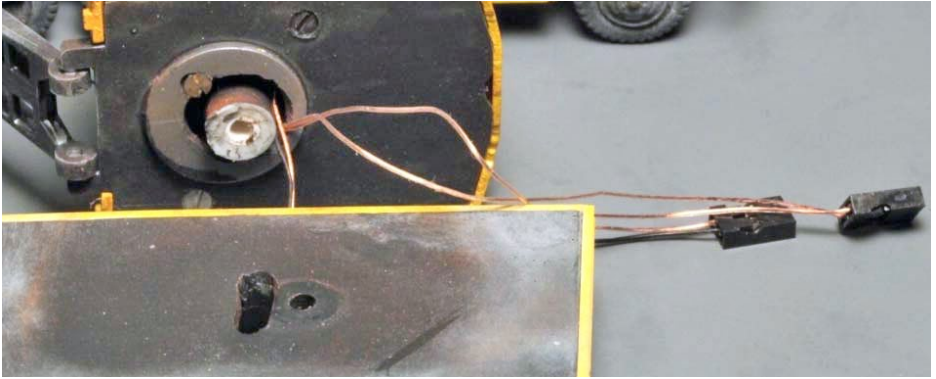

26. A shot of the crane cab bushing through crane bottom.



27. The motor drives have been mounted on cab floor.

## STEP 3: MOUNT THE MOTOR DRIVES *CONTINUED...*

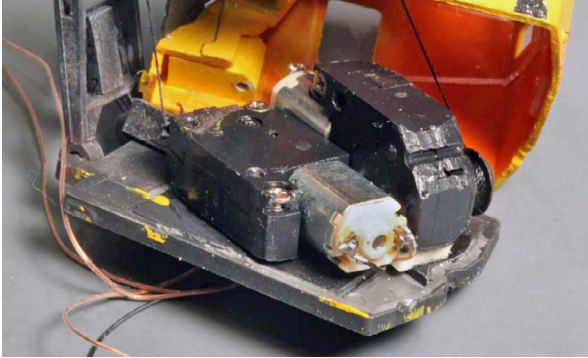

28. Cab turntable drive motor (left) and hoist motor (right).

This is a major construction simplification. It does limit the cab rotation, but still allows for an interesting animation.

I attached some very thin synthetic black or brown thread to the drum. The cable can either be glued to the hoist or tightened between the hoist parts with the

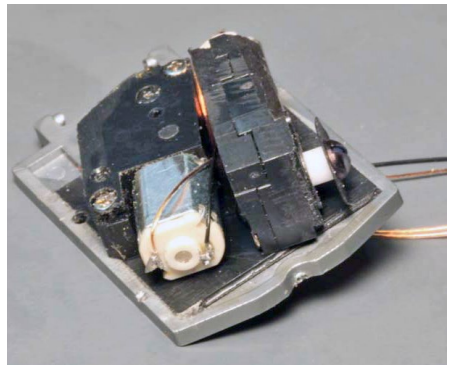
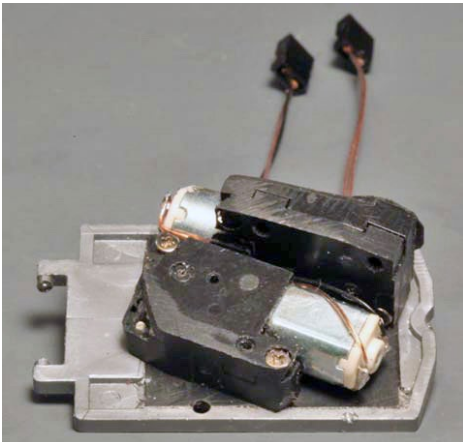

29-30. Motor wire routing. Crane cab turntable drive bushing test. I checked the hole to make sure it was centered and perpendicular to the drive.

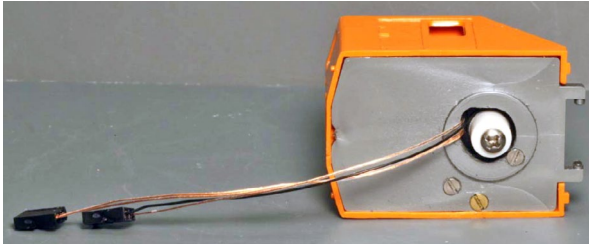

31. The motor leads from the cab pass through the body as near the center pin as possible.



32. Crane 18 with motor leads attached.

the boom, before gluing it in place. This will place enough of a tug on the cable (thread) to keep it taut during operations – an important feature.

hoist screw. Wind the thread around the hoist drum, with about double the length to run the thread out to the end of the boom. I drilled a 1/32" clearance hole in the front of the cab to route the thread as high as reasonably possible for good appearance.

Then I attached the cab from the bottom of the flatbed with the 2-56 screw previously sized. Before attaching the boom to the cab base, I hide as many small bits of lead or metal weights as possible into the joints of

STEP 3: MOUNT THE MOTOR DRIVES *CONTINUED...*



33. Weights have been added to the boom to help stabilize it.

ADVERTISEMENT

**Bachrus** inc  
RUNNING ON QUALITY

Click  
me!

## STEP 4: FINISHING THE CRANE



34. Crane 18 ready for operations. The cab rotates and the boom goes up and down.

the front of the boom, with a loop of thread for the hook cable, and then glued in place. The hook itself is the small hook (part number 17018) from an Athearn 250 ton Bucyrus crane. Each motor can be independently driven with 2-5 volts in any number of ways, including simple switches, pushbuttons, batteries, a wall power adapter, or even an old DC power pack.

I chose another simplification for this crane: not to provide a slip ring mechanism for the power to the motors. Experience with the Bucyrus 250 ton crane animation indicated that often no complete rotations were required. This saves much space and effort.

By using long thin flexible wire for the motor connections, routed as close as possible to the hub for the cab drive, the cab rotates approximately 90 degrees (or more) to the left and right of center. I run the wires vertically below the truck,

To keep this crane simple, there are only two DC motors – one for cab rotation and one for boom movement. The hook is attached to

STEP 4: FINISHING THE CRANE *CONTINUED...*

and lightly weighted the wires with a small piece of metal before they loop to connect to a controller – and it works!

The crane has markings for a fictitious company, Westside Machinery – WM – as crane number 18. Cranes sometimes get numbered for maintenance and inventory purposes. I secured a small welding hose and tanks to the front of the truck bed. The “Westside Machinery” tiger logo came from a Microscale #87-289 Structure Signs Decal Set.

ADVERTISEMENT

**GLXSCALEMODELS.COM**

GLX SCALE MODELS - OTTAWA, ONTARIO, CANADA - 613-294-2276

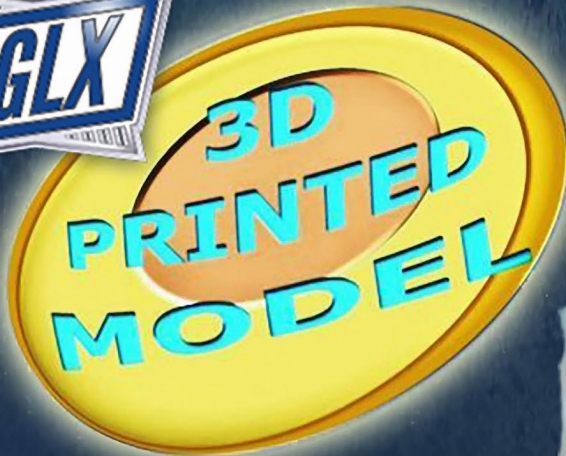

**NO  
ASSEMBLY  
OR  
PAINTING**



MOBILE LOADING RAMP



PORTABLE RAILCAR UNLOADER



RAILCAR INSPECTION TOWER

**BUY & DISPLAY NOW!!!**

MRHMAG.COM

- TABLE OF CONTENTS
- INDEX

## STEP 5: BUILDING A SIMPLE MOTOR CONTROLLER

Since I designed crane #18 as a simple animation, I built an appropriately simple controller that connects to the crane motor lead wires. The next diagram [35] shows a two-AA-battery controller with an on/off switch (S3), two presettable speed controls (R1 & R2), start-up booster capacitors to overcome friction (C1 & C2) and two small double-pole, double-throw center-off toggle switches (S1 & S2) to control each motor.

The motors run with very little power. The capacitors can be smaller, say 470uf at 6 volts. I used what I had on hand. The capacitors are used to give the motor a jolt to kick-start them.

Here are some representative components for the project:

- 2 - Bourns Inc. 3296W-1-201LF 200 Ohm Trimmer Potentiometer, [Digikey.com](https://www.digikey.com) #3296W-201LF-ND
- 2 - 910µfU 8V Capacitor Rubycon 8AX910M10X9, [Digikey.com](https://www.digikey.com) #1189-2381-ND
- 2- DPDT CENTER-OFF MOMENTARY MINI-TOGGLE, [Allelectronics.com](https://www.allelectronics.com) #MTS-93
- or 2- DPDT ON-OFF-ON MINI TOGGLE, [Allelectronics.com](https://www.allelectronics.com) #MTS-120PC
- 1- SPDT MINI-TOGGLE SWITCH, [Allelectronics.com](https://www.allelectronics.com) #TSX-4PC
- 1- BATTERY HOLDER 2 AA CELLS, [Allelectronics.com](https://www.allelectronics.com) #BH-32

## STEP 5: BUILDING A SIMPLE MOTOR CONTROLLER CONTINUED...

- 1- ABS PROJECT BOX, 3.97" X 2.12" X 1.72", [AllElectronics.com](http://AllElectronics.com) #MB-132

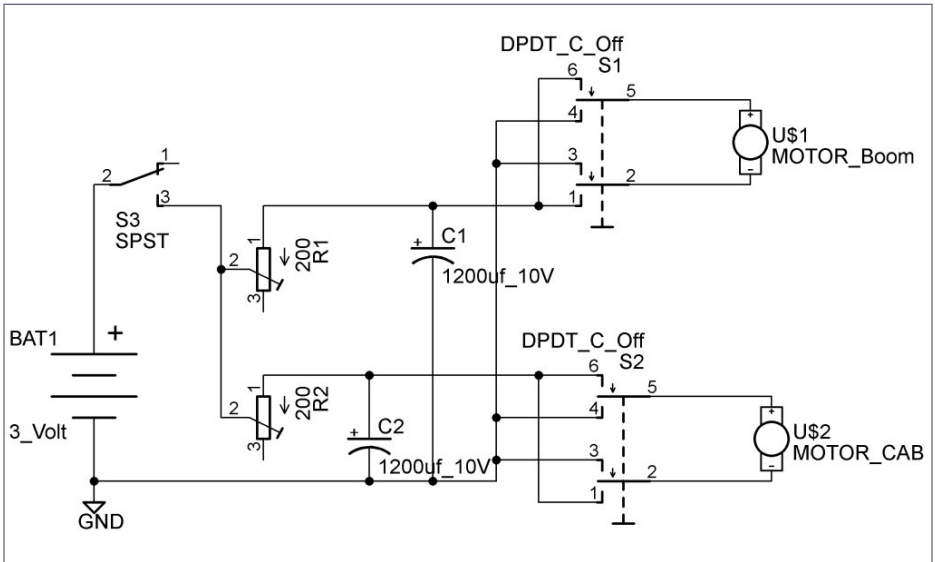

35. DC controller battery-powered schematic.

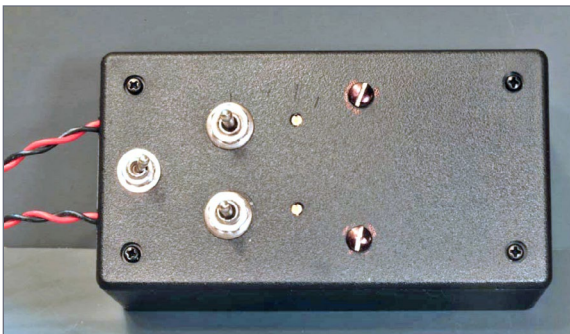

36. DC battery-powered controller.



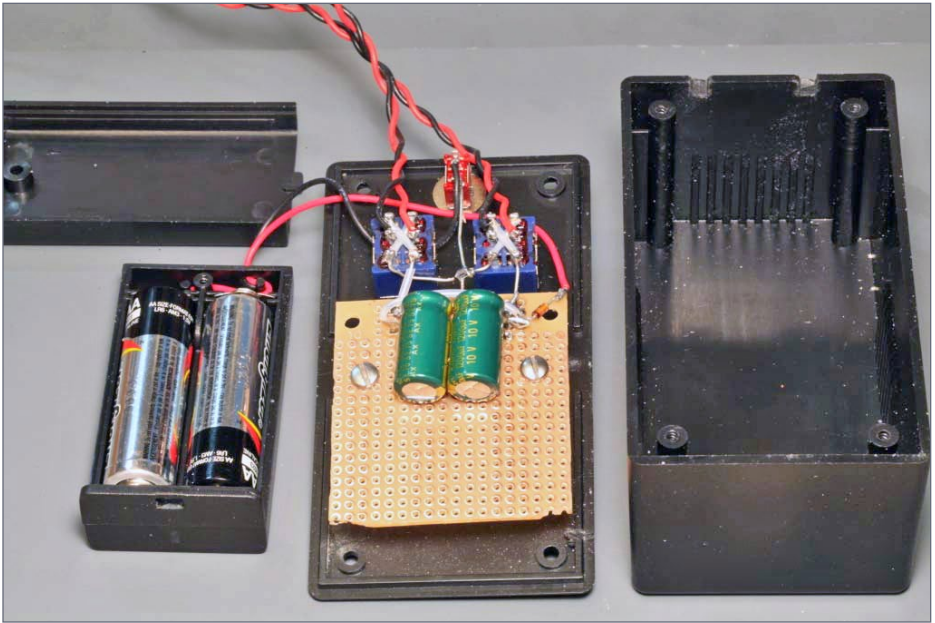

### 37. DC battery-powered controller open.

Once built, the two trimmer resistors can be adjusted to give a slow traveling speed for the cab and boom. Turn the power on with S3. Leave S1 and S2 at the center (OFF) positions ordinarily. Then switch S1 or S2 on to animate your crane in the direction you would like.

### Building a DCC-controlled truck crane (Crane #19)

The next crane, #19, has cab rotation, boom movement, and independent hook movement all controlled with DCC. I am again making a truck-mounted crane, but it requires two motors in the cab to control the hook and boom motion, representing another approach for animation.

A third motor sits between the rear truck wheels to turn the cab. So this time, I am using three different motors with a planetary gear drive. Again, I found these on eBay from several vendors for less than \$2.00 each. Search for “Small Planetary Gear Motor” or try: [ebay.com/itm/181494571304](http://ebay.com/itm/181494571304).



38. The planetary-gear drive motors for crane 19. The quarter gives you a good idea of how small these motors are.



[Click here for reader comments](#)

## STEP 1: PREPARE THE CRANE CAB

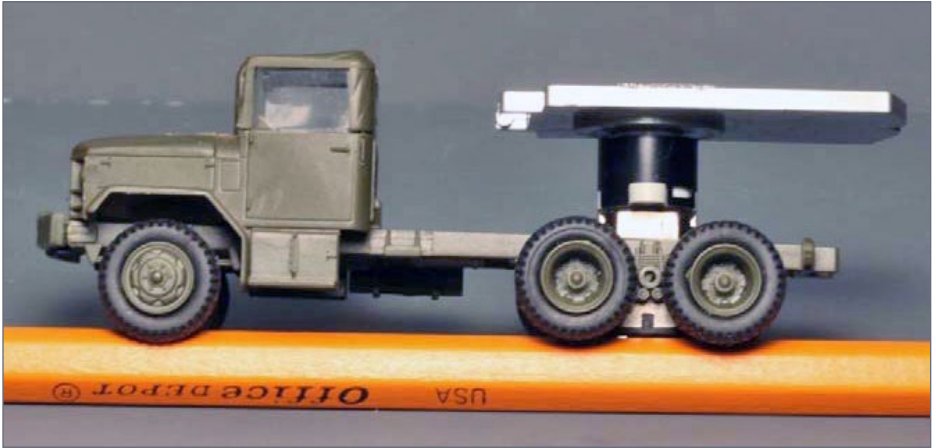

39. Crane 19 with the turntable motor mounted between the axles.

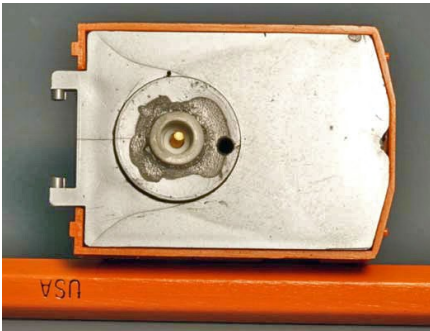

40. Crane 19 hub glued to the cab floor.

As with the previous crane, I fabricated the cab-drive hub with telescoping tubing, but drilled it with a  $5/64$ " or #48 bit to a depth of about 0.08" at one end to fit over the shaft of the motor.

I flattened the cab floor and filled around the hole with 0.040" x 0.38" styrene strips level the floor. I then drilled and fitted the  $1/4$ " hub and glued it in place. Finally, I fitted the telescoping tubing into the hole in the cab floor and over the drive hub.

## STEP 2: MOUNT THE HUB MOTOR



41. Hub cut and screwed to the motor shaft.



42. Hub spacing to cab floor.

I positioned the motor under the floor and set the hub spacing as close as possible to the floor while maintaining clearance as in [41]. I made sure to keep the tube perpendicular to the floor and glued it in place with a solvent glue for plastic.

After the glue dried, I cut the tube above the floor, even with the floor as shown in [42]. You need a 0-80 screw long enough to attach the hub to the cab-drive below. I cut the screw to fit, by measuring for length, then screwing on a 0-80 nut just below the length I needed. After shortening the screw, unscrew the nut and it will clear the screw threads.

Some motors have mounting ears on them, which can help with the cab motor mounting, but in this case they need to be cut off. I mounted two ear-less motors vertically, stacking one on top of the other. They are glued with ACC to a piece of 0.25" styrene channel with a side plate, and trimmed to fit on the cab base at a slight angle. This can be glued to the cab

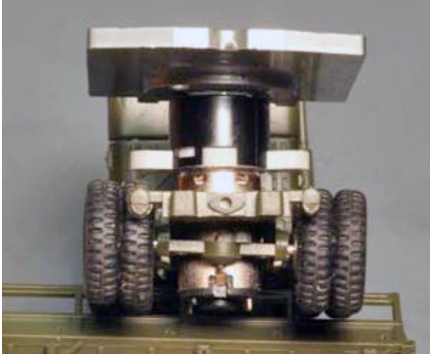

43. Turntable motor viewed from the end of the truck.

floor, after fitting each with two small disks to make up the cable drums.

The disk nearest to the motor is cut like a doughnut and glued to the drive, without gluing the whole gearbox shut! The outer disk is attached with a 0-80 screw into a shallow tapped hole in the end of the motor drive hub. I cut off the tiny protrusion after drilling the hole so it doesn't interfere with operations.

## ADVERTISEMENT

Make Loconet wiring extremely simple!



### ACCU-LITES, inc

Your DCC Center!

CELEBRATING  
**20**  
YEARS  
ANNIVERSARY

Dealer Inquiries Accepted

**PM42**  
breakout  
board



**SE8C**  
breakout  
board



**BDL168**  
Multi-zone  
breakout board



**BDL168**  
Single-zone  
breakout board

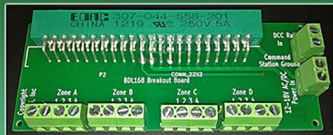

Now Offering SNAPS! in packs of 6 or 12 pieces! [CLICK TO LEARN MORE ...](#)

## STEP 3: IN-CAB MOTORS, LIGHTS, AND DECODER

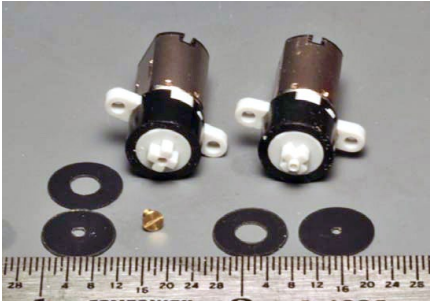

### 44. Hoist parts.

I equipped this crane with work lights front and rear. The LEDs could be wired in parallel, or they could use another decoder with more functions to control them independently. To control all this requires at least 6 wires into the cab. I elected not to do this.

Instead, I used a DCC decoder (a Digitrax DZ123 or DZ126) with a tiny 12-volt single-pole single-throw relay to select which motor the decoder drives. This relay can be obtained from Allelectronics.com (RLY-616). Thus, I only needed two wires to run up into the cab!

This decoder is tiny, cheap, and has function controls. DCC Function 2 (F2) switches between the hook and the boom

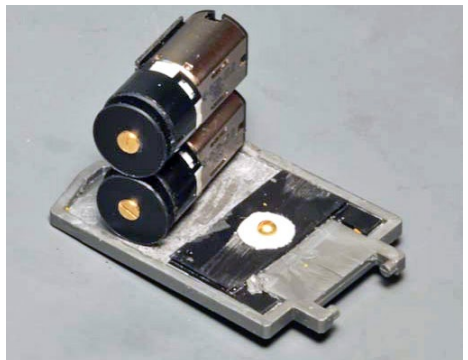
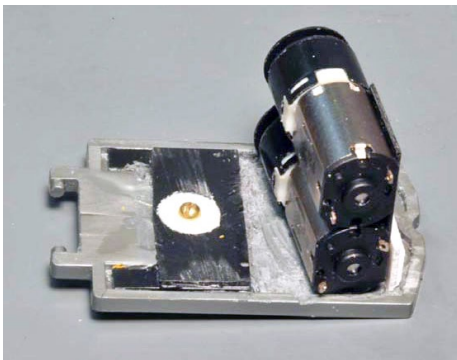

### 45-46. Stacked hoist drives on the cab floor.

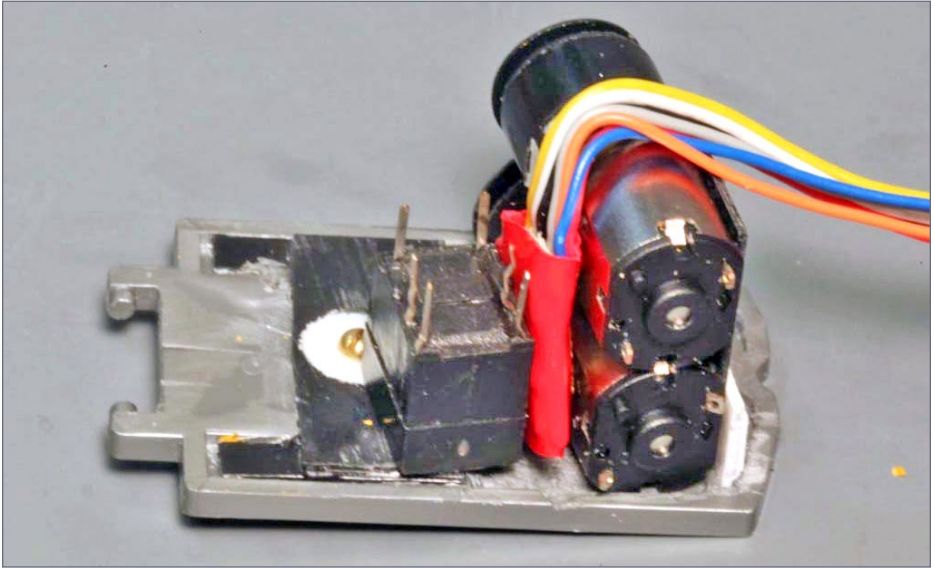

47. An SPDT relay and DZ126 decoder are installed on the cab floor next to the stacked drum drives.

drive. You can remap the yellow function wire to F1, F2, or F3 as you like.

A second DZ123 controls the cab rotation using a second separately addressed decoder. Juggling the two addresses is not a problem for me, since I intend to have these controlled by a program and not via a hand throttle.

However, throttles like the Digitrax DT402 do allow independent control of two decoders simultaneously. Position the stacked drum motors, the decoder, and the relay as pictured [48]. They really can fit inside the little cab quite well!

**STEP 3: IN-CAB MOTORS, LIGHTS, AND DECODER**  
*CONTINUED...*

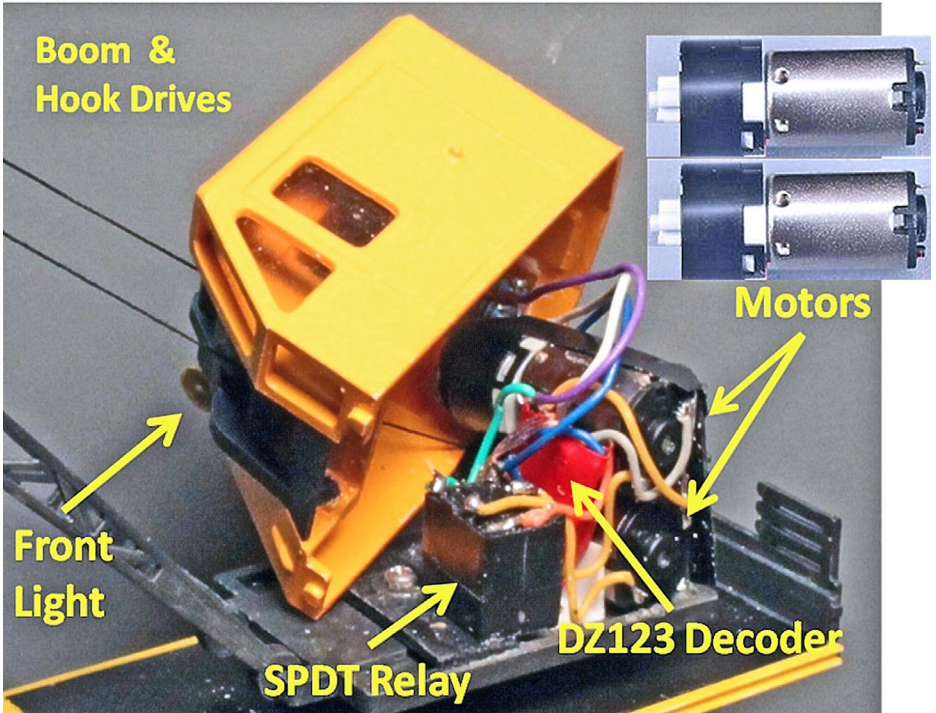

48. Stacked boom and hook hoist motors with the DZ123 decoder and drive relay.



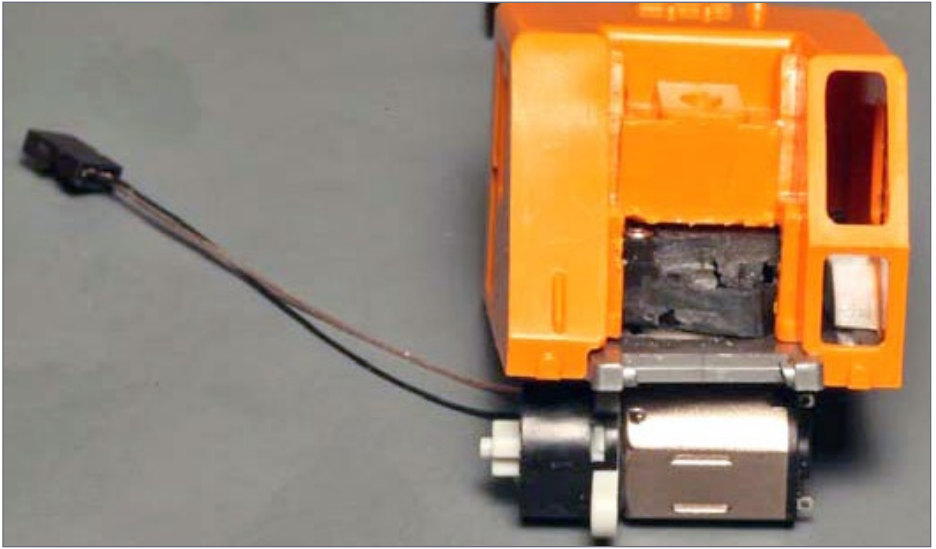

49. Wire lead extended for the DCC decoder.

Want to help  
keep MRH free?  
Then click on  
Ads!

## STEP 4: FINISH THE CRANE



### 50. Cab rotation drive that fits between the wheels.

Once the relay, motors, and decoder were wired, I painted and decorated the cab. I added glass and lights at this time. Once the cab was ready I screwed the cab motor drive to the cab hub bottom.

Next I prepared the truck chassis the same way as with the previous truck-mounted crane, except I located and drilled a hole to accept the top of the motor drive for the cab. The hole should be centered between the rear truck wheels. I inserted the motor through the truck bed hole, and screwed the cab onto the motor

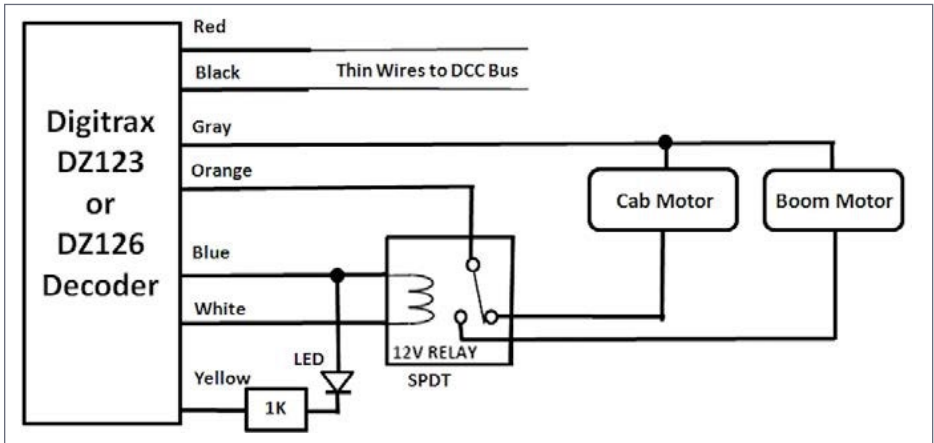

## 51. Cab decoder wiring diagram.

The red and black leads from the decoder should be attached or replaced by the same very fine flexible wire used before, and routed down alongside the drive hub. If the crane will operate toward the rear of the truck, place the holes for the wire toward the front of the truck. I made the holes large enough to allow maximum movement and minimize visibility. A keen observer will note that the hook on this crane has added weights on its sides. This is to add tension on the hook's cable/thread to enable smooth movement, since independent operation of the hook is possible.

I attached a second decoder to control the cab rotation. I programmed the decoders to have two sequential addresses and test the DCC control of the motors and lights. You should dramatically limit the upper speed/voltage settings of both motors as you like. Remember these are actually 6 volt motors.

## STEP 4: FINISH THE CRANE *CONTINUED...*



52. Finished truck crane 19.



[Click here for  
reader comments](#)



53. Finished cranes #18 (left) and #19 (right), along with the original unmodified source Wiking crane in the middle.

**When talking to hobby vendors, please remember to mention MRH.**

DR. GEOFF BUNZA



Geoff Bunza started as a Model Railroader when he received a Mantua train set for Christmas, at age 6. Interest in the New York Central was cemented when riding on a NYC fan trip to Harmon on November, 1966 behind S-Motor 110. He fed his interests through college becoming a member of the Tech Model Railroad Club (TMRC) at MIT while getting his doctorate and three other degrees in Electrical Engineering.

He models the New York Central Railroad, the Great Northern Railway, and Maine narrow gauge in HOn30. Scale model animation in HO is one of his great interests.

Geoff has authored numerous articles on animation for *Model Railroad Hobbyist*, the *New York Central System Historical Society Modeler Magazine*, and *Railroad Model Craftsman*. He has presented clinics for the NMRA at Division, Regional and National meets, and the National Narrow Gauge Conventions.

He is blessed with his wife, Lin, in marriage for 36 years and their two terrific sons. He is a life member of the NMRA and holds an Extra Class amateur radio license. ■

# iwata

by ANEST IWATA

*Just Rolling By...*

Make It **REAL** With Iwata

*Climb Aboard!*



**Eclipse  
HP - CS**

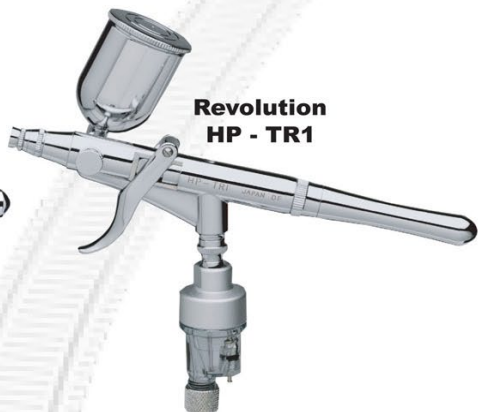

**Revolution  
HP - TR1**

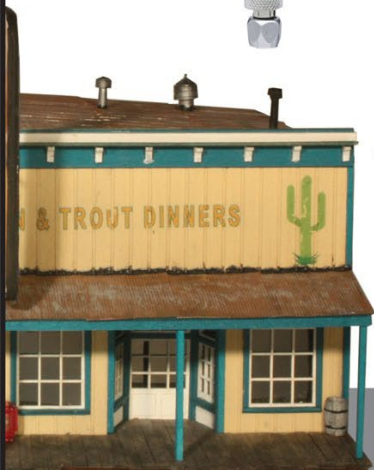

**Visit...**  
[www.iwata-medea.com](http://www.iwata-medea.com)

**To Check Out Our  
Full Product Line!**

*Models By... Alan Houtz,  
North American Prototype Modelers*



# GATX Version 33.9K TANK CAR

*Kitbashing this N scale tank car ...*

BY RICK UHLENKOTT  
.....







[Click here for  
reader comments](#)

**I WAS ELATED WHEN ATHEARN ANNOUNCED THE** release of the 33.9 K-gallon LPG/anhydrous ammonia tank car in N scale. Finally, for us in N scale, we have the straight-tube type car of this capacity that has been around since the early 1960s. To date the manufacturers have only offered the whale-belly design.

The Athearn offering is of a UTLX design from the 1990s, which has minor differences from the 1960s design car. The most prominent difference is that the end ladders are slightly off-center on the '90s car, whereas they are centered on the '60s car, with a corresponding change in the hand railings. Back-dating to the pre-'90s design is a simple matter of centering the ladders and adjusting the hand rails. If you begin with a decorated car, the stock paint scheme will need to be modified to reflect that of an earlier era.

I also wanted some of the similar GATX-manufactured cars. The major difference between the two manufacturers is the GATX cars have a side-mounted catwalk and end ladders, and full-width end platform handrails. I made no effort to determine or model any difference in tank length or circumference. Any difference would be so small it would be of little consequence in N scale. I used the undecorated model, which I was surprised to see comes as a partial kit. The main body is assembled, but some parts must be added by the modeler.

# GATX TANK CAR | 4

I installed the factory-supplied parts as shown in the exploded diagram except for the end handrails and center catwalk. The stock handrails are made to flank the off-center end ladder of the '90s UTLX car. Since the GATX car has the catwalk and ladders are located to one side, the end railings need to be one piece spanning the car width. I bent the new ones from Engineering .012" stainless steel wire.

I also modified the bolsters to accept Micro-Trains 1035 roller bearing trucks with Talgo-mount couplers. This is one of my standards. I use MT trucks and wheelsets on all cars running on the layout.

I reamed the holes of Kadee #209 gray fiber washers using a Dremel cone-shaped high-speed cutter in a pin vise until they slid over the bolster pegs, then glued with ACC. This allows



1. I installed the user-applied parts as shown in the exploded diagram included with the car, except for the end handrails and center catwalk.

## GATX TANK CAR | 5

just enough clearance under the end platform for the coupler box to swing freely. The hole in the MT truck was a bit larger than the bolster peg, I used a homemade putty made from styrene scraps melted in liquid cement. I coated the outside of the bolster to adjust it to fit the hole.

After applying the layer of putty I slipped the truck on and centered it to help make sure the bolster would end up just right. Being a dissimilar plastic, the truck did not weld to the styrene, and was easily loosened to turn freely once the homemade putty had set. Finally, there is a tab sticking out from the bolster to the end of the tank. This must be removed for the coupler pocket to clear.

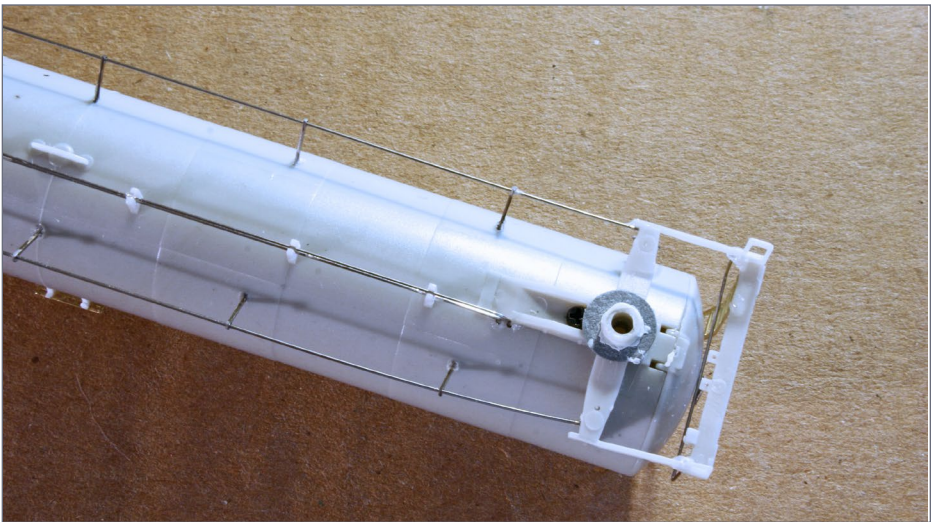

2. I add a Kadee fiber washer to my standard Micro Trains car. I attach it to the bolster pegs. You can also see my putty mix applied to the bolster pin to bring it up to the same diameter as the Micro-Trains trucks.

I filled all the holes for mounting the center catwalk and the original hand railings with Squadron brand putty. Once those were set and sanded smooth, I marked a line along the side of the tank where the GATX catwalk was to be mounted.

After some deliberation on placement, I determined that the catwalk would look closest to the prototype at the level where the mounting holes for the original dome platforms were. This made it convenient for accurately placing a level line.

After determining where the ends of the new catwalk would be, I made a pattern on a piece of scrap paper. This way I could locate and mark where the holes needed to be drilled for the mounting pegs designed into the Gold Medal Models catwalk. Be sure the walk will end up on the correct side of the tank; looking at the catwalk side of the car, the B end (with the brake wheel) should be to the left.

In [3] you can see I did the same for the short platform on the opposite side, except the marked line only runs between the two original holes at the center of the tank. Normally I used a pencil for the markings on all the cars, but I used a black marker for clarity in the photos.

### Modify the GMM catwalk

[4] shows the cuts for the version with the hand railing on the inside of the walk, and the short platform on the opposite side of the car. The center portion that wraps around the jumbo car dome is removed from each side of the walk, yielding two walkway sections. The short platform is trimmed from one of the center portion pieces and the mounting pegs and railing are removed from what will be the outside edge of the catwalk. The

# GATX TANK CAR | 7

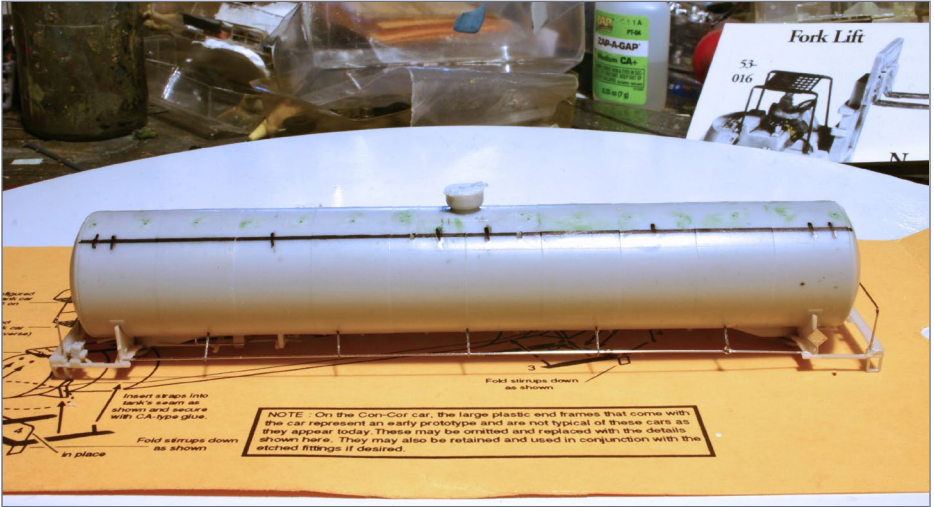

3. I marked the location of the walkway on the side of the tank body. For clarity in the photo, I used a marker instead of a pencil.

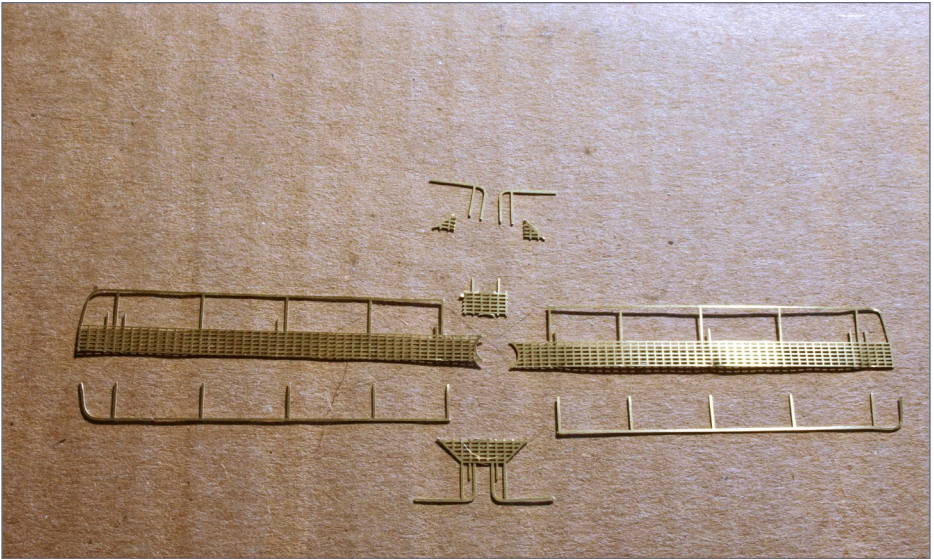

4. Here you can see the cuts I made on the Gold Medal etched catwalk. This set is for the inside handrail of the GATX car.

## GATX TANK CAR | 8

remainder of the center portion walkway will not be used, but the separated railings are saved and will be used later.

[5] is cut for the version with the rail on the outside of the walk and a longer platform on the opposite side of the car. On this one the railing is removed from what will be the inside edge and the mounting pins retained, while the outside railing is retained and the mounting pins on that side removed

Neither side of the center portion is used here. Instead, the long platform on the other side of the car is cut from the side of one of the end platforms designed for replacing the thick plastic end platforms on the jumbo cars. Again, the removed hand railings will be used later.

I drilled new mounting holes, and test-fit the walkway before going any further. I temporarily inserted one walk section and

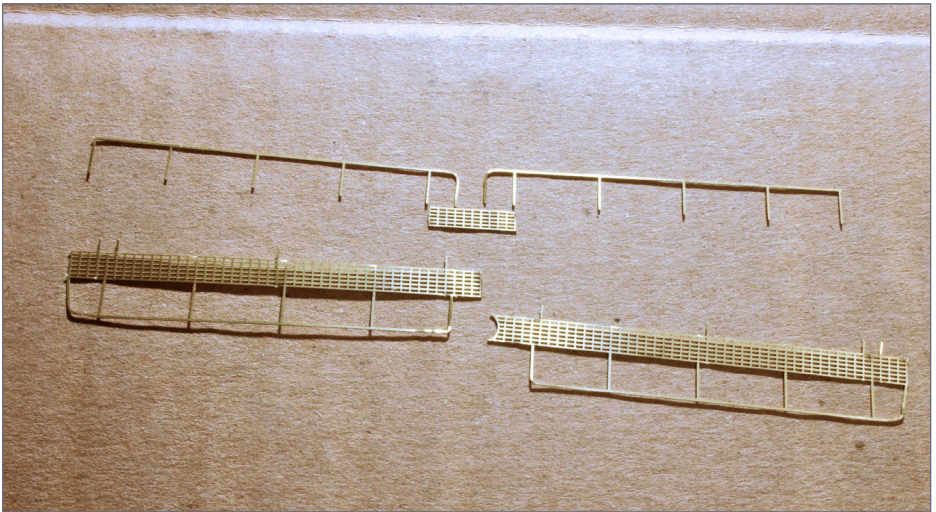

5. This picture shows the cuts made for the outside-railing on the UTLX car.

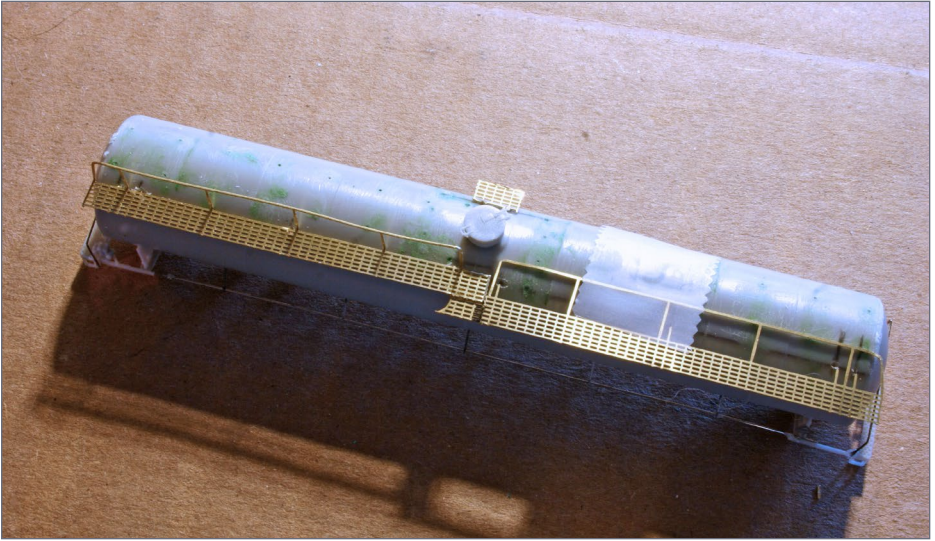

6. One walk section is temporarily inserted and the other is taped at its position to determine where to trim them for the splice.

taped the other at its position to determine where I should trim them for the splice. At the selected point, I left each cross line so that they overlapped. I filed each of the trimmed ends at the splice point at a shallow angle so they overlapped. When glued down, these angles made a fairly seamless splice.

Next I turned to the hand railings removed earlier from the original configuration.

In [7] the upper railing is unmodified and the lower is bent for the inside-railing car. I compared the railing to the dome area to make sure the bends would be in the correct places to fit. The second one was made a mirror image of this one. Once the railings were trimmed, I mounted them around the dome.



# GATX TANK CAR | 10

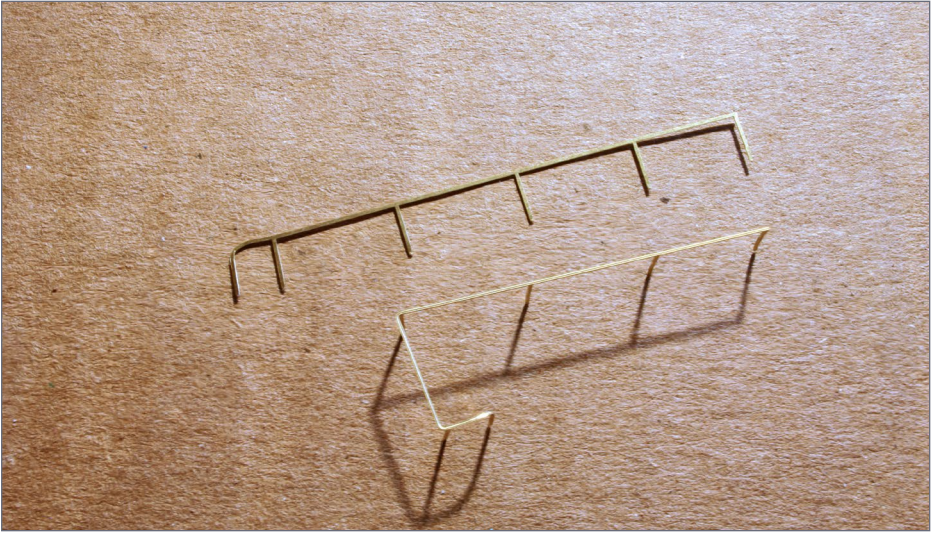

7. The dome railings are bent and trimmed for the inside railing.

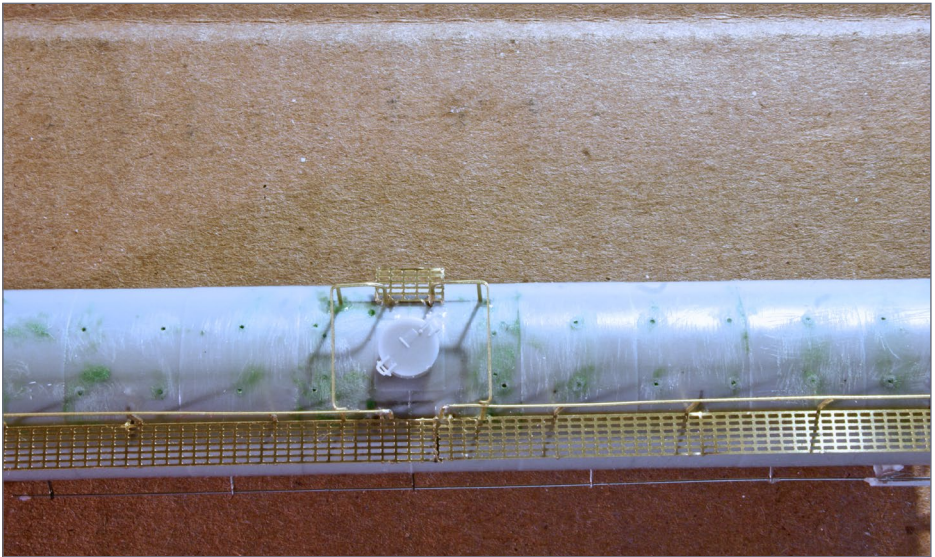

8. The dome hand railings mounted to the top of the car.

# GATX TANK CAR | 11

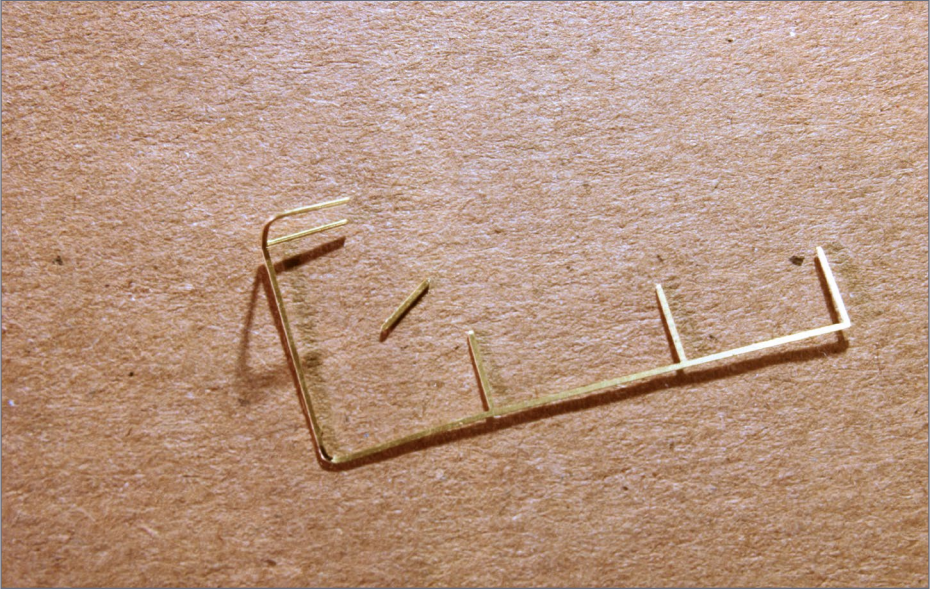

9. One of the bent handrails for the outside-railing configuration.

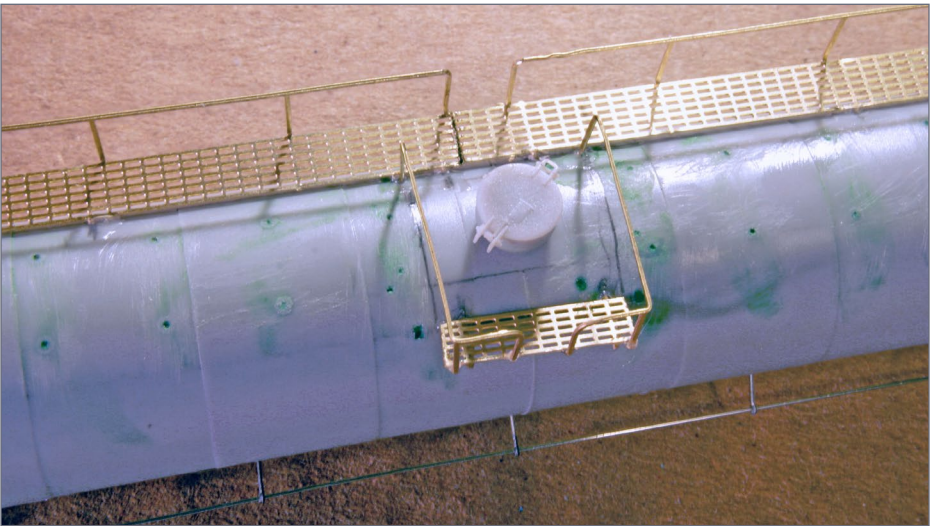

10. In this photo you can see the dome railings mounted for the outside-railing configuration.

## GATX TANK CAR | 12

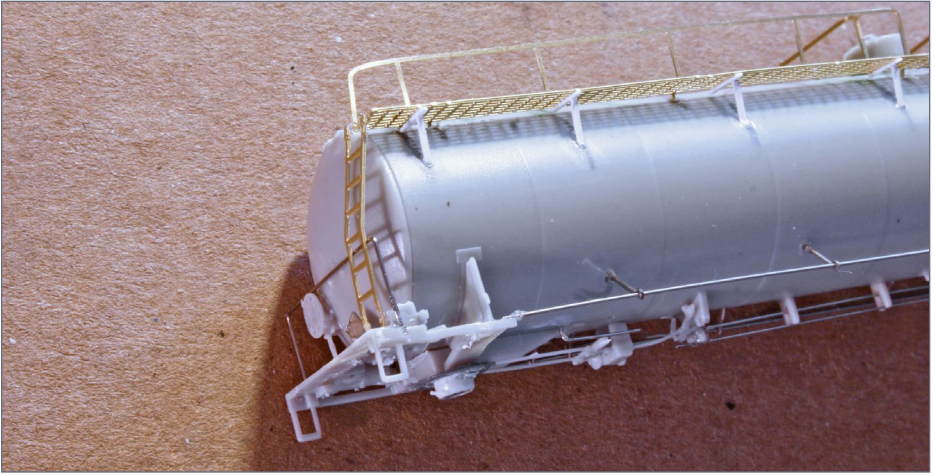

11. Bracing to support the catwalk is made from .010" x .020" styrene. The braces are then cemented into place. In this photo you can also see the end handrail I made from 0.012" stainless steel wire.

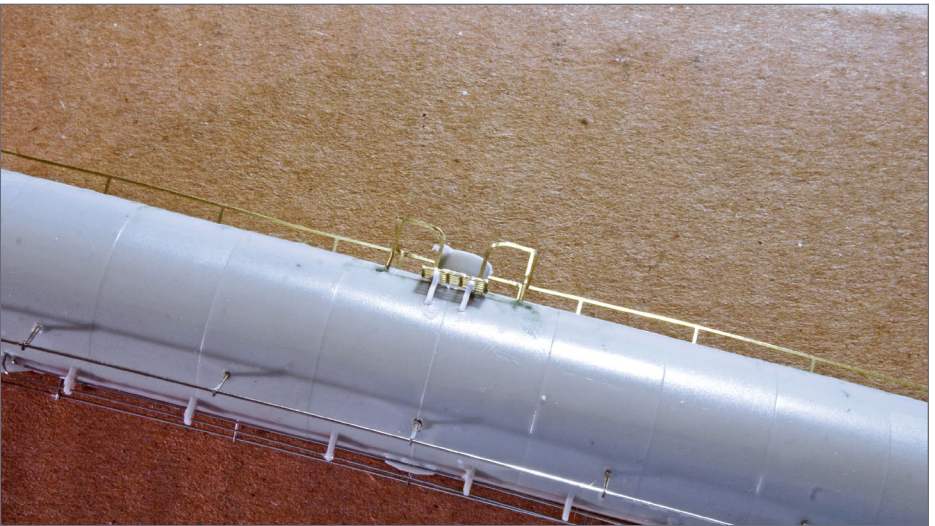

12. The dome catwalk on the opposite side of the catwalk has two braces added.

## GATX TANK CAR | 13

The dome railings are slightly different for the outside hand railings. I followed the same procedure as before. Again I compared it against the dome area for fit, and then bent the other railing as a mirror image. I trimmed what became the end stanchion next to the catwalk a bit long, and glued it into a hole drilled into the tank body for strength.

I built up the catwalk supports from .01" x .02" styrene strip, and the end ladders from the GMM fret. The new end platform handrail can also be seen. [11] shows the supports under the short platform. The supports on the long version of this platform are set-in the same distance from each end.

The inside-railing car has a different stanchion pattern. I removed the second stanchion from the end, and left the third

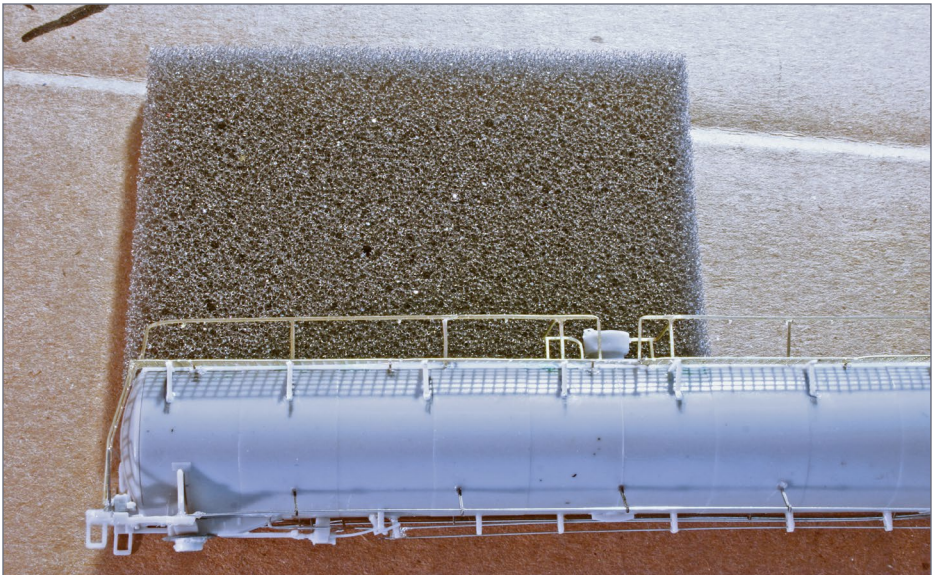

13. The fidelity of the etched catwalk is seen in the shadows cast on the side of the car.

## GATX TANK CAR | 14

one in place. The fourth and fifth stanchions were removed, and a new one placed to divide that span in half. I cut the new one from the open end of the handrail left over from making the dome railings so it can be cut long enough to insert into a hole drilled in the tank. Once in position, it was secured with ACC. I repeated the process for the handrail on the other side of the dome.

The finished cars were sent to the paint shop and then lettered with elements from various Micro Scale tank car sheets, following photos of the cars I chose from the myriad of images my Internet search turned up.

*See the pictures on the following pages ...*

# HobbyOn

*Come & See Us  
CLICK Here*



[www.hobby-on.com](http://www.hobby-on.com)

**Name Brand  
Hobby  
Products  
at Discount  
Prices!**

# GATX TANK CAR | 15



14. Finished model.

# GATX TANK CAR | 16





15. Click and drag the mouse to spin the model real-time.





On mobile devices, select mobile version and use arrows to spin.

[MRHMAG.COM](http://MRHMAG.COM)

- [TABLE OF CONTENTS](#)
- [INDEX](#)

---

## BILL OF MATERIALS

Athearn UTC 33.9K LPG Tank Car, Undecorated

Gold Medal Models 160-51 Freight Car Detailing Set for Atlas or Con Cor Jumbo Tank Car

Engineering N2112 .012" stainless steel wire ■

---

---

## RICK UHLENKOTT



Rick has been involved in the hobby since just before first grade when a regular feature of the first season of Captain Kangaroo got him hooked. A family move to a smaller house led him to switch to N scale for space reasons.

He has been involved over the years in a few clubs, and currently with N-Trak, a round-robin group and the NMRA. With NMRA he tackled the Achievement program, served as his Division's treasurer for 10 years, and served on three PNR Regional convention committees. He is currently the Division's newsletter editor. ■



[Click here for reader comments](#)

# Bowser

## EXECUTIVE LINE

### HO Cal Scale & Cary

Lost Wax Brass,  
Plastic Molded Detail  
Parts & Wire Form  
Parts



Air Horns



Air Hoses

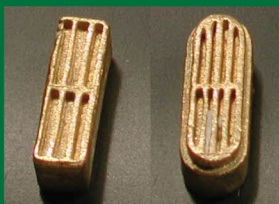

Exhaust Stacks

### HO Power & Trailing Trucks Kits



26"-33" Wheels available

### Foam Work Cradle



Protect your locomotives  
and cars upside down or  
right side up. You can work  
on them and not damage  
the paint or details.

HO, N & O scale  
available

### U25b Locomotives

Ready to Run & Fully Detailed  
Available with or without Sound



### HO Retro Fit Sound Kits

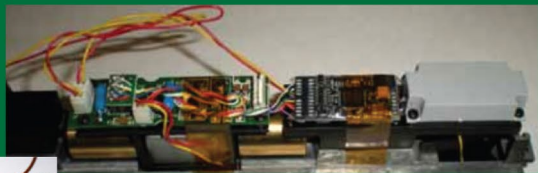

HO DCC & Sound Kits for Bowser, Old  
Stewart & Athearn RTR Locomotives

Click here to check out the details for these and other  
great Bowser products!

# BUILD A DCC TEST TRACK

BY JERRY BENGTON

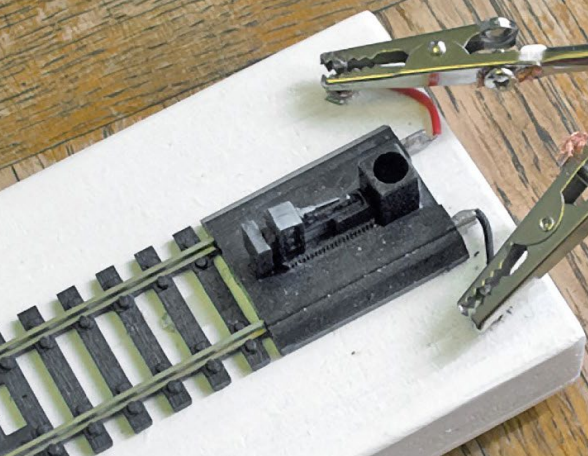

1. Jerry built himself a DCC test track he can use at his workbench – follow along in this article to see how he did it.



[Click here for reader comments](#)

## TEST YOUR DCC LOCOS AT YOUR WORKBENCH

### I WANTED A NICE DCC TEST TRACK THAT I

could use at my workbench, so I built the one described in this article. I use a PowerCab system for the DCC signal.

If you don't have a PowerCab system, then you will need some other way to generate a DCC signal at your workbench like using a SPROG (see: [sprog-dcc.co.uk](http://sprog-dcc.co.uk)). Once you have some way to create a DCC signal from your workbench, then you can adapt what I've done here to create your own DCC test track.

I started with some ½" MDF board cut to 3" x 48". Then I sanded the board and painted it white. I thought to also use this track to check car weight, so I added lines with NMRA weight standards on it for rolling stock – but this doesn't have anything to do with the DCC function, so you may elect to leave this off.

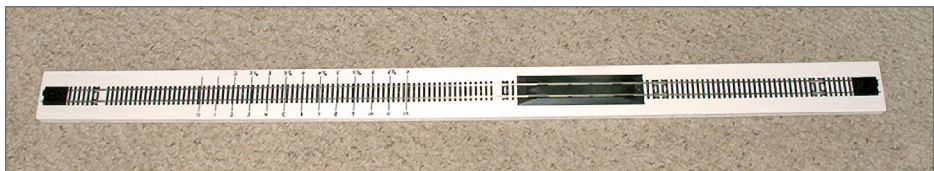

## 2. I used Atlas code 100 track, a rerailer, and some Atlas bumpers make up the trackwork on my test track.

I used Atlas code 100 track sections for the trackwork: (2) Atlas Snap Track Bumpers, one (1) 9" Atlas Snap Track 9" section, one (1) Atlas Rerailer and a 23" piece of Atlas code 100 flex track.

I added some self-stick felt padding strips to the underside of my test track to dress it up a bit and make it sit nicely on my workbench surface.

I drilled some holes near one end next to the Atlas track bumper and glued in two nails. Then I soldered 22 gauge solid wire to the end of the bumper and wrapped the wire around the



## 3. On the underside of my test track, I applied some self-stick felt pads.

nails and soldered the wire to the nails. The nails form terminal posts that will be used to attach the track feeder leads from the Powercab.

Next, I got a plastic electrical project box and mounted the NCE Powercab throttle socket board and the NCE USB interface

## BUILD A DCC TEST TRACK | 3

board in the box. I drilled two holes – one to feed in the coiled cable from the throttle socket board to the USB interface board, and the other to allow feeding the power cable in and plugging it into the throttle socket board.

I also added two track feeder wires to an orange connector socket that I installed in the box. You can find similar

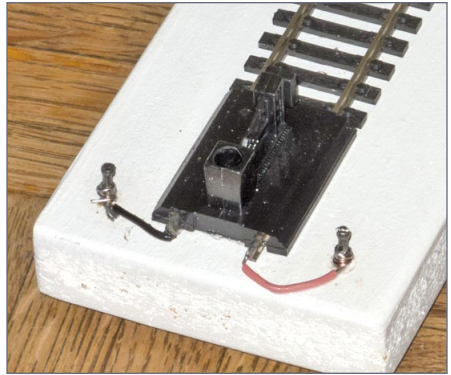

4. I drilled some holes and installed a couple of nails, then soldered wire to them to allow easily attaching feeder leads to the track.

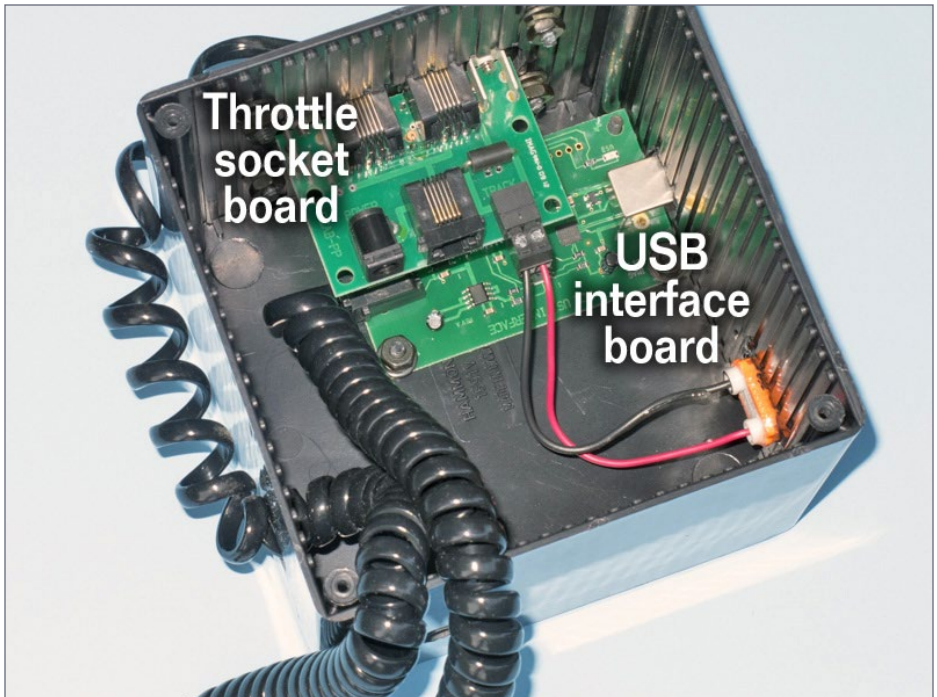

5. I mounted the NCE throttle socket board and USB interface board into a plastic electrical project box to keep things all neat and tidy.

# TONY'S TRAIN XCHANGE

Committed to your DCC support!



Erik Claus  
and his trusty  
Tony's Reindeer

## ESU LokSound Select Decoders

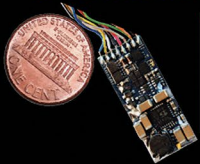

Use these two products together for awesome sound and incredible motor control in even the smallest HO and many N Scale Locomotives.

Accurate, Prototypical Sound & Superior Motor Control.  
Select 6AUX, Select Direct, Select Micro & Select 21 pin  
Starting at \$81.99

Order Yours

## TDS SuperSonic Mini Speakers



Incredibly Big, High Quality Sound, From Incredibly Small, High Quality Speakers.  
Don't Forget Enclosures!  
\$5.95

Order Yours

See and Hear These Decoders and Speakers in Action on Our Website:  
[tonystrains.com/tonys-tv](http://tonystrains.com/tonys-tv)



Fantastic Sound & Motor Control in a Bachmann HO 44 Tonner!

View Videos

Do you need a Sound or DCC Installation done?

Get a quote!



Providing unmatched person to person DCC support for more than 20 years, the kind of service that has made us #1 in DCC.

**DCC questions? CALL US! 1-800-978-3472**

\*Mention this ad for \$5.00 off your next order over \$100!

*We'll get you on the right track!*

Dec 2015



## BUILD A DCC TEST TRACK | 4



### 6. Mount the hardware in the electrical project box.

connectors at an auto supply for connecting up trailer wiring. [We recommend purchasing a commonly-available stereo banana plug socket and get two inexpensive alligator clip test leads with a banana plug on the other end. We list links to such parts online in the parts list at the end of this article. - *Ed.*]

Finally, I cut a square hole in the box for the USB lead on the USB



7. I passed the power cable from the "wall wart" for the throttle socket board through a hole I drilled in the case and plugged it in.





## LokSound L -Premium Quality Low Cost DCC and Sound in O Scale!

Coming Soon in "Atlas O"

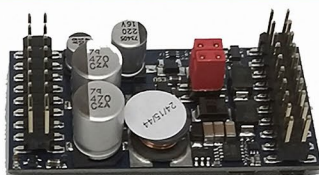

Each Decoder set  
comes with Decoder  
and Adaptor board



## FULL FEATURED "LOKSOUND L SELECT"

ESU Item# 73399 **\*\*ONLY \$149.99\*\***  
Shipping Now!

- Dimensions: 1 Inch x 2 inch
- Amperage: 3Amps continuous (up to 4Amps for a short time)  
Overload Protected
- Function Outputs: 11(!)
- Servo Outputs: 2
- And More Features!

- 
- Perfect for ESU Synchronized Smoke Units 54678 and 54679 with supported Sound Files
    - Smoke units will work with Steam and Diesel files
    - Smoke units can be set up to work with Smoke Chuff and Cylinder Steam!

**Click here for  
MORE FEATURES ...**

Also Available: 54399 Fully Programmable LokSound L V4.0 199.99

ESU LLC 23 Howard Street Montoursville PA 17754 - 1-570-980-1980

**[www.LokSound.com](http://www.LokSound.com)**

**MRHMAG.COM**

- [TABLE OF CONTENTS](#)
- [INDEX](#)

# BUILD A DCC TEST TRACK | 5

interface. This allows connecting the Powercab to a computer with DecoderPro installed.

To see how everything connects, see the wiring diagram [8] and the photo [9].

That's about it. With this DCC test track, I can program and test locos at my workbench. Thanks to the USB computer interface, I can connect to my laptop and use DecoderPro at my workbench as well.

# DCC WIP

## NCE PowerCab handheld controller

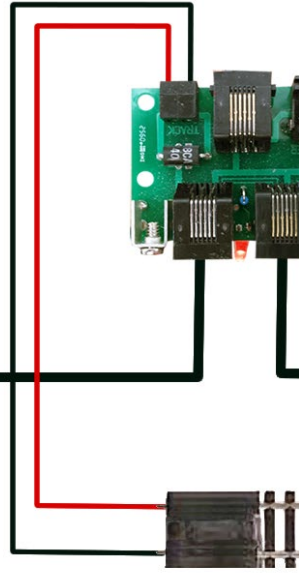

Track feeders

## ADVERTISEMENT



Installing DCC sound just **NOT** your thing?

Trust Traintek for sales and installation of sound decoders from these fine vendors!



"Taking model railroad control to the next level ..."



[traintekllc.com](http://traintekllc.com)



"Traintek was the way to go!"



[MRHMAG.COM](http://MRHMAG.COM)

- TABLE OF CONTENTS
- INDEX

# DCC TEST TRACK WIRING DIAGRAM

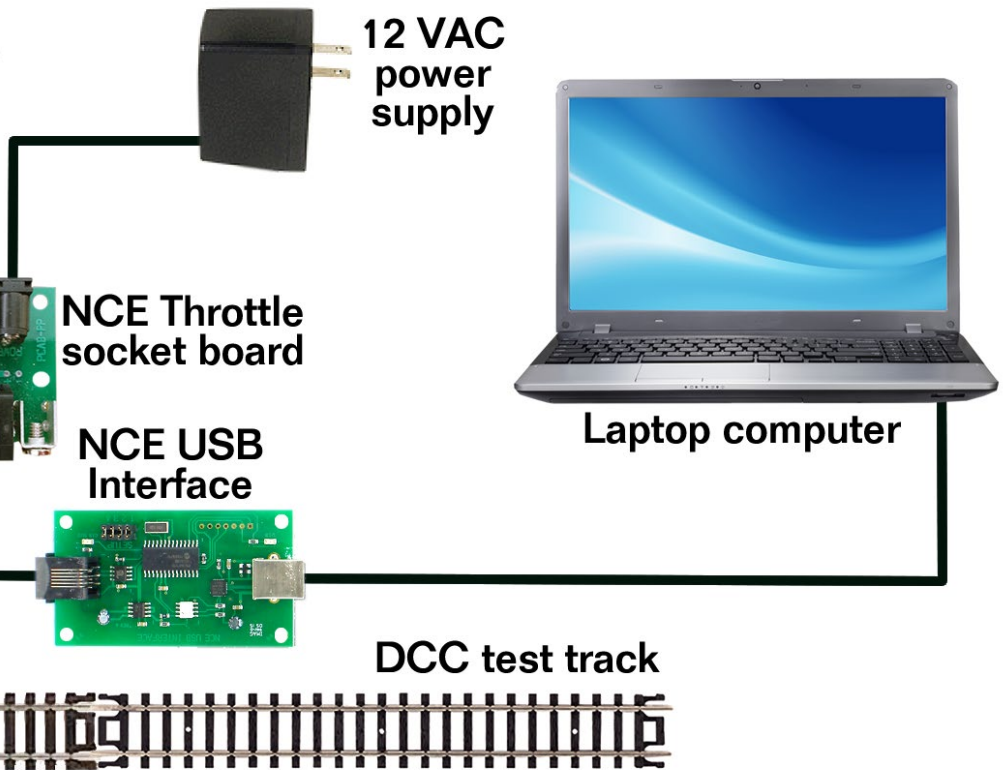

8. Wiring diagram showing how everything connects together.

*See more pictures and a parts list on the following pages ...*

# BUILD A DCC TEST TRACK | 7



9. This is how everything connects up to the box.

ADVERTISEMENT

**LC101 & LC201**  
**(8 pin plug) DCC decoder**



*High Performance*  
*High Compatibility*  
*Attractive Price*



- DCC standard decoder suitable size for HO scale locomotives
- Motor current 1.5 Amp continuous and 2 Amp peak
- 6x 100mA function outputs (For LC201 version)
- Back-EMF with silent motor control
- 28 step adjustable speed table
- Support long address



10. The track feeders with the alligator clips plug into the box here. The alligator clips on the other end connect to the test track as shown in [1].

.....

## PARTS LIST

(PowerCab system with USB interface or SPROG assumed)

½” MDF board cut to 3” x 48”

Atlas code 100 track:

- (2) Snap track bumpers
- (1) 9” Snap track 9” section
- (1) Rerailer
- 23” Piece of flex track

Self-stick felt pads:

Amazon link: [amzn.com/B002BLGKXM](https://www.amazon.com/B002BLGKXM)

Plastic project box:

Amazon link: [amzn.com/B0002BSRIO](https://www.amazon.com/B0002BSRIO)

7.5” x 4.3” x 2.2”

(191mm x 110mm x 57mm)

(2) Female banana plug sockets

Amazon link: [amzn.com/B00H3CRSLC](https://www.amazon.com/B00H3CRSLC)

(2) Alligator clip test leads with banana plug ends

Amazon link: [amzn.com/B00LUUJUKK](https://www.amazon.com/B00LUUJUKK)

22 gauge solid wire ■

.....



**Click here for  
reader comments**

SOUTHERN PACIFIC'S

# Passenger cars:

## More than just the Daylight, Part 8



BY **V. S. ROSEMAN** *Photos by V. S. Roseman  
unless otherwise noted*

### PART 8: MORE LIGHTWEIGHT CARS YOU CAN MODEL

**HERE IN PART 8, WE FINISH OFF LOOKING AT LIGHTWEIGHT** cars you can build by kitbashing or near-scratchbuilding. This final part concludes the series, so let's get started!

#### Rebuilt lightweight cars

Over the years, the corrosive cleaning agents used on the prewar lightweight Daylight cars damaged their Cor-Ten steel carbody frame components.

By the early 1950s the railroad began a massive rebuilding program, replacing badly corroded parts with new ones. Nearly all of the cars received new flat polished stainless steel skins.



[Click here for  
reader comments](#)

1. Rivarossi model of duplex 12 single bedroom/5 roomette car as it ran on the Starlight and San Francisco Overland Limited.



For some reason, a few cars were rebuilt with their old fluted stainless sides with all paint removed.

The new 1955 color scheme had letterboards painted red in the manner of the Sunset Limited with pale gray lettering. None of these were outlined in black as previously on some equipment.

Cars with conventional steel sides were painted imitation stainless color, a dark metallic silver. Car numbers were in black, and instead of the elaborate train emblem, cars received a plain orange ball and wing design.

The entire SP intercity fleet began to be changed over to the new colors, and to simulate anything after 1955 increasing numbers of these cars are needed.

There are no accurate plastic models of these cars available painted for Southern Pacific. MTH Electric Trains offers five-car sets of flat side Daylight cars including tavern, baggage-chair



2. Former Daylight parlor car as rebuilt to chair car 2243 with flat stainless sides, vestibule end.



3. Rebuilt parlor car 2243, blind end.

car, chair car, parlor car and parlor observation car. A two-car flat side add-on set is also offered, with two parlor cars.

The sets come painted and lettered for Northern Pacific and for Erie. Some sets, such as the Santa Fe lettered sets have corrugated sides, so shop carefully.

There is no dining car in these sets, but the fluted Daylight articulated chair cars and triple-unit service cars in scarlet and orange colors ran until 1963. After 1957, during



## PART 8 – SP PASSENGER CARS | 4

non-peak periods a yellow painted class 83-D-1 dining car was used on the Coast Daylight. Union Station Products has sides for this car, to be used with a car core kit in their range of products.

In mid-1955 the class 79-T-1 tavern cars were retired in favor of the newer Timberline Taverns off the Shasta Daylight, and in 1962 by dome cars. The tavern model in the five-car set could stand in for the Timberline Tavern or could be converted to resemble an Automat car [4].

The two car and the five car sets come with full skirting, and the center skirt should be removed. See the detailing section later in this article for suggestions on this operation. These cars come with Steam Ejector air conditioning systems which could be cut off and replaced with the correct Waukesha systems installed on most of these cars by the time they were rebuilt.

The models come with modern drop equalizer trucks, and some of the Daylight cars received similar trucks taken from scrapped sleeping cars. I began with a parlor car from the MTH Northern Pacific two-car set, 81-60016.

Two prototype Southern Pacific parlor cars, 3002 and 3003, were rebuilt as chair cars SP 2242 and 2243 in 1964, and as I wanted some more coaches I began with this model. Follow the simple disassembly instructions that come with the car.

The windows in these models are held in place with transparent double faced tape. I removed the clear windows from the car body and left the tape in place while I painted my model.

I placed a strip of tape inside the windows to prevent spray paint from damaging the lighting system inside. I did not remove the paint on my model.



### 4. Model of Automat car 10600 converted from tavern car, from Kato N scale model.

Two of the three stripes on the Northern Pacific painted model I had are close to the location of seams in the stainless steel sides on the prototype cars, and are hardly noticeable.

I painted my car with SP Scarlet overall, then masked the letterboard strip on each side of the car, 12-3/8 scale inches wide. (.142" actual size, or close to 9/64") then the car was painted with a mixture of silver with a drop of black added to more closely resemble stainless steel color.

You might wish to paint the roof with bright silver, or silver over sprayed with Dullcote or other matt finish to show that these were painted, while the sides were actually stainless sheets. You could also use Alclad Stainless Steel on the car sides for a brighter finish.

I lettered my car with from the Microscale Daylight car decal set. The interior can be modified easily by unbolting it from the floor, then cut off the chairs. I made my own seating, but several manufacturers make sets of coach seats.

In the summer of 1963, parlor observation cars 2952, 2953, and 2955 were refitted as 72-seat chair cars numbered 2295, 2296

and 2297. This conversion is essentially the same as described above using the MTH five-car set's observation car as a start. In this case, however, the model needs the correct updated lighting array on the roof.

Please see the detail section of this article for more information. These conversions permit modeling the Coast Daylight and other SP trains of the 1960s and '70s.

The railroad badly needed modern chair cars in the mid-1960s and several other conversions were done, such as removing the kitchen segment of a triple-car food service unit to form an articulated coach pair with no bathrooms or vestibules. These could be built using Union Station Products sides.

### **"ABC" cars - Automat Buffet Cars, the Automats**

Most authors indicate that these food service cars were terrible, but friends who actually rode the cars report that the offerings were pretty much what is available in office vending machines -- basic brand name canned food such as Van Camps, Campbell's, or Chef Boyardee.

Of course this does not compare with the meals that had been served in dining cars that were similar to what you would expect in the dining room of a large city hotel. Santa Fe and New York Central both had Automat cars offering the same type of meals as the SP cars.

For modelers of any time period after 1962, Automat buffet cars ran on most of the Southern Pacific's long distance trains. Car 10600, the first car, was built in July of 1961 and in its first weeks could be represented by one of the ready to run tavern cars. Unfortunately, for modelers, after less than a month of service, the car was

# PART 8 - SP PASSENGER CARS | 7

5. Walthers 6-6-4 sleeping car and converted model as Automat car 10603, class 83-ABC-1.



COVER OR PAINT THE WINDOWS INDICATED



## PART 8 – SP PASSENGER CARS | 8

modified by having the three inboard windows of one end were plated over. See page 474 of the *Southern Pacific Passenger Car* series, Volume 4 for details.



Car 10601 was rebuilt in October, 1961, from a 79-foot Daylight tavern car. This is an easy conversion to class 79-ABC-1 that is very close to the prototype.

Begin with a tavern car, preferably the postwar version without skirts, or remove the skirts if you have an earlier version.

Remove or mask the windows and repaint the car imitation stainless with red letterboard stripe and grey lettering. (Or simulate the appearance of stainless using Alclad 2.

The small loading door on the prototype to the right of the plaque could be simulated with .010" styrene, and the car should have a Waukesha air conditioning system.

This would complete the conversion of the exterior of the car.

The bar is behind the solid wall area and is not easily visible from the outside, so either leave it alone or replace it with vending machines. Make rectangular forms of plastic sheet to simulate the vending machines, and place along the walls in the non-window section.

Fourteen more automatic buffet cars were rebuilt from lightweight 83 foot sleeping cars. The rebuilds were in number series 10602 through 10615, all classed 83-ABC-1. All of these had some of their windows near the center of the car covered.

These could be made by painting over or patching the windows on a Walthers Pullman-Standard flush side 6-6-4 lightweight sleeper. Photos of the prototype indicate that the seams where the windows were covered showed slightly. You can decide if you like the appearance obtained by just painting over the windows, or want to putty these and sand them to completely cover the former window areas.

Car 10615 was rebuilt from a Pullman-Standard 10-5 sleeper, and a Walthers 10-5 could be used as the start point for that car. Again, for all the details see Volume 4 of the passenger cars series by the SP Historical and Technical Society.





6. Class 83-D-1 dining car (built 1949) at Oakland. In 1957 cars of this type ran on the Coast Daylight in the UP style yellow and gray livery as in the photo.

## Lightweight SP dining cars class 83-D-1 built 1949

These cars came to the Coast Daylight in off-peak periods beginning 1957, in place of the triple unit diner. This class was also used in several other assignments including the City of San Francisco and San Francisco Overland Limited. When they entered service on the Coast Daylight they were not repainted until the early 1960s from their yellow and gray liveries into imitation stainless steel with red letterboard.

Union Station Products offers kit #7579a with sides to be used with their car core kit to make this model.

# SOUTHERN PACIFIC

CLASS 83-D-1 DINER

BUILT IN 194

IN 1957 CARS OF THIS TYPE WERE USED ON THE COAST  
THESE CARS WERE USED IN U.P. YELLOW FROM THEIR PRODUCTION



BY THE 1960s THESE CARS WERE PAINTED IN IMITATION STAINLESS STEEL





# PACIFIC RAILROAD

DINING CAR

49

LAST DAYLIGHT IN NON PEAK OPERATING PERIODS  
PREVIOUS ASSIGNMENT ON OVERLAND ROUTE TRAINS



UNLESS STEEL WITH RED STRIPE, PALE GREY LETTERING



UNION STATION PRODUCTS HAS SIDES FOR 83-D-1  
(KIT 7579)

## PART 8 – SP PASSENGER CARS | 13

← [Previous page] 7. Diner 83-D-1 dining car shown in Overland Yellow and as it appeared in the late '50s on the Daylight in SP imitation stainless steel paint with red letterboard.

If you prefer not to build a kit, ready to run stand-in models include the Walthers 48-seat (Illinois Central prototype) lightweight dining car (#933-15356) and the similar smooth side 1930 series lightweight Union Pacific dining car available from Walthers (932-9542).

This car could also stand-in for a coffee shop diner or lounge car.

8. Walthers Illinois Central prototype dining car as a stand-in for SP lightweight diner class 83-D-1.

WALTHERS ILLINOIS CENTRAL LIGHTWEIGHT DINER AS A STAND-IN



# PART 8 - SP PASSENGER CARS | 14

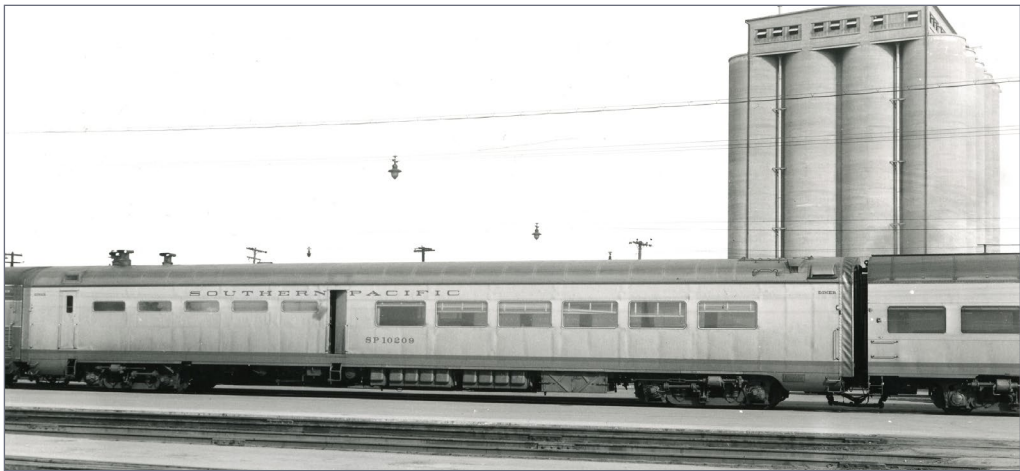

8. Prototype 83-D-1 dining car at Oakland needing a wash. *Courtesy Bob's Photos*

HAND-IN FOR 1949 SOUTHERN PACIFIC 83-D-1 DINING CAR





10. Prototype chair car 2354 in class 83-C-5 built in 1954 of steel for the Coast Daylight. *Courtesy Bob's Photos*

### Class 83-C-5 1954 Daylight chair car

Class 83-C-5 chair cars 2352-2358 and 2359 (2nd), 2360 (2nd), and 2361(2nd) were built with steel sides and roof for the Coast Daylight, with one car for Shasta Daylight in 1954.

The cars had tall windows of the size on the 83-C-1 class built for the Shasta Daylight In 1949. The 1949 cars had riveted aluminum roofs and their aluminum sides had a seam below the windows. If this is objectionable, the seam can be sanded down or filled in for use as an 83-C-5 car.

Union Station Products 83-C-1 car sides are .010" thick styrene with identical door and window arrangement to the 83-C-5, but for the seam.

Laser Horizons and Laserkit and other firms have similar products. These sides are to be used with a car core kit, available from most of these firms.

Note: I had already made my own cars when I saw that the Union Station cars were available.

# VICTOR ROSEMAN 2016 Calendar



Wallpaper  
photo downloads  
included!

Made especially for model railroaders by MRH

Vintage SP passenger trains



Major model RR  
event dates  
included!

Wall calendars:  
Open to 11" x 17"

**2016 AUGUST** San Joaquin Daylight behind three FP units, arriving in Fresno en route to Los Angeles, 1950.

Sunday	Monday	Tuesday	Wednesday	Thursday	Friday	Saturday
1 1 3 4 5 6 7 8 9 10 11 12 13 14 15 16 17 18 19 20 21 22 23 24 25 26 27 28 29 30 31	2 1 Eric Day (Canada)	3	4	5	6	7
8	9	10	11	12	13	14
15	16	17	18	19	20	21
22	23	24	25	26	27	28
29	30	31				



~~\$18.88~~

\$16.99  
+ S&H

**GET YOUR CALENDAR TODAY >>**

[store.mrhmag.com](http://store.mrhmag.com)

MRHMAG.COM

- TABLE OF CONTENTS
- INDEX

SOUTHERN PACIFIC

CHAIR CAR CLASS 83-C-5, 2352 - 2358, 2359 (2nd), 2360 (2nd)

PULLMAN STANDARD MANUFACTURE



83-C-5 IN THE AS DELIVERED DAYLIGHT COLOR SCHEME.



83-C-5 CAR AS REPAINTED AFTER 1958 WITH IMITATION STAINLESS WITH RED STRIPE. CARS

(I BUILT MY MODELS BEFORE I KNEW THAT UNION STATION

11. Models of the 83-C-5 chair cars. I built my own sides, which I added to car core kits before I knew that Union Station Products made these sides.

# PART 8 - SP PASSENGER CARS | 17

## C RAILROAD

, 2352 (2nd) - BUILT 1954 FOR COAST DAYLIGHT

MANUFACTURING CO.



RECEIVED NEW ALUMINUM FIXED STEPS AND THE BAGGAGE ELEVATORS WERE REMOVED.  
(ON PRODUCTS MADE SIDES FOR THESE CARS)

CHAIR CAR CLASS 83-C-5, 2352 - 2358, 2359 (2nd), 2360 (2nd)

PULLMAN STANDARD MODEL

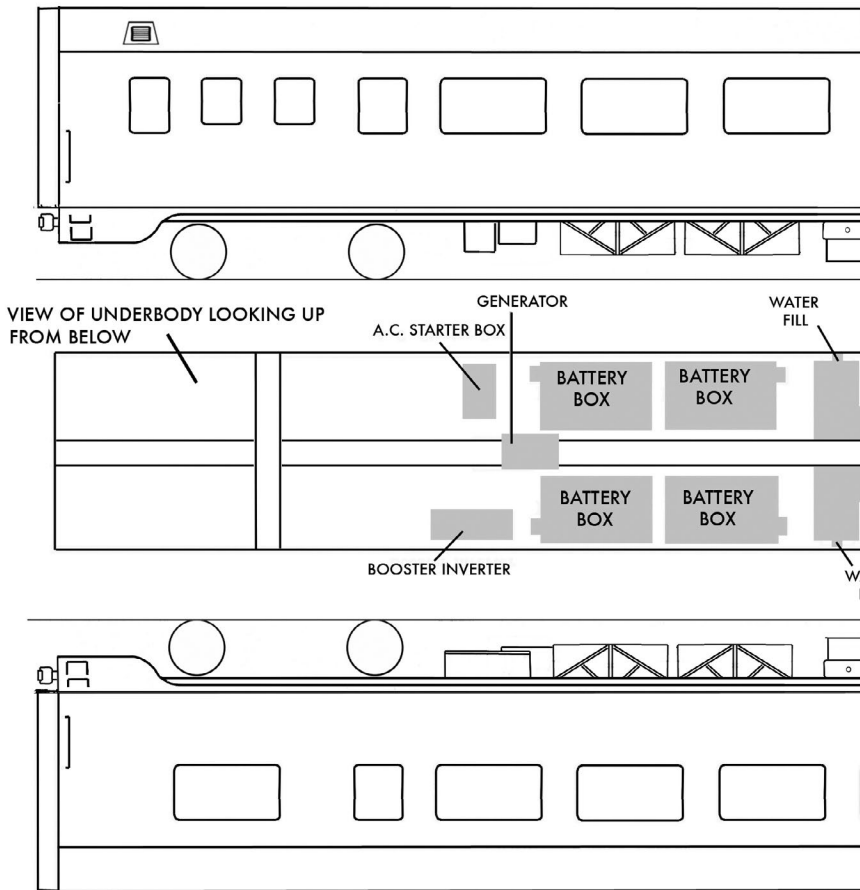

12. Drawing of 83-C-5 chair car showing arrangement of the Pullman electromechanical air conditioning unit on these cars. Class 83-C-5 was built of welded steel construction in 1954. The configuration was the same as one of the earlier class 83-C-1 chair cars built for the Shasta Daylight, which were built of riveted aluminum. Both classes has extra tall



## PACIFIC RAILROAD

(2nd) , 2352 (2nd) - BUILT 1954 FOR COAST DAYLIGHT

MANUFACTURING CO.

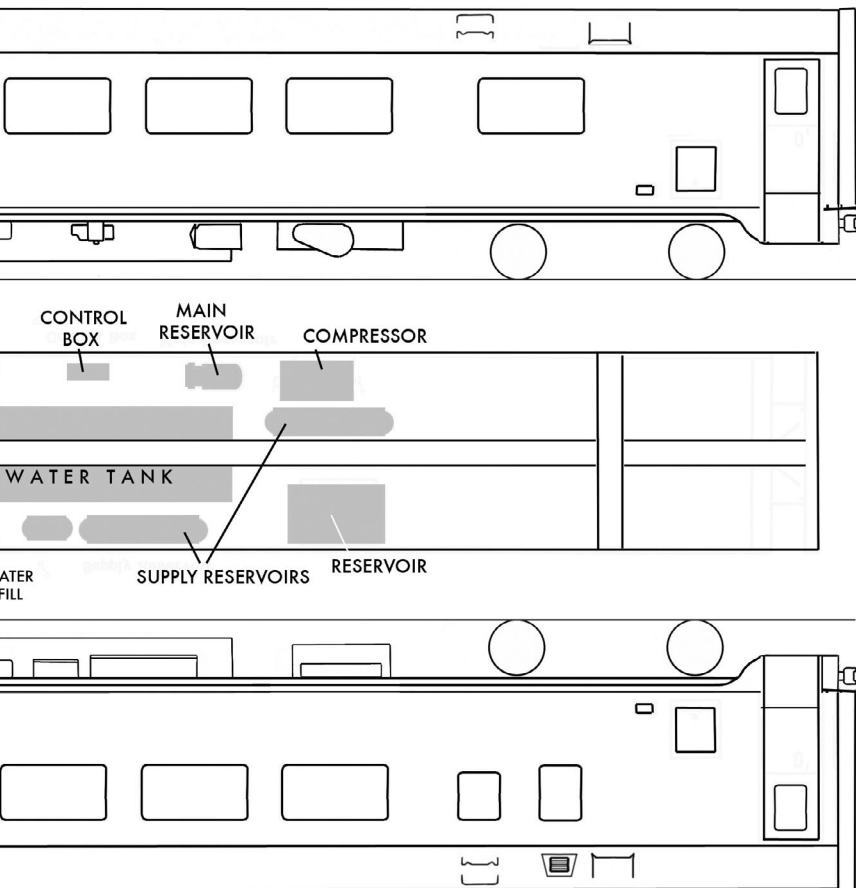

windows. Union Station Products kit #7571A for the 83-C-1 class car can be used to simulate the 83-C-5. (NOTE: There were other window and seating arrangements of the 83-C-1 cars for the Shasta Daylight, all classed 83-C-1.)



13. The coffee shop portion of a Shasta Daylight triple car food service unit illustrating windows that are 1/3 taller than most lightweight car windows. Postwar SP lightweight cars were recognized by these extra tall windows. *Courtesy Bob's Photos*

### Osgood-Bradley lightweight cars

In 1937, the St. Louis Southwestern (Cotton Belt, an SP subsidiary) bought several lightweight coaches very similar to the “American Flyer” cars on the New Haven.

Built by the Osgood-Bradley Pullman plant, other than air conditioning, these were very basic cars. Over the years, as passenger service was cut on the Cotton Belt, these cars migrated to the SP. Some of these cars were later sent back to the Cotton Belt. I have mentioned these cars because, as a popular and accurate model of an SP type car, I have been asked many times where they could be used on SP trains. The few photos of these cars on commute trains all appear to be deadhead moves.

The Osgood Bradley cars were used in Sacramento-Oakland services and on the West Coast and the Owl as well as possibly on other trains. Accounts of these cars are shown in the Southern Pacific Passenger Cars five-volume set, number 1 dealing with



14. SP 2215, an ex-Chicago North Western chair car, bought by SP in 1961, is shown in Overland Route service. UP owned nearly identical cars.

coaches. Rapido in Canada makes ready to run close replicas of these cars.

### Overland Route cars

In addition to the recent issue of City trains by Walthers in HO scale and by Kato in N scale, a number of other cars can be built to make up more complete consists and to model different time periods.

In addition to a number of car side sets from Laser Horizons and Union Station Products, Brass Car Sides Co. has UP and C&NW Challenger lightweight cars that would be used for a 1947 City of San Francisco. These cars operated until replaced by new equipment built from 1948, but were often used to fill in where needed, or would have been seen on the San Francisco Overland Limited or secondary trains.

The diagram [15] shows the procedure for using brass sides, and instructions are included in each set.

## BRASS CAR SIDES

USE RIVAROSSA  
1930 SERIES  
COACH CAR OR  
SIMILAR MODEL

1. CUT GROUPS OF  
WINDOWS OPEN  
FROM CAR SIDE

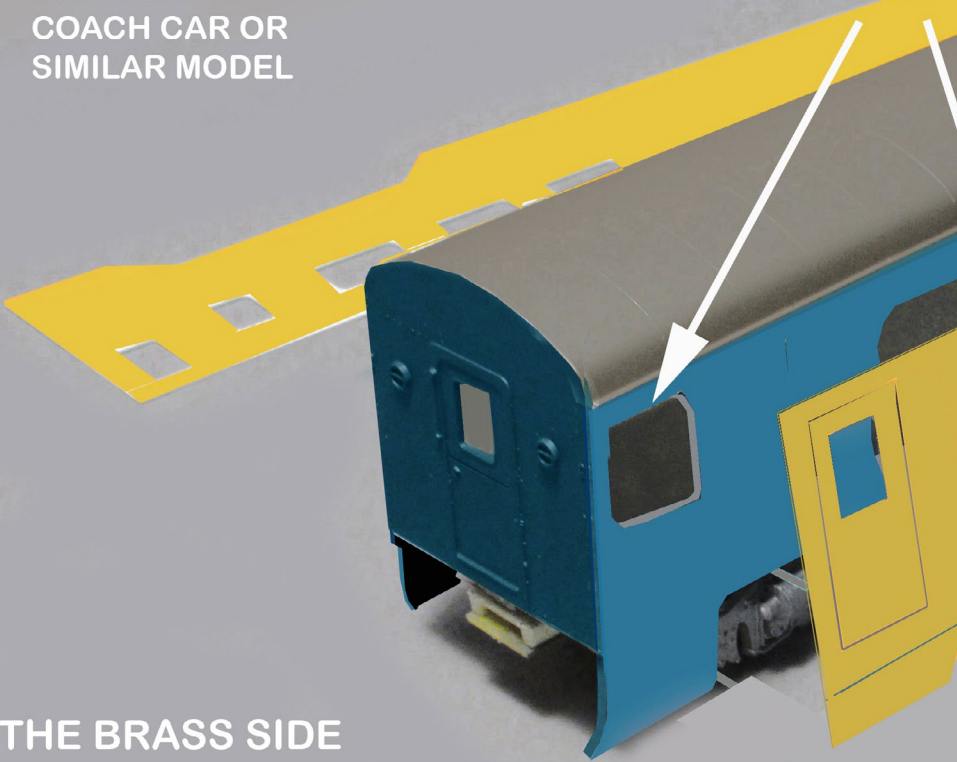

THE BRASS SIDE  
CAN BE PAINTED  
BEFORE OR AFTER  
ASSEMBLY BUT  
BEFORE INSTALLING  
WINDOW GLAZING

15. Applying alternative brass sides to a coach car kit.

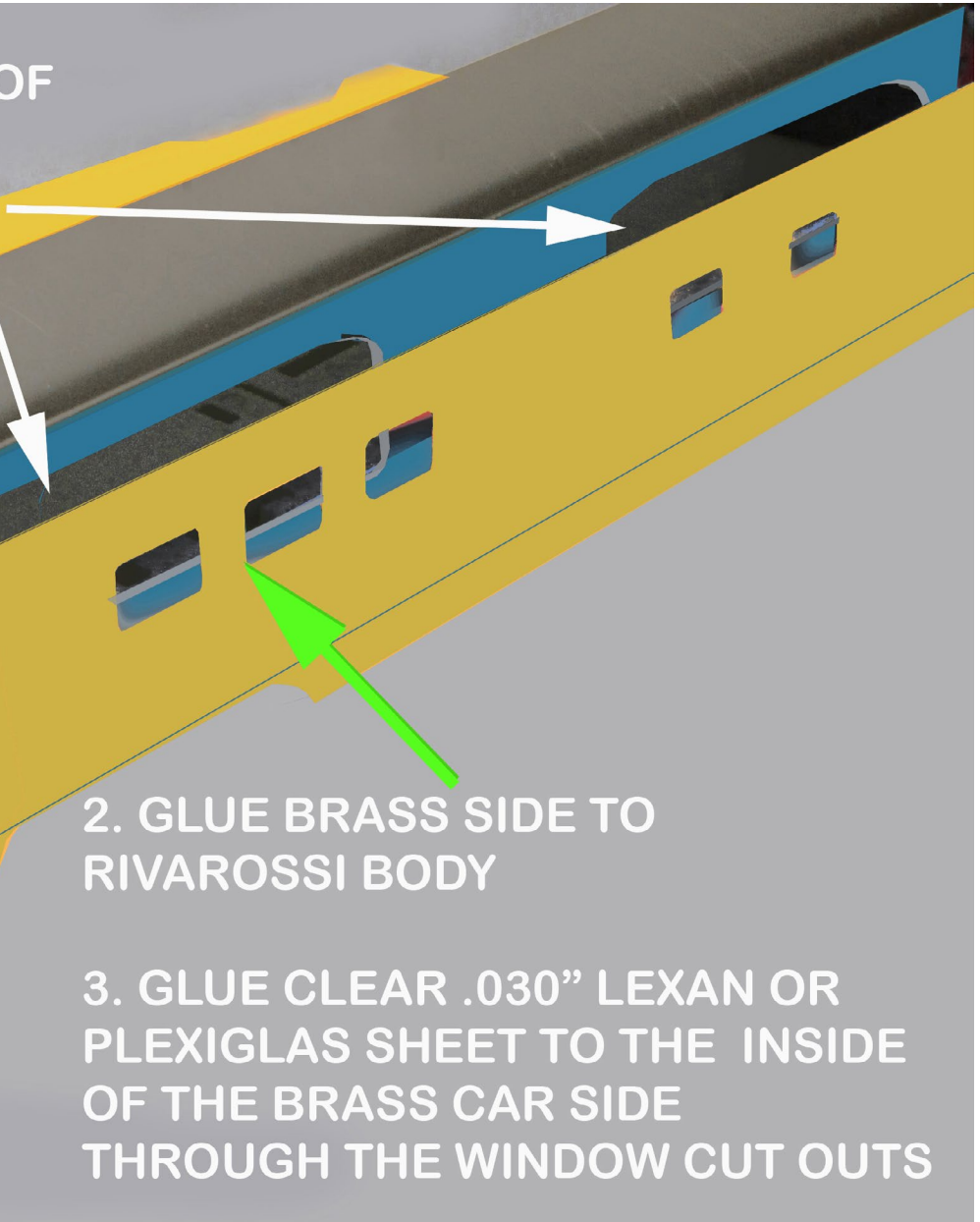

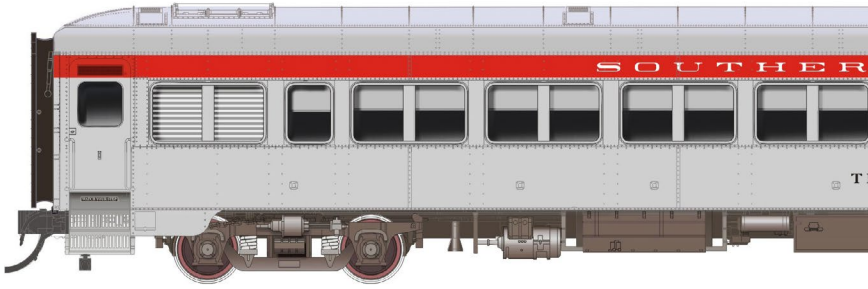

16. Built for the Cotton Belt (St. Louis Southwestern) SP subsidiary, these Pullman- Standard lightweight cars were sent to SP T&NO and Pacific lines when passenger service ended on their

Most of the Brass Car Side sets can be used on a number of car core kits in addition to the ones listed, so you may have a choice of construction methods. The car core kits are described above, and mounting on a Rivarossi or similar car has a few differences. The advantage of this method is that rigid sides are already in place.

Place the brass side on the car and trace out the windows. Cut out groups of windows leaving about 1/8" around the window tracings. Leave three or more vertical braces to stabilize the upper edge of the plastic car side. File off any raised detail on the plastic car side.

Apply the brass side. You may want to pre-paint the side, but I suggest doing this after it is applied. I recommend the use of a flexible contact cement.

The Woodland Scenics white contact cement Hobby Tack or solvent based DAP-Weldwood product both work well and are very strong. In both cases, apply the cement to both surfaces

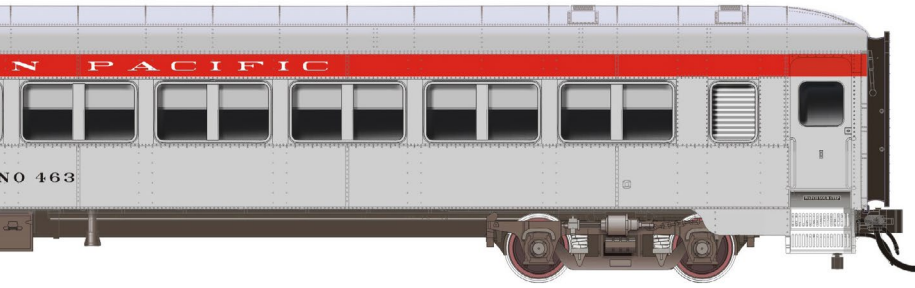

image courtesy Rapido

home road. They were used on the West Coast, the Owl and frequently in Oakland-Sacramento locals. *Illustration courtesy Rapido Models.*

and let dry till glossy, usually for 5-10 minutes. Align very carefully and press the side into place.

Carefully drill the spotted holes for hand grabs. Cut your window glazing to fit the openings that have been left for this purpose, and glue in place. Paint the car side, add decals and overspray. Handle the model very carefully now so you do not damage the decoration.

Cut your window glazing from Plexiglas, acrylic, Lexan, or similar .030" thick plastic and apply from the inside, through the openings in the plastic car side and glue to the inside of the brass side directly to provide realistic flush windows.

Contact cement can be used very carefully, applied with fine tool such as a toothpick. Do not smear the glazing. Contact cement provides a flexible bond that permits expansion and contraction that occurs with temperature changes. Even in temperate climates, changes do take place, and rigid adhesives like super glue may break apart.

### Core car kits

The car core is styrene and consists of a floor, roof and ends. Eastern Car Works car core kits include trucks. Underbody detail is available from aftermarket sources such as Precision Scale Models.

Construction of this type of kit is easy, but takes some care to get a really nice model. Each manufacturer of the car core kits has its own idea of what should be included. Some have interior bulkheads, others include trucks, for example.

1. Detail the roof with any vents or hatches and let dry.
2. Check to see that the ends have one with a closed door and one with an open door, if the car has a vestibule. Cut one end door open if necessary.
3. Paint the ends and roof. Scrape off paint from gluing surfaces, glue ends to roof.
4. Paint the sides, add all decal lettering and overcoats. Glue to the clear backing.

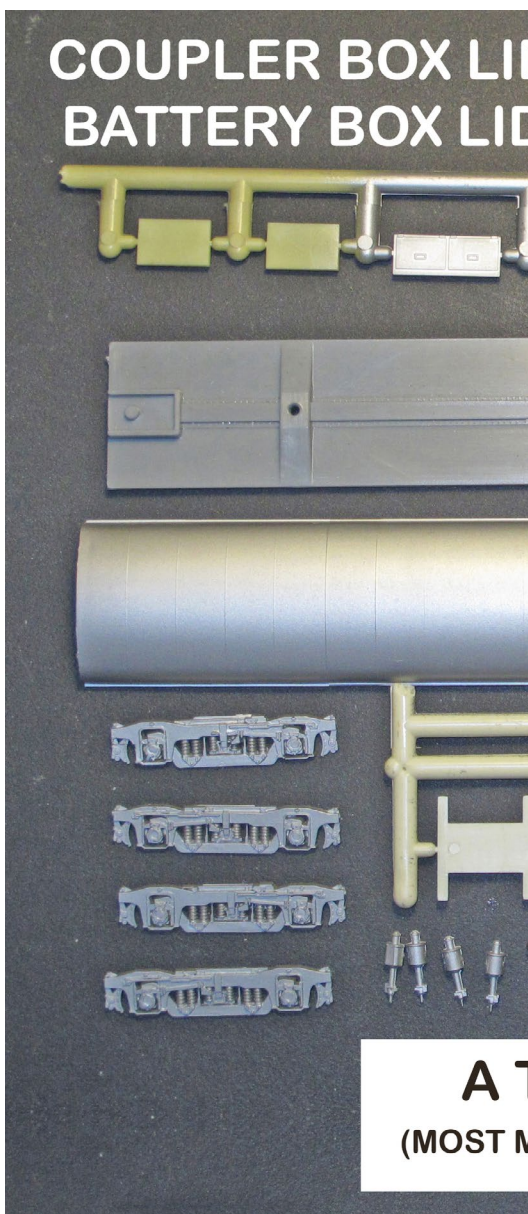



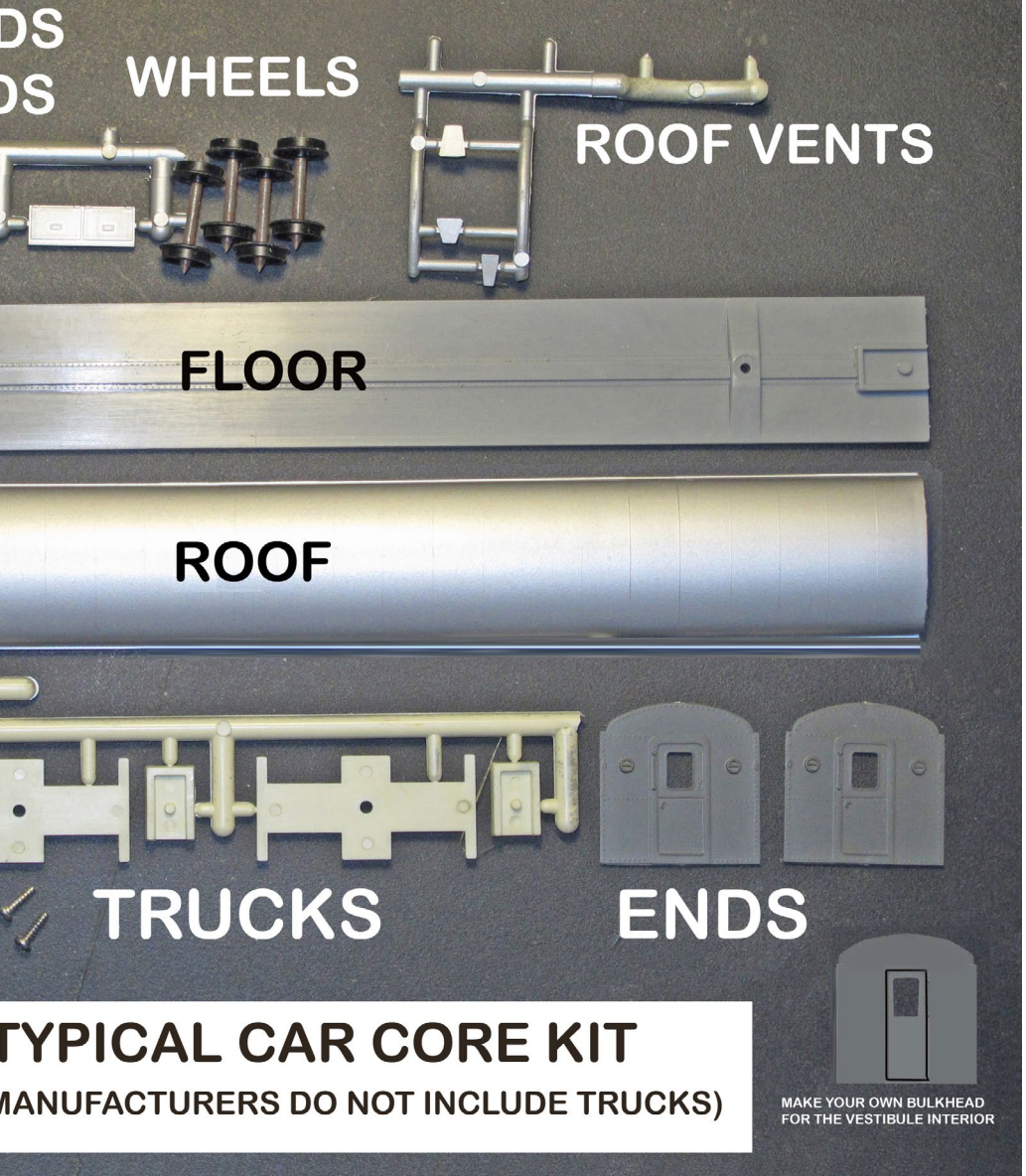

17. Parts in a car core kit. Most do not have trucks included. Some kits include various other details depending on the prototype chosen and the manufacturer of the kit.

5. Add the sides to the roof and ends. I suggest adding strip plastic in back to locate the floor.
6. Snap the floor in to check the fit, then remove to detail the underbody.
7. Add trucks, couplers and paint the unit. Do not paint the wheel treads. I spray a wash of flat finish and solvent with a small amount of earth color to most of my underbody units to simulate the weathering seen on most cars.

Many SP car sides are available from various manufacturers.

## CAR CORE KIT ASSEMBLY

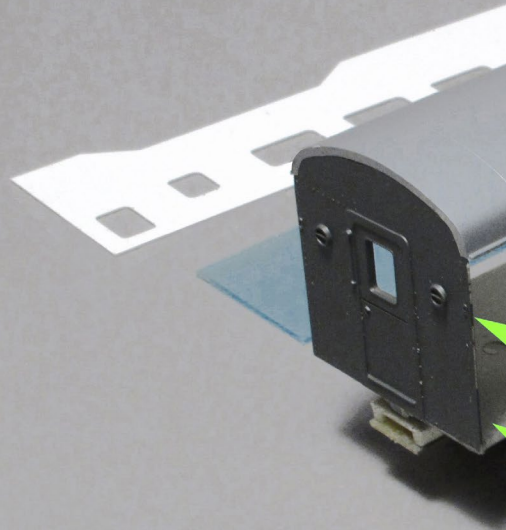

STYRENE SIDES AVAILABLE FROM AMERICAN MODEL BUILDERS, UNION STATION PRODUCTS AND OTHER MANUFACTURERS

### Car side and car core kits available for SP equipment

The following link leads to the Union Station Products website:  
[www.unionstationproducts.com](http://www.unionstationproducts.com)

Many Precision Scale Co. details can be found at their link:  
[www.precisionscaleco.com](http://www.precisionscaleco.com)

Red Cap Line ([redcapline.com/About/index.shtml](http://redcapline.com/About/index.shtml)) and Palace Car Co. ([www.palacecarco.com](http://www.palacecarco.com)) have interior appointments for your cars, such as vents.

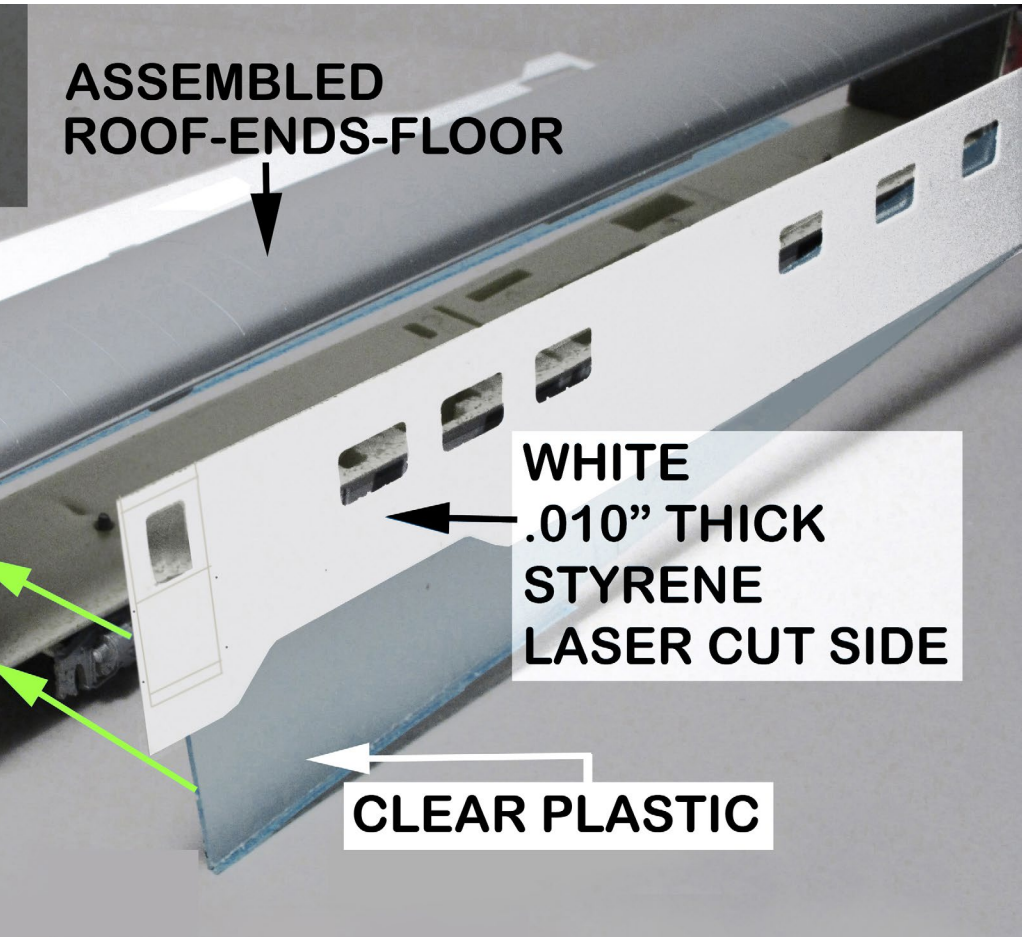

**18. Assembly of a car core kit.**

Laser Horizon sides (available through Pro Custom Hobbies) are a similar product and provide additional SP cars:

[www.procustomhobbies.com/catpages/LAH.shtml](http://www.procustomhobbies.com/catpages/LAH.shtml)



19. Walthers model of the 2215. Model features the tinted windows of the prototype. Minor detail variation is the notch over the truck which appeared only on the Union Pacific-owned cars.

## Condensed listing of SP kits available as of this writing

*Union Station Products car sides* available in HO and N scale (specify when ordering.)

[unionstationproducts.com/ho\\_n\\_scale\\_passenger\\_car\\_sides.html](http://unionstationproducts.com/ho_n_scale_passenger_car_sides.html)

### **KIT NUMBERS:**

7390 prewar fluted diner lounge observation for Sunbeam/  
Hustler T&NO 7403 prewar 79 ft. tavern lounge for Daylight

7417 pre-war triple unit coffee shop, kitchen, diner (fluted) 1939 and 1940 sets, pre 1951 appearance with small loading windows. Built for Daylight. On request the triple-unit car can be made as a flush side kit for later time period.

7422 pre-war 44-seat 79-foot chair car for Daylight

7423 pre-war articulated chair car pair with corrugated sides for Daylight

7423R pre-war articulated chair car pair with postwar rebuild (approx. 1958) flat sides used on Daylight

## PART 8 – SP PASSENGER CARS | 31

7569 46-seat chair smooth side, class 83-C-1 for Shasta. Window arrangement same as 1954 83-C-5 for Shasta and Coast Daylight

7571 48-seat chair car smooth-side vestibule forward, 83-C-1 for Shasta  
7571A 48-seat chair car smooth side, 83-C-1 for Shasta

7575 tavern-lounge smooth side Timberline Tavern for Shasta, on Coast Daylight after 1957.

7572 triple-unit diner/kitchen/coffee shop smooth side for Shasta Daylight, later on Coast Daylight (tall window type car)

7579A 48-seat diner smooth side, post-war used on Coast Daylight non-peak periods after 1957. In yellow UP colors till repainted in silver and red. Built for Overland, COSF, Golden State.

7582 coffee shop-lounge smooth side 1949, prototype cars 10402-6 Golden State and COSF. Later converted to hamburger grill and used on various trains.

There is also a 9600 series of Budd fluted car side kits as built for the 1950s Sunset, later seen on any SP train including Daylight. Other SP cars for Lark, Cascade available.

***Laser Horizons car sides*** (Available through Pro Custom Hobbies)

The list as of writing includes the following SP cars:

Laser Horizons does not show any diagrams. The price for a pair of car sides for one car is \$20.00 from Pro Custom Hobbies, plus shipping. Their web page indicates that the HO sides are 20 mil ABS plastic. Their cars appear to be 1949 Shasta Daylight cars, but please check before ordering as I have no additional information. Their ordering list indicates these are *special order items*.

[www.procustomhobbies.com/catpages/LAH.shtml](http://www.procustomhobbies.com/catpages/LAH.shtml)

## PART 8 - SP PASSENGER CARS | 32

### CHALLENGER CARS FOR 1940s- EARLY

UNION PACIFIC "CHALLENGER" 48 SEAT CHAIR  
BRASS CAR SIDES CO. SET#173-3

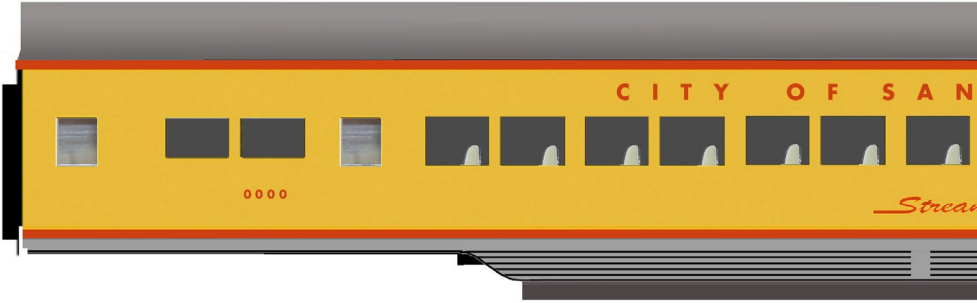

UNION PACIFIC "CHALLENGER" 56 SEAT  
BRASS TRAINS CO. SIDE SET #173-67. (FITS TR



CAR IS SIMILAR OR THE SAME AS C&NW CARS 61

20. Appearance of "Challenger" type chair cars for SP/UP/CN&W RR interline City of San Francisco train. Brass sides are available for these car models.

New England Rail Service ([www.newenglandrail.net/products.html](http://www.newenglandrail.net/products.html)) has styrene kits for ice air conditioning boxes and other underbody equipment for heavyweight cars. Palace Car Company has light-weight car air conditioning.

## PART 8 - SP PASSENGER CARS | 33

### 1950s CITY OF SAN FRANCISCO TRAIN

CHAIR CAR UP #5331-5365 PROTOTYPE BUILT 1942  
31 (FITS RIVRAROSSO COACH BODY)

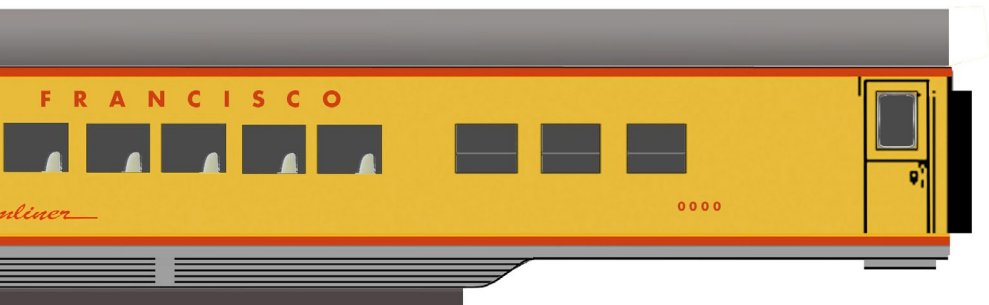

CHAIR CAR BUILT 1937, UP #5200-5211.  
TRAIN STATION PRODUCTS ACF CAR CORE KIT)

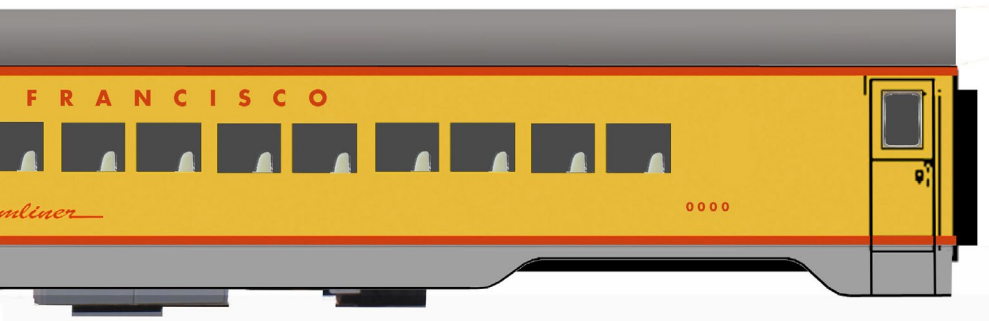

32-6166 BUILT 1937 AS USED ON COSF TRAINS

Precision Scale ([www.precisionscaleco.com](http://www.precisionscaleco.com)) has some air conditioning parts and many other details.

Train Station Products ([trainstationproducts.com](http://trainstationproducts.com)) also has trucks and air conditioning parts.

Cal Scale has additional brass parts such as the UC brake systems. ([www.bowser-trains.com/hooter/calscale/calscale.htm](http://www.bowser-trains.com/hooter/calscale/calscale.htm))

## Summation

I have attempted to show models with the correct details and with the appearance of the prototype, but in some cases appearance is a matter of opinion, and I have no doubt there are other ways to simulate these passenger cars.

In researching the underbody equipment of these cars, I would see notations such as "not all cars were so modified." This accounts for the different appearance of some cars from the official description of their class or group.

Some heavyweight cars were modified with ice air conditioning. Beginning in the 1930s, most or all lost their ice boxes when Steam Ejector air conditioning system was installed.

The 1937 lightweight Daylight cars received Steam Ejector a/c units, but by the late 1930s, new lightweight cars were delivered with Waukesha a/c and some Steam Ejector-equipped cars

## ALUMINUM

CARS BUILT FOR THE CITY OF SAN FRANCISCO WERE DELIVERED WITH DECORATIVE ALUMINUM ABOVE AND BELOW THE WINDOWS. SOME CARS ADDED LATER WHILE OTHERS NEVER RECEIVED

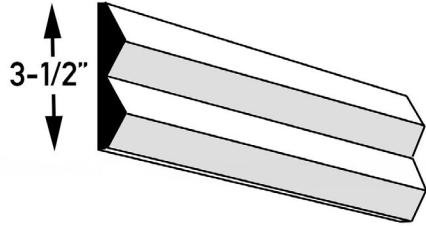

.040" STRIPING TAPE SCALES 3-1/2" IN HO SCALE AND IS A REASONABLE WAY OF SIMULATING THE ALUMINUM STRIPS.

BEHIND THE LOUVERED SKIRTS, SOME CARS HAD SOLID "W" ENCLOSURES AROUND THE UNDERBODY APPLIANCES.

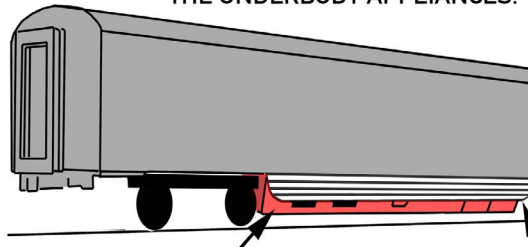

"W" ENCLOSURE

LOUVERED SKIRT



# M STRIPS AND LOUVERED SKIRTS

IN 1941, 1942 STRIPS HAD THESE THE STRIPS.

MANY OF THE CARS IN THE 1947 COSF CONSISTS HAD LOUVERED SKIRTS WITH "W" CASINGS. THE REMAINING CARS HAD CONVENTIONAL SOLID SKIRTS. ALMOST ALL WERE REMOVED BY 1952.

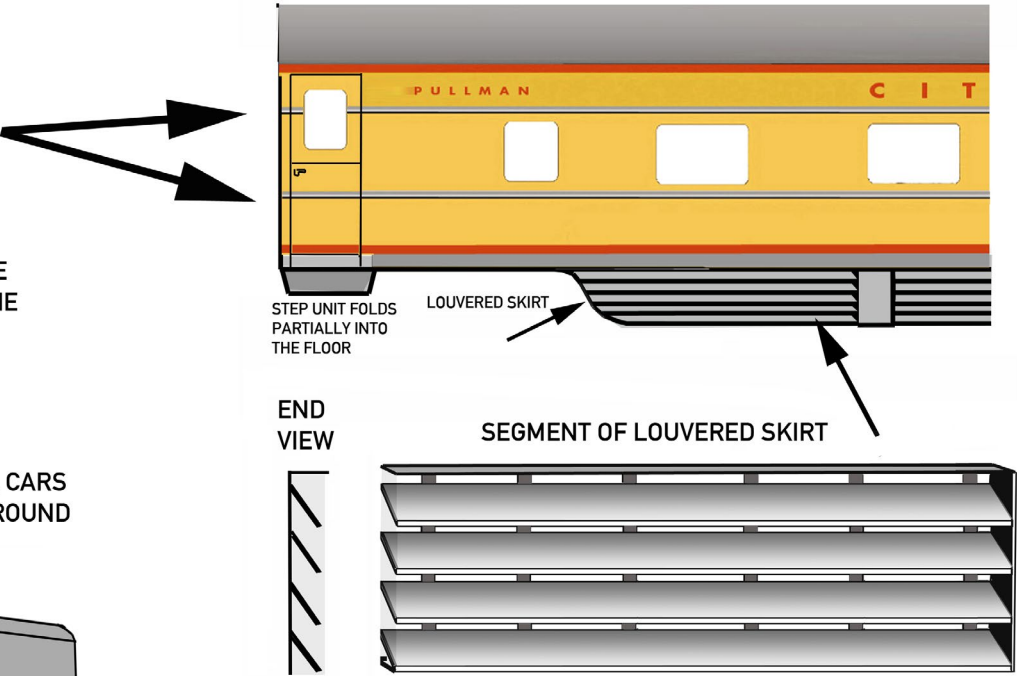

21. The City of San Francisco cars built to UP styling standards for Overland service were fitted with aluminum strips above and below the window pier panel. Most of these cars had louvered skirts built as shown.

were changed over to Waukesha systems. After World War II, once the railroad appeared to be satisfied with Waukesha units, I found that one group of the postwar cars (class 83-C-5) had Pullman electromechanical air conditioning.

So it is necessary to model not only the underbody equipment as delivered on the streamlined cars, but also be aware of changes to the underside of your model that may have happened during the time period of interest.

Work from good data or photos for accuracy. In my case, unless noted, most of my models still have the underbody equipment they came with.

If you model for effect, there are many possibilities for simulating your favorite train, even if

SP is not the railroad you wish to model. I have shown several methods of modifying existing models so they come closer to the appearance of specific cars that are not available as ready to run or kit form plastic cars.

Some of the modified cars are very close in appearance to their prototypes, while others may only be acceptable when

MODEL

EVERGREEN STYRENE  
#4051 CLAPBOARD  
.050" SPACING, .040" BASE



CUT OFF  
SKIRT END

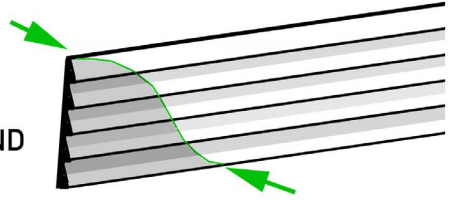

CUT SOLID ENDS  
FROM .040" THICK  
STYRENE

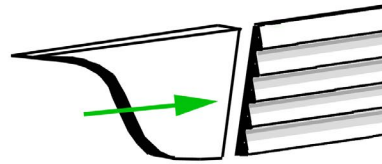

--- Remaining covered skirts on SP cars.

## ING LOUVERED SKIRTS

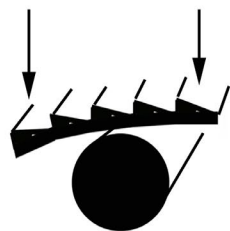
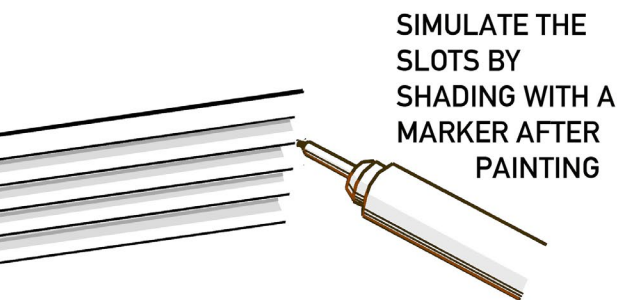
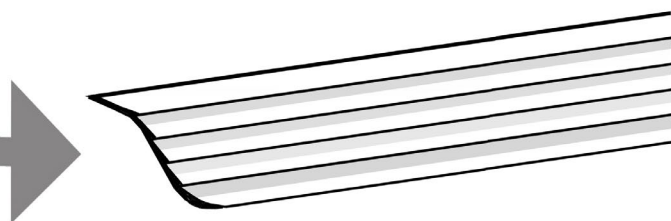
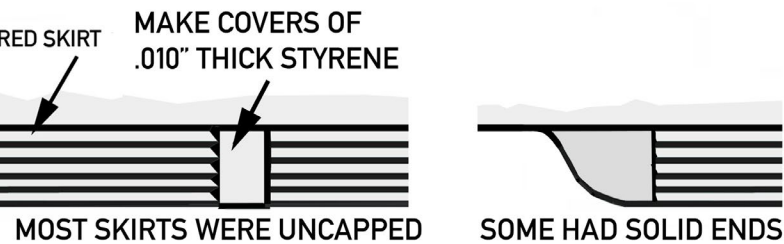

PRESS OVER  
A ROD TO  
FORM  
CURVATURE

rolling by on a train on the model railroad. When cars are standing still, you can carefully count the number of windows, inspect car numbers, or spot other variations from the prototype. When kitbashing many of these cars, you can reduce or eliminate the need for a lot of expensive brass equipment – and you may even have some cars that never have been made in brass.

# 1947 CITY OF SAN FRANCISCO LETTERING AND SIDE DETAILS, PAGE 1

23. The City of San Francisco cars at this time were owned by a consortium of the Union Pacific, Southern Pacific, and Chicago North Western Railroads. Beginning in 1946, ownership of the cars was divided among the three roads. Cars were gradually relettered with the railroad name or Pullman name in the letterboard with the owning railroad's name at the letterboard ends. Most of the COSF cars had louvered skirts, but some had sheet metal skirts. Some of the louvered skirts were replaced with sheet metal, and by about 1950 they were gradually being removed to gain better access to underbody equipment. (Window arrangements shown are only examples)

CONSO

Sleepers with aluminum window strips and louvered skirts

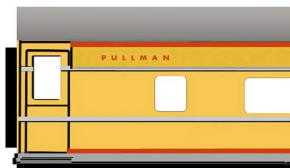

Sleepers with plain sides and solid skirts

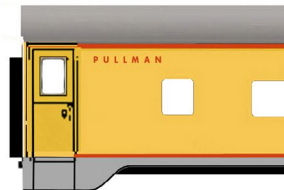

Chair cars with aluminum strips and louvered skirts

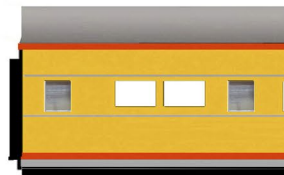

Chair cars with aluminum strips and solid skirts



Chair cars with plain sides and louvered skirts



## PULLMAN OWNED CARS 1940s THROUGH 1947

*Example: Rincon Hill*



*Example: American Brigade*



*Example: Dormitory-Club car Marina*



*Example: Chair car Market Street*



*Example: Chair car 5338*



# 1947 CITY OF SAN FRANCISCO LETTERING AND SIDE DETAILS, PAGE 2

RAILROAD OWNED C

Example: South

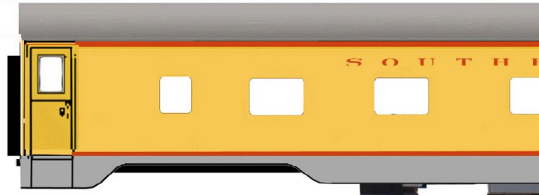

Example: Un



Example: Union P



## Series conclusion

We've come to the end of this multipart series: *SOUTHERN PACIFIC DAYLIGHT PASSENGER CARS: More than just the Daylight.*

In this series, I have attempted to show the breadth of Southern Pacific passenger trains that were run, and tried to provide a good sense of the appropriate details for the various trains and cars. As you can see, the scope of this series has covered far more than just the Daylight trains.

I hope you have enjoyed learning about the SP prototype and gotten some good ideas on how to model any kind of passenger train well, be it the SP or some other prototype. ☑

Shown are some of the detail a in the 1947 time period. There your cars.

# PART 8 - SP PASSENGER CARS | 41

## CARS, 1948 AND LATER

*ern Pacific 9250 (ex Portsmouth Square)*



Sleepers with SP railroad name and car number

*ion Pacific Imperial Flower)*

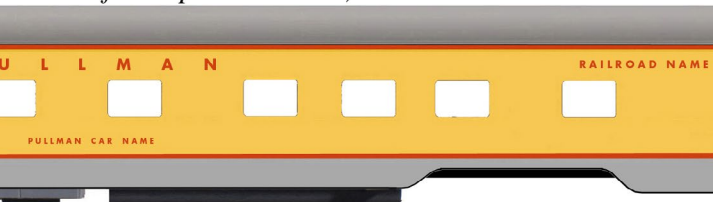

UP sleeper with Pullman in center, UP small at ends

*Pacific Baggage-Dormitory car 5316)*

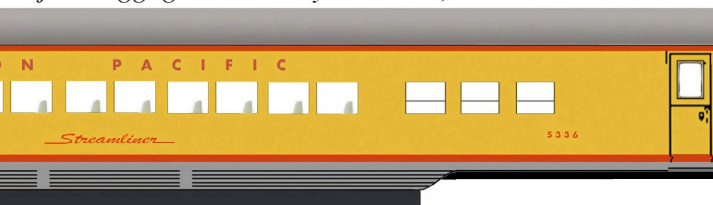

Railroad owned chair cars (UP, CNW) w/louvered skirts

arrangements for cars on the City of San Francisco were other variants, so use photos to model

***In the December bonus downloads to go with this series, we will include many reference drawings of various passenger car configurations and suggested stand-ins where available.***



**Click here for reader comments**



## VICTOR ROSEMAN

Victor got his first train, a Lionel, at age 3. Victor graduated from the Pratt Institute with BFA and MS degrees and taught fine arts in high and junior high school for 30 years and is now retired.

Victor has written many articles and several railroad related books over the past 35 years. He's also done many freelance projects for Walthers, Atlas and other model manufacturers. ■

ADVERTISEMENT

# END OF TRAIN DEVICE

**NEW ORANGE CASE!**

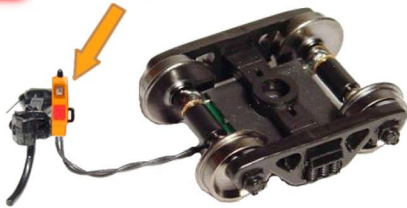

**Bright Red Flashing Light!**

Installs in minutes!  
No freight car modification required!

**RE RING**  
ENGINEERING

**Click Here to Learn More**

Patented Technology - US Patent 7,549,609

**Does not affect Load!**

↓ Car without Load ↓



↓ Car with Load ↓



MRHMAG.COM

- TABLE OF CONTENTS
- INDEX



# Heckman's Canadian Pacific A Photographic Journey

by Ralph Beaumont

Joseph Heckman was a pioneer photographer for the Canadian Pacific Railway. He photographed the line from coast to coast between 1898 and 1915, capturing the engineering works, stations, hotels, steamships, and the people who made the railway run. More than 4,000 of these historic images are preserved in the CPR's Corporate Archives, and 380 of them have been made available for this large format, hard cover book.

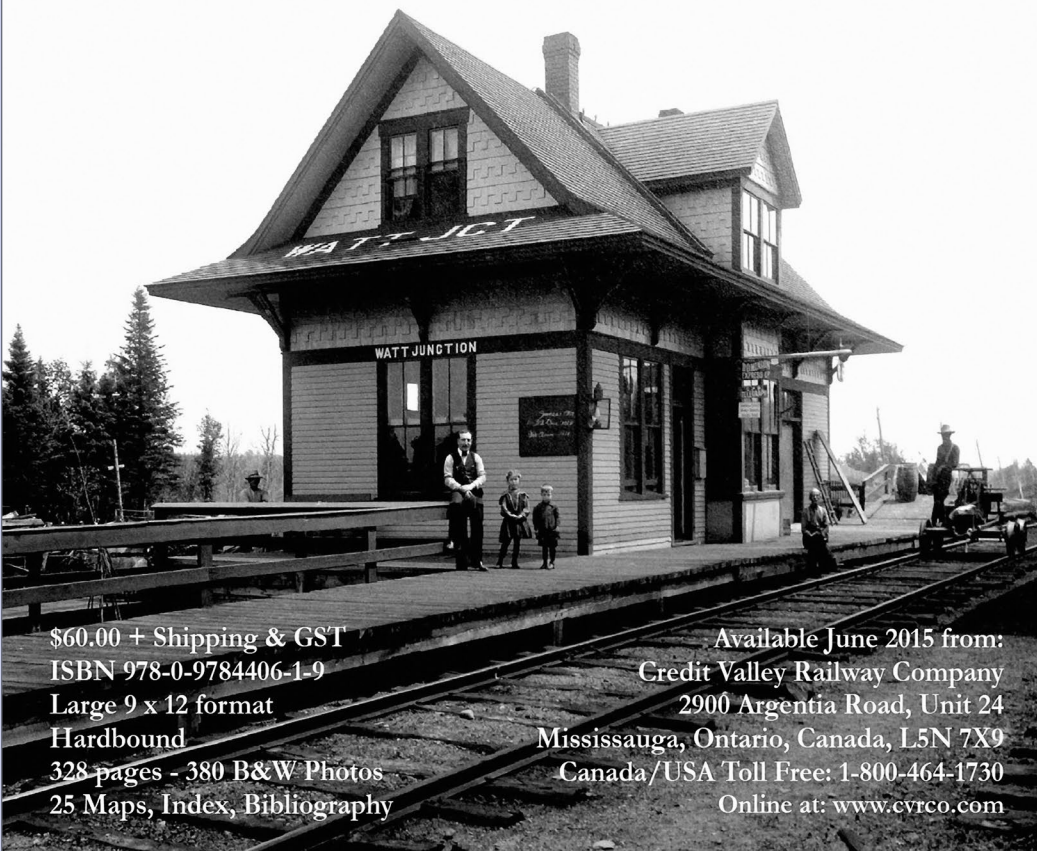
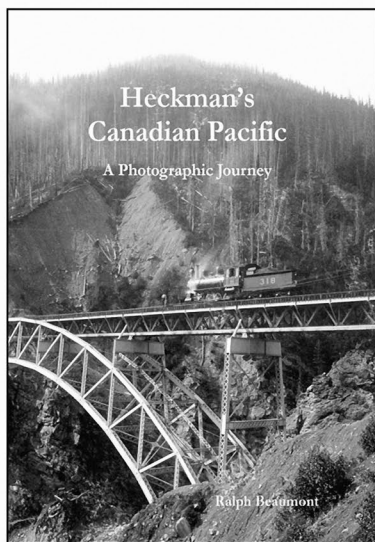

\$60.00 + Shipping & GST  
ISBN 978-0-9784406-1-9  
Large 9 x 12 format  
Hardbound  
328 pages - 380 B&W Photos  
25 Maps, Index, Bibliography

Available June 2015 from:  
Credit Valley Railway Company  
2900 Argenta Road, Unit 24  
Mississauga, Ontario, Canada, L5N 7X9  
Canada/USA Toll Free: 1-800-464-1730  
Online at: [www.cvrco.com](http://www.cvrco.com)

[MRHMAG.COM](http://MRHMAG.COM)

- [TABLE OF CONTENTS](#)
- [INDEX](#)

# WHAT'S NEW!

ON  
TRAINMASTERS.TV

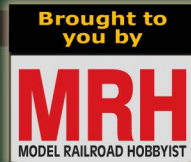

## BETTER STRUCTURE ROOFS

Every building has one, and Miles Hale has lots of tips for making them unique.

**Non-members: Watch for just \$1.49!**



## DIESEL HANDRAIL UPGRADE

Efram Ellenbogen finishes his brass handrail upgrade on an Athearn "blue box" SD40-2.

**Non-members: Watch for just \$1.49!**



## THE SCALE TRAINS STORY: 1

TMTV's exclusive backstory of how this major new hobby company, ScaleTrains.com, came to be. 1 of 3.

**FREE FOR FOR ALL TO VIEW!**



**HOT!**

## G. CHRISTENSEN WEATHERING

Gary Christensen of The Weathering Shop demonstrates his weathering secrets to host Joe Fugate.

**Non-members: Watch for just \$1.49!**



**Special  
Holiday  
pricing in  
effect!**

**Watch these videos on TrainMasters.TV**

(Non-members can now watch one of these videos for just \$1.49, or download-to-own for \$3.49)

MRHMAG.COM

- TABLE OF CONTENTS
- INDEX

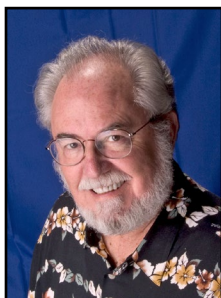

# DECEMBER NEWS

column

RICHARD BALE *and* JEFF SHULTZ



[Click here for  
reader comments](#)

## Trainfest 2015

Several MRH staff members and hundreds of other suppliers, dealers, publishers, and manufacturers have just returned from attending Trainfest 2015. Held annually in Milwaukee, WI, Trainfest has become the most significant such event for both hobbyists and suppliers in the model railroad community. This year 19,500 hobbyists attended the two-day event where they were able to see and meet with the employees of more than 200 exhibitors. Many manufacturers took the opportunity to announce brand new products, which are in this report. Next year's Trainfest is scheduled for November 12 and 13, 2016 ...

## SceniKing Closing

Les and Janet Mavor, owners of **SceniKing** brand products, has announced that due to complications from medical

▶ THE LATEST MODEL RAILROAD PRODUCTS, NEWS & EVENTS

# DECEMBER NEWS | 2

.....

issues, they will discontinue making their backdrop products at the end of this year. They will continue to fill both retail and wholesale orders until December 18, 2015. Until that date inquiries can be directed to [les@sceniking.com](mailto:les@sceniking.com) ...

## New Addresses

**Concept Models** is now located at 8810 El Toro Way, Stockton, CA 95210. The web site remains [con-sys.com](http://con-sys.com) ...

**MTS Imports** has relocated to Florida. Owner Joel Lovitch said the new address, P.O. Box 5279, Sun City Center, FL 33573, is effective now ...

**N.J. International** has also moved to Florida. Their new address is P.O. Box 1686, Land O Lakes, FL 34639. Phone 813-406-4288. The email address is [orders@njinternational.com](mailto:orders@njinternational.com) ...

.....

## NEW PRODUCTS FOR ALL SCALES

*Arduino Model Railroad Signals* is a new 8 x10-inch soft-cover book by Paul and David Bradt that provides ideas for the model railroad hobbyists to develop automated signal projects using and programming the Arduino micro-controller. Subjects include using the Arduino microcontroller to control one or multiple signals, linking two Arduinos to control signals remotely, and building a programmable fast clock. Published by CreateSpace Independent Publishing, the 100 page book is available at [amazon.com](http://amazon.com).

.....

**Hobbymasters** has 1 ounce plastic bottles with 1-inch stainless steel hollow needle dispensers. They are well suited for accurately

## DECEMBER NEWS | 3



dispensing a variety of fluids including solvent, flux, oil, glue, ink, contact cleaner, and ACC kicker. The bottles are available with needles having inside diameters of 008, .010, .012, and .023 inches. Replacement needles are also available with collars in several different colors to help identify the contents. For additional information visit [hobby-masters.com/hobbymasters-stainless-needle-point-applicator-bottle](http://hobby-masters.com/hobbymasters-stainless-needle-point-applicator-bottle).

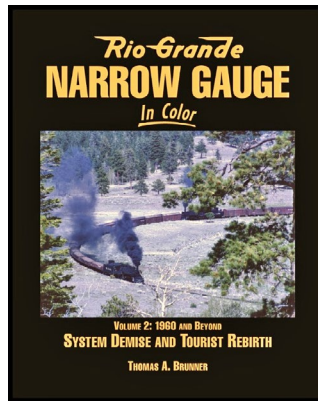
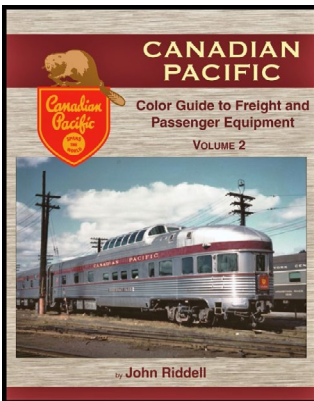

**Morning Sun Books** has released several new titles just in time for the Christmas gift giving season. New hard covers include *Volume 2, Canadian*

*Pacific Color Guide to Freight & Passenger Equipment* by John Riddell, *Volume 2, Rio Grande Narrow Gauge In Color* by Thomas A. Brunner, and a look at an iron ore-hauling railroad in Michigan's Upper Peninsula titled *Lake Superior & Ishpeming Railroad in Color* by David C. Schauer.

Two additional new books are *Southern Railway Power in Color* by Kurt Reisweber, and *Volume 2, Conrail Under Pennsy Wires* in

which author Robert Davis Jr. looks at Conrail electric and diesel freight operations in some of PRR's old electrified territory.

New e-books of note from Morning Sun include *Forty Years of Rio Grande Narrow Gauge* by Soph Marty, and digital reprints of *Spokane, Portland & Seattle Color Guide to Freight and Passenger Equipment* (originally published as a hardback in 1998), and *Union Pacific Diesels In Color: 1934-1959*. For additional information contact a dealer or visit [morningsunbooks.com](http://morningsunbooks.com).

.....

## O SCALE PRODUCT NEWS

**Atlas O's** production schedule for the third quarter of 2016 includes a triple-bay grain car and an LPG tank car. Both two-rail and three-rail versions of the ready-to-run models will be offered.



The O scale ready-to-run version of the grain car is based on a center-sill car Trinity Industries introduced in 1995. The distinctive curved (some

would say bulging) sides and triple discharge outlets were specifically designed to increase the efficiency of hauling grain. Paint schemes on the 5161 cu. ft. car will be BNSF, CSX, Iowa Interstate, and Denver & Rio Grande Western. The ready-to-run model features metal corner steps and grab irons, die-cast trucks with rotating bearing caps, etched-metal roof walk and safety platforms, and different hatch styles as appropriate to each road name.

The second Atlas O model expected in the third quarter of next year is an 11,000 gallon tank car. The ready-to-run model follows

# DECEMBER NEWS | 5



a prototype built by American Car & Foundry in the 1940s and '50s primarily for transporting liquefied petroleum gas. Road names will include Hooker Chemicals, GAF (Linden NJ), Gas-Oil Products of

Florida, Gem Automatic Gas Co. , and Jefferson Chemical. Atlas O will offer both two-rail and three-rail versions of the model. For additional information about Atlas O products contact a dealer or visit [atlaso.com](http://atlaso.com).

.....



**Downtown Deco** has released two new O scale Hydrocal structure kits. The craftsman style kits include cast walls, color signs, and detailed assembly instructions. Painting and weathering suggestions are also included. The new kits include the Boobie Hatch (10

x 7 inch footprint) and Chop Suey Take-Out (1.5 x 4 inch footprint). For additional information visit [downtowndeco.com](http://downtowndeco.com).

.....

**Model Railroad Control Systems** is selling a DCC compatible occupancy detector. The device is a low cost, DCC only, current sense track/block occupancy detector. It is intended to be inserted inline with one block feeder wire and provide a signal

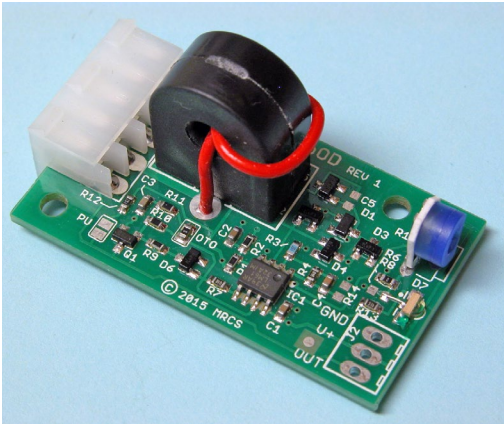

indicating a track/block has current flowing in it. The occupancy signal is logic low and can be tied to a computer input port or current limited LED. The unit draws 5mA @ 5V and supports up to 60A of track current. It is available with either a 3-position screw terminal block or

with a 5-pin Molex connector. For additional information including quantity pricing, visit [modelrailroadcontrolsystems.com/cpod-control-point-occupancy-detector](http://modelrailroadcontrolsystems.com/cpod-control-point-occupancy-detector).

## HO SCALE PRODUCT NEWS



**Accurail** is currently developing a new HO scale 36-foot (inside length) double-sheathed wood boxcar. According

to company chief Dennis Storzek, the tooling will allow them to produce models with either a wood or 7/7 inverse corrugated steel end, and either a fishbelly or straight underframe. The various combinations of ends and underframes suggest an opportunity for a wide range of road names. The new model will follow Accurail's formula of offering economically priced kits with molded-on detail, automatic couplers, and appropriate trucks. Availability is tentatively set for next fall.



# DECEMBER NEWS | 7

Meanwhile Accurail has released several new HO scale freight car kits including three open hopper cars.



This USRA twin-bay hopper is available decorated for Norfolk & Western and Clinchfield.



The third hopper in the current group is a Pennsylvania Railroad 40-foot war emergency composite car with a *Buy War Bonds* slogan.



Three different styles of boxcar have also been released including a T&P single-sheathed car with outside bracing. The wood car has Murphy steel ends and Youngstown corrugated steel doors.



A double-sheathed wood car decorated for Ann Arbor has Murphy ends and a National door.

# DECEMBER NEWS | 8



A Grand Trunk Western steel car with a maple leaf herald is the third boxcar kit Accurail released this month. The car is based on a 40-foot AAR design built in

1937 with Dreadnaught ends and Youngstown doors.



New covered hopper kits available this month include a CN/IC car and a 4750 cu. ft. triple-bay car decorated for Farmers Coop of Creston, Iowa.



Completing Accurail's list of current releases is a kit for a Western Fruit Express ice refrigerator car. All Accurail HO scale kits include appropriate trucks and Accumate

couplers. For additional information contact a dealer or visit [accurail.com](http://accurail.com).



**American-Excellence** is an on-line seller that specializes in die-cast vehicles. Their 1:87 scale collection ranges from exotic foreign vehicles like this Alfa Romeo 8C 2900B to domestic four-door sedans such as the 1986 Chevrolet Caprice shown above – and virtually everything in between. To review their on-line catalog visit [american-excellence.com](http://american-excellence.com).

.....



**Athearn** is working toward an October 2016 release date for an all-new 1960s-era EMD SD39 diesel locomotive. The Ready-to-Roll model will be available as a DCC-ready version as well as with full DCC features. Road names will include Santa Fe (blue and yellow 1969 as delivered scheme, above); Minneapolis, Northfield & Southern (with Flexicoil “c” truck side-frames with high brakes); Illinois Terminal; Norfolk & Western (in both large and small road name schemes); and Southern Pacific (bloody nose scheme, below).



An undecorated version with all detail parts uninstalled will also be offered both with and without DCC and sound.

# DECEMBER NEWS | 10

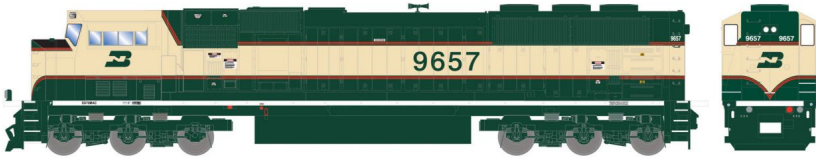

Athearn's September 2016 delivery schedule leads off with a new run of EMD SD70MAC locomotives. Road names for the HO scale Genesis series model will be a Phase III built in 1995 decorated with BNSF wedge patch, a Phase IV locomotive delivered in 1995 with early HTC-R trucks decorated for BN, and a Phase VIa locomotive built in 1998 with late HTC-R trucks and X-panel engine roof doors in Conrail livery.

Also a 1997 Phase VIIa SD70MAC decorated for Paducah & Louisville, a Kansas City Southern Phase VIIIa as delivered in 1999 with late HTC-R trucks and a small EMD plow, and CSX Phase VIIIb built in 1999 with late HTC-R trucks and a large EMD plow. Both full DCC and DCC-ready models with Quick Plug technology will be available.

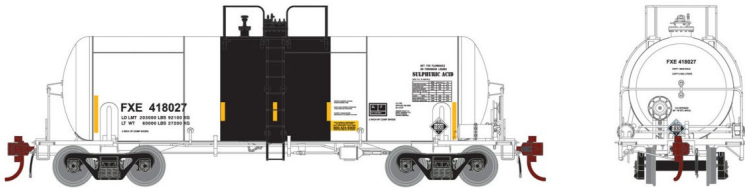

Athearn's September schedule includes a new run of Genesis 13,600 gallon acid tank cars. Road specific details include early or late body phases, different end sills, different top platforms, and different brake systems. All versions feature separately applied details, etched metal walkways, separate wire grabs and hand-rails, uncoupling bars, trainline hoses, and trucks with rotating bearing caps. Road names are GATX-General American Tank Car, KCCX- Kennecott Copper, DUPX-Du Pont, FXE-Ferromex, CHVX-Chevron, and CPDX.

# DECEMBER NEWS | 11



A 33,900 gallon LPG tank car is also due next September. Road names will be CPCX-Chevron Phillips Chemical and UTLX-Union Tank Car in both black and white schemes.



Ready-to-Roll models coming next September include an EMD GP35 diesel locomotive. Tooling for the HO scale model was originally developed by Rail Power Products. It represents a Phase 1a version of the prototype that was produced from October 1963 to February 1964. This was arguably the most widely used variant of the popular GP35. Some of the spotting features of this phase captured on the model include triple louver sets on the battery box covers, open top 36-inch center radiator fans, flat bottom cab number board housing, flat inertial air filter hatch, thick side sill, and low profile fuel tank. In addition to Union Pacific, road names will be Chicago & North Western, Erie Lackawanna, Louisville & Nashville, New York Central, and Rock Island.



American Car & Foundry introduced the Centerflow covered hopper car in the 1960s.

The design relies on the car's rounded body to provide structural

# DECEMBER NEWS | 12

strength without the added weight of bracing, as well as making gravity unloading easier.

The early twin-bay Centerflow prototype had a capacity of 2,970-cu. ft. Athearn's HO scale version is available for Union Pacific (above), Burlington Northern Santa Fe, Erie Lackawanna, The Anderson Rail Group, North American Car, and PQ Corporation. The application of either round or trough hatches will be in accordance with prototype practice. Additional features include detailed discharge outlets, photo-etched metal roof walk, individual wire grab irons and corner steps, detailed brake fixtures including a brake cylinder, valve, air reservoir and appropriate brake plumbing.



Coming under the Athearn-Roundhouse brand is a 40-foot high-cube plug-door boxcar with mostly molded on details. Road names will be Santa Fe, Burlington, CSX, Northern Pacific, Norfolk Southern, and Union Pacific.

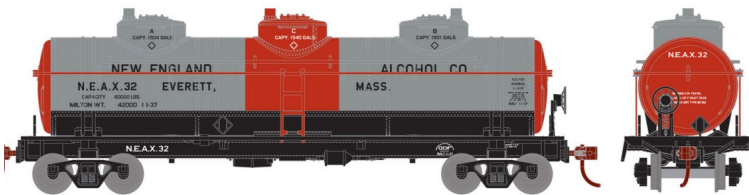

Also a three-dome tank car that

is mildly upgraded from the original model Irv Athearn introduced in 1957. Improvements include better trucks, knuckle couplers, and state-of-the-art decorating and pad printing. Road

## DECEMBER NEWS | 13

.....

names will be Anderson Prichard Oil Corp, Gustafson Bros Oil, Navy Gas & Supply, Panhandle Refining, New England Alcohol, and Sherwood Refining. Additional Ready-to-Roll items coming in September include a Ford F-850 truck with a long-bed for grain service, and three-packs of CIMC 53-foot containers. For more information on Athearn products contact a dealer or visit [athearn.com](http://athearn.com).

.....



**Atlas Model Railroad Company** will release new paint schemes and road numbers for its HO scale Master Line General Electric U23B locomotives during the fourth quarter

of 2016. The four-axle road-switcher of the late 1960s through the mid 1970s will be available with new numbers for Missouri-Kansas-Texas, C&O, Conrail, Norfolk Southern, and Western Pacific. New road names will be Erie Lackawanna and Georgia Central. Undecorated models with a choice of a low or high nose will be included in the run. Atlas Silver series analog DC versions of the locomotive will have an NMRA compatible 8-pin plug to facilitate installation of an aftermarket DCC decoder. Atlas Gold series models will have LokSound Select Dual-Mode decoders that support all DCC programming modes.



The third quarter of 2016 will see the arrival of a new run of Atlas Master Line 50-foot

boxcars. The HO scale model is based on a prototype built by ACF in the late 1960s and early 1970s. The ready-to-run models will be

# DECEMBER NEWS | 14

.....

available with smooth sides decorated for Seaboard System, Louisville & Nashville, Missouri-Kansas-Texas, and Western Maryland. Rib side versions will be available for Conrail PCA, Norfolk Southern, Rock Island, Frisco, and Illinois Terminal.

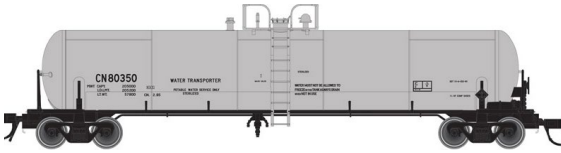

Also coming from Atlas in the third quarter of next year is a new release of GATX 20,700

gallon non-insulated tank cars. The Master Line series ready-to-run HO scale model of the general-purpose, non-insulated, non-pressure tank car prototype will be available with Type 10 saddles decorated for Canadian National and GATX with a Service Driven logo. Cars with Type 20 saddles will be available decorated for DOWX-Dow Chemical, GATX (WX repaint), RTLX-Relco Tank Line, ETCX-Eastman Chemical, S. M. Brooks, and RCRX-Reagent Chemical. Undecorated models of both saddle types will also be available.

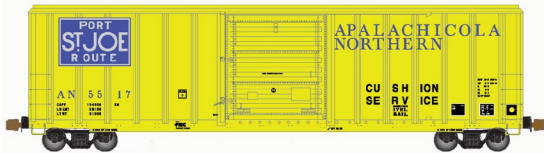

Future projects at Atlas include an FMC 50-foot 5347 cu. ft. boxcar with sliding doors.

No release dates yet but road names under consideration are Apalachicola Northern (Port St. Joe Route slogan), Chicago North Western-Union Pacific, Delta Valley & Southern, Savannah State Docks (Georgia Ports Authority), Mississippi Export Railroad, New Orleans Public Belt Railroad, and Providence & Worcester. For additional information about all Atlas products contact a dealer or visit [atlasrr.com](http://atlasrr.com).





# DECEMBER NEWS | 15

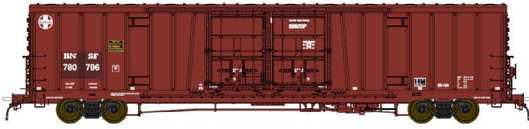

**BLMA** is taking reservations for third quarter delivery of BNSF 62-foot Bx-166 double plug-

door boxcars. Santa Fe built a total of 300 Bx-166 cars in their Topeka, KS shops in 1974. The 62-foot (actual length 61-feet 6-inches) insulated car with two 8-foot insulated plug-doors became the car of choice for beer distribution throughout North America. Spotting features on the prototype include the diagonal braces on either side of the doors. The original livery of the Bx-166 cars was Santa Fe's Indian Red with a large white cross and *Shock Control* slogan. After 20-plus years of service the cars were repainted plain mineral brown.

BLMA will offer the HO scale ready-to-run model in all three repaint schemes including a BNSF patch with small Santa Fe herald in the upper left hand corner (above), and BNSF with round BNSF herald on the right side of the car (below).

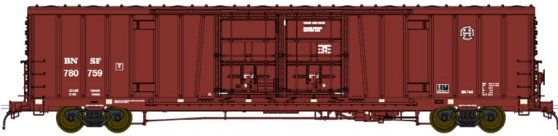

Also a later BNSF repaint with BNSF powerbar logo (see illustration in the N scale

listing on page 34). For additional information contact a dealer or visit [blmamodels.com](http://blmamodels.com).



**Bowser Trains** has released its U-25B diesel locomotive to dealers. The HO scale Executive Line model is

available decorated for GE Demo, Erie-Lackawanna, Conrail (EL

# DECEMBER NEWS | 16

patch), Maine Central, Maine Central (ex Rock Island), Rock Island, The Rock, Santa Fe, Burlington Northern, Chesapeake & Ohio, Oregon California & Eastern, Weyerhaeuser, Southern Pacific, and N de M (Ferrocarriles Nacionales de México).

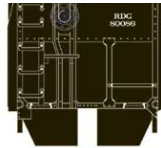
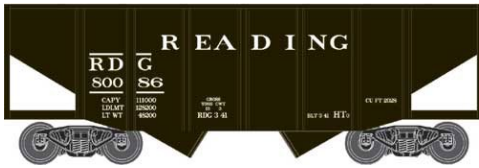

Bowser plans to release a 55-ton fish-belly and U-channel

twin-bay hopper car next summer. The HO scale ready-to-run model will have correct underframe detail including air tank, brake cylinder, and triple valve. Road names will be Reading, Lehigh Valley, Chesapeake & Ohio, Delaware & Hudson, and Western Maryland (with circle). Road names for cars with U channel frames will be Toronto, Hamilton & Buffalo; Boston & Maine; and Pittsburgh & West Virginia. Cars decorated for Atlantic Coast Line and Norfolk & Western will have peaked ends.



Also due from Bowser this summer is a class F30a flat car decorated for PRR, PRR (1950s scheme, above), PRR (1960s scheme), Conrail MOW, Union Pacific, and Lehigh Valley. Both flat and hopper car will be available in three numbers for each road name. For additional information contact a dealer or visit [bowser-trains.com](http://bowser-trains.com).

**Broadway Limited** plans to deliver an HO scale version of the famous Commodore Vanderbilt Hudson steam locomotive next fall. The Case Institute of Technology designed the streamlined shroud that was applied to NYC's 4-6-4 No. 5344. Named in honor of

# DECEMBER NEWS | 17

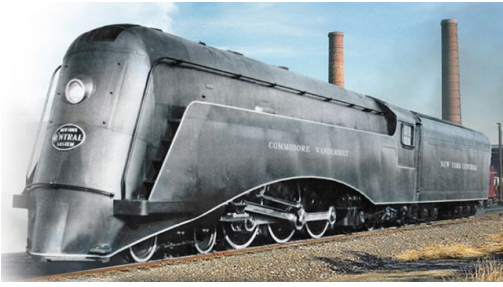

the NYC's controlling owner, the dramatic appearance of the locomotive thrilled viewers at its 1934 debut at Grand Central Terminal. After touring several major cities, No. 5344 was placed

in regular service hauling the 20th Century between New York City and Chicago.

BLI's HO scale version of the Commodore Vanderbilt has a die cast chassis and body. The matching tender has an ABS plastic body on a die cast underframe. The model will be equipped with Paragon3 Rolling Thunder sound system that is operational on both DC and DCC layouts. The MSRP is listed at \$499.99. For complete information contact a dealer or visit [broadway-limited.com](http://broadway-limited.com).



**Con-Cor International** has released its HO scale Christmas car for 2015.

This marks the 39th anniversary of the festive HO scale series which began in 1976.



Con-Cor has also released HO scale Tropicana containers in four different decorating schemes. They include 45-foot containers in the 1980s (left) and 1990s (right) schemes. Each scheme is available in a two-pack at an MSRP of \$31.98.

# DECEMBER NEWS | 18



Tropicana's modern schemes are also available on 53-foot containers. They have an MSRP of \$32.98 for a two pack. For additional information contact a dealer or visit [con-cor.com](http://con-cor.com).



**Downtown Deco** has two new HO scale Hydrocal structure kits. The craftsman style kits include cast walls, color signs, and detailed assembly instructions. Painting and weathering suggestions are also included. The new kits include the Boobie Hatch (4 x 6 inch footprint) and Chop Suey Take-Out (1.5 x 4 inch footprint). For

additional information visit [downtowndeco.com](http://downtowndeco.com).



**ExactRail** has issued a new production run of its FMC 5277 combo-door boxcar. The HO scale ready-to-run model replicates the 70-ton Plate C prototype with

a Stanray X-panel roof, combination 6-foot plug door and 10-foot Youngstown sliding door. Decorating schemes include Railbox (1978 as delivered with 11-panel roof, above).

Cars with 9-panel roofs are available for CN (1984 CNA Patch, above), Railbox (repaint), and CN (1985 wet noodle scheme). For

# DECEMBER NEWS | 19



additional details including ordering information visit [exactrail.com](http://exactrail.com).



**InterMountain Railway** is taking reservations for mid-summer delivery of HO scale EMD F7A and F7B locomotives. Both DC

and DCC versions with and without sound will be available. Road names in this release will be Santa Fe (blue bonnet), Amtrak, Frisco, Reading, Alaska, EMD demonstrator, Burlington Northern (green), and Burlington Northern (green and white hockey stick scheme, above).



Also scheduled for release in June/July 2016 are 1958 cu. ft. twin-bay covered hopper cars with distinctive open sides. Features of the HO scale ready-to-run

model include etched-metal roof walks and individual wire grab irons. Decorating schemes will be Elgin, Joliet Eastern; NAHX-International Minerals; Monon; Delaware & Hudson; Birmingham Southern; Chicago & Eastern Illinois; Jablona Corona; NBS-National Bureau of Standards Scale Test Car; Virginian; and NAHX-Polybor Chlorate. An undecorated kit will also be available.

A group of HO scale A-Line 53-foot smooth-side containers will soon be available decorated for CMRU-Conrail Mercury, APCU-American Presidents Line, and SFTU-Santa Fe. This release will

## DECEMBER NEWS | 20



include a 53-foot Duraplate container for JBHU-J.B.Hunt. Undecorated containers

will be available for both styles. Anyone interested in these products should keep in mind that Intermountain produces models based on advance reservations. For additional information contact a dealer or visit [intermountain-railway.com](http://intermountain-railway.com).



**Kadee's** February 2016 release will include two new 50-foot PS-1 boxcars. Shown above is a Denver & Rio Grande Western version with twin Youngstown doors covering a 15-foot opening. The model is based on a car delivered in 1957 in the original boxcar red.



The second car is decorated for Delaware & Hudson and includes the road's complex multi-colored herald. The car has

a 10-foot six-panel Superior door and a cushion underframe with extended draft gear. All Kadee ready-to-run models come with two-piece self-centering trucks and Kadee #2100 couplers. For more information contact a dealer or visit [kadee.com](http://kadee.com).



Knapp's News Agency is the name of a new HO scale structure kit from **KC's Workshop**. The model is based on a structure formerly located in

# DECEMBER NEWS | 21

Laurel, Maryland. The craftsman-style kit consists of laser-cut components, Northeastern scale lumber, Tichy doors and windows, multiple roofing materials, and BEST detail castings. The assembled structure has a footprint of 7 x 7 inches. Figures and vehicles in the illustration are not included. For more information visit [kcworkshop.com](http://kcworkshop.com).



New neon-style animated HO scale signs available from **Miller Engineering** include this U.S. Army recruiting billboard.

Also new are animated storefront signs for Rexall Drugs, F. W. Woolworth Co., and S&H Green Stamps. For additional information visit [microstru.com](http://microstru.com).



**Monster Model Works** plans to release an HO scale kit for Placerville Garage later this month. MMW owner Jimmy Simmons credits inspiration for the kit to renowned nar-

row gauge modeler Steve Harris who scratchbuilt a model for his Rio Grande Southern layout. Harris based his model on a structure in Placerville, CO near the RGS depot. Weathering tips included in

## DECEMBER NEWS | 22

the kit suggest that the locale of the structure, southwest versus New England for example, can be achieved by altering the color of the stone walls.

The HO scale kit includes 3D laser-engraved block stone sides and corners, 3D printed rooftop vents, laser-cut doors and windows, and peel & stick tarpaper roofing material. Signage, window glazing, instructions and weathering tips complete the kit. The finished structure has a footprint of 6.75 x 8.25 inches. For additional information including ordering instructions visit [monstermodelworks.com](http://monstermodelworks.com).



New HO scale items now available from **Peach Creek Shops** include cast steel ingot car with molds and ingots. These cars were of a common design that served in both open hearth mills and in hot ingot service.



The models are made of a mild resin that is easy to cut, shape and paint. The ingots are translucent orange acrylic and can be lighted. The open hearth ingot cars are sold as a set of two at

\$39.95. The set includes eight ingot molds, eight ingots, eight charging boxes, Kadee wheelsets, and four different ingot cover plates for use when smaller ingot stools are used. The assembled models



**Click here for  
reader comments**



## Who is ScaleTrains.com?

Nineteen months ago, four key people resigned from Athearn and quietly began planning a new company and a new line of model railroad products. Collectively, the talented quartet brings a wealth of model railroad manufacturing experience to the new firm.

Calling themselves ScaleTrains.com, the new enterprise has established a base of operations in the town of Benton in the Blue Ridge Mountains of Tennessee. Heading the team as president is Shane Wilson who was formerly the Athearn brand manager at Horizon Hobby's headquarters in Illinois. Others include Athearn's former product development director Mike Hopkin, an expert in dealing with manufacturing problems and personalities in China, Joe Olvera, a talented graphic designer who managed all of the artwork required for decorating Athearn's immense product line, and product development expert Paul Ellis whose knowledge of prototype details is legendary.

With all of this talent it will be interesting to see what ScaleTrains.com develops over the next few years. A brief video about ScaleTrains.com initial launching can be viewed at [youtube.com/watch?v=1rCRGo46TZk](https://youtube.com/watch?v=1rCRGo46TZk).



From the left, members of the ScaleTrains.com team are Shane Wilson, Mike Hopkin, Paul Ellis, and Joe Olvera.

## DECEMBER NEWS | 24

.....

illustrated here are fitted with Kadee couplers, however, since operators used a wide range of couplers and drawbars for their in-house cars, Peach Creek does not include couplers in their kits. For additional information visit [peachcreekshops.com](http://peachcreekshops.com).

.....



In addition to prototypically accurate rolling stock, **Resin Car Works** will also offer structures called Scene Setters. The initial Scene Setter release is a round corrugated metal grain bin – a common sight throughout the heartland of America. The

prototypes began with a government grain storage program in the 1930s and thousands of these grain bins were installed in towns across the nation. The RCW's HO scale model is a one piece resin casting ready for painting. The bins are priced at \$36.00 for a pack of four plus postage and handling. For additional details including ordering information visit [resincarworks.com/scene.htm](http://resincarworks.com/scene.htm).

.....

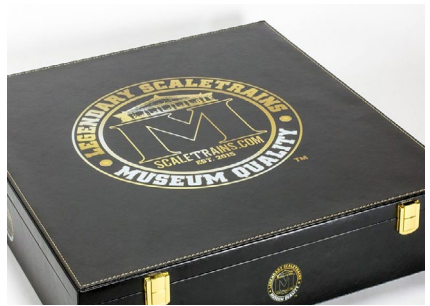

The headline product announced by **ScaleTrains.com** at the recent Trainfest Show is a Union Pacific 8,500 hp GETL (Gas Turbine Electric Locomotive) as built by Alco/GE in the late 1950s.

## DECEMBER NEWS | 25

Thirty of the 180-foot long deafeningly loud jet locomotives operated between Council Bluffs, IA and Ogden UT. ScaleTrains.com HO version will offer the model in two levels of detail: Museum Quality with an exceptional level of detail topped by a deluxe presentation/storage box, and a somewhat more economical Rivet Counter version.

The Rivet Counter edition of the model will have prime mover sound in both the A and B units, multiple dynamic brake configurations, extended fuel tank retrofit, air intake scoops, nose grab iron ladder, Dynavane intake housing, rear MU connections, and separate water hoses between the A and B units.

Museum Quality models will have all of the above features plus selectable white, red, and green classification lights; curve squeal and frog clank sounds; cab interior lighting; a lighted control panel in the cab; and a ground light on the engineer's side. Also operating cab doors with separate door handles, separate rubber MU and electrical buss connections between the A and B units, sliding engine compartment side doors in the B unit, detailed interior with turbine visible inside, and a visible spinning turbine fan blade in the exhaust outlet. Availability for the GETL is scheduled for April 2016.



The Museum Quality locomotive with DCC and

LokSound will have an MSRP of \$899.99 with initial direct pricing at \$724.99. The MSRP of the Rivet Counter locomotive with DCC and LokSound will be \$719.99 with a direct price of \$574.99. The Rivet Counter locomotive without sound has an MSRP of \$529.99 with a direct price of \$424.99.

## DECEMBER NEWS | 26

ScaleTrains.com also introduced a set of Union Pacific water tenders as used by UP on their steam excursions. The prototype tenders have been extensively modified since they originally served as fuel tenders for the turbine locomotives. Visible changes included removing the fuel oil heaters and squaring-off the top corners to increase their water carrying capacity. The Rivet Counter series models are scheduled for release in February 2016. The set has an MSRP of \$149.99 with a direct sale price of \$119.99.



ScaleTrains.com has pledged to include economically priced freight car kits in its mix of products. First up is a kit for an Evans 5100 cu. ft. 8-foot double plug-door boxcar. This is an entry level

model with much of the body detail molded on. An exception is the separately applied brake wheel. The kit comes with body mounted knuckle couplers and ASF Ride Control trucks with machined metal wheelsets. The initial release, available this month in multiple road numbers, includes Burlington Northern, Boston & Maine, Chessie, Conrail, Tropicana, Union Pacific, Vermont Railway, Willamette, and Wisconsin Central. Road names on a second release scheduled for February will be BC Rail, CP, CSX, FEC, GTW, MNS, MP, Ralston Purina, D&RGW, Weyerhaeuser, and undecorated. The Evans 5100 kit has an MSRP of \$17.99 with direct pricing of one to five models at \$13.99 each, six to 11 at \$12.99 and 12 or more at \$12.49 each.

Coming from ScaleTrains.com in January is a ready-to-run HO scale Trinity Rail 31,000 gallon crude oil tank car. The HO scale factory

# DECEMBER NEWS | 27

.....



assembled model will be available in the ScaleTrains.com Operator series as well as in the upgraded Rivet Counter series.

Features common to both series include a decal sheet with additional lettering, and a group of parts the modeler may elect to apply. The Rivet Counter model includes the above features plus etched-metal head-shields, detailed manway cover with protective housing, see-through top and end platforms, simplified underbody brake rigging details, metal anti-personnel rods, detailed tank saddles with defect card holders, metal end sill and corner grab irons, underbody chain and outlet valve, FRA-224 yellow conspicuity striping, and printed hazmat placards.



Both versions of the ready-to-run model come with metal SE Type safety double-shelf knuckle couplers (above), and ASF motion-control 110-ton trucks with 36-inch wheelsets with rotating bearing caps.

The Operator series model will have an MSRP of \$28.99 with a direct price of \$22.99. The Rivet Counter Model has an MSRP of \$48.99 with a direct price of \$38.99. Lower prices are available for both series when purchased in quantity. It is worth noting that ScaleTrains.com is using Tru-Color paint ([trucolorpaint.com/products/paint](http://trucolorpaint.com/products/paint)) on their models which should simplify touch-up and kitbashing for hobbyists. For additional information visit [scaletrains.com](http://scaletrains.com).

.....



## Tangent Scale Models

has introduced a prototypically accurate HO scale model of a General American Transportation Corporation (GATC) 4180 cu. ft. Airslide covered hopper. Although similar in appearance to previous releases, this new model is offered in three distinct variations of the car body and associated details that reflect prototypes built between 1965 and 1980.

Tangent continues its usual attention to detail with such features as see-through bolster arrangements above the trucks and nicely-detailed underframe pipe arrangements and outlets. Also etched-metal see-through running boards, separate air hoses, and machined 36-inch wheelsets. Details specific to the prototype road and date being modeled include different roofs, running boards (Apex or Morton), body side post profiles, high and low brake positions on the B end, different ladder, crossover platform, handrail, and grab iron arrangements.

Decorating schemes include Milwaukee Road (original 1965 gray, above), CACX- Clinton Corn Processing (1969), B&O (original 1968 gray), CNW (original 1976 gray), GACX (1993 GATX blue repaint), GM&O (original 1966 gray), NAHX-IGP Canada (original 1973 gray), SIRX (1990 restenciled IGP Canada), and RTR in gray primer only. An undecorated kit is also available.



Tangent is also offering the 4180 decorated as BNSF buffer car #1 and the slightly different car #2. These models represent

cars that have been changed from revenue service to buffer service for used in crude oil and ethanol trains requiring buffer cars. A buffer car was typically positioned at each end

## DECEMBER NEWS | 29

of such trains. The model includes the gray anti-skid paint on the roof. For additional details including ordering information visit [tangentscalemodels.com](http://tangentscalemodels.com).

.....

**Trainworx**, an established N scale supplier, has entered the HO market with the release of a group of high-cube drop-frame trailers. The models will be based on both corrugated and smooth side 40-foot trailers that are 13-feet 6-inches tall. Corrugated trailers will be available for Great Northern, Union Pacific, Santa Fe, and Milwaukee Road. Smooth side trailers will be available decorated for Illinois Central Gulf, Family Lines, and Norfolk & Western. For additional information visit [train-worx.com](http://train-worx.com).

.....



New products announced by **Walthers** at Trainfest 2015 include a General Electric Evolution series diesel loco-

motive. The all-new Walthers Mainline series model will have the same five-pole skew-wound motor and all-wheel drive as WalthersProto series. Additional features include working front ditch lights and molded drill starter points for grab irons (sold separately). The locomotive will be available with SoundTraxx sound for DCC and DC operation.

Locomotives with a low headlight will be available for BNSF (C4 A1A center idler axle truck), and CSX (steerable truck). Also Union Pacific, Canadian National, and Canadian Pacific with high-adhesion trucks. A Norfolk Southern unit with high headlights and high-adhesion trucks is included in the release.

## DECEMBER NEWS | 30

Standard DC units will have an MSRP of \$129.98. DCC versions will list at \$199.98. Delivery is scheduled for fall 2016.

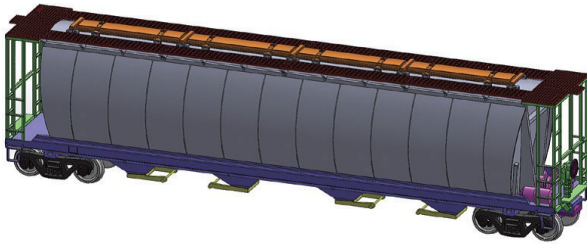

Here is a preliminary CAD drawing of a new 59-foot cylindrical hopper car Walthers has scheduled for release next April. The all-new

ready-to-run model is based on a 4550 cu. ft. prototype built by National Steel Car that was introduced in 1972.



Prototype photo courtesy of Darin Umlauft

Features include see-through running boards, and detailed brake gear, roof hatches, and end ladders. The HO scale

Mainline series model will be available decorated for Canadian Wheat Board, Canadian Wheat Board - Canada, and Saskatchewan Wheat Board. Road names will be available in four numbers at an MSRP of \$24.98 each.



New road names have been announced for the next run of WalthersProto EMD SD45 locomotives

which are scheduled for release in February. Both sound/DCC and analog DC versions will be available for Conrail, CP (1995 dual flag scheme), Santa Fe (1966 as delivered in blue with yellow nose and pin stripe), and Wisconsin Central shown here from a previous production run.



## DECEMBER NEWS | 31

.....



This single track deck girder bridge is the latest addition to Walthers expanding selection of HO scale Cornerstone bridge components. The bridge comes in 30, 50, 70, and 90-foot lengths with MSRP prices ranging from \$17.98 to \$29.98. The bridge can be adapted for either an open or ballasted deck. Delivery is planned for March 2016.

Compatible accessories sold separately include center piers, abutments and Code 83 bridge track.



Walthers is quoting a June release date for a new HO scale 110-foot motorized turntable. The rotating bridge in the Cornerstone series model is fitted with Code 83 rail and will accommodate locomotives up to 15.25-inches long. The

turntable is index programmable for up to 99 different track locations. It comes with a control box and motor. The turntable has an MSRP of \$349.98. A 12-18 volt AC/DC power supply is required (not included). For details on all Walthers products contact a dealer or visit [walthers.com](http://walthers.com).

.....

## N SCALE PRODUCT NEWS

New N scale items coming from **Athearn** next September include a 33,900 gallon LPG tank car. In addition to the CPCX-Chevron Phillips Chemical car shown here, a black car decorated for UTLX-Union Tank Car will also be available. The models have photo-etched metal walkways and end platforms, wire safety and

# DECEMBER NEWS | 32

.....

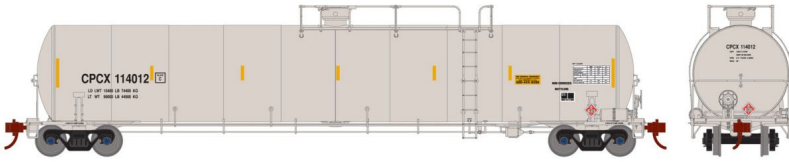

end handrails. Additional features include separately applied walkway platform, manway access, ladders, brake rigging detail, safety rail supports, and tank saddles.



Also due next September are ACF twin-bay 2,970 cu. ft. covered hopper cars. Road

names will be Erie Lackawanna, The Anderson Rail Group, Burlington Northern Santa Fe, North American Car, PQ Corporation, and Union Pacific. The N scale models will have either round or trough hatches depending on the practice of the prototype. Features include photo-etched metal roof walks, separately applied wire grab irons, and screw-mounted trucks with machined metal wheelsets.

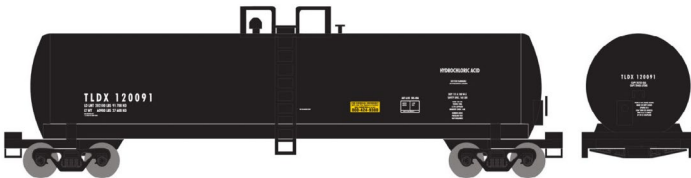

Completing Athearn's N scale releases for next September

is an RTC 20,900 gallon acid tank car. Road names will be Union Tank Car Co. (with tank bodies in both white and black), LLCX Inc., Reagent Chemical & Research Inc., and General Electric Rail Services Corp. For additional information on all Athearn products contact a dealer or visit [athearn.com](http://athearn.com).



## DECEMBER NEWS | 33



**Atlas** has announced road names on the next production run of its N scale GE Dash 8-40 locomotives.

Decorating schemes for the Dash 8-40CW ver-

sion will be BNSF H2, Conrail Quality, Canadian National, Canadian National (IC), CSX (Conrail patch), and Norfolk Southern (Conrail patch). Road names for the Dash 8-40C versions include CSX “YG”, Ferrocarril Nacionales de Mexico, Union Pacific, and Union Pacific “*Building America*” scheme.



The third quarter of 2016 will see the arrival of Atlas 50-foot boxcars that follow prototypes built by ACF in the late 1960s and early 1970s.

The N scale ready-to-run models will be available

with smooth sides decorated for Missouri-Kansas-Texas, Western Maryland, Seaboard System, and Louisville & Nashville.



Rib side versions will be available for Frisco, Conrail PCA, Norfolk Southern, Rock Island, and Illinois Terminal.

Also coming from Atlas in the third quarter of next year is a new production run of GATX 20,700 gallon non-insulated,

# DECEMBER NEWS | 34

.....

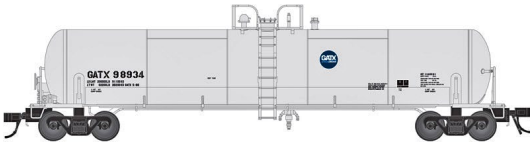

available with Type-10 saddles decorated for Canadian National and GATX with a Service Driven logo (above).

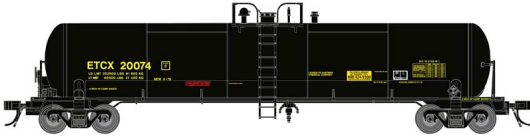

Cars with Type-20 saddles will be available decorated for ETCX-Eastman Chemical, DOWX-Dow Chemical, GATX (WX repaint), RTLX-Relco Tank Line, S. M. Brooks, and RCRX-Reagent Chemical. Undecorated models of both saddle types will also be available. For additional information about Atlas products contact a dealer or visit [atlasrr.com](http://atlasrr.com).

.....



release in late January. Features include separate brake detail, 100-ton ASF Ride Control trucks with 36-inch machined metal wheelsets, and body-mounted knuckle couplers. In addition to the black scheme shown here, the N scale ready-to-run model will also be available with a white tank. A total of 48 road numbers will be offered.

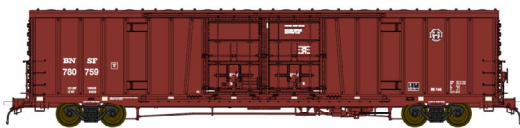

Santa Fe built a total of 300 Bx-166 cars in their Topeka, KS shops in 1974. The 62-foot (actual length 61-feet 6-inches)

Here is a preview look at **BLMA's** 31,000 gallon crude oil tank car tentatively scheduled for

BLMA is taking reservations for third quarter delivery of BNSF 62-foot Bx-166 double plug-door

# DECEMBER NEWS | 35

insulated boxcar with two 8-foot insulated plug-doors became the car of choice for beer distribution throughout North America. A spotting feature of the prototype are the diagonal braces on either side of the doors. The original livery of the Bx-166 cars was Santa Fe's Indian Red with a large white cross and Shock Control slogan. After 20 or more years of service the cars were repainted plain mineral brown.

BLMA will offer an N scale ready-to-run model in all three repaint schemes including a BNSF patch with small Santa Fe herald in the upper left hand corner, and BNSF with round BNSF herald on the right side of the car (see the HO scale listing for illustrations). Also a later BNSF repaint with BNSF powerbar logo (above). For additional information contact a dealer or visit [blmamodels.com](http://blmamodels.com).

.....



**Con-Cor International** has released its N scale Christmas car for 2015.

This marks the 40th anniversary of the festive N scale series which began in 1975.



A very limited run of N scale tri-level auto cars decorated as Santa's Helper is also available.

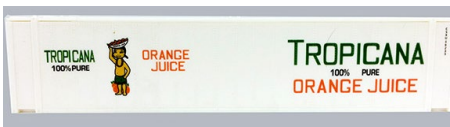

Con -Cor has N scale Tropicana containers in four different decorating schemes. They include 40-foot containers in the 1980s

# DECEMBER NEWS | 36

(left) and 1990s right) schemes. Each scheme is available in a two-pack at an MSRP of \$22.98.



Tropicana's modern decorating schemes are available on 53-foot containers. They have an MSRP of \$22.98 for a pack of two containers. For additional information contact a dealer or visit [concor.com](http://concor.com).

**Downtown Deco** has released a new N scale Hydrocal structure kit named the Boobie Hatch. The craftsman style kit has a 3 x 3.5 inch footprint. Components in the kit include cast walls, color signs, and detailed assembly instructions. Painting and weathering suggestions are also included. To order visit [downtowndeco.com](http://downtowndeco.com).



**Eastern Seaboard Models** has scheduled another release of its 1958 GSC well-cars for January 2016. The ready-to-run N scale model is based on a prototype built by General Steel Castings in 1958. The model consists of an ABS plastic body and a die cast well/underframe, Atlas Barber S-2a truck frames fitted with Fox Valley 28-inch metal wheelsets, and Micro-Trains body-mounted couplers. Road names for the January release will be Delaware & Hudson, New York Central, Penn Central, Conrail, Pennsylvania Railroad, Department of Defense, ESMX, and Allis-Chalmers as shown here. Contact a dealer for additional information on ESM.



**InterMountain Railway** is planning a mid-summer delivery for its N scale EMD F7A and F7B locomotives.

Both DC and DCC versions are in the lineup. This is the first time InterMountain will offer these N scale models with sound. In addition to the Electro-Motive demonstrator scheme shown here, road names in this release include Santa Fe (blue bonnet), Amtrak, Frisco, Reading, Alaska, Burlington Northern (green), and Burlington Northern (green and white hockey stick scheme).

.....



**KatoUSA** reports it will release new N scale versions of SDP40F Type I diesel locomotives next spring. Built by EMD in 1973-74, the prototype SDP40F was the first locomotive built specifically for Amtrak. Based on

the framework of the SD40-2 workhorse, the SDP40F was geared for speed and included steam generators to supply heat and hot water for the passenger equipment it would pull including the ex-Santa Fe El Capitan and Super Chief cars.

Kato will offer two road numbers each in both the Amtrak Phase I (above) and Phase 2 (below) paint schemes. Models in the Phase 1 scheme are expected in April or May of 2016. Phase 2 models will follow about one month later.

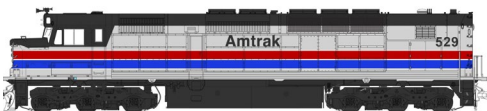

For additional information about KatoUSA products contact a dealer or visit [katousa.com](http://katousa.com).

.....



open hopper car with offset sides. The car features the Chessie cat and comes slightly weathered.



The N scale model rides on six-wheel passenger trucks and is patterned after a prototype built in 1923.



AC&F. The car is classified as a DOT-111-A-100-W-3 tank car which qualifies individual cars to carry commodities such as gasoline or vegetable oils.



Micro-Trains has also released this Western Maryland 50-foot standard box car with double doors. It follows a prototype built by Pullman Standard in 1961 as part of WM's 31051-31065 series cars. Like the prototype, the N scale model rides on roller bearing trucks. For additional information on all Micro-Train Line products contact a dealer or visit [micro-trains.com](http://micro-trains.com).







**NJ International** plans to release an N scale version of a Pennsylvania Railroad Home-Type signal by the end of this year (HO model shown). Item 2046 is priced at \$51.99 each. For additional information visit [njinternational.com](http://njinternational.com).

## NEW DECALS, SIGNS AND FINISHING PRODUCTS

**Correction:** The decals we listed last month from the Illinois Traction Society are for Illinois Terminal, not Illinois Central. We apologize for the error.

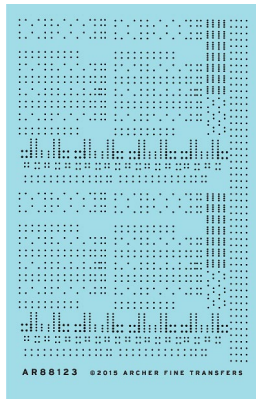
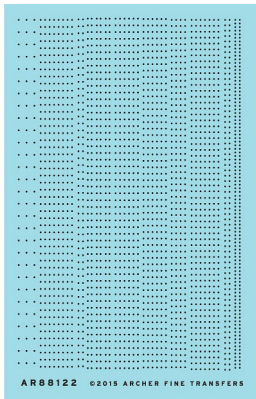

**Archer** has introduced two new rivet detail sets for hopper cars. The patterns were developed from research by prototype modeler Larry King. Archer Rivet set #1 (left) includes both inside and outside rivet patterns for the side stakes, bolster area, and end supports. Set #2 (right) includes rivet patterns for cross ridge at the center side stake, internal cross tie, cross posts, both top and bottom side panels between the stakes inside the car, and top and bottom end sheet patterns. The resin rivet



# DECEMBER NEWS | 41

includes both early and late lettering styles. For information on Microscale decals contact a dealer or visit [microscale.com](http://microscale.com).

Although best known for their authentic O scale decals, **ProtoCraft** also offers prototypically accurate HO scale decals.



Recent HO additions include a lettering set for Southern Pacific class B-50-18/23b steel boxcars circa 1946-1955 (above).



Also Southern Pacific class B-50-18/23c steel boxcars as renumbered in 1955. These and other SP decals offered by ProtoCraft were developed by Rick Leach. For additional information including painting and lettering guidelines and ordering instructions visit [proto-craft.com](http://proto-craft.com).

**San Juan Decals** has On3 D&RGW MOW decals suitable for decorating any of the road's 03000 or 04000 series MOW cars. They are available in either white or black lettering at \$12.95 per set. To order go to [sanjuandecals.com](http://sanjuandecals.com).

**Smokebox Graphics** has HO scale thin-film water-slide decals for Buffalo Creek 40-foot ACF boxcars. Decals for New Haven 40-foot 1937 AAR boxcars available for cars rebuilt in 1955 and decorated in orange scheme with large black

and white “NH”. The BCR and NH lettering sets have sufficient material to decorate two cars. Also available is a Pere Marquette decal set that will decorate up to five cars. The decals cover most PM equipment from mid-1930s through mid-1960s.

Artwork for Smokebox Graphics decals is prepared by digitally tracing in-service photos of actual freight cars. The decal sets include road names, dimensional information, spare numbers, and reweigh/repack data. The decals are printed in Italy by Cartograf. For additional information visit [smokeboxgraphics.com](http://smokeboxgraphics.com).

.....

### SEND US YOUR PRODUCT ANNOUNCEMENTS

If you are a hobby manufacturer with a product announcement, just [click here](#) and submit your announcement to us. Our web site and free magazine reach continues to grow, so get on board this new media train! ■

.....

#### DISCLAIMER .....

The opinions expressed in this column are those of the writer and do not necessarily reflect the opinion of *Model Railroad Hobbyist* or its sponsors. Every effort is made to provide our readers with accurate and responsible news and information, however, neither *Model Railroad Hobbyist* or the writer of this column can be held responsible for any inaccuracies or typographical errors that may inadvertently appear in this column.



## THIS MONTH'S BONUS EXTRAS

MRH SUBSCRIBERS GET ACCESS TO FREE BONUS extras, but you do have to be a subscriber! That's easy because [subscribing is free \(just click this link\)](#).

The bonus extras this month include:

- High quality versions of the issue videos
- Special SP passenger cars addendum to the “More than the Daylight” passenger cars article series

To access the bonus extras, click the link below:

[BONUS DOWNLOADS FOR THIS ISSUE](#)



DID YOU  
KNOW MRH  
SUBSCRIBERS GET  
FREE BONUSES?

CLICK TO SUBSCRIBE NOW - IT'S FREE!



## BRIEFLY NOTED AT PRESS TIME ...

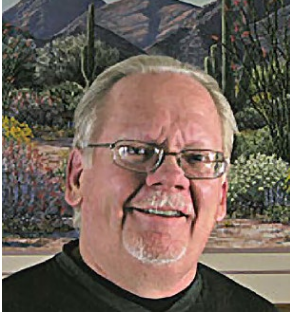

**Verne Glen Niner**, an accomplished author, photographer, and model railroad builder died of a heart attack on November 18, 2015. Niner, who was a contributor to this magazine, was 59 years old. Niner's life-long interest in trains centered on narrow gauge activities in his native Arizona. He incorporat-

ed his affection for the southwest in his modeling in which he successfully blended humor with authenticity. The cover of the 2015 On30 Annual features Niner's Estralla & Sonora Grande Railroad, a sleepy narrow gauge copper hauler in the Sonora Desert. A focal point of the E&SG is the animated town of San Lorenzo which won an award at the 2013 Narrow Gauge Convention in Pasadena, CA. Niner studied at Arizona State University and Boise State University. He and his family lived in Glendale, AZ where he worked as a scrum specialist and technical project manager ...

An early look at **Athearn's** schedule of fall releases includes Genesis GP7/GP9 A and B diesel locomotives decorated for Santa Fe, Erie, Western Maryland, and Denver & Rio Grande Western. The HO scale Ready-to-Roll list of motive power coming from Athearn next October includes P40DC/P42DC diesels decorated for Amtrak Phase V, Amtrak Phase V Big Game Train, Amtrak Phase III, Amtrak Phase III with fading stripes, and Connecticut Department of Transportation.

HO scale 40-foot double sliding-door boxcars, NACC 8,000 gallon tank cars, and 20-foot double-bogy container chassis are

## NOVEMBER NEWS | 44

.....

all on Athearn's October schedule. Items under the Athearn-Roundhouse brand are a 5283 cu. ft. FMC 50-foot double sliding-door boxcar, and a 50-foot flat car with stakes. Both HO and N scale versions of a GATC 2600 cu ft single-bay Airslide covered hopper car and NACC 1960s-era 50-foot outside post boxcar are also due next fall ...

**Rapido Trains** has released its N scale GARX meat reefers to dealers. Complete details are available at [rapidotrains.com/reefer\\_n.html](http://rapidotrains.com/reefer_n.html). Next up are Rapido's HO scale Amtrak F40PH diesel units which should be available early this month ...

**Train Control Systems** has introduced a drop-in decoder specifically designed to fit an N scale Kato ACS-64 locomotive. This decoder is designed to replace the original lighting board for the Kato model. Features include forward and reverse LEDs along with two solder pads for additional light functions and TCS BEMF motor control, customizable lighting effects. For complete information visit [tcsdcc.com/Customer\\_Content/Installation\\_Pictures/N\\_Scale/Kato/ACS-64/Kato%20ACS-64\\_K7D4.html](http://tcsdcc.com/Customer_Content/Installation_Pictures/N_Scale/Kato/ACS-64/Kato%20ACS-64_K7D4.html) ... ■

.....



**Click here for  
reader comments**



# SELECTED EVENTS

## December 2015

*(Please note that many events charge a fee. Check individual info website for details.)*

**CALIFORNIA, BAKERSFIELD**, December 13, Annual open house at Golden Empire Historical & Modeling Society Model Train Club, 1534 19th Street, (Rear entrance behind Chef's Choice Noodle Bar). Info at [gehams.org](http://gehams.org).

**COLORADO, COLORADO SPRINGS**, December 4-6, Train Expo Colorado, at Mortgage Solutions Financial Center, 3660 N. Nevada Ave. Info at [tecoshow.org](http://tecoshow.org).

**COLORADO, LONGMONT**, December 11-13, 38th Annual Model Railroad Expo, at Boulder County Fairgrounds, Hover & Nelson Roads, sponsored by Boulder Model Railroad Club. Info at [bouldermodelrailroadclub.org](http://bouldermodelrailroadclub.org).

**CONNECTICUT, FAIRFIELD**, December 6, 29th Annual Train Show at Fairfield Senior Center, 100 Mona Terrace. Sponsored by Housatonic Model Railway Club. Info at [housatonicmr.org](http://housatonicmr.org).

**FLORIDA, LARGO**, December 12-13, Train Show and Open House sponsored by Suncoast Model Railroad Club. Train Show at Minnreg Hall, 6340 126th Avenue. Club open house at 12355 62nd Street North, Suite A. Free parking at both locations. Info at [suncoastmrrc.com](http://suncoastmrrc.com).



## SELECTED EVENTS | 2

**FLORIDA, THE VILLAGES**, December 17-20, Christmas Train Show, at Colony Cottage Recreation Center, 510 Colony Boulevard. Sponsored by The Villages Railroad Historical Society.

**MARYLAND, BALTIMORE**, December 13, 20, and 27; Baltimore Society of Model Engineers (BSME), Annual open house, at 225 West Saratoga Street, (3rd floor). Info at [modelengineers.com](http://modelengineers.com).

**MARYLAND, CHESTER**, December 5-6 and 12-13, Festival of Trains at Old Kent Narrows Outlet Stores, hosted by Queen Anne Railroad Society and the Museum of Eastern Shore Life. Info at [qarrs.org](http://qarrs.org).

**MASSACHUSETTS, MARLBOROUGH**, December 5-6, Annual New England Model Train Expo, at Best Western Royal Plaza Trade Center, 181 Boston Post Road (US Rte. 20), hosted by NMRA HUB Division. info at [hubdiv.org](http://hubdiv.org).

**NEW JERSEY, CINNAMINSON**, December 5-6 and 27, Open house at Burlington County Model Railroad Club, 808 Pomona Road, (Basement of the Footlighters Playhouse). Info at [bcmrc.org](http://bcmrc.org).

**NEW YORK, ALBANY**, December 6, Great Train Extravaganza, at Empire State Plaza Convention Center. Info at [gtealbany.com](http://gtealbany.com).

**OHIO, LIMA**, December 19, Train Town Show & Swap Meet, sponsored by Division 3, NMRA North Central Region. Allen County Fairgrounds, 2750 Harding Highway. Info at 567-259-3340.

**OHIO, SPRINGFIELD**, December 6, Model Train Show at Clark County Fairgrounds, 4401 South Charleston Pike.

## January 2016

**ARIZONA, TUCSON**, January 8-9, Winter Train Show & Meet, at Tucson Expo Center, 3750 East Irvington Road. Sponsored by Gadsden Pacific Division Toy Train Operating Museum. Info at [gpdToyTrainMuseum.com](http://gpdToyTrainMuseum.com).

**FLORIDA, COCOA BEACH**, January 7-9, Prototype Rail Meet at Cocoa Beach Hilton, 1550 North Atlantic Avenue. Hosted by Mike Brock. Info at [prototyperrails.com](http://prototyperrails.com).

**LOUISIANA, METAIRIE**, January 9, Open House at Crescent City Model Railroad Club at 601 North Lester Avenue. Info at [ccmrc.com](http://ccmrc.com).

**MASSACHUSETTS, WEST SPRINGFIELD**, January 30-31, Railroad Hobby Show, sponsored by Amherst Railway Society, at Eastern States Exposition Fairgrounds, 1305 Memorial Avenue. Info at [railroadhobbyshow.com](http://railroadhobbyshow.com).

**MISSOURI, ST. CHARLES**, January 16, Trainfair, presented by St. Charles Model Railroad Club at Heart of St. Charles Center, 5th and Highway I-70. Info at [stcharlesrailroadclub.org](http://stcharlesrailroadclub.org).

**NEW JERSEY, CINNAMINSON**, January 9-10, 16-17, February 13-14, 20-21; Open House at Burlington County Model Railroad Club, 808 Pomona Road, (Basement of the Footlighter Playhouse). Info at [bcmrc.org](http://bcmrc.org).

**NEW JERSEY, NORTH HALEDON**, January 2-3, 58th Annual Model Railroad Show, at 575 High Mountain Road, sponsored by Garden State Model Railway Club, Info at [gsmrrclub.org](http://gsmrrclub.org).

## SELECTED EVENTS | 4

**WASHINGTON, SEATTLE**, January 16-18, 42nd Annual Train Show, co-sponsored by Pacific Science Center and NMRA PNR Region 4th Division, at Pacific Science Center, Denny and Broad Street. Info at [4dpnr.com/pacific-science-center-show](http://4dpnr.com/pacific-science-center-show).

### Future 2016, by location

**CANADA, BRITISH COLUMBIA, SALMON ARM**, June 15-19, Selkirk Express, NMRA Pacific Northwest Region Annual Convention and Train Show. Info at [selkirkepress2016.ca](http://selkirkepress2016.ca).

**CALIFORNIA, RICHMOND**, June 18, Bay Area Prototype Modelers Meet, at St. David's School Hall, 871 Sonoma Street. Info at [bayareaprototypemodelers.net](http://bayareaprototypemodelers.net).

**CONNECTICUT, ENFIELD**, June 3-4, New England/Northeast Prototype Modelers Meet, at Holiday Inn. Info at [neprototype-meet.com](http://neprototype-meet.com).

**ILLINOIS, COLLINSVILLE (Metro St Louis)**, August 12-13, Tenth Annual St. Louis Railroad Prototype Modeler's Meet, at Gateway Convention Center. Hosted by John Golden, Lonnie Bathurst, Dave Roeder, and Dan Kohlberg. Cosponsored by NMRA Gateway Division. Info at [icg.home.mindspring.com/rpm](http://icg.home.mindspring.com/rpm).

**ILLINOIS, CHICAGO**, October 1-2, Brass Expo, a juried show limited to pre-submitted items including brass models and items relevant to brass models. At The Westin Hotel (Chicago North Shore), 601 N. Milwaukee Ave. Wheeling, IL 60090. Info at [brassexpo.com](http://brassexpo.com).

## SELECTED EVENTS | 5

**INDIANA, INDIANAPOLIS**, July 3-10, NMRA National Convention and National Train Show. Info at [nmra2016.org](http://nmra2016.org).

**IOWA, OTTUMWA**, March 5-6, 25th Annual Train Show, at Quincy Place Mall. Sponsored by Great River Railway Club. Info at [trc.trains.com/events.aspx?page=info&eventid=15850](http://trc.trains.com/events.aspx?page=info&eventid=15850).

**KANSAS, WICHITA**, February 6-7, Train Show & Swap Meet at Cessna Activity Center, 2744 George Washington Blvd. Info from Phil Aylward at [aylward1@cox.net](mailto:aylward1@cox.net).

**MAINE, AUGUSTA**, Sept. 7-10, 36th National Narrow Gauge Convention. Info at [nngc2016.org](http://nngc2016.org).

**PENNSYLVANIA, MALVERN (Metro Philadelphia)**, March 18-20, Seventh Annual Valley Forge Railroad Prototype Modelers Meet at Desmond Hotel. Info at [rpmvalleyforge.com](http://rpmvalleyforge.com).

**UTAH, OGDEN**, March 4-6, Model Railroad Festival sponsored by Hostlers Model Railroad Club, at Ogden Union Station, at 25th Street and Wall Avenue. Info at [hostlers.info](http://hostlers.info).

**VIRGINIA, FREDERICKBURG**, September 23-24, Mid-Atlantic Prototype Modelers Meet, at Wingate by Wyndham  
NEED ADDRESS, Info at [marpm.org](http://marpm.org).

### Future 2017 and beyond (by location)

**AUSTRALIA, VICTORIA, GEELONG**, April 14-16, 2017, 13th Annual Australian Narrow Gauge Convention. Info at [austnar-rowgaugeconvention.com](http://austnar-rowgaugeconvention.com).

**COLORADO, DENVER**, August 30-September 2, 2017, National Narrow Gauge Convention, at Marriott Denver Tech Center Hotel.

## SELECTED EVENTS | 6

**FLORIDA, ORLANDO**, July 30-Aug 5, 2017, NMRA National Convention.

**MISSOURI, KANSAS CITY**, August 5-12, 2018, NMRA National Convention. ■



**Click here for  
reader comments**

**Did you know MRH readers  
have built a free MRH index  
you can search?** *click  
here*

# Clickable advertiser index – 1

[Accu-Lites](#)

[American Ltd \(San Juan\)](#)

[ANE Models](#)

[Archer Fine Transfers](#)

[Amherst Railway Society](#)

[Athearn](#)

[Atlas Model Railroad Co.](#)

[Bachmann](#)

[Bachrus](#)

[Backdrop Junction](#)

[Berrett Hill Trains](#)

[Black Cat Publishing](#)

[Blair Line](#)

[BLMA](#)

[Bowser](#)

[Caboose Hobbies](#)

[Canadian Railway Modeler](#)

[Canyon Creek Scenics](#)

[Clever Models](#)

[Coastmans Scenic Products](#)

[Coffman Graphics](#)

[Con-Cor \(E-Auction-Club\)](#)

[Credit Valley Railway](#)

[Digitrax \(2 page spread\)](#)

[East Penn Traction Club](#)

[ESU LokSound](#)

[Fast Tracks](#)

[Fifer Hobby Supply](#)

[Fox Valley Models](#)

[George's Trains](#)

[GLX Scale Models](#)

[Great Decals](#)

[HO Diesel Supply](#)

[Hobby-On \(MRS Hobby\)](#)

[Iowa Scaled Engineering](#)

[Iwata-Medea](#)

[Jelsma Graphics](#)

[KC's Workshop](#)

[Ken Patterson.com](#)

[Lights 4 Models](#)

[Litchfield Station](#)

[Logic Rail Technologies](#)

[Microscale](#)

[Model Railroad Benchwork \(1\)](#)

[Model Railroad Benchwork \(2\)](#)

[Model Rectifier Corp.](#)

[Motrak Models](#)

[Mountain Subdivision Hobbies \(1\)](#)

[Mountain Subdivision Hobbies \(2\)](#)

[MRH Store \(1\)](#)

[MRH Store \(2\)](#)

[MRH Store \(3\)](#)

[MRH Store \(4\)](#)

[Mr. Detail Parts](#)

[Nano-Oil](#)

[NCE \(2 page spread\)](#)

[Nick & Nora Design](#)

[North American Railcar](#)

[Pre-Size Model Specialities](#)

[Precision Design Co.](#)

[RailMaster Hobbies](#)

[Railroad Explorer](#)

[Rapido \(1\)](#)

[Rapido \(2\)](#)

# Clickable advertiser index – 2

[Ring Engineering \(1\)](#)

[Ring Engineering \(2\)](#)

[Rulers-of-the-World](#)

[Rusty Stumps](#)

[Scale Trains \(2 page spread\)](#)

[Scotty Mason Show](#)

[Smokebox Grapics](#)

[Soundtraxx \(Blackstone\)](#)

[Southern Digital](#)

[Streamlined Backshop](#)

[TAM Valley Depot](#)

[Tony's Train Exchange](#)

[Train Show Inc.](#)

[TrainMasters TV \(1\)](#)

[TrainMasters TV \(2\)](#)

[Traintek](#)

[True Scene Modeling](#)

[TSG Multimedia](#)

[Vector Cut](#)

[Walthers](#)

[Westerfield Models](#)

[Yankee Dabbler](#)

[Yarmouth Model Works](#)

# Clickable “other” index

---

[Other – Bonus Extras](#)

[Other – Cover](#)

[Other – Derailments](#)

[Other – Hobby Marketplace](#)

[Other – MRH Sponsors](#)

[Other – Staff Notes](#)

[Other – Table of Contents](#)

# DOWNLOAD ISSUE



DOWNLOAD PORTRAIT



DOWNLOAD LANDSCAPE



# REVERSE RUNNING

commentary

BEN KAUR  
.....



[Click here for  
reader comments](#)

## BUY THAT OLD LAYOUT!

**EVERY ONCE IN** awhile we happen upon the rarest score in this hobby, a completed layout.

There before you is a swirling empire fit for a mogul, every bit as cumbersome and cantankerous as an old beat-up aircraft carrier! And now they want to sell it.



Meanwhile, you're drawing up layout after layout, dreaming about the great grand railroad. Your visions include yards, industrial districts, sprawling cities, mountain ranges crossed by magnificent bridges. Someday, you will build it under your very own roof! But when opportunity, arose my solution was to *buy it!*

▶ STEPPING OUTSIDE THE BOX WITH A CONTRARY VIEW



A fully functional club layout represents a tremendous opportunity. The track has been tested and the operational capabilities of the line are known.

The club has probably spent years composing this masterpiece, and if they are like the astute modeler who loves flawless operation, you may be looking at high-quality goods. Best of all, the whole thing is already assembled, just waiting for a new home – your home!

This isn't without liabilities, of course. First, you need the space to dock an aircraft carrier and you may only have a little pond. You have to physically move the beast. You could also inherit every headache that was in that old plan. As the new owner of this layout, however, you become “chairman of the board” and can resolve those old issues however you choose!

Some parts you'll be able save intact. Others may need a “demolition study” in selective compression. Still other parts may simply need to be stripped like an old dead carcass as you salvage your investment as best you can. It is your layout now and it's now your responsibility to get it up and running!

Sacrilege to buy instead of build? Perhaps. At the end of the day, though, it is but a layout. If you do your homework and you're skilled at salvage, a little research into the infrastructure of a large layout for sale could represent a golden opportunity for quickly getting a layout of your own!

Give buying an old layout a second look, and compare how much it might cost you to attempt the same project from scratch. When the club puts a layout up for sale, their labor becomes your next potential chainsaw – so buy that old layout!

That's what I did.

See this thread on the MRH website:

**[I bought the club layout. \[mrhmag.com/node/23523\]](https://mrhmag.com/node/23523)**



# DERAILMENTS



## SNOW TRAIN ...

No it's not a a bizarre or humorous video, but we do think this video is a bit unusual for our modern times – steam and snow. A great railfan video for the christmas holiday!

Posted on YouTube by [Jason Lowe Photography](#).

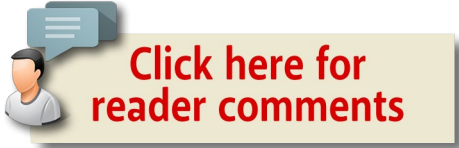

▶ BIZARRE FACTS AND HUMOR (SUPPOSEDLY)

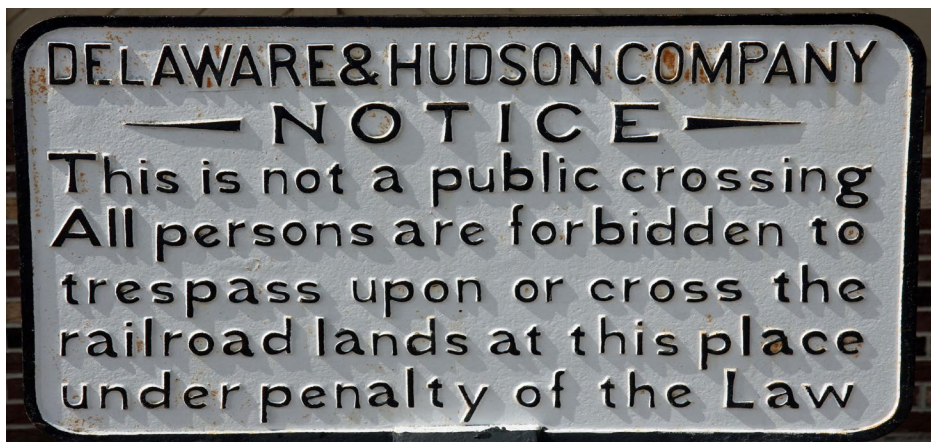

## Railroad sign written by lawyers?

### GET PAID ...

If you're the first to submit a bit of good humor or bizarre facts and we use it, it's worth \$25! Just send to [derailments@mrhmag.com](mailto:derailments@mrhmag.com) ■

### Coming next issue ...

- Celebrating 25 years on Joe Fugate's Siskiyou Line
- Build an On30 wood hopper
- Geoff Bunza's working cranes, part 2
- Emery Falls N scale modules
- Make your own ballast
- And lots more ...

