

HAVING FUN WITH TRAINS

OCTOBER 2015 | FREE

MRH

MODEL RAILROAD HOBBYIST

Clark Propst builds
and operates

Allied Mills

>> READ NOW

ALSO:

- AAR open top loads
- SP&S switching layout
- SketchUp & 3D printing
- Realistic paper structures
- Using forced perspective

... and lots more inside!



STANDARD EDITION | PORTRAIT



DOWNLOAD

BLMA MODELS

DON'T FORGET

Your Juice!

64' TROPICANA REEFER



HO & N

CLICK HERE TO SEE MORE



MRHMAG.COM

- [TABLE OF CONTENTS](#)
- [INDEX](#)



STAFF CREDITS

Front cover: Clark Propst selected Allied Mills as a modular mini-layout experiment to see if a “single element” layout could be engaging. Read what Clark learned from his project in this month’s cover story.



ISSN 2152-7423

Editorial Staff

Joe D. Fugate, Publisher and Editor

Don Hanley, Assistant Editor

Production

Patty Fugate, pasteup and layout

Joe Brugger, copy editing

Mike Dodd, copy editing

Technical Assistants

Jeff Shultz

Jimmy Simmons

Advertising

Les Halmos, Account Manager

Daniel Nava, Advertising Assistant

Jean-François Delisle, Marketing Assistant

Columnists

Richard Bale, News and events

Jeff Shultz, News and events

Les Halmos, Modular railroading

Larry Smith, Narrow Gauge/Shortlines

Bruce Petrarca, DCC

Ken Patterson, Reporter at large

Special Correspondents

Joe Brugger, Questions & answers

Charlie Comstock, Contributing editor

Issue password: Oct2015

Published for the glory of God. [What's this?](#)



MRH SPONSORS

A - E



acculites.com



americanlimitedmodels.com



railroadhobbyshow.com



anemodel.com



archertransfers.com



athearn.com



www.atlasrr.com



bachmanntrains.com



bachrus.com



backdropjunction.com

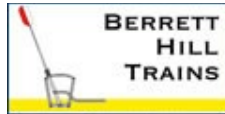

berretthill.com/trains



blairline.com



blmamodels.com



bowser-trains.com



caboosehobbies.com



coffmaneng.com



conco.com



conco.com



www.digitrax.com



esu.eu/en

[Vendors: Get your clickable logo here ...](#)

MRH SPONSORS | 2

F - R



www.handlaidtrack.com



fiferhobby.com



foxvalleymodels.com



glxscalemodels.com



georgestrains.com



www.hobby-on.com



www.iascaled.com



iwata-medea.com



litchfieldstation.com



microscale.com



model-trains-video.com



modeltechstudios.com



stores.ebay.com/Motrak-Models



mthtrains.com



nano-oil.com/Model%20Railroad.html



ncedcc.com



nickandnoradesigns.com



www.pwrs.ca/main.php



railmasterhobbies.com



rapidotrains.com



ringengineering.com



rr-cirkits.com



rslaserkits.com



rustystumps.com

[Vendors: Get your clickable logo here ...](#)

MRH SPONSORS | 3

S - Z



sanjuancarco.com



signaturepress.com



soundtraxx.com



sodigi.com

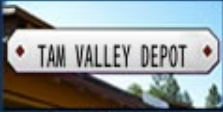

tamvalleydepot.com



tonystains.com



trainfest.com



traintekllc.com



walthers.com



yankeedabbler.com

[Vendors: Get your clickable logo here ...](#)

Looking for something? Check our Hobby Marketplace!

The screenshot shows a grid of advertisements for hobby-related products. Key items include:

- Mr. Detail Parts**: Bulk Packs and Bundles Now Available.
- BranchWork**: Precision Branchwork, Librable Branchwork, and Librable Branchwork starting at \$24.
- Trees**: "SUGAR COBE" SPEAKERS, 4 Sizes • 4 Models, "Sweet" Speaker Option!
- CLAYB**: Customized Building Kits.
- Yarmouth Model Works**: Various model kits.
- FREE SHIPPING!**: on all USA orders over \$20.

Take me there!

Nano-Oil™

Made in U.S.A.

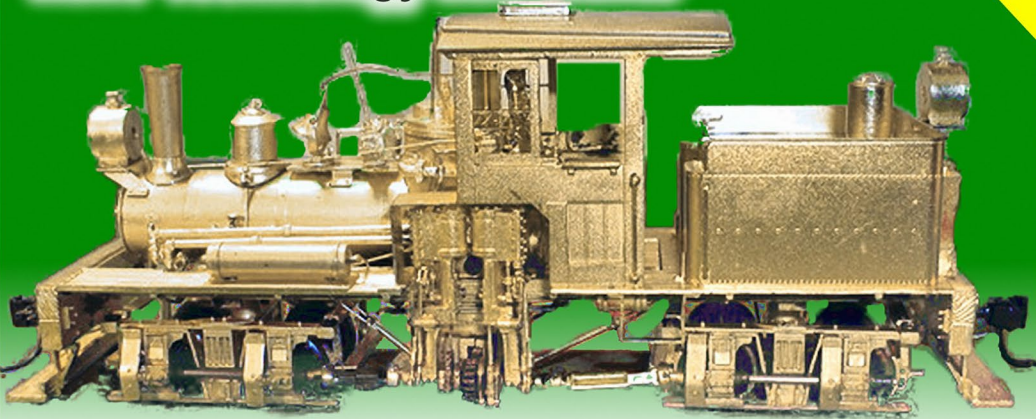
**New
Innovation****Nano Technology Lubricants**

"After eight years of extensive testing, the only lubricants now used in my shop are Nano-Oils and Nano-Grease. The extreme reduction in power draw by mechanically minimizing friction is simply technologically superior."

- Phil Floyd, 'The Shay Fixer'

**Nano-Grease**

**For more details
click here ...**

**THE SHAY FIXER**

VISIT US AT...

SHAYFIXER.COM

Specializing in brass Pacific Fast Mail / United geared locomotives

MRHMAG.COM

- **TABLE OF CONTENTS**
- **INDEX**



TABLE OF CONTENTS

FEATURES

Allied Mills diorama

CLARK PROPST

An engaging mini-layout project



AAR open top loads

DOUG FORBES

Prototypically accurate loads for your flatcars



SP&S switching layout

GREG BAKER

Prototype railroader's layout for student conductors



Building Marshfield Hills

MICHAEL TYLICK

Using selective compression effectively in scenes



Carissa Saloon

DOUG DICKSON

Making impressive structures with paper



ALSO: Hobby Marketplace | Bonus downloads

TABLE OF CONTENTS | 2

COLUMNS

MRH Q-A-T: Model momentum with DCC, and more ...
compiled by JOE BRUGGER

DCC Impulses: SoundTraxx Econami decoders
BRUCE PETRARCA

Getting Real: Intro to SketchUp and 3D printing
JACK BURGESS

What's Neat: St. Louis RPM, modeling from above, ...
KEN PATTERSON

Imagineering: Creating a signature scene
MICHAEL TONDEE

Photo feature: Yes, it's a model
compiled by DON HANLEY

Derailments: Bizarre facts & humor
compiled by the MRH STAFF

NEWS and EDITORIAL

Publisher's Musings: Doing layouts - time for TOMA?
JOE FUGATE

Staff Notes: New Allagash railfanning series ...
compiled by the MRH STAFF

News & Events: October 2015
RICHARD BALE & JEFF SHULTZ

Reverse Running: Ruining the view with a masterpiece
JOE FUGATE

MAKE THE PAST
Come Alive

— ATHEARN TRAIN SETS —



NEW PAINT SCHEMES MEMORIES FROM A GOLDEN AGE

Transport yourself to a time when trains were lead by the legendary Warbonnet diesels and the Iron Horse's lonely whistled echoed through the night. Sharing these memories with the next generation through an Athearn Model Train Set makes the holiday season unforgettable.

TRAIN SETS: \$209.99

- ATH29308 HO Warbonnet Train Set, SF
- ATH29309 HO GP38-2 Iron Horse Train Set, ARR
- ATH29310 HO GP50 Iron Horse Train Set, NS/Eco
- ATH29311 HO GP38-2 Iron Horse Train Set, GT/Bicentennial
- ATH29312 HO GP38-2 Iron Horse Train Set, UP/Lightning Stripe
- ATH29313 HO GP38-2 Iron Horse Train Set, CPR/Flags
- ATH29314 HO GP50 Iron Horse Train Set, BNSF/Power Bar
- ATH29315 HO GP38-2 Iron Horse Train Set, NdeM

Visit athearn.com for more details!



VISIT
Your Local Retailer

CLICK
Athearn.com

CALL
1.800.338.4639

SERIOUS FUN[®]

©2015 Horizon Hobby, LLC. Athearn, Generic, Ready To Roll, Trains in Miniature, Serious Fun and the Horizon Hobby logo are trademarks or registered trademarks of Horizon Hobby, LLC. The Union Pacific mark and other marks owned by Union Pacific are made under trademark license from Union Pacific Railroad Company. All other trademarks, service marks and logos are property of their respective owners. Final models may vary slightly from photos shown. 50/92



PUBLISHER'S MUSINGS

editorial

JOE FUGATE



[Click here for
reader comments](#)

DOING LAYOUTS: TIME FOR TOMA?

THE PROCESS OF DOING A MODEL RAILROAD

layout has come a long way since the early days in the first half of the previous century. The layouts in the 1930s and 40s filled a room with a big table and generally covered it with as much track as possible.

Access on such layouts was always a problem, which is one reason why I think layout benchwork construction methods (and scenery methods) from that time put a high value on making the layout sturdy enough you could walk on it – because you just might need to do that. Or, barring that, locating numerous access hatches around the layout was a necessity.

As the hobby progressed into the 1950s and 60s, it began to dawn on layout designers that railroads are inherently linear, and thinking “shelf” rather than “table” had a lot of merits, not the least of which is access.

But beyond access, there's also being up close to the trains and being able to enjoy them more. Walkaround layout design became a hot topic in the '50s and '60s.

PUBLISHER'S MUSINGS | 2

As the 1970s and 80s unfolded, we had the proto-freelance and railroad prototype modeling movements take hold, and the concept of staging – connecting the layout to the outside world – became state-of-the-art.

Along with this, the Layout Design Special Interest Group (LDSIG for short) was born. This group advocated “linear design” as the preferred way to design a layout. With linear design, the mainline runs through the scene only once - not two, three, or four times as had been done previously. John Allen's Gorre & Daphetid was a prime example of older non-linear layout design, since it had the main going through the scene four times.

Then, in the '90s and early 2000s, multi-deck designs came into vogue, to allow a linear layout design to get more layout into a given floor space. One such multideck variation, the

ADVERTISEMENT

Check Out Atlas' October Announcements including....

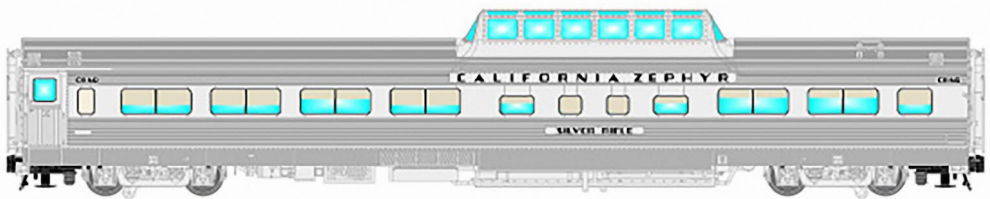

The FINAL car of the California Zephyr train - the Dome Car with Conductor's Window!

ORDER NOW!

MRHMAG.COM

- TABLE OF CONTENTS
- INDEX

FL9



**Order deadline
October 15, 2015!**



Lasercut structures. Highway, storefront and billboard signs.

NEW KIT in HO & N!

GREEN DOOR LOUNGE



WHAT'S NEW?



HO-N-O scales
Blair Line



All 20 Years Plus of Canadian Railway Modeller Magazine on DVD!

BONUS: All 12 Issues of Railfan Canada

- Contents Searchable • PC/Mac Compatible
- Includes All Ads, Departments & Articles
- Every Issue Since Train 1 Track 1 – 116 Issues!

\$69⁹⁵
CDN

Order before Nov.15

Click here to order

PUBLISHER'S MUSINGS | 3

mushroom (the two decks face opposite directions), also came to the hobby's attention.

Where does this leave us? What's the next development in our approach to doing a layout?

I believe the day of filling the layout room with benchwork needs to change. It's time to build a layout in small sections at the workbench, and all along the way have a finished, operational layout in the layout room.

That's why we've commissioned the "One Module" Challenge Contest. We'd like some of the brightest and best of you to put your thinking caps on and re-invent doing a layout, and help the art of doing layouts progress to the next level.

The main idea with *The "One Module" Approach* (TOMA) is to build a layout of any size in portable sections, starting



**N SCALE PRR K4s 4-6-2 PACIFIC with DCC-SOUND:
SUPERIOR CONSTRUCTION AT A SOUND VALUE PRICE**

The K4s 4-6-2 is now available in Bachmann's line of N scale DCC sound-equipped locomotives with our Sound Value *SoundTraxx*® steam package that includes authentic prototypical chuff, short and long whistles, bell, air pump, steam release, and blower—all in 16-bit polyphonic sound. This engine also features a die-cast chassis, precision motor, and finescale detailing. Front-end details vary per prototype with the Pre-War K4 models, based on a World War I-era model, having the distinctive "chicken coop" slat pilots, while the Post-War versions are equipped with modern pilots. Visit your favorite hobby dealer to enjoy this superior sound-equipped steam engine at a Sound Value price!

K4 features include:

- DCC sound-equipped
- precision motor
- die-cast chassis and boiler
- front-end details (headlight, generator, pilot, number plate, marker lights) per prototype
- precision machined brass flywheel
- all-wheel pickup in engine drivers and stanchion
- separately applied metal handrails and tanchions
- LED headlight
- metal wheels and siderods
- metal cut levers
- see-through frame
- NMRA RP25 wheel profiles
- super detailed parts including machined brass safety valves and separately applied tender ladders
- magnetically operated *E-Z Mate*® Mark II couplers

SHIPPING NOW • MSRP \$399.00



PRR POST-WAR
with MODERN PILOT #1361
Item No. 52851



PRR POST-WAR
with MODERN PILOT #3750
Item No. 52852

Click for
more info



PRR PRE-WAR
with SLAT PILOT #5448
Item No. 52853



PRR PRE-WAR
BRUNSWICK GREEN #5440
Item No. 52854



Bachmann Industries, Inc. • 1400 East Erie Avenue • Philadelphia, PA 19124 USA • www.bachmanntrains.com

Click to learn more.

MRHMAG.COM

- **TABLE OF CONTENTS**
- **INDEX**

with the first section. Build that first section to completion, complete with scenery, at the workbench.

Then move it into the layout room (that's why portable is important), attach flattop staging on each end, and run some trains through your newly completed scene. Want more layout? Fine, design and build a second module at the workbench, attach it to the first, and move the staging down to the end of the new module.

David Barrow proposed his "dominos" approach to doing a layout in the '90s, and Tony Koester introduced the idea of Layout Design Elements (or LDEs) about the same time.

TOMA builds on these concepts, bringing them to full flower for today's modern "microwave" society. I believe this is *the way* to do a layout in the 21st century. It's the ultimate modern scope management approach to doing a layout. You build layout until you want to quit and yet you have an operational layout in the train room that you don't need to apologize for.

TOMA also forces you to do a layout without over-committing. It's much harder to bite off more than you can chew, since you're now doing the layout in bite-sized chunks.

I also like how TOMA can adapt to your journey in the hobby. As your skills grow, you can replace a previous module with a better one. If your interests change, no problem. Swap out a few modules for something different.

Some of us are by nature builders. Once the layout gets close to finished, the builder wants to tear it out and build something new. With TOMA, you can replace modules with new ones indefinitely if you wish.

I also know if I were starting over on my own home layout, I'd use TOMA. In fact, I'm thinking of upgrading a bit of the Siskiyou

PUBLISHER'S MUSINGS | 5

Line, and TOMA looks like an especially intriguing approach. As I age, building the layout a manageable piece at a time at the workbench looks a lot more appealing and a lot more fun, too!



**Click here for
reader comments**

NICK & NORA DESIGNS
Uniquely inspired craftsman kits



Craftsman Structure Kits,
Detail Parts, Shingles & More!
www.nickandnoradesigns.com

Nick & Nora Designs
a division of
TMB Custom Models

LIKE US ON  **facebook**



ADVERTISEMENT



**CABOOSE
HOBBIES**
WORLD FAMOUS
MODEL TRAIN STORE
Since 1938!

**The World's
Largest
Model Train Store!**

Model trains G to Z, DCC, brass models, kits, RTR, collectable models, scenery, structures, books, magazines, DVD's, hobby tools & supplies and a full service repair department.

WWW.CABOOSEHOBBIES.COM



MRHMAG.COM

- **TABLE OF CONTENTS**
- **INDEX**

MRH CONTEST: THE "ONE MODULE" CHALLENGE



GOAL: Design the first "module section" for a sectional home layout design.

Hypothetical room is 12' x 15'

NOTE: This is a sectional home layout design, *no modular standard* required.

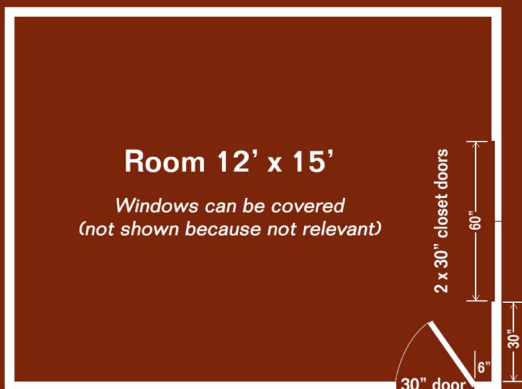

CONTEST RULES

ENTRY DEADLINE: January 31, 2016

- Module must be 18"-24" in depth and 60"-84" in length.
- Scale: Z, N, TT, HO, S, O - standard and/or narrow gauges.
- Connectable to a flattop staging section (or additional layout sections later) at each end. Design the two flattop staging yards with 3 to 8 staging tracks of at least 70" long.
- Rough out the outlines of the other layout module sections to be built for the entire room. No track plan needed, just an outline of the modules in the room is sufficient.
- Describe the theme, era (if any), and rationale for the module and its place in the layout that would eventually fill the room.
- Can follow a specific module standard (like Free-Mo) if desired, but that is not a requirement. Each module can be custom and only mate with an adjacent module.
- Module support method and height is up to you, but please describe it.
- Must be wired for either DC or DCC. Describe how you would interconnect the wiring.
- As the first module of a sectional home layout design, making the module removable once completed is not required, but innovation here will get extra points.
- As to construction methods & materials, surprise us. Extra points awarded for innovation.
- Include pricing for the module. There's no need to build it, this is a design contest. This includes module benchwork, legs, backdrop, roadbed, trackwork, wiring, scenery materials, structures, and details. Do not include a DCC system, rolling stock, or locos.
- The best submissions will be published, so extra points will be awarded for high quality text, illustrations, photos, and captions. Winners will get a bonus payment rate.

SUBMIT ENTRY (Choose "Contest entry")



STAFF NOTES



[Click here for
reader comments](#)



ALLAGASH Railfan Video Series

NEW ALLAGASH RAILFANNING SERIES ... AND MORE

WHAT'S IT LIKE TO RAILFAN A MODEL RAILROAD

as if it was a real railroad? That's the premise behind the new Allagash Railfan video series, coming this month to TrainMasters TV and the MRH Store.

We're presenting the series as a collection of volumes, each about 30 minutes long. Each video closely examines Allagash operations, visiting much of the scenic state of Maine in the process. We're releasing volumes 1 and 2 first, with more volumes to follow later on.

STAFF NOTES | 2

In volume 1, we spend a day track-side at New Sharon with the New Sharon switcher. You get to rail-fan working New Sharon Yard, and switching local customers like Franklin County Feeds. We'll also witness the daily road trains on the AGR's Kennebec subdivision, including some that work New Sharon, picking up and setting out cars for the local industries. The locos are varied and interesting, including Alcos from the Allagash and the Delaware & Hudson.



In volume 2, we follow coal trains over the Allagash. We chase trains across the entire scenic line both directions, getting to enjoy many of the Allagash's highlights. You'll get to see big coal trains passing through classic small town Maine, and we'll witness coal trains threading the deep rock cut at Holman Summit. Enjoy the excitement and drama of big-time railroading as we chase coal trains in volume 2 of the Allagash Railfan series.



[Click here to watch a preview.](#)

As we stated earlier, this series will be simultaneously released to TrainMasters TV and to the MRH Store as downloads or as



LAST ISSUE'S RATINGS

The five top-rated articles in the [September 2015 issue](#) of *Model Railroad Hobbyist* are:

- 4.7 Adding fall color to the railroad
- 4.6 What's Neat: Build a building, sandblast an engine, and more
- 4.4 DCC Impulses: DCC throttles
- 4.4 Lite and Narrow: The Woodward Iron Railroad
- 4.4 Re-weathering a 35-year-old-RS-2

Issue overall: **4.4**

Please rate the articles! Click the reader comments button on each article and select the star rating you think each article deserves. Thanks! ■

ADVERTISEMENT

Also coming to
TMTV in
October

Release date: **October 15th**

DVD media
VOL 1 & 2
DVD set ~~19.99~~
\$15.99
+ shipping/handling

ALLAGASH
Railfan Video Series
VOLUME 1:
Trackside at New Sharon

ALLAGASH

- Running time: 29 min
- New Sharon yard switching
- Working local industries
- Road trains through New Sharon



Railfan New Sharon yard for a day

ALLAGASH
Railfan Video Series
VOLUME 2:
Chasing coal trains

ALLAGASH

- Running time: 30 min
- Follow various Allagash coal trains
- See spectacular scenic Maine
- Witness dramatic Holman Summit



Railfan coal trains across Maine

Instant download
HD format

Volume 1 **\$4.99**

Volume 2 **\$4.99**

Get both
VOL 1 & 2 **\$8.99**
SAVE!

Get the ALLAGASH RAILFAN Videos

from the
Model Railroad
Hobbyist *Store*

MRHMAG.COM

- [TABLE OF CONTENTS](#)
- [INDEX](#)

STAFF NOTES | 4

a DVD later this month. You'll be able to buy downloads of volumes 1 and 2 separately or together (at a discount), and we'll be putting both volumes 1 and 2 together on a single DVD.

We've never seen the Allagash looking better, and there are many newly completed layout scenes featured in the series.

"One Module" Challenge Clarifications

After announcing the "One Module" Challenge contest last month, we've received a number of questions about it. Here are some answers to clarify how the contest works.

If you want to design a layout that terminates on one end in a stub-end terminal, that's fine, but we want you to choose and do the detailed design on one of the other modules on the layout that has connecting track at both ends and therefore needs the

ADVERTISEMENT



Archer
FINE TRANSFERS
PROUDLY SERVING MODEL BUILDERS SINCE 1989

THE ORIGINAL
SURFACE DETAILS™

WE NOW HAVE MORE THAN 100 SHEETS OF RIVETS, LOUVERS, TREADPLATE AND MORE CAST ONTO MICROSCALE CLEAR DECAL FILM

FREE SHIPPING:

- DOMESTIC USA ORDERS \$50 OR MORE
- INTERNATIONAL ORDERS \$100 OR MORE

CLICK HERE TO VISIT OUR WEBSITE!



Archer Fine Transfers • PO Box 1277 • Youngsville, NC 27596 • USA (919) 570-1026 • info@archertransfers.com • archertransfers.com

"Archer rivets are easy to apply and look great. To me, they are now a vital tool in building railroad models."
Tony Thompson, Model Railroad Author/Historian



MADE IN THE USA

ADVERTISEMENT



HO AND N DIESEL AND PASSENGER CAR DIAPHRAGMS.

THE FINISHING TOUCH.

AT YOUR DEALER OR DIRECT.
www.americanlimitedmodels.com

flattop staging at both ends as the first step (assuming this is the first module you build).

We're looking for a sample design that fits the parameters we specify – one single module. Outline the design for the rest of the modules in the room, and those modules can be any size you like. We just want one that fits our specs, and design that one out completely.

You can use a modular standard if you wish, but you don't need to. You can make each module a unique section that only connects to one other section if you prefer to do that.

The flattop staging can be just a construction and testing artifact and you can elect to ditch both of these staging yards in the final layout, replacing them with your "real" staging modules in the finished layout.

"ONE MODULE" CHALLENGE BONUS PRIZE!

**GET YOUR MODULE *FREE* FROM
modelrailroadbenchwork.com**

"We would like to offer the winner a free module meeting their design's size criteria with legs. This means you'll win a benchwork module with a value of up to \$150 shipped free to your home.

(In the US only, however.)"



STAFF NOTES | 6

With this contest, we're attempting to build a level playing field by making everyone to solve the same starting problem. Room size is therefore fixed as well.

As to module length, it can wrap around a corner. Keep in mind a single corner module with the contest linear length won't be easy to maneuver in and out of the layout room, so it might need to be in two sub-sections for transport – but hey, surprise us!

We will reward clever construction methods that are a good idea. We're hoping to advance the art of module-making a bit, but we're not interested in seeing how weird and bizarre you can be in your construction approach.

Someone asked why we mention photos if you are not supposed to actually build the module? If you are basing your design on a prototype, then a couple photos of the prototype might be included. Or if you have a particular construction technique that you've seen used and you have some photos of that technique you took, then go ahead and throw those in.

But this is a design contest, you don't have to build it, so you obviously won't be able to photograph the thing if it's only a design.

Let's see what you can come up with!

Contest Prize from Model Railroad Benchwork

The folks over at ModelRailroadBenchwork.com are offering a prize to the winner of our One Module Challenge Contest: **“We would like to offer the winner a free module meeting their design's size criteria with legs. This means you'll win a benchwork module with a value of up to \$150 shipped free to your home (In the US only, however).”**

Now there's a nice extra incentive from an MRH advertiser!

What's new on the MRH website?

Here's our monthly listing of some interesting posts.

Adding a car weighing scale track: mrhmag.com/node/23823

Rolling stock as lineside structures: mrhmag.com/node/23719

The "artsy" photograph: mrhmag.com/node/23745

Tichy USRA hopper build - set of 6: mrhmag.com/node/23694

Non-flickering car lighting: mrhmag.com/node/23755

Transforming cheap rolling stock: mrhmag.com/node/23623

Sergent coupler experiences: mrhmag.com/node/23791

Shapeways 3D printing: mrhmag.com/node/14759

ADVERTISEMENT

HO GP60M, GP60B AND GP60 Locos



NOW AVAILABLE !



DC OR DCC WITH SOUND!



www.foxvalleymodels.com

MRHMAG.COM

ADVERTISEMENT

George's Trains

EST. 1942

Canada's Greatest Model Train Store!

20 NEW Colours
Just added!



ACRYLIC-Air Brush Ready

NOW OVER 45 Canadian Railway Colours!

Dealer inquiries welcome.

- | | | |
|------------------------------|-----------------------------|-------------------------|
| PP-001 CNR Green #11 | PP-020 TH&B Maroon | PP-038 TTC CREAM |
| PP-002 CNR Imitation Gold | PP-021 Primer | PP-039 TTC Maroon |
| PP-003 CNVIA Blue #16 | PP-022 Reducer | PP-040 Warm BLACK |
| PP-004 CNVIA Yellow #18 | PP-023 Flat Finish | PP-041 Grimy Black |
| PP-005 VIA Grey | PP-024 Stencil White | PP-042 Anti-Glare Black |
| PP-006 CN Red/Orange #11 | PP-025 Loos Black | PP-043 Sleg Brown |
| PP-007 CN Lettering Grey #17 | PP-026 Flat Haze | PP-044 GO Green |
| PP-008 CN Grey #11 | PP-027 ONR LT BLUE | PP-045 GO White |
| PP-009 CNR Red #12 | PP-028 ONR DK BLUE | PP-046 CONRAIL Blue |
| PP-010 CPR Tuscan | PP-029 ONR YELLOW | |
| PP-011 CPR Diesel Grey | PP-030 ONR Post 2000 Yellow | |
| PP-012 CPR Diesel Yellow | PP-031 ONR GREEN | |
| PP-013 CPR Steam Grey | PP-032 BCR/PGE DK GREEN | |
| PP-014 CPR Mineral Brown | PP-033 BCR RED | |
| PP-015 CP Action Red | PP-034 BCR Blue | |
| PP-016 CP Action Yellow | PP-035 BCR Yellow | |
| PP-017 CP Action Green | PP-036 BCR/PGE LL GREEN | |
| PP-018 CP Bright Red | PP-037 GTW Blue | |
| PP-019 TH&B Cream | | |

\$8.98 each
Canadian



550 Alden Rd. Unit 101, Markham, On, Canada L3R 6A8
Tel: 905-470-6200 Toll Free: 1-877-8TRAINS (887-2467)
www.georgetrains.com

- TABLE OF CONTENTS
- INDEX

STAFF NOTES | 8

Upgrading to a Kato can motor: mrhmag.com/node/23725

Making a dispatcher track diagram: mrhmag.com/node/23713

New idea for small power sander: mrhmag.com/node/23754

Correcting MicroEngineering turnout: mrhmag.com/node/23750

Curved turnout using CV ties: mrhmag.com/node/23534

Enjoy the October issue of MRH!



**Click here for
reader comments**

ADVERTISEMENT



Rusty Stumps

Scale Models

WE ONLY SELL WHAT WE MANUFACTURE

DETAILS

IN HO, O, S & N SCALES

LASER CUT SHINGLES, DOORS & WINDOWS, FENCES, SIDING, CRATES. Also RESIN and WHITE METAL DETAILING CASTINGS.

CRAFTSMAN KITS

IN HO, O & S SCALES

CHECK IT ALL OUT AT

WWW.RUSTYSTUMPS.COM

Send \$3.50 for Catalog - Specify Scale

RUSTY STUMPS SCALE MODELS

6785 Cherry Blossom W. Dr., Fishers IN 46038

Phone (317) 595-9489

MRHMAG.COM

- **TABLE OF CONTENTS**
- **INDEX**

The Get the Latest Model Railroading News, Tips, Reviews & Opinions

SCOTTY MASON

S H O W

The Original Model Railroad Podcast

-Monthly Interviews

- Modeler's Spotlight: Top Modeler's Talk
- Narrow Gauge Modeling w/Chris Lane
- Contemporary Modeling w/ Mike Rose

-More Product Announcements & Reviews

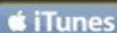

Our feed has changed! To get the latest shows, Please search Scotty Mason and subscribe to the new feed!

www.TheModelRailroadPodcast.com

Scott Mason Jimmy Simmons Mike Rose Joe Duckworth

**When talking
to hobby
vendors,
please
remember
to mention
MRH.**

ADVERTISEMENT

Backdrop Junction

Your Stop for Railroad Backdrops

Click Here →

**For the Finest in Custom
Designed backdrop**



www.backdropjunction.com

MRHMAG.COM

- [TABLE OF CONTENTS](#)
- [INDEX](#)

Trainfest®

— NEW —
**2 DAY
TICKETS**

**AVAILABLE NOW
THROUGH NOV. 13**

Sponsored by the Wisconsin
Southeastern Division, Inc. of the
National Model Railroad Association

**AMERICA'S LARGEST
OPERATING MODEL
RAILROAD SHOW**

**Saturday & Sunday
Nov. 14 - 15, 2015**

**9:00am-
5:00pm**

**WI State
Fair Park**
Milwaukee (West Allis), WI

Ticket discounts and show details at **Trainfest.com**

**ALL ACTIVITIES
INCLUDED
WITH ADMISSIONS
TICKET!**

EXPANDED TRAINFEST CLINICS

Join us for **2 full days** of clinics presented by expert modelers and model railroading manufacturers. Choose from a wide range of modeling topics at any of our **56 total clinics!** Space is limited, register for clinics today at www.Trainfest.com.

FREE

60 MODEL RAILROADING MANUFACTURERS

Come to see all **major model railroading manufacturers** at Trainfest and many **cottage industry** businesses offering unique and interesting products for your layout. Don't miss any of the exciting announcements scheduled to be unveiled at Trainfest!

NEW: PRODUCTS ANNOUNCEMENTS

70 OPERATING LAYOUTS

Make Trainfest your annual destination to meet with other modelers and find inspiration for your own layout as you walk through over **70 operating model railroads**. Experience the camaraderie of the model railroading hobby and even **operate the trains** on participating layouts!

**OPERATE
THE
TRAINS!**

CELEBRATING THE CHICAGO & NORTH WESTERN SYSTEM

This year marks the beginning of an exciting new tradition for Trainfest. Each year we will be celebrating a railroad, starting with the **Chicago & North Western System**. Discover the railroad's rich history in the museum quality historical photo display, learn about the road at C&NW clinics, and more.

**FREE
RIDE THE
MILES
TRAIN!**

NEW MANUFACTURER AND MEDIA PARTNER

Trainfest is excited to announce a brand new HO and N scale model railroading manufacturer, **ScaleTrains.com!** ScaleTrains.com will be unveiling several all-new models on **Saturday morning** at Trainfest. Be sure to visit us at Trainfest!





MRH Q-A-T

column

compiled by
JOE BRUGGER
.....



[Click here for
reader comments](#)

QUESTIONS AND ANSWERS

Model momentum with DCC

Q. Acceleration and deceleration ... using momentum gives me more time to use the other functions like brake squeal or air brake sounds as the train is slowing.

I just bought a TCS WOW Sound decoder and they have the Accel and Decel set so the train starts and stops like the real thing. They give you a brake function you can control when brakes are set or released and you get sounds like the train is slowing or the brakes were just released. Pretty cool.

How about you? Do you just use the knob to control the speed or do you program the momentum?

—Trent

A. Toni R.: I just got an N scale Atlas Alco S-2 with ESU-Lok-sound decoder and I love the way it came set up straight from the factory. The TCS brake functions perform very much like

▶ MRH QUESTIONS, ANSWERS, AND TIPS



1. Do your trains move with the ground-shaking majesty of a full-size freight locomotive? Modelers and manufacturers are developing techniques and tools for credible momentum effects. *Graham Line photo, Albina OR 1988*

Mike Confalone's method of setting up his Tsunamis. See mrh-mag.com/node/18171. I also have an Athearn F45 with Tsunami sound. I have not run it very much in the two years I've had it because of the unrealistic way the sound responded to throttle position, Now I have a PR3 and Decoder Pro and I may get the ambition to set that up.

Brian (santa fe 1958): I'm slowly adding momentum, but with a small layout, it is a case of getting used to it and not putting the loco in the dirt!

Tim Latham: Currently I am only putting a very small amount of Accel and Decel into my locos. Right now I am setting CV3 and CV4 at 5 which just keeps them from jackrabbit starts and wheel locking stops. As I learn the quirks of each engine – steam acts differently than diesel, big engines react differently than small – I am going back and adjusting them to different settings until I’m happy with them.

Graham L.: The owner of a layout I operate on from time to time likes to experiment with momentum levels. It’s disconcerting to run a GP9 or an SW1500 for a while, get called to another job, and find out that similar locomotives don’t respond in the same way. Yes, it can add a lot of “heavy engine” feel, but surprises can be spooky.

Brent Ciccone: I would like to see a knob on the throttle that adjusts the momentum, and have the throttle control the momentum. That way, you would select your engine address and then choose a heavy or light or somewhere in-between train weight rather than having a set momentum in the decoder. Sure, you can reprogram the CVs each time, but who wants to do that?

I prefer medium settings of 30 or 40, maybe around 10 in a switcher, but I always set some amount of momentum. It saves your engines if the operator suddenly switches direction on the throttle!

Also, when switching, set a slow speed on the throttle and then use the direction key to do your switching. You can do all your switching without touching the speed control!

Joe Fugate: NCE throttles have a “momentum” button with values from 0-9 on the throttle. Voila – instant extra momen-

tum! The digit you enter is multiplied by what you currently have in the loco Accel and Decel CVs. Entering zero removes the Accel and Decel, one uses what's established unchanged, two doubles it, and so on. Entering a 9 will really increase it! Works pretty cool, actually. It's fast and easy.

GregW66: I am just switching, so I don't run with it. I make sure I am on 128 speed steps. This ensures slow speeds, in my mind. Once I get more into sound, I may try some momentum.

Rick W.: Yes for acceleration, but no for deceleration. I have a swing gate on my layout and I don't want a loco coasting off the track if the gate happens to be open. I am able to slowly reduce the speed using the throttle so it's not a problem.

Nelson Beaudry: I set my locomotives (sound equipped) with a large setting for acceleration and only a small amount of deceleration. For example: Bachmann S4 switcher CV3 = 150 and CV4 = 20. An RS3 road switcher will have CV3 set at 200 and CV4 set at 25. It varies by decoder model and whether the unit has sound or not. Most non-sound units have values set at 10 or lower, and some don't have any. I run my throttles at 128 speed steps for sound units, and switch to 28 speed steps for non-sound units, and use the buttons for speed rather than the rotary knob. I like the rotary knob for sound units as I can spool up the engine and "load" it, and then back off as the engine starts moving. Makes for really good sound effects.

John Colley: I am experimenting with heavier cars (weighted at one ounce per inch between coupler faces) and lots of momentum; two or three SDP45s set at CV3 = 200, CV4 = 50. The results are beautiful operation. The only caveat is the learning

curve on the braking. One neat job is stopping eight or 10 feet out, and then coupling up to your train without shoving it half a car length!

Rob in Texas: I simulate momentum with very careful throttle control and long heavy trains. I tried switching with large amounts of momentum and it was maddening to me. I was continually over-running locations where I wanted to stop. I might at some time in the future try to use those controls again but right now I avoid the fast starts etc., by slow and smooth work on the throttle. I just found it stressful. For me, I will try it again at a later date.

Pete: When it comes to momentum. I have been in the “Rob in Texas” camp since I got my first Digitrax system 20 years ago. When sound came along I briefly tried to use a lot more CV3 and 4. While starting off was good, slowing and stopping accurately was too hard to manage.

What has caused me to change recently is this: Last month I installed my first TCS WOWsound diesel decoder in an Atlas O scale 2-rail SW9. It has been a revelation! I think the secret is in the 5-level braking function. Now I can manage it very accurately. Once I see how much retardation the first brake application provides, I can press again or not, and stop exactly where I want to. If it all goes horribly wrong, 5 presses of the brake button is pretty much a dead stop.

The brake control combined with the way the WOWsound notches back to idle by itself when coasting or braking has doubled my enjoyment of operation. It finally feels like the engine sounds like it should under all operating conditions, as well as moving like it should.

Eric Warhol: Use both acceleration and deceleration momentum along with the F7 key for applying the brake. Using QSI Titan Magnum decoders. Have CV3 set in the 60s and CV4 set in the upper 40s. Still playing with and getting used to it, but have really come to enjoy using the F7 key for braking.

Paul Schmidt: I learned a long time ago that momentum in model trains is only as good as the consist that can operate smoothly without it. CVs 3 and 4 are dialed in fairly low for switching, but I like the effect.

Much more about momentum at mrhmag.com/node/23331.

Keeping flex track straight

Q. I'm using Micro Engineering code 83 track on my layout-under-construction. It's usually fairly straight when it arrives, but by the time it's unpacked, moved, measured, painted, cut,



2. R. Seiler uses a 5/8" steel bar on straight HO flex track to help straighten it and to weight it down. *R. Seiler photo*



FAST TRACKS **YOUR VERY OWN TRACK FACTORY**

Make the most of your modeling experience.

Build perfect trackwork easily and inexpensively when YOU want it!



Check out our extensive (and growing!) online video library to learn how easy it is to hand lay your own trackwork with Fast Tracks tools and supplies.

Play Video 



shop online 24/7

1-888-252-3895

handlaidtrack.com

service@fast-tracks.net

MRHMAG.COM

- [TABLE OF CONTENTS](#)
- [INDEX](#)

Come See our October Specials

(while supplies last)

YD
Yankee Dabbler.Com



HO

DCC

ALL SCALES

- Kadee
- NCE
- Digitrax
- SoundTraxx
- And more!



MRH Q-A-T | 7

cleaned, etc., it's no longer straight. I searched the forum here. Lots about how hard it is to straighten it. Not a lot on how to.

—nydepot

A. Rob Spangler: I get the track as straight as practical before installation by running my fingers down the ties. Rather than using weights, I hold track in alignment with push pins while gluing. Where necessary, I put a metal straightedge, plastic level, or whatever is handy against one rail while pinning the track down.

To keep the caulk away from the straightedge, I try to limit the application to the center of the ties plus a bit on either side. With a wide straightedge like a level against the rail, the opposite side hits the roadbed some distance from the edge of the caulk so it tends to stay clean. I mostly use Alex Plus acrylic/latex sealant for track, which cleans up easily with water.

MRH Q-A-T | 8

Stottman: A lot of the Fast Tracks (handlaidtrack.com) SweepSticks help, as well as the flex track tool that's made by MLR.

Using a long straight edge helps, but I have found that the ties are inconsistent in width enough to throw things off. It also makes turnouts difficult.

Paul Schmidt: I use a straight edge set alongside the outside of rails. Works well enough even for N scale code 55.

More on straightening flex track at: mrhmag.com/node/23291.



TIPS

Easy and excellent uncoupling tool

These coupler picks are easy to make, effective, and easy on the train budget (because they're acquired on the coffee budget!). If you live

FINALLY!

Are you ready for an Innovative Website where new AND used Model Train Stuff can be bought and sold hassle-free?

The screenshot shows the e-Auction-Club.com homepage. At the top, it says "e-Auction-Club.com Where buyers and sellers both save money." Below that is a navigation bar with links for Home, Browse, Pre-Order Help, Welcome, Sell, Help, and a search bar. The main content area features a banner for "Welcome to our Grand Opening" and a grid of model train listings. Each listing includes a small image of the train, the item name, and the current bid price. For example, one listing is "HO Coach - Knapik Pacific Paint Set..." with a bid of \$43.77. Another is "HO P-20 Pennsy A's Bath Coach E..." with a bid of \$7.86. The bottom of the page shows the date "Monday, September 14, 2015 12:14 PM" and a copyright notice for e-Auction-Club.com.

Basic Listings are FREE with a 6% Final Value Fee on all sales, less than HALF of the average ebay commission!

Some Innovative Ideas that you will find at e-Auction-Club.com

1. We accept Pre-Orders up to 5 months before scheduled delivery.
2. We allow "Item Wanted" Ads
3. Add a video to any listing to greatly increase sales.

Join the
e-Auction-Club.com
Community Today

e-Auction-Club.com
Where buyers and sellers both save money.



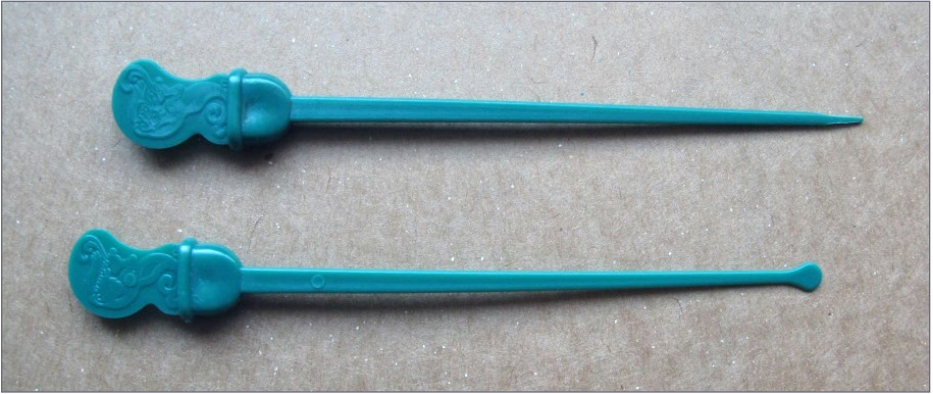

3. Shape a point on a Starbucks “stopper” to make a useful uncoupling tool.

in a Starbucks-free zone, you may need to make importing arrangements.

My local Starbucks barista tells me these are officially known as “stoppers.” A couple of quick snips with flush cutters will reshape the rounded safety end to reveal the model train coupler-releasing tool hiding inside. The lower “stopper” in the picture is the stock item available in any Starbucks. Above it is the modified version.

This produces a very comfortable and effective uncoupling tool, at least for HO. I suspect neighboring scales will also benefit, perhaps with some variation in the shaping of the point. The handle is both decorative and comfortable to grip and use, and the thin dimension of the tapered rectangular shaft slips easily between the diaphragms on modern passenger equipment to find and release the couplers. The leverage provided by the square-ish edges of the shaft is very effective at releasing the couplers with minimal frustration.

— Chuck Heuer

MRH Q-A-T | 10

**GET PAID FOR
YOUR TIP**

We pay \$25 per tip we publish, or \$40 each if the tip also includes a photo or finished drawing. [Click here and select article type TIP.](#) ■



**Click here for
reader comments**



**DID YOU KNOW
MRH SUBSCRIBERS
GET FREE BONUSES?**

**CLICK TO SUBSCRIBE
NOW - IT'S FREE!**

MRHMAG.COM

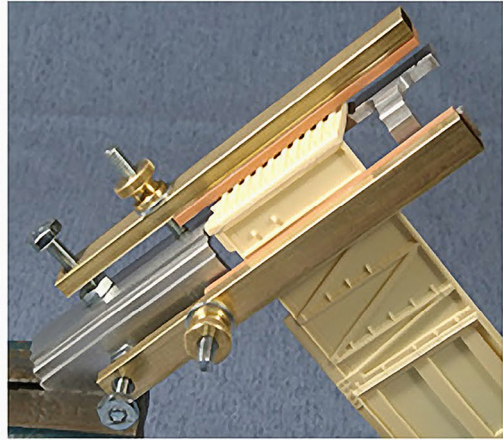
Combo Right Clamp™

Combo Right Clamp™
with cast resin boxcar

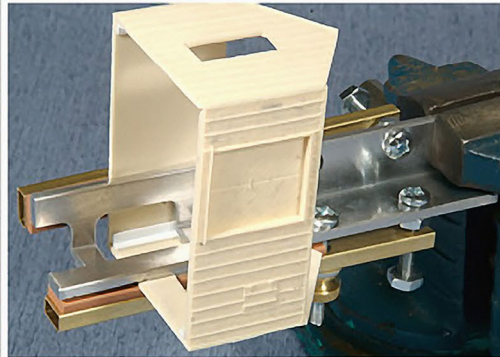

Combo Right Clamp™
with Wolf Design Pump House

**Click here for
all our products ...**

Tools for Modelers

Coffman Graphic Solutions Co.
1500 River Circle, Richmond,
KY 40475-7907

- [TABLE OF CONTENTS](#)
- [INDEX](#)

The power of LocoNet



\$455.00 MSRP
Super Chief Xtra



LocoNet
Is The Digitrax Difference

- Run Trains
- Sound
- Feedback
- DC Control
- Computer Control
- Lighting
- Turnouts
- Signaling
- Transponding
- Block Detection

t® only with **Digitrax**



\$225.00 MSRP
Zephyr Xtra

Free Digitrax Toolbox App!
*Easy to use tools to enhance your
Digitrax experience!*

For iPhone/iPad and Android

**Download now @
[www.digitrax.com!](http://www.digitrax.com)**



Southern Digital



**20% Discount
on most Items!**

Specializing in DCC Since 1992



DCC Conversions, Service & Support

Orders Received by 3:00 pm EST ship the same day

WWW.SODIGI.COM

E-mail: sales@sodigi.com

(770) 929-1888

(Photo's are from our N-Scale layout)



DCC IMPULSES

column

BRUCE PETRARCA
.....



[Click here for
reader comments](#)

SOUNDTRAXX' ECONAMI DCC DECODER ...

IN JULY 2015, SOUNDTRAXX ANNOUNCED THE Econami, their first new sound decoder series since the Tsunami debut about a decade ago. I briefly mentioned it at the end of my September column (mrhpub.com/2015-09-sep/port). This month's column is written with input from some folks who have actually had Econamis in their hands and installed them.

The Econami is the first group in a whole new line of decoders from SoundTraxx. Obviously from the name and the price, it will be the low-end unit. Based on what the Econami delivers, I expect great things from their other offerings as they are announced.

The Econamis are available in three versions: 1-amp with wires [1], 1-amp with a 21-pin NMRA-compliant connector [7], and 4-amp with screw terminals [8]. There are diesel, steam, and electric sound variations for each package. I'm not going to spend a lot of space repeating what is on the SoundTraxx web site. You can see for yourself at soundtraxx.com/dsd/econami/index.php.

► DCC TIPS, TRICKS, AND TECHNIQUES

DCC IMPULSES | 2

I got a sample from SoundTraxx of the ECO-100 1-amp wired models [1] in all three voices. These guys are small: 27 x 10.5 x 5 millimeters. That's 1.063 x 0.413 x 0.197 inches. They will make many of those tight installations easier to do, including N scale ones. With a list price just under \$80, these guys fit a tight budget, too.

The downside of the small size is that they don't have room for any connectors, so they must be hard-wired into the locomotive. Also, while they support external energy storage systems (like SoundTraxx' CurrentKeeper), that must also be hard-wired. Point of note – the ECO-100 is smaller than the CurrentKeeper.

The package includes a 220 μ F electrolytic capacitor to wire between the blue and yellow/green leads, reminiscent of the TSU-750 decoders. The CurrentKeeper can be wired here

ADVERTISEMENT



Make Your Modeling Dollars Go Further

You don't have to break the bank to add great sound to your fleet!



The **NEW Econami ECO-100** is the most feature-packed, micro-sized sound decoder for under \$80.

Hear how you can get more for less!





1. One-amp wired version of the SoundTraxx Econami, the ECO-100.

ADVERTISEMENT



Installing DCC sound just **NOT** your thing?

Trust Traintek for sales and installation of sound decoders from these fine vendors!



RailPro

"Taking model railroad control to the next level ..."



traintekllc.com

Click here for more details...



"Traintek was the way to go!"



instead. Thus, you can have three levels of energy storage: small (what's in the decoder), medium (external capacitor), or large (capacitor bank, like the CurrentKeeper).

Sound quality

The first thing I wanted to do was listen to the raw audio quality of the Econami. I put a diesel version on the test bench and connected it to an eight-inch speaker in a public address baffle [2] that I have above my

DCC IMPULSES | 4

workbench. This speaker makes a lot of sound out of one watt of audio power and shows the cleanliness of the sound. I connected a motor and the DCC signal from my PowerCab.

I didn't install the steam version before the deadline for this column, so, I'll focus on the diesel version for now. Because I don't have different models to compare (ECO-400, 4-amp, for example), I cannot comment on sound differences between the versions. I can point out the specifications which show the sound power output varying among the models: 1 watt on the smallest decoder, 2 watts on the 21-pin version and 3 watts on the 4-amp version.



2. Eight-inch 8-ohm speaker in a public address wall baffle that I used for the initial sound quality test.

EMD 567

✓ EMD 645 (turbo)

EMD 710 (turbo)

GE FDL-16 (modern)

ALCO 244

3. Decoder Pro selection screen for prime mover sounds.

I was highly impressed with the sound as it came out of the bag. It was almost too loud with the efficient speaker that I was using, so I used DecoderPro (see notes later in this column) to reduce the general sound level and didn't adjust any specific sound volumes.

A simple change of CV allowed me to cycle through the prime mover choices [3]. While they are limited, they cover exactly, or are very close to, the majority of locos modeled. The default (CV123 = 0) is the EMD 567 non-turbo. I tried all the motors before settling on the EMD 645 turbo that my intended installation needed. Each motor had a different and, to my ear, accurate startup sound. The running sounds were clean and accurate, as were the shutdowns. Just what I expected from the SoundTraxx decoders for the aftermarket U.S. modelers. The products sold to loco manufacturers, like Athearn and Bachmann, to name two, are frequently lesser units in terms of features and sounds.

DCC IMPULSES | 6

Given the small size of the decoder, I expect to see additional models on the market, with sounds for locos like the GE 44-ton and 70-ton motors. It just seems right, unless the upcoming flagship decoder in the SoundTraxx line-up is smaller.

There are a myriad of horns (16) and bells (7 with as many as 4 ring rates for some) available in the diesel package.

In summary, the decoders do a good job of delivering the sound quality that I heard on the 32-bit master tapes in SoundTraxx' editing studio.

Remember, the sound quality will only be as good as the decoder can deliver and your acoustic design can support. This decoder can deliver. See my August 2012 column, How Do I Get the Sound Out?, (mrhmag.com/magazine/mrh-2012-08-aug/dcc_impulses) for more information on acoustic design.

ADVERTISEMENT

Make LocoNet wiring extremely simple!

ACCU-LITES, inc

Your DCC Center!

Dealer Inquiries Accepted

CELEBRATING
20
YEARS
ANNIVERSARY

PM42
breakout
board



SE8C
breakout
board



BDL168
Multi-zone
breakout board

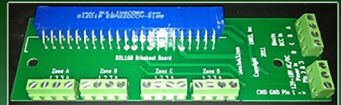

BDL168
Single-zone
breakout board



Now Offering SNAPS! in packs of 6 or 12 pieces! [CLICK TO LEARN MORE ...](#)

MRHMAG.COM

- [TABLE OF CONTENTS](#)
- [INDEX](#)

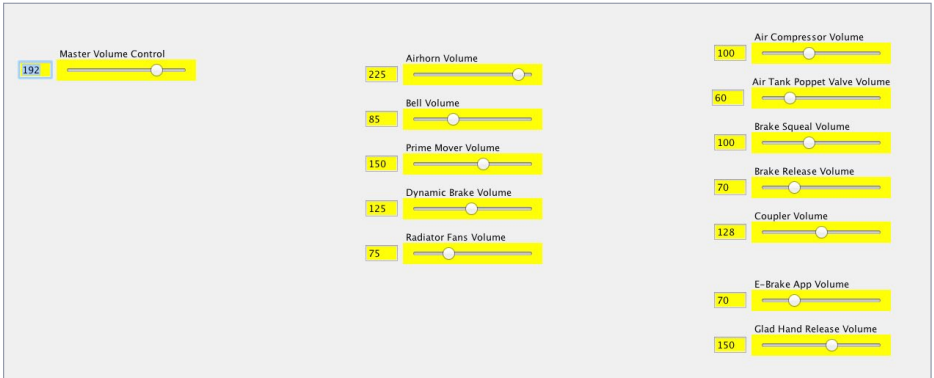

4. The DecoderPro page for adjusting sound levels in the Econami decoder.

DecoderPro support

The Econami introduces indexed CVs to the SoundTraxx stable for the first time. Indexed CVs can be very vexing, especially for first-time or casual users. Here is where DecoderPro (jmri.org/download/index.shtml) shines. You don't have to worry about what CV (or indexed CV) is needed, just select what you want and have it write the CVs and keep a copy on your computer.

Thanks to several folks in the JMRI community (Michael Mosher, Dave Heap and Alain Le Merchand), the test version (4.1.1) of JMRI issued on August 15, 2015 includes support for all released Econami models. That and all later versions (4.2 will be the next general release) will have what you need. Be aware, that versions of JMRI later than 4.0 will require Java version 1.8 or later. You can verify what version of Java you have on the web (java.com/en/download/installed.jsp). Java 1.8 says that it is not supported by Windows XP. I installed it on an XP machine and am running JMRI 4.1.1 just fine. Just forge ahead when it starts telling you that it won't work.

DCC IMPULSES | 8

One look at the choices for sound levels [4] or function mapping [5] shows you why you need DecoderPro to tame the Econami.

Installation

Before the deadline for this column, I was able to install the diesel ECO-100 and a CurrentKeeper in a Walthers HO scale GP15-1 [6].

Use this sheet to determine which functions will control which outputs

	Extended Function Mapping	Forward Driving	Reverse Driving	Forward Standing	Reverse Standing	Emergency Stop Button
Headlight	F0	<input type="checkbox"/>	<input type="checkbox"/>	<input type="checkbox"/>	<input type="checkbox"/>	<input type="checkbox"/>
Backup Light	F0	<input type="checkbox"/>	<input type="checkbox"/>	<input type="checkbox"/>	<input type="checkbox"/>	<input type="checkbox"/>
FX3 Effect	F24	<input type="checkbox"/>	<input type="checkbox"/>	<input type="checkbox"/>	<input type="checkbox"/>	<input type="checkbox"/>
FX4 Effect	F25	<input type="checkbox"/>	<input type="checkbox"/>	<input type="checkbox"/>	<input type="checkbox"/>	<input type="checkbox"/>
Dimmer	F7	<input type="checkbox"/>	<input type="checkbox"/>	<input type="checkbox"/>	<input type="checkbox"/>	<input type="checkbox"/>
Mute	F8	<input type="checkbox"/>	<input type="checkbox"/>	<input type="checkbox"/>	<input type="checkbox"/>	<input type="checkbox"/>
Brake	F11	<input type="checkbox"/>	<input type="checkbox"/>	<input type="checkbox"/>	<input type="checkbox"/>	<input type="checkbox"/>
Half Speed	F14	<input type="checkbox"/>	<input type="checkbox"/>	<input type="checkbox"/>	<input type="checkbox"/>	<input type="checkbox"/>
Momentum Override	F14	<input type="checkbox"/>	<input type="checkbox"/>	<input type="checkbox"/>	<input type="checkbox"/>	<input type="checkbox"/>
Grade Crossing Signal	F9	<input type="checkbox"/>	<input type="checkbox"/>	<input type="checkbox"/>	<input type="checkbox"/>	<input type="checkbox"/>
Forward Signal	Disable	<input type="checkbox"/>	<input type="checkbox"/>	<input type="checkbox"/>	<input type="checkbox"/>	<input type="checkbox"/>
Reverse Signal	Disable	<input type="checkbox"/>	<input type="checkbox"/>	<input type="checkbox"/>	<input type="checkbox"/>	<input type="checkbox"/>
Stop Signal	Disable	<input type="checkbox"/>	<input type="checkbox"/>	<input type="checkbox"/>	<input type="checkbox"/>	<input type="checkbox"/>
RPM+	F5	<input type="checkbox"/>	<input type="checkbox"/>	<input type="checkbox"/>	<input type="checkbox"/>	<input type="checkbox"/>
RPM-	F6	<input type="checkbox"/>	<input type="checkbox"/>	<input type="checkbox"/>	<input type="checkbox"/>	<input type="checkbox"/>
Airhorn	F2	<input type="checkbox"/>	<input type="checkbox"/>	<input type="checkbox"/>	<input type="checkbox"/>	<input type="checkbox"/>
Bell	F1	<input type="checkbox"/>	<input type="checkbox"/>	<input type="checkbox"/>	<input type="checkbox"/>	<input type="checkbox"/>
Dynamic Brake	F4	<input type="checkbox"/>	<input type="checkbox"/>	<input type="checkbox"/>	<input type="checkbox"/>	<input type="checkbox"/>
Short Airhorn	F3	<input type="checkbox"/>	<input type="checkbox"/>	<input type="checkbox"/>	<input type="checkbox"/>	<input type="checkbox"/>
Coupler	F13	<input type="checkbox"/>	<input type="checkbox"/>	<input type="checkbox"/>	<input type="checkbox"/>	<input type="checkbox"/>
Coupler Release	F13	<input type="checkbox"/>	<input type="checkbox"/>	<input type="checkbox"/>	<input type="checkbox"/>	<input type="checkbox"/>
E-Brake App.	Disable	<input type="checkbox"/>	<input type="checkbox"/>	<input type="checkbox"/>	<input type="checkbox"/>	<input checked="" type="checkbox"/>

5. The Econami allows broad flexibility in function mapping.



LokSound L -Premium Quality Low Cost DCC and Sound in O Scale!

Coming Soon in "Atlas O"

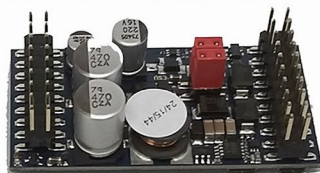

Each Decoder set
comes with Decoder
and Adaptor board



FULL FEATURED "LOKSOUND L SELECT"

ESU Item# 73399 ****ONLY \$149.99****
Shipping Now!

- Dimensions: 1 Inch x 2 inch
- Amperage: 3Amps continuous (up to 4Amps for a short time)
Overload Protected
- Function Outputs: 11(!)
- Servo Outputs: 2
- And More Features!

-
- Perfect for ESU Synchronized Smoke Units 54678 and 54679 with supported Sound Files
 - Smoke units will work with Steam and Diesel files
 - Smoke units can be set up to work with Smoke Chuff and Cylinder Steam!

**Click here for
MORE FEATURES ...**

Also Available: 54399 Fully Programmable LokSound L V4.0 199.99

ESU LLC 23 Howard Street Montoursville PA 17754 - 1-570-980-1980

www.LokSound.com

MRHMAG.COM

- [TABLE OF CONTENTS](#)
- [INDEX](#)

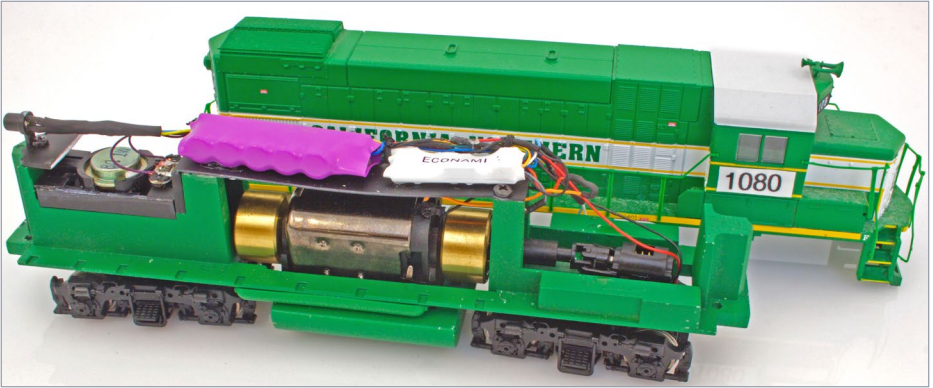

6. ECO-100 diesel and CurrentKeeper installed in a Walthers HO scale GP15-1, using a 16 x 35 mm 8-ohm speaker in a baffle arrangement.

Details and more photos are on my web site (mrdccu.com/install/hods/walthers-gp15-1.html).

One area that also impressed me was the electrical efficiency of the decoder. When this locomotive was sitting on the track with the idling sounds running, my RRampMeter was showing 0.01 amps (10 mA of current) being consumed. This efficiency should translate into cooler running. The few that have been installed seem to confirm this.

Comments on the steam version

My friend, Mark Kasprovicz has been working with the steam version and has kindly agreed to have his remarks from the SoundTraxx Yahoo group included here.

About chuff sync, since there is no cam input: “The chuff sync is adjusted via CV113. It has a maximum setting of 127 [NOTE: Newer versions allow 255 max. If you need more range, SoundTraxx will update your decoder for free.] My little HOn3

DCC IMPULSES | 10

C-16 needed a setting of around 120, much higher than the recommended midpoint of 57. But the wheels are small.

“It appears that the chuff sounds are being generated based motor revolutions, which may be the end of cams.”

About the cylinder cock sound: “Pressing F4 starts a constant hiss, opening the throttle starts the chuffs which interrupt the hiss. That’s OK as in real life steam will enter the cylinders and then be exhausted resulting in the chuff. So I just press F4 and straight away open the throttle. I think it sounds pretty much like the real McCoy.”

About the electrical efficiency and CurrentKeeper: “The circuit is much more efficient – I’m getting 70% more stay alive with the motor and sound running than with the Tsunami, also I found that when the motor stopped the sound kept running for another five or six seconds.”

ADVERTISEMENT

Great control in a tiny package



**Original
Touch Toggles**

- Touch Toggle™ plug in controls
- Bright clear indication
- Easy setup
- Flexible system

Stall Motors, Twin-coils,
Power, and Servos

Now for Tam Valley Depot
and MRservo too!



Made in the USA



What will they think of next?

www.berrethillshop.com

MRHMAG.COM

- [TABLE OF CONTENTS](#)
- [INDEX](#)

DCC IMPULSES | 11

About function remapping: “I just tried the new remapping feature and wanted to put the brake on F7, in common with my remapped Tsunami’s. So I input CV32 to 1 to enable the indexing on level one, punched in the Brake CV which is (1.)275 and then input the destination function key. Selected in this case 7, and it’s there. Dead easy.”

General comments: “These are loud and if you’re going anywhere near the limit you need to ensure the speaker can take it. I use sugar cubes and reduced the volume to about half of the factory setting. Any more and the speaker started to ‘square off’, i.e. distort.

“Overall impression is brilliant! If this is a portent of the new Tsunami then bring it on.”

ADVERTISEMENT

ADVERTISEMENT



IOWA SCALED
ENGINEERING

Enhance Prototype Realism
Electronics for “Your” Model Railroad

- Switch Machines
- Time Lock Controllers
- Fast Clocks
- Sound Players
- Infrared Detectors
- Block Detectors
- And more!

 open source hardware

LEARN MORE >



TamValleyDepot.com
Great Electronics for Great Model Railroads

We are loading up the boxcars with Frog Juicers ready for your layout!

- **TABLE OF CONTENTS**
- **INDEX**

DCC IMPULSES | 12



7. ECO-21, 21-pin connector version of the 1-amp model with a 2-watt amplifier.

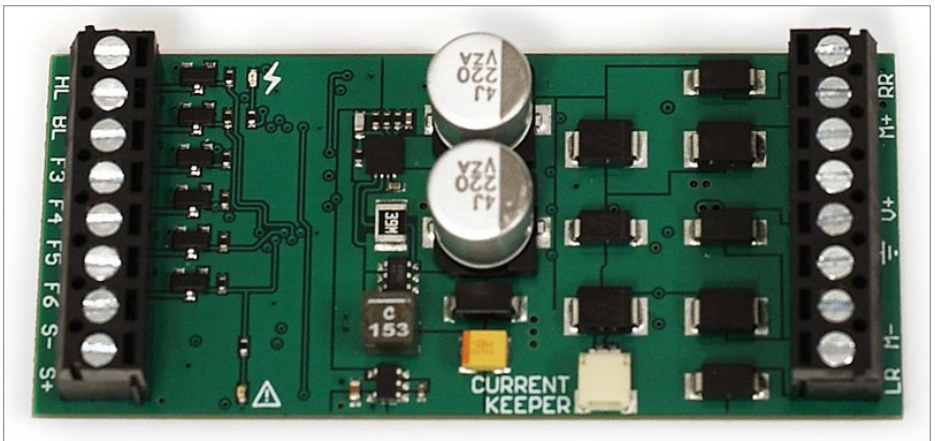

8. ECO-400 4-amp decoder with a 3-watt amplifier.



[Click here for reader comments](#)

Motor control

One area of disappointment in the Tsunami line was the difficulty of getting the locomotive to creep when a Tsunami was installed. I have a method to do so in the middle of the Tsunami page on my web site (mrdccu.com/curriculum/soundtraxx/tsunami.html). It works, but requires fiddling. How much fiddling varies between locomotives.

I am happy to report that the Econami in the Walthers GP15-1 crept on speed step 1, out of the bag, with no tweaks. More installations will tell if this is due to their new “Hyperdrive 2” or just a stroke of luck.

SoundTraxx continues to stress the checking of stall current for its decoders (mrdccu.com/curriculum/stall.html). For example, they rate the ECO-100 for 1 amp motor stall current. This is not wheels slipping, but fully stopped.

Customization

Some of the sound customization features carry over from the Tsunami, some do not. There is no reverb, but the equalizer remains. Presumably the reverb will be part of a more expensive model.

There are horn or whistle sequences available on a single function [5], grade crossing signal (F9), forward start signal (off by default), reverse start signal (off by default), and stop signal (off by default).

The 3-step speed control is available using CVs 2, 5 and 6. For the more dedicated, the 28 step table is supported, too.

21-pin 1-amp version

While I didn't test any 21-pin decoders [7], I'm very happy to see them available. They have a bit more audio power (2 watts)

Get Better Sound from your Locomotives

Can't get a good sound from your sound decoder?
Give our speakers a test drive with your ears.



RAILMASTER HOBBIES
9812 BELMONT
BELLFLOWER, CA 90706

Bass Reflex
Speakers



High Bass
Speakers



When it comes to speakers we have high quality speakers to fit many different applications.

We are also a full line hobby shop. Need anything? We are an authorized dealer for Soundtraxx, Digitrax, Athearn, Walther's and many others. We provide quality speakers for your DCC sound systems and quality service.

**Click here for
the answer ...**

DCC IMPULSES | 14

and six function outputs. The power rating can be confusing: initial specs said 1½ watts, but the units that are shipping actually put out 2 watts, per SoundTraxx. The function outputs are NMRA compliant. That means, unlike non-compliant decoders, all six functions are available to drive 100 mA loads without external circuitry.

The use of an adapter board, currently available from ESU, allows the decoder wiring to be done in the loco and then the decoder to be plugged in. This way all the connections go through one connector. I'd expect SoundTraxx to make an adapter board themselves soon.

4-amp version

O scale and some G scale modelers will be happy to see a small, inexpensive (\$150 list) decoder [8] available for their section of the hobby. I'm hoping to evaluate one soon.

It boasts 4-amp motor stall current, 6 function outputs and a 3 watt audio amplifier, all in keeping with the larger scales.

It also has a jack for direct connection of the CurrentKeeper. Given the amount of power that this decoder can deliver, will SoundTraxx give us an even larger version of the CurrentKeeper, say one with four times the amount of storage?

Folks always seem to have additional ideas to share. Just click on the Reader Feedback icon below. While you are there, I encourage you to rate the column. "Awesome" is always appreciated. Thanks.

Until next month, I wish you green boards in all your endeavors.



**Click here for
reader comments**

Mr. DCC Workshop follows ...

TONY'S TRAIN XCHANGE

Committed to your DCC support!

Jack Wabbit Quad

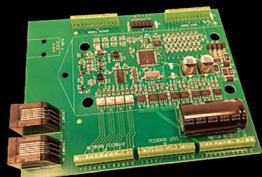

4 Output Stationary Decoder,
Compatible with Stall Motors,
Snap Coils, Servos & All Others,
Optional Loconet Interface

Starting at \$59.95

Order Yours

Atheam Genesis HO EMD GP9, GP9B & GE ES44AC GEVO



Incredible Genesis Level Detail
and Smooth Operation
Available in both DC & w/Sound

Starting at \$149.95

Order Yours

DCC Specialties RRampMeter™



Accurately Measures DCC,
AC and DC Volts and Amps!

Versions I, II, III & IV

Starting at \$59.95

Order Yours

**Do you need a Sound or
DCC Installation done?**

Get a quote!



Providing unmatched person to person
DCC support for more than 25 years, the
kind of service that has made us #1 in DCC.

DCC questions? CALL US! 1-800-978-3472

*Mention this ad for \$5.00 off your next order over \$100!

We'll get you on the right track!

Oct 2015



MR. DCC'S WORKSHOP

MY IDEAL THROTTLE ...

When my copy editor was going over last month's column about DCC Throttles (mrhmag.com/magazine/mrh-2015-09-sep), he asked me what I thought would make an ideal throttle.

That is pretty easy to put into words. Making one might not be so easy.

Remember, I use a Digitrax UT4R and a NCE Cab06PR on a regular basis. Here's what I want in an operator's (potentiometer) throttle – it's a combination of the two with a few more features, all in the same size package, of course:

- A pot with more robust end stops than either throttle has
- The option for “yard mode,” like the NCE
- A center-off direction switch, like the Digitrax
- The direction switch would change which direction is which when the throttle is used in “yard mode,” so that, with a quick flip of the toggle switch the loco can be made to go in the direction that the pot is turned;
- The ability to key in loco addresses, like the NCE
- A display of loco number and direction, like the NCE
- The ability to build and break consists, a function that neither company has on their operator's throttles
- Direct access to functions 0 through 9, like the NCE
- Radio on/off control without having to remove or flip batteries, like the NCE

DCC IMPULSES | 16

- Buttons for direct control of most used functions: horn, bell, lights and brake. Can be mapped to any Function 0 to 27 within the throttle.

So, there's my wish list. You may want to voice a different opinion. Feel free to do so on the MRH web site under the blog for this column, by clicking on the link below. ■



[Click here for reader comments](#)

ADVERTISEMENT



NEW TECHNOLOGY



NEW Starter Kit
\$399.99 MSRP

- Includes Wireless Color Touch Screen Handheld Controller and 56 Watt Power Supply
- Expandable to Virtually any Size Layout

NEW Locomotive Module
LM-2 & LM-2S



- Direct Radio RF
- Sound and Non-Sound
- New Tiny Size
- 6 Light Outputs

Click Here to Learn More

For more information visit our Internet site: www.RingEngineering.com

MRHMAG.COM

- [TABLE OF CONTENTS](#)
- [INDEX](#)

From first train set to railroad empire...

*Our complete line of DCC products
grows with you. Discover the fun!*

- Designed and manufactured in the U.S.A.
- Preferred for ease of use and ergonomic design
- Unlimited scalability for any size model railroad
- Plug-and-play means more time running trains
- Great customer service and excellent support



See your dealer



Visit our new and improved web site for all your DCC needs!

- Get the latest new product announcements
- Watch our detailed how-to videos
- Browse the all-new Information Station
- Enjoy secure online sales, day or night!

Visit **ncedcc.com**





S T A T I O N

COOL

DCC Products & Service

with Prices that

DON'T BURN

623-298-7355

www.LitchfieldStation.com



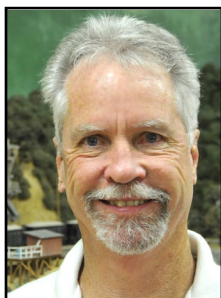

GETTING REAL

column

JACK BURGESS
.....



[Click here for
reader comments](#)

AN INTRODUCTION TO SKETCHUP AND 3D PRINTING

THERE HAS BEEN A LOT OF TALK DURING the last few years about “3D printing.” That excitement is valid as this relatively new technology has enormous potential for model railroaders.

What is 3D printing? Basically, it is a technology allowing a machine to produce a scale model of a physical part using “additive layer manufacturing” technology. That techno-description simply means that a 3D printing machine lays down successive layers of material to build up the physical model as a series of cross sections. Depending on the process, each layer is fused by a UV light, laser, or other energy source. These layers, which correspond to virtual cross-sections from the computer model, create the final shape.

▶ [MODELING REAL RAILROADS AND WHAT THEY DO](#)

The basic process

The first step for a modeler is to draw the desired part in “3D” on a computer using a program such as SketchUp. This free program was originally available from Google but is now available (still free) from Trimble at sketchup.com. It might seem impossible to draw something in 3D on a 2D computer screen, but the basic concept is simple. In the simplest approach, you draw a flat square on the “ground” and then you use a tool (called a Push-Pull tool) to click on that rectangle and “pull” it up, creating a cube [1-5]. I’ll show more examples as we go along.

After completing your drawing, you export the drawing and process it through another free program. You then upload your file to a 3D printing service bureau and order the part where it is “printed” and mailed to you, ready to use. I have been using

ADVERTISEMENT

GLXSCALEMODELS.COM

GLX SCALE MODELS - OTTAWA, ONTARIO, CANADA - 613-294-2276



**3D
PRINTED
MODEL**

**NO
ASSEMBLY
OR
PAINTING**



MOBILE LOADING RAMP



PORTABLE RAILCAR
UNLOADER



RAILCAR INSPECTION
TOWER

BUY & DISPLAY NOW!!!

MRHMAG.COM

- [TABLE OF CONTENTS](#)
- [INDEX](#)

GETTING REAL | 3

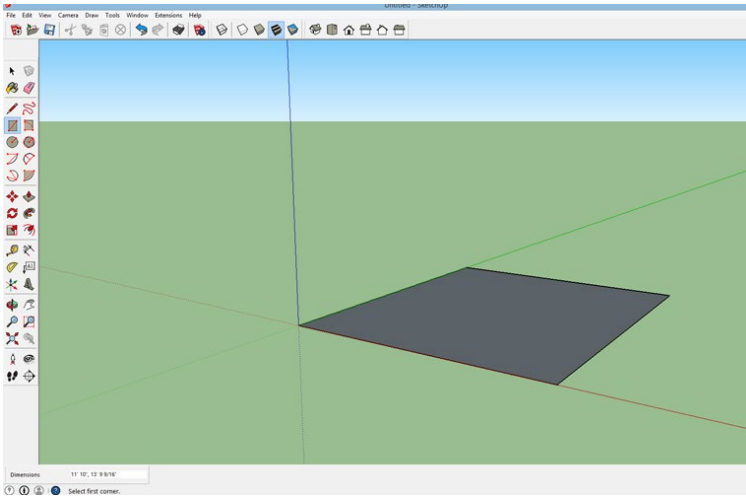

1. Here is the basic sequence used to draw something in 3D using SketchUp. Begin by using the Rectangle Tool (highlighted in the Tool Bar along the left side of the screen) to draw a rectangle.

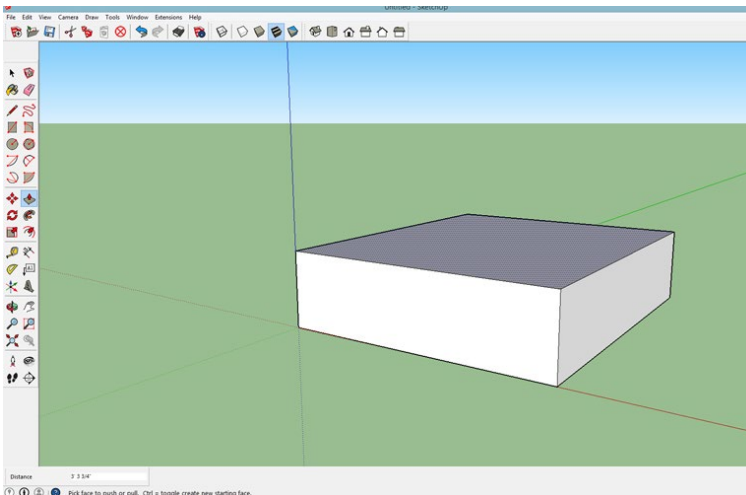

2. Then use the Push-Pull Tool (highlighted), click on the rectangle, and move the mouse upward, creating a 3D solid.

GETTING REAL | 4

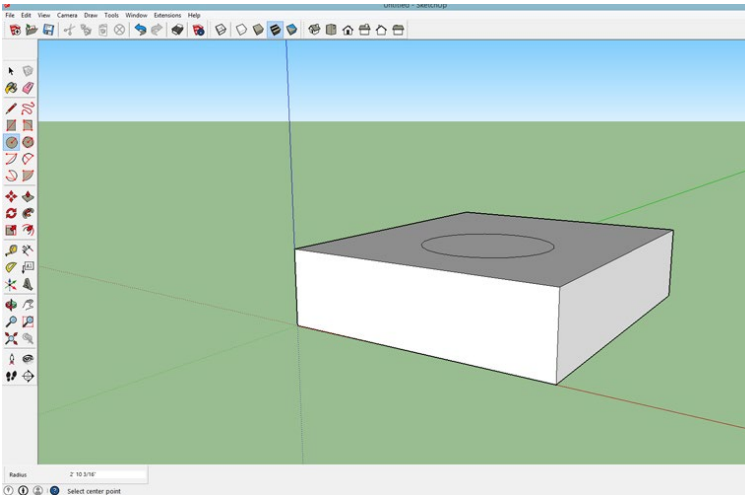

3. The same Push-Pull Tool is used to make circular holes. First use the Circle Tool to draw a circle on the top of the part.

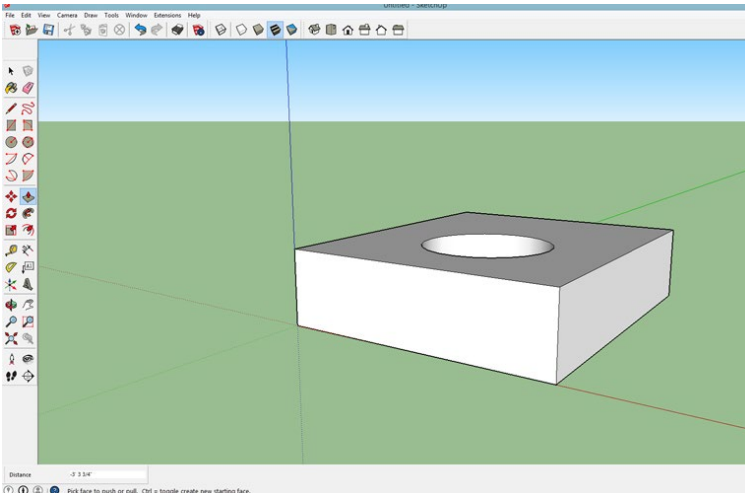

4. Click on the circle with the Push-Pull Tool and then move the mouse downward to create a hole.

GETTING REAL | 5

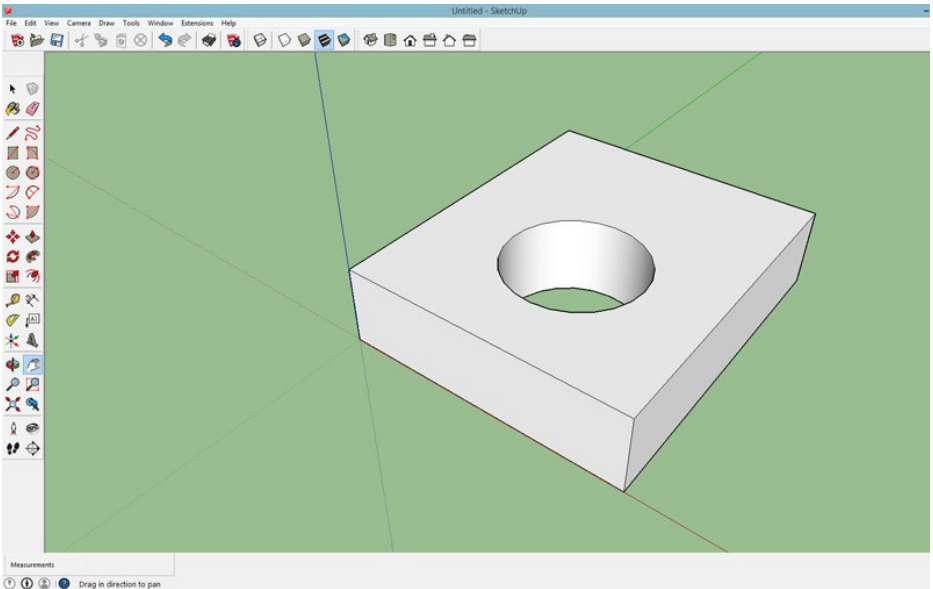

5. If you go completely to the bottom of the cube, the hole will extend completely through the cube.

**Want to help
keep MRH free?
Then click on
Ads!**

Frosted Ultra Detail							
1 actual inch = 25.4 millimeter							
	N scale		N scale	HO scale	HO scale	S scale	S scale
	Prototype		Prototype	Prototype	Prototype	Prototype	Prototype
	mm	inches	inches	inches	inches	inches	inches
Min Wall Supported	0.3	1.886	1-7/8"	1.026	1"	0.719	3/4"
Min Wall Free	0.6	3.773	3-3/4"	2.051	2"	1.509	1-1/2"
Min Wire Supported	0.6	3.773	3-3/4"	2.051	2"	1.509	1-1/2"
Min Wire Free: (if not bearing weight)	0.8	5.030	5-5/16"	2.735	2-3/4"	2.012	2-1/8"
Min Wire Free: (if bearing weight, like a sprue)	1.0	6.288	6-5/16"	3.419	3-7/16"	2.515	2-1/2"
Min Embossed Detail	0.1	0.629	5/8"	0.342	5/16"	0.252	1/4"

6. These design standards summarize the main thickness requirements for Frosted Ultra Detail printing using Shapeways.

Shapeways (shapeways.com) to print my parts since I began using this technology in mid-2013. This firm caters to hobbyists, artists, and others and has a very good support staff if you run into problems.

Design standards

What you can make using this technology is limited by your scale and wallet. There are both minimum and maximum sizes for what can be printed, as well as minimum sizes for supported and unsupported walls and sprues. Shapeways lists these factors in millimeters by material. I've taken those factors for the most common material used for model railroading, Frosted Ultra Detail, and converted them into scale dimensions by scale [6].

For example, the minimum thickness for a wall which is supported on two or more sides is just over 1 inch in HO, but it must be at least 1-7/8-inch thick in N scale. These design standards need to be kept in mind while designing your part. If something is too thin to be successfully printed, Shapeways will let you know soon after you upload the file.

GETTING REAL | 7

Each 3D printer and material type has limits on how small a part can be and the maximum size it can print.

These limits are also listed on the Shapeways website. The maximum size which can be printed is (in actual inches) 11 inches high by just over 7 inches wide and just under 7 inches long. The smallest part which can be printed is determined by adding the height, width, and length of the part in actual inches. Those three dimensions must be larger than $\frac{1}{2}$ inch.

I have designed some very small parts which would have been too small for Shapeways to print.

In those cases, I simply added a sprue to one end of the part to meet the minimum size requirement and then cut off that sprue once I received the part.

Within these limitations, your imagination and wallet are the only factors.

FINISHED Details

OVER 1000
UNIQUE DETAILS

WWW.
modeltechstudios.com



Rusting Car
Skeletons



Coal
Conveyors

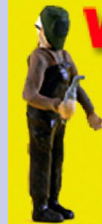

Welders



Steam
Boilers

N HO

S O

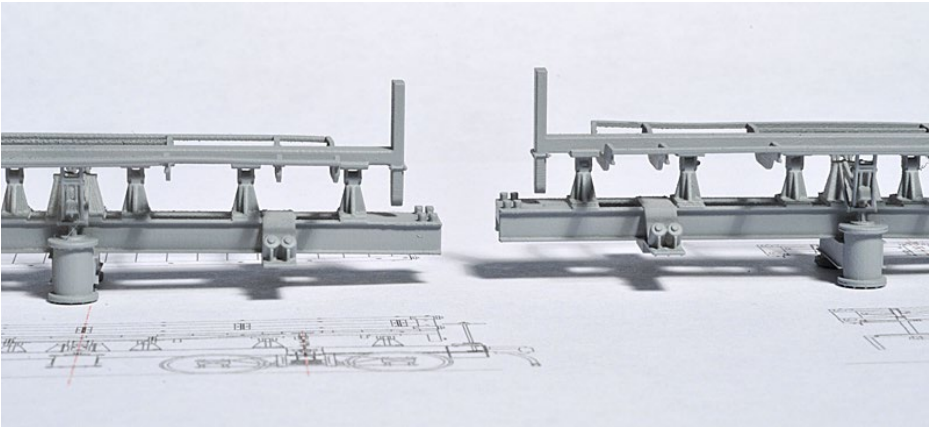

7. On the left is a Shapeways print in FXD, while a FUD print is on the right. In HO scale, I couldn't see any difference.

The cost

The cost of parts printed by Shapeways is dependent on the material being used and the volume of material used to print your part. There is also a fixed \$5.00 charge per part, plus a fixed shipping charge of \$4.99 per order.

For model railroad parts, I recommend using only Frosted Ultra Detail (FUD) or a newer material, Frosted Extreme Detail (FXD). I used FUD exclusively until FXD became available and then I tried it once. Printing with FXD took longer to get into production and the printing time took longer. FXD is also about 25 percent more expensive. Upon comparing identical prints of the two materials, I could not see a difference between them and will thus continue to order parts in FUD, for at least the time being [7].

Note that it is the actual volume of material being used that determines the cost and not the overall size of the part. I drew

GETTING REAL | 9

up a set of HO stairs for a project [8] which cost just under \$12 plus the shipping charge.

Months later, an O scale modeler emailed me and asked if I could make that same part available in O scale. That was a simple request and I only needed to upscale the part by 181 percent. But the price for the O scale stairs came to nearly \$80!

The problem is that doubling the scale of the part actually increases the volume of the part by a factor of eight. As an example, a cube 1 inch square would have a volume of 1 cubic inch (1" times 1" times 1"). But a 2 inch cube would have a volume of 8 cubic inches (2 times 2 times 2).

I could have reduced the price by reducing the size of the various components but it still would have been more than he was willing to pay.

October?
click to know more



Proudly made in the U.S.A.

Since 1933



www.microscale.com





8. In HO scale, these stairs cost under \$12. Printing them in O scale would have cost nearly \$80 because of the volume of material used.

To date, I have drawn and uploaded about three dozen parts. They tend to be either very complex parts or very small parts. Both can be difficult to scratchbuild. All were in HO scale.

In such cases, the cost was not really a factor for me since the option was to not build the model at all or to compromise the project. But keep in mind that larger parts will cost more than smaller parts.

Shapeways has several suggestions to keep in mind to reduce the cost of printed parts. For example, when feasible make models “hollow” to the extent possible.

For example, a simple 8 by 10 foot shed 8 feet high with a sloped roof will cost about \$133 for a solid print of the shed using Frosted Ultra Detail material. But if the walls of that same shed were reduced to 2 inches thick, the cost would be about \$26.

GETTING REAL | 11

Being an impatient modeler, I tend to order a part as soon as I upload it. The cost of that single part includes the \$5.00 per part fixed charge. I should hold off until all of the parts for a project have been uploaded and are determined to be printable by Shapeways. But, don't order them just yet. Once you have received acknowledgment from Shapeways that all of the parts can be printed, put all of those parts into a single file and connect them with a sprue. You can then upload and order all of the parts together, limiting the \$5.00 fixed charge to the entire sprue [9].

Using SketchUp

If I have convinced you to give this new technology a try, download the SketchUp program. The Trimble website will encourage you to download the trial Pro version. (You do not need the Pro version since everything you need to do can be done with the free version.) The Pro version cost \$495 at one time but is now

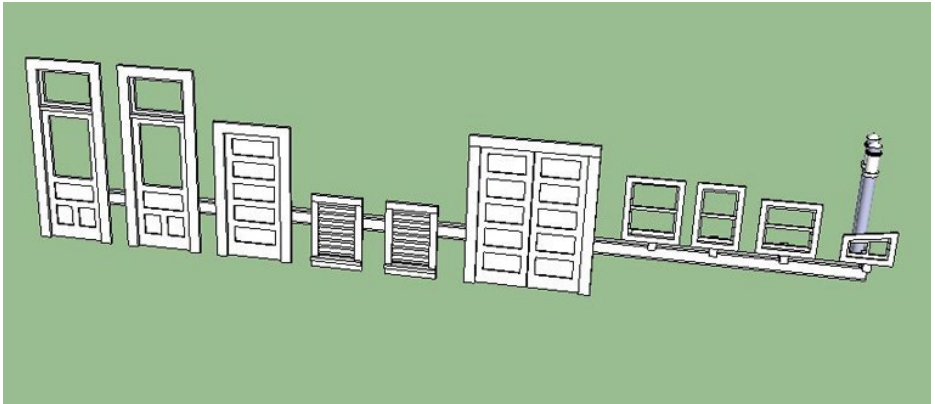

9. This single sprue includes three doors, two attic windows, a pair of double doors, four miscellaneous windows, and a pair of smoke stacks. The cost of the entire sprue of parts is \$16 plus the \$5 shipping charge.

apparently available for a yearly “rental” fee. Just download the free version.

When you first start the program, you will be presented with a welcome screen. Click on the Choose Template button in the upper right. I suggest selecting the Simple Template, Feet and Inches, and then click on Start Using SketchUp. Once you have selected this template, it will be the default template and you will not need to select it again.

When the work space opens, you will see the three axes – red, blue, and green – and a graphic of one of the Google team members from when they owned SketchUp. Mouse click on the team member and hit Delete to get him out of the way. Google added a different team member to each upgrade as a way to allow a user to gauge the general size of the object being drawn. The member of Version 15 is Greg.

When you get to the main screen, you will want to add more tool bars to the basic set to have them readily available. Click on View/Toolbars. I like to have these tool bars on my screen:

- Large Tool Set
- Measurements
- Standard
- Styles, and Views

The Instructor dialogue box with additional help about the selected tool will also be visible. When you no longer want it taking up screen space, use Window/Instructor to remove it. Note that when you hold the mouse arrow over a tool, the name of the tool appears along with what the tool does. When you click a tool to select it, additional information and options

Heckman's Canadian Pacific A Photographic Journey

by Ralph Beaumont

Joseph Heckman was a pioneer photographer for the Canadian Pacific Railway. He photographed the line from coast to coast between 1898 and 1915, capturing the engineering works, stations, hotels, steamships, and the people who made the railway run. More than 4,000 of these historic images are preserved in the CPR's Corporate Archives, and 380 of them have been made available for this large format, hard cover book.

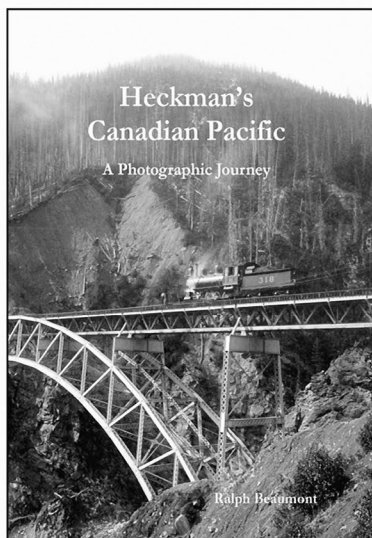

\$60.00 + Shipping & GST

ISBN 978-0-9784406-1-9

Large 9 x 12 format

Hardbound

328 pages - 380 B&W Photos

25 Maps, Index, Bibliography

Available June 2015 from:

Credit Valley Railway Company

2900 Argenta Road, Unit 24

Mississauga, Ontario, Canada, L5N 7X9

Canada/USA Toll Free: 1-800-464-1730

Online at: www.cvrco.com

MRHMAG.COM

- [TABLE OF CONTENTS](#)
- [INDEX](#)

appear at the bottom of the screen. While it is easy to “doodle” in SketchUp, the measurement box at the bottom of the screen lets you input exact dimensions using the feet and inch symbols. Regardless of your modeling scale, always draw full size and reduce the file to your chosen scale later.

If there is one “trick” to using SketchUp, it is that it is slightly different than typical drawing programs.

With drawing programs, you normally click at the start of a line, drag the mouse to the second point, and then release the left mouse button.

SketchUp is different. You still click on the start of a rectangle, circle, or line, but you then release the left mouse button and simply move the mouse arrow to where you want the box to end, and then either click to finish the item or stop and type in the desired dimensions.

For example, after releasing the left mouse button, use the keyboard to type in the size of that item in the measurement box at the bottom of the screen. If you are drawing a rectangle, you can type in “4,3” to create a rectangle 4 by 3 inches. Keep this in mind as you start working with SketchUp and it will quickly become instinctive.

One simple project

To illustrate the power of SketchUp, let’s look at a

ADVERTISEMENT



SmartSwitch™ ANE MODEL

New SmartFrog™ is coming

Let you rid itself of manual switching on your turnout frog. From now on, turnout Frog polarity change automatically is not a dream. ANE MODEL New version SmartFrog™ Let your dreams come true!!

- Frog polarity change automatically
- Two LED output for turnout signal control
- Independent Operation or Connect SmartSwitch™ Interlock Control

ELECTROFROG

GETTING REAL | 15

relatively easy project. A couple of years ago I was building models of a Fairmont T27 extinguisher car and a nearly identical T28 trailer in Proto48 scale. The 48-inch-diameter water tanks on these cars rested on a pair of wooden tank supports. From the remains of a T27 in Railtown 1897 State Historic Park in Jamestown, California and prototype photos [10], I knew that these supports were 4 inches wide, 36 inches long, and 6 inches high. The thickness of the support under the tank was 3 inches. Before the availability of SketchUp, I would have wrapped a piece of sandpaper around a scale 48-inch-diameter piece of tubing and tried to evenly sand four scale 4x6 pieces of

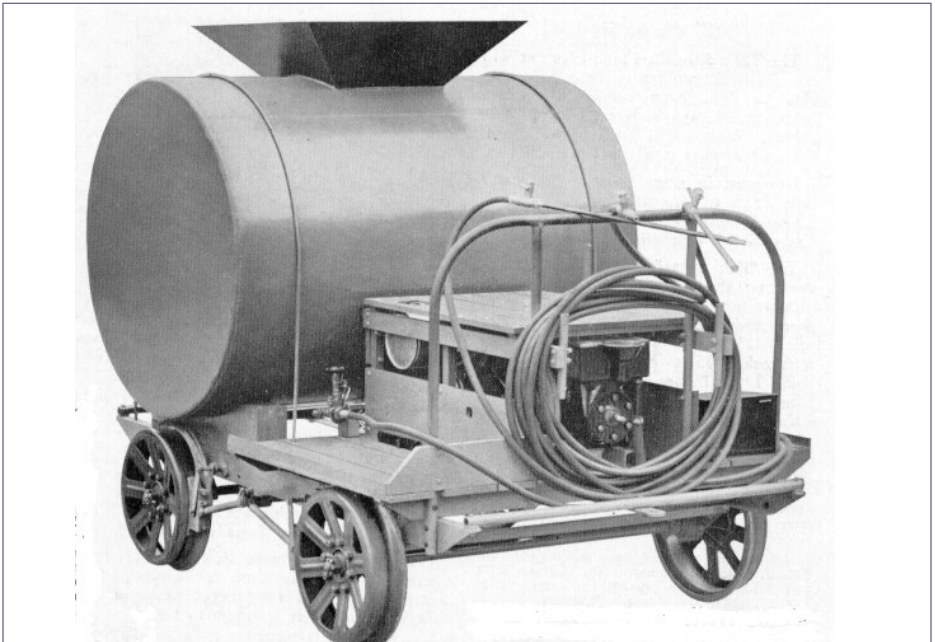

10. A Fairmont Motor Company photo of a T27 extinguisher car. The wood tank supports can be seen between the water tank and the frame.

GETTING REAL | 16

stripwood to create these supports. Drawing them in SketchUp is more accurate and took only 5 to 10 minutes [11-20].

It would be impossible to describe how to use each tool in SketchUp in a single article. Instead, I suggest two alternatives. One option is to purchase a book describing each tool, how to use them, and everything else you might want to know. I found the book *Google SketchUp – The Missing Manual* very complete and easy to use. It even has a chapter on importing building photos into SketchUp and using the tools to develop scale plans for the building. It is available from Amazon. I read the first couple of chapters and followed the detailed description of drawing a bench, which provided a good overview of the program. It is a handy resource as you work on more detailed projects.

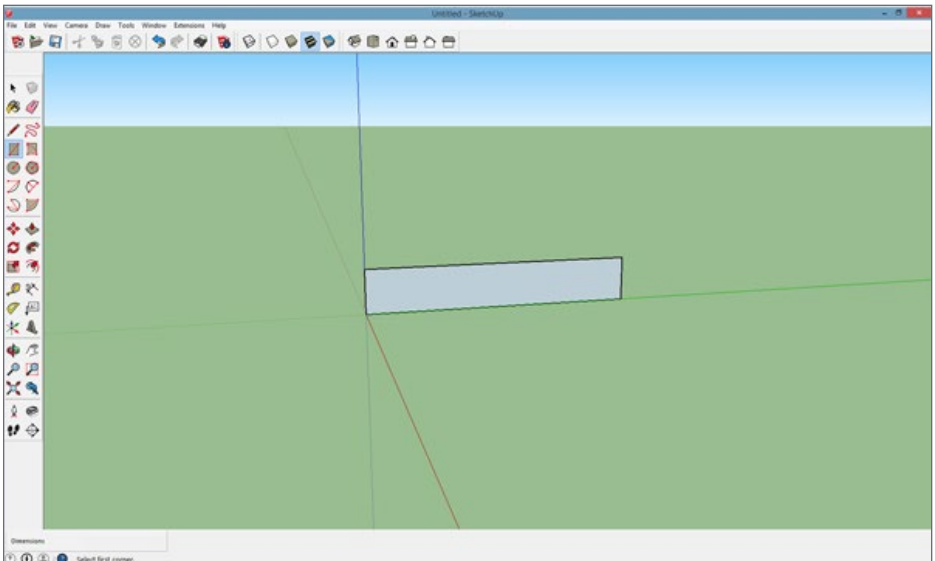

11. Start by drawing a rectangle 36 inches long and 6 inches high. That is the height and length of the timbers used by Fairmont to make the water tank supports for the car.

12. To create the center-lines of the timber and the water tank itself, select the Tape Measure Tool and click near the center of the left edge of the rectangle. “Hesitate” near the top center of the rectangle and the tool will snap to the vertical center of the rectangle, creating the first centerline.

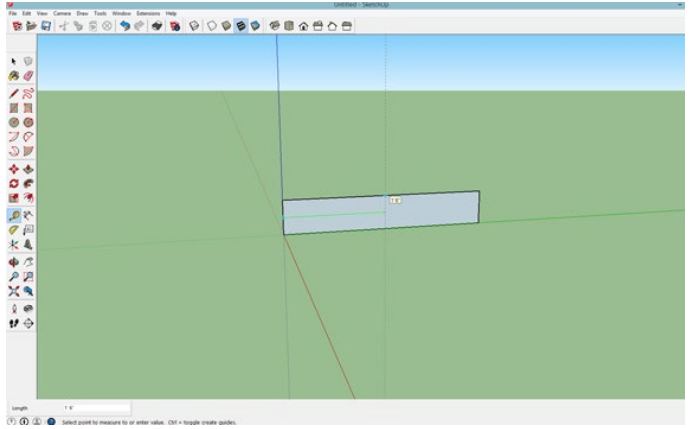

13. Using the same tool, start at the bottom of the rectangle and hesitate near the center. The tool will snap to the horizontal center of the rectangle. This centerline is also 3 inches from the bottom of the rectangle and thus the bottom of the 48-inch-diameter water tank.

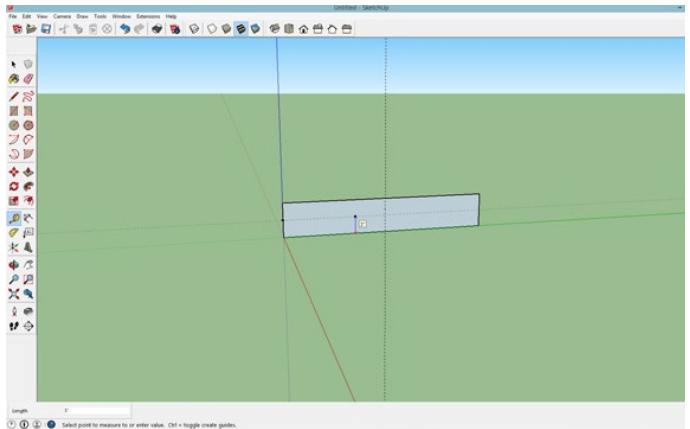

14. Now use the same tool and click on the horizontal line. Drag upward and type "48" into the measurement box on the bottom left of the screen. That will result in another guideline 48 inches above the centerline of the rectangle. That is where we need to draw the circle representing the 48-inch-diameter water tank.

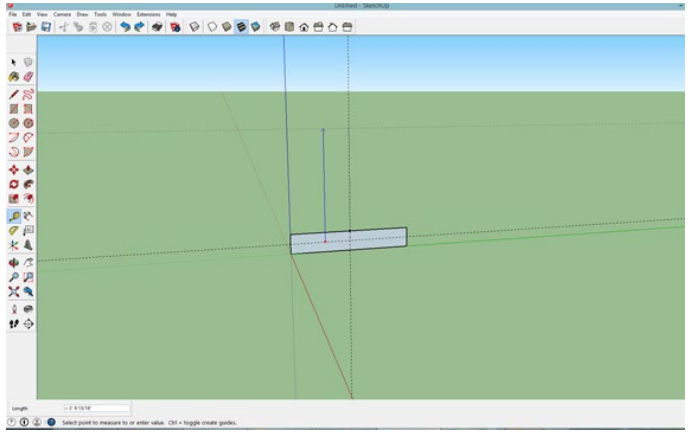

15. Select the Circle Tool and click on the intersection of the two last guidelines. Start drawing a circle and then type "48" into the measure box to create a 48-inch-diameter circle.

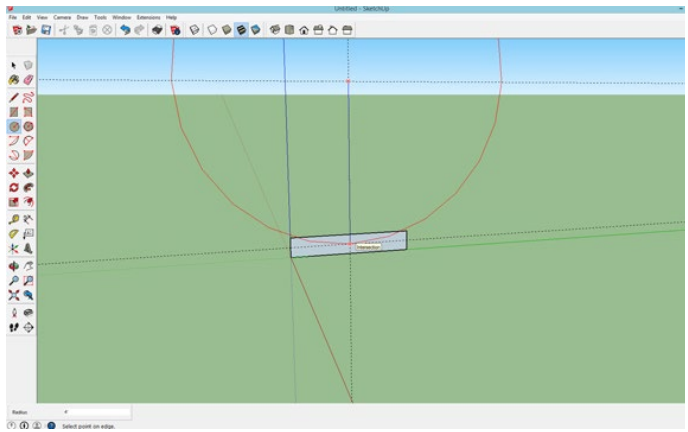

GETTING REAL | 19

16. Here is the result with a circle equal to the water tank diameter, the bottom of which is 3 inches above the bottom of the rectangle.

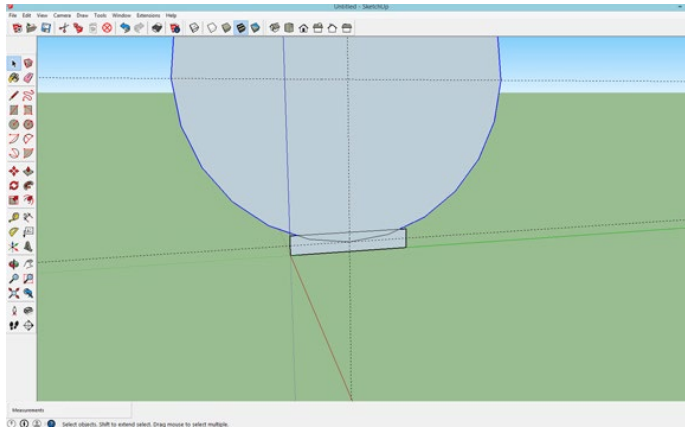

17. When one shape overlaps another shape, as in this case, it results in three parts which are 1, the large part of the circle;

2, the remaining small part of the circle; and 3, the remainder of the rectangle. Click on the large part of the circle and hit Delete.

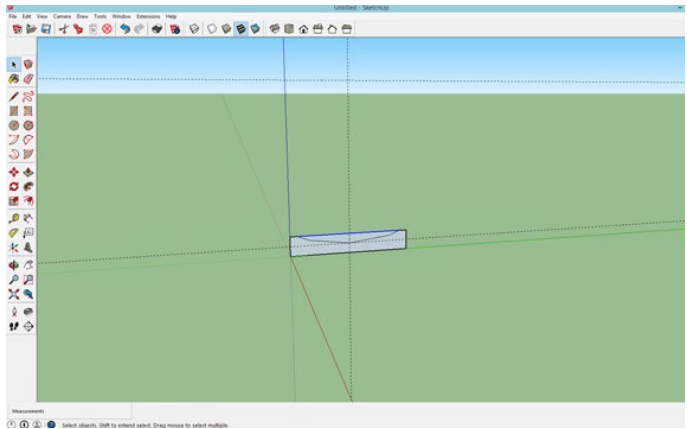

18. SketchUp creates circles with 24 segments rather than an actual “circle.” Those remaining segments are very obvious in

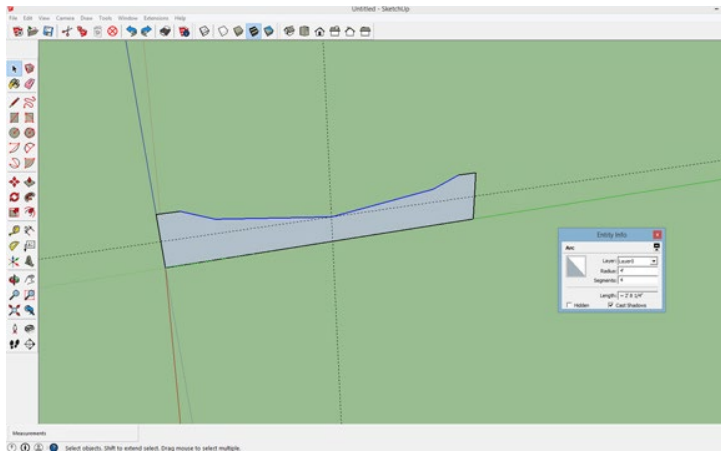

this view. Right click the remainder of the circle to open an Entity Info box. In the entry for Segments, backspace over the number and type in a larger number such as 24 in this case for just the remainder of the circle. If you are drawing a full circle, increase the number of segments to 96.

19. As soon as you do that, the remaining segment will smooth out.

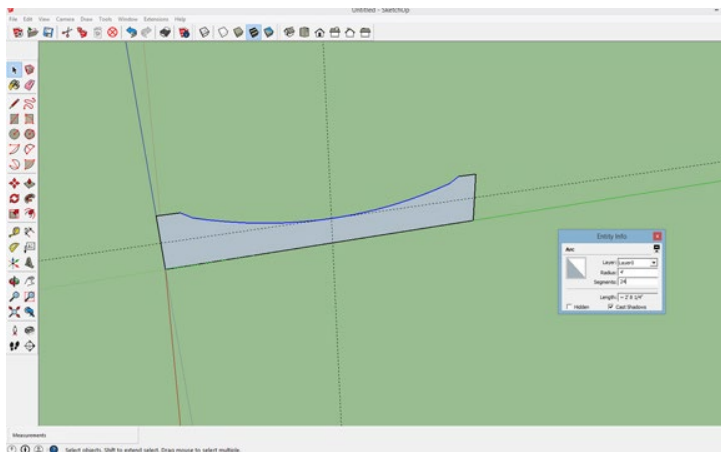

GETTING REAL | 21

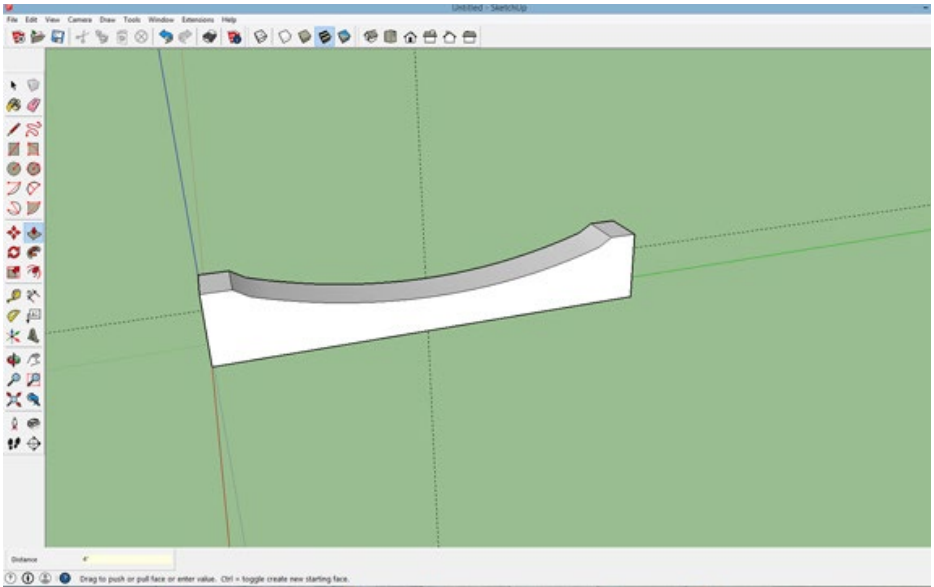

20. With the shape now finished, use the Push-Pull Tool to pull the face of the support “out” 4 inches, which is the width of the support. You are finished in less time than it would have taken to create them by hand! At this point, you could add NBW representations at the top end of the support (which I did) and then copy/paste the part to get the total number needed (four in my case) for the two cars. Connect them with a sprue, export them, upload the file, and order them. The four supports ended up costing about \$7 plus the \$5 shipping charge.

The other source of additional information is the series of Google SketchUp YouTube videos. These videos were professionally produced when Google owned SketchUp. Log into YouTube and search for *Getting started with SketchUp - Part 1*. Note that these videos were produced by SketchUp but there are also a number of knockoffs with nearly the same name.

There are four beginner SketchUp videos plus other videos on the some of the different tools, all from Google. All together (although some are not very informative), there are nearly 600,000 videos dealing with SketchUp. I have used the YouTube resources to find help for specific drafting challenges such as how to draw a coil spring for a railroad truck side frame. But I also note the number of views for each video and skip those with low viewer numbers.

Saving your work

For complex projects, I like to do a “Save As” of the file each time I complete a major change. You never know when something you did earlier will turn out to be the wrong choice later on. For example, if I am drawing a pulley I might sequentially name the resulting files “Pulley 01” followed by “Pulley 02” and so on. This will let me go back a previous version at any future date.

The next step

SketchUp files are saved as .skp files but they need to be exported as .stl files before they can be uploaded to a 3D printing service bureau to be printed. You can download a free tool called a SketchUp extension to do this. This extension is on a website called the SketchUp Extension Warehouse. In SketchUp (you need to be connected to the Internet at the time), click on Window/Extension Warehouse and then click on SketchUp STL which might be the first extension listed on the right side of the screen. Otherwise, type SketchUp STL in the search window. Once you are in this screen, click on Install and the extension will install itself in the SketchUp File menu.

With this extension installed in SketchUp, export your project using File/Export STL. The first time you choose the menu Export

STL option, you will be asked for the export options. Select the “Inches and Binary” option which will become the default.

One more step is needed before you can upload your file to a service bureau such as Shapeways. That step is completed using another free program called netfabb. This program is used to convert your file from feet/inches to millimeters and then to scale the full size part to your scale. Lastly, export the part as a .stl file and have the program check and fix any small errors. The steps necessary to use netfabb and where to download it are detailed on the clinic handout I have created for using SketchUp. That handout is at yosemitevalleyrr.com/clinics. This handout includes a lot of additional information.

Using Shapeways

Before uploading a file to Shapeways, you will need to set up an account with your user name and password. Once you have your account, click on the “smiley face” on the right side of the screen, select “My Models.” and upload the file. Simple parts will upload relatively quickly while more complex parts can take several minutes to upload and complete the initial file checking done by the Shapeways computers.

Once uploading is complete, the part will spin in a window which allows you to carefully make sure that the part is exactly what was on your computer screen in SketchUp. When you first start using this technology, holes might disappear or parts might be missing or a part might have other flaws. This is just the nature of using a new computer program and such frustrations will disappear completely as you gain more experience.

While you are hopefully congratulating yourself on a successful upload, the Shapeways computers are doing further checks

to ensure that the part can be 3D printed. These checks include the overall size of the part (too small or too large?), wall thickness (too thin?), “loose shells” (elements that might appear to be attached to the part but are loose and won’t print), etc. For complex parts, this process might take 5 to 10 minutes or so. Meanwhile, you will be getting an email from Shapeways congratulating you and telling you that you can order the new part. While waiting for that email, click on the link to Frosted Detail Plastic. Once your preferred material (FUD or FXD) has a green check mark, you are ready to order. If there are design issues, you can click on the issue to view what needs to be changed to pass these tests. Make the corrections and upload the file again to ensure that they have been fixed.

ADVERTISEMENT



Announcing
Motrak Models Flat Paint
Made by Scalecoat:

Rail Brown – White – Black - Silver
Aluminum – Oxide Red – RR Grime #1
RR Grime #2 – Boxcar Red – Roof Brown
Aged Concrete – Dirt – Sand - Rust
MOW Gray – Engine Black

Limited quantities - place your order now!

We still have other colors available from Scalecoat.

Phone number: 813-476-4784

Email: motrakmodels@centurylink.net

**CHECK
IT OUT!**

Summary

I tend to draw parts as close to scale as possible which tends to “push the limits” of the Shapeways design guidelines. A current project is building an HO model of the side dump which the Yosemite Valley Railroad purchased in 1927 [21]. I first drew up one of the C channels which form the basic frame and then exported just that single part and uploaded it to Shapeways.

On this first effort, Shapeways determined that the C channel flange was too thin. I thickened it in SketchUp by an eighth of

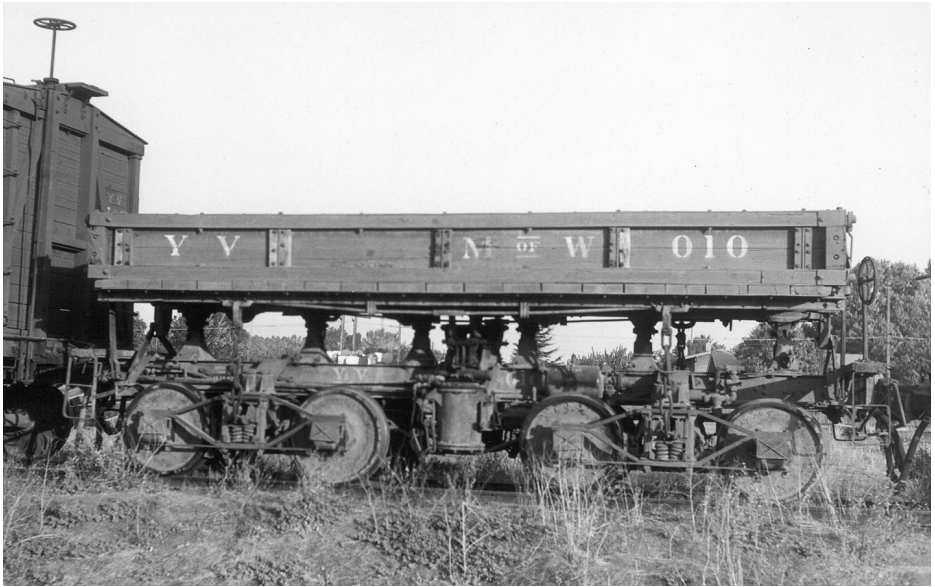

21. At first glance, scratchbuilding a model of this side dump car appears to be nearly impossible given the complex design of the frame, the pedestals which allow the bed to be tipped to either side, the U-shaped supports for the bed, and the complex rods and levers which actually tip the bed. However, with experience and by working methodically, it is completely possible.

an inch and tried again. Shapeways accepted that part so I proceeded with the bolsters, etc.

Each time I added a significant element to the frame, I uploaded the revised file to Shapeways and then kept going if everything was okay. The resulting SketchUp drawing included all of the parts for the frame and tipping mechanism [22]. The resulting print [23] clearly illustrates the power of this technology.

3D printing has an enormous potential for our hobby! It can be used to create models that would be nearly impossible without it.

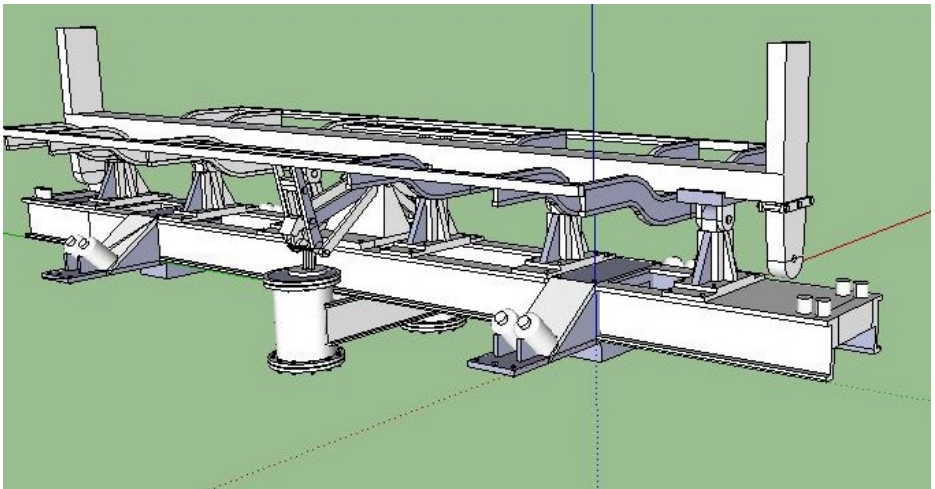

22. After starting with the pair of C channels, a bolster was drawn in line with and to the side of the frame. That bolster was then moved laterally to the truck centerline and a copy moved to the other truck centerline. The same process was used for the pedestals, air cylinders, bed supports, etc. This is a screen grab of the final frame which was printed as a single part.

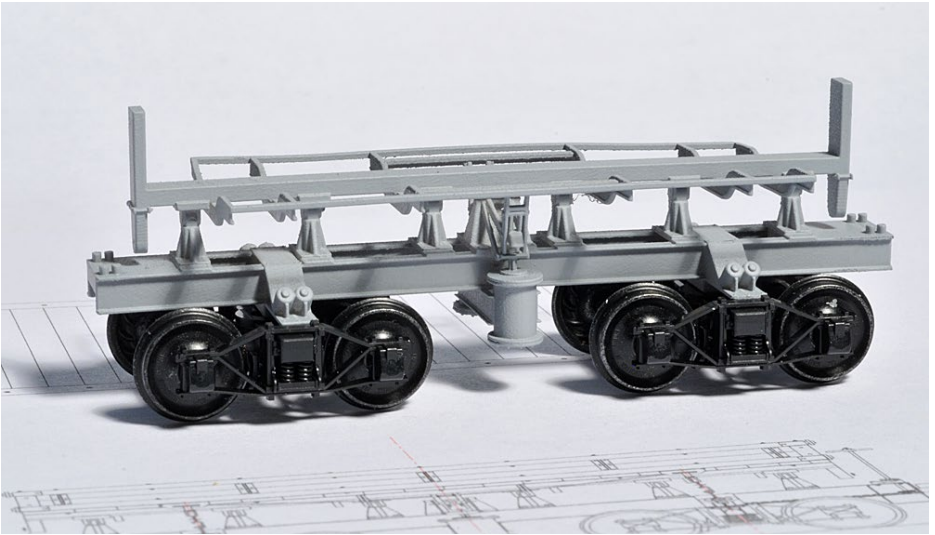

23. Here is the printed frame resting on the trucks. The bed itself will be built up with stripwood and the end levers and other small parts reproduced using photo-etching. As of this writing, the model is still under construction. But getting this far would have been impossible without using 3D printing.



[Click here for
reader comments](#)

NEW!

MRH 2016 Calendars!

Especially for model railroaders

~~\$18.88~~ **\$16.99**

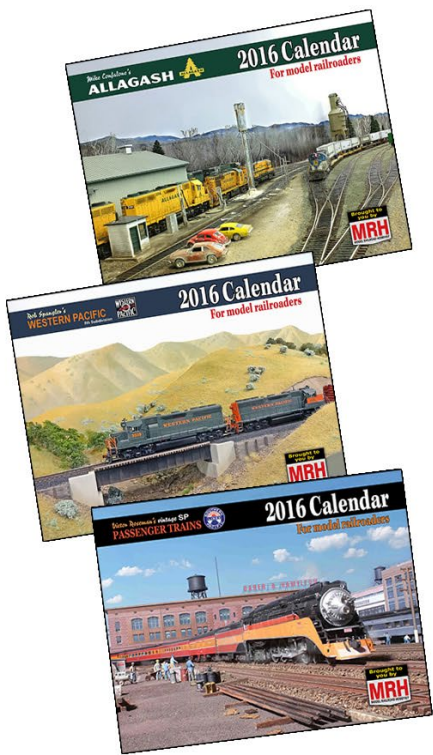

Has major model railroading events listed!



2016 JUNE

One half of Mike Cronline's "Teet" of two Alco RS1s teams up with an Allagash #322 on an evening wood chip train over on the grade at Hobson Mountain. The train is about to enter a deep rock cut as it struggles toward the summit in March 1984.

Sunday	Monday	Tuesday	Wednesday	Thursday	Friday	Saturday
	1 May	2 3 4 5 6 7 8 9 10 11 12 13	1	2	3 NCR regional June 3	4
5	6	7	8	9	10	11
12 Shenast	13	14 Flag Day	15 Salmon Arm, BC PDR regional June 15-19	16	17	18 Richmond, CA Bay Area RPS June 18
19 Father's Day	20 1st day of summer	21	22 Middletown, TN Low-Rail regional June 22-25	23	24	25
26	27	28	29 Kansas City, KS National V-Con. June 29-July 3	30		July 1 2 3 4 5 6 7 8 9 10 11 12 13 14 15 16 17 18 19 20 21 22 23 24 25 26 27 28 29 30 31

Mike Cronline's
ALLAGASH 

Buy your 2016 calendar NOW

store.mrhmag.com

Includes download link for free wallpaper of the images!



Model Railroad Hobbyist | October 2015 | #68

WHAT'S NEAT WITH KEN PATTERSON

KEN PATTERSON

column



[Click here for
reader comments](#)

ST. LOUIS PROTOTYPE MEET ...

THIS MONTH WE COVER THE PROTOTYPE

modelers meet in St. Louis MO this past August. We talk about track and layout design and some of the things to think about when planning a new layout. We have an interview with James Lincoln as he discusses his Proto:48 3D printed track details. We also cover tool tips with an overview of rotary tools. There is an interview with Mike Skibbe and the Midwest Mod-U- Track N scale layout. Plus Joe Steimann is up to his old tricks with a rocket-propelled flat car in G scale during my open house and bonfire in conjunction with the RPM meet. We also start a new video segment called "Modeling Ideas From Above" with prototype drone footage from our professional drone pilot Jon Dietzen. It really shows how our models should look. Great segments in this month's video for October 2015.

▶ [PHOTOS AND VIDEO OF SUPERB MODELS](#)

WHAT'S NEAT | 2



Playback problems? [Click here ...](#)

ADVERTISEMENT

Bachrus inc
RUNNING ON QUALITY

Click
me!

MRHMAG.COM

- [TABLE OF CONTENTS](#)
- [INDEX](#)

TRAINMASTERS.TV

*George Sellios'
Franklin & South
Manchester update*



Brought to
you by

MRH
MODEL RAILROAD HOBBYIST

Coming in October!

Non-members can watch for only \$1.49

Visit the TrainMasters TV website

MRHMAG.COM

- TABLE OF CONTENTS
- INDEX

WHAT'S NEAT | 3



During my open house for the RPM meet in St. Louis the question was asked, “I’m planning a layout. Ken, how do you plan your track layout? After that there was silence. I knew where to start but the answer would take an hour to fully explain. So

WHAT'S NEAT | 4

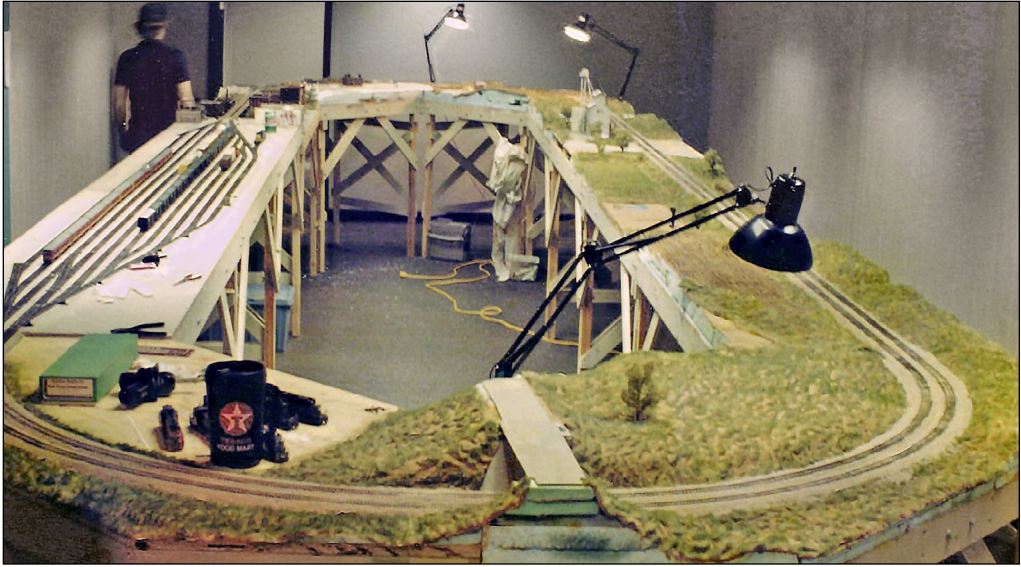

many variables come into play in covering this, like how do you plan to use your layout? Is it a runby layout with various prototype scenes modeled inch by inch or are you interested in *Continued on next page ...*

WHAT'S NEAT | 5

operation with switch lists? What is the minimum radius your largest models will run around? How many people do you want to entertain and run trains with? This determines your aisle sizes. Placement of your buildings and towns determines where you choose to lay your track. Do you want to run it from one spot, "old school," or do you want to walk around with your train?

I designed a layout that I thought would work for a club in a building that I planned to purchase when I was a real estate speculator in the '90s. The design was for a 5000 square foot space where aisle space was to be 4 to 5 feet and minimum track radius was 49 inches. These two factors determined the layout design that I built. A 1/48 scale planning model is shown in the photo on the previous page.

When I designed and built the Midwest Valley Modelers layout the two main factors in its design were constantly running trains and a well-designed viewing perspective with good lights and flowing realistic scenery throughout. In the video I share a lot of photos that show various layouts that I have built over the past 42 years [1-4 previous page].

Later in the video we talk about Dremel rotary tools, the old ones and the new ones on the market. We talk about the various uses for our hobby, like cutting track, and wire brushing the rail for good solder contact. Cordless and corded models are shown with after market handles. Drilling holes with small number bits is easy with the cordless lithium Dremel's slow speeds. I also talk about the older style Dremel rheostat that allows very slow speed control when drilling holes for your nut and bolt castings [5-6].

WHAT'S NEAT | 6



[Click here for reader comments](#)

WHAT'S NEAT | 7

This month I take you to the St. Louis RPM Meet that was held this past August. 400 people registered for the show which featured thousands of models from locomotives and freight cars to buildings, boats and bridges. Many vendors were there with tools, trains, detail parts, books, photos and building kits for modelers in every scale. The weathering artists of every era were in full swing with prototype rust and graffiti effects shared and taught real time in some of the booths.



[Click here for reader comments](#)

WHAT'S NEAT | 8

We find Jim Lincoln on a park bench for a discussion about his 3D printed track parts for laying Proto:48 turnouts. He explains how this process can take two months per turnout, making each piece of hardware necessary to scratchbuild an exact model of a switch. The detail is breathtaking..

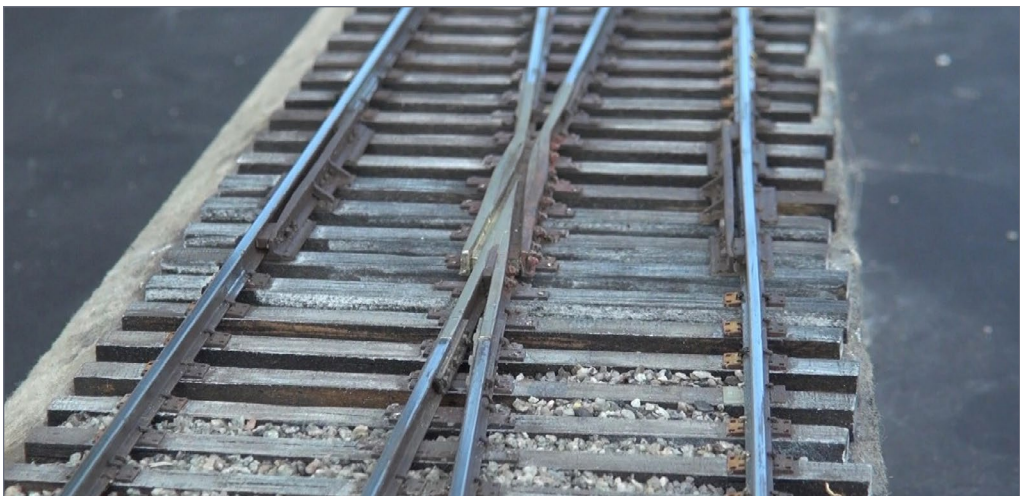

WHAT'S NEAT | 9

We interview Mike Skibbe, a member of the N scale Midwest Mod-U-Track N scale layout. He discusses how this group, that always had an HO scale layout in the Chicago area, decided to jump into N scale with a fantastic modular layout that was set up at the RPM show. The scenery flows from module to module with Midwest farm land scenes in between towns and rivers. These guys are professionals.

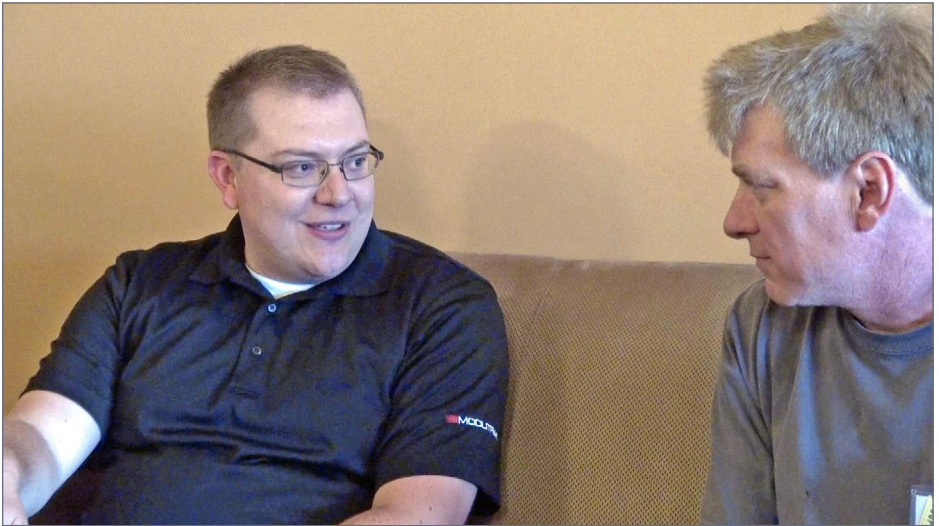

WHAT'S NEAT | 10

This month we start a new segment, “Modeling Ideas from Above.” It features drone footage of various prototype railroad locations from 50 to 100 feet in the air. In this video you can see a thousand things from the same height we view our layouts. Grass patterns, the colors in roads, and colors of people, cars and buildings tend to be subtle and blend when viewed from the air. It’s rich and exciting video you won’t forget.



[Click here for
reader comments](#)

WHAT'S NEAT | 11

After attending the show for two days, that Saturday evening I had an open house and bonfire on the bluff of the Mississippi river. Jon Dietzen brought over his drone and flew it along the bluff. He shot great video of the garden railroad and its scenery. His system was run from his cell phone giving him data and an image view in real time. He shot this still photo of the house



WHAT'S NEAT | 12

after sunset with us standing in the frame as we were moved by this cool flying craft and its possibilities.



WHAT'S NEAT | 13

During the open house the trains ran fantastically inside and out under the supervision of Daniel Coombs, who made sure the trains ran all night. I took the opportunity to show off all the new Athearn models that I had been shooting for the past six weeks. There were a lot of ooohs and aaahs over the rainbow of paint schemes on the various locomotives.



During the bonfire the garden railroad was running great with a lighted Amtrak Amfleet consist. Joe Steimann suggested burning down the G scale 20-foot trestle. That was nuts. Bad idea. So we convinced him to work off his desires on a G scale flat car loaded with Estes rocket motors to see what would happen. What happens next is all on video, real time. Funny and cool at the same time to end this month's "What's Neat" video.

WHAT'S NEAT | 14



[Click here for
reader comments](#)

iwata

by ANEST IWATA

Just Rolling By...

Make It **REAL** With Iwata *Climb Aboard!*



**Eclipse
HP - CS**

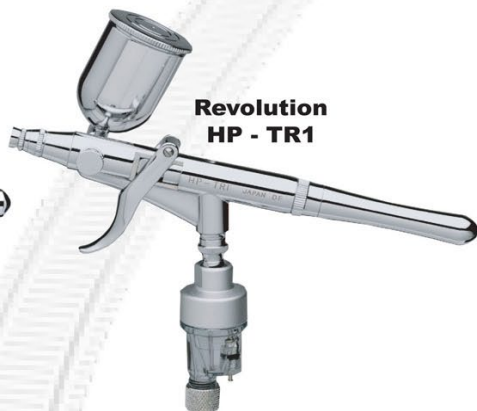

**Revolution
HP - TR1**

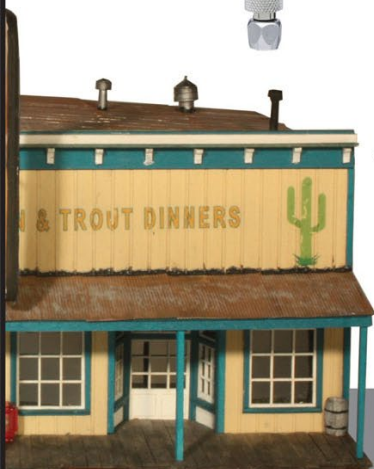

Visit... www.iwata-medea.com

To Check Out Our Full Product Line!

*Models By... Alan Houtz,
North American Prototype Modelers*

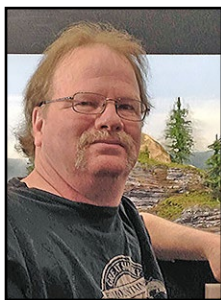

IMAGINEERING

column

MICHAEL TONDEE
.....



[Click here for
reader comments](#)

MODELING A SIGNATURE SCENE

| A LOT OF IMAGINATION AND A LITTLE
RESEARCH BRING A PROJECT TOGETHER

AS A FREELANCE MODEL RAILROADER, A LOT of things over my years in the hobby have influenced me and my idea of what a model railroad should be. I thought the best way to introduce myself is to share one of my modeling projects.

One of my favorite model railroad scenes is a picture from John Allen's original 3 x 7 Gorre and Daphetid. It's a night scene of a lit passenger train crossing the small trestle above Taylor Lake: the whole area with the trestle, lake, dam, and mill makes a great "signature scene." Of course, once the G&D was expanded to a larger layout, this became just one of many memorable scenes.

My layout, the "Blackwater and Blue Hollow," is nowhere near the size of the G&D, but it does need at least one signature scene. Obviously, I didn't want to copy someone else's scene, but the

▶ EXPLORING THE CREATIVE SIDES OF THE HOBBY

aforementioned one from the G&D has always been a favorite of mine. My layout already has a trestle and a small lake partially done, so it seemed natural to add the mill. While my scene is not quite the same, it would still be along the lines of the G&D scene and hopefully a tribute to my favorite modeler of all time.

Given my penchant for deep three-dimensional scenery and because this idea was something of an afterthought, I didn't have room on my two-foot-wide shelf for the dam and mill. To add it would involve widening my benchwork on the front by 8 inches.

Part of this new scene would also need to be lower, because the mill must sit below the dam. But the rest of the new area could be made the existing height and provide room for some foreground scenery and /or an industry.

After some calculation and testing, I determined that adding the extra 8 inches to this part of the layout was not going to cause me any reach issues, so I went ahead and made the change.

Composing the scene

Once the benchwork issue was solved I turned my attention to scene composition. While I usually have a strong picture in mind of how a scene will look, visual experimentation can help refine the final look.

As it turned out, my benchwork gave me a little extra room to work with [1]. I might put a few more ancillary buildings around the mill, or maybe add some new forest to suggest an area had been cut over to fit the mill in. Maybe a combination and balance of both. Whatever the elements might be, they needed a high level of detail because the scene is right out front: you can't miss it.



1. This is the lowered area for the mill. The original level of the layout plus slightly lower site for the lake can be seen in the background. The mill building is sitting in place to help illustrate how far the benchwork must be lowered to accommodate it and the height of the water wheel.

Sorting out the steps

First I needed to plan the dam area and millrace, which would also help to establish the final position of the mill. It may sound convoluted, but often when adding a feature like this, “one hand washes the other.”

IMAGINEERING | 4

The mill kit had to be built because it established dam height. And the dam must be built to define the mill location. There isn't a lot of room here though, so the millrace must be short.

As far as the dam type, I first thought of making some an earth and stone amalgamation. Considering the mill itself is already on a stone foundation made of plaster, and I find it easy to cast and carve plaster, I made another casting.

I found an old picture of a long-abandoned truss bridge crossing a stone mill dam from my home state of Georgia. Although strict prototypical accuracy does not drive my modeling, it's nice to have it reinforced by what "could have been." Besides, I'm not sure my railroad would have erected a bridge over an earthen dam, so a stone dam it was.



2. The mold and scrap rail for the dam. I filled the mold with plaster and once it set, I carved the stonework with an X-Acto knife. I soldered the scrap rail together and didn't worry about being too neat. In fact, the whole mold need not be all that pretty, either.

Making a plaster casting is not at all difficult, and I can use a variety of materials to make the mold. My favorite mold material is a cheap plastic “For Sale” sign available at any discount or hardware store. They can be cut with scissors and glued together with liquid plastic cement.

After figuring out the dimensions, I cut the pieces and put them together with the cement. Then I built a grid work out of scrap rail to make the dam casting stronger. The grid work step came from a suggestion on the MRH forum and one I haven’t used until recently.

I used the rail gridwork on the foundation for the mill and again here [2]. Metal “rebar” is used in real construction with concrete and it adds quite a bit of strength. I accidentally dropped the dam casting when removing it from the mold and it didn’t break!

Once I had cast and carved the stone dam, I colored it with acrylics and an India ink wash. Setting it in place took a little bit of experimentation. As I stated earlier, I needed to build the mill to set the dam height. I wanted the millrace to have some drop in height to it, but I didn’t want the top edge of the dam too high. Making the top of the dam too high would require building up the lake surface too much, either with plaster or two part epoxy [3].

Now it was time to build the millrace. If you look up that word on Google you will get many hits and images. A “millrace” is an artificial water channel carrying water to or from a mill. The word also is interchangeable with a “sluice way” which controls the flow of the water by a gate or “sluice,” hence the name.

Building from imagination

Since my mill is close to my dam, my millrace is not very long. I used scrap balsa and scraps of scale lumber from a kit to construct it. I didn’t follow any plans. I just used my imagination, my recollections of actual mills I’ve visited, and a few photos off the Internet.



3. The dam in place with preliminary scenery built around it. I did have to build up my lake surface just a tad more. Also note the cutout on the right and a shallow one on the left as well. They are for the millrace and an overflow respectively.

Most of these dams have some type of overflow in addition to the area where water is channeled to the wheel. I assume this is for when the sluice is closed or flood conditions exist. I put my overflow to the left as shown in the photo [3].

I also needed to model an area in front of the wheel to carry off water leaving the mill, this being an extension of the millrace. To model this, I cut away some of the cardboard I used when I built the mill kit and foundation, and then cut a slot into the plywood below.

During this I also thought about access to the mill. How would wagons or trucks have gotten to the mill to bring in corn or

supplies, or how did they take away ground meal? Such details would be important to the finished scene.

Sometimes when building a scene toward the back of the layout, I will take shortcuts and let the viewer make assumptions and fill in some details. Your mind can trick you into a lot of visual foolery.

In this case with the scene at the front of the layout, not only does it need a high level of detail, but I didn't want to back myself into a corner that I could not get out of.

Logical designs

Scenes need a certain amount of logic to them, especially when right out in front on the layout. I could not just explain away incongruities. I might get away with running a road or a small stream of water off the front of the layout, though. Just modeling a cleared area with no sign of access won't work like it might in another scene farther back.

It may seem I make this up as I go along, but a lot of these things occur to me just days or hours before I actually have to finally decide, so I think several steps in advance. That's just how the creative process works for me. Others may need to do more advanced planning, and there's nothing wrong with that.

Once I got the millrace above and below the wheel taken care of, things started coming together with the millrace from the dam to the wheel to the sluice [4].

Next, I mapped out the path water would take from the overflow, or spillway, on the other side of the dam. I added scenic textures with different grades of ground foam. By building the mill on its own base I could easily move it in one piece. This

IMAGINEERING | 8

allows me to move it in and out of the scene as needed. Adding the textures as I go helped me to visualize where to put natural features like rock faces.

The ‘aha moment’

At this stage, things slowed down and the “several steps in advance” mode came to a crawl. I still had the vision of the scene as a general road map, but now the variables increased.

I may not look at scene for a few days or I may stare at it for five minutes, try something, and then come back about 20 minutes



4. A view from the side illustrates the millrace, the sluice and the supporting structure. I purposely left it unfinished for the photo to show how I did it. Note that in this position the sluice would be blocking the flow of water to the wheel.



5. This is the status of the scene after some preliminary scenery and a bit of “roughing in” of watercourses. At this point I decided to let things sit and “percolate” a few days.

later. It all depends on when the creative juices are flowing or when that “aha moment” comes.

This is where the “imagineering” comes in for me. I must not force anything. I must believe the inspiration will come. By now I was working on trees and doing other less involved scenes elsewhere on the layout. I had thought about road access, but still had no firm decision.

I took a short break during a couple of days out of town, and I had to “consider the scene from afar.” I had to envision it in my “minds eye” again as I had first conceived it. When I got back and started working on it again, I had made some decisions about the logistics of how the mill connected with the outside world.

IMAGINEERING | 10

I made a few more additions, including some trees I had envisioned nearby and I added some rock castings. Nothing was really set in stone, but the scene started to look more like my vision [5].

At this point, I secured the mill and base in place with a couple spots of hot glue to avoid bumping and misaligning it. I used just enough hot glue to hold it down, but still allow removing it later if needed. Although I never mentioned it earlier, I had added a couple of golden white LEDs to the mill and run the wire leads out the back, out of sight from normal view.

I took some patching plaster and worked to finish the scene [6].



6. At this point I'm finding things come together with mill access: it's provided by a stone ramp, cast similar to the dam. A road fashioned from foamcore also leads away and I've started experimenting with tree placement.

Over the next few days, I did scenicking by using my base color of landscape paint, and then added various ground textures. I made some furnace filter trees and worked out the dimensions for an ancillary building nearby. I whipped up a structure in an afternoon using cereal box cardboard, some rough-hewn sticks, and a few pieces of shingle left over from the original mill kit. At this point, I added the layout fascia, followed by more scenery work and more experimentation with trees [8-9].

Then came a break from working on the scene. Some came from normal day to day circumstances, but a lot had to do with the ebb and flow of my creativity. Sometimes I would stare at the scene for a good 45 minutes and then walk away having done absolutely nothing.

Scenery modeling is 3D art to me and art can't be rushed! I knew that I would "know what I was looking for when I saw it." Then I could wrap up the scene do the "water pour."

After more odds and end details, the day finally arrived for pouring the Envirotex resin.

I waited for a good day to do the pour, that is until my family was to be gone most of the day. That way I would not have complaints about the "smell" or have interruptions. I can't really smell the stuff myself, but I did open a window or two just to be sure.

Epoxy pours make me nervous because there is a chance of ruining hard work, but this one came off without a hitch. I was pleased with the look of the final scene [10].

I hope stepping through this project gives you insight into my creative process and bit of whimsy involved. Every layout can have at least one signature scene, and maybe more. The only thing that limits them is the imagination of you, the modeler. We are all "imagineers" to one extent or another.





7. This shot shows the mill landscaping near done except for coloring and ground texture. I used patching plaster to fill in the areas around the building.

8. The scene continues to develop and evolve with different scenic textures and gravel for a road. I put a bare tree trunk on the left to judge tree height and placement. Foliage came later.

9. The almost complete scene is missing only water. The truck lends a sense of time and I just quick-scratched the shed from a cereal box, craft sticks, and leftovers from the mill kit.

IMAGINEERING | 14

I don't have a set direction for my part of this "Imagineering" column series. I might show more of my projects, or I might share some philosophy, or some combination of both.

And I hope we all have fun together! ☑



[Click here for reader comments](#)



10. This shows one of my favorite epoxy water effects, the reflection of the bridges.

*Learn to solder track, wiring and
brass models in this video!*

**CHECK IT
OUT!**



kenpatterson.com

click here to ...

Visit Ken's website

**Ken Patterson shows
you how to solder like
an expert!**





11. The finished scene also looks pretty good from ground level.



MRH MARKETPLACE

LOOK at what's new at Black Cat this month

Click here for our website

Terra Transport Containers in HO or N scale



Black Cat Publishing
(204)489-5005
ajfergus@mymts.net
blackcatdecals.com



Affordable built to order Benchwork starting at only \$20 a Sq Ft.

PRECISION DESIGN CO

Chains
Flat Car loads
Joint Bars
Signs & Posts

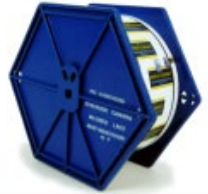

FREE SHIPPING

STREAMLINED BACKSHOP

Sales
... Services
..... Solutions

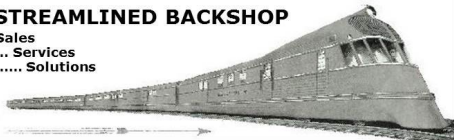

"SUGAR CUBE" SPEAKERS...

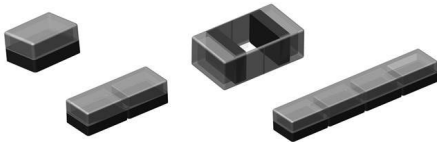

4 Sizes * 4 Baffles

... "Sweet" Speaker Options!



www.SBS4DCC.com

Trees

Evergreen
Conifers for HO,
N, S, and O Scales

Make Your Own,
Save Money and
Have Fun

Real Wood Trunks

All Components
Available
Separately

Made in Oregon, USA



coastmans.com

MRH MARKETPLACE | 2

Don't settle for lifeless signals!

We've got signaling circuits!



LOGIC RAILTM
TECHNOLOGIES

"Sophisticated
Model Railroad
Electronics"



Please visit our website and online store!

21175 Tomball Pkwy
Suite 287
Houston, TX 77070

Phone: (281)251-5813
<http://www.logicrailtech.com>
info@logicrailtech.com



AMERICA'S NUMBER ONE
RAILROAD PRINT SOURCE

Railroad Art-Prints,
Caps, Jackets,
Shirts and More ...
Jackets starting
at \$79.95

www.jelsma.com

1-904-221-3513 • Jacksonville, FL.



Yarmouth Model Works

HO scale resin kits and detail parts



..... U.S.A. MAILING ADDRESS
3560 Pine Grove Ave. Unit 617
Port Huron, MI 48060

Tel. 519-633-7574
pierre.oliver@start.ca

..... CANADIAN MAILING ADDRESS
85 Hiawatha St.
St. Thomas, ON N5P 2T5

www.yarmouthmodelworks.com



BenchWork^{.com}
Affordable track planning
starting at \$250



PRECISION
Laser Cut Details & Kits

HO DIESEL SUPPLY

Are you serious about your HO Diesel fleet or just tinkering? Either way
You probably bought just the right parts you needed from us already

BACKSHOP HARD PARTS DIVISION

Now Direct Personal Service

www.hodieselsupply.com

email:TheBoss@hodieselsupply.com



www.clevermodels.net



P.O. Box 6 Paonia, CO 81428

Ph. 970 527 4586

Made in The USA

Cast resin items for All Scales.

Tunnel portals, bridge piers, abutments,
culverts, and retaining walls.

Trackside details and sage brush tree
armatures.

"FREE SHIPPING see website for details"

Hobby Marketplace Ads are Economical and Effective.

MRHMAG.COM

- TABLE OF CONTENTS
- INDEX

CLICK HERE

CANYON CREEK
SCENICS

MOUNTAIN SUBDIVISION HOBBIES

www.modelrrsupply.com

FREE USA SHIPPING OVER \$29.00

NCE - SOUNDTRAXX - DIGITRAX - PECO - CIRCUITRON
DCC SPECIALTIES - INTERMOUNTAIN - CMX - ATLAS
BAR MILLS - BOWSER - KATO - MRC - TOMAR - RIX -
PIKESTUFF - LOGICRAIL - CENTRAL VALLEY AND MORE!

True Scene™ Modeling



FusionFiber™

Scenery Base Material for the 21st Century!

SATISFACTION GUARANTEED!

www.truescene.com or 716-523-7305

W GOLDEN AGE LINE
WESTERFIELD
MODELS, LLC

NEW N.A.R. STK CAR KIT!



RESIN KITS, DECALS,
DATA DISKS & DETAIL
PARTS AVAILABLE.
westerfieldmodels.com

Great Decals!™

FEC, Interstate, Virginian
Railway, & L&N Titles
After Hours Graphics Line
Coupler Gages and More
In O, S, HO, and N Scales

CUSTOMIZED SIGNS FOR YOUR LAYOUT
ADD A PERSONAL TOUCH TO YOUR LAYOUT WITH
A CUSTOMIZED SIGN.

WHETHER IT'S "AL'S GARAGE" OR
"BOB'S TOWING", WE'LL HELP
YOU DESIGN THE
PERFECT SIGN

LIGHTS 4
MODELS

UNIQUE PRODUCTS FOR UNIQUE LAYOUTS

[Click Here](#)

RULERS-of-the-WORLD

Scale Rulers \$4 each

Over 200+ scales!

Metric or Imperial

www.rulers-of-the-world.com

**HOBBY
MARKETPLACE**
ads are
economical and
effective.

Click [HERE](#) to learn more.

When talking to hobby vendors,
please remember to mention MRH.

Have you seen these popular blogs on the MRH website?

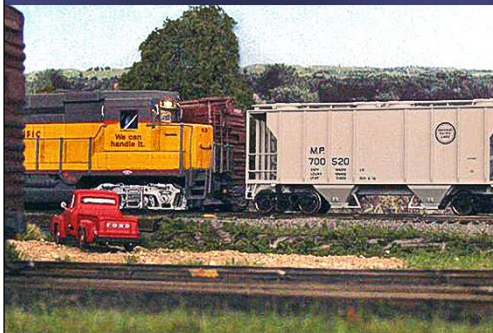

Ken Glover's Shelf Layout

76,000 reads

[CLICK TO READ IT NOW](#)



Mike Rose's N scale empire

166,000 reads

[CLICK TO READ IT NOW](#)



Your ad could be in this space for just \$84 a month.

[Click to learn more ...](#)

2016 Trolley Calendar

Color cover, 13 B&W photos with descriptive captions from mid-Atlantic area:

PTC, PST, SEPTA, LVT, H&F, Scranton, D.C. Transit, and others.

\$10 +\$2 S&H

To order the calendar by check or money order (payable to East Penn Traction Club), please send it to:

East Penn Traction Club
c/o Charles Long
227 Locust Road

Fort Washington, PA 19034-1425

[click HERE to learn more](#)

ALLIED MILLS

Building an engaging "mini-layout"



BY CLARK PROPST
.....

MRHMAG.COM

- TABLE OF CONTENTS
.....
- INDEX



1. Clark learned enough about operations at the prototype Allied Mills complex to feel it would be fun to model and also engaging to operate. Clark thought Allied Mills could illustrate how a robust Layout Design Element (LDE) can be a captivating mini-layout in its own right, so he went ahead and built it to illustrate the point, even though he has a layout already.



[Click here for
reader comments](#)

The power of the “one module” concept ...

WHILE THINKING ABOUT A RAILROAD PROTOTYPE

Modelers (RPM) meet clinic I needed to make, I came across several intriguing photos of Allied Mills in the archive department of the local library. I downloaded and emailed a few to my retired railroader friend, Bob Drenth, to get his thoughts.

Bob's early career was on the Milwaukee Road, which served Allied Mills. I asked if he'd ever switched Allied Mills. He went into quite an oratory about how complicated it was. So, here I had an impressive structure that will be a challenge to build and had interesting switching moves as well. I felt these attributes would make it a good candidate for a stand-alone layout.

For more background on my concept for this project, see the sidebar: “Choosing to build Allied Mills.”

CONSTRUCTION

Blending tower and warehouse

First on the agenda was to build the main structure, the blending tower and adjoining warehouse. I took several months accumulating the parts and materials, then finally started construction in February 2014.

Conventional wisdom would have me use .040” styrene for its rigidity. But I would need to cut out a lot of windows, so I chose

ALLIED MILLS | 4

.015" for its ease of cutting, then would back this thin outside facade with sheets of .030" styrene.

The windows I had purchased were rectangular in shape, while the windows in the Allied Mills tower appear to be square. No problem, I just made my windows almost square by cutting out one sash row and gluing the two pieces back together.

Next I needed to decide on the size of my model structure. The prototype building is still standing so I could measure it, but I

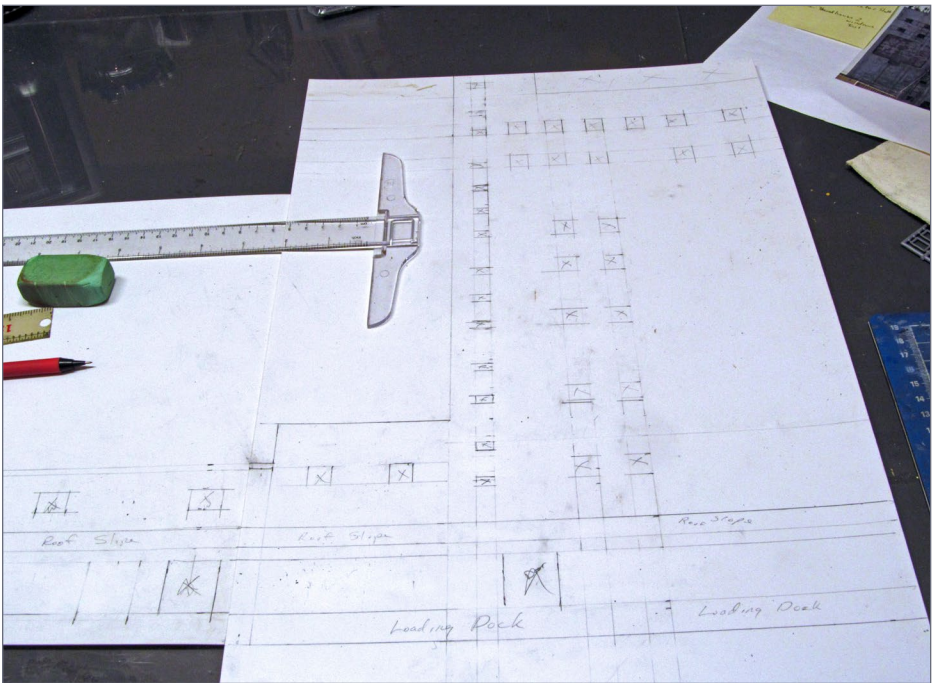

2. The layout of the windows and doors drove the overall building size. I proportioned the building by guesstimating the space between windows. My building may not have the same dimensions as the prototype, but it appears to be about the right size. I chose to use relatively thin .015" rather than thicker styrene for my walls because it would be easier to cut out all the openings.

ALLIED MILLS | 5

already had a pile of windows I'd modified that most certainly were not the same size as those in the real building.

Modelers love the term “selective compression” to describe making a structure smaller, but I prefer the term “proportioning.” My challenge was to proportion this structure using my modified windows as a measuring stick. I estimated the distance between windows, both horizontally and vertically, to get a structure that looks the same size as the real one even though it's likely not the same measurements as the real thing.



3. Here's the window assembly line. I'm using the knife to remove one vertical sash from the Tichy rectangular masonry windows. Trimming is done with sprue nippers or nail file, and then I'm gluing the pieces back together. I kept the finished windows in a fishing lure box.

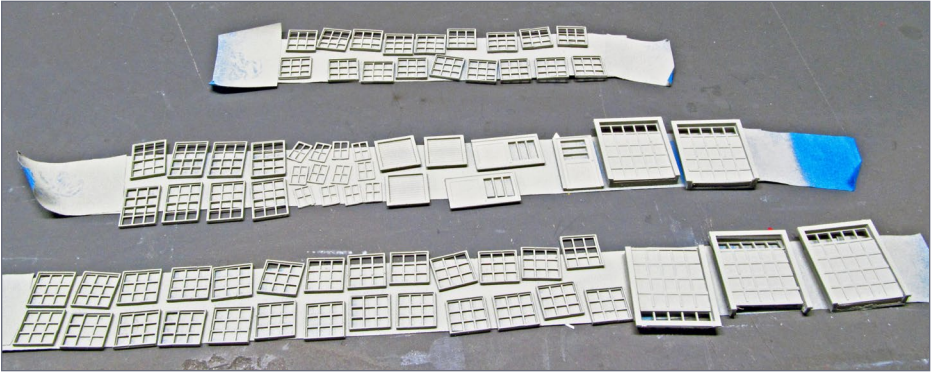

4. I put the completed windows and doors on masking tape and airbrushed them with Floquil CN gray. I placed the tape sticky side up by placing small pieces, sticky side down at the ends. No, I never counted the number of windows.

I laid out the windows and doors on the back of the styrene sheets, then borrowed a Micro Mark corner punch from my friend Bob Gretillat. I had some troubles keeping it on my lines, but it worked well and most importantly, the task went fast.

I ran into an issue: the windows were thicker than the .015" walls. To address this problem, I made a frame of .030" thick Evergreen strip behind the window opening. I placed a window in the opening, then pushed the frame pieces against it to make a tight fit. This framework also gave me a surface onto which I could glue a piece of clear styrene behind the window.

After painting the walls, I glued the windows in. I used white wall-patching compound to fill any gaps. The inside .030" window framework made a good backing for the filler. By using the white patching compound, I was able to avoid needing any paint touch-up.

As the final step in the window installation, after the clear styrene was glued in place, I lightly brushed black paint across the

ALLIED MILLS | 7

back of the clear window styrene. I made no attempt to completely paint the clear styrene. I just wanted wide dark streaks.

Upon closer inspection, I noticed the warehouse had what appeared to be roll-up garage doors. Unfortunately, I had bought Tichy wooden freight doors because they had windows across the top like the prototype.



5. The doors in the warehouse appear to be sectional garage doors. I bought Tichy wood freight doors because they had transoms across the top that would work for the windows in the top section of the warehouse doors. I glued spacer strips to the perimeter of the wood door and then glued on pieces of plain sheet styrene over the wood panels to make them look more like the prototype doors. I marked off sectional panels on these doors by adding thin styrene strips to the plain sheet styrene that covered the original wood paneled doors.

No matter; I changed the doors' appearance by making an overlay out of styrene. The overlay on the first door I did was too short, so I hid this miscue by cutting the window section across the top and down the sides, and then bent it back so the door appeared to be partially open.

This concrete structure had support columns built in, so using photos as a guide I glued long strips of .040x.188" Evergreen to replicate the support columns. Before I could fix the windows and doors I'd fabricated in place, I needed to paint the walls.

I used a rattle can of white primer for the walls. It covered well and dried fast.

The last step before assembly of the building was to add signage. I found a photo of a Wayne Feed sign on the Internet. It took a lot of cutting and pasting in PowerPoint to come up with the banner for the east side of the tower. I made the banner for the west end of the warehouse from scratch.

Once I was done, I printed the signs on regular typing paper.

The signs had to span the support column strips. Being paper, I didn't feel it was possible to contour the signs around those columns. I decided to tape the sign on the wall where I wanted it and then tape extra support column strips on top of the sign. I marked the width of the columns on the paper sign, then removed it and cut it into strips, using my marks as guides.

I glued the sign pieces to the wall and to the columns separately. I thought I might need to paint the sides of the column strips, but unless you look at the walls from an extreme angle, you don't really see the white column sides.

I tried a couple types of glue to hold the sign on the wall, but they failed. I went back to my standby – Elmer's glue sticks, which worked fine. On a side note, I have also used these glue sticks to hold up the photo backdrops on my layout. After a few

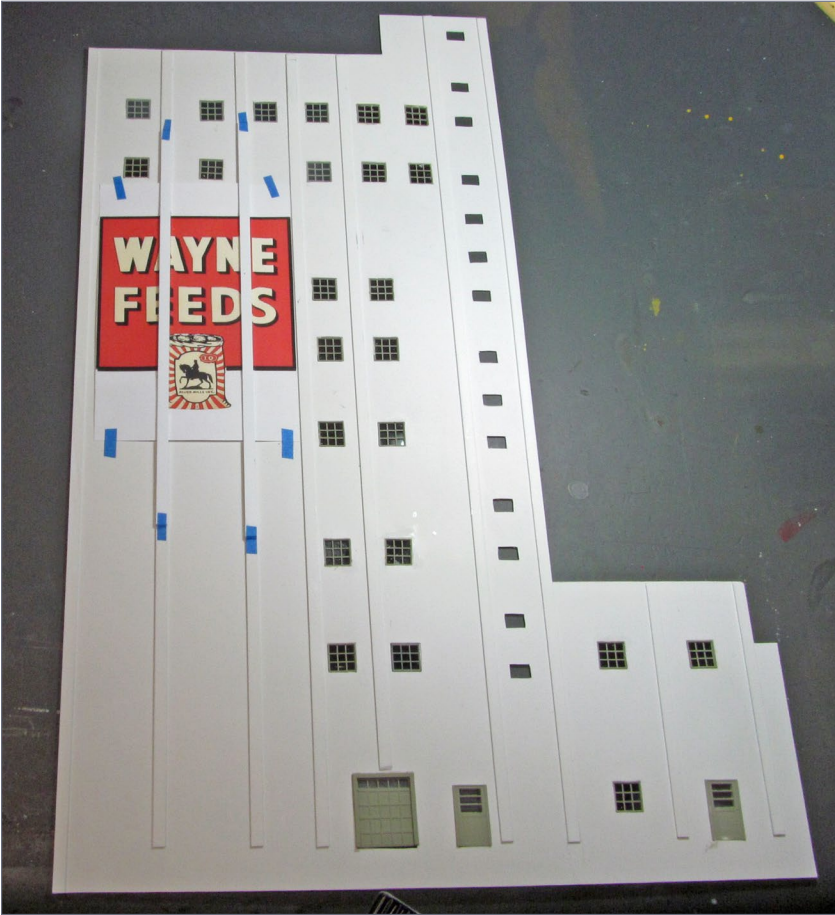

6. The blending tower and west end of the warehouse had signs painted on them. I found a photo of a Wayne Feed sign online. I manipulated it in PowerPoint and printed the signs on regular typing paper. Since the paper signs span several of the support columns, I had to cut them at each column. To determine where to cut the sign, I taped it on the wall and taped extra support column strips over the sign. I marked where the columns were, removed these column strips and sliced the paper with a knife guided by a straight edge. Once I had trimmed the edges, I glued the signs in place. I tried several adhesives and found that Elmer's glue stick worked the best.

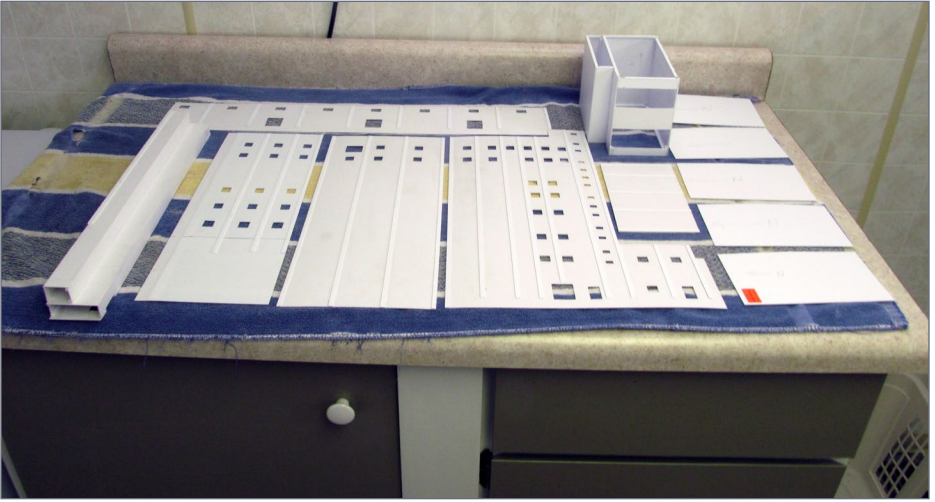

7. Here's the building "kit." All windows and doors have been cut out. I've glued strips of styrene on the walls to represent the extra support columns. I also cut out interior warehouse bulkheads. Finally, I've collected the other structure pieces needed for the complete assembly.

years, I find this glue does dry out. When this happens, I lightly pull the paper forward and apply more glue – and I'm good for a few more years!

With the windows and doors in place, all the tasks requiring the walls lying flat were complete.

Assembling the building

Since the walls are so thin, I started assembly with what I think is the stairway or elevator shaft – it's an L-shaped protrusion on the northwest corner of the blending tower.

I glued long strips of .125" x .125" Evergreen styrene to the edges of the front and back walls. These not only provide support, but create a good gluing surface for attaching the side walls.

ALLIED MILLS | 11

To that solid piece of structure I added the bag-filling room (I think that's what it was, anyway). This two-story affair helps add rigidity to the larger pieces coming next. Once I had glued the tower walls in place, I added inside floors for reinforcing. I also made several internal bulkhead walls for the warehouse to further add rigidity. I cut a bunch of triangles from scrap .030" styrene and used them as gussets to brace the bulkhead walls inside the warehouse.

I added the back walls and the roofs last, which really helped make the structure more solid. After the roofs were in place, I

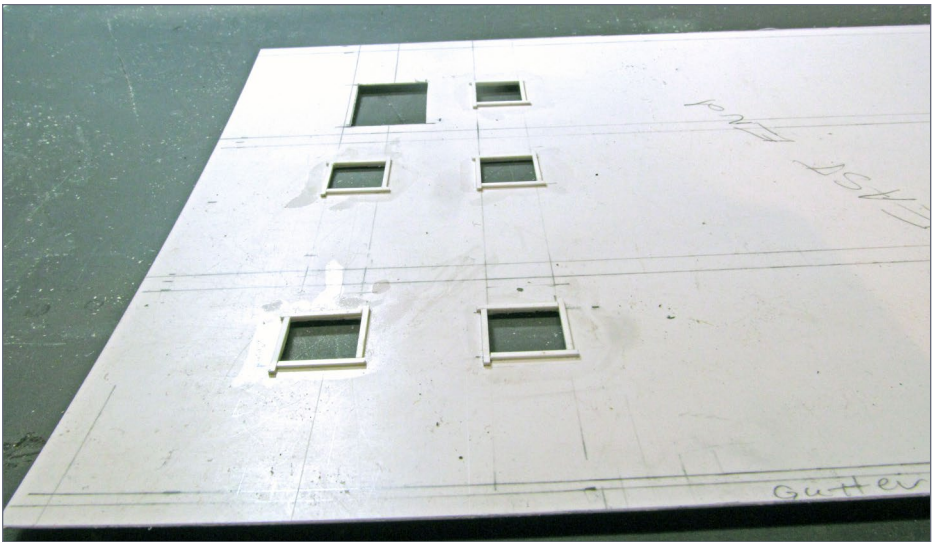

8. One of the drawbacks to using .015" styrene for the walls is the lack of gluing surface for the masonry-style windows. I overcame this by building a crude frame on the inside of the wall. I placed a window in the opening (it protruded through the .015" styrene) and pushed the .030" square styrene strips against it and applied glue to the wall. I immediately removed the window, since I was only using it to position the strips for gluing – I was not ready to install the windows.

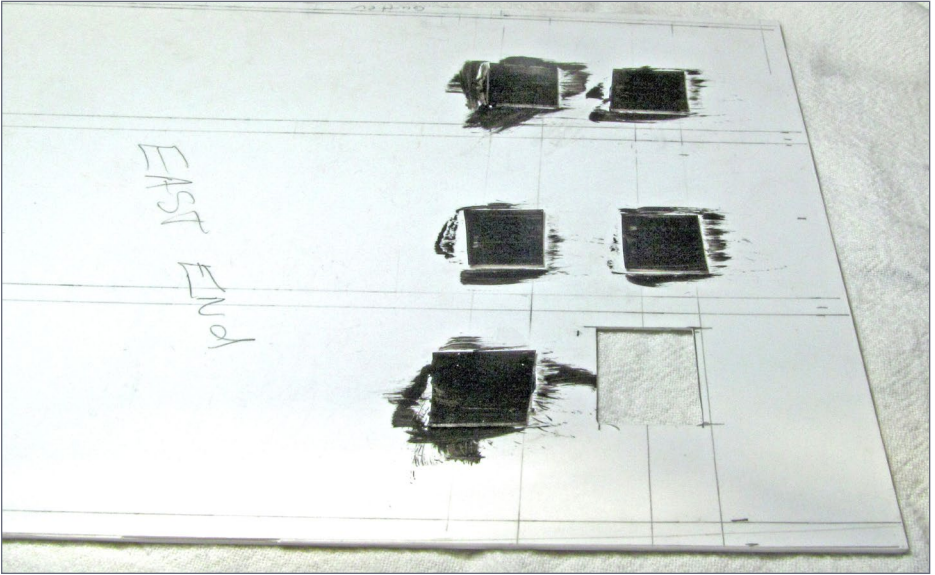

9. Once I had painted the walls flat white using a spray can, and had glued the windows in place, I glued rough-cut squares of clear styrene to the inside of each window frame. Then I brushed black paint on the back of the clear styrene with a single stroke, leaving just a slight bit of transparency.

added the penthouse to the tower roof, and also added several vents. The larger vents, which allow air to escape from bins while they're being filled, are by Bar Mills. The smaller vents came from my scrap box. Most notably, many of these are the pins Accurail provides to hold their trucks to the bolsters.

I made skylights for the warehouse roof by gluing windows upside-down on a clear styrene sheet. Then I cut them out and glued them to the roof.

The prototype loading platform is concrete. I used Squadron Green filler putty to cover all the seams in the long strips of styrene I used to make the platform. After sanding the joints smooth, I airbrushed

ALLIED MILLS | 13

the platform with Floquil CN gray and I applied some gray Pan Pastels to help give the appearance of concrete.

I used corrugated styrene for the platform awning. Since the awning sits at an angle, I glued styrene rod to the wall for the awning to rest on. I figured by using round material, I'd have a greater gluing surface than just the edge of square stock. I painted the awning with a mixture of Floquil silver and a light gray to create a galvanized steel look.

I drew pencil lines at measured intervals to simulate corrugated panel seams. I attempted to show the panels were overlapping



10. I made all the roofs from .020" sheet styrene. Here you can see several vents on top of the blending tower roof. I had some Bar Mills vents on hand and used those for the largest vents, and made the rest of the smaller vents from scrap box pieces.

by highlighting one side of a panel with light gray Pan Pastels and darkening the other side with dark gray.

I used styrene channel to make the roof support brackets along with Micro Engineering gutters and down spouts on the front of the loading dock roof as well as on the warehouse roof.

This concluded work on the main structure for the time being. I was pleased that my choice of using thinner styrene had worked out on this impressive structure that measured in at 35 5/8" long and 16 3/4" tall.

Unloading shed

Next on the agenda was the unloading shed, which also housed a scale. Using photos as my guide, I cut the walls from corrugated Evergreen styrene sheet.

The prototype building has roll-up doors on both ends. I learned these doors were ordinarily kept shut and only opened to move cars. It eventually dawned on me that if I modeled closed doors, I couldn't move any cars through the place!

So I fabricated the roll-up door housing and gear motor by sanding a flat spot on a length of plastic tubing and gluing rectangles of thin styrene to its ends. Once dry, I used flush-cut pliers to snip the styrene into a rough rounded shape, and finished it off with a file. For the gear motor, I rounded the end of a short piece of sprue material and glued it on the end of the housing. I glued the whole shebang along the top of the door opening.

I finished the door opening by framing it with L-shaped styrene. After I'd glued the four walls together, I made some more bracing from Evergreen channel for the inside walls and for between the walls and roof.

I airbrushed the entire structure with my galvanized mixture. The roof is plain .030" styrene painted black, but I did not glue it in place at this time.

Since the end doors are so large, I thought it would be a nice touch to add some interior detail. I had a photo of an end loader used to unload boxcars. I asked Bob for more details, and he described what was there and made me a sketch.

Along the north wall there was a scale room, and at the east end there was a concrete platform to which an electric end loader ran back and forth. The west end had a ramp for the end loader to drive up and down. I made the scale room from embossed brick material and used plain styrene for the platform and ramp, filling any seams to help give the appearance of concrete.

“Since the end doors are so large, I thought it would be a nice touch to add some interior detail.”

I emailed a photo of my completed interior to Bob. He pointed out that the door to the scale room was on the end, not the side facing the track, as I had done. The door was on the end of the scale room because it was so close to the track and no one would be able to open the door with a car spotted for unloading. I thought “What the heck” – I’m close enough; besides no one was going to see much of it anyway.

ALLIED MILLS | 16

My next task was to fabricate the foundation for the building. The concrete foundation has pads that extended out both ends of the building, slanting in toward the track at their ends.

I had to study the prototype details here. First, there was an underground hopper covered with heavy grating between the tracks and on both sides of the track adjacent to the end loader platform.



11-12. Once I had the building section base done I laid the track on it and a piece of Homasote. This way I could determine the shape of the track lead section.

For loaded boxcars, the concept was for an electric end loader to drive into the car containing loose ingredients, scoop up some, back out and then dribble the material between the platform and the car, into the hopper below.

Covered hopper cars would be spotted with a set of discharge gates over the grating, and emptied. As each pair of hoppers became empty, the car would be nudged forward, and the next set of gates opened.

From this lower hopper, the material was transported to the blending tower by some type of unknown conveying system.

There was also a scale that formed a two-part unit with weighing beams on either side of the hopper. The weighing rails, called live rails, were very long, extending well past the ends of the building. Cars were weighed before being emptied.

How did I model all this? First I cut some rails to an appropriate length and filed their ends to a gentle point. I laid these rails on the track running through the shed, up against the molded spike head, and super-glued them in place.

I measured the distance between the two rails, and cut long strips of thin styrene to represent the concrete between the through rails and the weighing rails. I then cut more strips of styrene to go between the rails. Lastly I cut the pieces that formed the building foundation. I used window screen material to represent the hopper grating.

It was about this time that I decided to actually go out to the facility and see if I could gain permission look around. There was a note on the office door saying the attendant was gone and would be back later. I took the opportunity to do a quick walkabout and snap a few photos. I knew immediately after

looking inside the unloading shed I needed to make some changes to my interior.

I changed the door opening to the end of the scale room by simply scribing the outside of the wall and bending it back 90 degrees. The scale room was two stories tall, so I put another set of walls on top of what I'd built.

There was a heavy I-beam structure over the end loader platform I needed to make and the ramp was not concrete, but steel. I modified my ramp to look closer to the real one. I added some noticeable details to the scale room walls and called it good.

“It was about this time that I decided to actually go out to the facility and ... look around.”

Bulk load-out tower

On the prototype there is a steel truss tower between the unloading shed and the middle track. Feed or ingredients from the blending tower could be piped over to this tower for bulk loading into either boxcars or hoppers. About a car length west of this tower was a concrete platform that I assume was used to fit boxcars with grain doors (called coopering). Finding materials for building this tower was a real head-scratcher.

I ended up using Plastruct Howe Trusses, their ladder and safety cage set, as well as a Tichy platform set. Plastruct's trusses are much heavier than the real ones, but sometimes we have to go with what we've got. Besides, the heavier trusses would make a sturdier tower.

The real tower narrows toward the top angling to the south. I cut a thin triangular shape out of the trusses to give my tower an appearance more like the prototype. The trusses have angled edges along their length, possibly to aid in fitting a 90 degree corner together? If so, I failed in my attempt at a clean joint, so I covered the corners with L shaped styrene, making the tower even chunkier.

I modified the Tichy platform to fit the top of the tower. I glued the Plastruct ladder and safety cage on the north side of the tower. I made the concrete base from scraps of thick styrene and made some steps from a Central Valley steps and ladders detail set.

While looking at the Central Valley pieces, I noticed that one of the ladders could be used as the top to the tower. I glued two of these ladders to the platform at the top of the tower, leaning toward the south so the transport lines could be threaded through them.

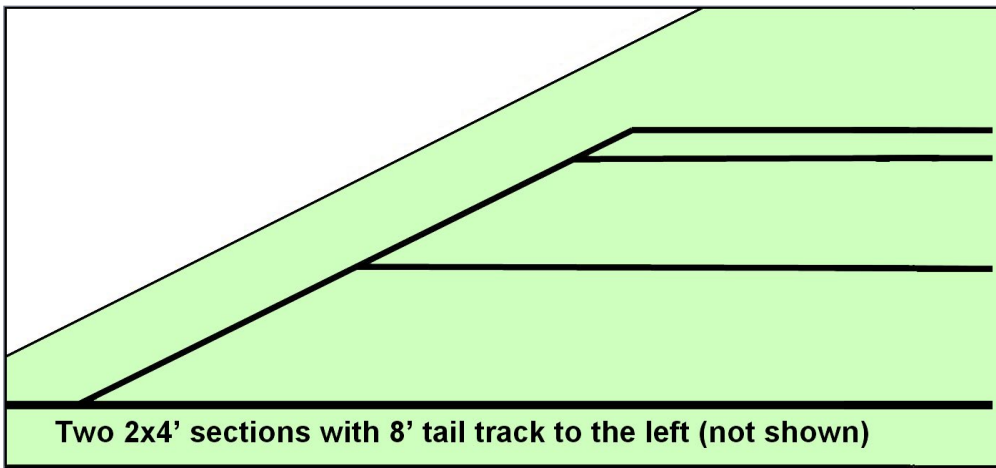

13. Track plan schematic for the two-section Allied Mills Layout Design Element (LDE). *Not to scale.*

I used brass rod for the transport lines. I wrapped pieces of .019” brass wire around the longest line’s rod, and soldered them in place. I drilled holes in the blending tower and pushed the pig-tails of the wire wraps into the holes and fixed them with super-glue. The shorter line has a support bracket fastened midway so I soldered a heavier brass wire to that rod and fastened it to the building in the same fashion as the longer line.

There’s a trap that period modelers can fall into that bit me here. Things change: what you see today may not be how it was at the time you model. I found that with the operator’s shack on my model. The operator’s shack on the platform, between the tower trusses, is now a fairly large corrugated shack. Pictures from the mid-50s show a smaller (possibly wood) outhouse-looking shack. I used the recent photos I took as a reference when building the tower instead of the period ones. Naturally, I built the larger, more

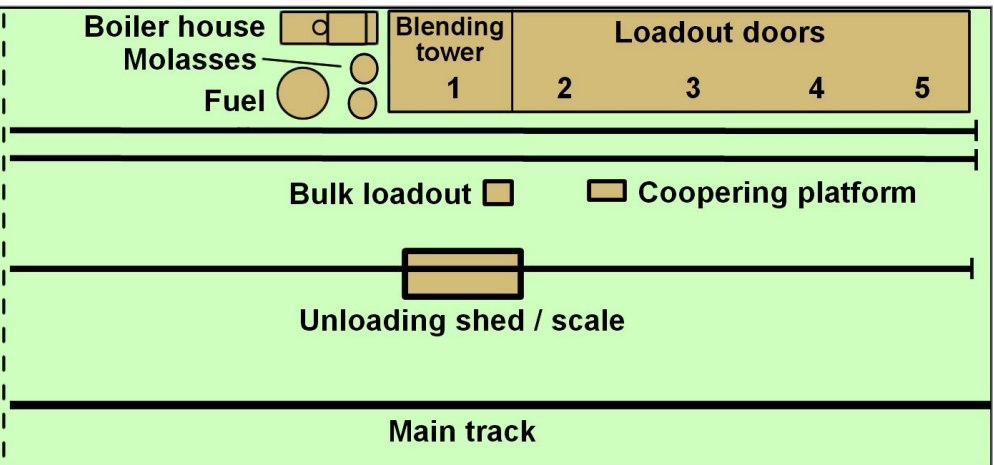

modern steel shack. Okay, then I'll rationalize that the outhouse-looking affair didn't work well and was replaced early-on with the corrugated shack!

I made the boxcar-coopering platform at the same time as the tower platform and with the same materials.

Boiler house

The boiler house is brick, so I used Plastruct embossed brick. However, the concrete block at the top of the center section did concern me a bit. Luckily, I found an old piece of cardstock with block mortar lines pressed into it at a hobby shop that would work. I used the door to guesstimate the height of the boiler house.

“There’s a trap period modelers can fall into ... what you see today may not be how it was at the time you model.”

I used the windows to size the adjoining section of the boiler house to the east and I shortened the two west sections considerably. I shortened this part of the boiler house because it straddles two layout diorama sections and prefer it to come off the layout as a single structure, not several pieces. This part is hidden behind the fuel oil tank away, so it works.

Once I cut the north brick wall to size, I used it as a pattern to cut two plain sheets of styrene. I used one sheet to be a backing to the brick wall and the other to be the back wall of the building.

Because of space restrictions not only did I truncate the length of the building, but I also cut back the depth. I dislike building flats, but am OK with having some depth. Once I'd determined the depth for the building, I cut the ends walls from the brick material and plain styrene backing sheet.

Before I could glue the north wall and the backing piece together I decided to paint the walls and a section of the backing piece to represent the Transite™ (asbestos-cement) panels in the center of the building's tall section. I lightly airbrushed on a couple shades of gray, followed by a wisp of Grimy Black.

I first tried a PollyScale white wash over the brick walls, but wasn't happy with that, so I dry-brushed on a PollyScale brick color and then blended everything with Pan Pastels.

I built the brick walls using a brick and plain styrene sandwich. I next glued the windows and doors in place, along with their concrete sills. Since the flat roofs were below the roof line of the walls, I glued a couple rows of brick material along the top inside edges of the walls before gluing the final box together. I made the two taller center section side walls almost the height of the building for added support. I only veneered on brick sheet to the outside of these walls where it would show above the adjoining roofs.

When all the walls were in place, I cut the roof pieces out of black styrene. I used U-shaped Evergreen styrene strips painted silver as a wall cap. I made the stack from a piece of plastic tubing with .015" styrene rod wrapped around it to simulate the stack section flanges.

For the vents on the roof, I used small wood mushroom-looking pieces I found at Hobby Lobby.

The building looks a bit odd if you study it closely because the center section is so tall. I'd made the mistake of allowing selective compression to trump proportioning.

Storage tanks

There is a large tank for fuel oil to the north of the boiler house. I used a tank by Alexander Models that I had built years ago.

“Because of space restrictions, not only did I truncate the length of the building, but I also cut back the depth.”

The mill also receives regular shipments of molasses, fish oil and linseed oil. The two tanks on the east side of the blending tower are where they are stored. To represent these tanks, I used tanks some friends had cast in plaster. I dressed them up with Tichy platforms and ladders.

Building the mini-layout base(s)

I was watching the height of the mini-layout to keep it from getting too tall, so the framework for the bases would have to be thin. I mulled over various frames that would not only serve as



14. I used small electrical wire for the unloading hoses for the fuel oil and molasses tanks. I made the fuel spill with Polly Scale Oil Black paint. The Molasses spill is Pan Pastel extra-dark red iron oxide. I achieved the wet look with few a drops of polyurethane.

a skeleton, but also protect the base surface material. I chose to build a picture frame style using 1x2s with 45-degree corners, and adding a slot ½” down from the top on the inside.

I purchased two 2’x4’ sheets of 1/8” hardboard. I slid the hardboard into the frame slots, with a couple of 1x2s placed across the frame as intermediate bracing. I built one rectangular base for the mill complex.

I cut an old piece of ceiling tile to fit inside the 1x2 frame and glued it to the hardboard. The fragile edges of the ceiling

tile would be protected from damage by the 1x2 pine framework. I chose ceiling tile for this section because I wanted to do some contouring.

I temporarily laid out the buildings on the rectangular section and laid some Shinohara code 70 track. Once I had this track in place, I laid out the leads for the second section and took some measurements.

I found this base section's frame a bit more difficult to build because of its triangular shape. Considering the cost of scenery materials, I could see no reason to have any more surface

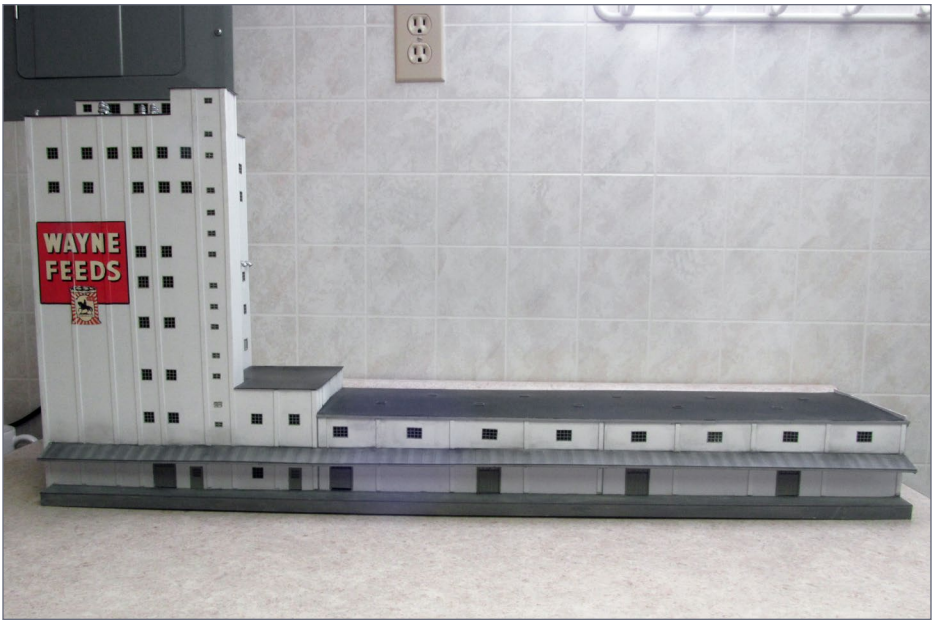

15. The blending tower and attached warehouse are complete. Just like the real one, it's quite an impressive structure measuring 16 $\frac{3}{4}$ " tall by 35- $\frac{5}{8}$ " long. At this point the question asked by my wife and guests was: "Where are you going to put it?"

area than necessary. I used a piece of Homasote on this section, because all the turnouts (#6) are located here, and I wanted a good base for spiking.

Before I could lay all the track, though, I needed a good way to fasten the sections together. I'd used door hinges in the past on portable layout modules with great success. I found a set of narrow hinges that did the trick.

I've never been thrilled about laying track. It's one aspect of layout construction I just do to get it done.

I cut some cork in thin strips to raise the mainline a little, so the ballast could have some shoulder. Once I had spiked all tracks in place, I took the sections outside to airbrush the track with Floquil Grimy black, rail brown and tie brown.

I use my own mix of mostly real limestone for the spur tracks, because the ballast looked whitish in the photos. Mine turned out a bit more gray than I wanted.

I mixed a different concoction for the mainline. Pit-run gravel ballast was popular on the prototype. The mainline had been in place for years before the mill and its associated trackage was laid, so I wanted the main to look well-used.

For weathering the track, I like using paint pens to quickly color random ties. Grays and browns seem to look the best to me. I also tried Jason Klocke's trick of brushing dark reddish brown Pan Pastel along the base of the rail giving the impression of rust accumulating at the tie plates. I streaked black Pan Pastel down the center of the track representing oil and other substances that dip off trains.

Wiring

You can add layout wiring to my layout construction-dislike list. My plan was to connect Allied Mills to the layout's DCC buss, but I had two issues to address.

First, the Shinohara turnouts are power routing, meaning I need to attach feeders from the point end. Second, the tracks on the two sections would not be joined together with rail joiners, so I needed to add feeders to all the tracks on the rectangular section.

I started soldering stranded wire onto the rail as drops. My main bus is 14-gauge solid wire, and I prefer using terminal strips to connect feeders to the bus.

“You can add layout wiring to my layout construction dislike list.”

I made my own terminal strip connector by drilling holes in the frame and inserting two long 8-32 bolts. I crimped fork connectors to the stranded wire drops and formed loops in the ends of the solid 14-gauge wire. Washers and nuts held all the wiring to their respective bolts.

The wire I used for all the drops had white insulation. A little ditty I use that helps keep track of rail polarity is: “Black in back,” so I used a Sharpie marker to blacken the wire connected to the back rail.

I didn't want any dangling wires between sections getting pinched under the frame. I used my rotary cutting tool to cut grooves in the bottoms of the frames for the wires to pass through, and used wire nuts to connect the bus wires together.

I soldered only one pair of drops to the bus on the triangular section near the points of the mainline turnout. This could cause problems if any of the points failed to pass power.

Now that all the tasks on my dislike list had been checked off, it was time to have some fun!

Scenery

Scenery is how we convey to the layout viewer the part of the country and time of year represented by the model. Making scenery is the most enjoyable part of the hobby for me.

I temporarily placed the buildings in their appropriate locations, drew a pencil line around them, and covered the area with masking tape to keep from getting ballast, gravel or static grass under the buildings.

Contouring

I wanted some contour to the base of the rectangular section. Ceiling tile carves easily with a utility knife and Stanley Surform tool. Dampening the tile before shaping keeps the irritating dust down. I had glued pieces of the thin cork I'd used under the mainline where the foundation of the unloading shed would be. Since the cork is about the same thickness as the track ties, my concrete-painted pieces of styrene laid flat over the ties up to the rail.

I carved ditches on both sides of the main, and used the Surform tool to slope the ground toward the ditch on the south side of

the main. I used a knurling tool in my drill to dig ditches in the Homasote on the triangular-shaped section. I sanded off any “frizzies” with coarse sandpaper.

There is a berm along the north side of the north spur. I scalped a couple pieces of florist foam and glued them in the proximity of the berm on my model.

I had given the foam a rather steep slope because I wanted some exposed dirt showing. I added dirt by first rubbing full-strength white glue on the sides of the foam, followed by a sprinkling of sifted real dirt. I sprayed the dirt with a water-alcohol mix, followed by drops of diluted white glue. I sliced some rough vertical grooves in the wet dirt to indicate signs of erosion.

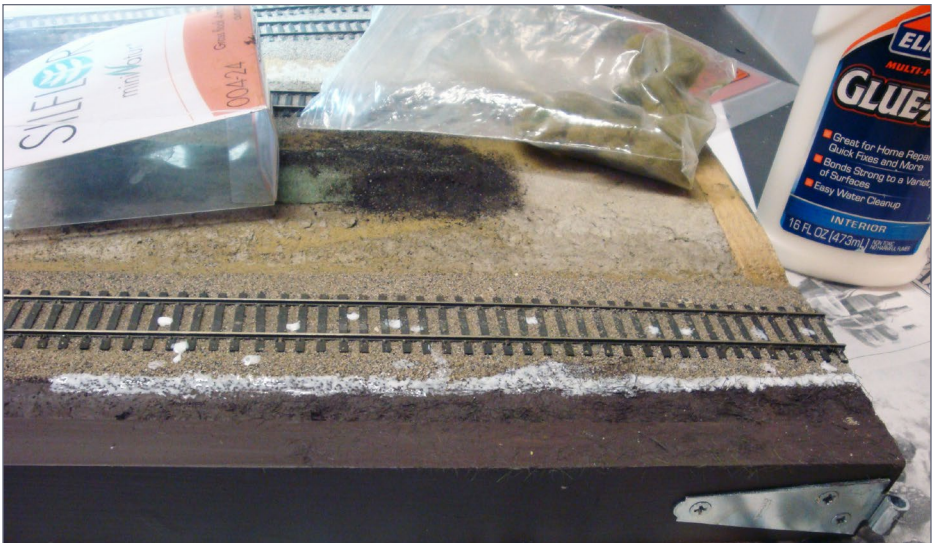

16. Jason Klocke showed me how he simulated a weed sprayer's passing by on the mainline. As the first step, I brushed full-strength Elmer's glue along the ballast edge and a few places between the rails.

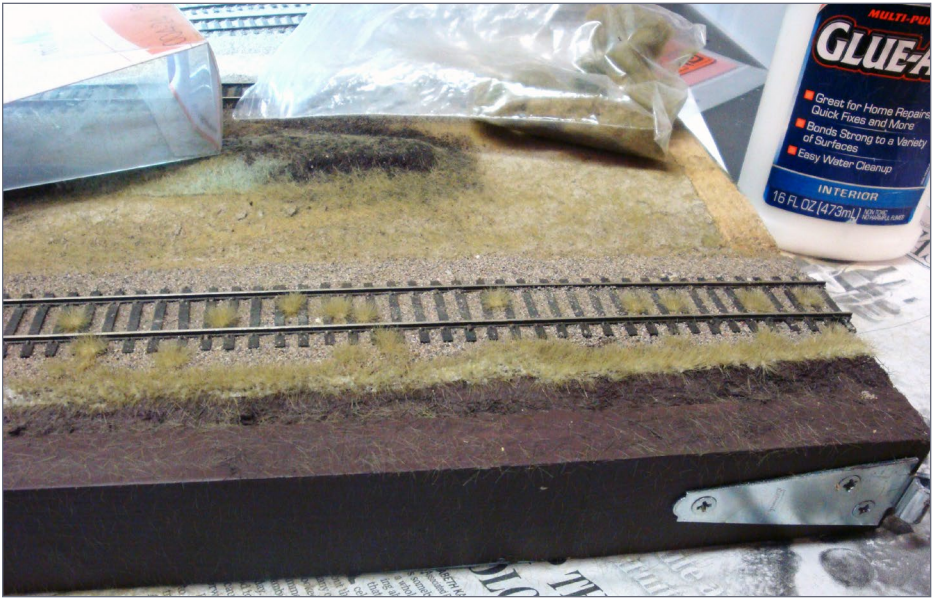

17. After applying the full-strength white glue [13], I applied Silflor 4mm autumn-colored static grass to the glue.

Static grass

I like to use either earth-colored paint or white glue to secure static grass in place. I also wanted to try Jason Klocke's method of giving the appearance a weed sprayer has come by recently. To do this, I brushed a line of full-strength white glue along the edge of the mainline ballast. I then applied 4mm autumn-color static grass to this glue line.

Once dry, I painted more full-strength white glue in the area between this first line of dead grass along the mainline and the front edge of the frame base. Here I applied 4 mm late-summer colored static grass. I also used the late-summer color to cover the rest of both sections.

ALLIED MILLS | 31

In the spring, new grass or weeds are green under last year's crop of taller, dead tan-colored stands. In summer, grasses go to seed, creating a brownish-tan layer across the green carpet. I've found I can emulate this look by stacking the static grass.

First, I spray areas of the late-summer-color grass with a strong hair spray, and then apply a layer of autumn-color static grass. Once everything has dried, I sprinkle on some different textures and colors of ground foam. This represents the larger leaves and some kinds of seed pods.



18. To finish the static grass application, after applying the weed-sprayed autumn grass [13, 14], I applied late-summer green 4mm grass to the ditch between the track and the front edge of the base.

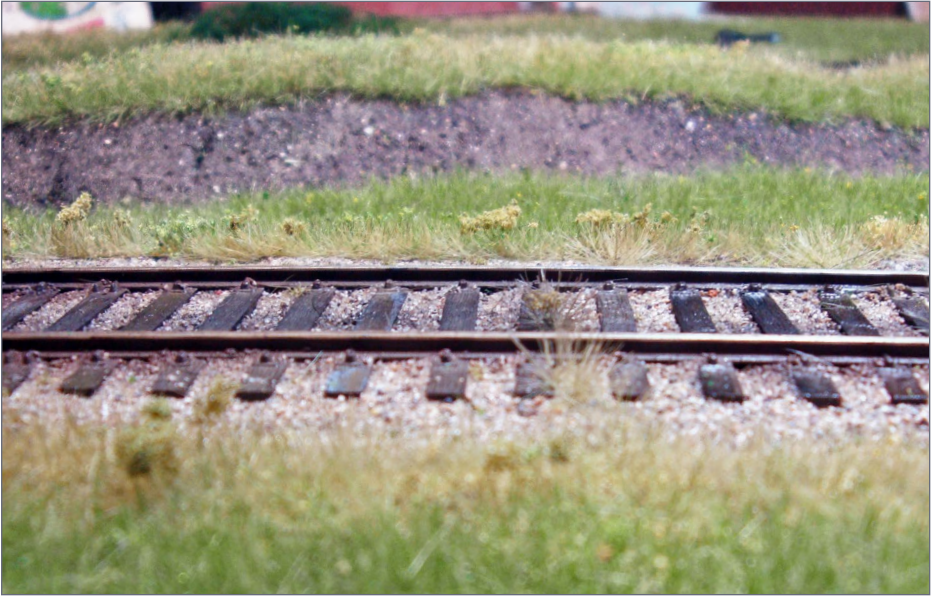

19. As a final touch, I added coarse Woodland Scenics foam of a similar color to the tops of the autumn grass. First, I sprayed the grass with hair spray. Next, I lightly held some of the coarse foam between my thumb and first finger, then dragged the foam across the top of the grass where the hair spray had been applied. The stickiness of the hair spray caused the grass tops to grab a bit of the foam. The result is full-looking weeds with leaves and seed pods.

Jason taught me to lightly hold coarse autumn-colored foam between my thumb and first finger, then barely touch the tops of the static grass I had just shot with hair spray, running my fingers down the weed line. Strands of the grass will catch bits of foam, creating a striking resemblance to milkweed.

Sprinkling on different colors of fine foam can be used to represent wild flowers and various flowering weeds.

To model the gravel area around the buildings, I applied a combination my spur ballast and some sand mixed with a pinch or two of other powdered materials I've accumulated over the years.

With the ground cover finished, it was time to place the structures.

I decided to glue tabs on the back of the larger mill structure so I could use screws to attach it to the frame. To keep the front of the building in place, I super-glued several styrene rod "pegs" along the front. I drilled holes in the base for these pegs to slide into. I used the same technique to peg the unloading shed and boiler house in place.

The two plaster tanks had been on my layout and were already in a catch basin, making it simple to glue them in place. I added pegs to the loading tower and cooping platform, and stuck them down with carpenters glue also.

The buildings are held quite securely using this method. In hindsight, though, I should have used brass tubing instead of styrene rod. I have already replaced some broken styrene rods with brass tubing.

The boiler house straddles both sections, and needs to be moved to the mill section for transporting. I added an additional set of holes so I can secure it in its traveling position.

I hauled the sections inside a crate in my pickup bed to the 2014 St. Louis RPM show. The buildings all stayed in place, with the only damage being a couple of broken styrene rod pegs.

Details

Allied Mills was looking good, but a bit sterile.

I'm not one to populate my layouts with a lot of people, but there are other details I could add to give it some character. I had just

ALLIED MILLS | 34

a few days left to the RPM meet. With my limited time in mind, I studied the prototype photos looking for things to add. I made the following for the loading dock:

- Bridge ramps from .005” brass shim stock and heavy-duty aluminum foil



20. The final Allied Mills LDE module pair, suspended from its storage location over my layout.

- A broken bag of feed
- Stacks of plywood cut from brown paper towels
- A few lumber scraps and short lengths of cable for good measure.

On the surrounding grounds, I made a cardboard box from old newspaper and scattered bits of old newspaper around to simulate grain doors ripped from cars being unloaded.

To enhance the cooping platform, I made a stack of wood grain doors and laid a short ladder on the platform. I glued hooks



21. Precision Scale Hayes wheel stops match those used on the prototype. I brushed them with Floquil Grimy Black, Rail Brown and Polly Scale Rust without letting any of the paint dry. Adding water-based paint on top of solvent-based paint created some interesting effects.

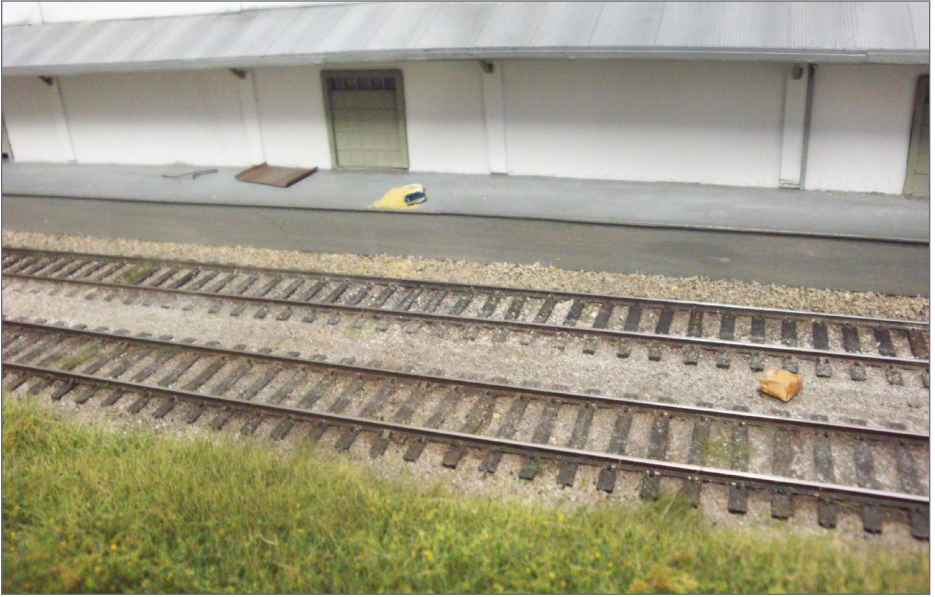

22. I added a few details on and around the warehouse loading dock. I made an old cardboard box from old newspaper, I cut a resin feed bag nearly in two and piled yellowish ground foam in the cut. The bridge plate is .005" shim, and there are pieces of thread to simulate lengths of chain or cable.

formed from brass wire to the ends of stile steps that could be used to get out of the car after nailing on the wood grain doors.

I made hoses for emptying tank cars from small-diameter stranded wire and super-glued them by the fuel and molasses tanks.

I brushed some Polly Scale oily black paint around the track near the fuel tank and scrubbed some tea-colored Pan Pastels around the track by the molasses tanks.

I dripped a few drops of urethane vanish on the pan pastels to add a wet look.

I sent a photo of the tank car unloading area to my retired railroad friend Bob. He explained that Allied Mills built bunkers between the rails and filled them with sand to catch any drippings from the unloading process. I figured I was going to model a time before the government could spell EPA, so there simply could have been spilled product around.

The three stub tracks had Hayes wheel stops for bumpers. I used wheel stops from Bowser. After super-gluing them in place, I blended thinned Floquil Grimy black, tie brown, and Polly Scale rust by brushing one over the other while they were still wet. Mixing the lacquer and water-based paints gave an interesting result.

It dawned on me that I had no idea how the Allied Mills personnel moved cars through their unloading shed. So I asked Bob.

He said they had a motor-driven loop of cable with a chain and hook. They fastened it to a car and used the motor and cable on pulleys to pull the car forward. I stimulated this apparatus by placing rectangles of styrene at each end of the concrete pad that extended from the unloading shed. I made these to represent the enclosures protecting the motorized pulleys at the ends of the loop.

Lastly, I super-glued down two lengths of thread as cable. I also spread some short lengths of thread along with more lumber and paper in and around the shed.

At this point, I was done. Time to figure out how to operate the thing.

Operations

Activity began in the afternoon when Allied Mills would call the railroad and tell them the sequence in which they wanted the cars unloaded. The switch foreman would find these cars either in the yard or on local interchanges. With all the cars located,

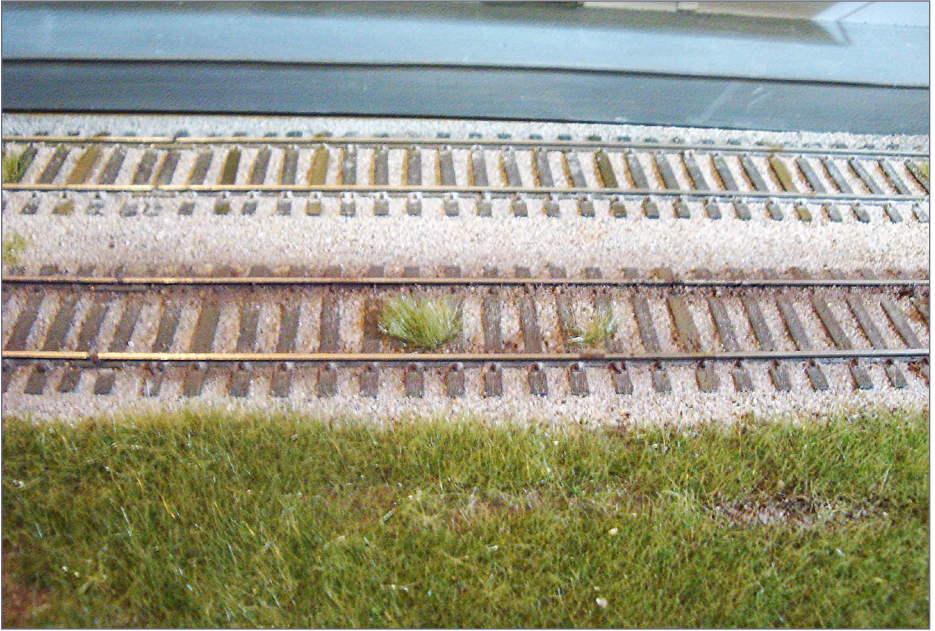

23. Another technique Jason Klocke showed me was to brush Pan Pastels along the base of the rail. This photo shows the difference between the foreground track with Pan Pastels applied and the back track without the Pan Pastel treatment.

he would line them up in the requested sequence before he shoved the cars to the mill.

The shove usually didn't take place until third trick, which was after the last freight of the day left town. Since the shove involved pushing cars about three miles west, they tacked a caboose on the end – that is, in front of the cars. Once at the mill, they cut off the caboose and left it on the mainline.

The different owning railroads gave the three tracks at the mill different names over the years. I will attempt to explain the common practice and procedure for switching the mill.

After cutting off the caboose, the crew would first shove their train into track 2, the storage track, also known as the middle track. Also here is the bulk load-out tower. If any car loads were here they'd spot them for weighing on the scale in the unloading shed, and would pull them later.

Next, the crew pulled track 1, the house track, also known as the south track. The warehouse had four doors, plus one in the blending tower. They numbered the door spots 1 – 5, or left-to-right when facing south. But the doors had no actual numbers on them; the railroad just expected employees to know the order.

Generally, the cars spotted here contained loads of bagged feed to pull. But occasionally, they would receive a car of supplies, like paper bags, for example. If these cars were not empty, they would need to be relocated after switching was complete. If the



24. Overview of mill complex section with the scenery completed.

ALLIED MILLS | 40

inbound cars were empty, they might also want them spotted at a different door for loading.

At the east end of the track stood the molasses and fuel tanks. Bob told me they never delivered any fuel, but it is possible that fuel oil may have arrived in tanks cars before he started work in 1969.



25. The Allied Mills switch job begins with the afternoon switch foreman being handed a switch list by the clerk. Allied Mills would notify the railroad each afternoon of the sequence they wanted for their inbound cars. The foreman would have to locate the cars in the yard or off an interchange transfer, and get them arranged. Since they would be shoving the cars about three miles west, they placed a caboose on the west end of the lineup in front of the cars. The third trick would usually do the mill switch job after the last freight train had cleared the mainline. In this photo, they have cut off their caboose on the main [see 29] and are shoving the inbound cars into the middle track.

Either way, the railroad weighed the tank cars before spotting them for unloading. Each time a switching crew worked the mill, they would re-weigh the tank cars so the mill would know how much was left in each car.

This process would be repeated over three or four switching jobs until the car was empty and was released by the mill.

Next, the crew pulled track 3, the scale track, also known as the north track. Empty cars for bag loading may come off the unloading track, per instructions left for the crew.

These unloaded cars would be east of the unloading shed with one car left inside, and the end doors closed. The mill would



26. Next move is to pull loads off the track next to the warehouse.



27. Tank cars could bring fuel oil for the boiler house, molasses, fish oil, or linseed oil. The feed-mix oils were stored in tanks next to the blending tower. The mill would want to know how much product had been removed from a tank car after each workday, so the switch crew would weigh each tank car on the scale in the unloading shed and replace it. It usually took three days to empty a car of molasses. This means a car could be weighed and re-spotted twice before being pulled as an empty.

leave an amended switch list in the scale room for the switching crew foreman. This would tell him which empties to spot at which doors on the house track.

Because the crew brought cars to the mill in a specific order, any unloaded cars would need to be put in their proper place in an altered line-up.

ALLIED MILLS | 43

Once completed, the crew would shove the loads through the unloading shed. They would cut off the car next to the engine, place it over the pit inside the shed, and close the doors.

The crew could now take the cars they had placed out with their caboose and head back to the yard to sort them.

All this was done without any fancy switching maneuvers, and no running around – just straightforward back-and-forth moves that can be duplicated with our models.

An operating session would commence with the train staged on the lead. You'd push the train toward Allied Mills, drop the



28. The last pull is the track beyond the unloading shed. The mill would decide which empty car they wanted to reload, and place a second switch list in the unloading shed. This list designated which empty boxcar was to be spotted at which warehouse door by number. The doors were not stenciled with their number: the crew was expected to “just know” which door was which. Either a covered hopper or boxcar could be chosen for bulk loading.

caboose on the main and start shuffling cars around just like the prototype.

When you had finished all the moves, you'd pull your train back onto the staging track. Depending on how fast you work, switching the mill could take from a half hour to an hour. Car movements can be controlled with car cards and waybills, or a switch list. Also, a combination might work: the operator could be given have car cards and a blank switch list he can fill out if he chooses.

I used a simple car-card system and a lineup list for unloading cars, and allowed attendees at the St Louis RPM to try their hand at switching the mill. Once they were comfortable with the paperwork, they had a great time operating this mini-layout.

Choosing an era

Prototype modelers like to model a specific time. Some even chose a specific day. I want to keep my Allied Mills era to summer of a specific year.

I used a process of elimination to narrow down my desired date. The Mason City yard usually had a Baldwin switcher assigned. EMD MP 15s bumped the remaining Baldwins from service by mid-70s. Jason Klocke kindly gave me a Stewart Baldwin to use as my Allied Mills switcher, so I need to be pre-1975.

Next, the Milwaukee renumbered its diesel fleet in 1959. They gave 900-series numbers to the Baldwins. I chose to put a 900-number on my Baldwin switcher because I knew local operators would recognize it. It warms a period prototype layout builder's heart to hear visitors proclaim: "I remember that!"

The mill changed over the years in two significant ways. The first was to enclose the loading dock and the second was to add cyclone-style dust collectors to the fan exhaust vents on the west wall of the

blending tower. The mill enclosed the loading dock when my friend Bob started working for the Milwaukee in 1969. I modeled the loading dock prior to it being enclosed. That got me to 1959 -1969.

The newest photo I have of Allied Mills is dated 1961. I see no cyclones on the exhaust vents. I used this photo as a guide when making the signs on my model.

I also have several photos of Baldwins in Mason City in 1961. One of those Baldwins is 901, which has the same body configuration as my Stewart/Bowser model, plus it sports Xs along the frame (that may have been unique to the Milwaukee), but that adds extra appeal.



29. Outbound cars would be set against the caboose as each track was pulled.



30. If a boxcar had been selected for bulk-loading, it would be spotted by the switch crew at the cooping platform. After grain doors were installed by mill personnel, they would use a capstan car-puller to move the car next to the load-out tower.

So I numbered my Baldwin to 901 and set the year at 1961.

Maybe, as I build a small fleet of cars dedicated to Allied Mills, I may not be able to resist a car or two built in the mid-'60s. In that event, I may adjust the date few years, as determined by the newest built date on a piece of rolling stock.

Conclusion

This was a fun project. I met my space requirement, completing the project in six months. An Allied Mills-type mini-layout would also fit into a larger layout with ease.

ALLIED MILLS | 47

Taking Allied Mills to the St Louis RPM and letting attendees operate it proved that, yes, a single LDE can work well a stand-alone mini-layout.

Sidebar continues on the next page ...



**Click here for
reader comments**

ADVERTISEMENT

Railroad Explorer Magazine

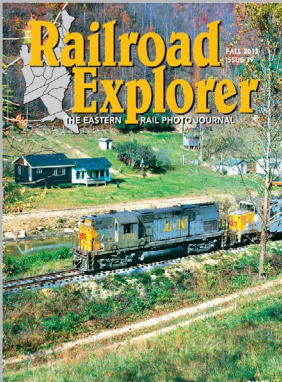

THE EASTERN RAIL PHOTO JOURNAL

- Three all-color issues per year. Exciting feature stories and spectacular photos of Eastern Railroading
- Best-in-class photo reproduction. Printed on heavy, glossy paper. Zero advertising.
- Three times per year - Winter, Spring/Summer and Fall editions.

Subscribe today!

www.railroadexplorer.com

MRHMAG.COM

- [TABLE OF CONTENTS](#)
- [INDEX](#)



31. Clark feels his Allied Mills LDE has demonstrated quite well how interesting a relatively small mini-layout can be to build, scenic, and operate. So if you don't have a layout yet, time to get started on an interesting LDE such as Allied Mills!



[Click here for
reader comments](#)

CHOOSING TO BUILD ALLIED MILLS



Tony Koester coined the phrase “Layout Design Element”, or LDE, to describe specific focal points on a layout. It could be a yard, industry, or anything that could hold the attention of the viewer/operator.

Bob Rivard used the concept of “prototype focal points” (the term LDE wasn’t invented yet) and connected several such building blocks together in a linear fashion to build a rather nice prototype layout. LDEs generally have been thought of as one of several pieces that are needed to make up the whole. Could a single LDE be a standalone layout? Or, as John Golden put it, a “mini-layout,” making such a narrow focal point into the main attraction?

What made me choose Allied Mills to model as an LDE or mini-layout?

When someone mentions a feed mill, most picture a small structure in a rural setting that could handle only a car or two at a time. On the other hand, Allied Mills in Mason City, Iowa, is a large structure with a blending tower that can be seen for miles.

About year prior to a clinic I was building for the Naperville RPM show, I was at the archives department of the local library. While

.....

thumbing through photos they'd scanned, I came across several photos of Allied Mills that intrigued me. I downloaded and emailed a few to my retired railroader friend, Bob Drenth.

Bob had worked for the Milwaukee, which served Allied Mills, and continued working their tracks for subsequent owners. I asked if he'd ever switched Allied Mills. He went into quite an oratory about how complicated it was. So, here we have an impressive structure that's a challenge to build and had interesting switching moves. I felt these attributes would make it a good candidate for a stand-alone mini-layout.

Over the years, I've heard many excuses why someone hasn't built a layout. The three most often heard are: I don't have the time, don't have the space, or don't have the money. I've never heard "don't have the skill."

Another concern is if a layout design will hold your attention over time. I felt the operations at Allied Mills seemed varied enough to hold your attention for quite some time.

Why build such a large and complex industry? I'm a prototype modeler first and an operator second. My present layout is fun to operate with friends, but it's virtually finished, with no more major modeling projects. I wanted a project unlike anything I'd built before.

Building this kind of mini-layout is part of the natural progression of concept, construct, and operate. Besides, I had talked the talk and poked fun at the excuses for not building a layout at a previous Naperville presentation – now I wanted to show I could walk the walk and build a complete mini-layout for this presentation.

.....

Choosing such a large building with support structures goes against the first excuse model railroaders use, that being not enough time. I'm retired, so I wanted a project that would take time to complete. Something similar could be built by combining a few structure kits.

This project would eat up material, and it certainly wasn't going to be cheap. But I felt the result would be just substantial enough to prove my point about building and operating something: even a well-chosen single LDE can be very satisfying and fun. ■

.....

CLARK PROPST



Like most 'baby boomers' Clark received a Lionel train set for Christmas at a young age. And as Clark says, "I got to watch my dad play with it."

Clark's father worked for the Minneapolis & St Louis railway. They lived next to the tracks, further cultivating Clark's interest in railroads and modeling them. Clark has built many layouts over the years, but says "true satisfaction comes from modeling the prototype as faithfully as possible."

Clark retired after 39+ years as an electrician at a local cement plant in Mason City, Iowa. Clark and his wife Eileen recently moved to a smaller home, where he's building a branchline operation. ■

.....

UNPRECEDENTED!

**Save 30% on ALL
MRH Store
downloads!**



**Use
coupon
code:**

SAVEBIG134M

Expires October 15, so don't miss out!

START SAVING NOW >>

store.mrhmag.com

**MICRO-
TRAINS®
LINE**

Announcing our next Limited Run PWRS / Micro-Trains® Cars!!!

Safety-Kleen (PROX)

54' General Service
Tank Car 4-pack

CLICK HERE FOR
Safety-Kleen

COMING
April 2016

PWRS 



**Canadian
National (CN)**
40' Standard Grain
Box Car 4-pack



CLICK HERE FOR
CN Grain Box

TRAINWORX
Inc. 

Announcing NEW Limited Run PWRS / Trainworx™ Trailers!!!

PWRS 

Canadian Freightways
28' Smooth Sided Trailer w/Dolly
4-pack



CLICK HERE FOR
Cdn Freightways



The Bay - Zellers (HBC)
53' Smooth Sided Trailer 4-pack

COMING
April 2016

CLICK HERE FOR
Bay / Zellers

PACIFIC WESTERN RAIL SYSTEMS
SPECIAL RUN CAR

Pacific Western Rail Systems



YES, IT'S A MODEL

compiled by
DON HANLEY
.....



**Click here for
reader comments**



1. Jeff Meyer of The Weathering Shop posted these photos of CR 883595 on the MRH forum.



The shop forces painted over the old Penn Central markings in their haste to get as many cars as possible converted at the beginning of Conrail's existence. To see more of Jeff's work go to theweatheringshop.com/jeffmodels.html.

► **MRH'S MONTHLY PHOTO ALBUM**

YES, IT'S A MODEL | 2



2. TrainMasters TV Executive Producer Barry Silverthorn submitted this photo of BNSF 8615 still in its Santa Fe livery. The engine looks a little worse for wear and in desperate need of a new paint job. It is an Atlas Dash 8-40B with “lots of weathering.” The tower is an American Model Builders interlocking tower, with the background structures by DPM and Magnuson Models. Barry took the photo on a diorama in natural sunlight.

YES, IT'S A MODEL | 3



3. Andy Renshaw posted a nicely done Kansas City Southern boxcar. The model has the typical graffiti that is common on today's rolling stock. Andy also has done extensive modeling of military equipment. To see more, visit his site historyinscale.com.



4. It's an early Monday morning as "Annie" makes her way across a river heading up to the isolated coal mining settlement of Coal Creek. The locomotive is an On30 model of a four-ton Bagnall industrial locomotive built in 1912. The prototype was built for the Gentle Annie quarries near Gisborne, New Zealand.



Chris Bradley of New Zealand built the models and posted the photo on the MRH forum.



5. The clouds are breaking up and the sun is peeking through as family members arrive at grandma's house to share a meal. Brodie Washburn posted a scene from his 12 x 14-foot L-shaped layout, a freelance California landscape based in the late 1950s.

YES, IT'S A MODEL | 7



6. Peter Herron posted these photos of an Abanakee Lumber Co. center cab locomotive on the paint stand. We believe that he did a great job of capturing the look and feel of a light industrial locomotive.



GET PAID FOR YOUR PHOTO

We pay \$40 per photo we publish. If you'd like to get your modeling in our photo feature, just start posting your photos on the MRH website, especially in the Weekly Photo Fun thread created each weekend.

See mrhmag.com/help for more on how to post an image. You need to be an MRH subscriber to post photos to our website, and becoming a subscriber is free, [just fill out this form here](#). ■



**Click here for
reader comments**

**When talking
to hobby
vendors, please
remember to
mention MRH.**

Bowser

EXECUTIVE LINE

HO MILW M636 Locomotives

Ready to Run and Detailed. Features: air hoses, windshield wipers, grab irons, coupler lift bars, operating headlight, window glass, can motor, flywheels, nickel silver wheels with RP25 flanges and knuckle couplers.

DC Version
\$209.95
Sound Version
\$309.95
Available
August 2016



HO 70 Ton 12 Panel Hopper Cars

Ready to Run. Features: Crisp details and sharp painting and printing, metal wheels and knuckle couplers.
\$23.95 each



Available
May 2016

HO 40' Single Door Box Cars

\$24.95 each

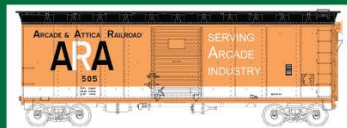

HO Freight Car Kits

KIT INCLUDES: One piece plastic molded body, under frame, brake wheel, air tank, brake cylinder, triple valve, free rolling trucks, knuckle couplers, & car weights.



See your dealer

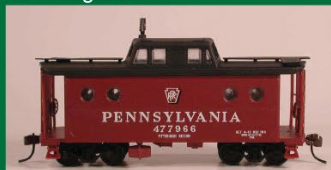

HO SD40-2F Locomotives

Ready To Run and Detailed. Features: air hoses, windshield wipers, grab irons, coupler lift bars, operating headlight, operating class lights, window glass, can motor, flywheels, nickel silver wheels with RP25 flanges and knuckle couplers.

DC Version \$219.95
Sound Version
\$319.95
Available
Late 2016

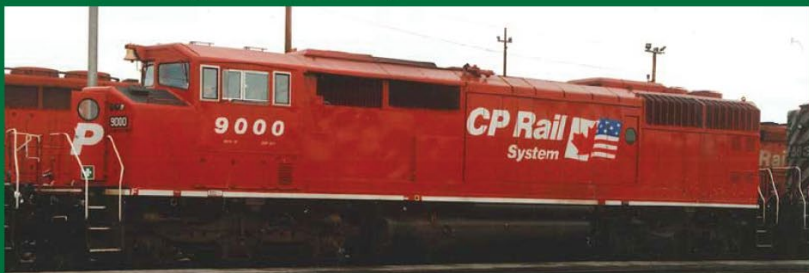

Click here to check out the details for these and other great Bowser products!



AAR OPEN TOP LOADS

BY DOUG FORBES
.....

Using the AAR open top loading guide and rare earth magnets to make removable flat car loads ...

WOULDN'T IT BE NICE TO HAVE FLAT CAR LOADS that could be easily removed for an operating session? Imagine that John Doe for ACME Road Construction ordered a new steam shovel excavator or a new road grader. For an operating session, the load would be shipped to an unloading ramp at Anywhere, USA. Then the load is simply removed out of the way and the empty flat car is routed back to the yard to begin its next shipment cycle.

At a train show, my brother and I stumbled across an *Association of American Railroads Guide to Loading of Commodities on Open Top*

Cars and Trailer. We quickly bought it. It has approximately 1500 pages of diagrams and illustrations that illustrate how to appropriately place



**Click here for
reader comments**

and tie down loads for flat cars and gondolas to comply with AAR guidelines. It has everything from structural steel pieces, to forest products, to tanks, tractors, military Jeeps, landing boats for the army, airplane wings, and a whole chapter on TOFCs (trailers on flat cars). Following are a few examples of these diagrams.

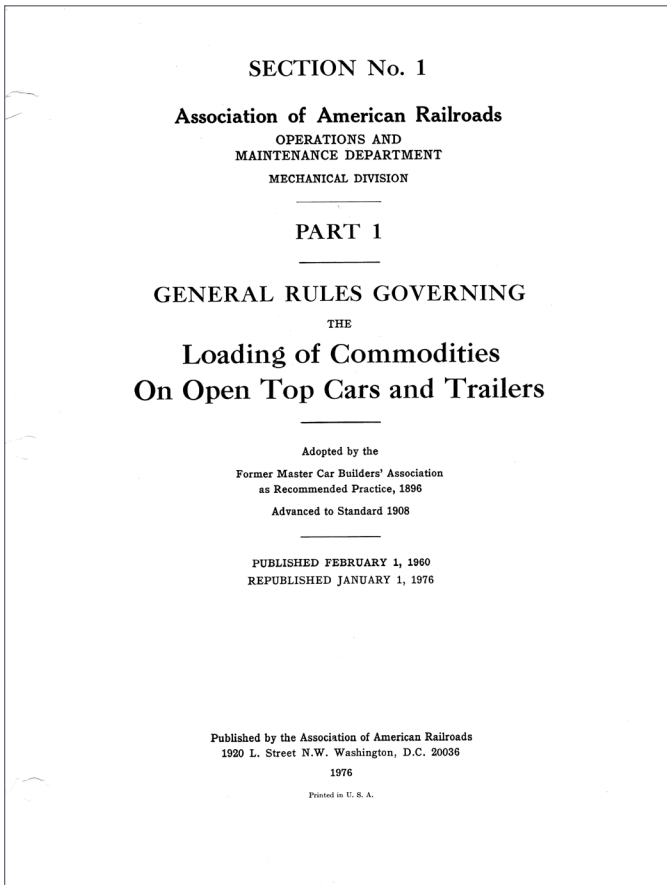

1. Front cover of loading diagrams.

AAR OPEN TOP LOADS | 3

Sec. 3—Fig. 83 (Rev.—10-1968)

71

TRACTORS (WITH OR WITHOUT PNEUMATIC TIRES), BOTH ROW-CROP AND CONVENTIONAL, LENGTHWISE OR DIAGONALLY, OVER 4,000 LBS. TO AND INCLUDING 7,000 LBS.—FLAT CARS

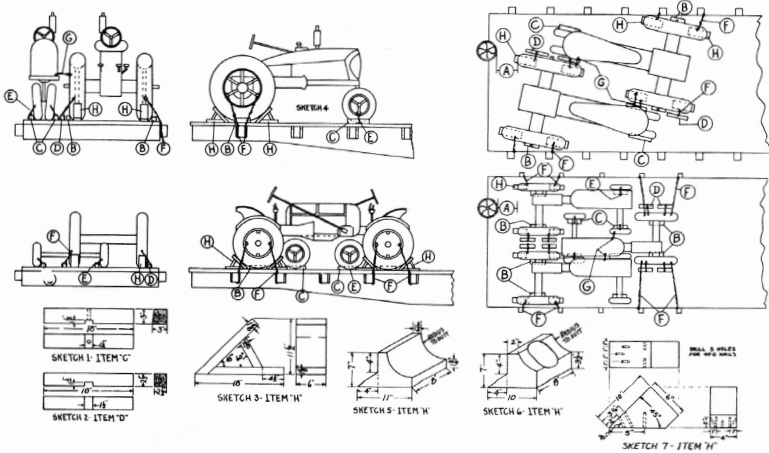

Item	No. of Pcs.	Description
A		Brake wheel clearance. See Fig. 2, Sec. 1.
B	1 ea. rear wheel	Blocks, 3 in. x 3 in. x 12 in., hardwood, beveled at top to prevent chafing. Locate both either inside or outside of each rear wheel and nail each to floor with four 50-D nails.
C	1 ea. front wheel	Blocks, per Sketch 1, beveled at top to prevent chafing. Locate both blocks either outside or inside of each front wheel and nail each to floor with six 50-D nails. On machines having dual front wheels, nail blocks to floor against outside of wheels. Size of notch not to exceed $\frac{1}{2}$ in. deep nor $1\frac{1}{2}$ in. long. When Item "E" is attached to front end of machine and to stake pocket block, 3 in. x 3 in. x 12 in., without notch, secured to floor with four 50-D nails, may be substituted for Item "C".
D	2 ea. inside rear wheel.	Blocks, per Sketch 2 or tie-down plates Pattern 32. Size of notch not to exceed $\frac{1}{2}$ in. deep nor $1\frac{1}{2}$ in. long. Secure Sketch 2 blocks to floor with six 50-D nails and Pattern 32 plates with ten 10-D nails.
E	Four wheel tractors, 2; Row-Crop tractors, 1.	Each to consist of six strands, No. 9 ga. black annealed wire. Pass three wires through holes in plates or spokes of wheels, or through holes in frame near front of machine, and through stake pocket or Item "C". Overlap ends of wires and twist taut.
F	2 ea. rear wheel.	Each to consist of six strands, No. 9 ga. black annealed wire. Pass three wires through holes in plate, or around spokes, of outside wheels and preferably through two stake pockets. When two stake pockets are not available, attach wires to one stake pocket, per Sketch 4, or to blocks, Items "D". When space between rear wheels of side by side machines will not permit application of both Items "D" side by side, one Item "D" may be used provided three wires, Items "F", are passed through side by side wheels and around Items "D". Overlap ends of wires and twist taut.
G	2 ea. pr. of machines.	Each to consist of six strands, No. 9 ga. black annealed wire. Pass three wires around frame, spokes, or through holes in plate of wheels, or through a suitable bracket attached to each side by side machine with at least one $\frac{1}{2}$ in. dia. bolt, so as to tie machines together at front and rear in the most effective manner. Overlap ends of wires and twist taut.
H	2 ea. rear wheel.	Blocks, per Sketches, 3, 5, 6 or 7. Locate against tread and nail each to floor with five 40-D or seven 30-D nails. When more than two tractors are loaded side by side, across car, apply blocks only to wheels of tractors nearest sides of car.

Vertical holes, slightly smaller than the diameter of nails, must be drilled through blocks, Items "B", "C" and "D". Detached parts, boxed material, etc., must be loaded as far from car sides and ends as practicable and secured to prevent displacement.

Tractor tires must be inflated as uniformly as possible to a minimum of 18 lbs. for two-ply and 27 lbs. for tires of four-ply or more.

If so equipped, mechanical brakes must be tightly set and levers wired.

See General Rules 4, 5, 9, 14, 15, 19-A and 19-B for further details.

1968

2. How to load tractors on flat cars.

AAR OPEN TOP LOADS | 4

Sec. 6—Fig. 81 (Rev.—8-1972)
TANKS AND SIMILAR UNITS OVER 100,000 LBS.—FLAT CARS

101

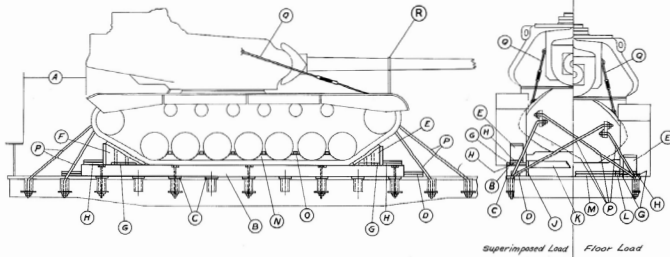

Item	No. of Pcs.	Description
A		Brake wheel clearance. See Fig. 2, Sec. 1.
B	2	10 in. x 18 in. x 24 ft. Locate, as shown, along each side of car. Secure each to car with at least five 1 in. dia. bolts passed through Items "B" and "C", wood filler in stake pocket, and 1/2 in. x 4 in. x 10 in. plate underneath stake pocket. Not required for units loaded on floor of car.
C	As required.	Metal fillers, length, width and thickness to suit. Locate between Items "B" and top of stake pockets. Not required when units are loaded on floor of car.
D	4	Each to consist of two pieces of 2 in. x 6 in. x 18 in. Locate against Item "B" as shown. Secure lower piece to floor with four 30-D nails, and top piece to one below in like manner. Not required for units loaded on floor of car.
E	2	Blocks, pattern 30. Locate one against each front crawler tread.
F	2	Blocks, pattern 31. Locate one against each rear crawler tread.
G	2 ea. Item "E" and "F".	2 in. x 3 in. x 20 in. Locate, as shown, against each side of Items "E" and "F" and secure to floor of Item "B" with four 20-D nails in each.
H	4	Each to consist of two pieces of 2 in. x 12 in. x 18 in. Locate one against each Item "E" and "F". Secure lower piece to floor or Item "B" with five 30-D nails and top piece to one below in like manner. Substitute, if desired, patterns 81.
J	6	2 in. x 8 in. x 13 in. Locate, as shown, against Items "B" and crawler, one near each end of unit and one at center. Secure each to Item "B" with four 30-D nails, and to Item "K" with three 30-D nails. Not required for units loaded on floor of car, or when patterns 80 are used.
K	3	4 in. x 6 in., length equal to distance between Items "J". Not required for units loaded on floor of car. Substitute, if desired, patterns 80.
L	2	Each to consist of two pieces of 2 in. x 4 in. x 14 ft. Locate against inside of crawler treads. Secure lower piece to floor with 30-D nails spaced about 12 in. apart and top piece to one below in like manner. Required only when units are loaded on floor of car.
M	3	Each to consist of two pieces of 2 in. x 4 in., length to suit, suitably spaced between Items "L". Secure lower piece to floor with 30-D nails spaced about 12 in. apart and top piece to one below in like manner. Required only when units are loaded on floor of car.
N	As required.	Each to consist of two pieces of 6 in. x 6 in., length to suit, cut to fit contour of bogie wheels. Locate one piece between inside and outside wheels of each bogie assembly.
O	1 ea. Item "N".	2 in. x 4 in., length to suit. Locate on top of Item "N", as shown, and secure with four 20-D nails.
P	8	1 1/2 in. dia. rods. Attach to lifting lugs and pass through stake pockets and 1/2 in. x 4 in. x 10 in. plates underneath stake pockets, as shown. Substitute, if desired, 3/8 in. x 6 x 7 steel cable, doubled.
Q	2	3/8 in. steel cable, doubled. Locate, as shown, between gun turret and crawler structure.
R	2 ea. unit.	3/8 in. steel cable, 6x19 IWRC. Apply two 3/8 in. cables in a complete loop securing gun barrel to unit at each side. Not required when unit is equipped with external built-in gun brace; however, if external gun brace is inoperative, cable will be used. Substitution of wire or banding is not authorized.

When necessary to extend floor for the application of Items "G" on units loaded on floor of car, use method shown in Figure 1-C, Sec. 1.

Turret gun should be in straightforward position, and turret lock handwheel and elevating mechanism handwheel must be wired to prevent rotation.

When tie-down rods are found slightly loose in transit, they need not be tightened.

Hand brakes must not be set.

"NOTICE"

This figure, when applicable, is to be used for the loading of vehicles being shipped under the provisions of ICC Special Permit No. 3498 during a National Emergency when the gross weight for each loaded vehicle is in excess of 100,000 pounds. See General Rules 4, 5, 7, 9, 11, 14, 15 and 19-A for further details.

1972

3. An example of how to load tanks on flat cars.

AAR OPEN TOP LOADS | 5

After finding this, my brother challenged me to build some flat car loads that could be removable. I decided to take him up on this challenge, and the results are what you see in this article. After flipping through all of the diagrams, the two I decided to model were the steam shovel excavator and the road grader. For the excavator I chose to use the Jordan Highway Miniatures Erie B-2 Steam Shovel Kit. For the road grader I used GHQ's 120 Road Grader.

Modeling the steam excavator

The following pictures show how the steam excavator was put together. I followed the directions in the kit. The instructions include a diagram for how the excavator would be arranged if it were placed on a flat car [6].



4. The flat car loads in the loaded position.



5. The flat cars with their loads removed.

I found the loading diagrams straightforward in their illustrations. They show the proper placement for blocks and strapping for shipment. Therefore, it is great for a modeler, so I simply followed the directions as illustrated.

I began by using colored pencils to help me find all the parts needed to tie down the load. The excavator has quite a few more pieces than the road grader. The following diagram illustrates what I did [11].

After looking over the loading diagrams, I ordered stripwood in the dimensions I needed. I labeled them with masking tape flags so I could remember which was which. I then brushed on an India ink wash to help the wood look just a little aged, as if it had been sitting outside for a little while [12-13].



[Click here for reader comments](#)

AAR OPEN TOP LOADS | 7

FINAL ASSEMBLY - (Continued from other side.)

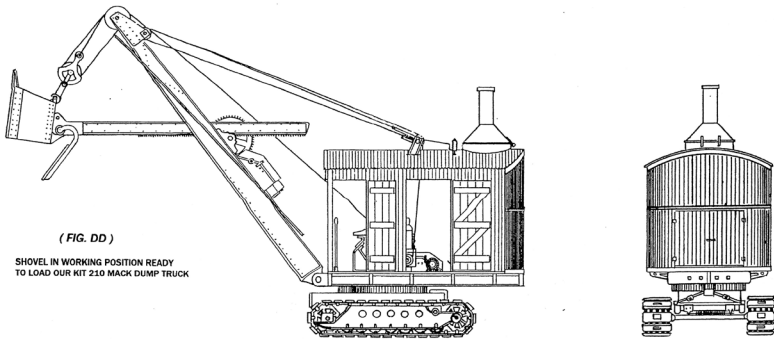

(FIG. DD)

SHOVEL IN WORKING POSITION READY TO LOAD OUR KIT 210 MACK DUMP TRUCK

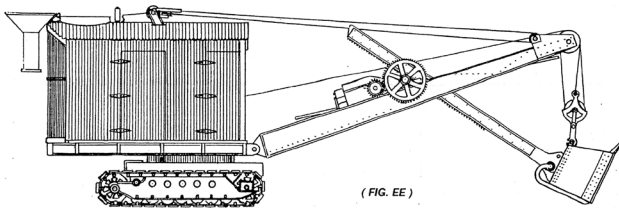

(FIG. EE)

SHOVEL ALL "BUTTONED UP" READY FOR TRANSPORTING. (A GREAT FLAT CAR LOAD)

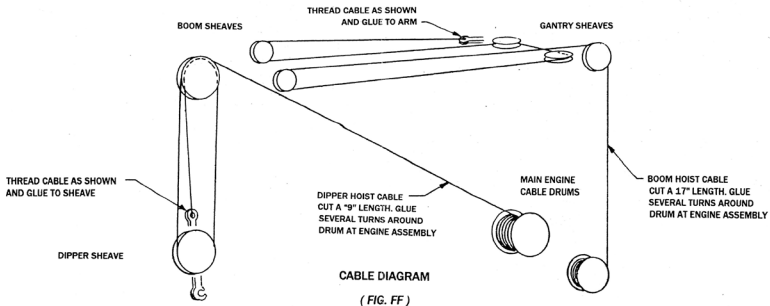

CABLE DIAGRAM
(FIG. FF)

NOTE: IF STRINGING THE CABLE SEEMS A LITTLE TEDIOUS, STRAIGHTEN THE CABLE BY APPLYING THE TESTORS LIQUID CEMENT (THE HEAVIER BODIED LIQUID) TO THE THREAD WITH THE THUMB AND FOREFINGER. HANG THE THREAD WITH A WEIGHT ON ONE END AND LET IT DRY OVERNIGHT. CUT THE THREAD TO THE LENGTHS NEEDED BETWEEN SHEAVES. GLUE ONE END TO ONE SHEAVE AND ALLOW IT TO DRY, THEN GLUE IT TO THE OTHER SHEAVE.

6. Jordan Highway Miniatures diagram showing how the excavator was "buttoned up" for travel.

AAR OPEN TOP LOADS | 8

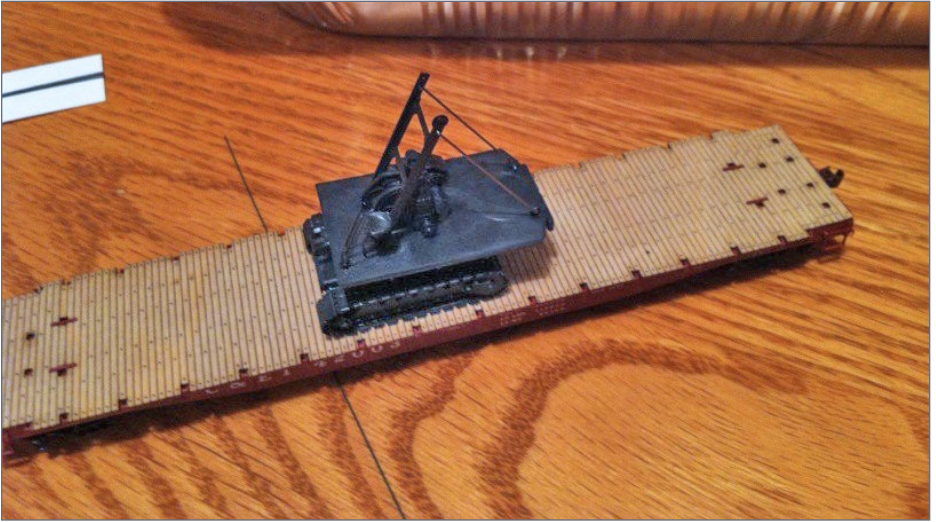

7. Here is the bottom part of the excavator in a test-fit with the flat car.

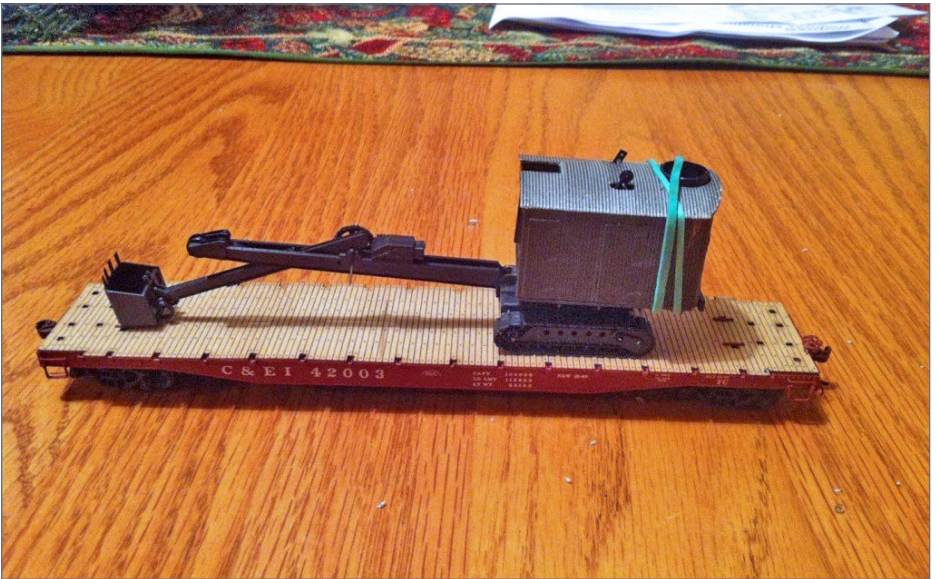

8. Another test-fit, this time with the boom attached.

AAR OPEN TOP LOADS | 9

27-A

Sec. 4—Fig. 22-A (Rev.—3-1965)

CRAWLER TYPE SHOVELS—ROTATING BODIES—BOOMS ATTACHED—FLAT CARS

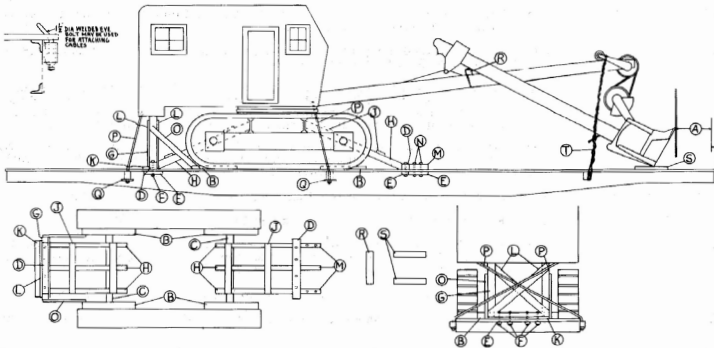

Item	No. of Pcs.	Description
A		Brake wheel clearance. See Fig. 2, Sec. 1.
B	2	4 in. x 6 in., hardwood, length equal to that portion of crawler tread resting on floor. Locate on floor, against crawlers, and secure each with four $\frac{3}{8}$ in. dia. bolts or eight 60-D nails. Substitute, if desired; four pieces, 4 in. x 6 in. x 4 ft. Locate as shown and secure each with two $\frac{3}{8}$ in. dia. bolts or four 60-D nails.
C	2	4 in. x 4 in., hardwood, long enough to fit between Items "B". Secure each to floor with two $\frac{3}{8}$ in. dia. bolts or four 60-D nails.
D	2	4 in. x 6 in., hardwood, for machines weighing 45,000 lbs. or less; 6 in. x 6 in., hardwood for machines weighing over 45,000 lbs.; long enough to extend beyond Items "G" and "H". Secure each to floor with four $\frac{3}{8}$ in. dia. bolts.
E	As Required.	2 in. x 4 in. x 18 in., hardwood cleats, or $\frac{1}{2}$ in. x 4 in. x 18 in. plates.
F	8	$\frac{3}{8}$ in. dia. bolts, with nuts and washers, long enough to pass through Items "D", "E" and floor.
G	2	4 in. x 6 in., hardwood, for machines weighing 45,000 lbs. or less; 6 in. x 6 in., hardwood, for machines weighing over 45,000 lbs.; long enough to fit between Items "D" and body of machine.
H	4 6	4 in. x 6 in., hardwood, for machines weighing 112,000 lbs. or less. 6 in. x 6 in., hardwood, for machines weighing over 112,000 lbs. They must be long enough to fit between Items "D" and base of machine.
J	4	2 in. x 6 in., hardwood, long enough to extend beyond outside Items "H". Secure to Items "H" with three 20-D nails at each location.
K	1	2 in. x 6 in., hardwood, length to suit. Locate against Item "D", and secure to floor with six 30-D nails. Not required when Items "M" are used at both ends.

1965

9. This is the loading diagram for the steam excavator.

AAR OPEN TOP LOADS | 10



10. Another test-fit as I'm starting to experiment with the bracing.

27-A
Sec. 4—Pkg. 22-A (Rev.—3-1968)
CRAWLER TYPE SHOVELS—ROTATING BODIES—BOOMS ATTACHED—FLAT CARS

Item	No. of Pcs.	Description
A	2	4 in. x 8 in., hardwood, length equal to that portion of crawler tread resting on floor. Locate on floor, against crawler, and secure each with four 3/8 in. dia. bolts or eight 40-D nails. Substitute, if desired, four pieces, 4 in. x 6 in. x 4 ft. Locate as shown and secure each with two 3/8 in. dia. bolts or four 40-D nails.
B	2	4 in. x 4 in., hardwood, long enough to fit between Items "A" and "C". Secure each to floor with two 3/8 in. dia. bolts or four 40-D nails.
C	2	4 in. x 6 in., hardwood, for machines weighing 45,000 lbs. or less; 6 in. x 6 in., hardwood for machines weighing over 45,000 lbs.; long enough to extend beyond Items "B" and "D". Secure each to floor with four 3/8 in. dia. bolts.
D	As Required.	2 in. x 4 in. x 18 in., hardwood cleats, or 1/2 in. x 4 in. x 18 in. plates.
E	8	1/2 in. dia. bolts, with nuts and washers, long enough to pass through Items "D", "E" and floor.
F	2	4 in. x 6 in., hardwood, for machines weighing 45,000 lbs. or less; 6 in. x 6 in., hardwood, for machines weighing over 45,000 lbs.; long enough to fit between Items "D" and body of machine.
G	4	4 in. x 6 in., hardwood, for machines weighing 112,000 lbs. or less.
H	4	6 in. x 6 in., hardwood, for machines weighing over 112,000 lbs. They must be long enough to fit between Items "I" and base of machine.
I	4	2 in. x 6 in., hardwood, long enough to extend beyond outside Items "H". Secure to Items "H" with three 20-D nails at each location.
J	1	2 in. x 6 in., hardwood, length to suit. Locate against Item "D", and secure to floor with six 20-D nails. Not required when Items "M" are used at both ends.

1965

11. Showing how I used colored pencils to coordinate the parts to be made.

AAR OPEN TOP LOADS | 11

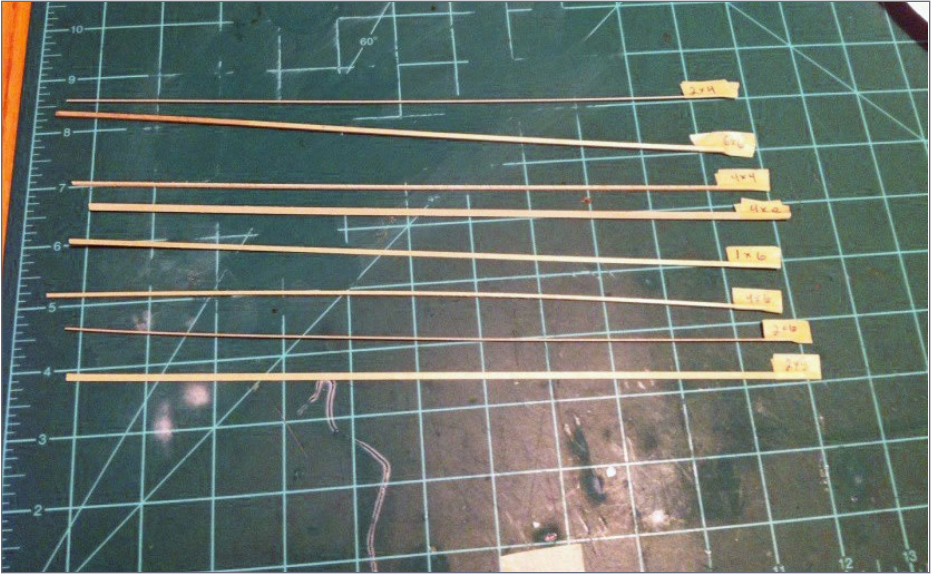

12. Labeled stripwood.



13. Stripwood that has been stained.

AAR OPEN TOP LOADS | 12

From that point on, it was simply a matter of referring to the diagram and using the corresponding piece of wood to model the block. It is comparative to assembling a wood craftsman kit [14-22].

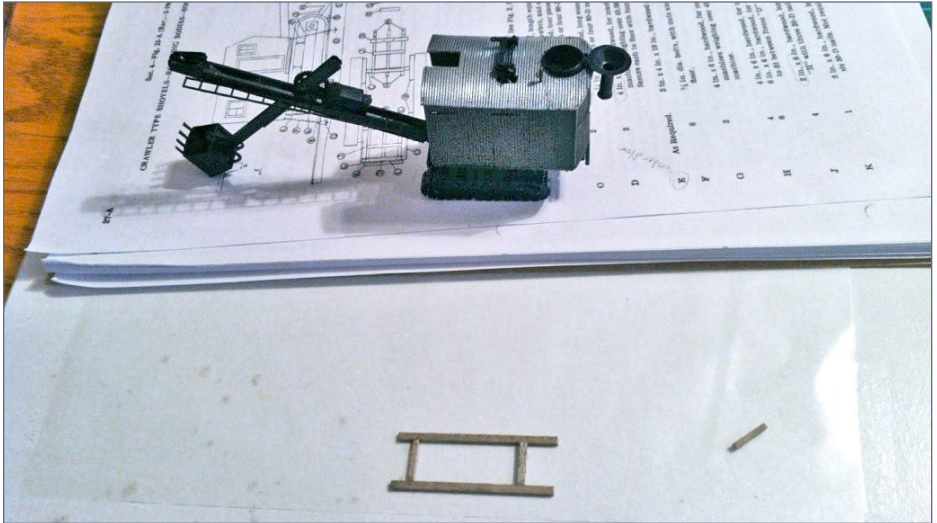

14. This shows the bracing underneath the excavator.

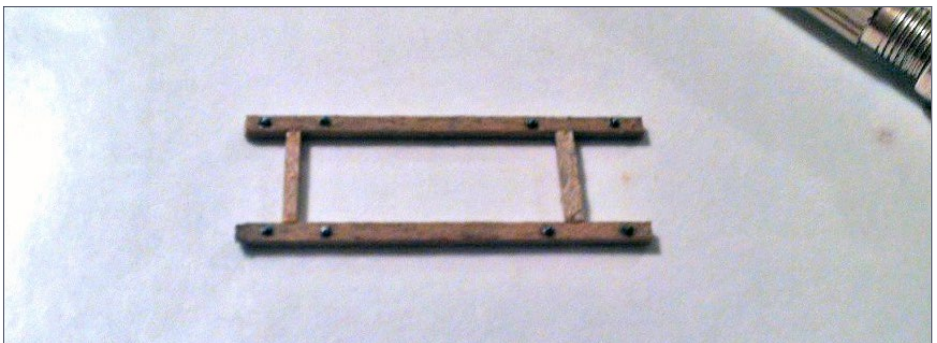

15. This shows the nut/bolt castings in place. I spray-painted them black, and then dry-brushed the heads with silver hobby paint. Then I cut them off and glued them in place with CA.

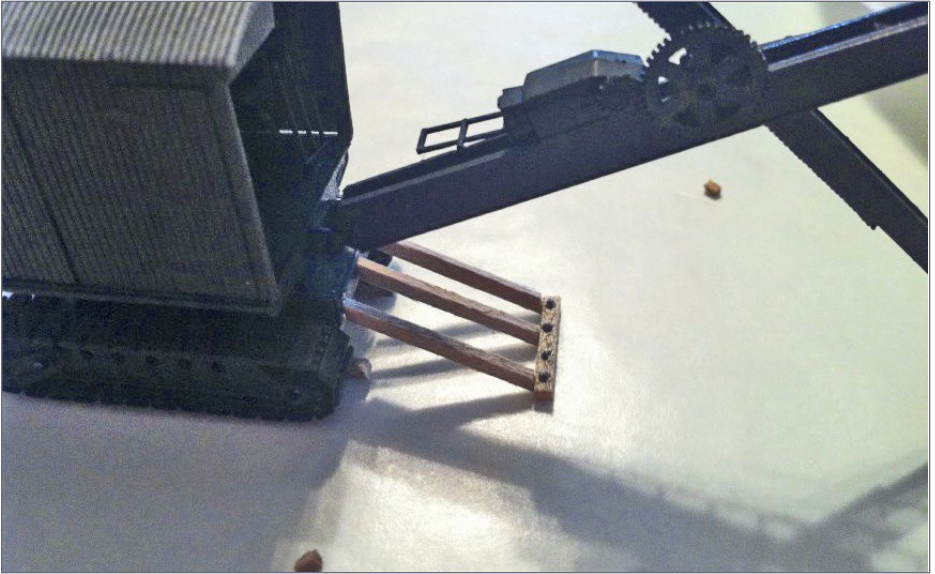

16. The bracing in the front of the steam shovel.

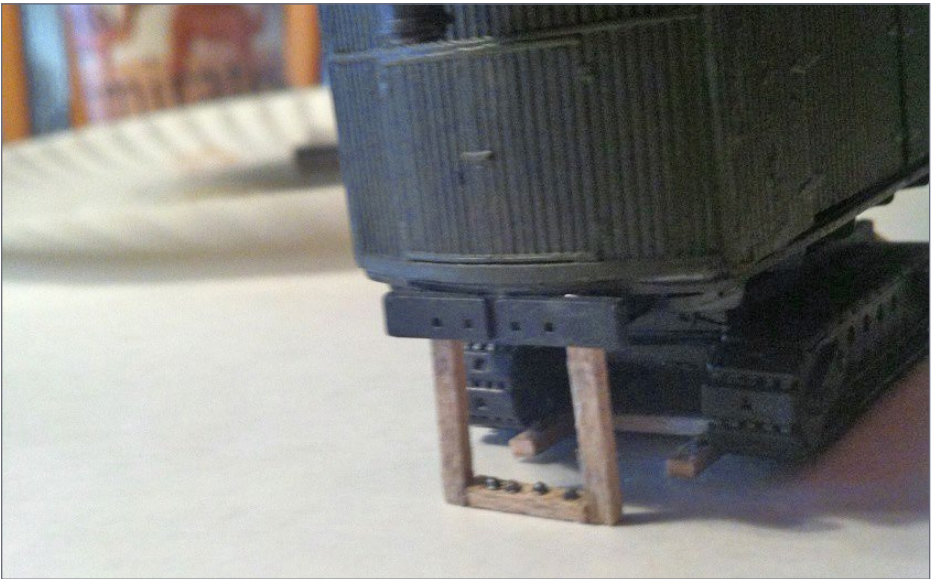

17. The start of the bracing in the rear.

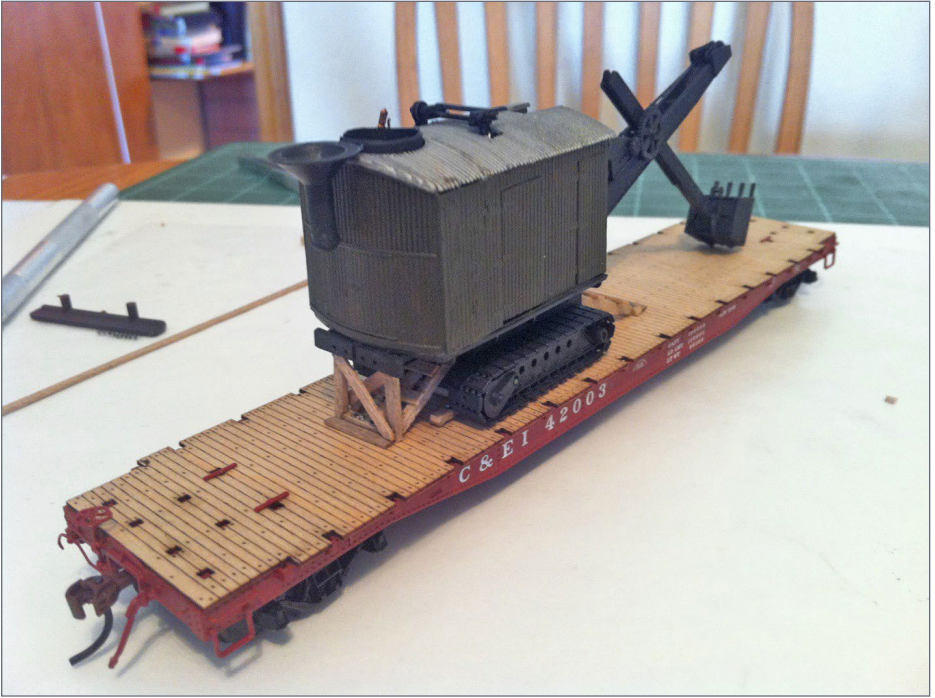

18-20. Most of the rear bracing is in place during a test-fit. I glued these pieces together on wax paper so that the CA wouldn't stick to anything. See following two pictures.

**Want to help
keep MRH free?
Then click on
Ads!**

AAR OPEN TOP LOADS | 15

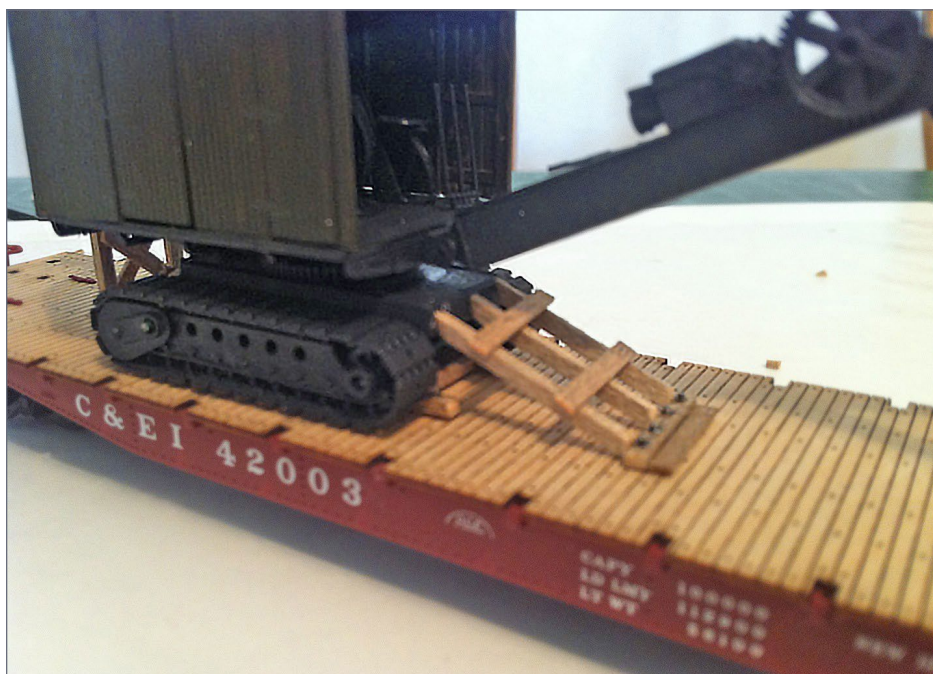

AAR OPEN TOP LOADS | 16

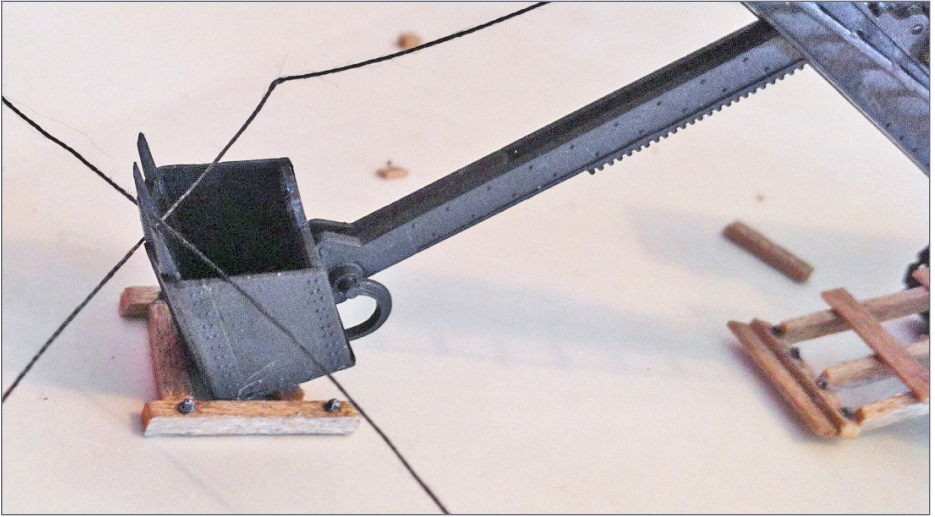

21. The bracing around the shovel. The threads are used to string the cables used to operate the shovel.

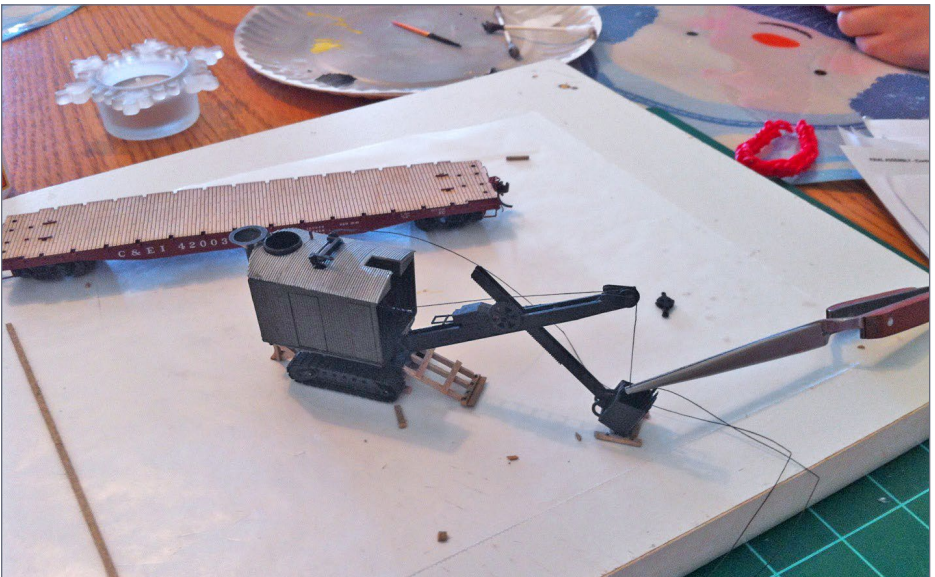

22. Most of the bracing is in place and the cables for the excavator are being strung.

AAR OPEN TOP LOADS | 17

In the final photo [36] you can see that I used wires as the tie downs. The 0.020" wire I used is stiff enough not to bend out of shape when the excavator is removed from the flat car. The ends of the wire simply fit into the pockets on the side of the flat car.

I used rare earth magnets to keep the load in place. These were purchased from an eBay seller for a few dollars. They are 1mm in thickness by 3 mm in diameter. I used an appropriate-sized drill bit to make a hole large enough for the magnets, and then applied CA to glue them in place. The magnets hold well to the metal weight that is in the flat car. I tipped the flat car to 45° to

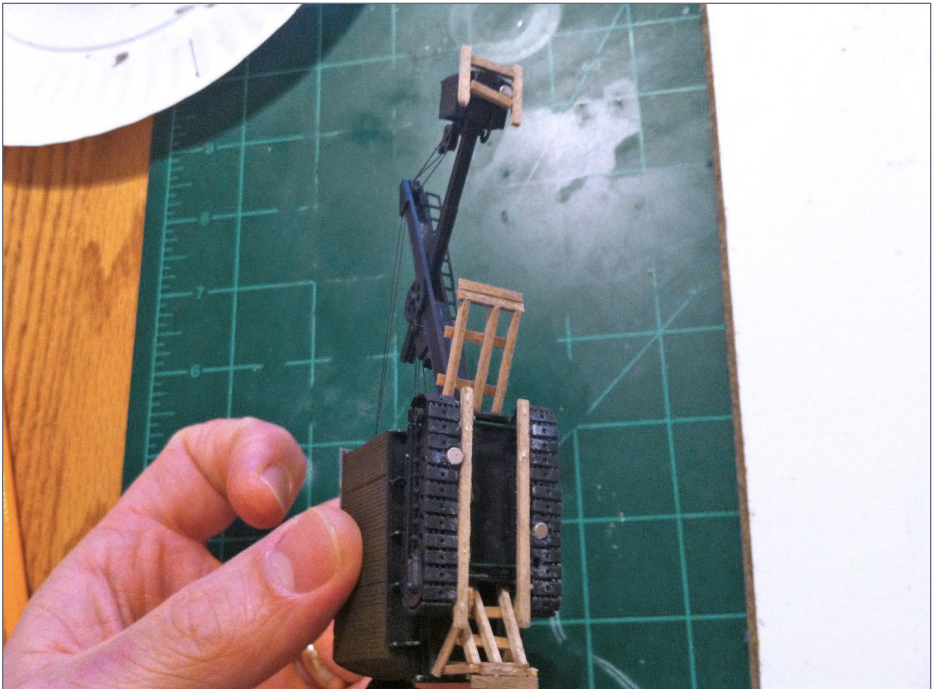

24. The excavator with magnets glued in place. It also shows the bracing from the underside.

see if it would fall off, and it didn't. They work well. Hindsight being 20/20, the only thing I would do differently would be to add the magnets at the beginning of construction rather than at the end. I had to re-glue some parts that fell off when drilling the holes for the magnets.

Modeling the road grader

I started this load by working on the flat car, an Athearn blue box 40-foot flat car. I dry-brushed the deck with white acrylic paint. After that dried, I used the same India ink wash, going back over it with a cotton swab to give it a weathered look.

The GHQ road grader is all metal and went together well. I sprayed it with yellow construction spray paint. The loading diagram, is much simpler than for the crane. It consists of sets of blocking placed against the tires to keep it from moving.

The diagram references a page that shows how to make the blocking. Just like the excavator, I used the correct sizes of wood and then glued the blocking into place on wax paper so the CA wouldn't glue it to the surface. It is a good idea to drill the holes for the magnets early in the project. The magnets hold the model to the flat car during operating sessions.

When talking to hobby vendors, please remember to mention MRH.

AAR OPEN TOP LOADS | 19

4

Sec. 3—Fig. 1 (Rev.—10-1968)

FOUR AND SIX WHEEL MOTOR GRADERS (WITH PNEUMATIC TIRES), LENGTHWISE—FLAT CARS

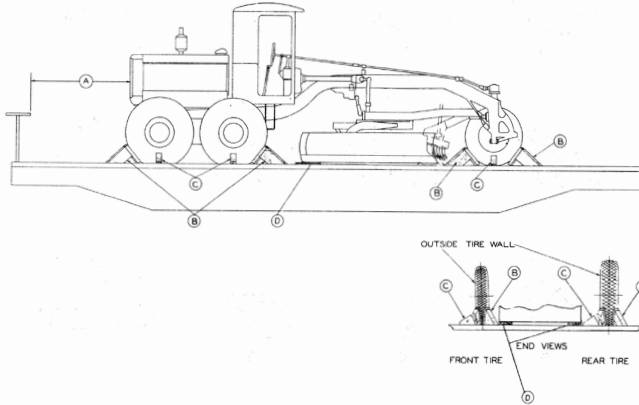

Item	No. of Pcs.	Description
A		Brake wheel clearance. See Fig. 2, Sec. 1.
B	16 or 8	Blocks, pattern 2. Locate two against front and back of each front wheel, two in front of each intermediate wheel and two in back of each rear wheel. Nail each to floor with two 60-D, three 40-D and one 20-D nail in heel and one 40-D nail in each side of block. For six wheel units weighing 10,000 lbs. or less, and for all four wheel units, use one Item "B" at each location.
C	6	Blocks, pattern 3. Locate all against either inside or outside of each wheel and nail each to floor with two 60-D, three 40-D and one 20-D nail in heel and one 40-D nail in each side of block.
D	2	1 in. x 6 in. x 24 in. Locate longitudinally under blade of unit, suitably spaced as shown, and secure each to floor with three 10-D nails.

*When the unit is shipped in a preserved condition, by or for the Department of Defense, the blade is to be elevated to maximum position and secured to the grader frame with ½ in. 6 x 19 preformed wire rope, length to suit, and two ½ in. cable clips. Mechanical or hydraulic blade controls must be placed in closed position and wired.

If so equipped, hand brakes must be tightly set and levers wired.

See General Rules 4, 5, 7, 9, 14, 19-A, 19-B and Fig. 1-B for further details.

1968

24. The loading diagram for the road grader. I colored this one as well, but it doesn't have the number of pieces as the excavator. Note it also references patterns 2 and 3, which are on the following diagram.

Part 1—Section No. 3

BLOCKING PATTERNS
ROAD GRADING AND ROAD MAKING MACHINERY

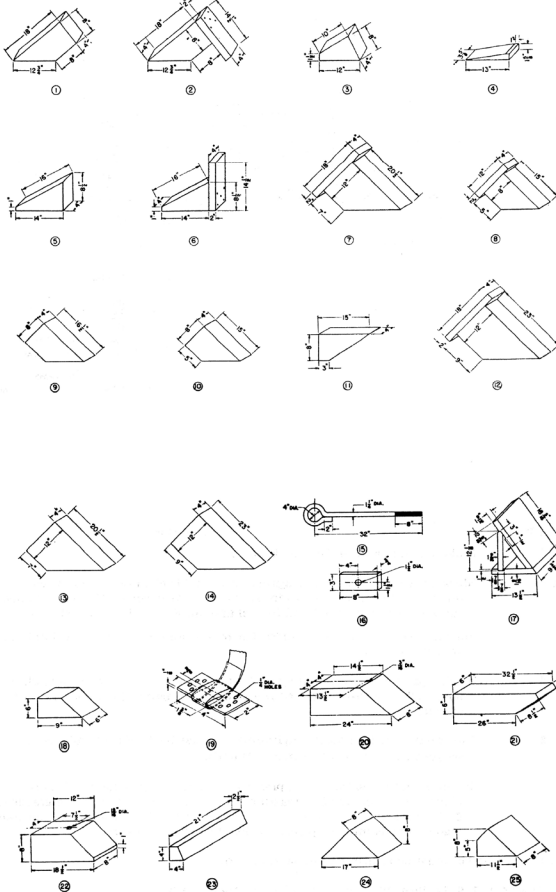

25. Blocks 2 & 3 are needed for the road grader. Note how it shows the dimensions.

AAR OPEN TOP LOADS | 21

Sec. 3—Fig. 1 (Rev.—10-1968)

FOUR AND SIX WHEEL MOTOR GRADERS (WITH PNEUMATIC TIRES), LENGTHWISE—FLAT CARS

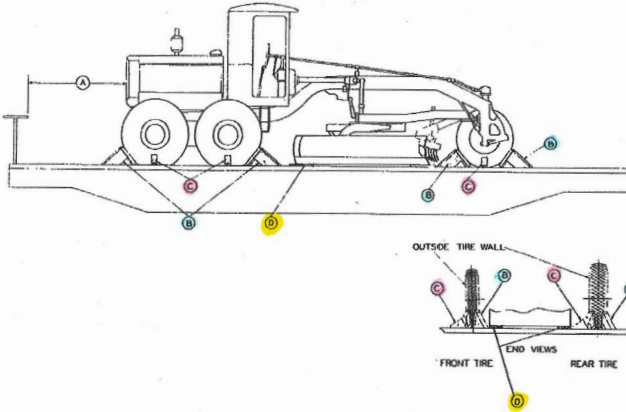

Item	No. of Pcs.	Description
A		Brake wheel clearance. See Fig. 2, Sec. 1. - p. 27
B	10 or 8	Blocks, pattern 3. Locate two against front and back of each front wheel, two in front of each intermediate wheel and two in back of each rear wheel. Nail each to floor with two 60-D, three 40-D and one 20-D nail in heel and one 40-D nail in each side of block. For six wheel units weighing 10,000 lbs. or less, and for all four wheel units, use one Item "B" at each location.
O	6	Blocks, pattern 3. Locate all against either inside or outside of each wheel and nail each to floor with two 60-D, three 40-D and one 20-D nail in heel and one 40-D nail in each side of block.
D	3	1 in. x 6 in. x 24 in. Locate longitudinally under blade of unit, suitably spaced as shown, and secure each to floor with three 10-D nails. *When the unit is shipped in a preserved condition, by or for the Department of Defense, the blade is to be elevated to maximum position and secured to the grader frame with ½ in. 6 x 19 preformed wire rope, length to suit, and two ½ in. cubic clips. Mechanical or hydraulic blade controls must be placed in closed position and wired.

If so equipped, hand brakes must be tightly set and levers wired.

See General Rules 4, 5, 7, 9, 14, 19-A, 19-B and Fig. 1-B for further details.

1968

26. The colored diagram for the road grader.



27. Weathered flat car.



28. Before bracing was added.



29. Wood bracing pieces for the road grader measured with a scale ruler.



30. Wood bracing pieces glued together.



31. Rare earth magnets 1 mm by 3 mm.

**Yes, we pay for
articles!**

**Need some hobby
cash? Consider
sending us an article.**

click to learn more ...

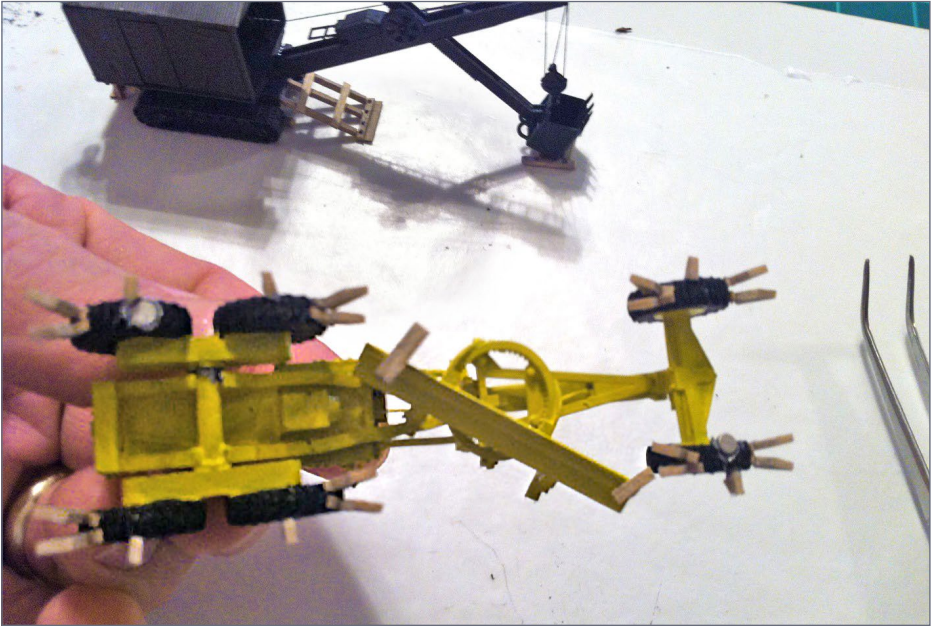

32. The road grader is upside-down with the magnets visible on the bottom of the wheels. I painted them black after gluing them in place.



33. All that is left is the final wire bracing that will go into the stake pockets.



34. It's done!



35. This is the final product. Here you see the wires that go from the crane to the flat car. There are two at the front and two on the rear.

I am quite happy with how this project turned out. It is very easy to remove these loads. For the crane, it takes a few seconds to line up the wires with the pockets, but it goes into the flat car relatively easy. These will make great additions to an operating session. ✓

DOUG FORBES



Doug has enjoyed model railroading since his junior high days, and is currently working on a layout of the Illinois Central in the late 1950s. He thanks his wife, Christy, and his three kids, Abby, Anna, and Isaac, for putting up with and sharing in this hobby of model railroading.

He is currently employed as a high school science teacher. ■



**Click here for
reader comments**

ADVERTISEMENT

The **PANORAMA** *Line*™

SUPER-DETAILED N SCALE PASSENGER TRAINS BY RAPIDO TRAINS INC.



**ALL
NEW!!**



**CLICK
HERE**

**Order deadline
October 30, 2015!**

MRHMAG.COM

- [TABLE OF CONTENTS](#)
- [INDEX](#)

SP&S SWITCHING LAYOUT

Based on Madras, Oregon

BY GREG BAKER AKA, MOUNTAINGOATGREG
.....



1. Greg models the SP&S Oregon Trunk line near Bend, Oregon on his home layout. When Greg went looking for a prototype for an "extracurricular" modular switching layout on which to demonstrate the challenges of real railroading, he ended up picking Madras, Oregon, another town also on his modeled line.

A real railroader designs a switching layout as the final exam for real railroad conductors ...



IT ALL STARTED WHEN I DECIDED TO BUILD a small switching layout as an “extracurricular” project to demonstrate the principals of switching safely and efficiently. I already had a home layout, so my space was limited for this extra layout.



**Click here for
reader comments**

I wanted a design that would support a variety of car types, would be relatively compact, and have some of the common hazards of a real railroad. These hazards would include things like spurs, crossovers, close clearances, and road crossings.

The space for this extra layout is 14 feet long and fairly narrow. I wanted to use Free-mo standards (free-mo.org/standard), but my space won't allow me to use a full 24-inch width. I designed the modules to be 18 inches wide, which still works with Free-mo. I also wanted a narrower module so they would be easier to transport and move around the house.

With the dimensions set, I looked for a prototype so I could anchor my layout plan in reality. I had already looked at Bend, which is where my home layout is set, but nothing was compact enough to capture everything I wanted. Later I came across the Madras, OR industrial area. I had planned to model this location at some point on my home layout, but for this extracurricular switching layout project, I found almost exactly what I was seeking. Notice I said: almost.

Inspiration and design

I located a station plat for Madras. The center of town along the railroad tracks has a sawmill, warehouses, and an elevator. The only thing it lacked was a crossover and some sort of hazardous

SP&S SWITCHING LAYOUT | 4

material. I used a little modeler's license to add the crossover and an oil distributor. See the plat map [2] and the overhead Google Earth views of the area [3, 4].

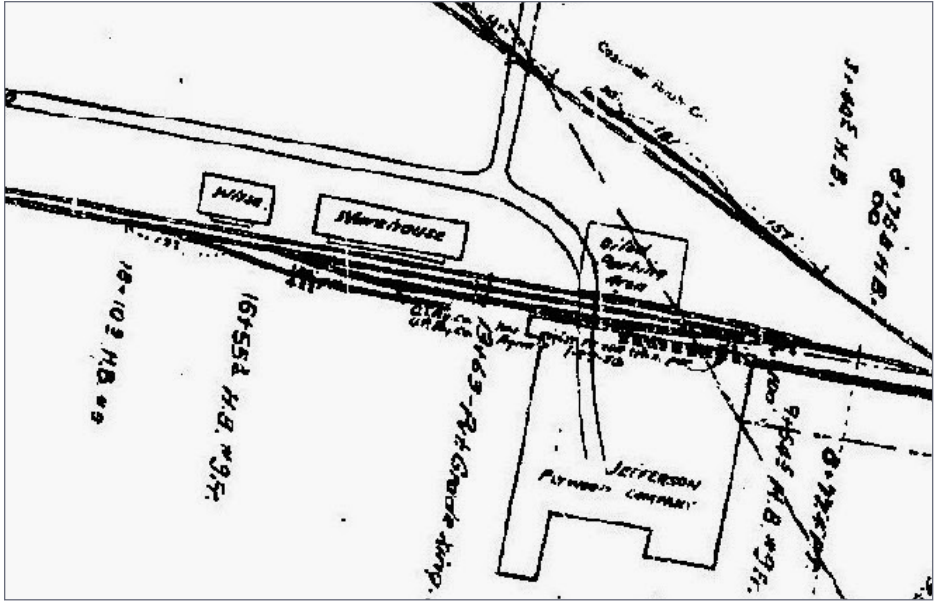

2. Station plat for Madras, Oregon.



3. Overhead Google Earth view. It looks kind of plain from the air, but there's lots of character in the buildings. The Google Maps link is: [google.com/maps/place/Madras,+OR+97741/@44.6546257,-121.1359106,17z/data=!4m2!3m1!1s0x54bee98a71bb48a7:0xc7e8145e5d1dfa82](https://www.google.com/maps/place/Madras,+OR+97741/@44.6546257,-121.1359106,17z/data=!4m2!3m1!1s0x54bee98a71bb48a7:0xc7e8145e5d1dfa82).

SP&S SWITCHING LAYOUT | 5



4. You can get an idea of the character of the Madras area from these photos, showing where Greg intends to place structures on his switching layout.

I developed a track plan that meets the Free-mo requirement, fits into the space I have available, and meets the other requirements I have for this project [5]. The one change I made to the prototype was adding the oil distributor and crossovers. The oil distributor and the crossover will be a separate module that can be added to the set if needed.

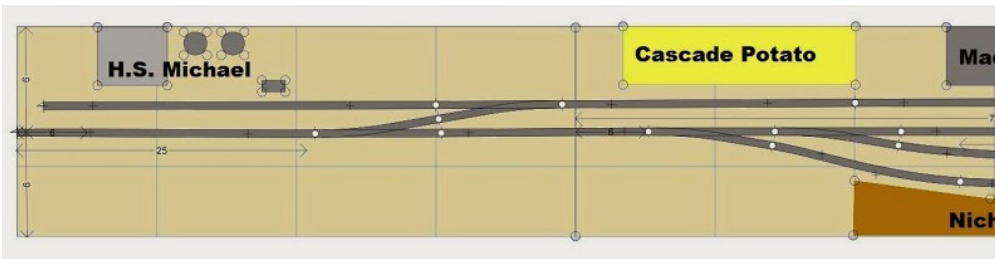

5. Track plan for Greg's Madras switching layout. The plan is also consistent with Free-mo modular standards.

SP&S SWITCHING LAYOUT | 6

I wanted to use the minimum number of switches possible in this design, and create the most operational interest. Yes, I could add more turnouts to make switching easier, but the goal is to operate this layout with a fixed number of cars and a specific set of moves. This gives me a “best” way of switching the layout and a way to determine the minimum moves necessary to complete the tasks.

A few things are going on in this plan that make it beneficial to have the crossover attached to a runaround. First, there are multiple customers on the same track. This allows an alternate route for car pickup without having to move all the cars. Also the industries can be switched by a train going either direction, which also increases efficiency.

My goal is to use this layout to help educate real railroad people on switching (*see footnote on bottom of next page*). I also wanted to have a variety of track industry arrangements to show different industry switching scenarios to the trainees.

When designing this layout, I wanted it to appear to be relatively simple. Only when you start switching it do you find it is not as easy as you thought! The lesson taught is that knowing

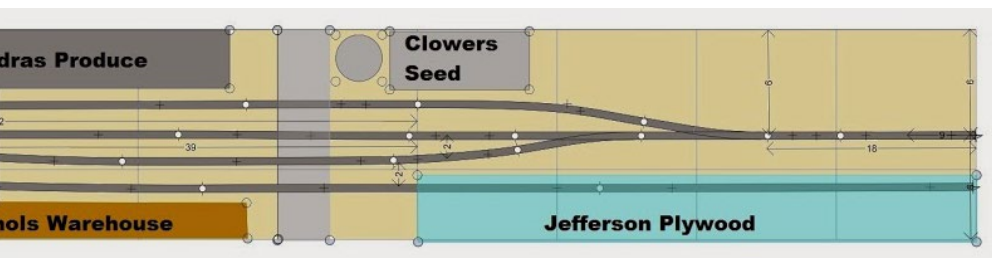

SP&S SWITCHING LAYOUT | 7

your circumstances, and conducting good job briefings are critical to success. It is a lot cheaper to mess up some HO scale equipment than some real 1:1 equipment. I planned it so you need to take some cars in more than one cut and also wanted a runaround required to spot the tank cars.

The plan is to start with a train sitting on the main. Left to right will be a loco, two cars for Jefferson, one car for Nicholas and one car for H.S. Michael. Finally come cars for Cascade Madras and Clowers in mixed order. Once the first trainee group has spotted all the cars, I will have the next group pick up the cars with the loco on the other end. I can either run the loco around or start “as is” for the next crew by scrambling the switch list See the sidebar: “The trainees’ test problem.”

Construction

I started construction on the modules and completed the basic modules over a weekend [6, 7]. I transposed the track plan to the plywood top and started gluing down cork. I took the modules

FOOTNOTE: From an MRH forum member who knows Greg: “Greg and I have known each other and have worked for the same holding company of railroads for about ten years. Greg has worked his way up from conductor, engineer, DSLE, Trainmaster, and now Safety Officer – so he brings a great deal of prototype experience to the hobby, along with wonderful creativity as an artist when it comes to scenery, backdrop painting and scratchbuilding. (A DSLE is a Designated Supervisor of Locomotive Engineers.)

“Greg and I became friends and now we work in the Safety and Rules department of the railroad, with one of our responsibilities being the training of new-hire conductors. We’re using all the technical ability we can – including using a model railroad switching layout to teach switching techniques. Greg and I previously discussed his track plan, and I agreed it should keep about a dozen students fascinated for 2-3 hours.

SP&S SWITCHING LAYOUT | 8



6-7. Greg erected the benchwork for these two modules in a single weekend.

outside and did some sanding to make sure I had smooth transitions all along the modules' top. Once I had completed the sanding, I put the modules back inside, put them together, and leveled them out. Next, I drew the track plan on top of the modules.

I glued some cork roadbed down: I used a combination of HO scale cork for the heavier used track and N scale for the industry tracks. After that, I painted the cork and exposed wood on the top of the layout.

I used Micro Engineering #6 turnouts for all switches and replaced the throw bars with PCB ties. I will eventually super-detail the switches with parts from the ME kits and from Proto:87 stores. I also plan to use Micro Engineering code 83 flex track on the main track.

For the auxiliary and industry tracks, I am using Central Valley tie strips and ME code 83 rail. For the transitions between

SP&S SWITCHING LAYOUT | 9

modules, I am using BNM Hobbies Free-mo tie strips. I am using both the Free-mo and intermediate strips for this project. They are a pretty clever design, allowing the rail to be soldered to CNC-cut boards, keeping the rail securely fastened and properly in gauge.

Once I laid all the track, I dropped the track feeders and wired everything to the bus, then tested the DCC by running an engine around.

I mounted the six Blue Point turnout controls, wired up the frogs, and added the throw rods. Finally, with the switch machines working, I had a working railroad!

I keep testing and adjusting the trackwork to make sure it runs well. I want the layout to be very durable and to last, so



8-9. Laying out the track centerlines on the plywood, and then gluing down the cork roadbed.

SP&S SWITCHING LAYOUT | 10



10. Laying the track, installing the turnouts, and attaching feeder drops to the rails.

outside and gave them a coat of Camouflage Brown.

While that was drying, I printed out some pictures of the area. I find working from the prototype to be the best plan of action for me. Next up is to determine exactly where to locate the structures, then to add Sculptamold to the foam.

Even flat parts of the world are not really flat. I first laid out where I was going to put the bulk oil tanks and building. Once

spending the extra time testing and tweaking seems worthwhile. Here's a video I shot during some of the testing [15].

To avoid a catastrophic event if something derailed, I added foam tops to the layout.

Before I started the ground scenery, I knew I wanted to spray paint my ties, so after placing the missing ties to hide the feeders, I took the sections

SP&S SWITCHING LAYOUT | 11

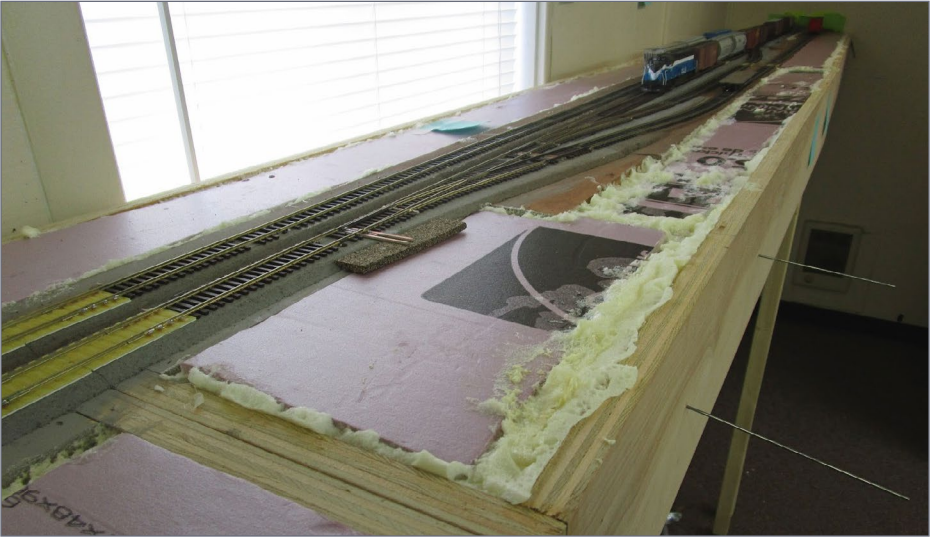

11. Filling the open spaces with foam in preparation for scenery work.



12. Greg added Sculptamold contours on top of the foam and spray painted the track with a camouflage brown spray paint. You can see how the taller HO cork roadbed realistically elevates the mainline above the industry spur.

SP&S SWITCHING LAYOUT | 12



13. Greg used Micro Engineering (ME) turnouts, but replaced the throw bars and headblock ties with copper-clad PC board ties. Greg will add ME and Proto:87 Stores turnout detail to the turnouts to enhance their realism.

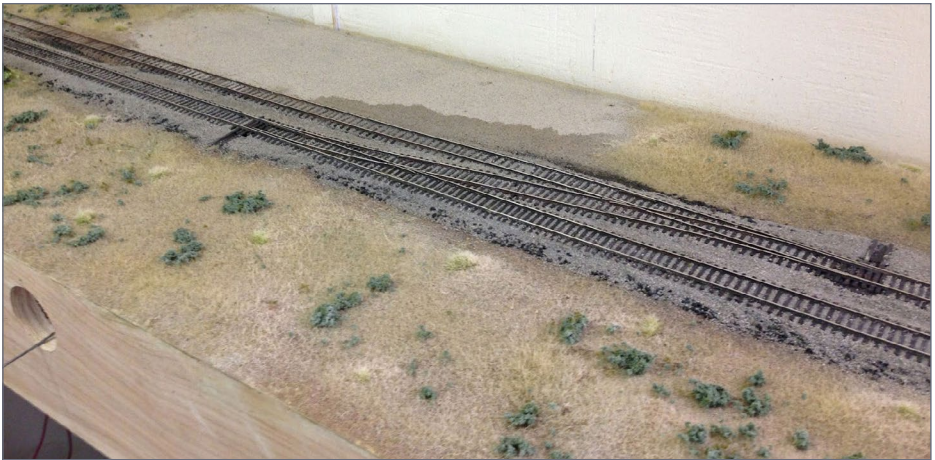

14. At the time of this writing, Greg is adding ballast, dirt and basic ground cover to the layout. Next will be building the specific structures needed for the layout. The space here is for the bulk oil depot.

SP&S SWITCHING LAYOUT | 13

I had that figured out, I mixed up some Sculptamold. I added some brown paint from the “oops” section at Home Depot to the Sculptamold mixture. Using this “goop,” I made a few undulations in the terrain to get it away from being perfectly flat.

When I designed these modules, I wanted them to have the look and feel of a branch line. The track that connects the modules would be older and well-worn, but still in good shape. The various industry tracks would be a little more worn-out.

Because I knew that some of the tracks would have older ties and dirt ballast, I decided to really weather those ties that were to be down in the dirt. I used a mix of oil paints and once the ties were painted gave the rail a coat of paint too. This forms the first layer, as I will need to touch things up once all of the ballast is down.

Paints I used are the Windsor and Newton water mixable oil paints. The colors were Burnt Sienna, Ivory Black, Raw Umber and Titanium White. I mixed them as needed to create different shades of browns and grays and painted the ties in a random pattern.

After the Sculptamold dried I painted the top of the module and covered it with actual dirt. In areas that were not well-covered, I added more dirt and sprayed it with water. While the dirt was still wet, I coated it with a 50:50 mix of water and matte medium, with a little rubbing alcohol added to break the surface tension.

Then I added static grass and some shrubs and bushes. Next up will be doing the structures, but that’s for another time. Even though the layout is not finished, I was able to put it through its paces with some students. Read about it in the sidebar: “The trainees’ test problem.”

SP&S SWITCHING LAYOUT | 14

Note: This article was derived from a pair of MRH forum posts by Greg. See mrhmag.com/node/22267, and mrhmag.com/node/22786.



15. Greg shot this video while testing and debugging the trackwork. The sound is an out-of-the-box Tsunami from Soundtraxx, factory-installed by Athearn. The master volume is turned down a little from the default setting. He is pretty happy with it and will get more of these sound locos.

See the following sidebar ...



**Click here for
reader comments**

THE TRAINEES' TEST PROBLEM

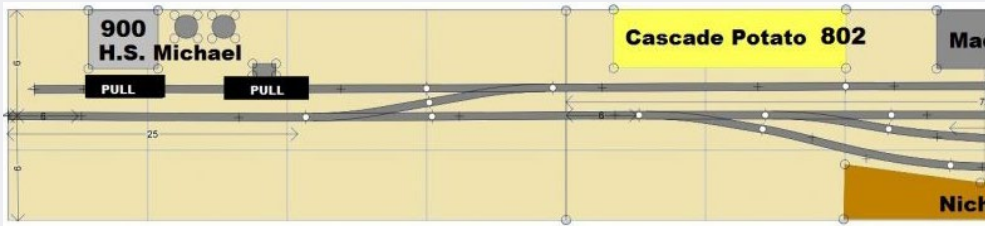

16. Setup for the trainee test problem.

I recently used my Madras, Oregon switching layout for a training session of new-hire conductors. While this little layout is far from finished, all of the track works and I got the turnout controllers operational. Other than a little dirty track and a switch that needed some adjustment, the layout ran really well.

For this operation problem, the purpose is to reinforce in a controlled environment how to switch safely and efficiently. Also, most of the people in these classes did not realize that railroading could be a career until they got the job. Needless to say, they are not experienced with railroading – model or otherwise.

In order to make this a good training tool instead of a fancy toy, realism is a must. I started by pre-spotting cars around the layout [16] and creating a list in Excel similar to the switch lists used by the real railroad. I also placed a train on the mainline with cars blocked to customers destinations on the layout [17, 18].

This was the first time any of them had seen switch lists, so I spent a good amount of time going over what each column means, and showed the difference between the cars to be spotted

SP&S SWITCHING LAYOUT | 16

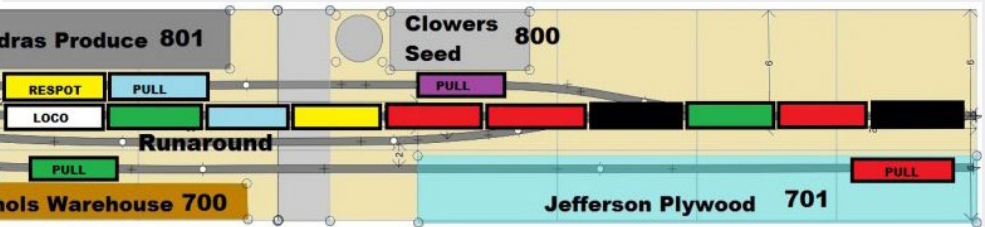

and the cars to be pulled. In order to not make it completely confusing I did condense the lists a little by removing a few columns. Along with the switch lists, I gave them a map of the track with each track numbered to match the customer.

JOB		ENG/COND			TRAINMAN	DEPARTURE		ARRIVAL		
						Date/Time		Date/Time		
SEQ	H	EQMT	L/E	KD	Block To	Switch Instr	Track/SP	Commodity	TRACK	MOVE
		Station: MADRAS			TRACK 700 NICHOLS WARE					
1		NP 62025	E	F	BEND	PULL				
		Station: MADRAS			TRACK 701 JEFF PLYWOOD					
1		CBQ 9836	L	B	BEND	PULL		LUMBER		
		Station: MADRAS			TRACK 800 CLOWERS					
1		GN 170100	L	B	BEND	PULL		WHEAT		
		Station: MADRAS			TRACK 801 MADRAS PROD					
1		NP 76325	E	H	BEND	PULL				
2		NP 76777	E	H	CLOWERS	SPOT				
		Station: MADRAS			TRACK 900 HSMICHAEL					
1	H	SHPX 17154	L	T	BEND	PULL		*SODIUM HYDR*		
1	H	MKT 9707	E	H	BEND	PULL		*AMMON NITRA*		

17. Here is the pull list. H indicates a Hazmat car and the crew has separate paperwork to explain the hazard.

SP&S SWITCHING LAYOUT | 17

JOB		ENG/COND				TRAINMAN	DEPARTURE		ARRIVAL		
							Date/Time		Date/Time		
SEQ	H	EQMT	L/E	KD	Block To	Switch Instr	Commodity	Station	TRACK	MOVE	
Station: Bend					M/L 100						
1		ATSF	E	B	Nchols Ware	Door 2		MADRAS			
2		GN	L	H	Madras Prod		OATS	MADRAS			
3		CR	L	H	Clower Seed		OATS	MADRAS			
4		WP	E	B	Jeff Plywood			MADRAS			
5		SP&S	E	B	Jeff Plywood			MADRAS			
6	H	RTLX	L	T	H.S Michael	Tank	*CHLORINE*	MADRAS			
7		GN	L	B	Nicholas Ware	Door 1	PAPER	MADRAS			
8		MP	E	B	Jeff Plywood			MADRAS			
9	H	NP	L	H	H.S Michael	Hopper	*AMMON NITRA*	MADRAS			

18. Here is the spot list. As with the pull list, an H in the second column indicates a hazmat car.

With all the paperwork in hand, I allowed them to then see the layout and get a feel for what they were up against. I asked for volunteers and two individuals were chomping at the bit to give it a try. I instructed the “engineer” on the use of my Digitrax Zephyr and allowed him to move the train forward and backwards. Next I showed the conductor how to unhook cars using a sharpened #2 pencil. I also showed them how to throw the turnouts and check the point position. After that, I stepped back and watched.

Crew #1: I have two guys in class who went to a railroad vocational school, so they came with some experience. I made them go first. After looking over the paperwork for a while, they decided to start moving cars. I’m not sure the conductor had a plan, but he started moving cars anyway.

He decided to tackle the back track with Clower and Madras Produce. After finding out the hard way that only the loco and

two cars would fit between end of track and the crossover, they were able to get one car pulled.

I decided to keep them from totally getting stuck, so I swapped out conductors. The conductor I had take over had been watching, and had seen a few moves that would have made things easier. After 20 minutes, he had taken care of Jefferson Plywood and Nichols Warehouse. He then made a mistake by pulling H.S. Michael and coming down the main, getting himself totally stuck. I guess you can't win them all.

Crew #2: While crew #1 had been flopping around like fishes out of water, two of the guys went into the next room and developed a game plan. They came back in and watched Crew #1 try to get themselves unstuck, and informed us they had a plan they thought would work.

I decided to reset the layout and let them have at it. They still made a few double moves and almost got themselves stuck once when they tried to grab too many cars, but caught their error before it was too late. I allowed a few of the other team to take over and complete the plan crew #2 had developed.

Conclusion: After all the cars were spotted and the pulls were on the main with the power on the opposite end, we concluded with a debriefing.

Overall, the group thought it was a great exercise. I plan to use the layout again with the rest of the class. I also plan to add some derails, track stops, clearance markers and maybe even a timetable of trains coming through heading to other destinations.

They did ask me for more track, and I told them they cannot go any further to the right as that goes out onto a CTC controlled

mainline. They cannot get a signal for the main until they are ready to return to Bend, OR.

I said the other end has a MOW project and foreman Smith won't let them past the red board. I reiterated that there's enough room to get the job done, and that customers are waiting!

It does get them to think outside the box and still complete the task. I also think this proves that a deceptively simple-looking layout can be a real challenge. ■

GREG BAKER



Greg Baker has been “seriously” model railroading since 2000, but as long as he can remember he has always been fascinated by trains.

Greg's main interests are the railroads of Central Oregon in 1968 with the focus on the SP&S, Great Northern, and Union Pacific along the Oregon Trunk. He is also interested in the City of Prineville

Railway and its connection to the Oregon Trunk.

He currently resides in Lewiston, Idaho, with his wife and two children as he continues his career in railroading. He is actively involved in promoting Free-mo and has created an Idaho Free-mo group. ■

WHAT'S NEW! ON TRAINMASTERS.TV



2015 NATIONAL TRAIN SHOW

Miles Hale visits the 2015 National Train Show and discovers the diversity our hobby offers.

Non-members: Watch for just \$1.49!



BLUE BOX FAN UPGRADE

Who would have thought replacing cast-on rooftop fans with see-through parts could be so easy?

Non-members: Watch for just \$1.49!



EASY STRUCTURE INTERIORS

Modeler Miles Hale shares some quick tips for giving buildings a more lived-in look.

Non-members: Watch for just \$1.49!



MAKING OPEN LOADS

Miles Hale demonstrates quick tips on getting great looking loads for your empty open-top freight cars.

Non-members: Watch for just \$1.49!

Watch these videos on TrainMasters.TV

(Non-members can now watch one of these videos for just \$1.49, or download-to-own for \$3.49)



BUILDING MARSHFIELD HILLS



BY MICHAEL TYLICK, MMR
.....

Manipulating perspective to create a realistic New England scene ...

WHEN THE MARSHFIELD AND OLD COLONY Railroad reached Marshfield Hills, MA in the 1880s, the only possible path was between the ocean and Telegraph Hill. The town was incorporated in 1640 and predated the railroad by several centuries. Neither the entrenched old Yankees nor their townie government were about to sell their homes to the big city railroad people. The only possible route was alongside

Route 139, better known as Ocean Street.

None of this may ever have really taken place, but it

makes a good story to explain my scale-sized world. It's fun to build a scene and then make up stories to explain it away. This tale sounded good, but now I had to figure out how to include oceanfront, salt marshes, a railroad and a highway in front of a town nestled on a hillside. At least it was a small town. The only option I could see was to use what has become popularly known as "forced perspective" in the hobby.

The idea of rendering distant objects smaller to appear further away is not new. Examples of inverse perspective – making important objects larger than subordinate objects – can be found as early as the tombs of ancient Egypt and Mesopotamia. Examples of creating depth by depicting objects smaller than scale appear on Grecian urns and Roman friezes well before the birth of Christ. Greek mathematicians quantified perspective by formulating mathematical equations to help accurately depict distance.

By the Early Renaissance, other types of perspective were commonly used by artists. Linear perspective creates the effect of distance by making parallel lines converge to vanishing points. Aerial perspective uses hazy coloring to make objects appear farther away. As obvious as overlapping perspective – placing a foreground object partially in front of a more distant one – may seem to us, it does not appear to have been used in ancient work. We see these effects so often in photography and realistic



[Click here for reader comments](#)

BUILDING MARSHFIELD HILLS | 3

drawing and painting that we take them for granted. Yet the idea of applying these artistic principles to model railroading still seems novel.

In freshman design class we were assigned the project of constructing an “infinity” box, a foot square shadow box with the depth of one inch. Our problem was to make this very shallow space appear to have as great a depth as possible. As you might imagine, there were as many solutions as there were students, all of which worked to some extent. So perspective always seemed a natural element to incorporate into my model scenes, much more obvious than innovative and certainly not “forced.” But I could ramble on about the history of art. Let’s take a step-by-step look at how I attempted to make the O scale town of Marshfield Hills fit a very narrow shelf. ☑

ADVERTISEMENT

Spread the word about MRH!

NEW!

MRH and TMTV apparel ...



Adjustable black baseball cap with a red brim and laminate MRH logo.

~~\$15.00~~
\$10.00
+Shipping



MRH t-shirt with eye-catching silvery logo against jet black fabric.

~~\$18.00~~ **\$15.00** per shirt
+Shipping
Sizes S-2XL



T-shirt displaying a TMTV logo against a deep chocolate brown fabric.

Get your apparel TODAY
store.mrhmag.com

BUILDING MARSHFIELD HILLS | 4



1. Telegraph Hill, the site of the future town of Marshfield Hills on this On30 layout. I added dirt and grass – little of this will be visible when I am finished, but I can get an idea of my final land forms this way. This simple scenery is much more attractive than benchwork!

It is not often that well-kept, desirable older houses get modeled, but these fit the affluent communities my railroad served. This is the Duxbury House, a Bar Mills O scale kit.

Rather than build a small mountain of back fill, I am using a few foam blocks to raise the foreground structures up to meet the sidewalk.

I cover the track with blue painter's masking tape during scenery construction. Unlike the buff-colored masking tape, the blue tape can be left in place for months and leaves no residue.

BUILDING MARSHFIELD HILLS | 5



2. Next I installed the Miss Marshfield Diner, a Bar Mills “Sweaty Betty” kit. I detailed the construction of this diner in *Model Railroad Hobbyist* for September, 2013 (mrhpub.com/2013-09-sep/land/#90). The highway slants downhill, so I added a concrete wall to the front.

I modeled the dirt road along the tracks on a filler of sawdust, white glue and water. I find this inexpensive material is ideal for back fill. It is easy to mix a batch in advance and keep it in a covered plastic container until needed. It dries slowly, so there is a long working time. The color is such that I do not have to worry about the bare spots.



3. Before hydraulics gave us large earth-moving equipment, hill towns used all sorts of imaginative engineering to make the infrastructure fit the terrain. Roads had no trouble diving down a steep hill and sidewalks often ended up with very high curbs and steps. I must remember to add railings before I get too much further.

Here, I've added the next section of the highway. Because the road runs mostly parallel to the viewer, it can be made narrower than it would be in reality. But we have to be careful to place only a few small vehicles in the right places.



[Click here for reader comments](#)



4. New England hill towns usually have streets running parallel to the hillside, and the effect is to see upper stories and roof-tops protruding from the foliage.

I want to suggest more streets like this behind the diner, but there was no room for much more than some low-relief “flats.”

It is sometimes difficult to tell scales when building structures, but this small house is essentially S scale, so it’s a bit smaller than full scale on this O scale scene, giving an added sense of distance and perspective.



[Click here for
reader comments](#)



5. I installed the house behind the diner, with their walls almost touching. I used styrofoam to level the house. Hot glue fastens these background structures quickly and securely on uneven ground.



6. Since the Duxbury House at left is on the same vertical plane as the red house behind the diner, but it now looks too large to me. I am not sure how to resolve this problem as yet.

**Want to help keep
MRH free?**

Then *click* on ads!

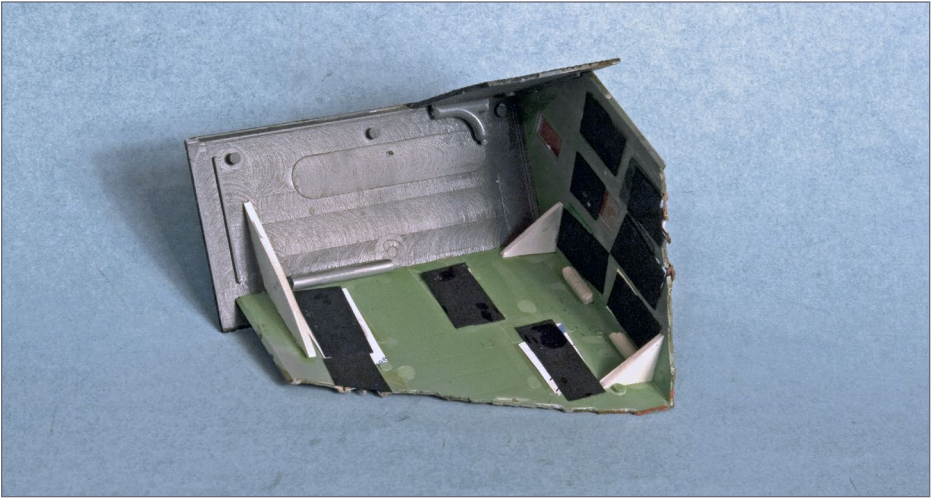

7. I assembled this gray house from the scrap walls from an HO scale Con-Cor Aunt Millie's House kit. I cut the walls to fit the terrain. O scale has the advantage of being able to draw on several smaller scales for inexpensive kits for the background.

8. The gray house from the back.



9. The installed gray house.

**When talking to
hobby vendors,
please remember
to mention MRH.**

BUILDING MARSHFIELD HILLS | 12



10. The picket fence and stone wall make the very narrow yard appear larger. The fence is almost touching the fireplace.

The dirt path curves from a very narrow strip hidden behind the S scale Bar Mills board fence into a much wider road as it approaches the concrete highway, an example of linear (vanishing point) perspective.



11. As described [10], the road perspective in front of the house is rather exaggerated, but a Bar Mills billboard (S scale) hides the worst of it.

**Did you know MRH readers
have built a free MRH index
you can search?** [click
here](#)



12. Waste not, want not. I got this shed from the rear of a Carolina Craftsman Kits structure. It seemed too nice to send into oblivion in my scrap box. Telegraph Hill rises up rather abruptly from the parking lot, so this break to ease the transition is most welcome.

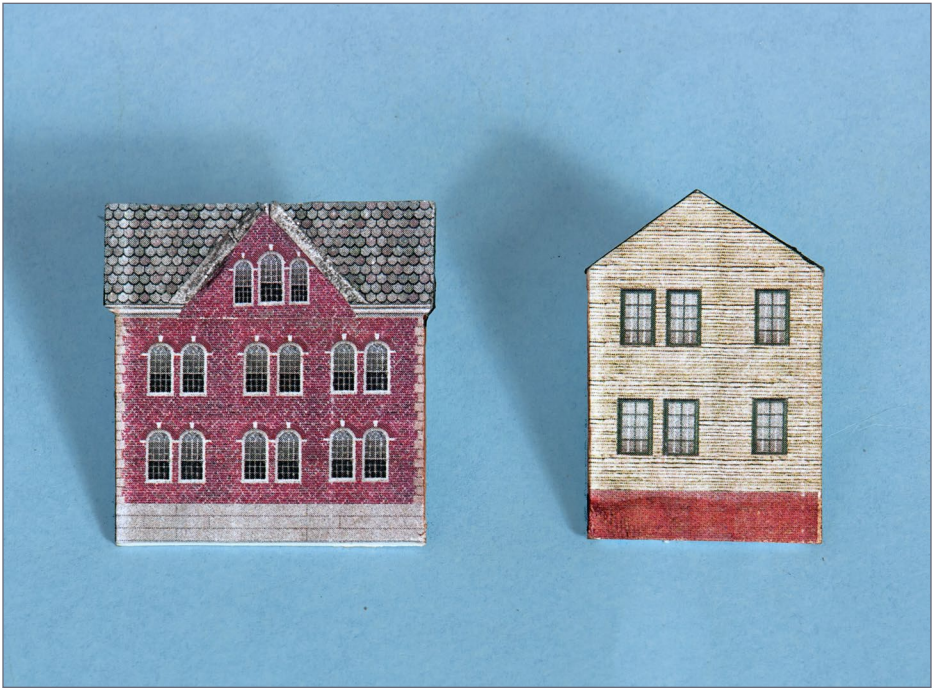

13. I didn't have any Z scale supplies or kits on hand, but the Model Builder software package available from Micro-Mark is a quick and effective way to draw background flats. When glued to a piece of illustration board, they are quite effective for distant structures.

Almost 40,000 have read this MRH forum thread - have you?

[Home](#) / [Forums](#) / [Track and electrical/DCC](#) / [What DCC system do you use - and why?](#)

What DCC system do you use - and why?

Mon, 2010-08-02 11:03 — [joef](#) [Track and electrical/DCC](#) [DCC - Electrical](#)

I'm curious what DCC system various modelers on here are using, and why? I think it's useful - so post a bit about the system you use and how you came to choose it. Also if you have any learnings, that's always helpful!

**Read
now**





14. The overall scene from the front as it is developing. I've placed the z scale flats, in addition to a simple N scale structure I built from styrene. The next building on the foreground street to the right, a kitbashed Bar Mills Amos Cutter's General Store, is in place as well as another S scale billboard.

With the exception of the Duxbury House on the left, the houses appear farther away as they climb the hill. I am hoping that foliage will hide a multitude of sins.



15. Using an old Dremel tool and a finishing nail, I have drilled holes for inserting trees into the background. The hardshell drills quite easily and I drill more holes than necessary. I'll use ground cover to cover over the white plaster spots and the bare holes.

My sawdust filler is very hard to drill, but if I hit a patch, wetting the scenery softens the filler sufficiently in just a few minutes.



16. There are many excellent tree products on the market, but I have always preferred this local weed. No one seems to know what it is called but patches seem to pop up each autumn in random places. I use hundreds of these trees, and the price is right.



17. The background is forested. The bare trees seem to enhance the feeling of distance by obscuring the smaller scale structures. The foliage also helps hide the otherwise excessively large size of the Duxbury House on the left.

Want to keep MRH free?

CLICK on ads.

If ads in MRH don't get clicks, then advertisers won't advertise with us, it's that simple ...



18. Woodland Scenics ground foam foliage netting on top of the tree armatures completes the background. Although often maligned, I like this material because I think spreading it out on top of tree armatures best conveys the airy feeling of autumn at its height. The more I can stretch it out, the better the appearance.

I have found I use considerably less foliage by applying it in place on the layout rather than the workbench. I save the foam droppings for ground cover and small bushes. It seems like more than half the bag falls off while stretching the netting.

I find the colors of the fall season to be just too beautiful to pass up.



19. A coat of earth-colored latex paint on some black gator-board hill profiles gives a good background color. I then attached coarse and extra coarse foam is to the backdrop with white glue. Eastern mountains are mostly covered with foliage, so they are easy to depict with this method.

20. The background hills add depth to the scene. Hot glue is all that is needed to attach the self-supporting Gatorboard to the layout.



21. Since this is O scale, larger details at mid-depth will be easily seen, but steer away from objects with very fine detailing. Some figures, automobiles, and larger objects like benches, telephone booths, and trash cans are sufficient. Too much fine detail will attract the viewer's eye and serve to degrade the illusion of depth.



22. With a train and a backdrop. Until this layout section is moved to its final home, Photoshop will have to do for simulating the backdrop.

MICHAEL TYLICK, MMR



Michael Tylick has built a number of smaller layouts of various types and scales over the years. Mike has been a long time contributor to Model Railroader, Railroad Model Craftsman, the National Model Railroad Association Bulletin, and other hobby publications. He has also delivered numerous clinics and presentations on various railroad and historical subjects.

He now works as a custom builder of railroad structures and rolling stock, and is the owner of RailDesign Services, for design and graphic aspects of model railroading. ■



[Click here for
reader comments](#)



The Carissa Saloon, 1890

MRHMAG.COM

- [TABLE OF CONTENTS](#)
- [INDEX](#)



BY DOUG DICKSON
.....

MRHMAG.COM

- [TABLE OF CONTENTS](#)
.....
- [INDEX](#)

Make impressive structures using paper ...



[Click here for reader comments](#)

I GREATLY ADMIRE THE BEAUTIFUL WOODEN models I see in MRH, but the materials are difficult to source both where I live in France and in Britain, so I prefer to build structures with cardstock and printed papers. I rarely see these materials used in MRH, so I decided to build my version of a typical U.S. outline structure based on the Carissa Saloon in South Pass City, WY. It may even encourage other people to try their hand at card and paper work!

Doubtless, most U.S. modellers would prefer to download shingle and log texture papers but I have used the same Scalescenes

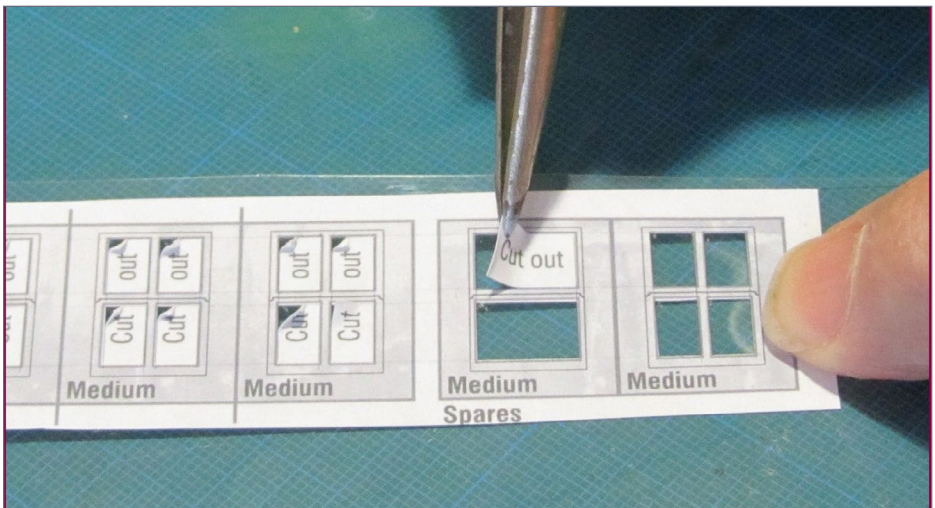

1. Peeling Paper from window acrylic



2. Front door and window assembly.

(scalesscenes.com) texture papers I use in many of my British models – old corrugated iron for the roof, plain and white clapboard, and squared rubble stone.

I printed computer-drawn window elements onto self-adhesive paper labels, which I stuck to clear acrylic sheet before cutting just through the paper horizontally and vertically along the appropriate printed design lines. There is no need to stop at each corner; the adhesive holds the minute intersections in place while peeling off the “glass area” using tweezers. With practice, bars as fine as .015” are achievable [1].

I stuck the printed one-piece front windows and doors onto more clear acrylic sheet, and in the same way removed the clear glass areas before cutting through the paper either side of the doorway, allowing the sheet to bend against a straightedge to form the recessed doorway. Then with strips of .020” card, I built up frames around them [2].

THE CARISSA SALOON | 5

I cut sides and back walls in .040" card, cut out the side and rear window and door openings and then covered them with plain clapboard paper. To stick texture papers to card I prefer the 'Stick' type glues, and apply the glue to the card, not the paper, to prevent the paper becoming delicate to handle as the glue softens it. Some sort of roller is essential to ensure even, bubble free paper covering and to keep corners crisp and sharp where it wraps around components. I use a wallpaper seam roller shown here beside the inner floor blank, back wall and roof support [3].

When the glue was completely dry, I cut down vertically through the paper in the center of each opening before folding-back and gluing the paper to the inside face with white glue. When this glue was dry, I stuck the windows inside the openings with contact

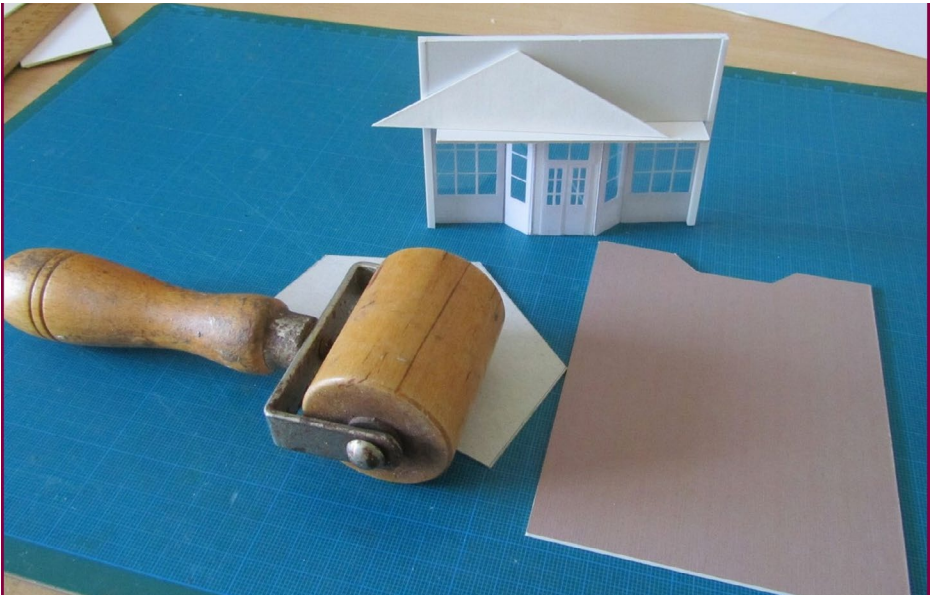

3. Paper roller and floor cut-out with interior view of building front wall.

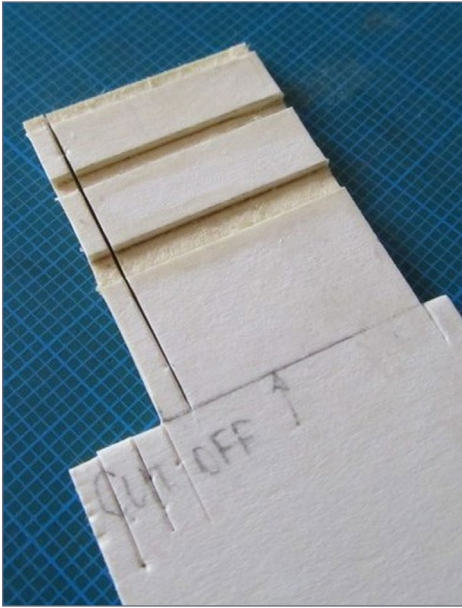

4. Grooves cut in fence post material before separating individual posts.

Tip: For fencing and railings, cut several identical posts from one piece of card before separating them. With care, the vertical and horizontal elements of wooden field gates join in a far more convincing manner than by simply gluing the bars and posts one on top of the other.

Slightly bending some parts and the use of thick dirtied acrylic paint adds to the effect [5].

I glued a flat card roof across the whole of the building in between the false-front wall and the back wall gable, added a center triangular support and then glued the cereal-box card roof over all,

adhesive. Small strips of card formed the window sills.

With the windows securely fixed, I glued the back and side walls around a .040" cardstock inner-floor blank, and then built up the false front to incorporate the acrylic front window assembly. I printed the sign onto white clapboard paper.

The steps and railings I made from .070" pasteboard. The layered build-up of this dense card lends itself easily to cutting half-lap or bridle joints to make convincing looking structures simply by cutting half way through and peeling out a portion [4].



5. Slightly bending some parts and using thick dirtied acrylic paint adds to the effect



6. Distressed roof and ridge covering.



7. Miss-cut roof covering to represent a slipped sheet of corrugated iron.

THE CARISSA SALOON | 9

covered with aged corrugated iron paper. I deliberately cut misaligned edges and bent the card to add a little realism. Some scraps of paper overlapped from the ridge covering, [6, 7].

Small pieces of watercolor-tinted matchsticks added under the eaves give the impression of rafters. I used scrapbooking scissors to cut decorative bracket details to approximate the original design, and added a stove pipe fashioned from a cocktail stick and a scrap of drinking straw. Once completed I did a little light weathering with watercolor, then protected the glazed areas with Post-It notes before spraying the whole building with matt artist fixative spray, the sort that is used by pastel artists to 'fix' their pictures and add some UV protection [8].



8. Matchsticks represent the ends of rafters.

Conclusion

I frequently hear doubts expressed concerning the long-term viability of card and paper models, but by using genuine printer inks on good quality paper and protecting buildings from both direct sunlight and extremes of humidity I have buildings nearly 20 years old that are still in good condition.

Overall, I feel I have achieved a model that evokes the feel of a building of the 1890s and hope this example will encourage you to try using cardstock and paper.



[Click here for reader comments](#)

DOUG DICKSON



Doug Dickson is a retired marine engineer. He worked with steam and gas turbine propulsion systems, and now lives in southwest France with his wife and terrier. Doug enjoys gardening, steam traction, food and wine.

He enjoys structure modelling the most, and scratchbuilds a variety of buildings and digital card models. Doug is busy designing a portable 8 x 2 foot “shunting puzzle” layout at this time. ■



The Amherst Railway Society Railroad Hobby Show

Our 2016 Show will be

January 30 & 31, 2016

Save the dates!

About The Show

Every year late in January or early in February, the Amherst Railway Society holds its Railroad Hobby Show at the Eastern States Exposition Fairgrounds (The home of The Big E) in West Springfield, Massachusetts. More than 25,000 railfans and public attended the Show each of the past three years.

The event features real life railroads and scale model railroads, historical societies, travel agencies, art shows, flea market dealers, importers, manufacturers and photographers. You have to see it to believe it!



**Click
to learn
more ...**

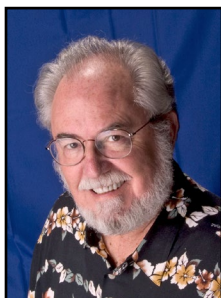

OCTOBER NEWS

column

RICHARD BALE *and* JEFF SHULTZ



[Click here for
reader comments](#)

Atlas acquires Weaver O Scale Tooling

Atlas Model Railroad Co. has purchased most of the tooling for O scale products previously manufactured by Weaver Models. According to Atlas CEO Paul Graf, the acquisition includes tooling for Weaver's 2-8-0, U25B, RS11 and VO-1000 locomotives. Also the troop sleeper and kitchen cars, the Pullman Bradley coaches, the war emergency gondola, the wagontop boxcar, and the class H30 covered hopper. Tooling for the popular telephone poles and 20-foot containers was included in the purchase. The announcement did not indicate when products from the newly acquired tooling might be available.

Working brakes in HO scale?

According to Shane Stoddard, working brakes and remote uncoupling will soon be available for HO models. Stoddard,

▶ THE LATEST MODEL RAILROAD PRODUCTS, NEWS & EVENTS

OCTOBER NEWS | 2

.....

the founder of Miniature Railway Foundries of West Bingham City, UT, is utilizing the micro-mechanics of watchmaking to develop functional brakes and remote uncoupling for trains as small as HO scale. Also under development are such miniaturized functions as working Gyalights that switch to red in emergency braking, fans on radiators and dynamic brakes that are controlled by grade, and control of exhaust from the cylinder cocks of steam locomotives. According to Stoddard, DCC is not needed but can be incorporated into the system if that is what a modeler wants. Stoddard, who has been sharing ideas with Kadee, indicated some amazing new items may be announced before the end of the year.

Personalized modeling workshop scheduled

Fos Scale Models has scheduled a hands-on workshop for November 7, 2015. The all-day event will be conducted by Doug Fos at his studio in Stonington, CT. Personalized instructions will cover weathering, achieving worn clapboard and peeled paint, and treating roofing, shingles and corrugated panels. Additional instructions will include techniques in the use of chinks and oils in weathering and rusting details and small parts. Attendance is limited. The \$225.00 fee includes a Fos kit valued at \$75.00. To register visit foslimited.com//index.php?main_page=index&cPath=15&zenid=9f87836633b3b02d686bec8a7e0f800c.

.....

NEW CLUB CARS



with the bold Guilford G on the side.



ping. To order visit ct-tmrr.org/clubcars.htm.

The **Torrington Area Model Railroaders** are selling a PS-2 twin-bay covered hopper car custom-decorated for Delaware & Hudson

Also available is a similar D&H PS-2 covered hopper except it has the D&H shield on the side. The HO scale models are \$25.00 each plus ship-

NEW PRODUCTS FOR ALL SCALES

Deepwoods Software has released version 2.1.36 of the program we reviewed in the February 2012 edition of MRH. The updated version of The Model Railroad System is a collection of software including utility programs and libraries to be used by other programs. Versions of it are available for both Windows and Linux systems, as is the source code. Updates in this version include support for the Raspberry Pi processor, updates to the communications libraries, GUI improvements, and additional CMRI support. The Model Railroad System can be downloaded at deepsoft.com/ModelRailroadSystem and more information can also be found on the program's Facebook page at facebook.com/ModelRailroadSystem.

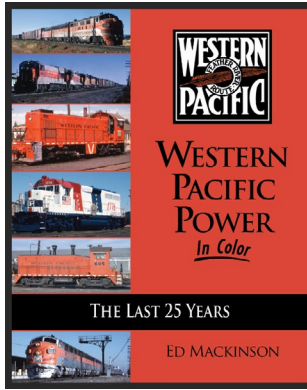
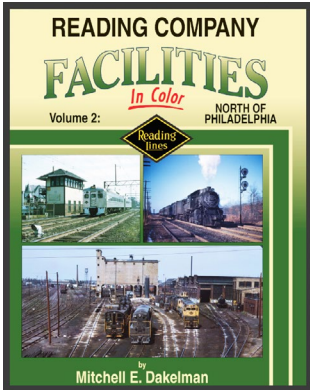

New hardcover books from **Morning Sun** include Reading Company Facilities, *Reading Company Facilities In Color Volume 2: North of Philadelphia* by

Mitchell E. Dakelman, and *Western Pacific Power* by Ed Mackinson. The Reading book pictorially reviews the stations, towers, maintenance shops and the many lines that emanated from Philadelphia, Reading, SEPTA, and Conrail. The WP book examines diesels of the Feather River Route on a unit-by-unit basis, showing both roster and action shots in color from the 1950s until the Union Pacific merger.

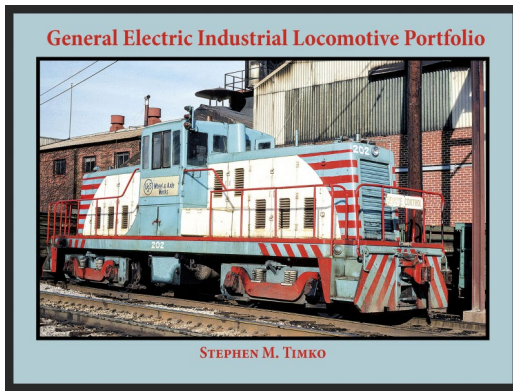
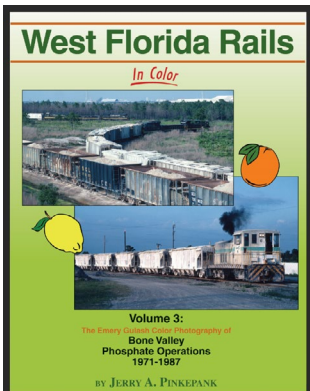

In *West Florida Rails*, diesel expert Jerry Pinkepank offers details on the motive power and phosphate operations in the Bone Valley of Florida from 1971-1987. Morning Sun's *General Electric Industrial Locomotive Portfolio* offers more than 350 color and black & white photos of GE's famed series of shortline and

OCTOBER NEWS | 5

.....

industrial-type locomotives. Author Stephen Timko covers the gamut of “tonner” locomotives including oddball, special-order units, off-center-cabs, drop-cabs, and SL-series units.

.....

Fifty-years of the *Narrow Gauge & Short Line Gazette* magazine are now available on DVD. The two-disk archive contains every page of the *Narrow Gauge & Short Line Gazette* from the first issue in 1975 through the end of 2014 for a total of 239 issues. Also included are complete collections of the magazine’s predecessors, *Finelines* (57 issues) and *Slim Gauge News* (18 issues). All issues and pages are fully searchable by title, author, keywords, and text entries. The disks are for use in a computer DVD drive. The two-disk DVD ROM set is available at \$139.95 plus shipping and handling. For more information including ordering instructions visit bobhayden.com/index.php?main_page=product_info&CPath=16&products_id=102.

.....

An online layout design tool called TRAX has been released by **Ngongo-B**. Usable with any modern HTML5-compliant Web browser, the plans are stored online, not on the computer on which they were created. This allows working on the plans anywhere Internet access and a compliant Web browser are available. Track plans can be private or collaborative, so multiple people all around the world can create a single track plan together. A novel feature of TRAX is that a photo can be set as a background to the trackplan and scaled to use as a guide.

TRAX includes templates for over 50 different track systems from Aristocraft G to Rokuhan Z. It also includes features to allow saving JPEG format images of the design, as well as a viewer application the user can embed in Web pages in the

OCTOBER NEWS | 6

same fashion that YouTube videos are. TRAX is free and can be accessed at traxeditor.com.

Railway Prototype Cyclopedia Volume 30 has been released by RP CYC Publishing Company. The 113-page periodical offers in-depth prototype information useful for serious modelers. Subjects in this issue include extensive reviews of WWII Emergency Composite GH/GS Gondola Cars and Part 3 of ACF-Design 1,958 cu. ft. Covered Hopper Cars. For additional information including ordering instructions, visit rpcycpub.com/ordinf.html.

O SCALE PRODUCT NEWS



Atlas O plans to release a new group of International NE-6 steel cabooses during the second quarter of 2016. Road names will be New Haven, Nickel Plate Road,

Susquehanna, Penn Central, Raritan River, and Norfolk & Western (3007300 series). The windows on the N&W caboose are set closer to the ends than on other road names. For comparison see this month's HO Atlas listing.

Also scheduled for release during the second quarter of next year is another run of O scale 50-foot PS-1 single-door boxcars. In addition to the D&RGW car shown here, road names will be

OCTOBER NEWS | 7



Richmond, Fredericksburg & Potomac; Conrail; Louisville & Nashville Family Lines; Rock

Island; and Santa Fe (3005700 series).



During the recent National Train Show in Portland, OR, Atlas O previewed several future products including a monster Gunderson Maxi-IV triple-unit container

car. The Master series model is planned for release during the second quarter of next year. Road names will be BNSF, BRAN, TTX, and Florida East Coast. New tooling is also being developed for 53-foot Jindo and CIMC containers.



Additional O scale models previewed at NTS included 48-foot containers, a California Zephyr dome car and a beautifully detailed heavyweight open-platform observation car.

OCTOBER NEWS | 8



All Atlas O equipment is available for either two-rail or three-rail operation. For additional information visit atlaso.com.



Rusty Rails has is selling a cast resin kit for a small O scale shack. The essential components of the easy-to-assemble kit are the one-piece building and two roof sections. The kit includes additional detail castings but not the figure shown in the illustration.

The completed shack has a footprint of three by two inches. For additional information, including painting suggestions, visit rustyrail.com/Simple%20Painting%20Instructions%20for%20the%20O%20Scale%20Shack.pdf.

HO SCALE PRODUCT NEWS

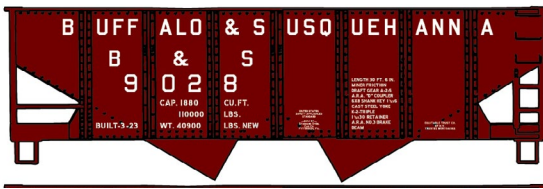

Buffalo & Susquehanna.

New HO scale kits released by **Accurail** include a three-car set of USRA twin-bay hopper cars decorated for

OCTOBER NEWS | 9



Also new from Accurail is an HO scale kit for a Detroit, Toledo & Ironton

50-foot steel boxcar equipped with a Superior door.



Accurail has issued a three-kit package of PS 4750 cu. ft. triple-bay covered hoppers decorated for Baltimore & Ohio, Chesapeake & Ohio, and Western Maryland.

In conjunction with Trainfest (West Allis WI, November 14-15, 2015) Accurail plans to issue HO scale kits for four Wisconsin-themed freight cars. The cars include a 40-foot double-sheathed wood box car, a 40-foot single-sheathed outside-braced wood boxcar stenciled for hide loading only, and a 70-ton triple-bay hopper car with offset sides, all decorated for Milwaukee Road. Completing the limited edition quartette is a Wisconsin Central PS 4750 cu. ft. covered hopper designated for grain service. All Accurail kits include appropriate trucks and Accumate couplers. For additional information contact your dealer or visit accurail.com.

Athearn's recently announced GP39-2 gained considerable attention at the National Train Show. The fact that two pre-production samples were decorated for the Portland & Western Railroad did not go unnoticed by local attendees. Production quantities of the Genesis series model are scheduled for release

OCTOBER NEWS | 10



next August. In addition to the P&W, road names will be Santa Fe, Delaware & Hudson, Burlington Northern, and Reading (item

40978-40981). DC versions of the model will be DCC-ready with Athearn's QuickPlug technology with both 8- and 9-pin plugs. DCC models will have factory-installed decoders with SoundTraxx Tsunami sound.



Athearn's August 2016 delivery schedule includes a new run of EMD SD45-2 diesels. Introduced by EMD in 1972, Santa Fe was the initial buyer with several orders for a total of 90 units. In addition to Santa Fe, Athearn will deliver the model decorated for Arizona & California, Maine Central-Pan Am, Montana Rail Link, and Trona Railway; all of which acquired their locomotives from Santa Fe. Also in the mix is a Conrail version which is a former EL unit. The Genesis series HO scale locomotive (item 86183-86199) will have the same DC/DCC options noted above for the GP39-2 model.

Additional Genesis series models introduced at the National Train Show included an F89F Bi-Level open auto rack car. Due next July, Athearn's HO scale version of the 89-foot 8-inch prototype features separately applied wire grab irons, wire-formed brake plumbing, and the distinctive "C" channel side sills. The

OCTOBER NEWS | 11



model rides on 70-ton roller bearing trucks with rotating bearing caps. A unique feature is the prototypically accurate undulating top safety railing. In addition to the Rock Island model shown here, road names will be Seaboard Air Line, Louisville & Nashville, Northern Pacific, and Southern Pacific. A car with partially enclosed sides will be available decorated for Southern.



Continuing its deference to the location of the National Train Show, Athearn has announced plans to issue an SD40 diesel locomotive decorated for Central Oregon

& Pacific Railroad. Known locally by its CORP reporting marks, the principal territory of the Class II railroad is the famed Siskiyou Line, the former mainline of the SP between Northern California and Eugene, Oregon. SP sold the line in late 1994 in favor of using a new route to Eugene via Klamath Falls. Athearn's HO scale locomotive represents a BNSF SD40 repainted in CORP livery. The Ready-to-Roll series model is scheduled for release in August 2016.

Athearn's July 2016 release schedule includes a group of five-bay rapid-discharge open hoppers with removable coal loads. The HO scale models will be sold individually as well as in two

OCTOBER NEWS | 12

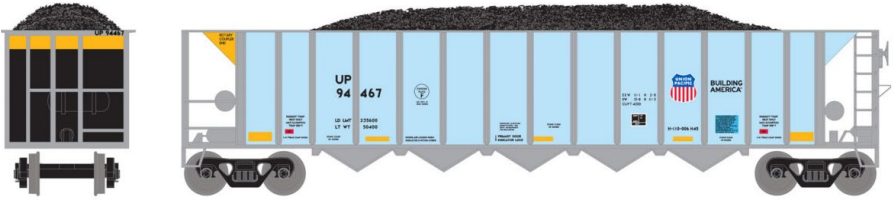

five-packs, all with different road numbers. Road names will be Union Pacific, CSUX-Colorado Springs Department of Public Utilities, Colorado & Wyoming, Southern Kansas & Oklahoma, Missouri Public Service Co., and Southern Railway (item 98332-349).



Also scheduled for release next July is a new run of 50-foot PS 5277 boxcars fitted with separate wire grab irons and the distinctive PS ribbed door. The HO scale Ready-to-Roll model will be available for Railbox, CN Railbox, Southern Railbox, BNSF, Chicago & North Western, and CSX (item 76336-353). The CN and Southern cars feature faded paint and patched reporting marks.

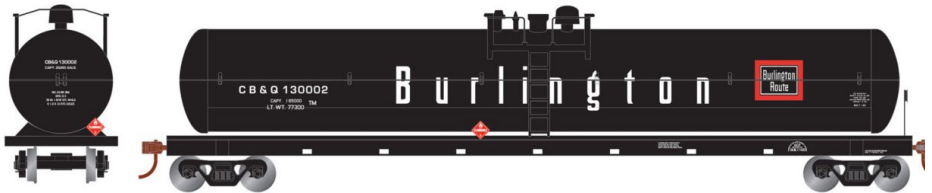

This 62-foot tank car is included on Athearn's July 2015 release schedule. In addition to this CB&Q version, decorating schemes

OCTOBER NEWS | 13

for this Ready-to-Roll HO scale model will be BNSF, General American Transportation, AC&F Leasing, Great Northern, and Ferrocarriles Nacionales de Mexico (76154-171).

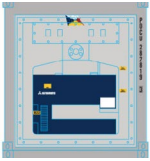

Three-packs of 20-foot reefer containers are set for release by Athearn next

July. Decorating schemes will be P&O, P&O/Nedlloyd, CMA/CGN, Columbus, K-Line, and OOCL (item 28801-06).

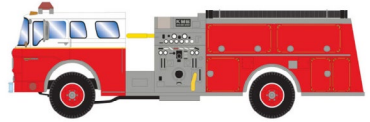

Athearn plans to produce a group of Ford C-series fire trucks for release next July. Ford built the medium-duty cab-over-engine truck between 1957 and 1990, a period of 33 years during which it was virtually unchanged. Athearn's HO scale version (item 92013-18) will be available in red, white, red with white roof, safety green (chartreuse), and red with a white cab (above).

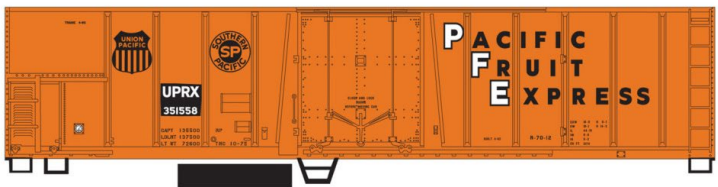

Athearn-Roundhouse models set for release next July include a 50-foot exterior-post mechanical reefer and a 40-foot 10-panel

OCTOBER NEWS | 14

steel gondola. The reefer (item RND 87854-71) will be decorated for Burlington Northern, Canadian Pacific (script), Santa Fe (with blue MTC door), Chicago North Western, PFE (dual SP-UP heralds), and Union Pacific-PFE (dual SP-UP heralds)



Road names on the Athearn-Roundhouse gondola (item RND 87836-53) will be C&O, Milwaukee Road, Pennsylvania, Chicago & North Western, Texas & Pacific, and Herzog as shown here. All models can be found at athearn.com.



Atlas Model Railroad Company is taking dealer reservations for another production run of its popular Alco RS-11 diesel locomotive. Delivery of the HO scale Master Series model

is planned for the third quarter of 2016. Road names will be Duluth, Winnipeg & Pacific; New Haven; Burlington Northern; Delaware & Hudson; Erie Mining; Winchester & Western; and Southern Pacific (10002132 series). The locomotive will be available for standard analog DC operation as well as with a factory-equipped DCC decoder with sound.

Atlas has scheduled the release of several new HO scale models during the second quarter of next year including a 50-foot

OCTOBER NEWS | 15

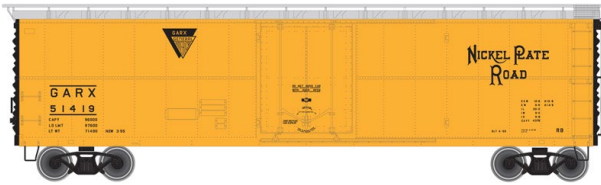

GARX steel refrigerator car. Road names will be Cotton Belt, Quanah Acme &

Pacific, Texas & Pacific, Union Pacific, Nickel Plate Road, and GARX (20003528 series). Spotting features of the 1950s-era car include a horizontal belt-line rivet strip and large panels flanking the 7-foot 7-inch door.



Also due for release in the second quarter of 2016 is another run of HO scale International NE-6 steel cabooses (20003597 series). Window location seen here on The Family Lines-CRR/SCL/L&N version will also be available on cars decorated for

Conrail, New Haven, Susquehanna, Penn Central, and Monongahela. The release includes a Norfolk & Western caboose with windows set closer to the ends. For comparison see this month's O scale listing.

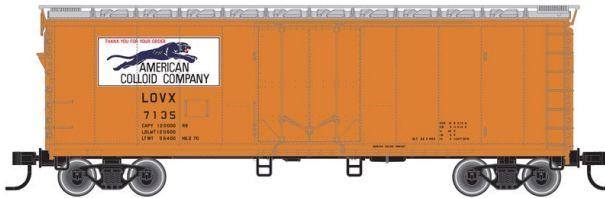

Atlas plans to release a Trainman series 40-foot plug-door boxcar in the second quarter of next year.

New paint schemes will be American Colloid (panther logo), American Colloid (volcano logo), WADX-American Refrigerator Transit, CP Rail, New York Central, and PRR-Fruit Growers Express. A rerun of the popular RBNX-Fruit Growers Express will be issued with new numbers (20003485 series).

OCTOBER NEWS | 16

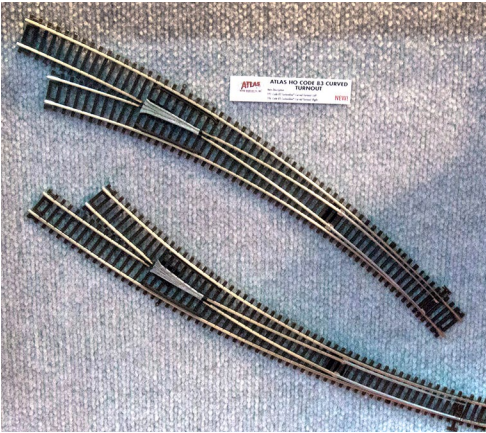

Atlas has announced plans to produce code 83 nickel silver curved turnouts. The HO turnouts have die-cast points and an isolated, die-cast frog with a power contact to optionally energize the frog and prevent momentary loss of contact when a powered model is passing through

the turnout. The outside radius of the curved turnout is listed at 30 inches; the inside radius is 22 inches. MSRP for the Atlas Custom Line Mark IV curved turnout is \$24.95. For additional information on Atlas products visit atlasrr.com.

.....

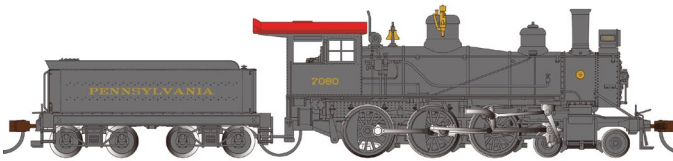

Bachmann Trains plans to reissue its HO scale 4-6-0 steam loco-

motive in December. The Baldwin Ten Wheeler, now fitted with 52-inch drivers, returns to Bachmann's lineup in a DCC sound-equipped version that includes the company's proprietary Sound Value package with SoundTraxx 16-bit polyphonic steam sounds including exhaust, short and long whistles, bell, air pump, steam release, and blower. The ready-to-run model has an MSRP of \$399.00. It will be available decorated for Pennsylvania Railroad, Union Pacific, Southern, Chesapeake & Ohio, and Santa Fe.

OCTOBER NEWS | 17

.....

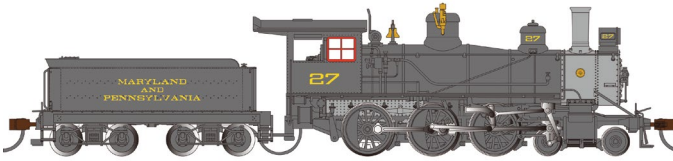

A DC analog version of the 4-6-0, with an MSRP of \$299.00, will

have an 8-pin socket ready for an aftermarket DCC decoder. In addition to Maryland & Pennsylvania (above) road names will be New York Central, Baltimore & Ohio, Canadian Pacific, and Texas & Pacific.



Also previewed at the National Train Show was an HO scale Alco S4 diesel locomotive. It is scheduled for release next month decorated for Chicago North

Western, and Pennsylvania Railroad (The NYC version shown is from a previous release). The model comes with Bachmann's DCC Sound Value system with SoundTraxx. The MSRP will be \$235.00. For additional information on Bachmann products contact your dealer or visit bachmanntrains.com.

.....



Broadway Limited has scheduled a February release date for this Milwaukee Road class S-3 4-8-4 steam

locomotive. Some details are yet to be applied to this engineering sample which features die cast metal frame and superstructure.

OCTOBER NEWS | 18

.....

BLI's HO scale Paragon3 model will have an MSRP of \$599.99. For additional information visit broadway-limited.com/paragon3milwaukee-34-8-4.aspx.



In other news from BLI, plans have been announced to produce a Type 27 6,000-gallon insulated high-pressure tank car based on a prototype manu-

factured by American Car & Foundry. Road names will be CILX-Canadian Industries, SACX-Columbia Southern, HOKX-Hooker Chemicals, TELX-Pennsylvania Salt, PPEX-Pittsburgh Plate Glass, VCSX-Virginia Chemicals, BCX-Brown Co., and NACX-Wyandotte Chemical. An undecorated model will also be offered. Delivery is planned for next spring. The HO scale ready-to-run models will be sold in 4-packs at an MSRP of \$129.99. For additional information visit broadway-limited.com/6000gallontankcar.aspx.

.....

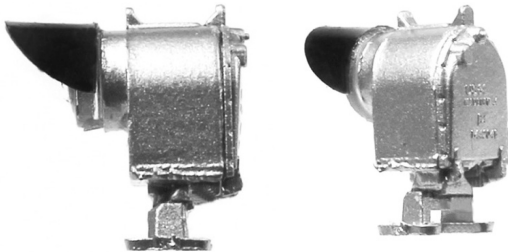

BLMA is selling Union Switch & Signal H-2 dwarf signal heads. The HO scale models are hand-assembled from brass and plastic components and are fitted with

three separate LEDs that vividly emit red, green, and yellow. The dwarf signal heads are sold in two-packs at an MSRP of \$24.95.

OCTOBER NEWS | 19

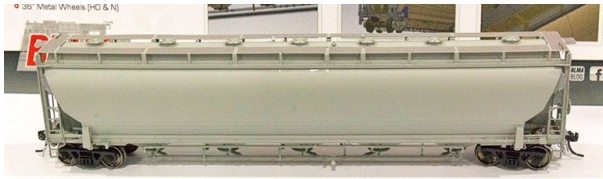

Here's an early look at BLMA's Trinity 5660 cu. ft. PD covered hopper that is scheduled for release

in mid-2016. As noted in our August report, the PD (pressure differential) car, which has five non-operating bays, is unloaded by pressurizing the interior and forcing the commodity out through a master discharge pipe connected to the bays. MRH's Jeff Shultz snapped this photo of a pre-production sample at the National Train Show. More information can be found at blma.com.

.....

Bowser Trains is taking reservations for a 40-foot boxcar and a class H-39 hopper for release next May. The ready-to-run HO scale models will have metal wheelsets and knuckle couplers.

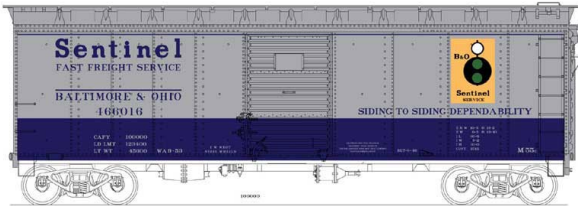

Shown here in B&O Sentinel livery, the single-door steel boxcar will also be available decorated for Wellsville,

Addison & Galetton; Arcade & Attica; Reading; Southern; Wabash; Western Pacific (orange feather); Santa Fe; Chesapeake & Ohio; and Great Northern. The MSRP will be \$24.95.



Road names for this 70-ton 12-panel triple-bay open hopper car will be

Pennsylvania (early class H-39 scheme), Canadian National, Norfolk Southern, Denver & Rio Grande Western, Pittsburgh & Lake Erie,

OCTOBER NEWS | 20

Erie Lackawanna, Conrail, Conrail (patch), Conrail (ex EL), Penn Central, and Conrail (PC patch). The MRSP will be \$23.95.



Bowser is working on four versions of a GMD SD40-2F for release late next year. The CP Rail variations will

be with porthole doors and sill dots (above), with sill dots and doors without portholes, without portholes with dashes on the sill, and with portholes and dual Canadian and American flags. Details included on the ready-to-run HO scale locomotives are air hoses, windshield wipers, grab irons, coupler lift bars, operating headlight, operating classification lights, window glass, can motor with a flywheel, nickel silver wheels, and knuckle couplers. DC analog versions will have a 21-pin plug for an aftermarket DCC decoder. A DCC/Sound version will be available with a LokSound Select decoder. For additional information on all Bowser products contact your dealer or visit bowser-trains.com.



Among the newest craftsman kits from **B.T.S.** is a structure identified as Fire Station No. 1. The HO scale kit consists of laser-cut basswood and plywood components. The footprint of the assembled structure is a scale 35 x 58 feet. The doors and windows are positionable. For additional information including ordering instructions visit btsrr.com/bts7235.htm.

OCTOBER NEWS | 21

According to B.T.S. owner Billy Wade, an O scale version of Fire Station No.1 is under development.

.....

Cannon & Co. offers key laser-cut components to modify other branded HO scale freight cars into specific prototypically accurate models not otherwise available.



Cannon kit 4011 includes sides and doors for building a PC&F Plate C boxcar with V-bar door (Great Northern

138000-138399, above). Cannon kit 5011 includes kit 4011 plus roof, ends and underframe. Other components such as ladders, grabs, brake fittings, draft gear, decals, couplers and trucks are not included.



Cannon kit 5020 was used to create this Northern Pacific boxcar with 6-foot and 8-foot combination doors. Using Cannon components, a skilled

craftsman can create unique museum-quality models. For additional information visit cannonandco.net.

.....

ExactRail has re-issued BNSF and Norfolk & Western versions of their 60-foot Pullman-Standard 7315 cu. ft. waffle-side boxcar. Underframe details on the HO scale model include all air

OCTOBER NEWS | 22



brake components with the connecting rods visible from the side (left).



Additional features of this highly detailed Platinum series model include wire grab irons, separately applied door tracks and door locking bars, and Kadee #58 couplers. The model rides on 100-ton ASF Ride Control trucks with 36-inch machined wheelsets. The car is also available as a kit. For additional information visit exactrail.com.



Fox Valley Models has released HO scale versions of an EMD GP60 diesel locomotive decorated for Southern Pacific, Cotton Belt, and Santa Fe. Three road numbers are available for each road.



The models are available for standard DC at an MSRP of \$199.95 and DCC with ESU LokSound on board at \$299.95. More information and availability can be found at fox-valleymodels.com.

OCTOBER NEWS | 23

InterMountain Railway plans to release a GP16 diesel locomotive next spring. The newly tooled HO scale model is based on a 1970s-era prototype EMD initially rebuilt from aging GP7s and GP9s for Seaboard. Road names for the HO scale ready-to-run model will be Seaboard System, L&N Family Lines System, R. J. Corman Co., The Indiana Railroad, CSX, Genesee & Wyoming-York, Pee Dee River, Louisville & Indiana, Everett Railroad, and U. S. Army. For additional information contact your dealer or visit intermountain-railway.com.

.....

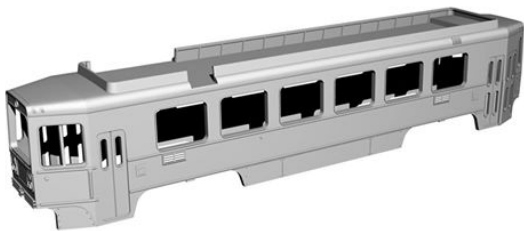

Here is a preview of a Kawasaki double-end Light Rail Vehicle coming soon from Imperial Hobby Products. The HO scale resin model will have injection-molded clear plastic windows. A 3D-printed underframe will be designed for a Bowser drive mechanism. Roof details will also be created by 3D printing and will accommodate a Sommerfeldt pantograph. For additional information visit ihphobby.tripod.com.

.....



Kadee Quality Products has released this HO scale ready-to-run DHPN 50-foot steel boxcar with a 10-foot sliding door.



Also available now is a Great Northern twin-bay covered hopper with eight round roof hatches.

OCTOBER NEWS | 24

.....



Next month Kadee plans to release its new insulated tank car decorated for SHPX-Texas Natural Gasoline Corp. This is the second road name for

the company's recently released HO scale version of the ACF 11,000-gallon prototype. Contact your dealer for additional information or visit kadee.com.

.....

Rexall DRUGS PRESCRIPTIONS

Miller Engineering has three new sequentially flashing electronic signs that are designed to mount flush to the wall of a building. They can also be readily adapted to a rooftop installation. In addition to Rexall as shown above, the new animated signs are for S&H Green Stamps and F. W. Woolworth Co.



For dimensional information as well as to see the signs in action visit microstru.com/Coming-soon.html.

.....



Here is a preview look at a **Moloco Scale Models** 50-foot General American Sill 1 RBL boxcar. The HO

scale model replicates the GA prototype with offset 10-foot

OCTOBER NEWS | 25

6-inch doors with narrow locking rods. Although similar in appearance to previous releases, this model is produced from all new body tooling. Features of the ready-to-run car include steel wire parts on the underframe, corner stirrups, Kadee couplers, Kadee running boards, and Moloco flexible air hoses made of real rubber. In announcing the new model, Nick Molo noted that some road names have different lettering on the ends and on each side. Multiple road numbers will be available for Chicago & North Western, Nickel Plate Road, WADX, MODX, and New York Central (with NYC doorstops). For more info visit molocotrains.com.



Monroe Models has introduced a kit for a 1920s-era gas station. Titled J. Burke Filling Station, the HO scale kit includes laser-cut components for the brick structure, gas pumps, sign posts, billboard, signage, fence, and driveway.

For additional information or to order visit monroemodels.us.



North American Railcar, a subsidiary of Pacific Western Rail Systems, operated several pre-production samples of its 4275 cu. ft. triple-bay potash service covered hopper cars at the recent National Train Show. The HO scale

OCTOBER NEWS | 26

models were decorated for both POTX-Potash Corporation and CEFX-Canpotex. For information on availability of the new models visit pwrs.ca/media.php.



Rapido Trains has announced plans to develop an HO scale 40-foot Northern Pacific 10000-series wood boxcar. The HO scale model will replicate one of the 4,000

prototypes built by Western Steel Foundry during the 1920s. Spotting features of the double-sheathed wood car include a radial roof, National sliding side doors, steel side sills, lever hand brake, and 7/8 Murphy ends fitted with a lumber door. As with all Rapido models, the car will have complete underbody details. The project, which is being coordinated with the Northern Pacific Railroad Historical Association, includes developing all-new U-channel trucks with in-line brake shoes.



The initial release of the ready-to-run model will include five versions:

1] 1923-38, no Monad, red ends and roof, K brakes; 2] 1940-44, 36-inch Monad, red ends and roof, AB brakes (above); 3] 1945-56, 36-inch Monad, black ends and roof, AB brakes; 4] 1951-56, large Monad, Mainstreet slogan, red ends and roof, AB brakes; and 5] 1956-82, company service, red ends and roof, AB brakes. An undecorated model will also be available. Reservations are being taken now with delivery expected late next year. For additional information contact a dealer or visit rapidotrains.com.

OCTOBER NEWS | 27



Rapido displayed some pre-production samples of their HO scale RDC cars at the National Train Show. The self-propelled car features full underbody

and interior details without any visible evidence of a motor and drive mechanism.

.....



Ring Engineering is selling HO scale End of Train Devices (EOTD) with a bright red flashing light in a choice of either orange or red enclosures. Additional options include either standard

or long wires and 33- or 36-inch wheels. The EOTD can be installed with no special wiring or modification to the freight car required. For additional information visit ringengineering.com/WhatsNew.htm.

.....



The newest item from Tangent Scale Models is an HO scale Pullman-Standard PS-3 70-ton triple-bay coal hopper.

Introduced in 1957, the prototype PS-3 proved exceptionally popular. To meet the demand, Pullman-Standard built the all-welded 2750 cu. ft. car at both its Bessemer, AL and Butler PA plants. At peak an average of 13 cars were completed per day.

OCTOBER NEWS | 28



Initial road names from Tangent include CRR-Clinchfield in the original FH8 scheme from 1958 and Louisville &

Nashville in the 1957 Dixie Line scheme. Between 1957 and 1961 L&N owned 8,150 of these cars. Additional road names include Utah Railway, Great Northern (1957 vermillion scheme with Rocky logo), and Rock Island. Each road name is available in multiple road numbers. A decal with additional numbers is included with each model. Road specific details include end heap shields, three different styles of door mechanisms, and several handbrake variations. Tangent ready-to-run models come with Kadee couplers. Assembled unlettered models are available in primer gray. An undecorated kit is also available.

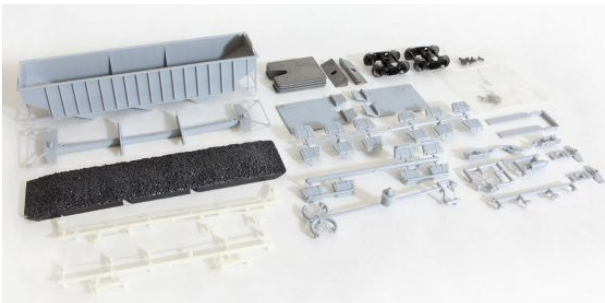

In other news from Tangent, the next production run of its highly rated General American three-compartment 6,000-gallon tank car has been

released. The multi-compartment design allowed consignees to receive up to three different grades of products, such as oils or chemicals. The HO scale models faithfully replicate the Type 30 prototype including the fully riveted tank and underframe.



Decorating schemes include STCX (Standard Tank Car Company, black lease scheme).

OCTOBER NEWS | 29

.....



Also PDAX with large Protex Industries on a black tank, as well as on each of the three domes.



A WCHX (Walter C. Haffner Company) decorating scheme on a general service car built in 1941 with a 1961 tank test date. Additional schemes include GATX

(General American Transportation) in black 1941 lease scheme, COSX (Mid-Continent Petroleum Company) with Cosden & Company Petroleum Products, Tulsa, Okla stenciled on the side of the tank, and GATX in the 1948 black lease scheme.

Features include separately applied tank handrail and strap detail, heater line and outlet drain details, AB brake components including air line, separate air hoses, road-specific brake wheels, and Kadee couplers. Black unlettered ready-to-run cars are available, along with undecorated kits. Tangent allows mixing for multiple-car discounts on quantity purchases. For additional information visit tangentscale-models.com.

.....

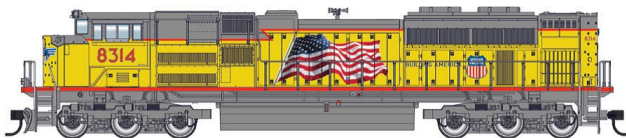

Walthers plans to deliver a new production run of its Mainline

series EMD SD70ACe locomotive next March. In addition to the UP Heritage unit shown here, road names will include BNSF (high headlight), Canadian National, Florida East Coast,

OCTOBER NEWS | 30

Chicago North Western, Denver & Rio Grande Western, and Southern Pacific. The HO scale model will be available for standard DC operation as well with factory-installed sound and DCC.

Walthers is developing new tooling for a Gunderson rebuilt 40-foot well car. The model should be ready for release by next February. Features of the Proto series model include etched-metal see-through walkways, heavy diecast metal frame, authentic body weld-line details, wire grab irons, and full brake gear. Road names on the initial release will be Northwestern Oklahoma Railroad, DTTX, and undecorated.



Also under development at Walthers is an HO scale Pennsylvania Railroad 80-foot P70fBR coach. The design includes modular tooling to insure lots of variations of the popular car. The prototype

was one of PRR's largest car classes, with more than 1,000 built between 1907 and 1929. Some continued in service into the mid-1970s. Walthers' initial release of four cars, set for next summer, will include P70 (as built), P70R (with ice air conditioning), P70fBR (clerestory roof, round restroom window, and mechanical air conditioning), and P70fBR (round roof, round restroom window, and mechanical air conditioning). The ready-to-run models will have factory-installed and painted stainless steel grab irons, operating sprung diaphragms, knuckle couplers, and Pennsylvania 2D-P5 roller bearing trucks with 36-inch metal wheelsets. Optional lighting will be available.

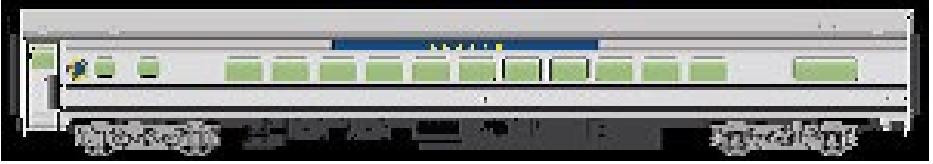

Walthers has shared computer renderings of three new HO scale Mainline series 85-foot modern Budd passenger cars it plans to release in January. First up is a small-window coach (item 910-30201 series) decorated for Amtrak, Santa Fe, Southern Pacific, Union Pacific, VIA, and Alaska Railroad.



A baggage-RPO (item 910-30301 series) car will be decorated for Santa Fe, Chicago Burlington & Quincy, New York Central, Pennsylvania Railroad, Southern Pacific, Union Pacific, VIA, Canadian Pacific, and Southern.



Concluding the January release of the new Budd models will be a round-end observation car (item 910-30351 series) decorated for Amtrak, Santa Fe, Chicago Burlington & Quincy, Canadian Pacific, New York Central, Pennsylvania Railroad, Southern Pacific, Union Pacific, VIA, Alaska Railroad, and Southern. A painted but unlettered car will be available for each body type.



Walthers also plans a January release date for an 89-foot channel-side flat car. Decorating schemes will be

Trailer Train (brown), Trailer Train (yellow), Trailer Train (twin 45), PTTX (pipe loading plain deck), KTTX Trailer Train (brown twin 45), and undecorated (item 910-5700-10 series). The Mainline series model will have an MSRP of \$27.98 each.



Walthers plans to release new Cornerstone series kits next month for a group of single-track through-girder train bridges. Kits will be available in 30-, 50-, 70-, and 90-foot lengths (item 933-4500 series). The HO scale kits can be assembled for either an open or ballasted deck. Additional detail items sold separately include single track abutments

and center piers. More information is available at walthers.com.

.....

N SCALE PRODUCT NEWS

Athearn will release a group of Ford C-series fire trucks next July. Ford built the medium-duty cab-over-engine truck between 1957 and 1990, a period of 33 years during which it was virtually unchanged. Athearn's N scale version (item 10273-78) will be

OCTOBER NEWS | 33

.....

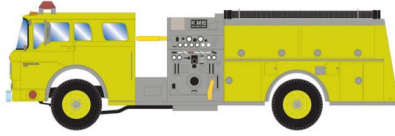

available decorated in red, white, red with white roof, red with a white cab, and safety green (above). More info can be found at athearn.com.

.....



Atlas Model Railroad Company is booking dealer reservations for another production release of its N scale Alco RS-11 diesel locomotive. Delivery is planned for the

second quarter of 2016. New road names will be Duluth, Winnipeg & Pacific; Toledo, Peoria & Western; Central Vermont; Delaware & Hudson; Pennsylvania Railroad; and Seaboard Air Line. Returning with new road numbers will be locomotives decorated for New Haven and Nickel Plate Road (40002600 series). The locomotive will be available for standard analog DC operation as well as with a factory-equipped DCC decodet (above), and undecorated.



Also due for release in the second quarter of 2016 is another production run of N scale International NE-6 steel cabooses (50002503 series). Window location seen on this Conrail version

will be available on cars decorated for CCR-The Family Line, New Haven, Penn Central, Susquehanna, and Monongahela

OCTOBER NEWS | 34

.....

Bicentennial. The release includes a Norfolk & Western caboose with windows set closer to the ends. For comparison see this month's O scale listing.

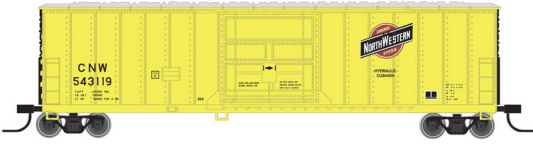

Chicago North Western car shown here, road names with new numbers will be Burlington Northern, Conrail, Conrail (Continuous Quality Improvement slogan), and Seaboard Coast Line (Solid Gold). New road names for this car will be B&O (Solid Gold), CSX (Solid Gold), Mountain Pine Lumber, and GARX (50001518 series).

Atlas' second quarter release includes a new production run of its N scale 50-foot FGE boxcars. In addition to the



Atlas N scale products scheduled for release early next year include a Trainman series 70-ton ore car. Road names will be Omaha, Lincoln & Beatrice; Bessemer & Lake Erie; Atlantic Coast Line (Bessemer patch); Chesapeake &

Ohio; Soo Line; and Chicago North Western (50002614 series). For additional information on Atlas products visit atlasrr.com.

.....

Bachmann has released N scale models of Pennsylvania Railroad's K4 steam locomotive – one of the more famous and recognizable 4-6-2 Pacific types of the steam era. Three versions of the iconic PRR locomotive are available, including a post-war model with modern pilot (two numbers), a pre-war version in Brunswick paint scheme with gold and red stripes, and a pre-war version with slat pilot (above). The ready-to-run model is

OCTOBER NEWS | 35

.....



available with DCC Sound Value SoundTraxx steam package that includes

16-bit polyphonic sound for chuff, short and long whistles, bell, air pump, steam release, and blower. The model is available now at an MSRP of \$399.99.



New N scale models scheduled for release next year include a 72-foot heavyweight coaches with interior lights and a GG-1, which will be

Bachmann's first N scale electric locomotive. Additional information is available at bachmantrains.com.

.....



BLMA displayed pre-production samples of a Trinity 31,000-gallon crude oil tank car at the National Train Show. The N scale ready-to-run model will be available late this year in 24 numbers, each

for DPRX (white tank with black belt) and TILX (all black).

Also shown at NTS was a pre-production sample of BLMA's N scale Trinity 5660 cu. ft. PD covered hopper that is scheduled for release in mid-2016. As noted in our August report, the PD (pressure differential) car, which has five non-operating bays, is

OCTOBER NEWS | 36

.....

unloaded by pressurizing the interior and forcing the commodity out through a master discharge pipe connected to the bays. For additional information contact a dealer or visit blmamodels.com.

.....



Bluford Shops is taking reservations for spring delivery of a newly tooled USRA 30-foot 6-inch twin-bay hopper car. The N

scale ready-to-run model will have operating knuckle couplers and appropriate trucks with Fox Valley metal wheelsets. Multiple road numbers will be available for Baltimore & Ohio, NYC-Big Four, Canadian National, Chesapeake & Ohio, Louisville & Nashville, Montour, New Haven, Pittsburgh & West Virginia, and Illinois Central. For additional information visit bluford-shops.com/bluford_93_031.htm.

.....



Here's a look at a Siemens-Amtrak ACS-64 Sprinter locomotive coming from

KatoUSA next month. Known as the “Amtrak Cities Sprinter,” the ACS-64 is Amtrak’s replacement for the aging AEM-7 and HHP-8 electrics currently in use in the Northeast and Keystone Corridors. Although based on European design, ACS-64 is a unique North America locomotive that is built entirely in the United States.

OCTOBER NEWS | 37

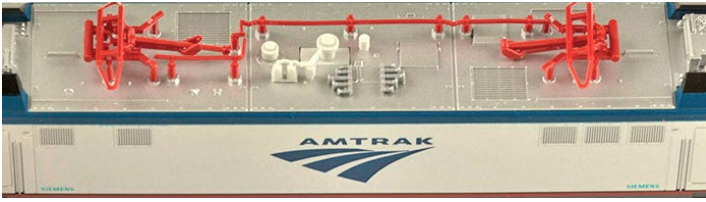

The prototype, which is powered through roof-mounted

high-speed pantographs (above), can pull as many as 18 Amfleet cars at speeds of up to 125 miles per hour.



Kato's initial release will be for a book-shelf presentation set consist-

ing of the ACS-64 locomotive, three Amfleet I coaches (above), and one Amfleet I café car. For additional information contact a dealer or visit katousa.com/N/ACS-64/index.html.



Micro-Trains Line has released several new N scale mod-

els including this 70-foot Santa Fe heavyweight RPO-baggage car. The car rides on six-wheel trucks.



New freight cars from Micro-Trains include an ART 40-foot wood reefer leased to Crazy Water Co.

OCTOBER NEWS | 38

.....



with steam and signal line gear to permit its use as an express car in passenger consists.



The Union Pacific eight-panel drop-bottom gondola shown here is available now from Micro-Trains.



The prototype of this Richmond, Fredericksburg & Potomac 40-foot boxcar was rebuilt in 1974. The update included removing the running board and shortening the right-hand side ladder. For additional information on all Micro-Trains Line models contact a dealer or visit micro-trainsline.com.

.....



Rapido Trains has added a 73-foot 6-inch baggage-express car to its N scale

Panorama line. Road names on the initial run will be Amtrak (Phase III), Baltimore & Ohio, Central of Georgia, Erie,

OCTOBER NEWS | 39

Milwaukee Road (1950 scheme), Missouri Pacific, Northern Pacific, Southern Pacific, Ontario Northland (green), and Burlington (shadowline scheme, above). A car decorated for BC Rail will be available exclusively through Pacific Western Rail Service.



Baggage-express cars with optional end doors will be available for Canadian National (1954 scheme), Great Northern, Penn Central, VIA Rail

Canada, and New York Central (two-tone gray, above). The N scale ready-to-run cars have an MSRP of \$54.95 in the US and \$59.95 in Canada. The order deadline is October 31st with delivery expected during the first quarter of next year. More information is available at rapidotrains.com/panbe.html.

Z SCALE PRODUCT NEWS



New and future models from **American Z** displayed at the National Train Show included a rough, yet impressive, pre-production test shot of an SD70ACe diesel locomotive.

Also shown was a brass caboose decorated for Santa Fe and a Procor molten sulfur tank car. For additional information visit americanzline.com.

NEW DECALS, SIGNS AND FINISHING PRODUCTS

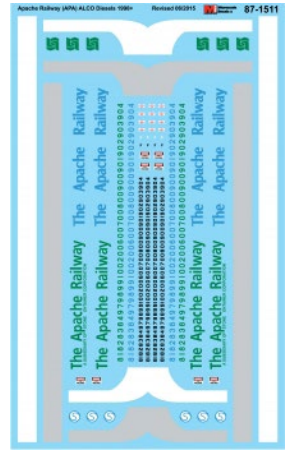

New decal lettering sets now available from **Microscale Industries** include Minneapolis & St. Louis (MStL) 40- and 50-foot boxcars, Chicago & Eastern Illinois 40- and 50-foot boxcars with Dixie and War Bond slogans, and Apache Railway Alco C420 and C424 diesel locomotives. Also new is a lettering set for early Pennsylvania Railroad freight cars.

Popular decal sets back in stock at Microscale include SP and SSW 83- and 89-foot flat cars and Fruehauf trailers, C&O and NH steam locomotives, BN and P&LE covered hoppers, UP passenger cars (yellow and gray scheme), PFE ice reefers, UP diesels and gas turbines (1947-1980), SP and SSW E-units and PA diesels (1950-1958), PRR pre-1948 steam locos in gold leaf, and NP passenger car stripes. For additional information contact your dealer or visit microscale.com.

Dan Kohlberg has released new HO decal sets for GATX black three-compartment tank cars 1941+ and Burlington

OCTOBER NEWS | 41

Northern PS-3 open hopper cars 1970+. For more information visit paducah@mindspring.com.

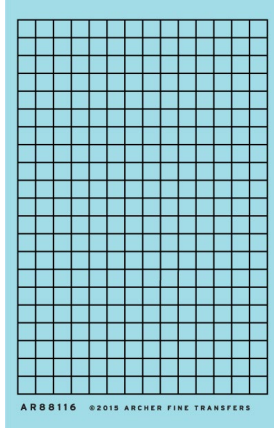
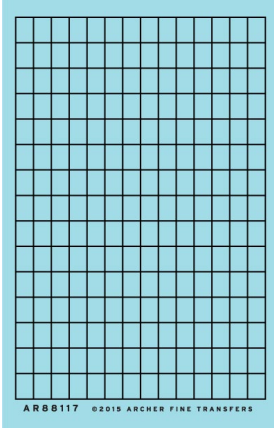

Archer Transfers has expanded its selection of surface details with the addition of factory windows with raised resin muntins applied to clear decal film. Sets are available in N, HO, S and

O scale. Both square and rectangular windows are available. For additional information visit archertransfers.com.

The Company Store of the Northern **Pacific Railway Historical Association** sells HO scale decals for Central Valley's NP stock and flat car kits. For additional information visit www1.storehost.com/stores/xq/xfm/store_id.615/Page_id.17/categ_id.1/parent_ids.0,0/qx/store.htm.

Mount Vernon Shops has released two new HO scale decal sets of interest to Pennsy modelers. The sets include PRR shadow keystone lettering for class GLa hoppers. This set has sufficient material to letter up to six cars, including system-wide reweigh locations. The second new lettering set has the same material for a class H21 hopper. For additional details including ordering information visit mountvernonshops.com.

i SEND US YOUR PRODUCT ANNOUNCEMENTS

If you are a hobby manufacturer with a product announcement, just [click here](#) and submit your announcement to us. Our website and free magazine reach continues to grow, so get on board this new media train! ■
.....

DISCLAIMER

The opinions expressed in this column are those of the writer and do not necessarily reflect the opinion of *Model Railroad Hobbyist* or its sponsors. Every effort is made to provide our readers with accurate and responsible news and information, however, neither *Model Railroad Hobbyist* or the writer of this column can be held responsible for any inaccuracies or typographical errors that may inadvertently appear in this column.



**Click here for
reader comments**



THIS MONTH'S BONUS EXTRAS

MRH SUBSCRIBERS GET ACCESS TO FREE BONUS extras, but you do have to be a subscriber! That's easy because [subscribing is free \(just click this link\)](#).

The bonus extras this month include:

- High quality versions of the issue videos
- Special eBook "Big-Boy" addendum to What's Next column
- Updated DCC Shortcuts card

To access the bonus extras, click the link below:

[BONUS DOWNLOADS FOR THIS ISSUE](#)
.....

ADVERTISEMENT

END OF TRAIN DEVICE

FLASH CIRCUIT
UNDER TRUCK

TRACK
POWERED



READY TO RUN!



**Bright Red
Flashing Light!**

Installs in minutes
with no freight car
modification required!

RE RING[™]
ENGINEERING

Patented Technology - US Patent 7,549,609

Does not affect Load!

↓ Car without Load ↓

↓ Car with Load ↓



For video
and more
click here!



BRIEFLY NOTED AT PRESS TIME ...

BLMA has shipped to customers all pre-orders for its latest run of both HO & N scale Santa Fe Bx-166 60-foot double-door box-cars. Coming next is another production run of BLMA's 64-foot Tropicana reefers with 24 new road numbers. Both HO and N scale models will be produced. blmamodels.com/blog.

Kadee has introduced HO scale cabooses with electrical pickup and a single pigtail lead. Solid-bearing arch bar and Bettendorf-style trucks are available. kadee.com.

An in-depth preview of **KatoUSA's** new N scale ACS-64 and Amfleet I Coach-Café car is available at youtube.com/watch?v=Wsooiwc1E2I&feature=youtu.be. The models are scheduled for release next month.

Rapido Trains has extended the order deadline for its N scale FL9 to October 15, 2015. Delivery is planned for January 2016. For more info visit rapidotrains.com/fl9_n.html.

Tangent Scale Models is selling unassembled kits for six different versions of its HO scale PRR X58 Sam Rea Shops boxcar. For more details visit tangentscalemodels.com.

Westerfield Models has moved to P.O. Box 455, Gardenville, NV 89410. The phone number, email and website remain the same at 303-658-9343, westerfieldmodels@gmail.com, and westerfieldmodels.com. In other news, Westerfield has re-released its No. 5760 series flat kits for PRR class GLA 30-foot twin-bay hopper cars. The kits follow prototypes modernized with AB

OCTOBER NEWS | 45

brakes. Although Westerfield kits do not include trucks, Tahoe Model Works trucks are now available from Westerfield. Three different versions of Tahoe plain bearing trucks (frame only, with RP25 wheelsets, or with semi-scale .088-inch tread wheelsets) are available. ■

.....

ADVERTISEMENT

2015 Texas Western Train Show



Click here to get
\$1 Off your Admission to the
2015 Texas Western Train Show

MRHMAG.COM

HobbyOn

Come & See Us
[CLICK Here](#)



www.hobby-on.com

**Name Brand
Hobby
Products
at Discount
Prices!**

- [TABLE OF CONTENTS](#)
- [INDEX](#)



SELECTED EVENTS

October 2015

(Please note that many events charge a fee. Check individual info website for details.)

CANADA, ONTARIO, ST. CATHARINES, October 25, Niagara Model Railway Show sponsored by Niagara Railway Museum, at Merritton Community Centre, 7 Park Avenue. Info at nfrm.ca/nfmrs.php.

– CANCELLED – CANADA, QUEBEC, LAVAL, Oct 3-4, The North Shore Train Show, Complexe Multi-Sports, 955 ave Bois-de-Boulogne. Info at salondutrainrivenord.org/english.html.

CALIFORNIA, SAN PEDRO, October 24-25, Open House & Swap Meet, at Belmont Shore Model Railroad Club, 3601 South Gaffey Street. Event includes 3D-printing clinic. Info at belmont-shorerr.com.

FLORIDA, PALATKA, October 10, Railfest 2015 Train Show sponsored by Ocala Model Railroaders' Historic Preservation Society at Price-Martin Center & Palatka's Historic Union Station. Info at railsofpalatka.org/rail-fest-2015.html.

FLORIDA, DEERFIELD BEACH, October 17, Model Train Swap Meet, sponsored by the South Florida Railway Museum and Model Railroad Club, at Westside Park Recreation Center. Info at sfrm.org.

SELECTED EVENTS | 2

FLORIDA, JACKSONVILLE, October 22-25, Gateway to Florida, NMRA Sunshine Region Convention, at Jacksonville Marriott, 4670 Salisbury Road. Info at sunshineregion.org.

ILLINOIS, ST. CHARLES, October 18, 24th Annual Chicago Railroadiana & Model Train Show, at Front Building, Kane County Fairgrounds, 525 S. Randall Road. Info at rrshows.com.

ILLINOIS, LISLE (Naperville), October 22-24, 22nd Annual Naperville RPM Conference, hosted by Joe D'Elia, at Sheraton Lisle-Chicago Hotel, 3000 Warrenville Road. Info at railroadprototypemodelers.org/naper_meet.htm.

INDIANA, FORT WAYNE, October 29-November 1, Fort Wayne Rails 2015, NMRA North Central Region annual convention, hosted by NCR Division 3, at Hotel Fort Wayne, 305 East Washington Center Road. Info at fortwaynerails2015.ncr-nmra.org.

MARYLAND TIMONIUM, October 24-25, The Great Scale Model Train & Railroad Collectors Show, Cow Palace at Maryland State Fair, 2200 York Road. Info at gsmts.com.

MASSACHUSETTS, WAKEFIELD, October 10-11, 35th Annual Train Show, presented by North Shore Model Railroad Club, at Americal Civic Center. Info at nsmrc.org/show.html.

MISSOURI, KIRKWOOD, October 10-11, The 25th Annual Greater St. Louis Metro Area Train Show sponsored by Mississippi Valley N Scalers, at Kirkwood Community Center, 111 South Geyer Road. Info at mvns.railfan.net.

NEW HAMPSHIRE, GREENFIELD, October, 17, Railroad Show, at Greenfield Historical Society, 828 Forest Road. Info from Dale Russell at dkrussell2@myfairpoint.net.

SELECTED EVENTS | 3

NEW JERSEY, MOUNT LAUREL, October 22-25, The Delaware Valley Turn, NMRA New Jersey Division, Mid-Eastern Region Convention, at Hotel ML, 915 Route 73. Info at delaware-valleyturn.org.

NEW MEXICO, SANTA FE, October 7-13, 18th Annual Santa Fe Model Railroad Show & Circus Modelers Convention, at Santa Fe County Fair Grounds. Info at santafemodelrailroad-club.org.

NORTH CAROLINA, FLETCHER, October 9-10, Autumn Rails 2015 – All Scales Model Railroad Show, presented by French Broad e’N’pire NTrak Club, at WNC Ag Center Expo Building. Info at fdr-ntrak.com/train-show.

OHIO, WEST CHESTER, October 10, NMRA Mid-Central Region, Cincinnati Division 48th Annual Model Railroad Show at Lakota West High School, 8940 Union Centre Blvd. Info at cincy-div7.org/events.html. For table rental information contact Roy Hord at (513) 777-5337 or rhord@fuse.net.

TEXAS, FOREST HILLS, October 10-11, Texas Western Model Train Show, presented by the Texas Western Model Railroad Club, at Forest Hill Civic Center, 6901 Wichita Street. Info at twmrc.org.

TEXAS, FORTH WORTH, October 16-17, Southwest O scale Meet, at Forth Worth Academy, 7301 Dutch Branch Road. Info at oscalesw.com.

WISCONSIN, EAU CLAIRE, October 10-11, 14th Annual Train Show at Eau Claire Indoor Sport Center, 3456 Craig Road, sponsored by West Wisconsin Railroad Club. Info at trainweb.org/imrc/TrainShow.

November 2015

ARIZONA, TUCSON, November 13-14, Fall Train Show & Meet, at Tucson Expo Center, 3750 East Irvington Road, sponsored by Gadsden Pacific Division Toy Train Operating Museum. Info at gpdtoytrainmuseum.com/annual_fall_show.htm.

CALIFORNIA, SACRAMENTO, November 14-15, Open House during Railfair (Roseville) at Sacramento Model Railroad Historical Society, 1990 Grand Avenue. Info at smrhs.com.

MICHIGAN, LANSING, November 15, Annual Model Train Show & Sale sponsored by the Lansing Model Railroad Club Michigan State University, Pavilion, 4301 Farm Lane. Info at lmrc.org/trainshow/index.shtml.

MISSOURI, SEDALIA, November 7, Third Annual Sedalia Rails Train Show, Liberty Park Convention Center. Info from Ken Bird at klbird@embarqmail.com.

OHIO, DAYTON, November 7-8, 40th Annual Dayton Train Show, at Hara Arena, 1001 Shiloh Road. Info at daytontrain-show.com.

WASHINGTON, KENT, November 14, Annual Swap Meet, sponsored by Boeing Employees Model Railroad Club. Event at 525 4th Ave. North. info at swapmeet@bemrrc.com or contact Ed Sherry at 206-244-3884. Also info at bemrrc.com.

WISCONSIN, WEST ALLIS (Milwaukee), November 14-15, Trainfest, Wisconsin Exposition Center at Wisconsin State Fair Park. Info at trainfest.com.

Future 2015 (by location)

COLORADO, LONGMONT, December 11-13, 38th Annual Model Railroad Expo, at Boulder County Fairgrounds, Hover & Nelson Roads, sponsored by Boulder Model Railroad Club. Info at bouldermodelrailroadclub.org.

MARYLAND, CHESTER, December 5-6 and 12-13, Festival of Trains at Old Kent Narrows Outlet Stores, hosted by Queen Anne Railroad Society and the Museum of Eastern Shore Life. Info at qarrs.org.

MASSACHUSETTS, MARLBOROUGH, December 5-6, 2015, Annual New England Model Train Expo, at Best Western Royal Plaza Trade Center, 181 Boston Post Road (US Rte. 20), hosted by NMRA HUB Division. info at hubdiv.org.

OHIO, SPRINGFIELD, December 6, Model Train Show at Clark County Fairground. More info: Bob Chafin (937) 399-6647.

Future 2016 and beyond (by location)

CANADA, BRITISH COLUMBIA, SALMON ARM, June 15-19, 2016, Selkirk Express, NMRA Pacific Northwest Region Annual Convention and Train Show. Info at selkirkexpress2016.ca.

COLORADO, DENVER, 2017, National Narrow Gauge Convention.

ILLINOIS, CHICAGO, October 1-2, 2016, Brass Expo, a juried show limited to pre-submitted items including brass models and items relevant to brass models. At The Westin Hotel (Chicago North Shore), 601 N. Milwaukee Ave. Wheeling, IL 60090. Info at brassexpo.com.

SELECTED EVENTS | 6

INDIANA, INDIANAPOLIS, July 3-10, 2016, NMRA National Convention and National Train Show. Info at nmra2016.org.

MAINE, AUGUSTA, Sept. 7-10, 2016, 36th National Narrow Gauge Convention. Info at nngc2016.org.

MASSACHUSETTS, WEST SPRINGFIELD, January 30-31, 2016 Railroad Hobby Show, sponsored by Amherst Railway Society, at Eastern States Exposition Fairgrounds, 1305 Memorial Avenue. Info at railroadhobbyshow.com. ■



**Click here for
reader comments**

ADVERTISEMENT



**Your Local N Scale
Online Hobby Shop**

**575-523-9743
fiferhobby.com**

MRHMAG.COM

- [TABLE OF CONTENTS](#)
- [INDEX](#)

Clickable advertiser index – 1

[Accu-Lites](#)

[American Ltd \(San Juan\)](#)

[Amherst Railway Society](#)

[ANE Models](#)

[Archer Fine Transfers](#)

[Athearn](#)

[Atlas Model Railroad Co.](#)

[Bachmann](#)

[Bachrus](#)

[Backdrop Junction](#)

[Berrett Hill Trains](#)

[Black Cat Publishing](#)

[Blair Line](#)

[BLMA](#)

[Bowser](#)

[Caboose Hobbies](#)

[Canadian Railway Modeller](#)

[Canyon Creek Scenics](#)

[Clever Models](#)

[Coastmans Scenic Products](#)

[Coffman Graphics](#)

[Con-Cor](#)

[Credit Valley Railway Co.](#)

[Digitrax \(2 page spread\)](#)

[East Penn Traction Club](#)

[e-Auction-Club.com](#)

[ESU LokSound](#)

[Fast Tracks](#)

[Fifer Hobby Supply](#)

[Fox Valley Models](#)

[George's Trains](#)

[GLX Scale Models](#)

[Great Decals](#)

[Hobby-On \(MRS Hobby\)](#)

[HO Diesel Supply](#)

[Iowa Scaled Engineering](#)

[Iwata-Medea](#)

[Jelsma Graphics](#)

[Ken Patterson](#)

[Lights 4 Models](#)

[Litchfield Station](#)

[Logic Rail Technologies](#)

[Microscale](#)

[Model Railroad Benchwork \(1\)](#)

[Model Railroad Benchwork \(2\)](#)

[Model Tech Studios](#)

[Motrak Models](#)

[Mountain Subdivision Hobbies](#)

[MRH Store \(Model Trains Video\) \(1\)](#)

[MRH Store \(Model Trains Video\) \(2\)](#)

[MRH Store \(Model Trains Video\) \(3\)](#)

[MRH Store \(Model Trains Video\) \(4\)](#)

[Nano-Oil](#)

[NCE \(2 page spread\)](#)

[Nick & Nora Design](#)

[North American Railcar](#)

[Pre-Size Model Specialities](#)

[Precision Design Co.](#)

[Railmaster Hobbies](#)

[Railroad Explorer](#)

[Rapido \(1\)](#)

[Rapido \(2\)](#)

[Ring Engineering \(1\)](#)

[Ring Engineering \(2\)](#)

Clickable advertiser index – 2

[Rulers-of-the-World](#)

[Rusty Stumps](#)

[Scotty Mason Show](#)

[Soundtraxx \(Blackstone\)](#)

[Southern Digital](#)

[Streamlined Backshop](#)

[TAM Valley Depot](#)

[Texas Western Train Show](#)

[Tony's Train Exchange](#)

[Trainfest](#)

[TrainMasters TV \(1\)](#)

[TrainMasters TV \(2\)](#)

[Traintek](#)

[True Scene Modeling](#)

[Vector Cut](#)

[Westerfield Models](#)

[Yankee Dabbler](#)

[Yarmouth Model Works](#)

Clickable “other” index

[Other – Bonus Extras](#)

[Other – Cover](#)

[Other – Derailments](#)

[Other – Hobby Marketplace](#)

[Other – MRH Sponsors](#)

[Other – Staff Notes](#)

[Other – Table of Contents](#)

DOWNLOAD ISSUE



DOWNLOAD PORTRAIT



DOWNLOAD LANDSCAPE



REVERSE RUNNING

commentary

JOE FUGATE
.....



[Click here for reader comments](#)

RUINING THE VIEW WITH A MASTERPIECE



GRAFFITI ON RAILROAD

equipment – it’s a divisive topic. Everyone seems to have an opinion, and when modelers express their often bi-polar opinions about graffiti in online forums, the fur starts to fly.

Some feel we need to appreciate the artistic genius that’s in a lot of graffiti, especially in the best of the graffiti art. Others quickly

counter that there’s no such thing as “good” graffiti – it’s all vandalism and destruction of property, and should never be condoned or appreciated.

▶ STEPPING OUTSIDE THE BOX WITH A CONTRARY VIEW

To me (speaking as a railfan and railroad modeler), a good analogy for graffiti on railcars is like someone sticking the Mona Lisa in my face while I'm trying to take in a scenic vista. Sure, the Mona Lisa is a masterpiece. But the context is all wrong – I am trying to enjoy the scenery and you're blocking the view!

Yes, the Mona Lisa is still a masterpiece, but by blocking my view with a masterpiece, you're not doing justice to the masterpiece! In short, you're just annoying me and doing a great injustice to both the masterpiece and the wonderful view.

That's what railroad graffiti is like to me. I won't discount that some graffiti is masterfully done. But you've ruined my view of the railroad car as a railfan and modeler. As a result, what might otherwise be a wonderful work of art in the right context is now just blocking my unhindered enjoyment of the railroad equipment. You've ruined both the amazing artistic genius of the graffiti and the delight of railfanning.

Oh, I can see what they're thinking – paint your masterpiece on railroad equipment and have it tour the country! But that's getting something by robbing someone else, which should not be an act a civilized society condones. If you want your great artwork to go on tour, then *earn it* through legitimate means.

It's unfortunate that the talented graffiti artists chose such a poor context for their best work. Rather than use a legitimate canvas so we can forever enjoy their work like we can the Mona Lisa, they use a canvas that will sooner or later be sandblasted and painted over, to be lost forever to posterity. Talk about a shame.

Like it or not, graffiti is reckless damage to railroad equipment, which impacts us all. The more maintenance costs on railroad equipment, the more shipping rates increase. And for railroads, that's shipping rates on everything from lettuce to automobiles.

I'll never ruin the view on my layout with a graffiti masterpiece.



DERAILMENTS



UPSIDE DOWN TRAIN LAYOUT

That's right, it's an upside down train layout, with actual running trains you can put on and take off the track!

This was submitted by Bill Brillinger, who first saw it on the Model Rail Radio Facebook page.



[Click here for reader comments](#)

► BIZARRE FACTS AND HUMOR (SUPPOSEDLY)



Oh, really?

.....

GET PAID ...

If you're the first to submit a bit of good humor or bizarre facts and we use it, it's worth \$25! Just send to derailments@mrhmag.com ■

.....

Coming next issue ...

- Gary Christensen's amazing Caldwell Blvd. diorama
- Geoff Bunza builds working cranes
- Make a DCC test track
- Modeling Piepul's Camera Store
- More SP passenger car modeling
- And lots more ...



MRHMAG.COM

- [TABLE OF CONTENTS](#)
- [INDEX](#)