

HAVING FUN WITH TRAINS

SEPTEMBER 2015 | FREE

MRH

MODEL RAILROAD HOBBYIST

ALSO:

- Adding fall color
- Car prep for operations
- Building a backdrop
- Easier wheel cleaning
- DCC throttles comparison

... and lots more inside!

**Bob Rivard
weathers**

**A 35-year old
Alco**

» READ NOW

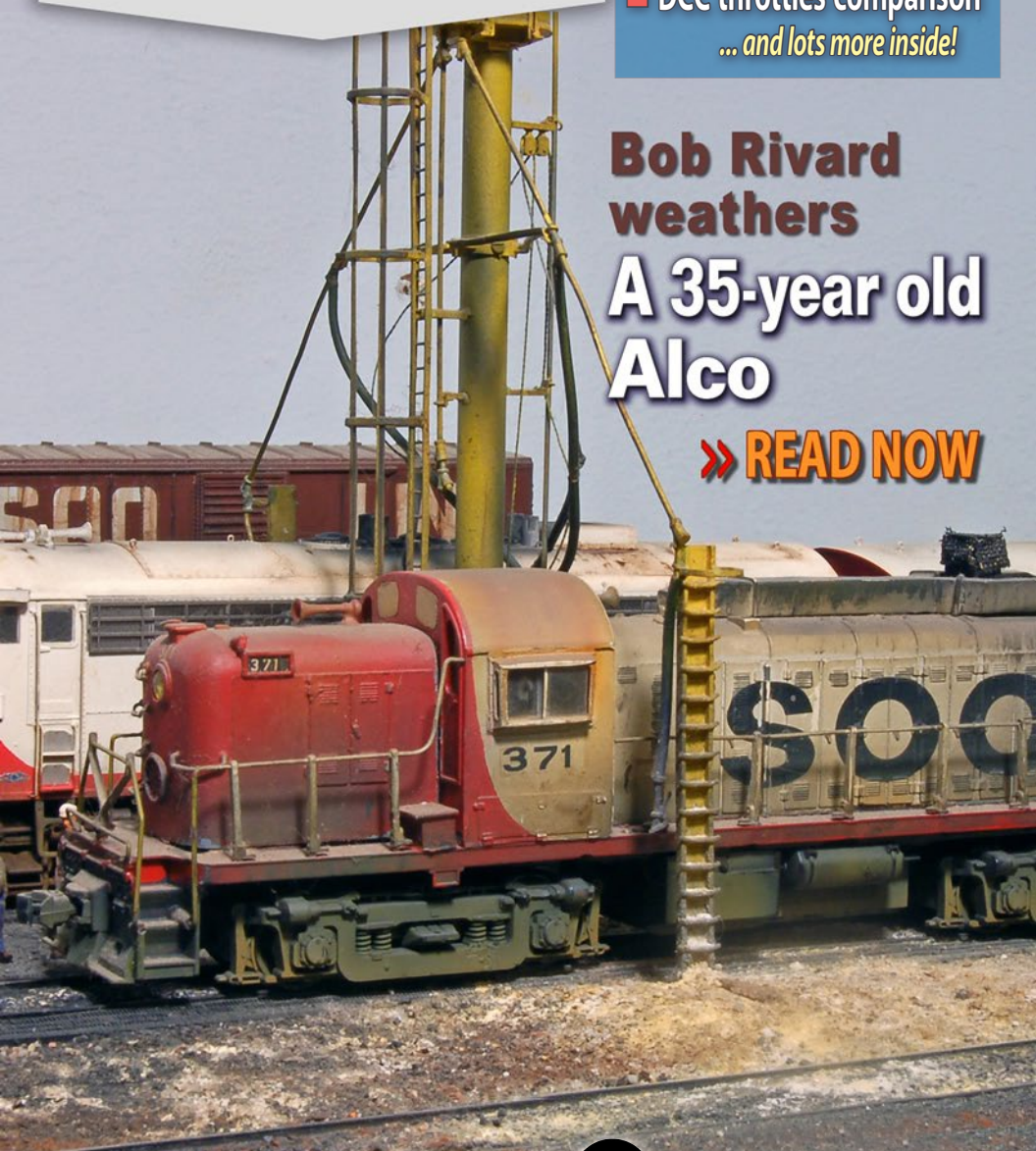

STANDARD EDITION | PORTRAIT



DOWNLOAD



BLMA MODELS

NEW TOOLING
TRINITY 5660
-PD-

FLOUR POWER

COVERED HOPPER

HO & N SCALE
ORDER ALL 24 NUMBERS TODAY!

The **5660 Pressure Differential (PD) Covered Hopper** was first introduced in 1999, by Thrall Industries, as the latest advancement in the evolution of Pressure Differential Covered Hoppers. Production continues today under the TrinityRail brand, with nearly 4,000 cars already in service. These specialized PD covered hoppers are notably different from traditional "gravity discharge" covered hoppers in both form and function. Designed to transport powdery commodities such as flour and talc, the 5660 PD Covered Hopper features five non-opening bays connected by a master pipe. The cars are unloaded by pressurizing the interior of the car with air, thus blowing the commodity out. An icon of today's railroading, the Trinity 5660 PD Covered Hopper is perfect for your modern layout! **Coming in HO & N**, collect all 24 numbers by ordering now through your favorite dealer or direct!

ORDER BY : SEPT. 15TH
DELIVERY BY: Q2 2016
BLMAmodels.com
**BLMA
BLOG**

**You
Tube**
MRHMAG.COM

- TABLE OF CONTENTS
- INDEX



STAFF CREDITS

Front cover: Bob Rivard takes one of his older model locos and re-does the weathering to his current standards. Follow along on this unique project!



ISSN 2152-7423

Editorial Staff

Joe D. Fugate, Publisher and Editor

Don Hanley, Assistant Editor

Production

Patty Fugate, pasteup and layout

Joe Brugger, copy editing

Mike Dodd, copy editing

Technical Assistants

Jeff Shultz

Jimmy Simmons

Advertising

Les Halmos, Account Manager

Daniel Nava, Advertising Assistant

Jean-François Delisle, Marketing Assistant

Columnists

Richard Bale, News and events

Jeff Shultz, News and events

Les Halmos, Modular railroading

Larry Smith, Narrow Gauge/Shortlines

Bruce Petrarca, DCC

Ken Patterson, Reporter at large

Special Correspondents

Joe Brugger, Questions & answers

Charlie Comstock, Contributing editor

Issue password: Sep2015

Published for the glory of God. [What's this?](#)



MRH SPONSORS

A - E



acculites.com



americanlimitedmodels.com



railroadhobbyshow.com



anemodel.com



archertransfers.com



athearn.com

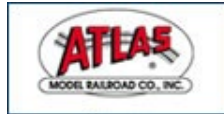

www.atlasrr.com



bachmanntrains.com



bachrus.com



backdropjunction.com

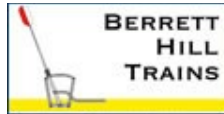

berrethill.com/trains



blairline.com



blmamodels.com



bowser-trains.com



caboosehobbies.com



coffmaneng.com



cvrco.com



www.digitrax.com



esu.eu/en

[Vendors: Get your clickable logo here ...](#)

MRH SPONSORS | 2

F - R



www.handlaidtrack.com



fiferhobby.com



foxvalleymodels.com



glxscalemodels.com

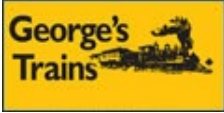

georgestrains.com



www.hobby-on.com



www.iascaled.com



iwata-medea.com



litchfieldstation.com



mapleleaftrains.com



micromark.com



microscale.com



model-trains-video.com



modeltechstudios.com



stores.ebay.com/Motrak-Models



mthtrains.com



nano-oil.com/Model%20Railroad.html



ngc-2015.com



ncedcc.com



nickandnoradesigns.com



www.pwrs.ca/main.php



railmasterhobbies.com



rapidotrains.com



ringengineering.com



rr-cirkits.com



rslaserkits.com



rustystumps.com

[Vendors: Get your clickable logo here ...](#)

MRH SPONSORS | 3

S - Z



sanjuancarco.com



scenicexpress.com



signaturepress.com



soundtraxx.com



sodigi.com

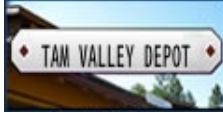

tamvalleydepot.com



tonystrains.com



trainfest.com



traintekllc.com



walthers.com

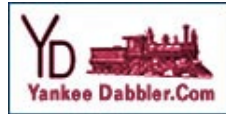

yankeedabblers.com

[Vendors: Get your clickable logo here ...](#)

Looking for something? Check our Hobby Marketplace!

The screenshot shows a grid of advertisements for hobby-related products. Key items include:

- Model Railroad Hobbyist | June 2015 | #64**
- HOBBY MARKETPLACE** with a "Mr. Detail Parts" ad for bulk packs and bundles.
- PARAVISION PRODUCTS** for plastic model parts.
- Trees** by Coastmans.com, featuring "SUGAR COBE" SPEAKERS and "Sweet" Speaker Options.
- CLAYBR** model boats.
- Yarmouth Model Works** for model railroads.
- BUILDERS-of-the-WORLD** for scale models.
- FREE SHIPPING!** on all USA orders over \$20.

Take me there!

Bowser

EXECUTIVE LINE

HO Cal Scale

Lost Wax Brass, Plastic Molded Detail Parts & Wire Form Parts
New Items - In Stock Now!!



Air Horns



Exhaust
Stacks

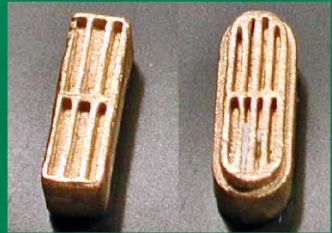

Antenna
Sets



Air Hoses

HO Retro Fit Sound Kits

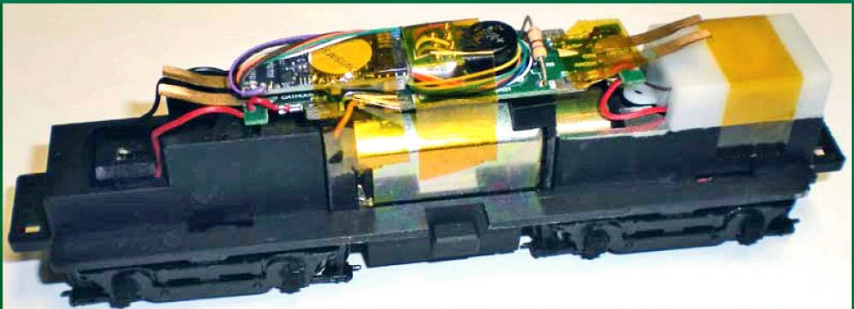

Retro Fit Sound kits for Athearn Ready to Roll & Bowser Locomotives

Click here to check out the details for these and other
great Bowser products!



TABLE OF CONTENTS

FEATURES

Re-weathering a 35-year-old RSC-2

BOB RIVARD

Give an older loco in your collection a facelift



Adding fall color

MICHAEL WOLF

High-quality autumn trees for the layout



Prepping cars for operation

JAMES J. EAGER

Solve rolling stock coupler & weight problems



SP passenger cars, part 6

VICTOR ROSEMAN

Kitbashing accurate heavyweight diners and coaches



An easy way to clean wheels

BRENT CICCONE

Easily clean all your rolling stock and loco wheels



ALSO: Hobby Marketplace | Bonus downloads

TABLE OF CONTENTS | 2

COLUMNS

MRH Q-A-T: Installing grab irons, and more ...

compiled by JOE BRUGGER

Up the Creek: Building a bullnose backdrop end

CHARLIE COMSTOCK

DCC Impulses: DCC throttles

BRUCE PETRARCA

Getting Real: Clearly conveying your modeling era

TONY THOMPSON

Lite and Narrow: The Woodward Iron Railroad

LARRY SMITH

What's Neat: Build a building, sandblast a loco, and more ...

KEN PATTERSON

Photo feature: Yes, it's a model

compiled by DON HANLEY

Derailments: Bizarre facts & humor

compiled by the MRH STAFF

NEWS and EDITORIAL

Assistant Editor's Thoughts: Back to the layout

DON HANLEY

Staff notes: "One module" challenge contest ...

compiled by the MRH STAFF

News & Events: September 2015

RICHARD BALE & JEFF SHULTZ

Reverse running: Nuke the clutter

JOE BRUGGER



SOLID COLD FRUIT GROWERS EXPRESS

100
TON



57
FEET



NEW ARRIVAL FGE 57' MECHANICAL REEFER NOW IN N-SCALE

By popular demand, Athena® is offering the Fruit Growers Express 57' Mechanical Reefer in HO and in N-scale! It is the first Athena N-Scale freight car available with onboard sound. The Genset or refrigeration unit cycles on and off! These models made their debut at the Milwaukee Trainfest 2014 and are now arriving at your favorite dealer. These reefers make any set cool.

N-SCALE NON-SOUND \$29.98 WITH SOUND \$59.98

ATH24862	ATH24762	N 57' Mechanical Reefer, FGE #11984
ATH24863	ATH24763	N 57' Mechanical Reefer, FGE #12028
ATH24864	ATH24764	N 57' Mechanical Reefer, FGE #12145
ATH24865	ATH24765	N 57' Mechanical Reefer, FGE #12269
ATH24866	ATH24766	N 57' Mechanical Reefer, FGE/Solid Cold #12824
ATH24867	ATH24767	N 57' Mechanical Reefer, FGE/Solid Cold #12904
ATH24868	ATH24768	N 57' Mechanical Reefer, FGE/Solid Cold #12873
ATH24869	ATH24869	N 57' Mechanical Reefer, FGE/Solid Cold #12918
ATH24870	ATH24770	N 57' Mechanical Reefer, BNFE #11702
ATH24871	ATH24771	N 57' Mechanical Reefer, BNFE #11910
ATH24872	ATH24772	N 57' Mechanical Reefer, BNFE #12445
ATH24873	ATH24773	N 57' Mechanical Reefer, BNFE #12547
ATH24874	ATH24774	N 57' Mechanical Reefer, BNSF/WFE #799767
ATH24875	ATH24775	N 57' Mechanical Reefer, BNSF/WFE #799772
ATH24876	ATH24776	N 57' Mechanical Reefer, BNSF/WFE #799786
ATH24877	ATH24777	N 57' Mechanical Reefer, BNSF/WFE #799790
ATH24878	ATH24778	N 57' Mechanical Reefer, BNSF/WFE #799793
ATH24879	ATH24779	N 57' Mechanical Reefer, BNSF/WFE #799798
ATH24880	ATH24780	N 57' Mechanical Reefer, UP/ARMN #912057
ATH24881	ATH24781	N 57' Mechanical Reefer, UP/ARMN #912998
ATH24882	ATH24782	N 57' Mechanical Reefer, UP/ARMN #922040
ATH24883	ATH24783	N 57' Mechanical Reefer, UP/ARMN #922047
ATH24884	ATH24784	N 57' Mechanical Reefer, UP/ARMN #922015
ATH24885	ATH24785	N 57' Mechanical Reefer, UP/ARMN #992989

HO-SCALE DUE 12-2015 PREORDER NOW. NON-SOUND \$49.98 WITH SOUND \$89.98

ATHG63056	ATHG63356	HO 57' Mechanical Reefer, BNFE #9251
ATHG63057	ATHG63357	HO 57' Mechanical Reefer, BNFE #9265
ATHG63058	ATHG63358	HO 57' Mechanical Reefer, BNFE #9269
ATHG63059	ATHG63359	HO 57' Mechanical Reefer, FGE/Solid Cold #12828
ATHG63060	ATHG63360	HO 57' Mechanical Reefer, FGE/Solid Cold #12898
ATHG63061	ATHG63361	HO 57' Mechanical Reefer, FGE/Solid Cold #12914
ATHG63062	ATHG63362	HO 57' Mechanical Reefer, Frisco #333009
ATHG63063	ATHG63363	HO 57' Mechanical Reefer, Frisco #333027
ATHG63064	ATHG63364	HO 57' Mechanical Reefer, Frisco #333048
ATHG63065	ATHG63365	HO 57' Mechanical Reefer, TPIX #136
ATHG63066	ATHG63366	HO 57' Mechanical Reefer, TPIX #138
ATHG63067	ATHG63367	HO 57' Mechanical Reefer, TPIX #140
ATHG63068	ATHG63368	HO 57' Mechanical Reefer, UP/ARMN #922012
ATHG63069	ATHG63369	HO 57' Mechanical Reefer, UP/ARMN #922036
ATHG63070	ATHG63370	HO 57' Mechanical Reefer, UP/ARMN #922049

N-SCALE REEFER FEATURES

- Brand new tooling
- Separately installed photoetched struts
- McHenry® scale knuckle spring couplers

- Machined metal wheels
- Minimum radius: 11"
- Modern FGE reefers include Gensets that are visible through openings on the roof & body sides

JUST ANNOUNCED AT THE NATIONAL TRAIN SHOW PORTLAND, OREGON 2015

HO Genesis GP39-2 in several phases.
Visit athena.com for more details!



HORIZON
H O B B Y

VISIT
Your Local Retailer

CLICK
Athena.com

CALL
1.800.338.4639

SERIOUS FUN®

©2015 Horizon Hobby, LLC. Athena, Genesis, Ready To Roll, Train in Miniature, Serious Fun and the Horizon Hobby logo are trademarks or registered trademarks of Horizon Hobby, LLC. The Union Pacific mark and other marks owned by Union Pacific are made under trademark license from Union Pacific Railroad Company. All other trademarks, service marks and logos are property of their respective owners. Final models may vary slightly from photos shown. #93841



Model Railroad Hobbyist | September 2015 | #67

ASSISTANT EDITOR

editorial

DON HANLEY
.....



[Click here for
reader comments](#)

BACK TO THE LAYOUT

SEPTEMBER IS GENERALLY CONSIDERED THE

month that summer ends. Kids go back to school, football season begins, TV shows pick up where they ended last season, and most vacations are over. There seems to be something in the North American psyche that says: *It is time to get back to work, play time is over.*

With summer ending, what are your hobby plans? Do you have a plan of action for the hobby? More often than not, our “plans” to do this or that are little more than daydreams.

How often do we say “I am going to fix this, or rework that section of track that causes us headaches.” But at the end of a busy day at work, we want to eat dinner with the family and watch a little TV. Before you know it, the evening is gone and you haven’t done anything. I’m guilty as charged.

Maybe we’re just armchair modelers at heart? There is nothing wrong with that – just be honest with yourself. But if you are like me and building the layout is important, how do you get yourself to work on it?

ASSISTANT EDITOR'S THOUGHTS | 2

How do we get out of the rut?

First, it is important to figure out *why* we are not working on the layout. It could be boredom or a phase of construction that we don't enjoy. Maybe we're stuck at a technical issue, or working on a section of layout that requires contortions the body rebels against. Whatever it is, identify it.

With the cause identified, I next devise several solutions or different courses of action and *write them down*. I recommend several because the first idea may not be the best. Talk to fellow hobbyists and get their input. Also talk to friends not involved with the hobby. They have no preconceived ideas about modeling that can limit suggestions.

"Getting Real" columnist Mike Rose didn't like the operations on his layout and took the extreme position rebuilding large

ADVERTISEMENT

Hot Off the Presses!

View and pre-order loco and freight announcements from the latest Atlas All Scales Catalog Now!

CLICK HERE!

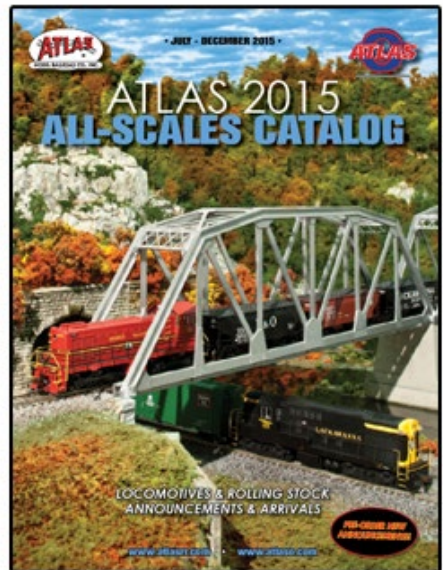

MRHMAG.COM

- [TABLE OF CONTENTS](#)
- [INDEX](#)



Ken Adams

THE FINEST RIDE

80' PULLMAN and 72' HEAVYWEIGHT CARS

with LIGHTED INTERIORS

The classic 80' Pullman and 72' Heavyweight Coach and Combine Cars with Lighted Interiors have returned to our line with updated features such as constant amber DC/DCC LED lighting and improved coupler pockets. They also feature railroad-specific die-cast trucks, low-friction 8-wheel pickup, and E-Z Mate® Mark II couplers. Visit your favorite hobby dealer to see why our 80' Pullman and 72' Heavyweight Cars with Lighted Interiors will offer the finest ride to your passengers!

72' HEAVYWEIGHT COMBINE • SHIPPING NOW! • MSRP \$105.00 each [Click for more info](#)

- Item No. 13601 PRR POSTWAR #9921 with ROUND DOOR (Tuscan red & yellow)
- Item No. 13602 B&O® #1443 with 4-WINDOW DOOR (blue, gray & black)
- Item No. 13603 SANTA FE #1524 with 2-WINDOW DOOR (Pullman green)
- Item No. 13604 NYC® #304 with 4-WINDOW DOOR (green & yellow)
- Item No. 13605 UNION PACIFIC® #2512 with 4-WINDOW DOOR (yellow, gray & red)
- Item No. 13606 SOUTHERN #654 with 2-WINDOW DOOR - *Coming this fall*
- Item No. 13607 PAINTED, UNLETTERED - PULLMAN GREEN - *Coming this fall*
- Item No. 13608 PRR POSTWAR #5159 with ROUND DOOR (Tuscan red & yellow) - *Coming this fall*

72' HEAVYWEIGHT COACH • SHIPPING NOW! • MSRP \$105.00 each [Click for more info](#)

- Item No. 13702 B&O® #5482 (blue, gray & black)
- Item No. 13703 SANTA FE #829 (Pullman green)
- Item No. 13704 NYC® #854 (green & yellow)
- Item No. 13705 UNION PACIFIC® #1115 (yellow, gray & red)
- Item No. 13706 SOUTHERN #1050 - *Coming this fall*
- Item No. 13707 PRR POSTWAR #4536 (Tuscan red & yellow; new roadnumber) - *Coming this fall*
- Item No. 13708 PAINTED, UNLETTERED - PULLMAN GREEN - *Coming this fall*

80' PULLMAN CAR • SHIPPING NOW! • MSRP \$105.00 each [Click for more info](#)

- Item No. 13901 SANTA FE "Moose Lake"
- Item No. 13902 PENNSYLVANIA RAILROAD "Edisonville"
- Item No. 13903 BALTIMORE & OHIO® "Loch Lomond"
- Item No. 13904 NEW YORK CENTRAL® "Mohawk"
- Item No. 13905 UNION PACIFIC® "Lake Waccamaw"

Thousands of Parts, in All Scales, Now Available Online
To order Bachmann parts from our Online Parts Catalog,
visit the Parts & Service section of www.bachmanntrains.com
and click on the "Order Parts" image. You can also contact the
Parts Team at parts@bachmanntrains.com or call 1-800-356-3910
(within the United States) for more information.



Bachmann Industries, Inc. • 1400 East Erie Avenue • Philadelphia, PA 19124 USA • www.bachmanntrains.com

[Click for more information.](#)

MRHMAG.COM

- [TABLE OF CONTENTS](#)
- [INDEX](#)



**Weathered
WHEELSETS!**

**DALLAS
MODEL WORKS**

New! Click here



Archer
FINE TRANSFERS
PROUDLY SERVING MODEL BUILDERS SINCE 1989

THE ORIGINAL
SURFACE DETAILS™

WE NOW HAVE MORE THAN 100 SHEETS OF RIVETS, LOUVERS, TREADPLATE AND MORE CAST ONTO MICROSCALE CLEAR DECAL FILM

FREE SHIPPING:

- DOMESTIC USA ORDERS \$50 OR MORE
- INTERNATIONAL ORDERS \$100 OR MORE

CLICK HERE TO VISIT OUR WEBSITE! →

Archer Fine Transfers • PO Box 1277 • Youngsville, NC 27596 • USA (919) 570-1026 • info@archertransfers.com • archertransfers.com

MADE IN THE USA

"Archer rivets are easy to apply and look great. To me, they are now a vital tool in building railroad models."
Tony Thompson, Model Railroad Author/Historian

ASSISTANT EDITOR'S THOUGHTS | 3

portions of it. Mike took the time off from running trains to figure out what was wrong, asked for input, and then developed a plan for making changes, see mrhpub.com/2015-07-jul/port/files/71.html and mrhpub.com/2015-08-aug/port/files/73.html.

The deadline of the NMRA convention spurred Publisher Joe Fugate back to work on a layout that had been mothballed for three years. He took the time to determine what needed to be done and prioritized items to be worked on. See mrhpub.com/2015-02-feb/port/files/11.html.

But what if you don't have a deadline or some compelling reason to get you working on the layout. What can you do then?

I am a firm believer in writing down goals. Once it is down on paper as a goal, it moves from wishful thinking to something

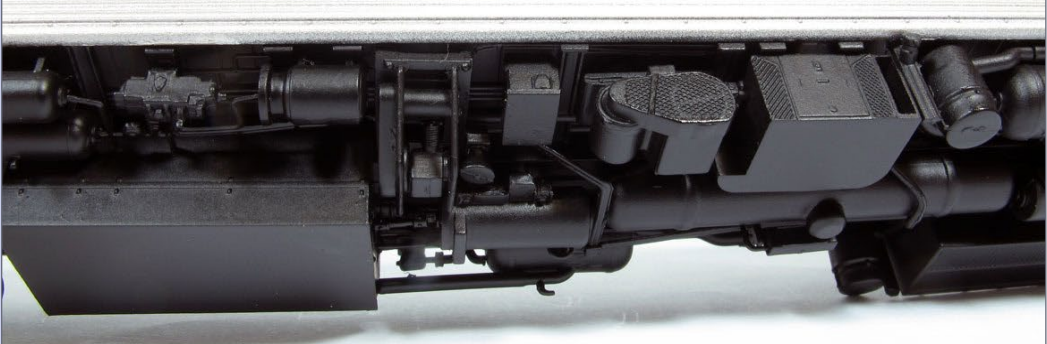
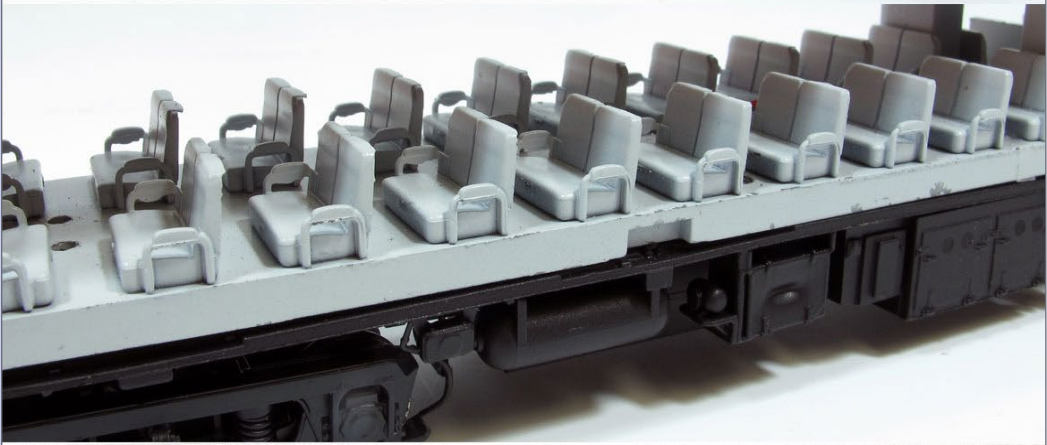

**FIRST TEST SAMPLES
CLICK HERE.**

tangible. Once it is written, a plan of action can be developed. The action plan does not need to be detailed, but it should contain key elements of what is needed to complete the stated goal.

Once the goal has been established, create a deadline for yourself and write it down. Why? Unless there is a written deadline it is just like an unwritten goal -- wishful thinking. If you don't meet your self-imposed deadline, so what? You are still further along than if you hadn't done anything. Just write a new deadline.

I understand many of us will not take the time to practice this exercise. Some of you might think it's a waste of time. Consider this: In 1979 new Harvard MBA graduates were asked a simple question "Have you set clear, written goals for your future and made plans to accomplish them?"

- 84% had no specific goals
- 13% had goals but they were not committed to paper
- 3% had clear, written goals and plans to accomplish them

Ten years later the graduates were interviewed again. The results?

- The 13% of the class who had goals were earning, on average twice as much as the 84% who had no goals
- The 3% who had clear, written goals were earning on average 10 times as much as the other 97% combined.

See sidsavara.com/personal-productivity/why-3-of-harvard-mbas-make-ten-times-as-much-as-the-other-97-combined

So, are written goals important? I think so. Will they help you make progress on your layout? I believe they will.

ASSISTANT EDITOR | 5

I will leave you with this quote from Mark McCormack: "If you don't have time to write down your goals, where are you going to find time to accomplish them?"



[Click here for reader comments](#)

ADVERTISEMENT

Checked us out lately?

- HO/N and now O scale products too!
- Laser-cut Structures & Bridges.
- Advertising & Storefront Signs.
- Highway Signs, vintage & modern.
- New Detail Items.
- Laser-cut Grade Crossings.
- Billboards, roadside & rooftop.
- Laser-cut Graffiti Decals
- 1000's of satisfied customers.



Established 1993...

Blair Line

ADVERTISEMENT



Your Local **N Scale**
Online Hobby Shop

575-523-9743
fiferhobby.com

MRH CONTEST: THE "ONE MODULE" CHALLENGE



GOAL: Design the first "module section" for a sectional home layout design.

Hypothetical room is 12' x 15'

NOTE: This is a sectional home layout design, *no modular standard* required.

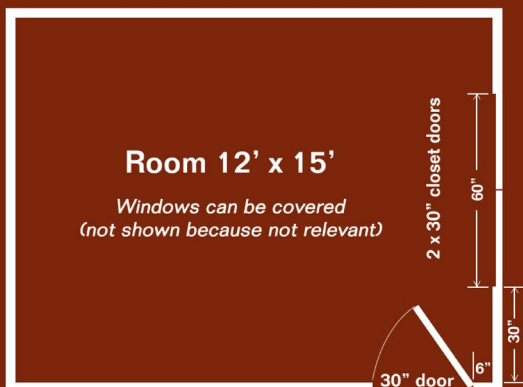

CONTEST RULES

ENTRY DEADLINE: January 31, 2016

- Module must be 18"-24" in depth and 60"-84" in length.
- Scale: Z, N, TT, HO, S, O - standard and/or narrow gauges.
- Connectable to a flattop staging section (or additional layout sections later) at each end. Design the two flattop staging yards with 3 to 8 staging tracks of at least 70" long.
- Rough out the outlines of the other layout module sections to be built for the entire room. No track plan needed, just an outline of the modules in the room is sufficient.
- Describe the theme, era (if any), and rationale for the module and its place in the layout that would eventually fill the room.
- Can follow a specific module standard (like Free-Mo) if desired, but that is not a requirement. Each module can be custom and only mate with an adjacent module.
- Module support method and height is up to you, but please describe it.
- Must be wired for either DC or DCC. Describe how you would interconnect the wiring.
- As the first module of a sectional home layout design, making the module removable once completed is not required, but innovation here will get extra points.
- As to construction methods & materials, surprise us. Extra points awarded for innovation.
- Include pricing for the module. There's no need to build it, this is a design contest. This includes module benchwork, legs, backdrop, roadbed, trackwork, wiring, scenery materials, structures, and details. Do not include a DCC system, rolling stock, or locos.
- The best submissions will be published, so extra points will be awarded for high quality text, illustrations, photos, and captions. Winners will get a bonus payment rate.



STAFF NOTES



[Click here for
reader comments](#)



“ONE MODULE” CHALLENGE CONTEST ... AND MORE

WE’RE KICKING OFF A NEW CONTEST THIS ISSUE:

the “One Module” Challenge Contest. In a nutshell, this is a contest to design the first module of a home layout that’s to be built in separate pieces. These sections do not need to follow any modular standard, although they can if you want.

See the contest announcement to the left for all the details.

One reason we’re promoting this contest is to drive home the idea that using sectional methods to design and build a home layout is an excellent approach to the hobby in the 21st century.

It works like this: pick some interesting scene, town, or industry for your layout (called a Layout Design Element or LDE in layout design parlance), and design a single “module” or section around it. We will use the term module below for convenience, but remember, we’re referring to a generic layout section, not something following any particular modular standard.

STAFF NOTES | 2

You can build this module at the workbench, likely doing your best work in complete comfort. Need to install turnout motors and wiring underneath? Turn the module over to work on it.

Build this module to a finished state, complete with scenery and structures. Now add flattop staging to each end and run trains!

Flattop staging is nothing more than a 1x12 inch board that's 8 feet long with a small staging yard on it. If you need more length, then add more boards on the end, with more yard tracks that line up with the first board.

Need more layout? Build another module and add it in. To build the entire layout, just keep on adding module sections until you get the whole layout. You can stop any time, and all along the way, you have a finished, operational layout. Completely adaptable layout scope management!

If your space changes, keep the finished modules and redo the connecting pieces. Build as much layout as time and skill allows, all the while having a finished working layout in the layout room. Scale back your plans without any worries once you see what your actual time and abilities allow you to accomplish.

Give it a try! Provide a thumbnail sketch outline for a layout in sections to fit a 12 by 15 foot room. Then design the first module section in detail, price it out, and enter it in the contest. If you have some innovative ideas on how to do lightweight layout module sections, you'll get extra credit for that.

Let's see what you can come up with!

2015 NMRA National Retrospective

As we're writing this, we're just coming off the 2015 NMRA National Convention. It was quite a week, with several MRH



LAST ISSUE'S RATINGS

The five top-rated articles in the [August 2015 issue](#) of *Model Railroad Hobbyist* are:

- 4.6 DCC Impulses: Getting started in DCC
- 4.5 What's Neat: Helicon focus, carving foam, and more
- 4.5 Using Excel to create your employee timetable
- 4.4 Getting Real: Finishing an entire aisle, part 2
- 4.3 Building Meadow Gold dairy

Issue overall: 4.5

Please rate the articles! Click the reader comments button on each article and select the star rating you think each article deserves. Thanks! ■

ADVERTISEMENT

HobbyOn

www.hobby-on.com

Come & See Us
[CLICK Here](#)

Name Brand Hobby Products at Discount Prices!

MRHMAG.COM

- [TABLE OF CONTENTS](#)
- [INDEX](#)

STAFF NOTES | 4

staff members showing layouts as well as doing clinics. The week ended with the National Train Show. For MRH, the Train Show saw a steady stream of brisk booth traffic most of the time. We got a host of new subscribers for MRH and for our network TV-quality internet channel, TrainMasters TV.

Publisher Joe Fugate hosted layout tours and an op session. Here's Joe's take on how it went:

"I worked hard getting the layout ready, and the last couple days we had TMTV Exec Producer Barry Silverthorn on hand to shoot the progress of final prep. When Barry didn't have a camera in hand, I put him to work on the layout!

"Barry did some scenery, helped test and tune rolling stock, and debugged operational issues by running lots of trains.

ADVERTISEMENT

Backdrop Junction
Your Stop for Railroad Backdrops

Click Here →

**For the Finest in Custom
Designed backdrop**



www.backdropjunction.com

ADVERTISEMENT

NICK & NORA DESIGNS
Uniquely inspired craftsman kits



**Craftsman Structure Kits,
Detail Parts, Shingles & More!**
www.nickandnoradesigns.com



Nick & Nora Designs
a division of
TMB Custom Models



MRHMAG.COM

- [TABLE OF CONTENTS](#)
- [INDEX](#)

STAFF NOTES | 5

“Barry also shot the Siskiyou Line special convention op session live and we’ll be doing that on video, too. We’re expecting to debut all this video on TMTV and DVD this January as part of the Siskiyou Line’s 25th anniversary in the January 2016 issue of MRH.”



PHOTO FROM TRAINORDERS.COM

Dick “Iron Duke” Yager, 1949-2015

Dick Yager, owner of Oregon Rail Supply, passed away suddenly at his home in Scappoose, OR, on August 25th. Dick was born in Fort Wayne, IN where he owned a hobby shop for many years.

ADVERTISEMENT

GLXSCALEMODELS.COM

GLX SCALE MODELS - OTTAWA, ONTARIO, CANADA - 613-294-2276



3D PRINTED MODEL

NO ASSEMBLY OR PAINTING



MOBILE LOADING RAMP



PORTABLE RAILCAR
UNLOADER



RAILCAR INSPECTION
TOWER

BUY & DISPLAY NOW!!!

MRHMAG.COM

- [TABLE OF CONTENTS](#)
- [INDEX](#)



PHOTO FROM TRAINORDERS.COM

Dick was a key player in the late 1970s in the Fort Wayne Railroad Historical Society's rescue and restoration of NKP 765, a 1944 Lima-built 2-8-4. He moved to Oregon and began Oregon Rail Supply in 1989, manufacturing signals and other detail items for the hobby, as well as distributing Accurail products.

In addition, Dick was involved in the restoration and operation of Southern Pacific 4449, and an active member of the Oregon Rail Historical Foundation.

Suzanne Yager would like to say a special thanks to all who assisted her in the National Train Show staffing the booth. If you have any stories you would like to share about Dick, please send them to Suzanne at rpyager@netzero.net

Dick is survived by Suzanne, his wife of 29 years; and his son Rick.

What's new on the MRH website?

Here's our monthly listing of some interesting posts.

Build an optical detector: mrhmag.com/node/23535

Using momentum on DCC: mrhmag.com/node/23331

Powering turnout frogs: mrhmag.com/node/23512

Wiring a wye: mrhmag.com/node/23545

Get non-flickering car lighting: mrhmag.com/node/4451

Lower the level of a siding: mrhmag.com/node/23507

Doing flatcar lumber loads: mrhmag.com/node/23327

Static grass applicator update: mrhmag.com/node/5776

ADVERTISEMENT

American Limited

HO AND N
DIESEL AND PASSENGER
CAR DIAPHRAGMS.

THE
FINISHING
TOUCH.

AT YOUR DEALER OR DIRECT.
www.americanlimitedmodels.com

MRHMAG.COM

ADVERTISEMENT

George's Trains EST. 1962
Canada's Greatest Model Train Store

20 NEW Colours Just added!

PROTO-PAINT

ACRYLIC-Air Brush Ready
NOW OVER 45 Canadian Railway Colours!

Dealer inquiries welcome.

\$8.98 each Canadian

ORDER NOW!

550 Alden Rd. Unit 101, Markham, On, Canada L3R 6A8
Tel: 905-470-6200 Toll Free: 1-877-8TRAINS (887-2467)
www.georgetrain.com

PP-001 CNR Green #11	PP-020 TH&B Maroon	PP-038 TTC CREAM
PP-002 CNR Imitation Gold	PP-021 Primer	PP-039 TTC Maroon
PP-003 CN/VA Blue #16	PP-022 Reducer	PP-040 Warm BLACK
PP004 CN/Via Yellow #18	PP-023 Flat Finish	PP-041 Grimy Black
PP-005 VIA Grey	PP-024 Stencil White	PP-042 Anti-Glare Black
PP-006 CN Red/Orange #11	PP-025 Loco Black	PP-043 Slag Brown
PP-007 CN Lettering Grey #17	PP-026 Flat Haze	PP-044 GO Green
PP-008 CN Grey #11	PP-027 ONR LT BLUE	PP-045 GO White
PP-009 CNR Red #12	PP-028 ONR DK BLUE	PP-046 CONRAIL Blue
PP-010 CPR Tuscan	PP-029 ONR YELLOW	
PP-011 CPR Diesel Grey	PP-030 ONR Post 2000 Yellow	
PP-012 CPR Diesel Yellow	PP-031 ONR GREEN	
PP-013 CPR Steam Grey	PP-032 BCR/PGE DK GREEN	
PP-014 CPR Mineral Brown	PP-033 BCR RED	
PP-015 CP Action Red	PP-034 BCR Blue	
PP-016 CP Action Yellow	PP-035 BCR Yellow	
PP-017 CP Action Green	PP-036 BCR/PGE LL GREEN	
PP-018 CP Bright Red	PP-037 GTW Blue	
PP-019 TH&B Cream		

- [TABLE OF CONTENTS](#)
- [INDEX](#)

STAFF NOTES | 8

Build a crossing signal circuit: mrhmag.com/node/23504

Modeling a junk yard: mrhmag.com/node/23519

HO scale glass block windows: mrhmag.com/node/23427

Sound, yes or no? mrhmag.com/node/23335

Dealing with solder corrosion: mrhmag.com/node/23413

Have a good read of the September issue of MRH!



**Click here for
reader comments**

ADVERTISEMENT



WORLD FAMOUS
MODEL TRAIN STORE

Since 1938!

The World's Largest Model Train Store!

Model trains G to Z, DCC, brass models, kits, RTR, collectable models, scenery, structures, books, magazines, DVD's, hobby tools & supplies and a full service repair department.



WWW.CABOOSEHOBBIES.COM

MRHMAG.COM

- [TABLE OF CONTENTS](#)
- [INDEX](#)

The Get the Latest Model Railroading News, Tips, Reviews & Opinions

SCOTTY MASON

S H O W

The Original Model Railroad Podcast

-Monthly Interviews

- Modeler's Spotlight: Top Modeler's Talk
- Narrow Gauge Modeling w/Chris Lane
- Contemporary Modeling w/ Mike Rose

-More Product Announcements & Reviews

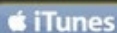

Our feed has changed! To get the latest shows, Please search Scotty Mason and subscribe to the new feed!

www.TheModelRailroadPodcast.com

Scott Mason Jimmy Simmons Mike Rose Joe Duckworth

**When talking
to hobby
vendors,
please
remember
to mention
MRH.**

ADVERTISEMENT

HO GP60M, GP60B AND GP60 LOCOS



NOW AVAILABLE !



DC OR DCC WITH SOUND!



www.foxvalleymodels.com

MRHMAG.COM

- [TABLE OF CONTENTS](#)
- [INDEX](#)

TRAINMASTERS.TV 2015 National Train Show report ...



Brought to
you by

MRH
MODEL RAILROAD HOBBYIST



Coming in September!

Non-members can watch for only \$1.49

Visit the TrainMasters TV website

MRHMAG.COM

- [TABLE OF CONTENTS](#)
- [INDEX](#)



MRH Q-A-T

column

compiled by
JOE BRUGGER



[Click here for
reader comments](#)

QUESTIONS AND ANSWERS

Drilling holes for grab irons

Q. I have just spent the last two weeks trying to drill umpteen #79 holes for the grab irons on a Tichy USRA box car kit. Nine broken #79 drill bits later with some bit ends stuck in the hole I was drilling, I am totally frustrated. I have been using my finest twist drill, soaping drill bits and trying to keep the work as steady as possible. What's the secret?

—Ken Adams

A. Geoff Bunza: Drilling tiny holes can be a challenge. Fortunately, soft plastic is about the easiest material to use, if you want to call it easy.

I have never been able to use a motorized drill with #80 and #79 bits with consistent luck. I always use the smallest pin vise I have. Insert the drill bit as far into the pin vise as you can, leaving only enough exposed to make the correct depth hole.

▶ MRH QUESTIONS, ANSWERS, AND TIPS

MRH Q-A-T | 2

Use a very sharp awl or scribe to mark and start the hole. This creates a dimple in the plastic. For consistent hole patterns like those needed for hand grabs, make a template for the hole spacing. That is, get a piece of plastic or metal, lay out the hole pattern in it, and drill the holes. Align the template on the side of the car with another piece of glued-on plastic to form an L bracket, or tape it in place. Use the scribe or even the drill in the pin vise to start the hole for the grab iron.

I use a lubricant called Boelube (orelube.com/products/liquids) available in liquid, paste, and paste stick from MSC Industrial Supply mscdirect.com and amazon.com. It is the best cutting lubricant for any material that I have ever used.

Drilling with a small drill means you must keep the work steady and the drill vertical. I literally tape the work to my bench or a piece of scrap wood or plastic with blue painters masking tape. With irregular plastic models, this is easier than clamping them in a vise, which would also be ideal. Drill for a

small depth and then remove and clear the flutes of the drill bit. This takes patience and practice. I still break bits from time to time, particularly when I get in a hurry or frustrated with the work.



1. The BLMA grab iron template is etched stainless steel marked for grabs in common sizes from 15 to 24 inches wide.

Many small bits on the market are just plain junk. A sharp bit is essential. I have purchased “bargain” 60-80-bit sets where many of the bits were dull, new out of the package. They were no bargain at all.

A couple of vendors have sold grab iron templates for ladders [1], but I don’t remember who they are. Practice will improve your efforts with considerably large amounts of patience.

Rob Spangler: I must confess to not being the steadiest with small drills, and I do break a few. What I started doing was to use a slightly oversized drill, maybe up to a #76. The small amount of extra strength helps, and the larger hole diameter disappears once the grabs are glued in.

For more advice and opinions, read the thread at mrhmag.com/node/22681.

Average lifespan of a railroad car?

Q. Can anyone tell me what the average lifespans of the different types of railroad cars are? Box cars, tankers, hoppers etc. My layout is set in the year 2000, and I would like to keep the cars pretty prototypical for the era. I’m thinking that cars from the ’70s would be fine and also ideal for some of the more extreme weathering, but everything I’ve read on the Internet seems to be giving conflicting results of exactly how long cars are in service mandatory retirement. I’m modeling a resurrected shortline on the premise of “what might have been” if they hadn’t gone out of business in the 1970s.

—Stu

A. Conflicting answers on the Internet? Say it ain’t so, Stu!

James Ogden: Short answer, anything since the 1970s goes, basically.

Age of freight cars is dependent on a few things. There are restrictions on age for cars used in interchange service. If a railroad wants to use a freight car in interchange service (moving from one railroad to another, then its life is over at age 50. If the car will stay on home rails, there is no limit. It is actually not uncommon to see older cars in maintenance of way service.

On the BNSF, I did spot a Santa Fe flat car with a build date of 1934. Of course, BNSF is huge, so staying on home rails is pretty easy and still allows a lot of travel for such a car.

Rob Spangler: The typical car in interchange service is subject to a 40-year underframe rule, unless remanufactured for 50-year compliance. There's now a 65-year rule for certain cars.

Any car built from 1960 on would be acceptable for your 2000-era layout. House cars built up to 1966 would have to exhibit revised safety appliances (no running boards, A-end ladders shortened to four rungs, an L-shaped grab iron on the roof at the B end if it retained high-mounted brake wheel and ladders, and a yellow placard stating "keep off roof – no running board").

Weathering on these older cars may not always be as extreme as you'd expect. It was still possible to see examples of paint schemes pre-dating the '70s and '80s mergers which remained more or less intact.

Chris van der Heide: I see tank cars with late -1970s/early -1980s built dates with some regularity. They're not as common, and that's for tanks that haven't been repainted/rebuilt/reweighed, and still have the original "NEW 5-79" etc. marking



2. GLNX 5329, photographed March 29, 2013, has a 12-79 new date: *Chris van der Heide photo*

visible. I see plenty more which I'm pretty sure are 1970s cars, but don't have the original date marking (and the data in the COTS panel is too small to read in the photographs, or when the train is rolling by at 40 mph).

Cars get repainted, renumbered, re-leased and sold, so that 1970s car design might be totally appropriate for your layout. The paint scheme or car number might not, at least not in its original state – a lot of secondhand cars exist out there in original paint but with all original logos painted over and renumbered for new owners.

Some secondhand cars can be traced using sites like railcar-photos.com and canadianfreightcargallery.ca with detailed

search features. Don't let the name turn you off – it also includes lots of U.S. equipment. Other sites like rr-fallenflags.org and rrpicturearchives.net also have lots of good material but aren't searchable by car history.

Read all of the answers at mrhmag.com/node/13366.

Paint cork before track?

Q. I'm about ready to put down some cork. The question is, should I paint the cork a base color before the track goes down, or just paint the cork and track together later? This is a yard area with seven tracks on sheet cork. If I paint first, I'm not sure how to transfer the track plan from my paper plan to the cork. May be hard to see on a dark base. I was thinking of using flat black as my base color. Suggestions, experiences, unrelated but funny anecdotes?

—Randy

A. Alan: Glue, track, then paint for me. Same issue – couldn't see centerline tracings if cork was painted first. A light coat of Camo Earth Brown is just a head start on weathering to come later. Rob Spangler will tell you to lay all track and operate the layout before painting, in case track changes are necessary. Good advice for some. I traded scraping a little paint off if need be, in exchange for no voluminous spray-painting in the train room.

Rob Spangler: I don't think you gain anything by painting first. Besides, when you paint the track, it will cover up the initial color on the roadbed anyway.

Tony in Gisborne, Australia: I'm with Alan and Rob. Lay track first, spray-paint it, paint cork on either side of tracks/yard, and spread ground cover, lastly lay ballast.

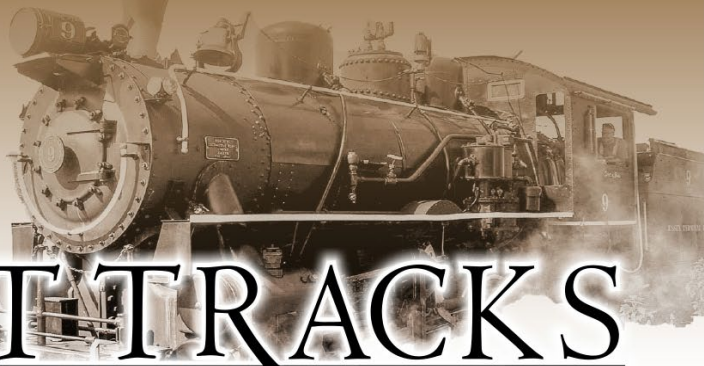

FAST TRACKS

YOUR VERY OWN TRACK FACTORY

Make the most of your modeling experience.

Build perfect trackwork easily and inexpensively when YOU want it!



Check out our extensive (and growing!) online video library to learn how easy it is to hand lay your own trackwork with Fast Tracks tools and supplies.

Play Video 



shop online 24/7

1-888-252-3895

handlaidtrack.com

service@fast-tracks.net

MRHMAG.COM

- [TABLE OF CONTENTS](#)
- [INDEX](#)

FINISHED Details

OVER 1000
UNIQUE DETAILS

WWW.
modeltechstudios.com

Rusting Car
Skeletons

Coal
Conveyors

Welders

Steam
Boilers



MRH Q-A-T | 7

Graeme Nitz: Paint all the “ground” first with a “ground” color, then lay the cork and track and paint the cork and track a “track” color.

Alan T.: One exception to the above advice might be under turnouts. Some like to spray the cork with “faux stone” texture paint to avoid having ballast foul the turnouts.

Brendan: I had a similar issue with seeing the lines. I painted mine with latex light gray and then added the lines. I used latex caulk to hold the track down. I have since had to make alterations and I can verify that the track and paint adhered well to the cork. When I pried the track up, the paint came up with the latex caulk and some cork in spots.

Under turnouts, someone showed me a trick where they cut a piece of tuck tape (used for vapor barriers) and stuck it under

MRH Q-A-T | 8

the switch points. He then sprinkled some ballast on top, and shook off the excess. The result was a thin, one-granule-thick layer of ballast that was well under the level of the points and wouldn't interfere. Later, an alcohol/water/glue mix was added for extra adhesion.

See more answers and photos at mrhmag.com/node/22600.



TIPS

Drill bit chart

While working on brake line detailing I frequently had to switch twist drill bit sizes. I became frustrated with trying to guess at what size drill bit to use with each diameter of brass wire. After an Internet search for the drill number/size comparison, I made a chart and taped it to the back of my drill bit case.

I had a feeling that over the years some drill bits were not

Combo Right Clamp™

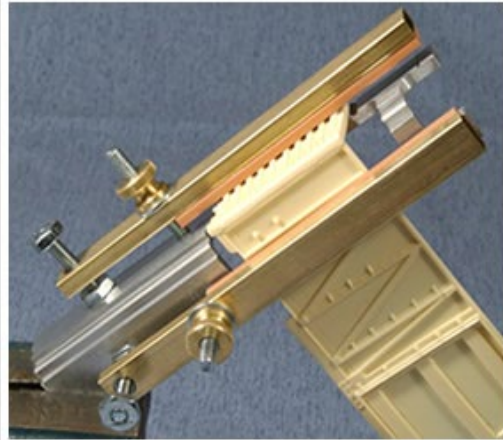

Combo Right Clamp™
with cast resin boxcar

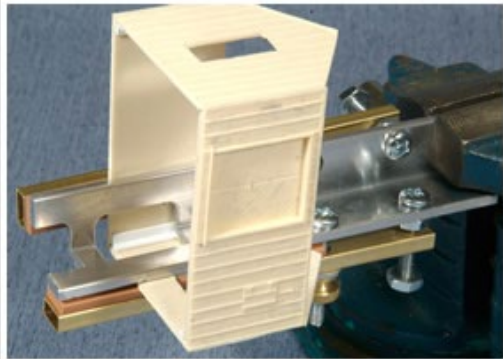

Combo Right Clamp™
with Wolf Design Pump House

**Click here for
all our products ...**

Tools for Modelers

Coffman Graphic Solutions Co.
1500 River Circle, Richmond,
KY 40475-7907

in the correct spot. I removed all of the drill bits and placed them onto a larger printout of the chart. I placed Scotch tape with the sticky side up over the decimal numbers to keep the drill bits from rolling around. I used my digital caliper to measure the drill bits and place them in the proper spot. After all were measured I placed them back into the case.

Now I don't have to guess at drill bit sizes anymore.

—Eric Warhol

Ed: Another way to save time fussing with drill bits is to use several different pin vises, with different bits chucked in them. I find the pin vises at swap meets and rarely pay more than \$5 for a good used one. Three or four are plenty.

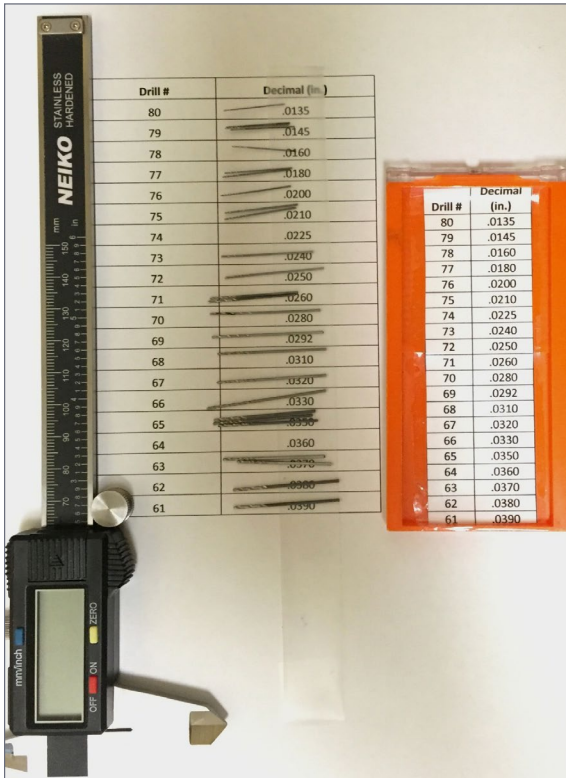

3. A little bit of organizing ahead will save valuable modeling time.

MRH Q-A-T | 10

GET PAID FOR YOUR TIP

We pay \$25 per tip we publish, or \$40 each if the tip also includes a photo or finished drawing. [Click here and select article type TIP.](#) ■



[Click here for reader comments](#)



**DID YOU KNOW
MRH SUBSCRIBERS
GET FREE BONUSES?**

**CLICK TO SUBSCRIBE
NOW - IT'S FREE!**

MRHMAG.COM

September 1901?

[CLICK TO KNOW MORE](#)

The Grand Canyon Line

Like The Santa Fe approached the development of the South Rim of the Grand Canyon with engineering skills and technology Microscale uses the most advanced machinery and processes to develop our new products



Proudly made in the U.S.A.

Since 1933



www.microscale.com



- [TABLE OF CONTENTS](#)
- [INDEX](#)

500 pages of Structure plans!

Drawn by Pat Harriman, MMR and Architect

What customers are saying ...

"I am really impressed ... WOW, really nice."

- W. Kroebig

from the
Model Railroad
Hobbyist *Store*

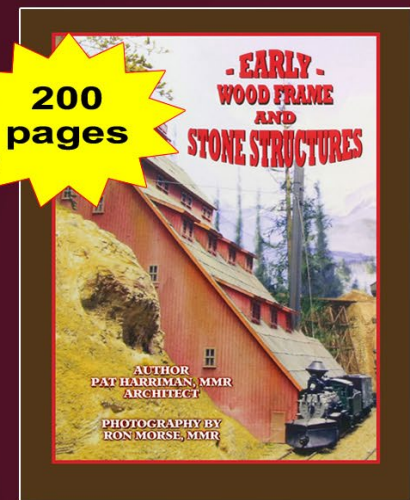

200
pages

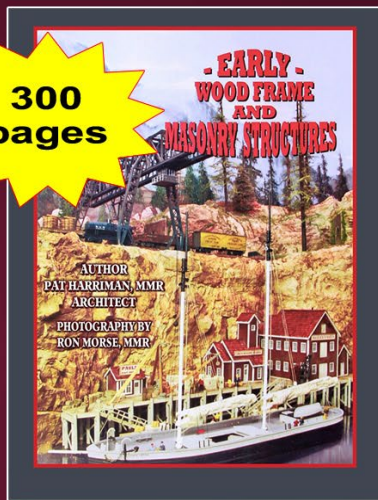

300
pages

Hardcopy

\$25.49

+ shipping/handling

~~\$29.99~~

Hardcopy

\$29.59

+ shipping/handling

~~\$36.99~~

GET VOL 1 BOOK NOW >>

GET VOL 2 BOOK NOW >>

eBook (instant download)

~~\$19.99~~ **\$10.99**

FORMAT: PDF or ePub (iBooks)

eBook (instant download)

~~\$21.99~~ **\$11.99**

FORMAT: PDF or ePub (iBooks)

GET VOL 1 eBook NOW >>

GET VOL 2 eBook NOW >>

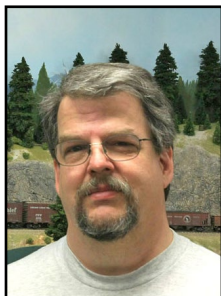

UP THE CREEK

column

CHARLIE COMSTOCK
.....



[Click here for
reader comments](#)

PUTTING A BULLNOSE ON THE END OF A BACKDROP ...

IN NOVEMBER THE AUTHORITIES INFORMED

me that it would be improper to host a December op session on the Bear Creek & South Jackson. I figured taking an extra month between op sessions would be a good time to complete the peninsula's benchwork and backdrop and install the remaining two miles of mainline. Accordingly, the week after the November 2014 session, my construction crew started the process of demolition and reconstruction.

In my "Up the Creek" column in the July 2014 *MRH* issue (mrh-pub.com/2014-07-jul/land/#22), I wrote about building the peninsula backdrop. I wanted to keep its thickness to a minimum. The 5" thickness required by a 2x4 stud wall could be much better used as space for trains. I built my backdrop out of two layers of 5mm Revolution Ply (from Patriot Lumber) laminated together with construction adhesive. Once the glue set and the clamps

▶ **BUILDING A FREELANCED 1950S ERA LAYOUT**

UP THE CREEK | 2



1. The newly completed backdrop runs the length of the Bear Creek & South Jackson's peninsula and really enhances the sense of isolation for train crews, as well as reducing the noise level during an op session. The backdrop is less than 1/2" thick in most places, but I elected to add a bullnose to the end of it. The bullnose looks great and avoids revealing that the sky is only 1/2" thick. It's built out of a cardboard shipping tube glued to a plywood mounting plate.

UP THE CREEK | 3

were removed, it proved to be stiff and straight – the warps and bows in the plywood sheets disappeared. With a thickness of only 3/8” it also left more space for the trains.

However, I didn't like the idea of people at the end of the peninsula being subjected to a view of the relatively knife-edge-like end of the backdrop. I figured a bullnose would make the end of the backdrop (and the peninsula) more aesthetically pleasing [1]. Follow along to see how we built it.

Pictures following ...

ADVERTISEMENT



Rusty Stumps
Scale Models

WE ONLY SELL WHAT WE MANUFACTURE

DETAILS IN HO, O, S & N SCALES

LASER CUT SHINGLES, DOORS & WINDOWS, FENCES, SIDING, CRATES. Also RESIN and WHITE METAL DETAILING CASTINGS.

CRAFTSMAN KITS
IN HO, O & S SCALES

CHECK IT ALL OUT AT

WWW.RUSTYSTUMPS.COM

Send \$3.50 for Catalog - Specify Scale

RUSTY STUMPS SCALE MODELS

6785 Cherry Blossom W. Dr., Fishers IN 46038

Phone (317) 595-9489

MRHMAG.COM

- TABLE OF CONTENTS
- INDEX

UP THE CREEK | 4



2. After the November 2014 op session the end of the peninsula looked like this. Before the next session, the temporary Salem staging area will be dismantled, the upper deck peninsula benchwork and subroadbed installed, the backdrop (left) extended close to the peninsula end, and the final two miles of mainline installed. The full-length backdrop will block the view of crews in this aisle so they can't see the next towns to the east and west – increasing their feeling of isolation and making them put a little more skin in the TT&TO game we play during op sessions. Running on smoke signals would no longer be feasible.



3. By late November, 2014 the peninsula benchwork was completed and it was time to get cracking on the back-drop. The two plywood laminations will separate about 24" from the end of the benchwork, and will be screwed to the bullnose mounting plate. This photo shows the first layer of plywood in place. Note the warpage of the plywood visible at the seam. Once the two layers are laminated, the bowing disappeared.



4. Here's an inside view of the bullnose's mounting plate. It's made of three pieces of plywood and is attached to the benchwork and the backdrop support cleat in the ceiling. I used my trusty copy of 3rd PlanIt layout-design software to figure distances and angles (5). The backdrop plywood separates about 24" from the end of the backdrop and each piece is screwed to the mounting plate, holding it firmly in place.



**FUN
FUN
FUN**

In the Summer!



S T A T I O N

623-298-7355 • www.Mr-DCC.com
www.LitchfieldStation.com

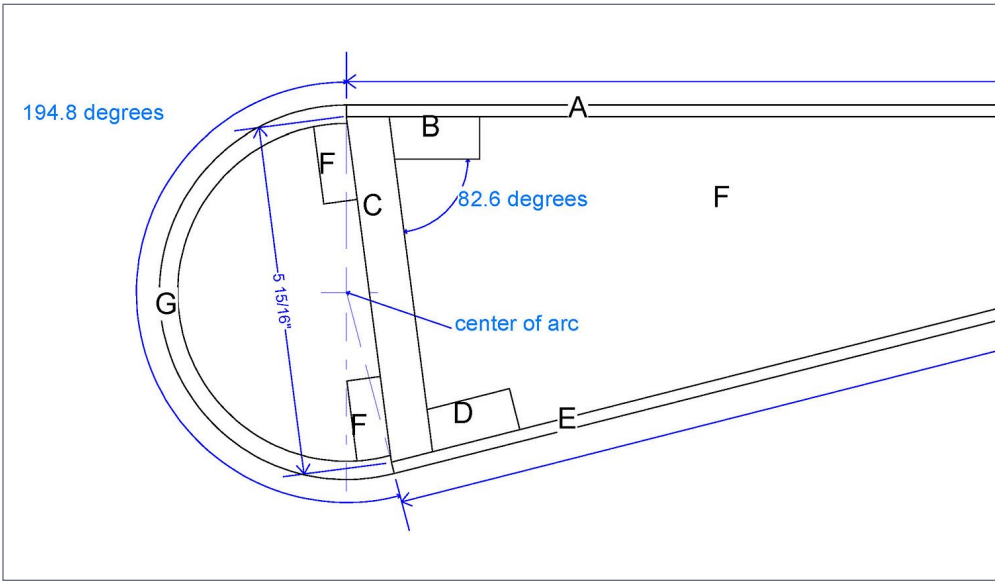

5. A cross-sectional top view of the end of the backdrop shows how the backdrop layers (A) and (E) split and are screwed to the bullnose mounting plate cleats (B) and (D).

I created this diagram full-size in 3rd PlanIt. When done, I took distance and angular measurements directly from the CAD plan. It showed an angle between the backdrop pieces of 14.8°. Pieces B, C, and D needed to be beveled 7.4°. I was a little concerned that a 24" span of non-laminated backdrop might be prone to warping, but between being screwed to the mounting plate and stiffened by the curve where A and E separate, my concern proved groundless – no warps are visible.

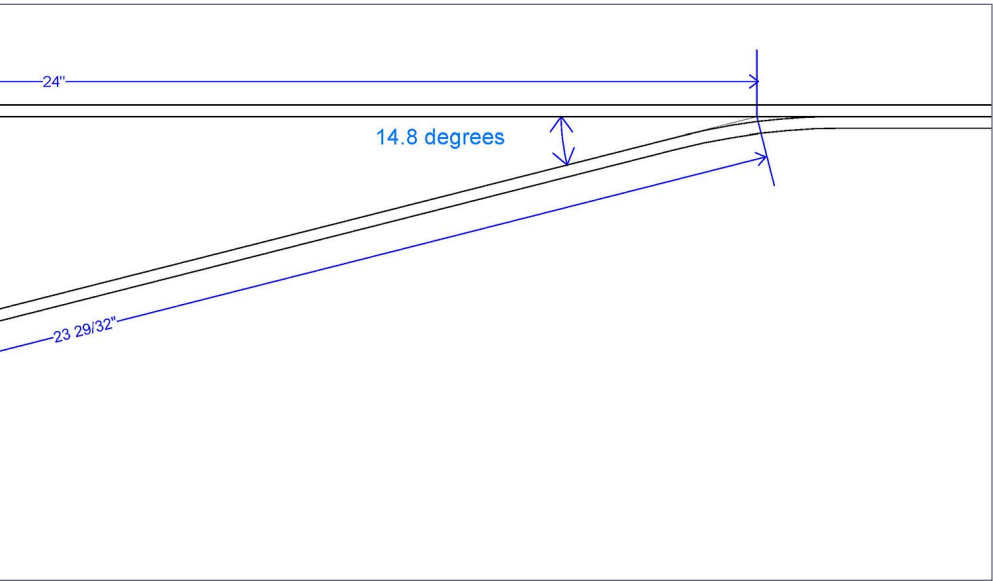

ADVERTISEMENT

END OF TRAIN DEVICE



Bright Red Flashing Light!

Installs in minutes with no freight car modification required!

RE RING
ENGINEERING

Patented Technology - US Patent 7,549,609

Does not affect Load!

↓ Car without Load ↓

↓ Car with Load ↓



For video and more click here!

USES FOR CAD



I've found lots of uses for CAD in the train room besides creating trackplans and figuring out how to support a back-drop bullnose. I've laid out a 200"-radius curve when there wasn't

room for a 200" trammel, designed control panel diagrams, created benchwork lumber cut lists, made plans for scratchbuilding bridges and structures, and even created custom fast clock faces. ■



**Model Railroad
Hobbyist magazine™**

YES, subscribing MATTERS!

(even though it's free)

**It helps MRH get more
advertisers**

Click here to subscribe!

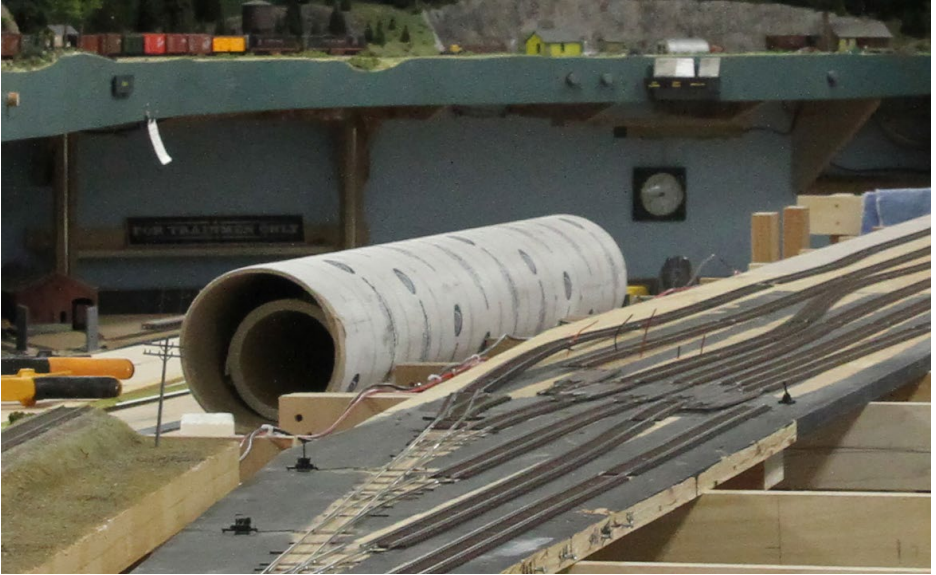

6. My friend Paul works for a shop where large cardboard shipping tubes arrive full of stuff, are unloaded, and discarded. He picked a couple of likely suspects and brought them to a work night. We used the larger one. I carefully measured its diameter and used that in 3rd PlanIt to design the bullnose mounting plate.

We were a bit concerned about dimensional stability after the tube was cut to fit on the end of the backdrop – PVC pipe definitely is not dimensionally stable when cut. However, it appears cardboard shipping tubes have little internal stress, and this one refrained from warping, twisting, or expanding after we cut out the necessary 194.8° needed for the bullnose.

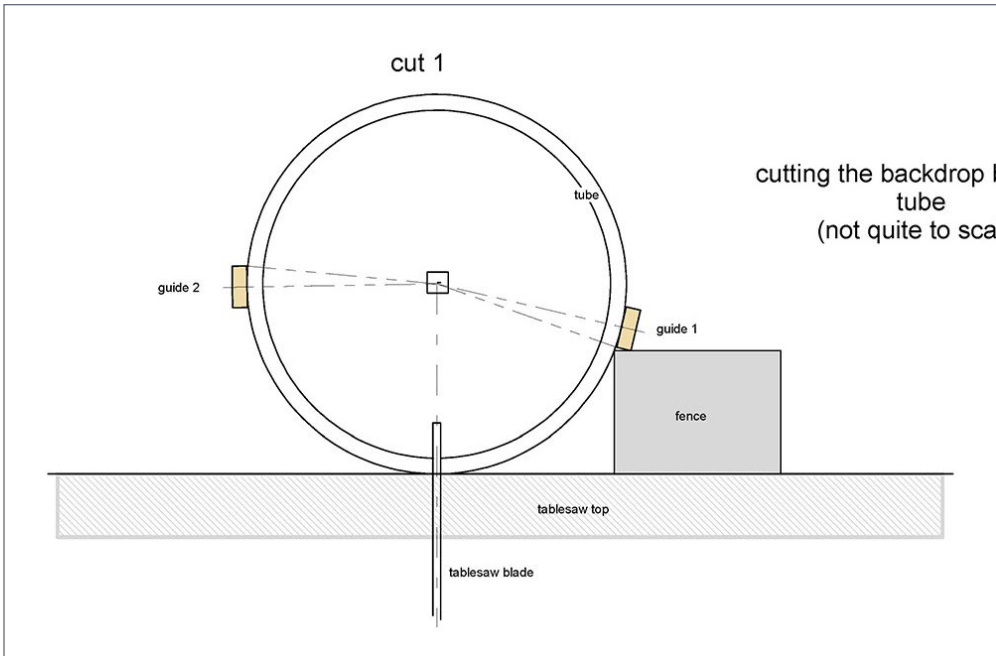

7. My CAD program and a bit of high school geometry showed that we needed to slice a 198.4° segment from the shipping tube. The question was, how? Ripping it on the table saw would most likely result in non-straight edges where it would attach to the bullnose mount. Something that would provide steady support was needed.

I came up with the idea of screwing cleats to the side of the tube, then sliding the cleat along the top of my table saw's fence. This required adjusting the fence so that with the tube against it, the blade would be cutting perpendicular to the tube. Two cleats would be needed. Placing them would require a bit of finagling to allow for the saw blade's kerf (width of the cut).

But could we measure out the angles needed? Because the tube was hollow (duh!), there was no way to precisely locate the center of radius and use that as the base for a protractor.

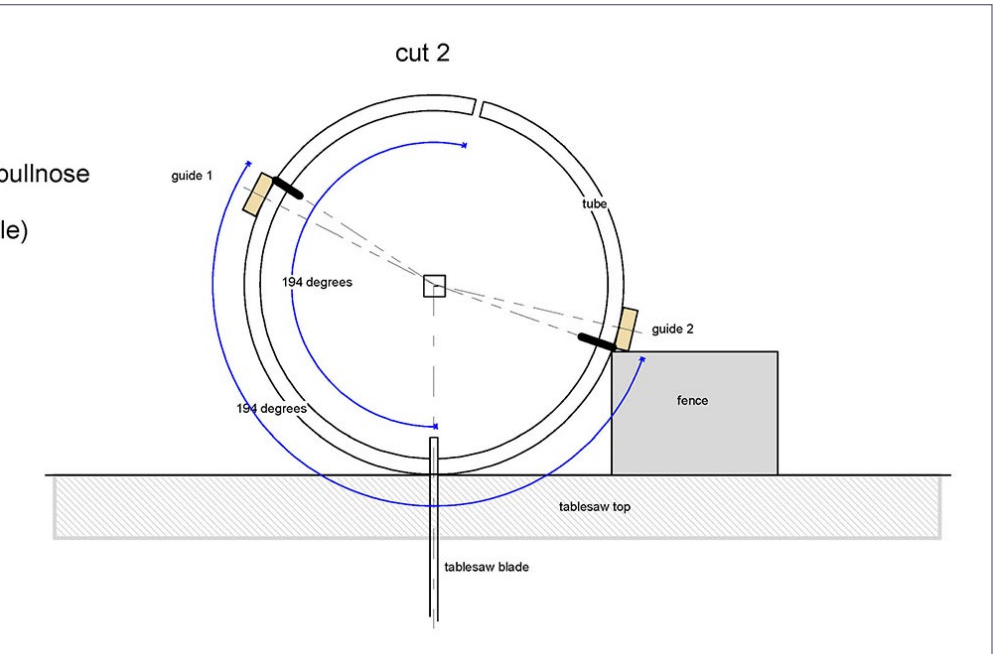

Your ad could
be in this space
for just \$168 a
month. *Click to
learn more ...*

ADVERTISEMENT

TamValleyDepot.com
Great Electronics for Great Model Railroads

Home of the Frog Juicer

We are loading up the boxcars with Frog Juicers ready for your layout!

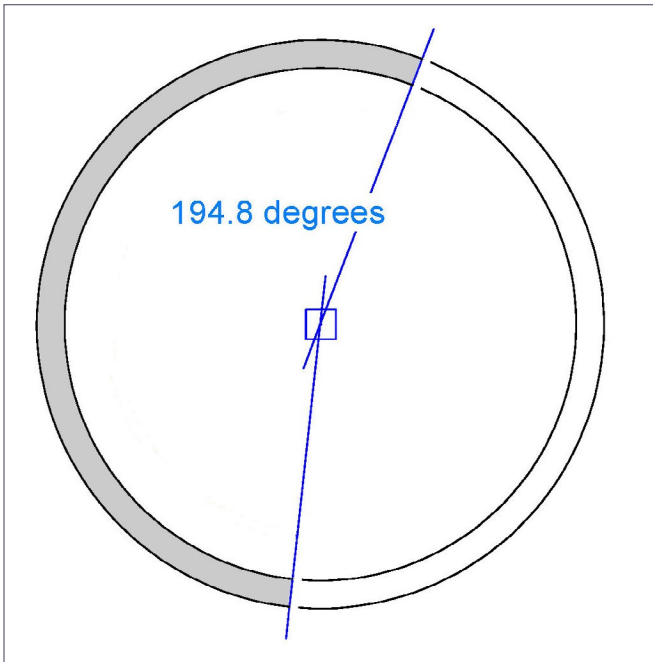

8. Once again I turned to 3rd PlanIt. I drew a pair of concentric circles the same diameter as the inside and the outside of the tube. Then I drew two lines from the circles' center, spaced the needed angle apart. I printed it full size and we stood the tube on end on

top of the template and marked where the two radial lines protruded on the tube. With the tube set on the table saw so it was against the fence, we used a straightedge to mark the angles on the other end of the tube and drew a line between the two sets of marks.

We used couple of 1/4" x 3/4" x 48" strips of wood for the cleats, attaching them to the tube using #4 flat-head wood screws. Then with great trepidation we cut the tube, resting the cleats on top of the table saw's fence to keep the cuts straight. It worked!

The final step was cutting the bullnose tube section to the correct length.



9. To tell the truth, I wasn't convinced we'd end up with a usable bullnose. You can see here that it did work – we placed one of the cut off ends of the bullnose against the mounting plate and it was less than 1/32" wider than the mounting plate on both sides. I can tell you this was a big relief!

The tube we used had a drawback – there were pronounced spiral grooves in it that would be clearly visible once it was installed and painted. I didn't want the bullnose to resemble a barber's pole, so I sprayed it with six layers of Kilz primer, sanding with a 60-grit sanding block after each layer. The spiral grooves were still visible, so I brushed on three layers of my sky blue latex house paint, using the sanding block after the first two layers. Success at last! The grooves disappeared.

UP THE CREEK | 15

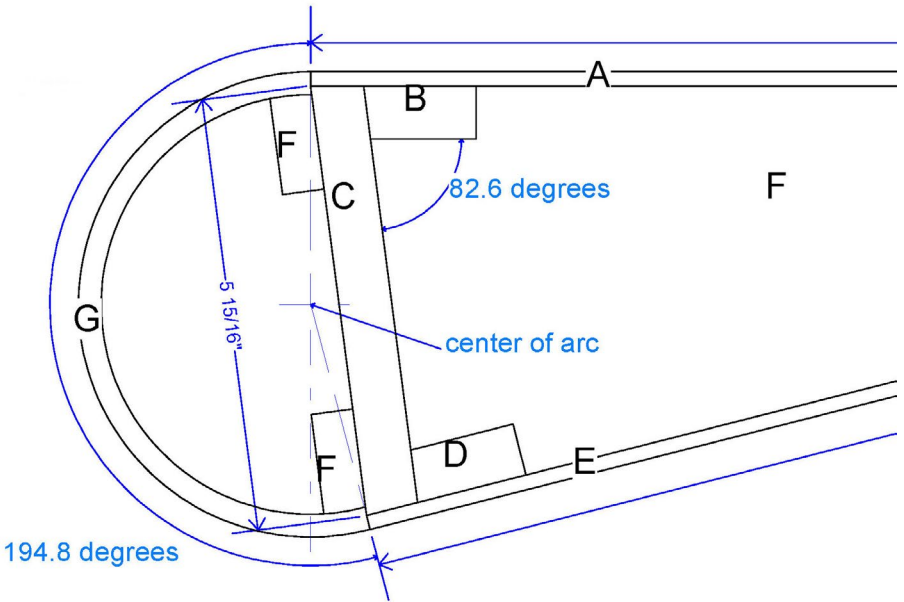

10. Now we needed to figure out how to attach the bullnose to its mounting plate. After much discussion we added two small cleats (F) on each side of the mounting plate's face, indenting them from the backdrop's surface a tad more than the bullnose tube's (G) wall thickness. We ran a large bead of construction adhesive up the edge of the cleats (F), spread the bullnose edges apart and pressed it in place.



[Click here for reader comments](#)



11. Remember that the bullnose was slightly wider than the back-drop? After scraping off the excess adhesive that oozed out of the seams, we covered the joints with blue painter's tape and temporarily screwed two pieces of 3/4" x 3" plywood

to keep the bullnose's surface lined up with the surface of the adjoining backdrop until the glue set. Once it was completely dry, we unscrewed the cleats, pulled off the painter's tape, and sanded down a few high spots. The seams weren't perfect, so we hit them (and the holes left by the screws that held the alignment cleats in place) with spackle. It took two layers of spackle before everything smoothed out. Two coats of sky-blue paint later, the seams (and holes) disappeared.

I still need to add clouds and hills and trees to the back-drop, but even in plain blue, it looks decent. The bullnose looks great, too.

12. This shot taken during my April 2015 op session shows the view seen peeking over the swing bridge at the entrance to the Bear Creek & South Jackson train room. The back-drop pinches down from the almost 7" diameter bull-nose to 3/8" thick, saving space for train stuff.

People entering the train room can no

longer see the entire aisle between Redland and Junction City. Crews report that the combination of the backdrop and the additional two miles of mainline on the peninsula make the layout feel a LOT bigger than before. They also like the





feeling of isolation from not being able to see everything at once, and it is definitely quieter during an op session than before. I think the bullnose looks much better than the end of a 3/8" thick backdrop!

From first train set to railroad empire...

*Our complete line of DCC products
grows with you. Discover the fun!*

- **Designed and manufactured in the U.S.A.**
- **Preferred for ease of use and ergonomic design**
- **Unlimited scalability for any size model railroad**
- **Plug-and-play means more time running trains**
- **Great customer service and excellent support**



See your dealer



Visit our new and improved web site for all your DCC needs!

- Get the latest new product announcements
- Watch our detailed how-to videos
- Browse the all-new Information Station
- Enjoy secure online sales, day or night!

Visit **ncedcc.com**





Southern Digital



**20% Discount
on most Items!**

Specializing in DCC Since 1992



DCC Conversions, Service & Support

Orders Received by 3:00 pm EST ship the same day

WWW.SODIGI.COM

E-mail: sales@sodigi.com

(770) 929-1888

(Photo's are from our N-Scale layout)



DCC IMPULSES

column

BRUCE PETRARCA
.....



[Click here for
reader comments](#)

DCC THROTTLES ...

E-MAIL FREQUENTLY PROVIDES ME WITH ideas for this column. Recently there was a question about throttles (also called cabs or handhelds) on one of the groups I monitor. This got me to thinking about them and I decided to share some of those thoughts with my readers.

The throttle is one of the most important considerations in DCC. It is the equivalent of the keyboard, mouse, and display of your computer, all rolled in one. Here's where you tell the DCC system what you want it to do, and it tells you what it is doing.

Frequently, a user's comfort level with the throttle drives their selection of DCC system brand. As I recommended last month (mrhpub.com/2015-08-aug/port), try all the various throttles for the brands of DCC system you are considering. What comes with a beginner's set may not be what you will want to standardize on for your eventual layout.

Very few throttles will work with more than one brand of DCC system. The ones that do work with different systems are

► DCC TIPS, TRICKS, AND TECHNIQUES

DCC IMPULSES | 2

usually third-party units and are frequently not as ergonomic as the name brand units. This is why it is important to be comfortable and happy with the throttles offered by your manufacturer. The makers will tend to keep the same models for many years with perhaps a feature adjustment along the way.

Let me say that there is no throttle that I personally find perfect. For operations, I own a Digitrax UT4R (radio) throttle and a NCE Cab-06PR (potentiometer, radio), as I frequently operate on layouts with both systems. My ideal throttle would combine features from both of them.

It is important that you like the throttle for your system and feel comfortable with it. Here are some features and ideas for your consideration.

ADVERTISEMENT



Econami™

SHIPPING NOW!

**Econami Digital Sound Decoders,
Designed With Value in Mind!**

- High-quality 16-bit sound and fun features starting at \$79.95 MSRP
- Easy-fit formats for N-G scales
- Sounds for Steam, Diesel, and Electric

Hear More!

SOUNDTRAXX®

MRHMAG.COM

- [TABLE OF CONTENTS](#)
- [INDEX](#)

Types of throttles

One of the important criteria is the way that you tell the system how fast you want the loco to go. Speed is by far the most frequently changed setting. Throttles tend to be grouped by the method of speed control. There are four basic ways of communicating speed desires to the system. I've been hoping someone would develop direct telepathy, but so far, no luck.

Potentiometer is a fancy name for the type of control that was used to adjust volume on radios a few years ago. They rotate about 270° and have stops at the ends. Throttles that use pots (short for potentiometer) usually have a line on the knob so you know where you are in the rotation.



1. Digitrax UT4D (duplex radio) potentiometer style throttle – direction selector switch is on the top left, here in the center-off (brake) position.

ADVERTISEMENT



New SmartFrog™ is coming

Let you rid itself of manual switching on your turnout frog
From now on, turnout Frog polarity change automatically is not a dream.
ANE MODEL New version SmartFrog™ Let your dreams come true!!

- Frog polarity change automatically
- Two LED output for turnout signal control
- Independent Operation or Connect SmartSwitch™ Interlock Control

DCC IMPULSES | 4

The advantages of a pot style throttle are:

- Quick, visual confirmation of your speed setting. Just look where the line is pointing.
- When using a throttle in “yard mode” (which I’ll discuss later), having a line showing you where the pot is positioned is helpful.

The disadvantages of pot style throttles are:

- The stops on the pots used in modern throttles are not as robust as those in classic radios. Heavy-handed operators can break them. You might ask about repair policies and costs for the brand(s) you are considering.
- When you select a loco with a pot throttle, the train immediately goes to the speed and direction set on the throttle. When you are running more than one train on a single pot throttle, the transition between trains can be interesting: instantaneous speed and/or direction changes

Encoders are increasingly used in volume controls and they have advantages in throttles, too. They go around and around with no stops, thus, there is no need for a line on the knob. It would be meaningless.



2. NCE Cab-06er (radio) encoder style throttle.

DCC IMPULSES | 5

The advantages of an encoder equipped throttle are:

- No stops to break.
- When moving between multiple trains, there are no speed or direction surprises.

The disadvantages of an encoder equipped throttle are:

- No direct indication of speed setting, unlike the line on the knob of a pot throttle.
- No indication when you have hit the end of the control area. With a pot, there are specific stops - you know when you hit zero or max speed. With an encoder, you wind up turning the knob counter-clockwise just to make sure you have set the speed all the way to zero.

Button control as the exclusive method of speed control is rare on throttles. Some high-end throttles have both knob control and button control. The two most popular throttles exclusively with button control are the Lenz LH100 [3] and the NCE Cab-05. I personally don't like button control for most running. On the rare occasion when I'm trying to hit a specific speed step, like the first step, I find buttons advantageous.

All of the exclusively button control throttles that I'm aware of use two



3. Lenz LH100 button control throttle – the down speed controls are circled, the up speed controls are the buttons on the right.

DCC IMPULSES | 6

buttons for each direction. One button (labeled V on the LH100 [3]) moves one step and the other moves several steps, for each direction.

Slider speed controls, while seen on some DC power packs, are rare on DCC throttles. Sliders are represented on WiFi connected smart phones and tablets. There are apps for both Android and Apple phones. The basic apps are free. The full-featured version costs a few dollars. The DCC system needs to be running JMRI and be connected to a computer and a WiFi hot spot.

The slider control in these apps is frequently a yard mode style, where the middle of the range is zero speed (as shown in [4]) and each end is maximum, either forward or reverse.

ADVERTISEMENT

Servo control with a touch

- Elegant Touch Toggle™ controls
- All plug-in system
- Super easy setup
- RC servo motor power

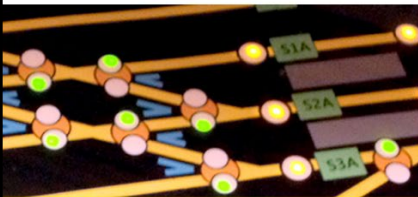

Now Touch Toggles for
Tam Valley and MRservo!

Servos, Stall Motors
Twin-coils, or Relays



Made in the USA



What will they think of next?

www.berrethillshop.com

MRHMAG.COM

- TABLE OF CONTENTS
- INDEX

Ergonomics, including knob orientation

How does the throttle feel in your hand? Can you adjust speed with the hand that is holding the throttle or do you need two hands? How easily can you read the display and from what angles? How easily can you access the function buttons? These are the ergonomic style questions for you to evaluate.

Bucking the trend of having the control knob stick straight out of the front of the throttle, the NCE ProCab [5], and the related PowerCab, both have the encoder mounted with its shaft parallel to the front panel with the edge of the knob sticking out.

Some folks feel that this is one of the most ergonomic designs available, yet others are turned off by the unorthodox design. Personally, I like it

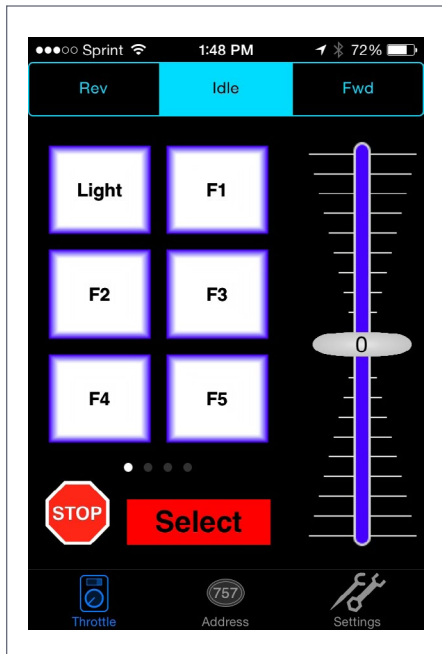

4. Slider style throttle on an iPhone using the free WiThrottleLite app.

Programming throttles vs. operator throttles

Most DCC systems have two levels of throttles, those that are aimed at operators and those with a lot more buttons and functions to program locos and set up consists. There is frequently a large dollar price difference between them, too.

Most layout owners have a limited number (perhaps one) of programming throttles, and more operator throttles. Several reasons are behind

this, including minimization of cost and keeping programming capabilities out of the hands of the entire fleet of operators. Frequently there will be a hostler job where consists need to be created or broken up. This job will need the programming throttle. Once the consists are built, they can be run on any throttle.

The NCE PowerPro system allows the user to tell the system what cabs can program locos and set consists as a way to minimize these problems.

Displays, consists and programming

A few of the operator level throttles display what the command station is doing, such as a confirmation of the loco direction. The NCE Cab-06 series [2] is an example of this style.

By necessity, programming throttles, such as [5] and [6], need to tell you what the command station is doing, so they



5. NCE's ProCab with the (encoder) speed control knob extending edgewise out of the front panel and speed control buttons, too, all in the SPEED box. Many folks comment on the very readable display.

Make Loconet wiring extremely simple!

ACCU-LITES, inc

Your DCC Center!

Dealer Inquiries Accepted

CELEBRATING
20
YEARS
ANNIVERSARY

PM42
breakout
board



SE8C
breakout
board



BDL168
Multi-zone
breakout board



BDL168
Single-zone
breakout board



Now Offering SNAPS! in packs of 6 or 12 pieces! [CLICK TO LEARN MORE ...](#)

ADVERTISEMENT

**IOWA SCALED
ENGINEERING**

Exciting and
affordable
sound player
for your model
railroad



[LEARN MORE >](#)



open source
hardware

MRHMAG.COM

ADVERTISEMENT



Installing DCC sound just **NOT** your thing?

Trust Traintek for sales and installation of sound decoders from these fine vendors!



RailPro™

"Taking model railroad control
to the next level ..."



traintekllc.com

Click here for more details...

"Traintek was the
way to go!"



- [TABLE OF CONTENTS](#)
- [INDEX](#)

have a display. Since they have a lot of controls and a display, they tend to be a bit cumbersome to hold. I have developed techniques to operate with either the DT400 series or the ProCab, but each took some getting used to.

In selecting a throttle, check out the display visibility when directly viewed and when viewed off angle. Take the time to understand what it is telling you and see how logical it seems.

Selecting direction and yard mode

There are two basic ways of selecting the direction of travel for your train:

- A toggle switch, such as on the Digitrax UT4 series [1]
- Push buttons, such as on the NCE Cab-06 series [2]

The advantage of the Digitrax method [1] is that there is a center-off position. You can “center your selector,” as they say in prototype diesel locomotives, and know that the loco won’t be told to move by a bump on the knob. The disadvantage of this sort of design is that it may be more difficult to operate one-handed.



6. Digitrax DT400 series throttle with two encoder speed controls (black knobs) and a small display screen – the duplex radio DT402D model is shown.

DCC IMPULSES | 10

The advantage of the NCE method [2] is that there is a button which will toggle the direction that can easily be pressed with the hand that holds the throttle. Some models have buttons for forward and reverse, so that you can make sure the loco will move in a desired direction. The NCE throttles also have an option for yard mode.

Yard mode is a fun way to switch cars. With a potentiometer throttle, the stopped position is with the pointer at 12 o'clock. When the pointer is at 7 o'clock, the loco is being told to run full speed in one direction. 5 o'clock is full speed in the other direction. I like switching this way. However, there is a learning curve. When things go a bit awry, the natural tendency is to rotate the knob fully counter-clockwise. This would be zero speed with a normal throttle set up. With yard mode, fully counter-clockwise is full speed in one direction.

Cutting the cord – wireless operation

Getting away from tethered operation usually enhances the operating experience. It is nice to not have to worry if you are plugged in to change speed or stop quickly. Another benefit is avoiding a tangle of cords.

Most DCC systems are available in wired and radio versions. If you don't start with a radio system, I recommend you investigate how to upgrade to radio should you decide to do so later. Digitrax and NCE both offer after-the-fact factory radio upgrades for their throttles. Both also offer the radio base units by themselves. So, converting to radio can be as simple as purchasing a radio throttle and a radio base unit and plugging the radio base into your throttle bus. And you may be able to have your existing throttles upgraded.

DCC IMPULSES | 11

The use of WiFi-connected smart phones [4] with a JMRI computer controlled layout is another way to easily add cordless throttles. Smart phones are frequently available for bargain prices, making for a very inexpensive way to have a bunch of wireless throttles.

Folks always seem to have additional ideas to share. Just click on the Reader Feedback icon at the beginning or the end of the column. While you are there, I encourage you to rate the column. "Awesome" is always appreciated. Thanks.

Until next month, I wish you green boards in all your endeavors.

Mr. DCC's Workshop on following page ...

ADVERTISEMENT

RailPro™
NEW TECHNOLOGY
DIRECT™
RADIO

RE RING™
ENGINEERING

NEW Starter Kit
\$399.99 MSRP

- Includes Wireless Color Touch Screen Handheld Controller and 56 Watt Power Supply
- Expandable to Virtually any Size Layout

NEW Locomotive Module
LM-2 & LM-2S

- Direct Radio RF
- Sound and Non-Sound
- New Tiny Size
- 6 Light Outputs

Click Here to Learn More

For more information visit our Internet site: www.RingEngineering.com



LokSound L -Premium Quality Low Cost DCC and Sound in O Scale!

Coming Soon in "Atlas O"

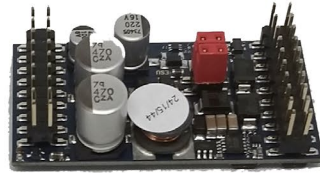

Each Decoder set
comes with Decoder
and Adaptor board



FULL FEATURED "LOKSOUND L SELECT"

ESU Item# 73399 ****ONLY \$149.99****

Shipping Now!

- Dimensions: 1 Inch x 2 inch
- Amperage: 3Amps continuous (up to 4Amps for a short time)
Overload Protected
- Function Outputs: 11(!)
- Servo Outputs: 2
- And More Features!

-
- Perfect for ESU Synchronized Smoke Units 54678 and 54679 with supported Sound Files
 - Smoke units will work with Steam and Diesel files
 - Smoke units can be set up to work with Smoke Chuff and Cylinder Steam!

**Click here for
MORE FEATURES ...**

Also Available: 54399 Fully Programmable LokSound L V4.0 199.99

ESU LLC 23 Howard Street Montoursville PA 17754 - 1-570-980-1980

www.LokSound.com

MR. DCC'S WORKSHOP

SOUNDTRAXX ECONAMI DECODER ...

Just as I started this column in mid-July, SoundTraxx announced a totally new sound decoder line. The Econami series (soundtraxx.com/dsd/econami/index.php) is the beginning of a new series of decoders to replace the aging Tsunami series.

The Econamis will be available in 1-amp and 4-amp versions, with \$80 and \$150 list prices. The 1-amp version will be available with two interfaces – wires and the 21-pin board that has become so popular amongst loco manufacturers.

They should be shipping by the time you see this in print. I plan to have a full review in a column very soon. ■



7. ECO-100 1-amp Econami decoder – 27 x 10.5 x 5 mm – \$79.95 MSRP.

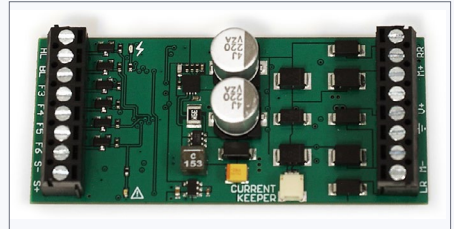

8. ECO-400 4-amp Econami decoder – 69 x 30.5 x 14 mm – includes a 3 watt audio amplifier – \$149.95 MSRP



[Click here for reader comments](#)

TONY'S TRAIN XCHANGE

Committed to your DCC support!

**Broadway Limited
HO ALCo RSD-15
Now In Stock**



With Paragon2 Sound & DCC,
Near brass-caliber detail at a
plastic price, Authentic
ALCo sounds in DC and DCC

\$199.95

Order Yours

**NCE DCC Systems
September Sale!**



Get a great sale price on all
the impressive NCE DCC
Starter Systems

**Call For Tony's
Sale Pricing!**

**TCS WOW! Diesel
Sound Decoders**



Also Available in 21 Pin Version
Now with sound files for
EMD 567, 645 & 710, Alco 251
and GE FDL16 & 7FDL16

Starting at \$84.95

Order Yours

**Do you need a Sound or
DCC Installation done?**

Get a quote!

**TONY'S
TRAIN
XCHANGE**
DCC SPECIALISTS

Providing unmatched person to person
DCC support for more than 25 years, the
kind of service that has made us #1 in DCC.

DCC questions? CALL US! 1-800-978-3472

*Mention this ad for \$5.00 off your next order over \$100!

We'll get you on the right track!

Aug 2015



MRHMAG.COM

- **TABLE OF CONTENTS**
- **INDEX**



Complete Train Control



Digitrax No Worries Warranty

That's it! A simple, straightforward warranty with no tricky language



You're protected against

Learn

Need tech support?

www.digitrax.com/contact

Need a repair?

www.digitrax.com

**NO WORRIES
WARRANTY**

Now Keeps Your Layout Running!

**For one year
or more!**

**Protects against
defects and accidental damage.**

Learn more at: www.digitrax.com/noworries

www.digitrax.com/repair

Need a throttle conversion?

www.digitrax.com/upgrade

Nano-Oil™

Made in U.S.A.



**New
Innovation**

Nano Technology Lubricants

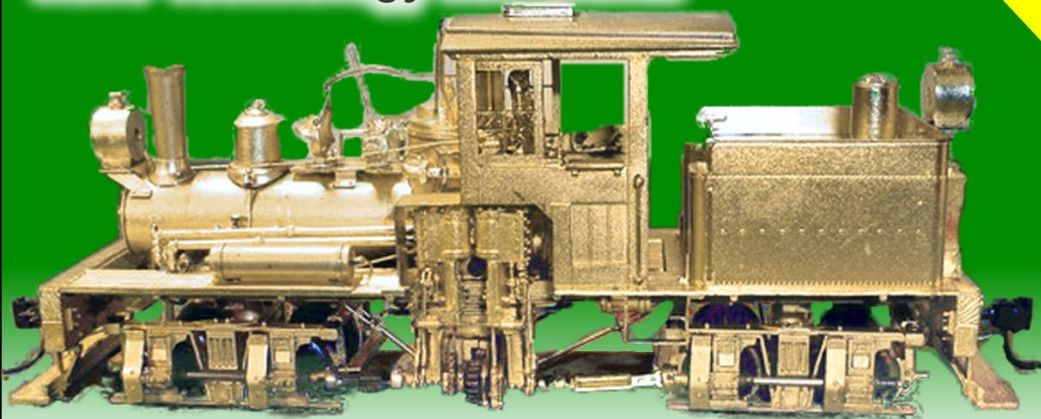

"After eight years of extensive testing, the only lubricants now used in my shop are Nano-Oils and Nano-Grease. The extreme reduction in power draw by mechanically minimizing friction is simply technologically superior."

- Phil Floyd, 'The Shay Fixer'



Nano-Grease

**For more details
click here ...**



THE SHAY FIXER



VISIT US AT...

SHAYFIXER.COM



Specializing in brass Pacific Fast Mail / United geared locomotives

MRHMAG.COM

- [TABLE OF CONTENTS](#)
- [INDEX](#)

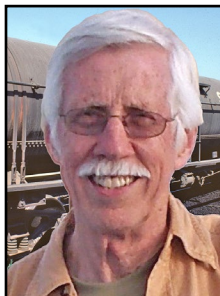

TONY THOMPSON
.....

GETTING REAL

column



[Click here for
reader comments](#)

TWO GOOD WAYS TO CONVEY YOUR MODELING ERA

IN ONE OF THE FIRST COLUMNS IN THE *MRH* “GETTING Real” series, back in November 2011 (mrhmag.com/magazine/back-issues), Jack Burgess discussed the process of choosing a date to model, and ways to reinforce that choice, in terms of the things you place on the layout. Among an extensive discussion, he mentioned that automobiles are among the most familiar objects that anyone can date, whether they are modelers or casual visitors to a layout, and therefore that automobiles must be model-year consistent for your chosen era. Obviously they cannot be cars of a model year later than your modeled year, but can represent a fair range of previous years. Jack emphasized that cars should also have license plates, and mentioned billboards as period setters.

I want to expand on these points, because I believe there is more to be said. I also want to explain a little about how I

▶ **MODELING REAL RAILROADS AND WHAT THEY DO**

GETTING REAL | 2

have done some of these things, just to show that multiple approaches are possible. This includes modeling procedures. I'll begin with billboards.

Billboards

Period advertising can be as revealing of an era as anything you can place on the layout. Some modelers have papered the sides of their buildings with posters which may fit with some eras, but were not often seen in the time I model, the 1950s. But roadside billboards, on the other hand, have been with us a long time, and have the advantage of providing bigger images.

The first challenge may be the billboard structure itself. For some years, Walthers offered a nice set of three roadside type billboards, their number 933-3103 and related numbers for

ADVERTISEMENT

Railroad Explorer Magazine

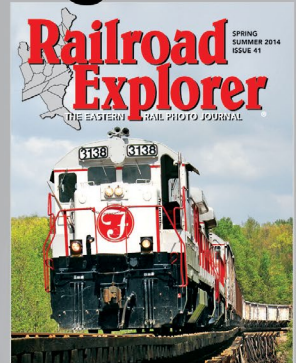
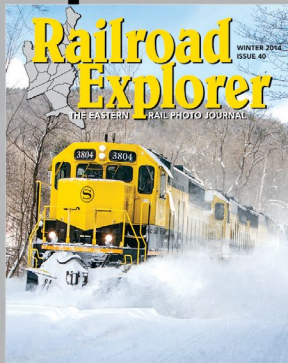
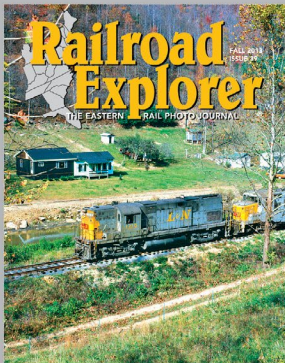

THE EASTERN RAIL PHOTO JOURNAL

- Three all-color issues per year. Exciting feature stories and spectacular photos of Eastern Railroading
- Best-in-class photo reproduction. Printed on heavy, glossy paper. Zero advertising.
- Three times per year - Winter, Spring/Summer and Fall editions.

Subscribe today!

www.railroadexplorer.com

MRHMAG.COM

- **TABLE OF CONTENTS**
- **INDEX**

GETTING REAL | 3

various periods, but these kits have apparently been replaced by the number 949-4250 sign kit. Other kits for billboards have been available over the years, but I won't review them, because these structures are not at all hard to scratchbuild. I show a scratchbuilt example in [1] and [2].

The board itself is styrene sheet, with vertical posts and rearward-angled diagonal supports. Each post also carries a horizontal member, tying the post to the diagonal and extending forward to support a walkway for sign posters to use. Lastly, a horizontal tie also extends across the back of all four diagonals.

As for dimensions, I have used both scale 4 x 4-inch and 6 x 6-inch posts, and 2 x 6-inch diagonal supports. If the posts run to the top of the board, as you see in [1], the diagonals can tie into them at the top. An advantage of making a billboard



1. One design of billboard structure, built from scratch in HO scale, using styrene strip and sheet. The criss-cross bracing below the signboard was seen only on some boards.

GETTING REAL | 4

structure this way is that you can suit its dimensions to an item of advertising you want to use.

Once you have a structure, whether scratchbuilt or from a kit, the second challenge can be the signs to place on your billboards. Almost any Google search on this and related topics will return a lot of images, some of which can be downloaded and adjusted in size for HO scale billboards (more on that in a moment).

Commercial billboard reproductions also abound, especially from JL Innovative shop.jlinnovative.com/HOScale-Signs-Billboards_c25.htm and others, such as City Classics cityclassics.biz/window_signs.html; scroll down to billboards. But you can readily find your own. I show later in this column some of the images I was able to find on the Internet and adjust for my use.

In choosing advertising, it may not always be obvious from which era or year the image comes. Here again, Google



2. The same billboard shown in [1], but from directly above. Here you can see the walkway below the signboard, as well as the rear support structure.

GETTING REAL | 5

searching in company histories or product histories can often reveal answers. A second point to consider is the choice of regional brands. National brands such as Coca-Cola, Shell Oil, Ford Motor Co., or Nabisco certainly have their place, but regional brands help set your location in a particular part of the country. As my layout is set in California in 1953, I want to use plenty of regional images among my billboards.

My modeling time was in the period of largely unrestricted billboard use. After the passage of the federal Highway Beautification Act of 1965, not only were billboards strongly restricted along Interstate highways, but state and local authorities went on to add further restrictions on size and numbers of



3. An example from outdoor advertising giant, Foster & Kleiser, of one of their first 12 x 25-foot billboards in 1925. The lattice beneath the sign was common in cities.

billboards. Older billboard structures (except along Interstates) were often grandfathered, however, and there are areas where quite old billboard structures remain today. The result is a wide mixture of sizes in use.

This raises the topic of the size and proportion of the billboard images you wish to use. Commercial sources, as well as images you can find on the Internet, probably will not be the correct size or proportion for any particular model sign structure. It may be worth mentioning that the Walthers signboard does not appear to be a common prototype proportion. It has a space, in HO scale, which accepts an image of 10 x 22 feet. The first standardized billboards, early in the 20th century, were 10 x 25 feet (known in the advertising business as a “24-sheet poster,” for the number of printed paper panels comprising the entire image). Another common size in the 1950s was 12 x 25-foot size; an early example is shown in [3].

Most prototype boards had a higher proportion of height to width, compared to the Walthers board, such as the prototype 10 x 30-foot boards (a “30-sheet poster”) which became popular in the mid-1950s. But a variety of sizes was erected for custom signs, so some variation is all right. Certainly the Walthers version looks acceptable as layout scenery.

As I mentioned above, with a scratchbuilt billboard, you can suit it to the image you want to attach. Another approach is to standardize on the Walthers 10 x 22-foot size. Advertisements of other proportions, if not *greatly* different, can be distorted to the 10 x 22 proportion using Adobe Photoshop or comparable software.

Simply uncheck the box for “Constrain Proportions” in the “Image Size” dialog box, then make the image the size you want.

Heckman's Canadian Pacific A Photographic Journey

by Ralph Beaumont

Joseph Heckman was a pioneer photographer for the Canadian Pacific Railway. He photographed the line from coast to coast between 1898 and 1915, capturing the engineering works, stations, hotels, steamships, and the people who made the railway run. More than 4,000 of these historic images are preserved in the CPR's Corporate Archives, and 380 of them have been made available for this large format, hard cover book.

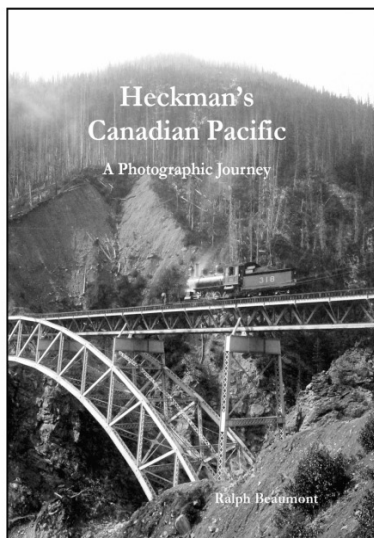

\$60.00 + Shipping & GST

ISBN 978-0-9784406-1-9

Large 9 x 12 format

Hardbound

328 pages - 380 B&W Photos

25 Maps, Index, Bibliography

Available June 2015 from:

Credit Valley Railway Company

2900 Argenta Road, Unit 24

Mississauga, Ontario, Canada, L5N 7X9

Canada/USA Toll Free: 1-800-464-1730

Online at: www.cvrco.com

MRHMAG.COM

- [TABLE OF CONTENTS](#)
- [INDEX](#)

GETTING REAL | 8

In HO scale, this is 1.38 x 3.03 inches, and for some purposes, this degree of precision really is required, as noted below.

Note in [3] that there is considerable white space around the advertisement itself. This was common in the 1950s and earlier, and offers another strategy in modifying the proportions of an image: simply add or subtract white space to make it fit.

The Walthers kits each supply six or more billboard images. Many are for Eastern companies, and some are from later eras than the 1950s. Accordingly, you may need to look elsewhere for appropriate regional and era-correct images. I searched on the Internet for some time, finding all kinds of varied billboard and other advertising images, and I found online resources which could in many cases provide the year or years when the image was used. Though many of the online images are copyrighted,

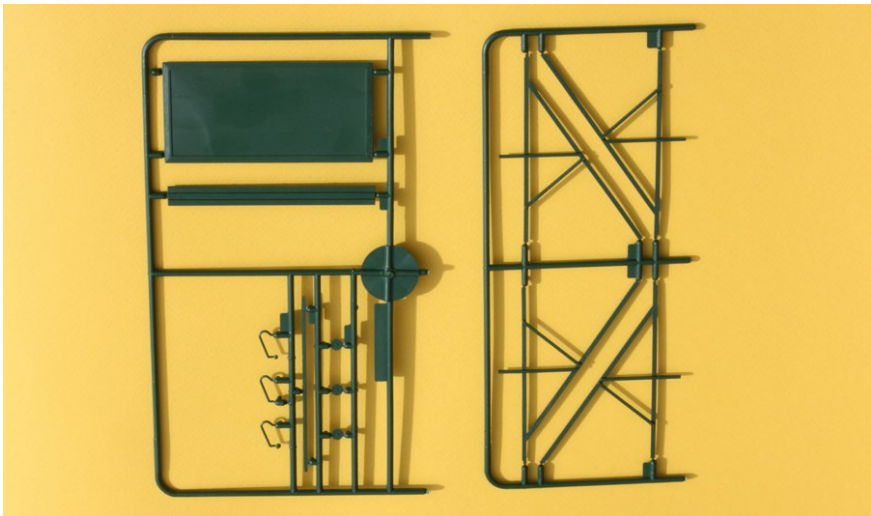

4. This is a Walthers billboard (kits have three). The sprue on the left contains the signboard, walkway, back brace, and floodlights (optional: many billboards had no lights). The sprue on the right contains all four support members.

you are permitted to download and print them for your own personal use.

Interchangeable billboard images

A key idea with billboards, should you wish to do so, is to provide for interchangeable advertisements. I had this idea simply because I found so many billboard images I wanted to have on the layout, that I realized I needed a way to display more than one per billboard. You might, for example, have different billboard images every time you operate, if you like. After all, they were periodically changed on the prototype, too.

It turns out this is really easy to do. I will illustrate it on a Walthers kit signboard. First, [4] shows the Walthers sprues for each billboard. I simply add a strip of scale 1 x 6-inch styrene



5. The Walthers signboard, still on its sprue, with scale 1 x 6 styrene strips attached. You can see on the left edge how the added strip is positioned just at the top of the slanting edge of the sign area.



6. The Walthers billboard assembled, with the added white styrene side strips obvious.

along each side. I show in [5] the addition of these side strips to a Walthers signboard. On a scratchbuilt billboard, I have put scale 4 x 4 styrene strips around the bottom and sides of the image space, then added the 1 x 6 to project inward, just as on the Walthers board.

To show an assembled billboard, [6] illustrates the Walthers board (with reduced-height supports, as kit directions advise), and with the side strips not yet painted. The billboard can also be built to its full height, if needed to suit your layout location.

Then, if the advertisements are accurately 10 x 22 HO feet, they can slip right into the board, and are readily removed so others can be substituted. (This is the reason you may need to achieve exactly the correct size images, as mentioned above). The substitution process is very simple. [7] shows the use of tweezers,

GETTING REAL | 11

but with a little practice, the ads can readily be inserted or removed with your fingers.

Finishing a billboard can be simple. These signboards were often dark green; I have also seen white and dark gray ones. If you are so inclined, you could also add the name of a sign company along the top or bottom of the signboard. Most billboards in an area were built and managed by a sign company, which in turn contracted with ad agencies for use of the billboard space. These companies often identified themselves on the billboard structure.



7. In this photo, I am demonstrating the insertion of an advertisement into the Walthers signboard, still on its sprue, see [5], with added side strips. The tweezers shown being used are not essential for this job. The period Signal Oil and Gas Company ad shows a familiar Signal slogan of the 1950s; Signal was a California oil company until its merger in 1964 with aerospace parts manufacturer Garrett Corporation.

Throughout the West, many roadside signs were managed by Foster & Kleiser, and I have put that name on some of my billboards. [3] shows the Foster & Kleiser name at top, see [8]. Another familiar billboard owner and operator was Pacific Outdoor Advertising, especially in southern and central California, and I have used that name also. Both are shown in [9].

A few examples of usage may be of interest. In [10], I show a strong era-setting image, an ad for a new automobile model,



8. A typical example of a Foster & Kleiser nameboard.

Want to keep MRH free?

CLICK on ads.

If ads in MRH don't get clicks, then advertisers won't advertise with us, it's that simple ...



9. These two billboards carry names of outdoor advertising companies, Foster & Kleiser on the upper board and Pacific Outdoor at the lower one. Public service ads, like this one for the Navy, were often seen in the 1950s.



10. This billboard carries an advertisement for the new 1953 Chevrolet. Few things can set your era more clearly than a specific date on a billboard. Below the sign, patrons of the Dolphin & Anchor Tavern are enjoying the fresh air.

and in [11] a Western beer company ad. Both these billboards are built to exchange ads. To show that more clearly, [12 and 13] show the same billboard structure with two different ads in it. To repeat what I said earlier, ads on prototype billboards changed periodically, so yours probably should, too.

Among the advertisers I have chosen to feature are Western beer brands (Lucky Lager and Acme), Western oil companies (Signal, Associated, Union, Richfield, and Chevron), and iconic Western clothing (Levi's jeans). One great era-setter is either a poster from a specific political campaign year, or for the introduction of a new model automobile; [10] shows the 1953 Chevrolet. Finally, ads from companies like Coca-Cola were ubiquitous, and I included a couple of them, too.

GETTING REAL | 15



[Click here for reader comments](#)



11 [previous page, top]. This particular Walthers billboard structure has been assembled full-height, something that may be suitable for some locations on a layout. The slogan used by Lucky Lager (previous page) may be a teeny exaggeration. Lucky Lager Brewing was headquartered in San Francisco, and in the 1950s became the best-selling Western beer.

12 [previous page, bottom]. Emphasizing another regional characteristic is this advertisement for Levi's clothing (previous page), with a slogan they used extensively in the 1950s, "as Western as the West itself." Levi Strauss & Company, of course, is still in business and still headquartered in San Francisco.

13 [above]. The same billboard structure here hosts an ad for Associated Oil Company, and their Flying A marketing brand. By the 1950s, Associated was the Western part of Tidewater Associated Oil Company, but continued consumer marketing under its own name.

A word on copyright and trademark. Some of these advertisers controlled, or attempted to control, use of their trademarks and images, even ones dating back 50 years or more. But using an image from a book or the Internet, copied only for your personal use, does not violate copyright. Publishing such images for general use would be another matter, which is why I am not supplying scale-size billboards for your use.

License plates

Even though license plates on HO scale vehicles are quite small, we are all familiar with their appearance and location, so that omitting them is more evident than you might think. They are not hard to create and apply, and gradually I have attached them to all motor vehicles on my layout.

Right from the beginning of the automobile age, each state issued motor vehicle plates, which for many years were quite distinctive, differing not only in color, but in size and proportion. The history of these plates is of interest not only to model railroaders, of course, but to everyone from local historians, to car restoration people, to nostalgia buffs of all kinds. So we modelers benefit from the work of many.

There are excellent resources on the Internet about vehicle license plates for all states and all eras. It is worth spending some time to find information on your modeled state and era. My own modeling is set in California, and there is a useful and quite complete Wikipedia entry about history and use of California plates, including my modeled year of 1953 see: [en.wikipedia.org/wiki/ Vehicle registration plates of California](https://en.wikipedia.org/wiki/Vehicle_registration_plates_of_California). Many state Departments of Motor Vehicles also have online license plate histories.

GETTING REAL | 18

In addition, there is a website offering reproduction plates for many states (and countries) and many years, available at: licenseplates.tv/index, and this site not only has a lot of history for a wide range of states and eras, but also has good images of license plates to view. The site used to include California plates among all the others, but for some reason it does not do so now. If that's what you want, you might check back from time to time to see if they are restored to the site.

It is worth mentioning that many “antique” or second-hand stores will offer a few old license plates for sale. I had been casually looking for these, and found a 1951 California plate, shown in [14]. As the history recounted below explains, this turned out to be an excellent find. But in any case, it can be fun to keep your eyes open for suitable plates of your modeling era.

But for whatever state you model, or whatever year, you can have accurate automobile and truck license plates—if you wish. Obviously if you model “the 1950s,” there is no license plate that



14. Actual 1951 California plate, a little the worse for wear but clearly showing letters and characters.

GETTING REAL | 19

fits the whole decade, and you might just as well use little dark rectangles with no lettering, or even omit license plates altogether. But if you want to have actual plates, it may be helpful for me to describe how I made mine. First, the history.

The basic facts are that until 1942, California issued complete new plates every year. Then from 1945 into the late 1950s, new plates only came out every several years, and metal corner tags were issued for each intermediate year. This corner tag covered up the year stamped in the original plate, and contained the current year. For automobiles sold in intermediate years, small numbers of new plates, stamped with the current year, were produced.

Turning to my own modeling year of 1953, as it happens, California had issued a new plate in 1951, which was black with yellow numbers. (This, of course, is the exact plate I found, shown in [14].) In 1953, a lower-right corner tag of stamped metal was issued, white in color, with the number “53” on it, covering up the “51” part of the year on the original stamped plate.



15. In 1953, owners of plates from previous years 1951 or 1952 were issued a white corner tag, which was attached at the right-hand bolt hole in the original plate.

GETTING REAL | 20

Thus by 1953, most plates were 1951-issue, with small numbers of 1952 and 1953 new plates, and all 1951 and 1952 plates carried white corner tags for 1953. But because of the new plates issued in 1953 which did have the 1953 date stamped in, I need a mixture of some new 1953 plates, and a lot of corner-tag plates, since all cars older than 1953 would have the 1951 plates with corner tags.

To illustrate, [15] shows an image of a California plate with a 1953 corner tag. This could be a 1952 or, more likely, a 1951 plate, with the 1953 tag.

The format of numbers and letters shown in [15] is typical. In that era, there was also a format for what were termed “commercial” vehicles, such as delivery vans owned by businesses (today that distinction has disappeared). These also had yearly corner tags (for the same reason as automobile plates), as [16] shows.

Finally, vehicles classified as trucks, whether or not used commercially, such as pickup trucks or business-owned highway trucks, received still another different plate in California in those



16. Vehicles classified as “commercial” used plates with this format in the early 1950s.

years (and still do). [17] shows an example for 1953. Today, all commercial vehicles in California receive a plate descended from that shown in [17].

For modeling purposes, I need to use all of these formats, as appropriate for individual models. I wanted also to have a few out-of-state plates among all the California ones, though in 1953 I would guess these would have been uncommon where I model, along California's Central Coast, fairly far from the main tourist areas. Examples might include [18], a Colorado plate for 1953, with a nicely contrasting shape and color, compared to the California plates, or Arizona, shown in [19].

Finally, small numbers of new cars, or cars which had new licenses in 1953 had to be issued 1953-stamped plates. An example is shown in [20].

You can readily find on the Internet the dimensions of license plates for any year in any state. In 1951, the California plate was 6 by 14 inches, which I can verify from my original 1951



17. Most trucks were issued plates like this, with a single letter of the alphabet leading all digits. This is still California practice, though today a number precedes the single letter.

plate. In HO scale, this is one-eighty-seventh as big, or about 0.07 by 0.16 inches.

Once you acquire digital images of plates, then, simply reduce them to these dimensions (other states and other years had



18. The Colorado 1953 license plate, one example of an out-of-state plate that might have been seen in California at the time.



19. Another obvious out-of-state plate for Central California might be Arizona, unfortunately a black and white plate in 1953 and thus not very distinctive in HO scale.



20. New cars, or cars newly licensed in 1953, received plates without corner tags. They looked like this. I have applied a few such plates on my layout.

different proportions of width to length). I recommend setting the resolution to 2000 dpi if you can do so, since otherwise they will not be readable. I collected a range of desired plate images, placed a whole bunch of them on a single layout page, and had them printed on glossy paper at my local copy shop, which has a high-resolution digital color printer. Once printed, they can be quickly cut out and glued onto your model trucks and automobiles. For this kind of job, I like to use canopy glue.

License plates on model vehicles

A few photographs of some of my HO vehicles with their license plates will show what I am trying to accomplish. A group of parked cars as in [21] “looks right,” with every one carrying a California license plate. [22] shows that they are indeed readable. And for the truck license plates, I show [23], following the format of [16]. [24] shows one of the “com” plates on a delivery truck.

I know there are those who regard the whole topic of HO-scale vehicle license plates as rather excessive refinement, but I



21. A group of cars is parked at right, all with correct California plates for 1953, while the drivers get a cold drink or a burger at the Giant Orange stand. At left, the tourists pulling a trailer have an out-of state plate, showing that they have come all the way from Pennsylvania. Their plate is, of course, correct for 1953.

ADVERTISEMENT



Announcing
Motrak Models Flat Paint
Made by Scalecoat:

Rail Brown – White – Black - Silver
Aluminum – Oxide Red – RR Grime #1
RR Grime #2 – Boxcar Red – Roof Brown
Aged Concrete – Dirt – Sand - Rust
MOW Gray – Engine Black

Limited quantities - place your order now!
We still have other colors available from Scalecoat.

Phone number: 813-476-4784
Email: motrakmodels@centurylink.net

**CHECK
IT OUT!**

GETTING REAL | 25

have found it fun to research, learn about, and create accurate automobile and truck license plates for my modeled era and locale. The specifics of my 1953 California plates are presented only to illustrate what can be done if you wish. Locating the desired information is itself engrossing, and license plates are yet another topic where “Google can be your friend” in the search.

Photos continued on the next page ...



[Click here for reader comments](#)



22. A closer view of one of the automobiles shown in [21] shows that the plate is indeed readable. Since the model represents a 1953 Chevrolet, its plate is naturally a new 1953 plate with no corner tag. Luckily we don't usually see model vehicles at this size, revealing the limitations of its resin casting.



GETTING REAL | 27

23. The pickup truck, with 1953-tagged license plate Y 63075, is about to pass an automobile with a new plate. Both are off-center on their respective bumpers, something more common on earlier cars than on more modern ones, which almost invariably have centered plates. In the background is yet another interchangeable billboard.

24. This delivery truck has a "com" or commercial plate. Though in use in 1953, this type of plate has not been issued in California for some years. The truck delivers from the Associated dealer on my layout.



[Click here for reader comments](#)

YD 
Yankee Dabbler.Com

- **Kadee**
- **NCE**
- **Digitrax**
- **SoundTraxx**
- **And more!**



Save On All Top Brands!



HO

DCC 

ALL SCALES

NEW!

MRH 2016 Calendars!

Especially for model railroaders

~~\$18.88~~ **\$16.99**

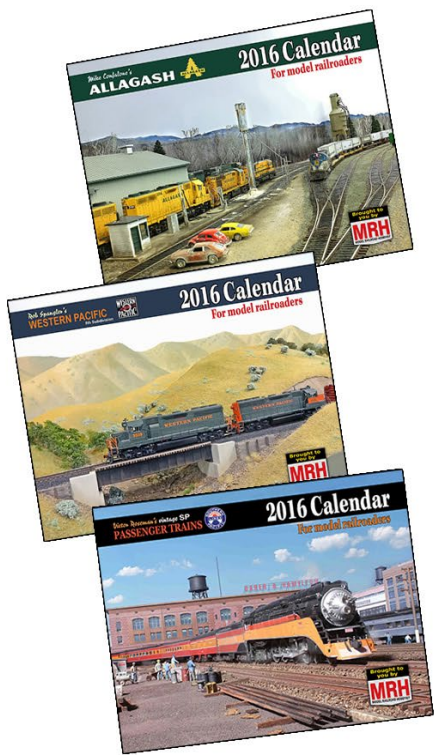

Has major model railroading events listed!



2016 JUNE

One half of Maine Central's "Tee" of two A&A ES11s teams up with an Allagash #322 on an evening wood chip train seen on the grade at Hobson Mountain. The train is about to enter a deep rock cut as it struggles toward the summit in March 1984.

Sunday	Monday	Tuesday	Wednesday	Thursday	Friday	Saturday
	May 1 2 3 4 5 6 7 8 9 10 11 12 13 14 15 16 17 18 19 20 21 22 23 24 25 26 27 28 29 30 31		1	2	3 MLK regional bank holiday	4
5	6	7	8	9	10	11
12 Shennet	13	14 Ring Day	15 Sabine Ave, NC P&W regional Jun 15-19	16	17	18 Richmond, CA Bay Area NP&W Jun 18
19 Father's Day	20 1st day of summer	21	22 Arlington, TX Low-Rail regional Jun 22-25	23	24	25
26	27	28	29 Kansas City, KS National V.Com. Jun 29-July 3	30		July 1 2 3 4 5 6 7 8 9 10 11 12 13 14 15 16 17 18 19 20 21 22 23 24 25 26 27 28 29 30 31

Mike Crawford's
ALLAGASH 

Buy your 2016 calendar NOW

store.mrhmag.com

Includes download link for free wallpaper of the images!

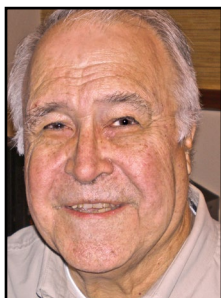

LITE AND NARROW

column

LARRY SMITH
.....



[Click here for
reader comments](#)

THE WOODWARD IRON RAILROAD | A SPECIALIZED RAILROAD YOU CAN MODEL ...

LIFE AND DEATH OF THE PROTOTYPE

MODERN SHORTLINES BEAR NO RESEM-

BLANCE TO their predecessors of the last century and before. Beginning in the 1980s with the deregulation of the railroads, leading to the four mega-railroads we have today and their ability to abandon or spinoff the less profitable branches, we have had the rise of shortline holding companies. Some well-known names, Genesee and Wyoming, and less familiar names, Watco Industries, now own and control over 60 shortline railroads. This results in a homogenization in paint schemes and identities of the individual shortlines. This isn't necessarily a bad thing, as it has saved many communities from the loss of vital rail services. What we have lost is the oft-times quirkiness of the local shortline.

Up until the late 1960s there were hundreds of shortlines in

▶ [RAMBLINGS ON THE NARROW GAUGE](#)

LITE AND NARROW | 2

the United States. Some of these were very long and served many different industries along their route. Others served one or two industries, while still others were captive to an industry. The former shortlines are still in business, owned now by holding companies, and the latter two have pretty much disappeared as demand for the product vanished. Such was the case with the Woodward Iron Railroad that survived until the late 1960s. Today there is very little remaining of a once very busy shortline.

History

To understand how the Woodward Iron Company (WICO) came into existence, you have to look at the geography and the geology of the Birmingham District. Located at the tail end



1. Aerial view of the Woodward Furnaces celebrating 75 years of service by the Southern Railway. From an article published in January, 1959 *Ties The Southern Railway Magazine*, and posted on southern.railfan.net .

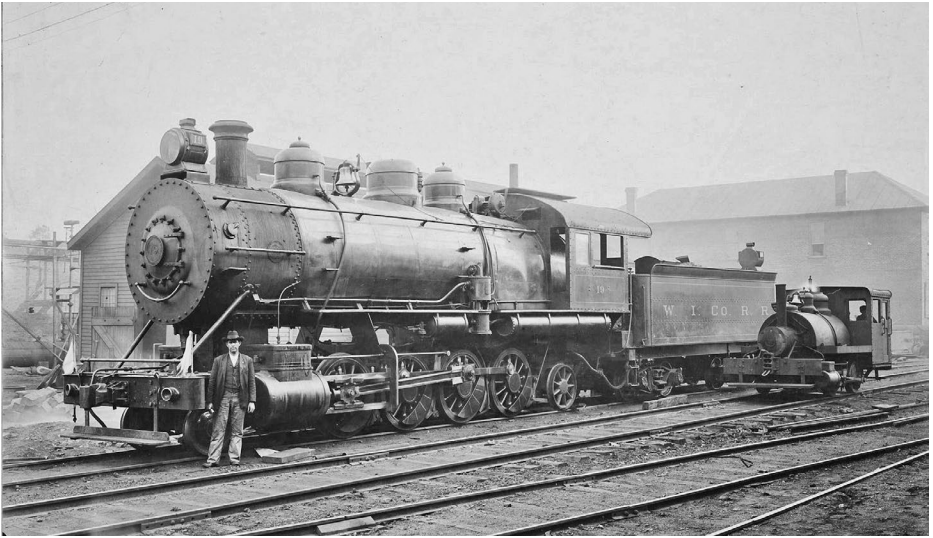

2. The engine on the right is one of the H. K. Porter 0-4-2Ts, either the #2 (Built June, 1882, construction # 498) or the #6. *John Stewart Collection*

of the Appalachian Mountains, the Birmingham District was blessed with being one of the few places in the world where the three necessary ingredients for making iron, and later steel, were in close proximity to each other. To give an idea of how close they were, it was said that when the Woodward furnaces were in operation, you could go to the top and see the mining operations for both the iron and coal. While not needed by Woodward, the furnaces were self-fluxing; the property with the limestone deposits was also visible. Because of this closeness and ease of obtaining the natural resources, the Birmingham District has had some kind of iron production dating back prior to the Civil War. Ironically, some of these early furnaces have been restored and are in state parks, while facilities that were built much later have vanished from the landscape.

LITE AND NARROW | 4

The story of the Woodward Iron Company actually begins in Wheeling, West Virginia, where, in 1849, the Belmont cut nail mill was established by E.M. Norton, under the company name

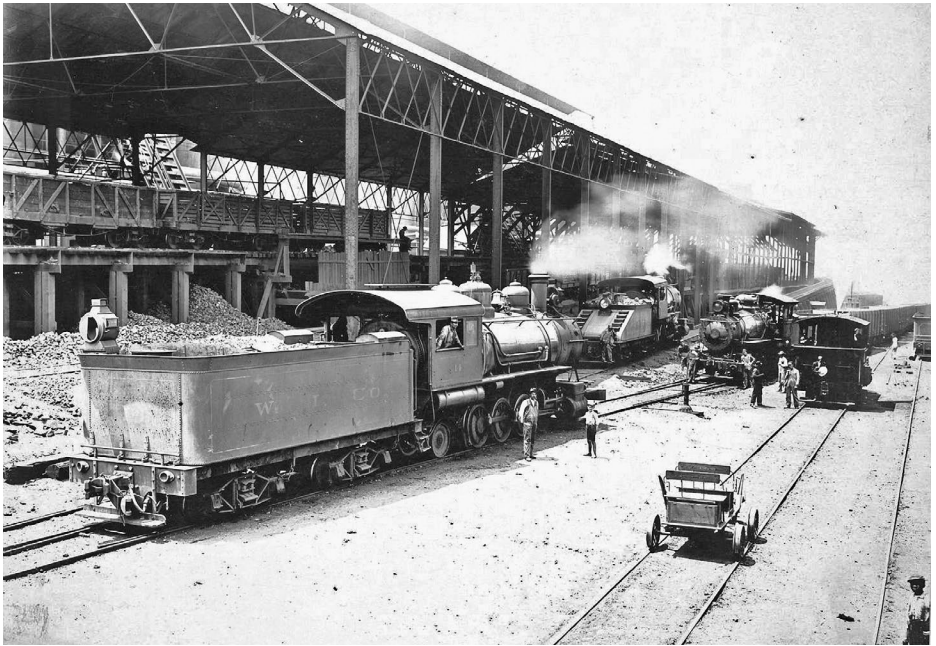

3. No.14 and friends at No. 3 stockhouse c. 1910. The engine with the slope-back tender facing the photographer is the #9 (built by Baldwin, December, 1898, construction #16389), the only one of WICo's 0-6-0s that was actually built for use at the Woodward furnaces, and spent its entire life there. The #9 was sold to Birmingham Rail & Locomotive for scrap in December, 1938. At far right in the shop panorama is the #10 (Built by Baldwin, May, 1900, construction #17773), Woodward's only 2-6-0. They eventually sold the #10 to the Woodstock Slag Corp. for their operation located just behind the WICo furnaces. It lasted until 1946. The #10 was the original "heavy" stockhouse-trestle engine for Woodward. *John Stewart Collection*

of Norton, Bailey and Company. Among the employees at the Belmont mill was S.H. Woodward. Woodward was a nailer at the Belmont mill, and probably came to the mill from either the Virginia mill or the Top mill, both being established in 1840. A nailer was a highly skilled individual, who along with a puddler, was the highest paid in the cut nail mills and thus could afford to invest in them. A nailer's job consisted of maintaining and repairing the nail machines, grinding and sharpening the nail-cutting knives, and making the dies associated with the nail machines. A puddler was a highly skilled individual who manipulated molten pig iron in a puddling, or reverberating, furnace to remove surplus carbon from the pig iron. The process involved the puddler to use long bars to manually stir, or puddle, the wrought iron until it eventually made a single lump in the center of the furnace hearth. The lump was then removed and hammered on a forge to remove the slag. This was done repeatedly until the wrought iron was ready to be rolled into bars or sheets. As a side note, reverberating furnaces were also used in smelters.

In 1851, Norton and 22 others left the Belmont mill and formed Bailey, Woodward and Company and began construction on a new mill, which was to be named LaBelle Iron Works (pronounced LAY BELL) after the French name for the Ohio River: La Belle Riviere, the beautiful river. Woodward became a managing partner in the company. It was interesting to note that most of the founding company members came from the various nail mills around the Wheeling area.

From the beginning, LaBelle was a fully integrated operation, with rolling mills, furnaces, and nail machines, under one management, making one product: cut nails. In 1859, the

LITE AND NARROW | 6

company further integrated their operations by purchasing the Jefferson Iron Works in Steubenville, Ohio, across the river from Wheeling. This purchase increased their number of nail machines and included two tracts of land containing woodlot and coal holding. Due to the wartime scarcity, and the wildly fluctuating of the price of pig iron, the company constructed two blast furnaces at the Steubenville site, one in 1862-63 and one in 1864. To complete the integration, the company sank a deep-shaft mine on their property to tap their coal reserves, thus insuring their control over their raw materials. Other Wheeling companies followed suit.

In January 1869, S.H. (Stimson Harvey) Woodward visited northern Alabama, investigating reports by Union veterans of rich coal and iron deposits. He had learned about the rich mineral



4. The Santa Fe with train is coming in from the coal mines.
John Stewart Collection



5. Mike No. 28 at red ore mine #3. *John Stewart Collection*

resources in February 1867, when traveling by steamboat on the Ohio, from two soldiers who, during their campaign against the Confederacy, had noticed vast deposits of iron ore, coal, and limestone within a few miles of each other. Understanding the significance of this information, with regards to iron making, he made a mental note about it, but was unable to do anything about it until two years later.

What he found was a densely forested land that was sparsely settled and had been the hunting grounds for Chickasaws, Choctaws, Cherokees and Creeks less than a generation before. He also found a fledgling iron industry scattered about the

LITE AND NARROW | 8

area, but nothing to rival the size and capacity of the Wheeling operations. After seeing the “red ore” deposits, geologists would estimate them to be over a billion tons in Jefferson county, and the brown ore in Shelby county convinced Woodward of the validity of the soldiers’ story. Within a month he purchased 550 acres of land on Red Mountain, spent \$30,000 on other coal and ore lands and, in addition, purchased a 2,000-acre tract near Woodstock in Tuscaloosa County. These properties were to become the nucleus of the Woodward Iron Company.

In 1836, Woodward married Margaret Glass, and eventually they had four sons and four daughters. In the 1870s, two of the sons, Joseph H. Woodward (J.H.) and William H. Woodward (W.H.), investigated the possibility of using the coking process

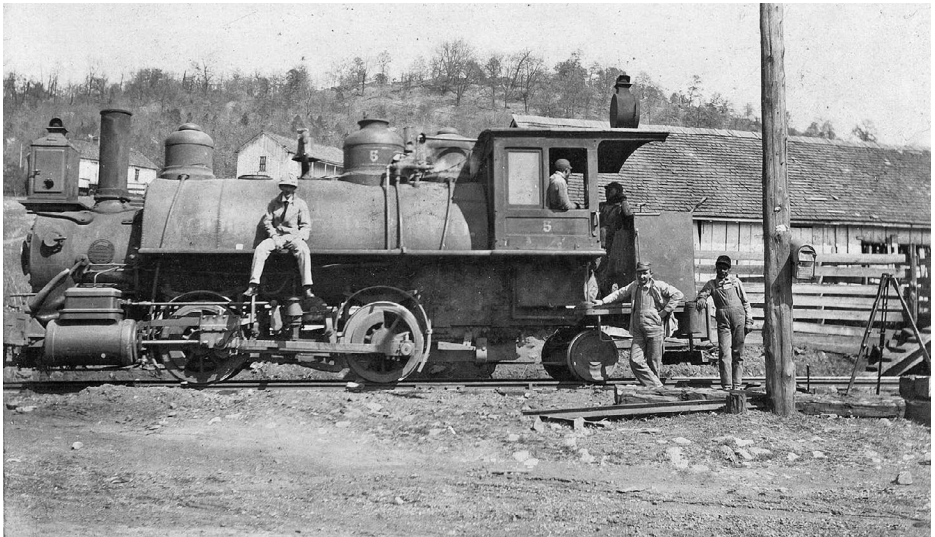

6. Woodward #5 an 0-4-2T. It looks like the trailing truck was an afterthought from the spacing under the engine.
John Stewart Collection



7. Train with locomotive #1 or #2 leaving red ore mine #1.
John Stewart Collection

(beehive coke ovens) at the Alabama lands. For many years the coal in the south was considered inferior and not usable for coke. Alice Furnace came on-line in 1880 using southern coke, and this attracted northern capital to the area. Agreeing that the coking process would be possible, the two sons founded the Woodward Iron Company following their father's death in 1881. W. H. served as president, while J.H. served as secretary-treasurer. Construction was begun almost immediately on the site's first blast furnace, 12 miles southeast of Birmingham, and was completed in 1883. The site was ideal. This close proximity of its operations, made possible by careful and early acquisitions, similar to the methods used earlier at La Belle, gave Woodward one

LITE AND NARROW | 10

of the lowest raw material assembly costs in the nation. While the Woodward Iron Company did not fully integrate producing finished products, such as iron castings, until the twentieth century, it did have full control over that which the Woodward's chose to produce.

The Woodward's plans were thorough. They called for a blast furnace; 150 beehive ovens (coke ovens so named because they resembled giant beehives); ore and coal mines, and about eight miles of in-plant railroad to serve them.

The railroad

The railroad was built as early as 1883, when the first Woodward blast furnace was put into operation. This early railroad shows clearly on the 1887 map available on the University of Alabama's online map archive. This early railroad linked the company's



8. Narrow gauge operations at the #2 red ore mine.
John Stewart Collection

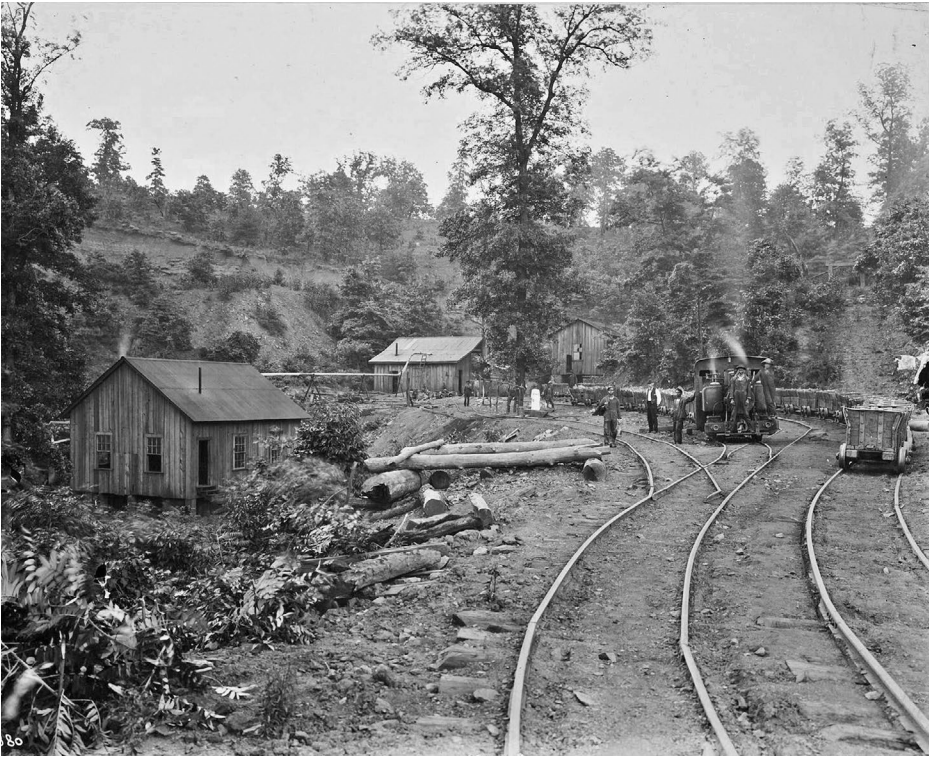

*9. Hoist house and narrow gauge at the #2 red ore mine.
John Stewart Collection*

coal mines at the north end to the blast furnaces near the mid-point, and then on to the red ore mines at the south end, a distance of eight miles. In an 1889 report of assets, the company had five locomotives and 83 coal and ore cars in operation. It was also reported that the railroad had connections with the AGS (Alabama Great Southern, today Norfolk Southern) two miles from the plant and the L&N (Louisville and Nashville) plus others less than ½ mile from the furnaces.

By 1907, Woodward had three furnaces in operation, and the AB&A (Atlanta, Birmingham, and Atlantic) arrived in Bessemer, AL.

LITE AND NARROW | 12

Through a prior agreement, the AB&A began the 13-mile construction to the Mulga mine, which would become part of the Woodward holdings in the near future. Over the years, the AB&A evolved into the Atlanta, Birmingham and Coast, and then the Atlantic Coast Line. It is now part of CSX. The trackage was abandoned and scrapped from downtown Birmingham to Parkwood Junction, south of the city, where the remaining portion of the line splits off of the old L&N line from Birmingham to Montgomery and goes to Manchester, GA. The only remnants of the abandoned portion of the line are some beautiful concrete overpasses in Bessemer, and a curved girder bridge over the Norfolk Southern mainline.

The AB&A extended a line to the Mulga Coal Mine owned and operated by Birmingham Coal and Iron. In 1912, Woodward



10. HH900 # 65 at the end of its life. rrPictureArchives.net, Robert Farkas contributor



11. SW1200 #52 showing the simple paint scheme Woodward applied to their locomotives. rrPictureArchives.net, *Robert Farkas contributor*

purchased Birmingham Coal and Iron, and leased the AB&A's Mulga Branch. While the ICC valuation records indicate the acquisition was 14 miles, plus four miles of spurs, part of the trackage was parallel to the Woodward coal line to Dolomite making the net acquisition around five miles. Sometime between 1924 and 1930, Woodward assumed complete control of the Mulga branch, leasing the parallel trackage to the Birmingham Southern.

In addition to the Mulga Coal operations, Woodward acquired the Birmingham Coal & Iron company's facilities in North Birmingham including the two Vanderbilt blast furnaces. To supply the furnace, Woodward operated raw material trains

LITE AND NARROW | 14

between the coke ovens at Woodward and red ore mines to Vanderbilt using trackage rights with the AB&A. The distance from the Woodward furnaces and the Vanderbilt furnace was about 13 miles in a straight line, but the distance on AB&A was somewhat longer.

Other BC&I facilities were located several counties east of Birmingham, and included coal and brown ore at Tecumseh, AL. These materials moved by class-one railroads. The cost of operating with trackage rights, or of paying common carrier rates, was more than the cost of operating the company's private railroad. In the long run, these transportation costs caused Woodward to abandon the facilities not served directly by the company's own railroad.

There were three Woodward ore mines, Woodward #1, #2 and #3. Woodward #1 was located south of Paul's Hill in Bessemer. There was a tailings dump on the south side of the mountain, at the end of track. In addition to administrative offices, this site also included doctors' offices, an elementary school (Red Ore) and the commissary. Woodward #2 was south of Lipscomb, west of TCI #6½. Woodward #3 was also south of Lipscomb, and

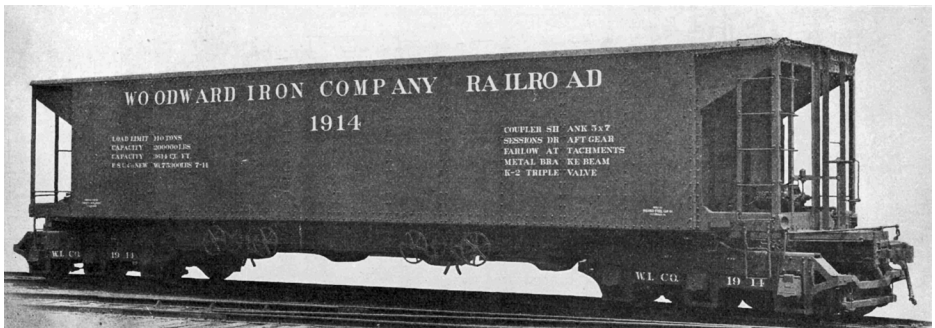

12. 100-ton cars built for Woodward by Pressed Steel Car Company in the late 1920s. *John Stewart Collection*

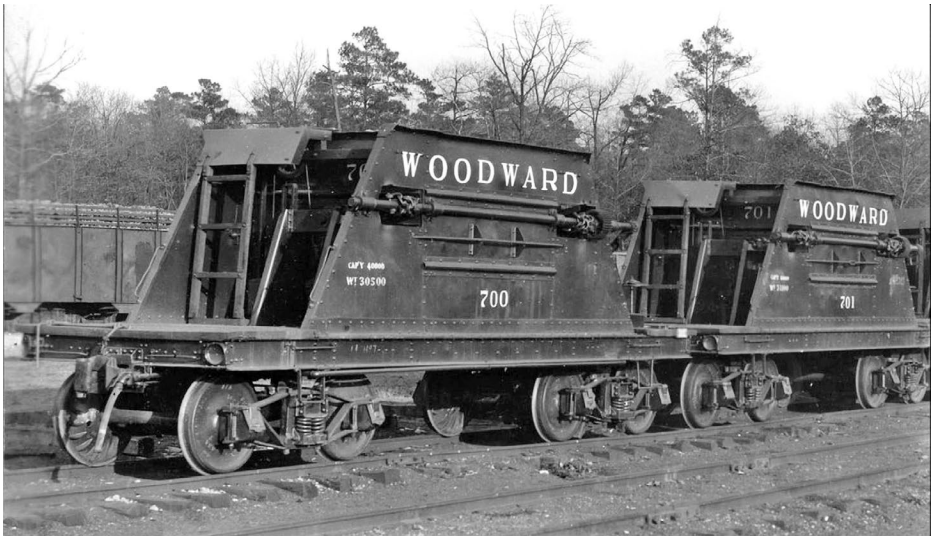

13. Home-built 20-ton ore cars used at the short-lived Vance Mine in Franklin County, near Russellville, AL. *John Stewart Collection*

was the last operational mine on Red Mountain. Number three closed about 1953. Woodward #3 Tipple, located on the north-west slope of Red Mountain, continued to be used to handle ore that was being hauled, by Euclid trucks, from the Woodward Songo Slope Mine two miles to the east. Songo was located between TCI's #10 and #11 mines. In the beginning, Mines #1 and #2 were served by a narrow gauge tram that was eventually standard-gauged. Mine #3 was reached by a standard gauge switchback from #2.

Red ore mines served via trackage rights

Woodward had other red ore mines that were accessed using trackage rights over two other railroads. Unlike the mines acquired east of Birmingham, these were located close to the Woodward furnaces with railroads already serving them.

LITE AND NARROW | 16

The Songo red ore slope mine was developed by Tutwiler, and sold to Birmingham Coal & Iron, with Woodward acquiring it in the BC&I acquisition in 1912. Originally, Songo had been served by the L&N Mineral North Branch on the north face of Red Mountain. L&N sold these lines to TCI about 1917, which left Songo without L&N service. In a major dispute with TCI over access issues, which resulted in Songo becoming land-locked with no rail service, Woodward was forced to sink a new shaft on the south side of Red Mountain to reach the Songo seam. The Redding Shaft (384 feet deep) was served by the Birmingham Mineral RR's South Branch along the south slope of Red Mountain.



14. This “high line” apparently ran from the surface mine operation to the washer, which was under construction at the Vance Mine in the winter-spring of 1928-1929. *John Stewart Collection*

When the South Branch line was abandoned about 1933, Woodward had to resort to truck haulage from Redding Shaft to Woodward #3, although they had a right-of-way that could have been developed along the south slope of Red Mountain. In short, the Woodward Iron Company RR didn't access the Redding Mine or the Pyne Mine directly, although there were preliminary plans for access indicated on some maps.

The Pyne Shaft Mine accessed the red ore of Red Mountain in Shades Valley by way of a vertical shaft, instead of a slope that followed the red ore seam from its outcrop near the top of Red Mountain. At 1200 feet, Pyne was the deepest of the red ore mines in the Birmingham district. It was also prone to flooding, and was closed until demand for iron could support the cost of pumping and transportation. The mine was located near the Lacey's Chapel community, and adjacent to the AB&A's mainline from Bessemer to Manchester, GA, so access was via trackage rights on the AB&A. The mine was located six miles from the Woodward Furnaces; however the trackage miles were longer.

When Woodward was founded, it had constructed 180 beehive coke ovens located northeast of the blast furnace. The coal for the coke ovens came from company-owned mines and was delivered by the company railroad. Another component of Woodward's raw materials transportation was coke made from the company's coal. In the early days, Woodward utilized the beehive ovens located northeast of the blast furnace plant. As technology changed, and better, more efficient methods of producing coke evolved, Woodward replaced the beehives with modern coke ovens. This resulted in a coke plant being built west of the blast furnace complex, on the west side of the main line railroad operated by Southern and L&N between Bessemer

and Birmingham. The Woodward Iron Company RR served all of the company's coke ovens.

Birmingham's rail network was complex, as it included trunk lines, short line common carriers, and the industrial private railroads. Although Woodward had a private railroad, their crews were required to cross other lines at junctions. Thus Woodward crews were required to obtain switch keys and interlocking privileges at several locations on the L&N and the AB&A, making for some interesting operations.

Woodward Company's leadership spanned four generations of Woodwards. A very interesting aspect of the WICo RR was that the third president and chairman of WICo. for a number of years, A. H. "Rick" Woodward, was himself a certified locomotive engineer. In fact, he actually was a road engineer for the AB&C Railroad holding #2 seniority for a period of years after 1921. A. H. Woodward had grown up in the company's operations and had become certified as a teenager, apparently starting as a hostler on the company's property. A. H. Woodward kept a close involvement with the company's railroad, as well as the AB&C; he also served on the Board of the Seaboard Air Line RR.

By 1924 the Woodward Iron Company Railroad was six miles long, but an article published in Blast Furnaces and Steel Plant in May of 1924 indicates that the Woodward Iron Company comprised 45 miles of trackage (a figure which presumably included route miles as well as sidings), 12 modern locomotives, and 232 standard gauge cars.

Following the Depression, and during the 1950s and 1960s, the company diversified by acquiring foundries, cast iron pipe foundries, and other types of companies allied to the iron industry. Woodward became a truly integrated iron company in that they produced finished products.

If you look at the history of family-owned corporations, you will see that they do not last more than three or four generations before being bought-out or closing. This was the case for the Woodward Company. After four generations of family leadership, the company was sold to the Mead Corporation of Dayton, Ohio in 1968, when the post-World War II boom in the iron and steel industry was drawing to a close. In less than 10 years after the sale to Mead, the last red ore mine closed (Pyne Mine), iron production ceased, the by-product coke plant was sold, and several firms acquired parts of the Woodward railroad. The Birmingham Southern acquired the three miles between AB&A junction and Bessemer over which it had trackage rights for many years. Birmingham Southern sold a mile to Koppers, the firm that purchased the by-product coke plant and continued to operate it until the 1990s. Drummond, Inc. purchased the Mulga mine, and removed the tracks. Most of the remaining tracks were sold to a firm that removed and sold used rails.

Motive power

Noted rail historian Tom Lawson has provided a summary by wheel arrangement and model of the standard gauge locomotives owned by Woodward Iron Co.:

**When talking to
hobby vendors,
please remember to
mention MRH.**

STEAM

- Two 0-4-0T Nos. 16, 17
- Four 0-4-2T Nos. 2, 4, 5, 6
- One 0-6-0T No. 3
- Six 0-6-0..... Nos. 3, 4, 5, 8, 9, 34 (all except No. 9 used at Vanderbilt Furnaces)
- One 2-4-0 No. 7
- One 4-4-0 No. 1
- One 2-6-0 No. 10
- Three 2-6-2 Nos. 22, 23, 24
- Four 2-8-0 Nos. 25, 35, 36, 38
- Nine 2-8-2 Nos. 14, 19, 26, 28, 29, 30, 31, 40, 42
- One 2-10-0 No. 41
- Two 2-10-2..... Nos. 33, 37

Notes: Also had three narrow gauge 0-4-0T's. Road numbers 3, 4, 5, 8 each used twice.

DIESEL-ELECTRICS

- SW7..... No. 50
- SW1200..... Nos. 51-52
- SW9..... Nos. 53-55
- SW8..... No. 60
- SW900 Nos. 61-62
- 75-ton Porter ... No. 63
- HH1000..... No. 64
- HH900 Nos. 65-66

Steamlocomotives.com has info on many of the Woodward Locos. 2-8-2's are steamlocomotive.com/mikado/?page=wic.

REFERENCES

Birmingham district railroads

Birmingham District National Heritage
Corridor – Birmingham Industrial District
Birmingham vie.
Jefferson County Alabama
HAER No. AL-L1

Historic american engineering record

National Park Service
Department of the Interior
P.O. Box 37127
Washington, DC 20013-7127

LaBelle Iron Works

Labelle Cut Nail Plant
30th and Wood Sts.
Wheeling
Ohio County
West Virginia
HAER No WV-47

HISTORIC AMERICAN ENGINEERING RECORD

National Park Service
Department of the Interior
P.O. Box 37127

Ties, Southern Railway magazine, January, 1959

Woodward Iron Company Railroad Rev 1, John Stewart,
Bhamrails.info

Unless otherwise noted, all Woodward photos are from Woodward Family papers, University Libraries Division of Special Collections, The University of Alabama.

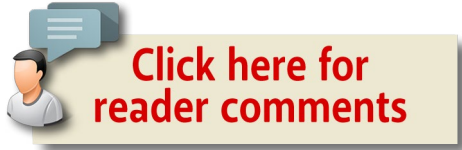

Yes, we pay for articles!

Need some hobby cash? Consider sending us an article.

click to learn more ...

NEW!

Spread the word about MRH!

MRH and TMTV apparel ...



Adjustable black baseball cap with a red brim and laminate MRH logo.

~~\$15.00~~ **\$10.00**
+Shipping



MRH t-shirt with eye-catching silvery logo against jet black fabric.

~~\$18.00~~ **\$15.00** per shirt
+Shipping
Sizes S-2XL



T-shirt displaying a TMTV logo against a deep chocolate brown fabric.

Get your apparel TODAY

store.mrhmag.com

NORTH AMERICAN RAILCAR CORPORATION

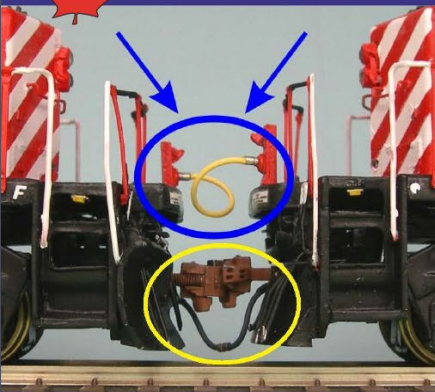

NARCorp MU Cables

use with
MagnaLock Brakelines



*New MU cables add
even more realism
to your model
locomotives!*

**NEW
Product!**

**COMING
September 2015**

NARCorp High Performance MagnaLock Brake Lines

**Improved
Design!**

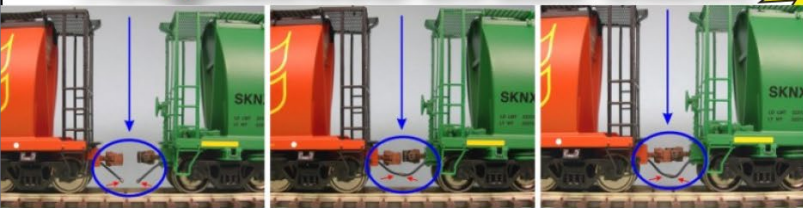

*New Design -
now even more
realistic!*



National Steel Car Potash Service 4300 cu. ft. 3 Bay Covered Hopper Special Limited Run 2015 Portland NMRA Convention Car



**WATCH
THE
VIDEO**
click here

Official NSC authorized product



Available exclusively through:

Pacific Western Rail Systems

MRHMAG.COM

- TABLE OF CONTENTS
- INDEX



WHAT'S NEAT WITH KEN PATTERSON

KEN PATTERSON

column



[Click here for
reader comments](#)

BUILD A BUILDING, SANDBLAST AN ENGINE ...

IN THIS MONTH'S VIDEO WE COVER BUILDING layouts, sandblasting brass models, constructing a laser kit, and improving freight car performance with aftermarket trucks. We discuss scales, comparing ½-inch (1:24) scale to 1:20.3 scale. As usual, there are lots of runbys and extras in the video.

To start this month's "What's Neat" in the magazine pages let's talk about layout construction.

▶ PHOTOS AND VIDEO OF SUPERB MODELS

WHAT'S NEAT | 2



1. I have been adding track and making changes on my layout, so I needed to pull off the plywood sides of the layout to change the panel block switch arrangements.



Playback problems? [Click here ...](#)



2. I cut a piece of Plexiglas to the size of the new panel and cut holes for the rocker block switches.



3. I applied thin tape in the pattern of the new track leads, then painted this panel black.



4. After removing the tape, I sprayed the back of the panel with gold paint.

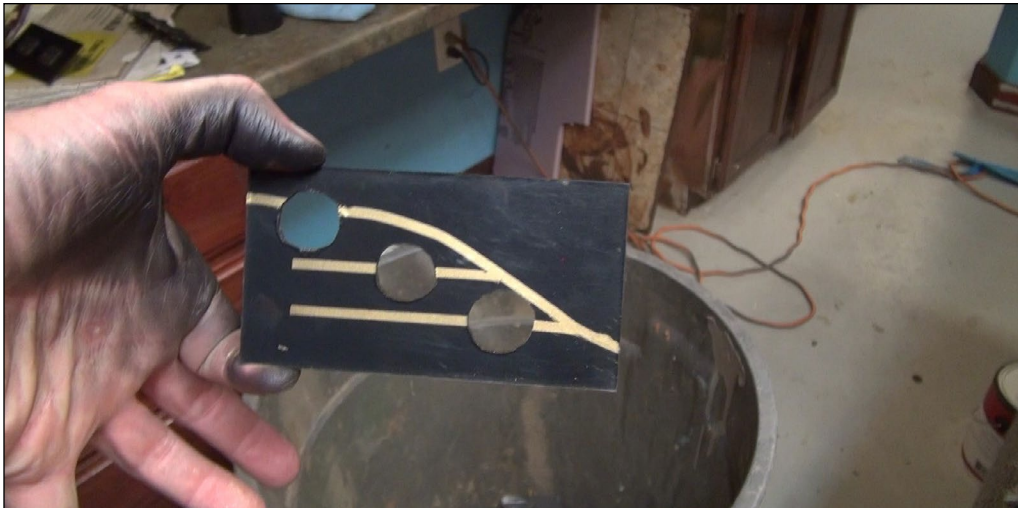

5. When you turn it over, you can see the new track arrangement on the panel in gold. It's ready to reinstall on the foam module.



6. When it was time to replace the plywood face on the module, I inserted strips of 1/2-inch dimensional lumber so I would be able to staple the sides to the foam. The foam on these modules is about 11 years old and was starting to get soft on the sides. Rather than glue it and have it pull apart later, I chose to use one-inch staples to secure the plywood sides to the wood that was glued deep into the foam. This worked well and held tight. You can see the entire process in real time in the video this month.



[Click here for reader comments](#)

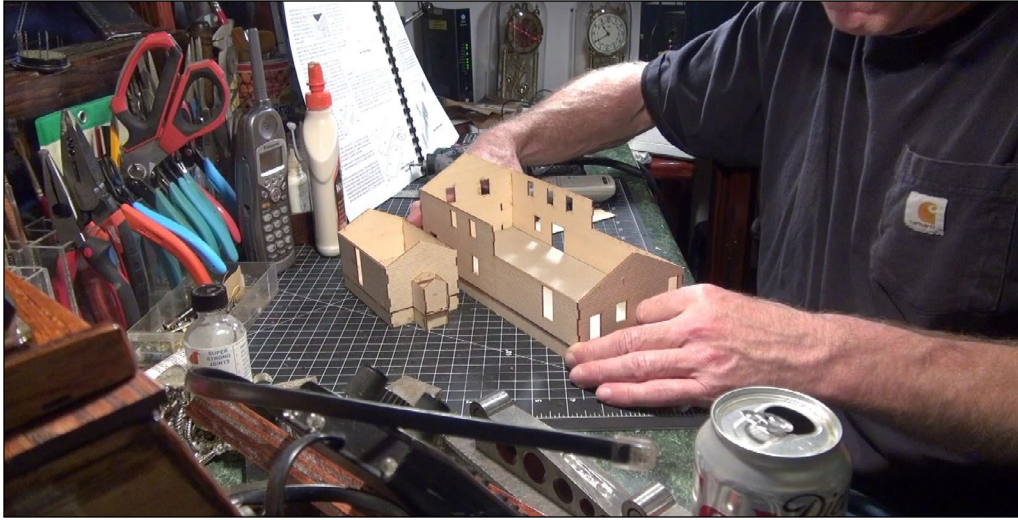

7. This month we build the B.T.S. Dodson's Farm Creamery. I'm using it as a hardware supply house for one of my mining towns. I test-fitted of all the main walls before I went back and glued these pieces with wood glue.

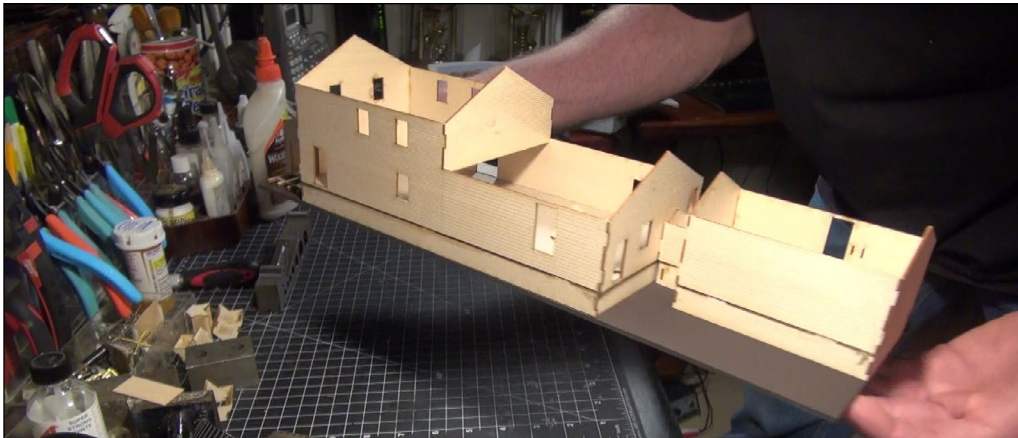

8. This model is long and has many sections and docks, so I cut a piece of Plexiglas. This forms a flat base to hold all the components of the structure together – it becomes a one-piece diorama that can be dropped into the layout.



9. Using an airbrush, I painted the main walls with Floquil Tuscan paint. My formula is 25 psi of air pressure, and the paint thinned 50 percent.



10. I cut out all the trim pieces and window parts and painted them white, and worked my way around the building. This gave the warehouse some accent color. It looks like a well-maintained structure.



11. After finishing the roof sections I was able to test-position all of the kit components together on to the Plexiglas just to make sure everything fit as planned.



12. I used Master Creations cedar shake shingles on the building. I enhanced these sheets with brown colored pencils before installing the shingles. This random effect will look good when the roof is applied.

TrainMasters TV ...

Cast your vote for *MORE* Network-TV level video programming for model railroading from MRH



Become a TMTV member today



Brought to you by

MRH
MODEL RAILROAD HOBBYIST

MRHMAG.COM

- [TABLE OF CONTENTS](#)
- [INDEX](#)

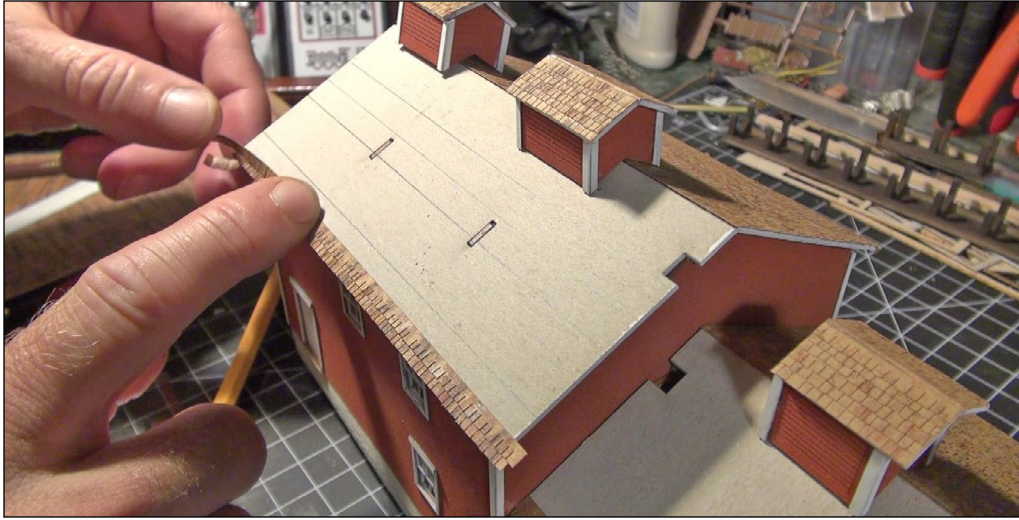

13. Simply peel and stick each row of shingles on to the roof sections. I draw lines on the roof to help keep the rows of shingles even.



14. Here is what the roof looks like with the randomly-colored shingles applied to the cardboard roof sections.

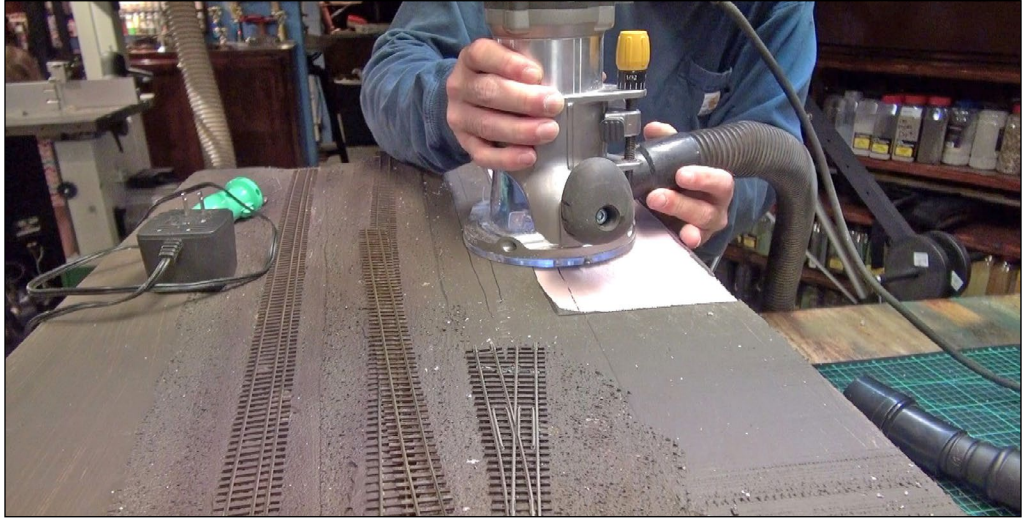

15. Turning my attention to the diorama where the building will sit, I used a router and a hot foam cutter to cut away the foam to the depth of the Plexiglas, making for a flush fit. I then glued the building to the Plexiglas base.



16. I laid two siding tracks to serve the building. This track was glued down with Liquid Nails, then painted with Rustoleum Camouflage paint to give the entire area a dull, even tone.



17. I ballasted the track with creek rock and sifted dirt around the area along with ground foam. Everything was glued down with Woodland Scenics scenic cement.

Want to help
keep MRH free?
Then click on
Ads!

iwata

by ANEST IWATA

Just Rolling By...

Make It **REAL** With Iwata
Climb Aboard!



**Eclipse
HP - CS**

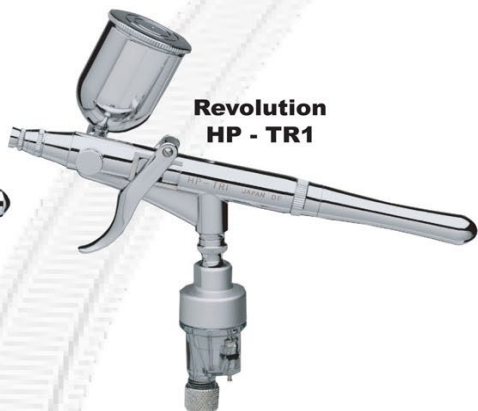

**Revolution
HP - TR1**

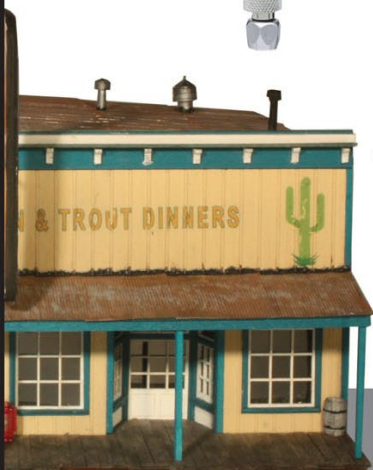

Visit...
www.iwata-medea.com
**To Check Out Our
Full Product Line!**

*Models By... Alan Houtz,
North American Prototype Modelers*



18. This is how the laser kit turned out. I still need to add steps, ladders, and chimney detail, but all-in-all this kit went together easy and fast with well-engineered design



and precision-cut parts. Now I have another area on the layout to drop off cars and add a little more operation potential to my home layout.



19. This month in the video we discuss model scale and the difference between $\frac{1}{2}$ -inch (1:24) scale models and 1:20.3 scale models. When I was looking to acquire this $\frac{1}{2}$ -inch scale brass model there was confusion among my friends whether this was bigger or smaller than 1:20.3 scale. What better way to explain the difference than to show it in photos and video? The $\frac{1}{2}$ -inch scale model is smaller than the 1:20.3 scale model. The wheel spacing on the $\frac{1}{2}$ -inch scale model is 3 feet, 9 inches rather than 3-foot narrow gauge, so it can run on G scale track. Just something interesting that you don't see every day.



[Click here for reader comments](#)

Sandblasting models



20. For this month's video tool tips, we discuss and demonstrate sandblasting brass models. Most models come with a lacquer clearcoat. When painted over, this can really cover up a lot of details. Sandblasting the model to remove the clear lacquer makes for a smooth finish with all the detail popping out at you.

When talking to hobby vendors, please remember to mention MRH.



21. Here you see the inside of my North Coast sandblaster. I am using a full-size ceramic gun with 220 grit aluminum oxide. This size is very fine and will not pit the brass. I used about 50 psi of air pressure during this process. A vacuum system sucks the sand out of the air in the booth to allow a clear view of the work.

109,000 have seen this MRH video - *have you?*

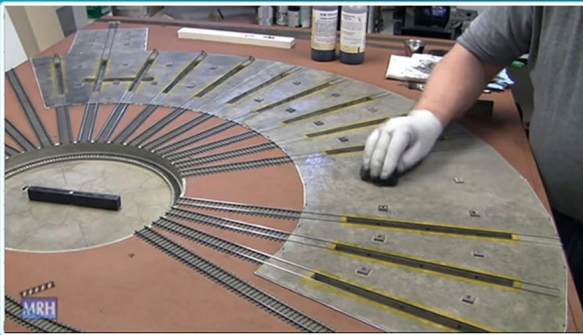

Watch the
video now





22. After blasting the model, I wash it in water from the sink and brush off the loose sand from the model. No matter how much you wash and brush the model, when you place it in the ultrasonic cleaner a dust cloud forms in the bath as all the dust from every crevice starts to float free. Now you have a clean model ready for paint. You can watch the entire process in this month's video in real time.



[Click here for
reader comments](#)

Improving freight car performance with aftermarket trucks

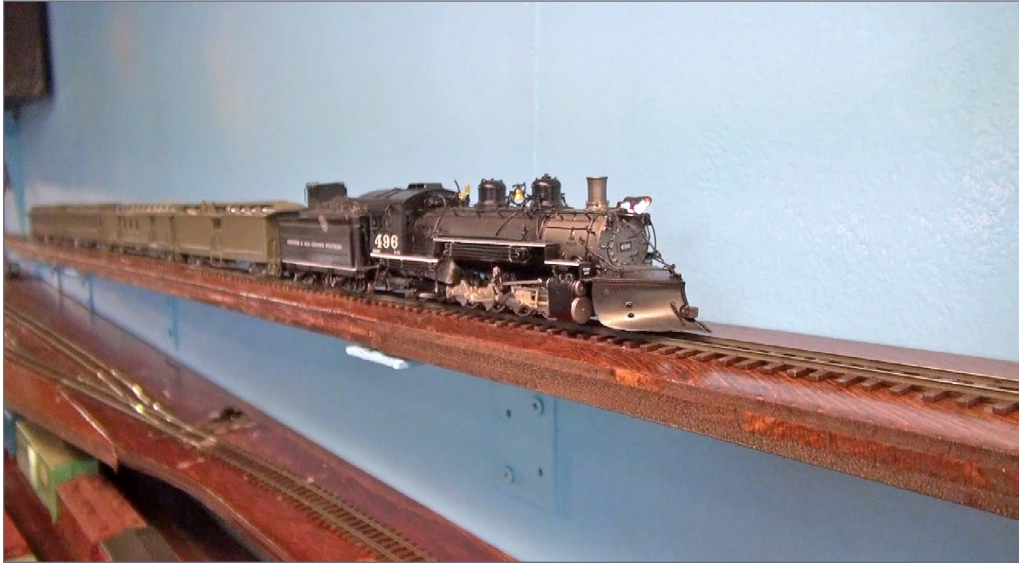

23. I have this K-37 scale brass model that could not pull four older brass passenger cars up a 4 percent grade. The brass trucks from the '60s don't roll very well and have a lot of drag. The solution was to replace the older trucks with free-rolling new Blackstone aftermarket passenger car trucks, reducing the pulling drag from 1.2 ounces to a half-ounce. Now the locomotive can easily pull the train up the 4 percent to the upper town.



24. I can measure the pulling drag of any given train with this Micro-Mark digital weight scale that allows very fine measurements.



25. I adapted a Kadee coupler to the measuring scale so I could connect it to locomotives or freight cars and measure the dead drag or pulling ability of the models.



26. My HO scale 62-car reefer train had a pulling drag of over 4.5 ounces. By replacing the trucks with Kato after-market trucks I was able to reduce the drag of the consist of cars to 2.2 ounces – more than half. Trains now run better with fewer coupler separation problems.

Be sure to vote in Readers Comments if you like What's Neat with Ken Patterson. Thank you for your support.



[Click here for reader comments](#)

*Build this beautiful shelf layout
step-by-step with Ken Patterson!*

**CHECK IT
OUT!**



kenpatterson.com

click here to ...

Visit Ken's website

**Ken Patterson builds a
shelf layout using
state-of-the-art methods**



MRH MARKETPLACE

Don't miss The Eagle!



- Enjoy 4 full color magazines per year
- Plus a 12-month full-color calendar
- 2015's annual meeting in Houston, TX
- On-line company store featuring special run MP models, books and much more.

To join: go to mopac.org or e-mail marketing@mopac.org for more info.
Or send \$35 for your membership to:
Missouri Pacific Historical Society
Membership Services
P.O. Box 138
Bucklin, MO 64631-0138

V2

True Scene™ Modeling



FusionFiber™

Scenery Base Material for the 21st Century!

SATISFACTION GUARANTEED!

www.truescene.com or 716-523-7305



PRECISION
Laser Cut Details & Kits

STREAMLINED BACKSHOP

Sales
... Services
..... Solutions

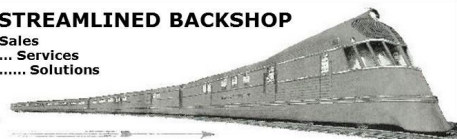

"SUGAR CUBE" SPEAKERS...

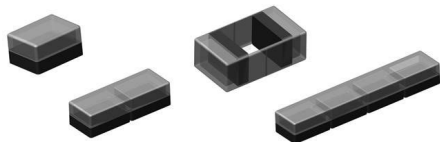

4 Sizes * 4 Baffles

... "Sweet" Speaker Options!



www.SBS4DCC.com

Trees

Evergreen
Conifers for HO,
N, S, and O Scales

Make Your Own,
Save Money and
Have Fun

Real Wood Trunks

All Components
Available
Separately

Made in Oregon, USA



coastmans.com

LOOK
at what's new at
Black Cat this month

**Click here for
our website**

CPR HO stock cars decals:



Black Cat Publishing
234 Lindenwood Dr. W.
Winnipeg, MB R3P 1X7
(204)489-5005
ajfergus@mymts.net



clever
models LLC

The hottest trend in
modeling... Is also the
least expensive.



Try one today!

www.clevermodels.net

GC
GRAND CENTRAL
MONEY RAILWAY

Ph: 0448534212
What we do:

Benchwork, Layout Design, Display Cabinets, Layout Photography,
Backdrops, Home Consultations and Valuations
www.australianpacificrailways.com





BenchWork
COM



Affordable built to order Benchwork
starting at only \$20 a Sq Ft.

Don't settle for lifeless signals!
We've got signaling circuits!





LOGIC RAIL™ "Sophisticated
TECHNOLOGIES Model Railroad
Electronics"

Please visit our website and online store!

21175 Tomball Pkwy Phone: (281)251-5813
Suite 287 <http://www.logicrailtech.com>
Houston, TX 77070 info@logicrailtech.com

Great Decals™
FEC, Interstate, Virginian
Railway, & L&N Titles
After Hours Graphics Line
Coupler Gages and More
In O, S, HO, and N Scales



P R E C I S I O N D E S I G N C O

Chains
Flat Car loads
Joint Bars
Signs & Posts



FREE SHIPPING

AMERICA'S NUMBER ONE
RAILROAD PRINT SOURCE

Jelsma
Graphics

America's Railroad Embroiderer

Railroad Art-Prints,
Caps, Jackets,
Shirts and More ...
Jackets starting
at \$79.95

www.jelsma.com
1-904-221-3513 • Jacksonville, FL.

Hobby Marketplace Ads are Economical and Effective.



P.O. Box 6 Paonia, CO 81428
Ph. 970 527 4586
Made in The USA

Cast resin items for All Scales.
Tunnel portals, bridge piers, abutments,
culverts, and retaining walls.
Trackside details and sage brush tree
armatures.



MOUNTAIN SUBDIVISION HOBBIES

www.modelrrsupply.com

FREE USA SHIPPING OVER \$29.00

NCE - SOUNDTRAXX - DIGITRAX - PECO - CIRCUITRON
DCC SPECIALTIES - INTERMOUNTAIN - CMX - ATLAS
BAR MILLS - BOWSER - KATO - MRC - TOMAR - RIX -
PIKESTUFF - LOGICRAIL - CENTRAL VALLEY AND MORE!



NEW N.A.R. STK CAR KIT!



**RESIN KITS, DECALS,
DATA DISKS & DETAIL
PARTS AVAILABLE.**
westerfieldmodels.com



Yarmouth Model Works
HO scale resin kits and detail parts

U.S.A. MAILING ADDRESS
3560 Pine Grove Ave, Unit 617
Port Huron, MI 48060

Tel. 519-633-7574
pierre.oliver@start.ca

www.yarmouthmodelworks.com

CANADIAN MAILING ADDRESS
85 Hiawatha St.
St. Thomas, ON N5P 2T5

CUSTOMIZED SIGNS FOR YOUR LAYOUT
ADD A PERSONAL TOUCH TO YOUR LAYOUT WITH
A CUSTOMIZED SIGN.

WHETHER IT'S "AL'S GARAGE" OR
"BOB'S TOWING", WE'LL HELP
YOU DESIGN THE
PERFECT SIGN



UNIQUE PRODUCTS FOR UNIQUE LAYOUTS

[Click Here](#)

RULERS-of-the-WORLD

Scale Rulers \$4 each

Over 200+ scales!

Metric or Imperial

www.rulers-of-the-world.com

When talking to hobby vendors,
please remember to mention MRH.

Have you seen these popular blogs on the MRH website?



Ken Glover's Shelf Layout

75,000 reads

[CLICK TO READ IT NOW](#)



Mike Rose's N scale empire

157,000 reads

[CLICK TO READ IT NOW](#)



HO DIESEL SUPPLY

Are you serious about your HO Diesel fleet or just tinkering? Either way You probably bought just the right parts you needed from us already

BACKSHOP HARD PARTS DIVISION

Now Direct Personal Service

www.hodieselsupply.com

email: TheBoss@hodieselsupply.com

Your ad could be in this space for just \$84 a month.

[Click to learn more ...](#)

HOBBY MARKETPLACE ads are economical and effective.

Click [HERE](#) to learn more.



Re-weathering MY 35-YEAR-OLD RSC-2



BY BOB RIVARD
.....

MRHMAG.COM

- TABLE OF CONTENTS
.....
- INDEX



[Click here for
reader comments](#)

Giving an Alco RSC-2 a facelift ...

BACK IN THE EARLY 1980S I MODELED MY FIRST Soo Line switcher, the 371, an Alco RSC-2. I found a great reference photo of this locomotive in the late Patrick Dorin's book *The Soo Line*. Switcher 371 was originally a six-axle RSC-2, however the Soo re-trucked the locomotive using two-axle trucks which basically made it a dead-ringer for an RS-2. I decided to model the 371 using a Hobby Town RS-2 metal kit.

Back in the day this was about the only way to model one of these Alco switchers. The heavy white-metal body along with a huge flywheel made this engine a very smooth-operating locomotive. However these Hobby Town engines shared one major drawback. The electrical pickup was such that only one set of wheels on each truck conducted current. This made the engine prone to stalling, especially at turnouts.

Fortunately I could rectify this problem a few years later with the introduction of Atlas' fantastic Alco RS-2. The Atlas model allowed the cab and hoods to be separate from the platform, so I simply attached my Hobby Town hood and cab to the Atlas platform. This was important to me because I had invested a lot of time constructing the unique air intake ductwork on the roof of the Hobby Town body.

Utilizing the original heavy metal Hobby Town body combined with the extremely smooth-running (and all-wheel pick up) Atlas mechanism is a recipe for the ultimate-running switcher!

RE-WEATHERING MY RSC-2 | 4

There was, however, one small nagging problem with this engine. Whenever I would come across prototype photos of the 371, I could see that I had applied way too much weathering to my model. My motivation to finally address this weathering issue came when fellow Soo Line modeler Luke Lemmens posted some shots of his 371 on the “Soo Line Models In Action”



1. Here is the shot of 371 I posted on the “Soo Line Models In Action” Facebook site. When I originally weathered it some 35 years ago, I simply applied Floquil Grimy Black using an airbrush. However, through the years I have learned there is much more to capturing the look and feel of correctly weathered Soo Line diesel locomotives. This becomes especially evident on engines painted white! After studying many prototype photos, I soon found it was critical to simulate the effects of dirt and grime that accumulate in the door latches, door seams, and louvers. Also taping around the intake grills before airbrushing exhaust soot is a nice touch.

RE-WEATHERING MY RSC-2 | 5

Facebook site. After posting a shot of my 371, I once again was reminded of my over-weathered model.

At one time many of my models had what I considered too much weathering, which prompted me to come up with a way to remove weathering. Follow along as I demonstrate how I remove and re-apply weathering on a 35-year-old model.

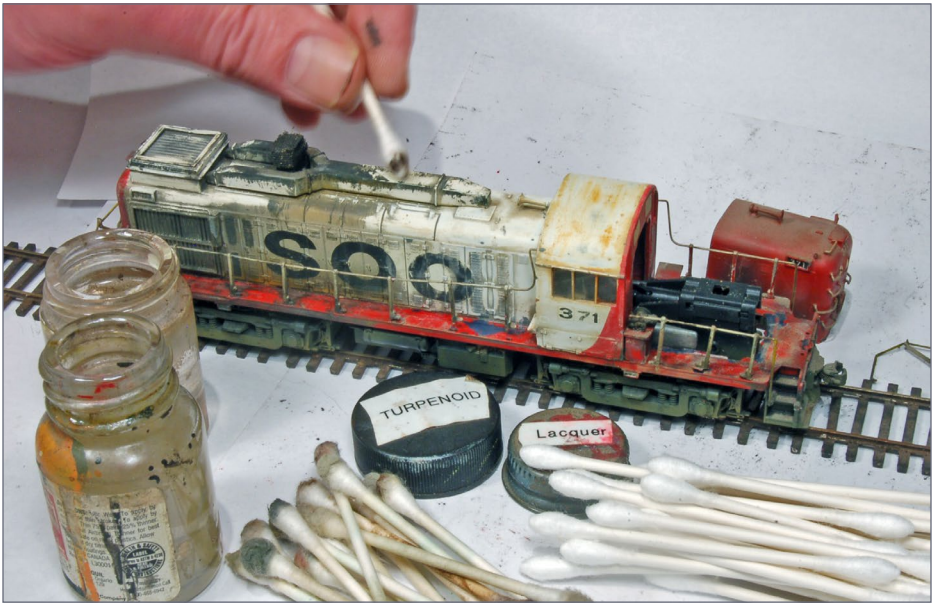

2. I start by using a combination of Turpenoid (an odorless paint thinner sold in art supply stores) and lacquer thinner. I dip a cotton swab into my jar of lacquer thinner and pick up some of the Turpenoid thinner. I wipe off weathering from the surface of the body using my cotton swab. I had a lot of weathering to remove so I switched often to a new swab. I went through at least 30 swabs on this project.



3. This is more like it. I removed quite a bit of weathering from my engine. Using a combination of lacquer thinner and Turpenoid is a very effective way to remove my 35-year-old weathering. I'm not concerned with removing all traces of weathering from the model. Notice how weathering remains in the door seams and latches. This realistically duplicates the look of weathering on a real Soo Line white locomotive. I also take care not to remove weathering from the intricate louvers.

RE-WEATHERING MY RSC-2 | 7



RE-WEATHERING MY RSC-2 | 8



4. By now you probably can see one drawback to using this method. Although using the lacquer thinner is a very effective way to remove the weathering it also removes lettering!
5. All is not lost. Fortunately I have extra sets of Soo Line lettering. Champ set EH 181 was one of the most accurate sets for Soo lettering and numbers.
6. Here is my model after re-applying fresh SOO lettering and numbers to the cab.

RE-WEATHERING MY RSC-2 | 9



RE-WEATHERING MY RSC-2 | 10



7. I'm now ready to add some new weathering, this time not so much. I first apply a quick application of Testors Dullcote. This gives everything a nice dead flat finish and hides the edges of the new decals.

8. I next airbrush a very light application of Grimy Black on the couplers, new air hose and under frame area.

9. I now airbrush some Floquil rust onto the underframe and couplers. Just as on the prototype, this really brings out the details.

RE-WEATHERING MY RSC-2 | 11

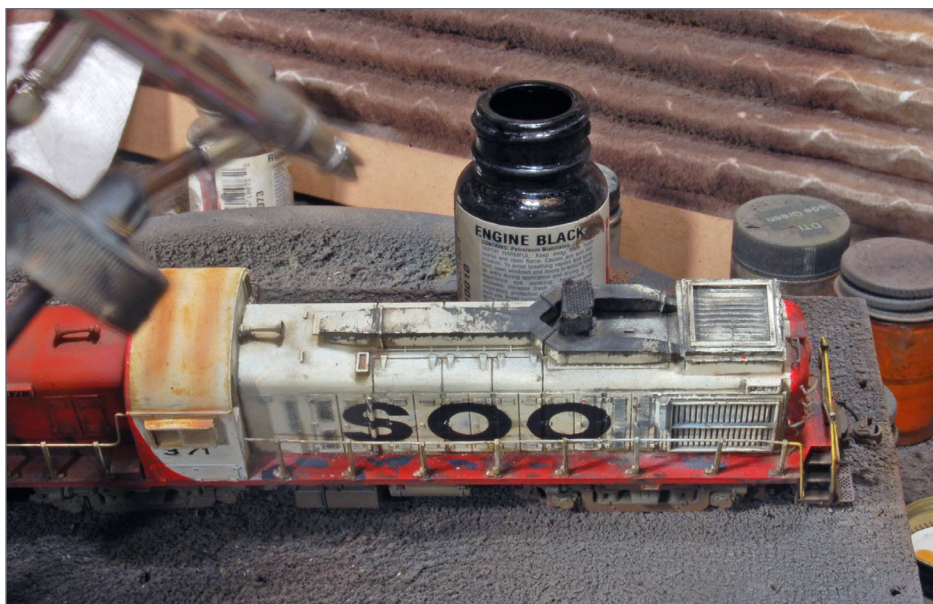



10. A common weathering pattern found on prototype Soo diesels were rust streaks on the cab roof. I simulate this effect by using quick passes with my airbrush and Floquil Rust.

11. I next apply a bit of Floquil Engine black around the exhaust stack area.

12. I'm almost finished. I apply some weathering powders to the pilot and trucks. This step is like the frosting on the cake, and provides another important dimension to the weathering process. The powders really simulate that gritty grimy look of the prototype.

RE-WEATHERING MY RSC-2 | 13



RE-WEATHERING MY RSC-2 | 14



13. My final step is to touch a dab of silver paint on the air hose details.

14. Before I head to the layout with my model, I take one last note of how many cotton swabs I used to clean off the old weathering.

15. I ran across this wonderful shot of the 371 on the Fallen Flags website. I noticed a couple of important details I forgot. Almost all Soo line diesels wore a set of re-rail frogs. These frogs on some units were even painted yellow and really stood out. I also added ACI plates which were attached to one of the hand rail stanchions.

RE-WEATHERING MY RSC-2 | 15



16-23. Here is the 371 at the Shoreham sand tower. See the following pictures also.



RE-WEATHERING MY RSC-2 | 16



RE-WEATHERING MY RSC-2 | 17



RE-WEATHERING MY RSC-2 | 18



BOB RIVARD



Bob Rivard has been fascinated with trains since the age of 5 when he received his first train set, the proverbial Lionel.

He really enjoys his job at KARE TV and has worked there for 34 years as a broadcast technician. He runs the robotic cameras during the 10 p.m. news. ■



[Click here for reader comments](#)

ADVERTISEMENT

An excellent new book about freight cars!

**American Car & Foundry Box Cars,
1960-1981**



Edward S. Kaminski

Ed Kaminski, noted freight car historian, presents a rich collection of builder and in-service photos for ACF box cars built from 1960 to 1981.

How can I learn more about this book?
How can I buy it?

[Click here for the answer ...](#)

SIGNATURE PRESS

WHAT'S NEW! ON TRAINMASTERS.TV

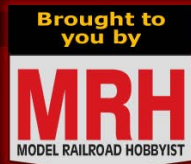

RAILROAD THAT COULD HAVE BEEN

TMTV visits Pete Smith's picturesque Sn3 Loon Lake Railway & Navigation Co., based on what could have been.

Non-members: Watch for just \$1.49!



MODELING BRICK & STONE

Don Railton demos modeling brick and stone in the larger scales on TMTV's Backshop Clinic.

Non-members: Watch for just \$1.49!



BLUE BOX CHASSIS UPGRADE

In our new NOTCH 8 series, we take finishing rolling stock & locos to the max. You don't want to miss it!

Non-members: Watch for just \$1.49!



HI-AD LOCO TRUCKS

What exactly is a Hi-Ad locomotive truck? Railroad historian Ken Goslett explains in Ken's Roundhouse.

Non-members: Watch for just \$1.49!

Watch these videos on TrainMasters.TV

(Non-members can now watch one of these videos for just \$1.49, or download-to-own for \$3.49)





N SCALE.



**CLICK
HERE.**





Model Railroad Hobbyist | September 2015 | #67

YES, IT'S A MODEL

compiled by
DON HANLEY
.....



[Click here for
reader comments](#)



1. A classic VW waits as 5538 slowly leads an eastbound CN freight at the Meurie crossing in Drummondville. Jazz De Longueuil took the picture on his HO scale layout, the Bonaventure & Chambly.

▶ **MRH'S MONTHLY PHOTO ALBUM**

MRHMAG.COM

- [TABLE OF CONTENTS](#)
- [INDEX](#)

YES, IT'S A MODEL | 2



2. Rick Sutton posted these photos of Kansas City Southern boxcars. Both models are Tangent X58 boxcars. The 23953 is originally a PC repaint that he re-imagined as one of the many KCS cars seen parked at a favorite railfanning site. KCS 21057 is modeled after a car he photographed. It began as a Norfolk Southern boxcar painted in a basic red/brown color he repainted to cream/white. The rust patterns were created by chipping off the white paint with an X-Acto knife, exposing the original color. The cars are faded with Vallejo Panzer Stencil white acrylic paint, then weathered with Vallejo rust colors and oil paint washes. The graffiti is from decals sourced from Microscale, Weathering Solutions, and various eBay sellers.

YES, IT'S A MODEL | 3



3. A local rancher drives along one of the many unpaved roads common in Utah. It is a slow day on the WP and bored railfan Rob Spangler took the shot as he was waiting for any train to pass by. The photo was taken on the Rob's WP 8th Subdivision layout. To see more of Rob's work visit his wp8thsub's blog mrhmag.com/blog/rob-spangler.



4. NYC 56508 was caught during some switching action. Uncounted miles in service left their mark; it is only a question of time until this car will end up in a scrap yard. The car is a Walthers Proto 60' PS single-door boxcar. Andreas Rittershofer weathered the car by partially removing the lettering, then applying a thin coat of light gray to get a bleached look. A fine brush with brown acrylic colors, and lots of time, were needed for the rust spots and streaks. Finally, a coat of matte acrylic varnish seals the results. Andreas photographed the car on his modular switching layout. To learn more visit his site at some-where-southwest.de.

YES, IT'S A MODEL | 5



5. SP VME (Valley Manifest East) is just east of Cliff siding on the La Mesa model railroad club in San Diego, CA. James Patterson took the photo while visiting, and captured the wide vistas the club is known for.



6. The Taggart Transcontinental, falling on increasingly hard times, has partnered with the Gorre and Daphetid to run this branch line. G&D #13 (a.k.a. Emma), was spotted today helping drag a damaged car after an inspection by G&D employees Horace P. Vestibule and Archibald Peter Van Slurp (a.k.a. Arch-Bar Pete). A track hand is supplying some refreshments for the hard-working duo.

Jeff Witt staged and took the photo as a tribute to pioneering modeler John Allen, and a nod to Ayn Rand, author of *Atlas Shrugged*, in which Taggart Transcontinental plays a key role.



GET PAID FOR YOUR PHOTO

We pay \$40 per photo we publish. If you'd like to get your modeling in our photo feature, just start posting your photos on the MRH website, especially in the Weekly Photo Fun thread created each weekend.

See mrhmag.com/help for more on how to post an image. You need to be an MRH subscriber to post photos to our website, and becoming a subscriber is free, [just fill out this form here](#). ■



**Click here for
reader comments**



15%

**OFF ON
EVERYTHING!**

**DID YOU KNOW
TRAINMASTERS TV
MEMBERS GET 15%
OFF ON ALL MRH
STORE PURCHASES?**

**CLICK TO JOIN TMTV NOW
AND START SAVING**



Adding
FALL COLOR
to the West Valley Union Railroad

BY MICHAEL WOLF
.....

Harvest hydrangeas to build high-quality foreground trees ...

MY WEST VALLEY UNION IS A FICTIONAL railroad operating in western Pennsylvania. A branch of the railroad climbs into Appalachian coal country, where forests are a dominate feature along the right of way. Because the upper deck



of my HO layout is only about two feet wide, in many areas there is only track and a forested hillside [1]. To produce a convincing scene, I needed a lot of good quality foreground trees at a very reasonable price.

To say that a layout can consume trees in a hurry is an understatement. With nearly 40 square feet of hillside to cover, I didn't know how many individual trees it would take but knew it would be more than a weekend project. By following the techniques below, you can make a tree in less than a minute

that will cost around 10 cents, and is fairly realistic in appearance.



[Click here for reader comments](#)

Inspiration for my future forest came during a local train show about four years ago. At one of the booths, a vendor was demonstrating the use of dried oak leaf hydrangea blooms, Future floor wax, and ground foam to make good-looking trees in seconds. Although I was several years from planting a forest on my layout, I filed away the idea and started looking for a supply of oak leaf hydrangeas.

Oak leaf hydrangeas (*hydrangea quercifolia*) are native to the southeastern U.S. but they are hardy enough to survive in USDA Plant Hardiness Zones 9-5, essentially all but the northern tier states. While the mop head or puffball-shaped hydrangeas are more popular, the oak leaf variety are present in a lot



1. Limited real estate for tree covered hillsides near the right of way on the WVU RR.



2. Summer blooms on an oak leaf hydrangea bush.

of landscapes in central Ohio where I live [2]. When dry, the remains of their blooms have a good conical tree shape and plenty of surface area to which foam foliage can adhere.

With permission, I was able to trim the dried blooms from three or four homes and businesses for the last three years. Cutting off the dead blooms does not affect the plant's growth or blooms for the next season – most of them fall off if you don't cut them. I typically wait until several weeks after a hard freeze when most of the plant's leaves have fallen [3]. I have even waited until March, but that risks ice and snow damage to the blooms.

I used a pair of pruning shears to cut the stems and tossed the cuttings into a garbage bag. The garbage bags hung in my garage for up to three years until I got around to making my first round of trees. In total, I harvest two to four bags a year. The blooms are pretty sturdy and don't break down while hanging around waiting to be transformed.

ADDING FALL COLORS | 5

Don't waste your time on blooms that don't have a lot of seed pockets [4]. There will be just too many holes in the foliage, revealing a foam-covered trunk. That being said, you'll occasionally see some old blooms from the previous year. I think they make pretty good dead trees to mix in to your forest [5].

Many blooms will have a good side and a flatter side. Much like a Christmas tree, they work fine. Just put the flat side toward the back and no one will ever know. Also, if you find a bush with really large blooms, much bigger than the scale you are modeling, definitely harvest them. You can make two trees by splitting the bloom in two and removing some sprigs to expose the trunk of the upper tree [6-7].

Start from the top

When my layout was ready for trees, I started experimenting with my first bag of blooms. The only tool needed for trimming



3. Time to harvest!



4. Don't bother with blooms lacking nice clusters of seed pods.

and shaping is a pair of scissors. While each bloom is unique, I usually start from the top and work down [8]. The goal is to remove any remaining bloom petals and the fine stems to which the petals were attached. Additionally, you can trim away any seed pockets (branches) that don't look right [9]. With very little practice, I was able to pick up the pace and average

ADDING FALL COLORS | 7



5. Blooms that manage to remain on the bush for more than a year make pretty good dead trees.



6. Super-sized blooms.



7. Make two trees from one.

ADDING FALL COLORS | 8



8. A dried bloom ready for trimming.



9. Finished in less than 30 seconds.

almost two a minute. Invite over a couple friends and watch the blooms fly.

I trim the blooms in the garage. There will be plenty of petals, stems and seeds to sweep up when you're finished. Because dipping and coating the trees is messy, I usually prepare several hundred trees before moving to that step [10].

Some of the blooms are very conical in shape and have potential as conifers. Although there aren't many pine trees in the forest areas I was modeling, I set them aside for later experimentation. Since I was doing fall colors, I found some blooms that looked very good "as is" and set them aside for planting.

The original technique used Future floor wax. Today it is marketed as Pledge Floor Care Multi-Surface Finish. While not as

ADDING FALL COLORS | 9

common as it once was, I found it at Walmart for about \$6 for a 27 ounce bottle. I cut the top off of a round plastic orange juice container to hold the floor wax. You're looking for a container just a little larger in diameter than the blooms and tall enough to completely dip the foliage area. A plastic half gallon milk jug with the top cut off also works. You can reuse the leftover floor finish, however, it's best to do large batches since it takes more than a bottle of floor finish to fill the container at the start [11].

Fine foam foliage

The next component is the foliage. Because I wanted fall foliage, I mixed up six or seven different color combinations. I use paint trays and paint tray liners to hold the foliage. A combination of different ground foam products is used. See the materials list.



10. Garage floor covered in trimmed blooms.

ADDING FALL COLORS | 10



11. Container for dipping and the key adhesive ingredient.

Although I've mixed in some Woodland Scenics coarse ground foam, I've found that finer materials work best.

I also use ground dry leaves to save a little money. Lots of oak trees in my backyard provide tons of free material. Each fall I grind leaves in a blender, and not in the wife's good blender! They are the base layer for most of the scenery on my layout. The ground leaves help dampen the intensity of some of the brighter colored foam. In some color batches, leaves make up 30 percent or more of the mix [12].

The last requirement is a place for the trees to dry. I use leftover pieces of foam insulation board. You can pack the trees pretty closely together. I find that a 16d nail works well to make a hole in the foam for the trunk.

Time to dip

This step is messy, so I use a drop cloth. Grab a bloom by the trunk and dip it top first into the floor finish. Just dip the bloom area. The bloom doesn't need to soak in the floor finish, just get it wet. Pull the bloom out of the floor wax and give it a shake to remove any excess. Move the tree to the foam tray and sprinkle it with colored foam. I use a wet hand/dry hand method. I dip and hold the trunk with my left hand and sprinkle with my right hand.

Foam can be applied two different ways – dump or sprinkle. Each produces a different looking tree. With the dump method, simply grab a handful of foam and dump it on the bloom as you rotate it. The foam tends to go on thickly and in clumps. With the sprinkle method, you lightly sprinkle the foam on to the bloom while rotating it.



12. Trays of colored foliage.



13. Dump method (green tree, left), au natural (brown, center), and sprinkle method trees (orange, right).

For blooms with lots of seed pod foliage, the sprinkle method seems to make a lighter, airier tree. The dump method works better for blooms lacking thick seed pod areas. No two trees in nature are the same so experiment and have fun [13]. Give the tree a gentle shake to remove excess foam and “plant” it for drying. The process goes quickly even when working alone and you can easily dip and coat over 100 trees in an hour.

Depending on the amount of coverage area on the blooms, you’ll need about one bottle of floor finish for 75-100 trees.

ADDING FALL COLORS | 13

Here's a photo of approximately 500 trees [14]. You can see how tightly I packed them. Also, experiment with top dressing some of the trees with other colors to provide highlights, or to simulate outer leaves changing color earlier or later than the main body of the tree. Of course, even if doing spring or summer trees, you'll want to mix three or four different tones of green and some yellow or lighter green highlights.

While the floor finish has a nice lemon smell, the aroma of five bottles of floor finish is a little more than my layout room and family can handle. I let the trees dry in the garage for a week or two until the smell diminishes or is gone. After drying, planting the trees is easy.

Planting the trees

Most of the hillsides on my WVURR are insulation foam board covered with a single layer of plaster-soaked paper towels. The



14. Approximately 500 trees on the drying rack.



15. Hillside prior to forestation.

plaster is painted with brown latex paint and sprinkled with ground leaves and other ground foam products along the edge of the forest where you see through the trunks [15]. I use a 16d nail to make a hole in the foam and then press the trunk into the hole. The trunks fit tightly in the hole and adhesives aren't necessary, even on mobile layouts. In some areas, I used a drill bit to make a hole in the plaster, rock molds, or the Homasote. After planting a thousand or so trees, most of the upper deck is forested [16].

For the transition area along the edge of the tree line, I use a mixture of clump foliage and unused or poorly formed chunks and branches of hydrangea trees as shrubs and small trees [17].

Distant trees

In two areas on my upper deck, I have distant hills in need of foliage. At first, puff ball trees came to mind because they are

ADDING FALL COLORS | 15



16. Nearly completed hillside of trees.



17a-17b. Before and after photos along the tree line.

ADDING FALL COLORS | 16

more than three feet from the viewer and behind some of the foreground trees and industries. However, after calculating how many individual little cotton-ball sized puff balls are required, I looked for another solution. A friend gave me several bags of black fiberfill for making puff ball trees and a new plan emerged – color the fiberfill in place.

I began by stretching about three-quarters of an eight ounce bag of black fiberfill into a thin layer about the size of my first hillside, two by six feet [18]. Earlier, I had re-purposed an old black trampoline mat to become the basic land form over insulation board forms to create the hillside [19-20].

Using a hot glue gun, I tacked the fiberfill to the hillside. It is in a very low traffic area reached by an access hole behind the



ADDING FALL COLORS | 17

foreground ridge line, so it doesn't have to be as secure as scenery near the front of the layout would be.

I spent a few minutes fluffing and stretching the fiberfill for good coverage and create some undulation to the foliage base [21]. I mixed up several paint trays of foliage color foam similar to the colors used for my trees to prepare for my next scenery experiment [22].



18. Black fiberfill stretched to cover a two by six foot area.

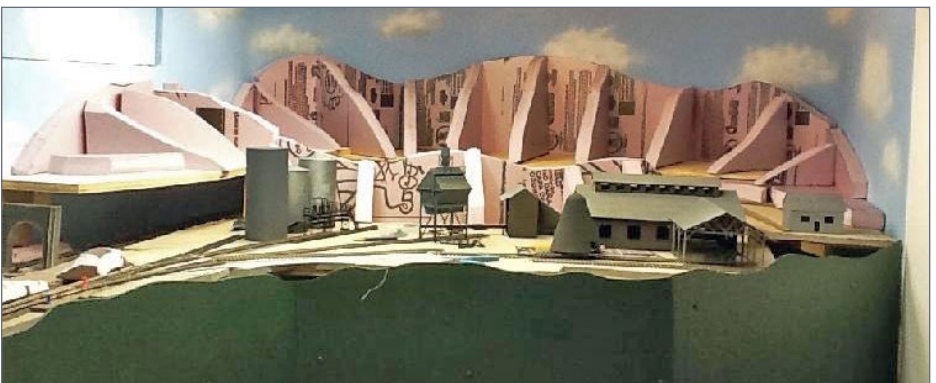

19. Construction of the distant hillside with ridge line in front to hide an access area.

ADDING FALL COLORS | 18



20. Re-purposed black trampoline mat serves as the base for the hillside scenery.



21. The distant hillside has been covered with fiberfill and is ready for hair spray and foam. The clumps of color are chunks of the Woodland Scenics Foliage product. This turned out to be an unnecessary addition.

ADDING FALL COLORS | 19

Then, I donned my dust mask and armed myself with a can of cheap unscented hair spray. Working in a one to two square foot area, I spray the fiberfill with enough hair spray to cause a noticeable mist on the fibers. Then I sprinkle little one to two inch blobs of the various colors. A little hair spray top-coats the foam to glue it into place, and then I move to the next area. Within 30 minutes, I can completely transform about 12 square feet into a pretty convincing distant mountainside [23].

On the right side where the foreground and background trees merge, I used larger puffs of fiberfill and color to transition from individual hydrangea trees to made-in-place fiberfill trees [24].

Correcting bright colors

Pleased with the results of my experiment, I did the same thing on a hillside behind a large mine on the opposite end of the



22. Paint trays with ground foam and dried leaves in various fall color combinations.



23. Finished distant mountainside.

layout [25]. It had a similar black trampoline mat hillside in front of a removable curved backdrop. I used a similar method to cover that hillside, but when I was finished the hillside looked too yellow and bright compared to the foreground trees [26].

I'm not sure if it was because of the lighting in the area or the mix of colors I used but it wasn't good enough for my taste. Fortunately, a quick coat of hair spray, a sprinkling of green foam, and ground leaves toned down the hillside quickly and easily [27]. In this area, there are two front to back transition areas. I started with smaller and smaller pieces and parts from hydrangea trees to gradually transition from hydrangea, to mixed, to puff foliage [28].

The access hatch

One last area remained to be forested. I had made a hatch on the lower level of the layout to access tracks leading to staging [29]. It is sturdy and lightweight, made from foam insulation board, with a thin plaster/paper towel hardshell surface painted



24a-24b. Before and after photos of the transition area between hydrangea and fiberfill trees.

ADDING FALL COLORS | 22



25. Before shot of the hillside behind a large mine.

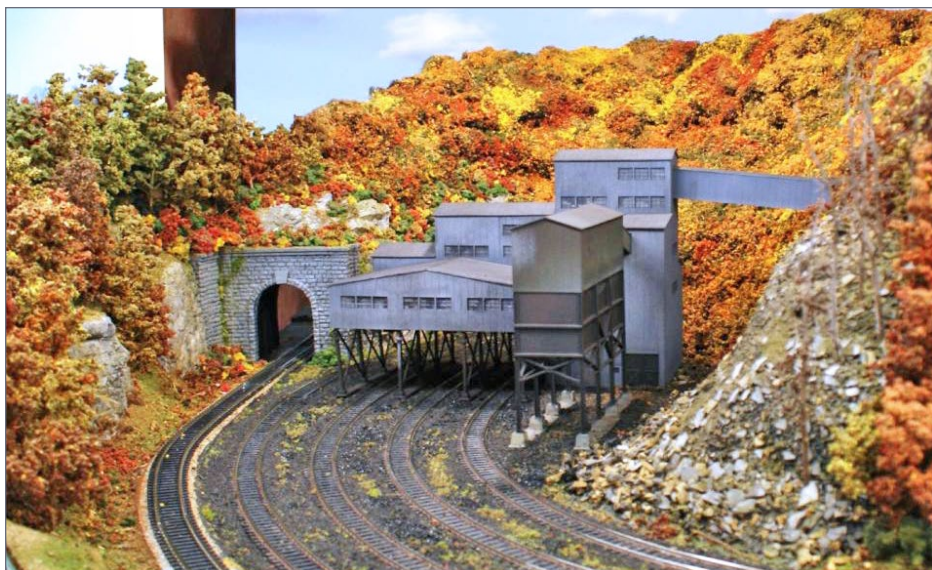

26. Initial colors came out yellow and bright compared to the trees in the foreground.



27. A better match after a top coat of green and brown to tone it down.



28. Transition zone between fiberfill and hydrangea trees.

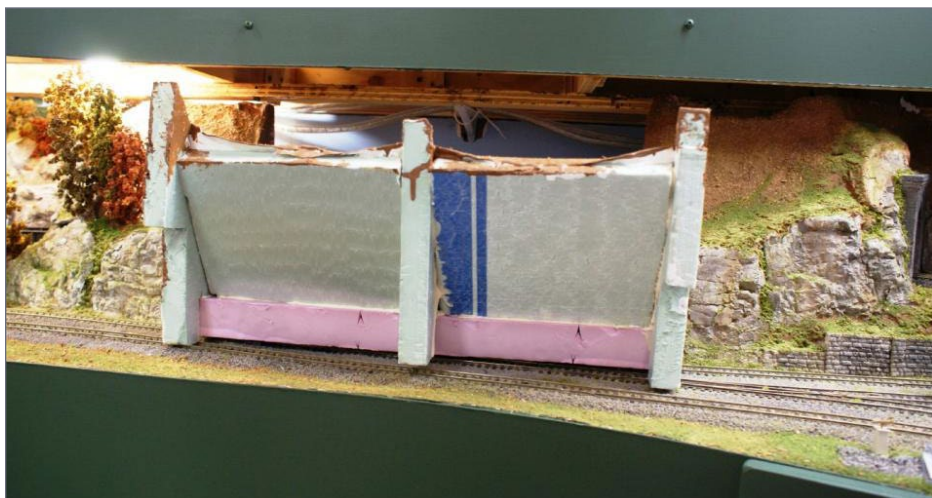

29.-30. Front and back side of access hatch.



[Click here for
reader comments](#)

ADDING FALL COLORS | 25

brown [30]. Working with only a few inches of depth, I wanted to transition from the rock cut next to the mainline to a very steep tree-covered hillside.

I begin by trimming the back of a hydrangea tree to produce a flat surface [31]. Using a hot glue gun, I place a glob of glue on the hardshell and hold the tree in place until the glue has set. By carefully selecting the shape of the trees, I am able to piece them together like a jigsaw puzzle to create a thick canopy



31a-31b. A hydrangea tree trimmed flat on one side for better adhesion.

ADDING FALL COLORS | 26

and disguise the fact that there is only an inch or so between the outer branches and the hardshell [32]. The trees and hot glue are pretty sturdy and the hatch holds up well to frequent removals [33].

I mixed up some darker green foam for my pine tree experiment [34]. I think they work fine when mixed in the deciduous canopy, but I'd probably play around with the color palette if I was going to use them in the foreground.

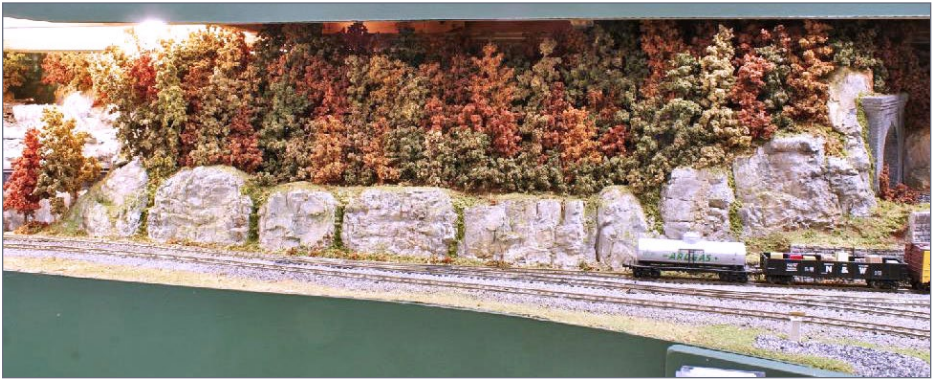

32. The finished hatch.



33. Hatch removed for access to trackwork behind the ridge line.



34. Conifer tree experiment.

There are lots of great techniques for creating realistic model trees. For those who have access to oak leaf hydrangea blooms, I feel they provide attractive, quick and inexpensive trees. Depending on the amount of foam used, I would estimate the cost per tree somewhere around 10 cents. Including trimming and dipping time, you can crank out more than 50-60 trees per hour. Invite a couple of friends over and you'll have a forest before you know it.

My experiments with “foam in place” fiberfill based trees made short work of large areas of distant hillsides. While I model fall foliage on the WVURR, the techniques can be applied to spring, summer or fall depending on your choice of foam color. I welcome your comments.

BILL OF MATERIALS

- Dry oak leaf hydrangea blooms
- Pledge Floor Care Multi-Surface Finish
- Scissors
- Hot glue gun

Various shades and sizes of ground foam:

- JTT Blended Turf - Early Fall, Late Fall, Earth, Yellow Straw, Burnt Grass
 - Timberline Scenery Ground Cover/Foliage - Forest Glen, October Orange, Autumn Gold, Cherokee Sunrise, Santa Fe Sunburst
 - Woodland Scenics Fine Turf – Weeds, Burnt Grass, Green Blend, Yellow Grass, Earth, Light Green
 - Woodland Scenics Coarse Turf – Fall Orange, Fall Rust, Fall Yellow
 - Woodland Scenics Underbrush – Dark Green
 - Noch Leaves – Light Green
 - Dunking container – 1/2 gallon plastic milk jug or juice container with an open top
 - Paint trays or other suitable container, to hold/catch foliage foam mix
 - Drying rack for trees (foam insulation board)
 - Black fiberfill (Putnam Company or others), 8 oz. bag,
 - Unscented hair spray, unscented. ■
-

MICHAEL WOLF



Photo by Lydia Wolf

Michael Wolf's interest in trains began at an early age with Lionel trains at Christmas. In junior high, his 4x8 foot "Christmas Tree Empire" expanded to two sheets of plywood and during his high school years he built his first permanent HO scale layout in a spare bedroom at his grandmother's. College, 23 years as a pilot in the U.S. Air Force, marriage and kids derailed his modeling but his interest in trains remained strong. With military

moves behind him, construction of the West Valley Union Railroad began shortly after moving to Ohio. Thanks to assistance from the Tuesday Night Gang, his modeling and operations skills have expanded a lot in the past six years.

Michael is a corporate pilot and flies around the world. His wife, Julia, a daughter and a son support his hobby, his vacation visits to train-related stuff, and the monthly Tuesday night ops sessions in the basement. When traveling on trips with extended ground time, he travels with a modeling project and his tools. If you find styrene scraps in the hotel carpet, Mike was probably there.

And yes, he is a proud alum of West Virginia University! ■



[Click here for reader comments](#)

WOW!

Premier Scale Trees



Many species of
Conifer trees available!

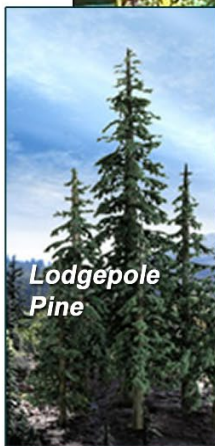

Lodgepole
Pine



Green
Spruce



Blue
Spruce

Also see our other
conifer offerings ...

Click for
more -
lots more!



PREPPING CARS FOR OPERATION

BY JAMES J. EAGER
.....

Easy ways to weight 'difficult' freight cars ...

READY-TO-RUN IS A POPULAR LABEL TODAY, but it isn't always the case. Between building in reliability for operation and following club rules, some work needs to be done on most cars before putting them on the layout. The steps needed are a short list and some cars need more work than others. Even old cars can be brought up to spec, so don't give up.

The first item, couplers, is mostly taken care of on today's cars by the vendors. In 1995, I started converting my cars to Kadees (kadee.com). I took a long-term approach as money was tight – I was on disability at the time – and I had a bunch of rolling stock. I started with one passenger train and worked my way the length of the train over a period of time. I finally finished all the cars last year.

The other thing that the Kadee conversion did was to push me into building an Access database of my rolling stock and including a column to show



**Click here for
reader comments**

what coupler is on each car. This same database has come in handy several times, as it provides a ready list on any large conversion by allowing me to add a new column and check off the progress.

With the rise of DCC, some clubs now require the use of metal wheelsets, and I was no exception. I finally settled on InterMountain wheelsets, which seem to work on all my rolling stock, aren't wildly expensive, and come in bulk packs of 100 wheels. See intermountain.com. I finished up that project last year as well.

Car length in feet	Car length in inches	Scale car length in inches	Length based weight	Total weight
40	480	5.517241	2.758621	3.758621
50	600	6.896552	3.448276	4.448276
60	720	8.275862	4.137931	5.137931
70	840	9.655172	4.827586	5.827586
80	960	11.034483	5.517241	6.517241
90	1080	12.413793	6.206897	7.206897
100	1200	13.793103	6.896552	7.896552
110	1320	15.172414	7.586207	8.586207

1. NMRA weight chart for HO in a spreadsheet.

CAR PREPS FOR OPERATIONS | 3

This brings us to the last major item for prepping a car for operations – adding weight. Any discussion of car weighting should start with the NMRA recommended practices. These recommended practices can be found on the NMRA website, (look at nmra.org/rp-201-car-weight). I entered the data into a spreadsheet, as shown [1].

Or, look at the simple graph shown below [2]

For some people, the above information is enough. For others, including me, this is the lowest acceptable weight for any given car. Some cars are delivered from the vendor well short of these weights. For scales other than HO, the formula constant changes, but the concept is the same.

All of the rest of this article applies to other scales as well, but since I model in HO, my examples are in HO scale.

Weight vs length

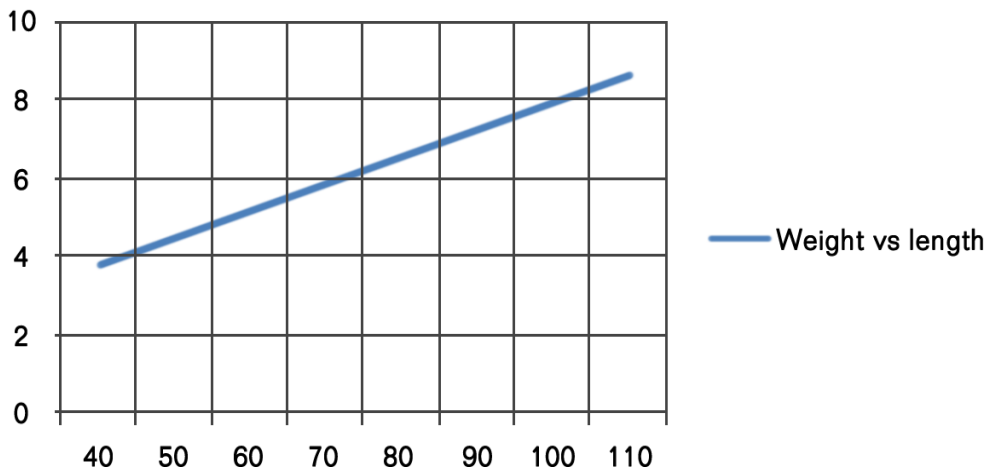

2. NMRA weight done in graphical form.



3. Commercial self-sticking weights.

For some kinds of cars, adding weight can be easy. For a plain boxcar or any other car that can be opened, but runs closed, you have the whole interior to fill with pennies, washers, BBs, or anything of weight that can be glued down. Alternately, lead weights can be purchased in bars [3] with two-sided tape already on them. Just break the bar at the seam and stick the amount needed inside the car in question.

But what about passenger cars that have big windows and (often) an interior? Or how about getting weight into tank cars, or open top cars like flat cars, hoppers, and gondolas?

In the July and August 2013 issues of *Model Railroad Hobbyist*, I wrote about building the City of Miami passenger train. The seven IHC/Rivarossi cars needed weight, which I added via weight kits that include various jigsaw puzzle weights [4] to place under the car floor.

CAR PREPS FOR OPERATIONS | 5

These weight kits are produced by Adair Shops (adairshops.com). This company specializes in internal car weights and car loads.

Open-door boxcars

After I finished the City of Miami, I found that Accurail (accurail.com) was releasing a nice 50-foot welded box car in my chosen railroad (Illinois Central). So, I ordered a dozen of them, and a set of decals to renumber them. I also decided to open up a few of the box cars to detail the interior. Well, these cars come with a bar weight for gluing to the floor. It looks ugly if you want to open the door. What to do?

The answer is another weight offering: boxcar end weights, and wooden decks originally destined for some flat cars, trimmed to fit. In this case, the end weights [5] are heavier than the original weight bar. I subscribe to the theory of making some cars different to draw the eye towards the cars you do extra work on. Only four cars out of 12 got this treatment. The remaining eight got a lighter weight set, still above NMRA standards. You could stack



4. City of Miami coach weights.

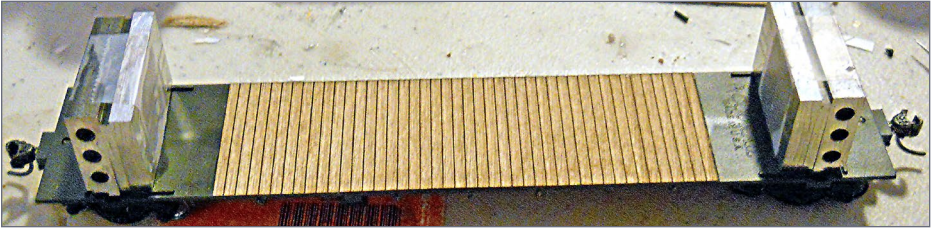

5. Boxcar end weights.



6. Empty Intermountain flat car.

metal washers or pennies in the car ends as well. Just be sure to weight both ends the same.

These cars received palletized loads that can be seen from outside, but that is another article for another day.

Weights for flats

What's next? I am working on wood deck flat cars.

Intermountain [6] makes some really nice flats, including for my favorite road. They were sold years ago as kits, but now you can only get them ready-to-run. Each time Intermountain releases the cars, they make new road numbers. The problem? The flat cars are way too light. These don't even come up to NMRA standard weights, and they tend to jump from the track.

I could tape some weight to the bottom of the car, but it would show. The answer here is to add a permanent load¹. Several

¹ (Editorial comment) Adding a permanent load to a flat car greatly reduces its utility, making it into a one-way-only loaded car in op sessions. Better is to use more clever methods such as adding tungsten (1.8x heavier

CAR PREPS FOR OPERATIONS | 7

companies make flat car loads of metal objects. Adair Shops offers nice steel plates, steel beams, even steel pipe loads. For the do-it-yourself type, get some metal pipe from plumbing supply, cut it to length, paint, and build a wooden cradle [7]. If you build the load as a unit [8,9,10,11], it can be added and subtracted as needed for an op session.

than lead) between underframe members, replacing the underframe beams with metal, using all metal trucks, and wrapping the wheel axles with solder. More on these and still other weighting methods in an upcoming book series called "Make it run like a dream" in 2016. - Joe Fugate



7. Custom wood cradles.

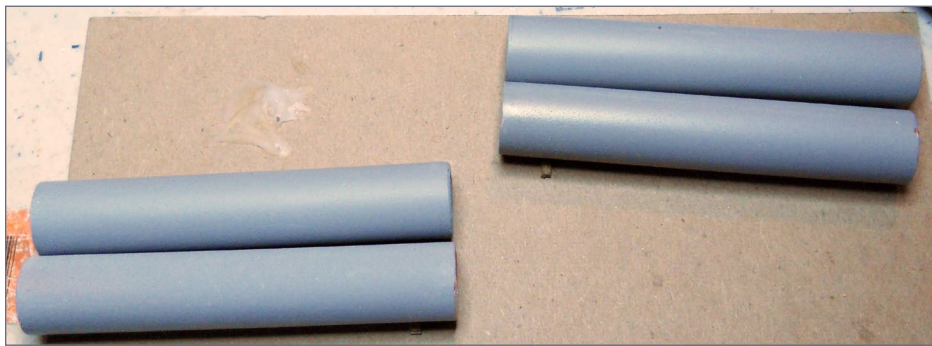

8. First layer of pipes.

CAR PREPS FOR OPERATIONS | 8

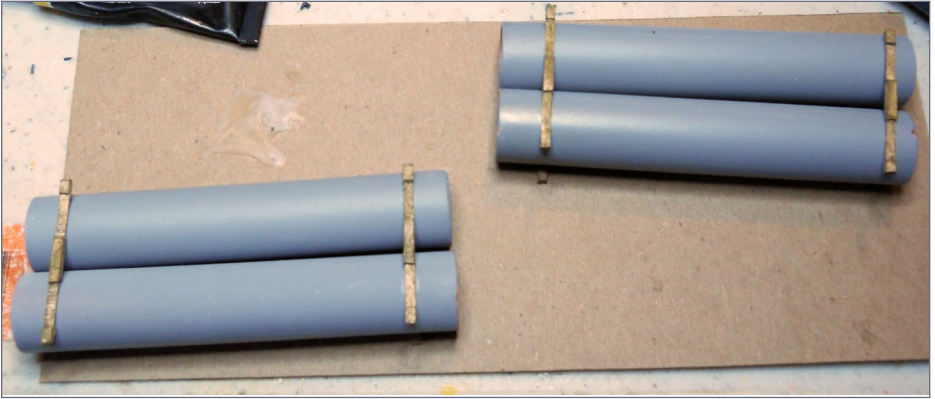

9. Second layer of cradles.

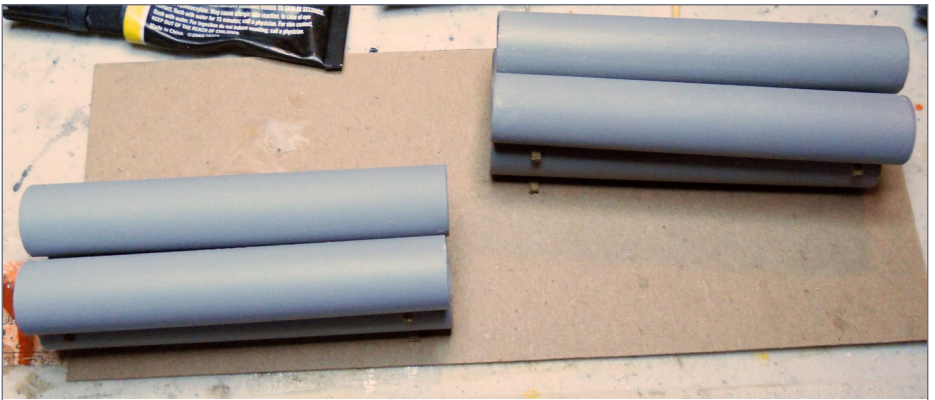

10. Second layer of pipe.



11. Fully loaded flat car.



12. Intermountain flat car with metal plate load.

If you want to get really fancy, each car can have different loads for different stops on the op session. The above pipe loads lift right off, and I have a steel plate load to fit the same car [12].

Weighting assembled cars

Next up are Intermountain grain cars and some other closed cars. Can't open them? The Intermountain cylindrical hoppers have a small hole on each end. Small metal bars can be slid into those holes (Adair Shops) or the holes are small enough for BBs, a lot of BBs, in fact. What if there is not a hole? Now is the time to find a drill bit just a slight bit larger than the lead shot you are using. Find a spot where the hole will be hidden and drill into the car. You can cover the hole up later.

The metal bars purchased from Adair Shops for the cylindrical hoppers don't have much room to move by the time you get them in, so fastening them down isn't necessary. I mention lead shot because it is a common solution, but I don't actually have any cars set up that way. Some people affix them, and some probably don't.

Look for ways into a car. I like old "blue box" Athearn tank cars – they're held together by screws. You can easily open them up to add weight inside the tank, either custom weights (Adair Shops), sticky weights, or something else.

Look around for new kits. Before you start to assemble them, look to see where you can install weight during assembly.

CAR PREPS FOR OPERATIONS | 10

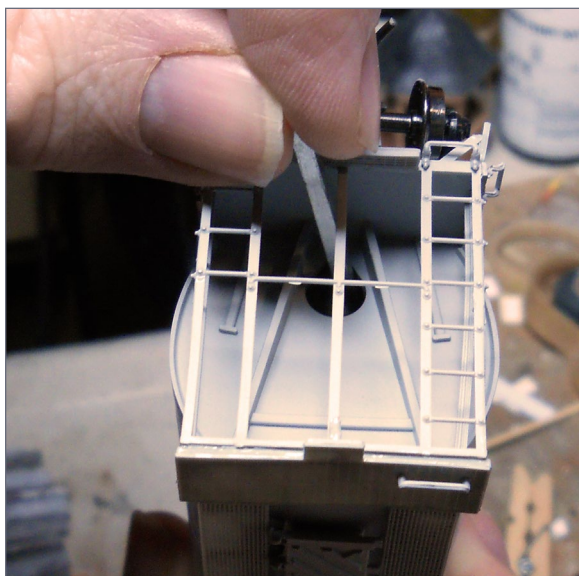

13. Adding weight bars to a covered hopper car.

Another unit train I am working on is a set of 16 gondolas. These are another nice kit released by Accurail. Before assembly, I found that Adair Shops has replacements for the metal bars that go under the floor of these cars, adding weight when

swapped in for the weights that come with the kits. But with gondolas and hoppers, you can add loads as well.



14. Gondola with steel beam load.



15. Gondola with pipe load.

Pipe and beam loads are great for someone like me who doesn't want to hide the extra wooden decks I put into the gondolas.² But there are other kind of loads you can add. You can build a wooden plug to fit into the car and glue anything you like on the top – the “trash” gondola load – and can put any amount of weight under the deck. Coal, crushed rock, and sand are options. Let your imagination run – or match it up to the industries your railroad serves.

Finally, you may not be able to weight every car. If this is the case, make sure that the ends of the train have heavy cars and put the light ones in the middle for best operation. For the more detail minded, you may want strapping around some of your loads. Now where did I put that scale chain?

² You can also add weight to open top cars by adding a false deck or false bottom to the inside. If you make the false deck/false bottom out of lead sheet, you automatically get extra weight. - Joe Fugate

JAMES EAGER



James J. Eager has been a programmer and database administrator for several major corporations.

He and his brother each received trainsets which led to a father and sons' layout in the basement, a Model Railroading Merit Badge, and a long-term interest in model railroading.

In 1997, as part of a Jacksonville model railroad club, one of his structures was shown in a TV commercial for the Ronald McDonald House Christmas charity layout at the mall.

James has a long-time interest in the Illinois Central, along with the B&O and ATSF. ■



[Click here for reader comments](#)

53,000 have seen this MRH video - *have you?*



[Watch the video now](#)





SOUTHERN PACIFIC'S

Passenger cars:

More than just the Daylight, Part 6

BY V. S. ROSEMAN

.....
*Photos by V. S. Roseman
unless otherwise noted*

PART 6: MORE HEAVYWEIGHT CARS YOU CAN BUILD

IN PART 5 LAST MONTH, I INTRODUCED YOU

to different heavyweight baggage cars you could kitbash or scratchbuild to more accurately model some of Southern Pacific's different passenger trains through the years.

Here in Part 6, I continue looking at other heavyweight cars you can model, as well as provide tips on modeling passenger cars in general. Even if you don't model the SP, you should find these passenger car modeling tips useful.

MRHMAG.COM

- [TABLE OF CONTENTS](#)
- [INDEX](#)



1. Heavyweight diner Class 77-D-4 (or hamburger grill) kitchen side. Diners and hamburger grill cars were externally similar.



[Click here for
reader comments](#)

Heavyweight dining cars, Classes 77-D-1, 77-D-3, 77-D-4 and 77-D-6 through 77-D-10

The Coast (Morning) Daylight always had first priority for streamlined dining cars. Any other lightweight diners had to be spread

REMOVAL

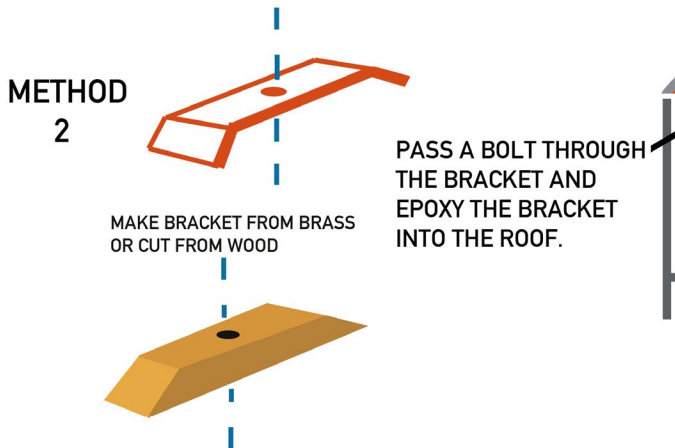
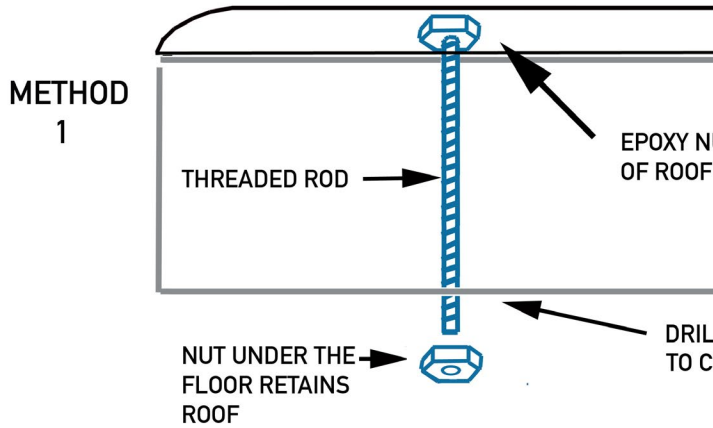

2. Mounting a removable roof for almost any model passenger car.

PART 6 - SP PASSENGER CARS | 4

among the Noon Daylight (probably second priority for these) and then other trains. With only a few lightweight food service cars available until 1949, modernized heavyweight cars had to fill in on important trains. Generally, extra sections of the Coast Daylight ran with these older cars, and often times the San Joaquin also had

BLE ROOF

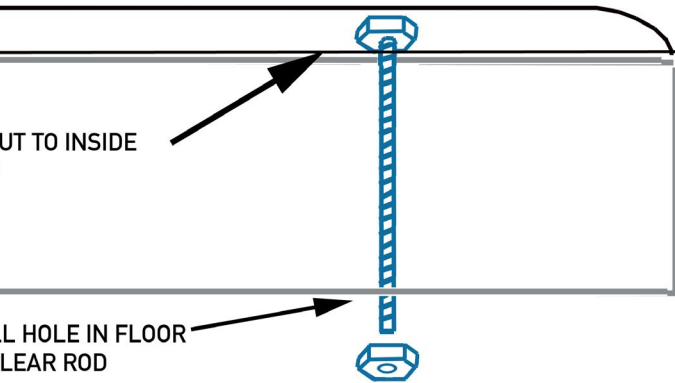

(END VIEWS)

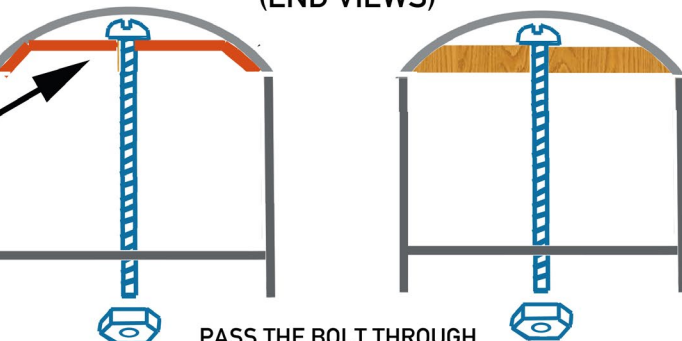

PASS THE BOLT THROUGH HOLE IN THE CAR FLOOR AND RETAIN THE ROOF WITH A NUT

COMMON STANDARD PASSENGER CAR UNDERFRAME STRUCTURE

(BASED ON MEASUREMENTS OF S.P. HEAVYWEIGHT PASSENGER CAR)

NOT TO SCALE

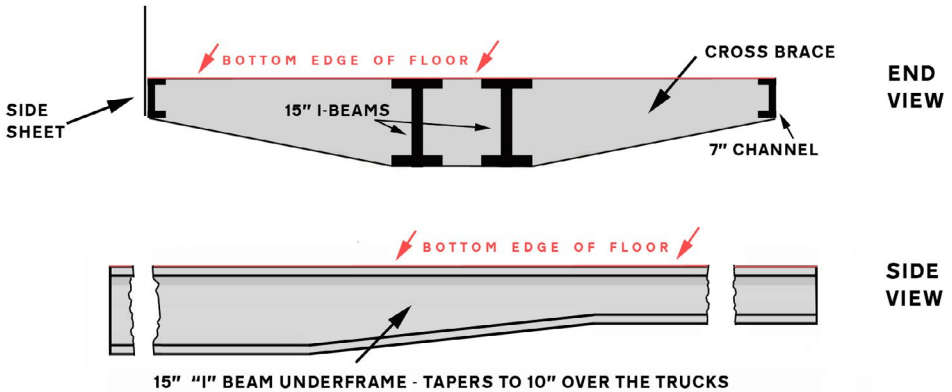

3. Common Standard type bar girder underframe.

heavyweight dining cars. A few of these were painted in Daylight colors, while the others were either two-tone gray, or dark olive.

These dining cars rode on various truck types, all with six wheels. 77-D-3 and 77- D-4 class arch roof heavyweights assigned to the San Francisco Overland were painted in UP yellow.

When the San Joaquin Daylight had a collision in 1947, one of its lightweight diners was wrecked, after which one consist was assigned a heavyweight diner and heavyweight lounge car for several years. Eventually, attrition of trains by the early to mid-1960s exceeded the heavyweight dining cars which were sold, scrapped or put into SP maintenance service.

The Rivarossi heavyweight 1920 series heavyweight dining car (Santa Fe prototype), the International Hobby Corp. heavyweight (B&O prototype) dining car, and the Walthers heavyweight diner

COMMON STANDARD PASSENGER CAR UNDERFRAME AS USED IN SOUTHERN PACIFIC HEAVYWEIGHT CHAIR CARS AND OTHERS

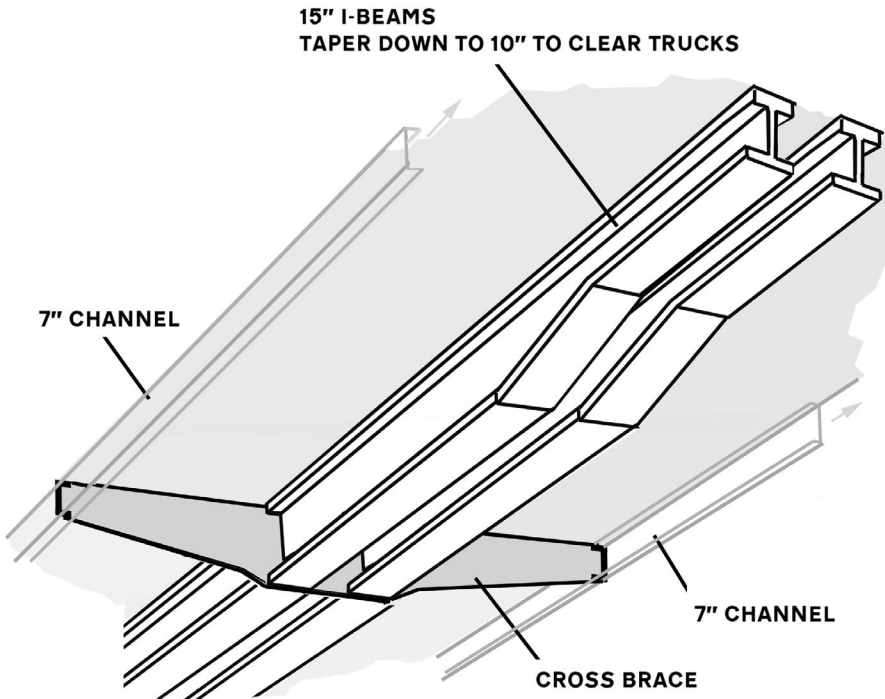

4. Common Standard underframe diagram.

(932-10159) are all similar to the SP's clerestory roof dining cars in classes 77-D-5 through 77-D-10, and any of these could stand in with just a paint job in SP colors.

I have modified some Rivarossi diners to more closely resemble SP prototypes during the streamlined era when they had been modernized with air conditioning. The small single window on both sides of the model should be filled with sheet styrene. Cut a fourth kitchen window, rearrange the kitchen window muntins with one horizontal muntin, and cover the transom windows.

COMMON STANDARD UNDERFRAME ARRANGEMENT

(NOT TO SCALE)

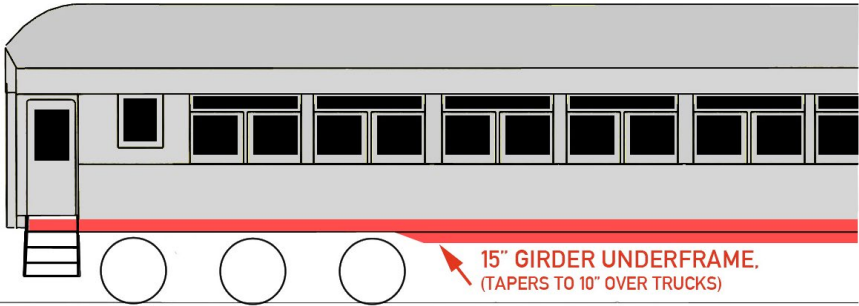

SKETCH SHOWS RECESSED FLOOR - UPPER EDGE OF RED UNDERFRAME IS THE BOTTOM OF THE FLOOR

MOST MODELS DO NOT HAVE THE FLOOR RECESSED SUFFICIENTLY TO PERMIT MODELING THE FULL UNDERFRAME

5. Common Standard type bar girder underframe.

The letterboard can be widened by plating it over with styrene strip. The right end of the aisle side of the car (as you face it) should have a fourth large window, and while there is room to cut one, it no longer leaves the wide space between the two sets of windows. Correcting this would require making many cuts into the car and I didn't feel it was justified.

My car is incorrect by one window, the vents at the car ends (which I did not remove), and the door which does not belong on the aisle side of the car. The prototype SP cars have a small window in the same location as the window of the door, and I just left it as it was.

Use .005-inch thick styrene to fill the simulated channel underframe at the bottom of the car sides, although this hardly shows. The fish belly underframe should be cut away and replaced with plastic strip to simulate the bar frame. A shortcut is to cut about

PART 6 - SP PASSENGER CARS | 8

SP HEAVYWEIGHT DINING CARS- SOME MAJOR VARIANTS

CLASSES 77-D-1, 77-D-3, 77-D-4

ARCH ROOF DINING CAR AS BUILT WITH TRANSOM WINDOWS

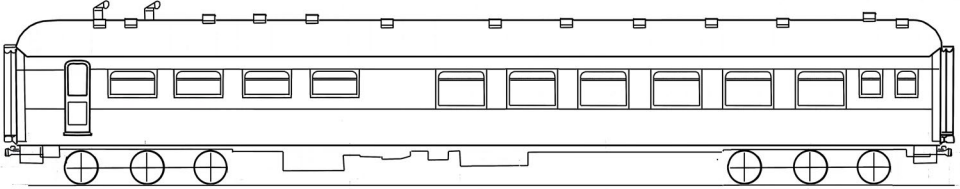

ARCH ROOF DINING CAR- MODERNIZED WITH AIR CONDITIONING - TRANSOMS REMOVED

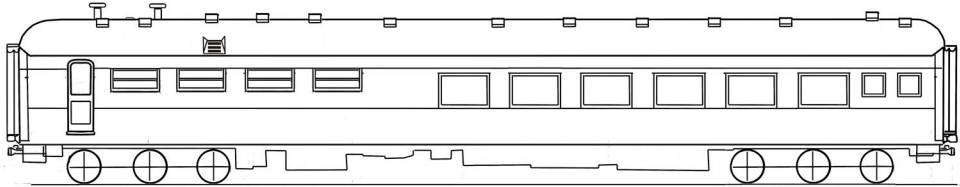

(LATEST STYLE KITCHEN VENTS SHOWN ABOVE)

AIR CONDITIONING MACHINERY FITTED BELOW THE CARBODY

CLASSES 77-D-6, 77-D-7, 77-D-8, 77-D-9

CLERESTORY ROOF DINING CAR AS BUILT

(CLERESTORY ROOF CARS NEVER HAD TRANSOMS)

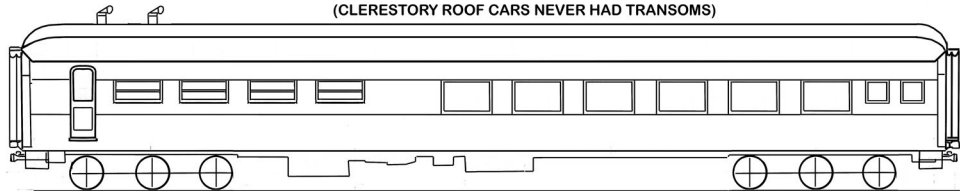

CLERESTORY ROOF DINING CAR - MODERNIZED WITH AIR CONDITIONING

(SOME CARS HAD INSIDE AIR DUCTS THAT DID NOT SHOW)

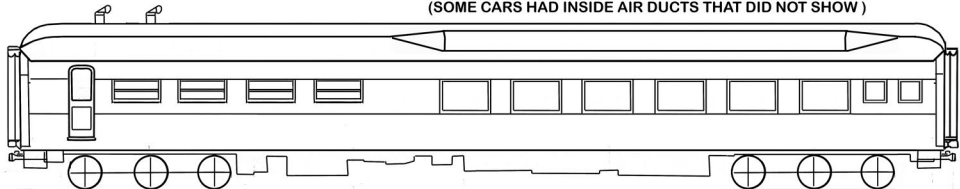

AIR CONDITIONING MACHINERY FITTED BELOW THE CARBODY

6. SP Heavyweight dining car sketches showing a few variants.

SP HEAVYWEIGHT DINING CAR CONVERSIONS CHART: From N, HO Rivarossi model

- All cars painted SP dark olive green with gold lettering as built.

Notes show repaint colors if different from green.

- There was no Class 77-D-5

- Class 77-D-2 had a different kitchen window arrangement than the cars shown

77-D-1 (arch roof)

T&NO 915-919 built 1916

Cars 915, 917, 918, 919 received ice a/c 1935. Scrapped or sold 1953-1956.

Trucks: 6-TC-1 top equalized, replaced 1927-8 with 6-T drop equalizer trucks

Cars 915 and 917, 918, 919 refitted with 6-TC-2 drop equalizer trucks

Car 915 refitted in 1938 with 6-TC-2 drop equalizer trucks

Cars 918, 919 to lunch lounge cars for Hustler, 1952

77-D-3 (arch roof)

SP 10098-10107 built 1924

This class received Waukesha a/c 1937-40. Scrapped or sold 1955-1960.

Trucks: 6-TC-2 drop equalizer type

NOTE: 10098, 10099, 10100 all Lark gray, 10099 UP Yellow 1957, 10104 Lark gray 1956

77-D-4 (arch roof)

SP 10108-10117, T&NO 920-922

T&NO 920 to SP 10006 2nd 1929

*M< 923, 924 (TO SP 10009 2nd, 10010 2nd 1929) *(M< = Morgan's Louisiana & Texas RR)

Built 1924. Class received Waukesha a/c,

1937 (except 10108, ice a/c 1936) scrapped or sold 1956-1962

Trucks: 6-TC-2 drop equalizer type

NOTE: 10006 2nd, UP yellow 1957, 2nd silver w/red 1959; 100009 2nd Lark gray,

UP yellow 1957, silver w/red 1959; 10010 2nd Lark gray, 10109 Lark gray 1947,

10112 Lark gray, UP yellow 1957; 10114 Lark gray 1956,

10115 Daylight colors 1947; 10116 Lark gray 1947, 10117 Daylight colors 1950.

7. Dining car detail chart, part 1

77-D-6 (Clerestory roof)

SP 10003 2nd, 10016 2nd, 10017 2nd, 10018 2nd, 10019 2nd, T&NO 933, 10026 to 10041 built 1927
Ice a/c 1936, replaced with Waukesha a/c 1937-1939 except 10018, 10019.

Scrapped or sold 1954-1960

Trucks: 6-TC-2 drop equalizer type

NOTE: 10010 Lark gray, 10017 Lark gray 1950s, 10038 Daylight colors 1948

77-D-7 (Clerestory roof)

SP 10126 -10131 built 1927 Class received ice a/c 1935, 36. to SP MW 1955-57

Trucks: 6-TC-5 drop equalizer type

Cars had outside a/c ducts on roof. Car 10128, 10131 had air duct inside the clerestory.

77-D-8 (Clerestory roof)

SP 10132-10137 (10133 to T&NO 932 2nd 1950, 10133 to T&NO 933 2nd 1950) built 1929

Class received ice a/c 1935 to SPMW 1955-56. Car 10134 scrapped 1958.

Trucks: 6-TC-6 drop equalizer type

77-D-9 (Clerestory roof)

SP 10138-10157, T&NO 925-929 built 1929

Cars 10138-10144, 10146-10148, 10154-10157

received Pullman Mechanical a/c 1932, received sub cooler 1939

Cars SP 10145, 10149-10153, T&NO 925-929 received ice a/c 1934, retired 1954-55

10140, 10141 converted to postal baggage cars 5044, 5045 1954

10143 scheduled for conversion to postal-bagg. 1952, cancelled, retired 1954;

10156 scheduled for conversion to postal-bagg. 1952, cancelled, retired 1955;

T&NO 925, 926 to N de M 1958

Trucks: 6-TC-6 drop equalizer type

Roof mounted air ducts, outside: 10138, 10139, 10148, 10153;

inside air duct 10152, 10157, T&NO 927 10148 Daylight colors

8. Dining car detail chart, part 2



9. Model of a clerestory roof SP dining car (77-D-9) aisle side.

half the material away from the fish belly which comes pretty close to the appearance of a Harriman type bar frame. See the Class 77-D illustration. The letterboard could be made to look smoother if covered with strip styrene as shown in the steps.

To build the arch roof diners in classes 77-D-3, 77-D-4, use two roofs from Roundhouse round roof Harriman cars spliced to fit this car. Cars in classes 77-D-6 through 77-D-10 had clerestory roofs, and if modeling one of these cars, the original Rivarossi roof is used. These cars had narrow air conditioning ducts added over the dining areas, although some cars had their air ducts inside the clerestory. I used strips of Evergreen styrene, sanding these to represent the ducts.

PART 6 - SP PASSENGER CARS | 12



10. Prototype SP diner Class 77-D-3 10102, aisle side.
Courtesy Bob's Photos



11. Class 77-D-4 dining car, nearly identical to 77-D-3. Kitchen side of car 10006 shown in the mid-1960s in imitation stainless steel with red letterboard paint. *Courtesy Bob's Photos*

SP CLASS 77-D HEAVY

MADE FROM RIVAROSSA SANTA FE

SP CLASS 77-D-1 THROUGH 77-D-4 HAD ARCHED ROOFS, CLASS 77-D-5 (THE CLASS OF FORMER EL PASO SOUTHWESTERN DINING CARS-SP 1012)

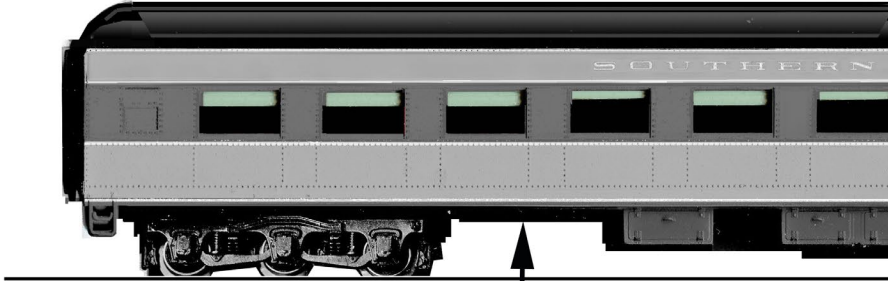

AISLE SIDE

(CUT AWAY THE FISHBELLY UNDERFRAME AND REPLACE WITH STRAIGHT BAR TYPE)

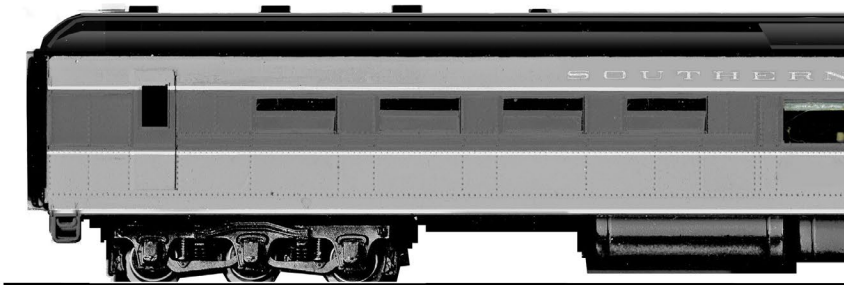

KITCHEN SIDE

CUT A NEW FO

MODIFY THE KITCHEN WINDOWS

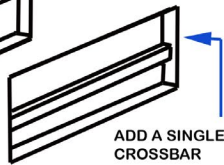
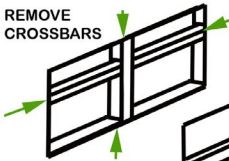

FOUR VENTS OF THIS STYLE WERE TYPICAL OVER THE KITCHEN

FOR CLASSES 77-D-1 THROUGH 77-D-4, USE TWO ROOFS FROM

RENDERING SHOWS THE BASIC CAR WITH KITCHEN VENTS OR AIR CONDITIONING SYSTEM

WEIGHT DINING CAR

PROTOTYPE MODEL IN HO OR N SCALE

77-D-6 AND LATER ALL HAD CLERESTORY ROOFS.

10123, 10124, 10125- WERE SIMILAR TO 77-D-6 BUT HAD HIGHER ROOF)

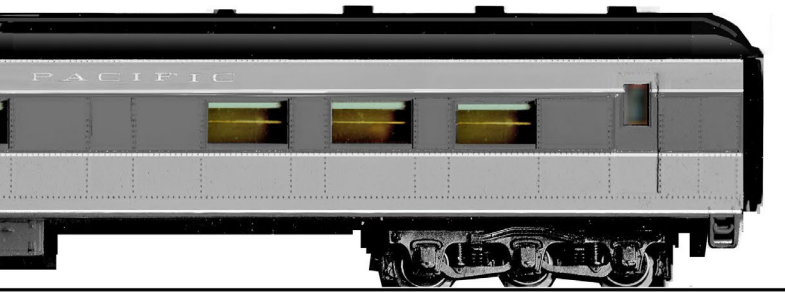

(MODEL SHOWS THE ORIGINAL NON-AIR CONDITIONED RIVAROSSO UNDERBODY. AIR CONDITIONING APPLIANCES SHOULD BE ADDED)

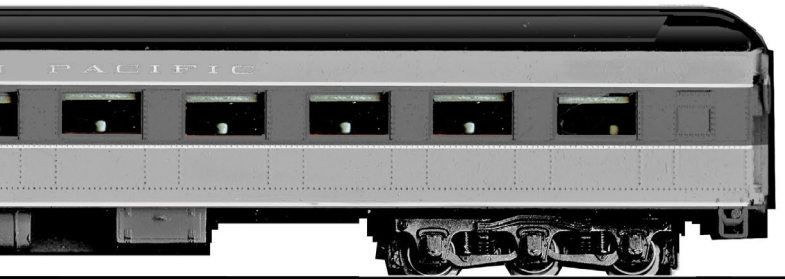

URTH KITCHEN WINDOW

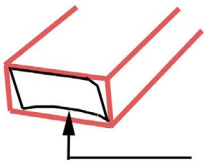

FILE THE FORM FROM A THICK STYRENE STRIP

FILE THE BOTTOM TO CONFORM TO THE ROOF

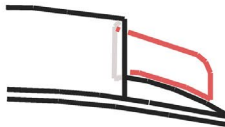

AIR CONDITIONING DUCT SHAPE

M ATHEARN - ROUNDHOUSE CARS SPLICED

OUT ANY ADDED HANDRAILS,
SYSTEM ADDED

12. Detailing the Rivarossi model to resemble SP clerestory dining cars. (77-D-4 through D-9 and class 80-D-1, plus hamburger grill cars).

Suitable kitchen vents should be added either from one of the after-market part companies or made up by the modeler.

For the underbody air conditioning units, Railroad Prototype Encyclopedia volume 11 describes both steam ejector and Waukesha systems and shows all the appliances. I sanded the arch roof to

Heavyweight dining cars repainted in Streamliner colors

CLASS 77-D-3 (Arch roof)

10098 two-tone gray 7/23/42

10099 yellow- 5/25/57

10100 two-tone gray 8/5/42

10104 two-tone gray 1/20/56

CLASS 77-D-4 (Arch roof)

10006 yellow 5/25/57

10009 two-tone gray 1950s -yellow 5/25/571-stainless w/ red 4/59

10109 two-tone gray 1950s

10110 two-tone gray 3/5/47

10112 two-tone gray 1950s - yellow 5/10/57

10114 yellow 3/56

10115 Daylight 1947

10116 two-tone gray 2/21/47

10117 Daylight 6/23/50

CLASS 77-D-6 (Clerestory roof)

10016 two-tone gray 3/16/56 10017 two-tone gray 3/56

10038 Daylight 5/15/48

10040 Daylight 5/27/48

CLASS 77-D-9 (Clerestory roof)

10148 Daylight 1956

13. Dining car colors chart.

PART 6 - SP PASSENGER CARS | 16



14. Dining car 10138, Class 77-D-9 with clerestory roof, kitchen side at Oakland, CA. *Courtesy Bob's photos*



15. Texas & New Orleans RR (SP subsidiary) car 927, kitchen side. Class 77-D-9 with ice air conditioning boxes shown coupled to Texas and Pacific car. *Courtesy Bob's photos*

SOUTHERN PACIFIC HEAVYWEIGHT

FROM RIVAROSSI 1920 SERIES HEAVYWEIGHT A

1. PATCH SMALL WINDOW ON BOTH SIDES OF CAR

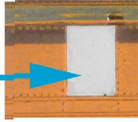

2. FILL ALL TRANSOM WINDOWS-

CUT NEW

KITCHEN
SIDE
OF
CAR

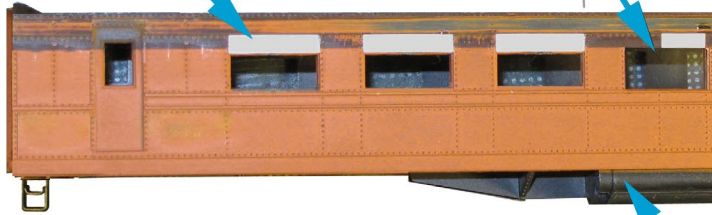

4. OVERLAY TRANSOMS WITH NEW LETTERBOARD
FRAME NEW

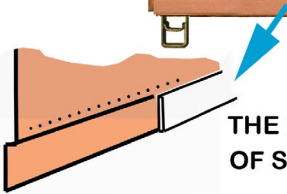

THE RECESS ALONG THE LOWER EDGE OF THE C
OF SANTA FE CARS. IF THIS IS OBVIOUS, IT CAN E

5. FILL ALL TRANSOM WINDOWS- OVERLAY THE TRA

AISLE
SIDE
OF
CAR



CLASS 77-D-3 AND HIGH
THIS LEAVES A VERY S
MY CARS WITH JUST T

SHORT DINING CAR CONVERSION

AT&SF DINING CAR MODEL HO AND N SCALE

16. Steps to convert a Rivarossi Santa Fe dining car to resemble an SP diner.

7 KITCHEN WINDOW

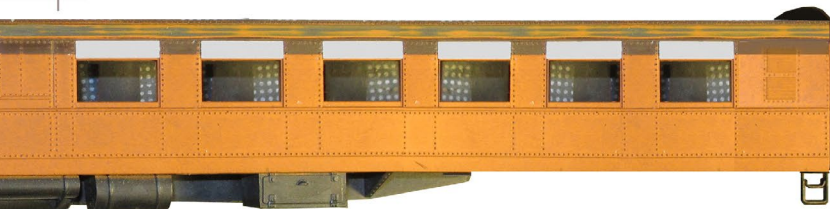

SAW OFF FISHBELLY UNDERFRAME AND REPLACE WITH BAR GIRDERS

W FOURTH KITCHEN WINDOW WITH PLASTIC STRIPS



AR REPRESENTS THE CHANNEL UNDERFRAME
BE COVERED WITH .005" OR .010" THICK STYRENE STRIP

NSOMS WITH NEW LETTERBOARD AS ON AISLE SIDE OF CAR

PATCH SMALL WINDOW



SHER HAD A FOURTH AISLE WINDOW THAT COULD BE CUT IN THE RIVAROSSO SIDE.
SHORT BLANK PANEL BETWEEN THE DINING AND AISLE WINDOWS, AND I LEFT
THE THREE ORIGINAL AISLE WINDOWS.

PART 6 - SP PASSENGER CARS | 19

eliminate the heavy rivets, and lightly scribed lines to represent the sheet steel roof, or canvas soaked in waterproofing over the roof. Most of these dining cars were painted dark olive green, but by the 1950s some were painted two-tone gray, and some were even painted Daylight colors.

The Class 77-D-2 has just three large aisle windows (like the Rivarossi model) but the kitchen side is a more complicated arrangement and as these were only ever painted in green I have not included this class.

Some of these cars were modified into coffee shop cars and hamburger grill cars with little if any exterior changes. These ran in various combinations with a regular diner or sometimes a lounge car.

On the San Joaquin Daylight of the 1950s, a diner was often run kitchen to kitchen with a coffee shop car, hamburger grill or another diner. And in peak periods the train sometimes ran 15 or more cars and another heavyweight diner (probably a green one) would be placed further down in the train.

A brief note about painting and the importance of working from photos. In one of the SP Passenger Cars books, (Volume 4, page 134) is a photo of a two-tone gray Class 77-D-2 diner with the top separator stripe and part of the upper light gray letterboard color actually painted several inches into the roof. This was to match the height of lightweight cars with which this car would serve. Not all the cars were painted in this way, so work from a photo whenever you can.

If these conversions are not close enough to the prototype for you, many good brass cars have been made available. The purchase of one or two brass cars is less of a strain on finances than buying a whole train.



17. A 75-CS-2 lounge car as it ran on the San Joaquin, at the Oakland Mole, CA.

Heavyweight lounge car Class 75-CS-4

In the San Joaquin Daylight's 1947 accident at Kingsburg, CA, the lightweight tavern car in one consist was destroyed and was replaced with paired window type heavyweight lounge car #2920, Class 75-CS-4. This car was one of several similar cars to be modernized, and this one had small windows due to the covering of the original transom windows. The other cars in this group had taller windows that reached the letterboard. A composite sketch of each side is shown.

Car 2920 was painted in Daylight colors, and the other cars in the class were two-tone gray or dark olive. Photos show these lounge cars sometimes substituted for 2920. The railroad began scrapping this class in 1957. I have not found any good stand-in for this car, but it generally resembled the Bachmann 10-2-1 sleeping car converted to a round roof. The prototype car ran or was available till it was scrapped in 1956.

SOUTHERN PACIFIC CLASS

USED ON SAN JOAQUIN DAYLIGHT

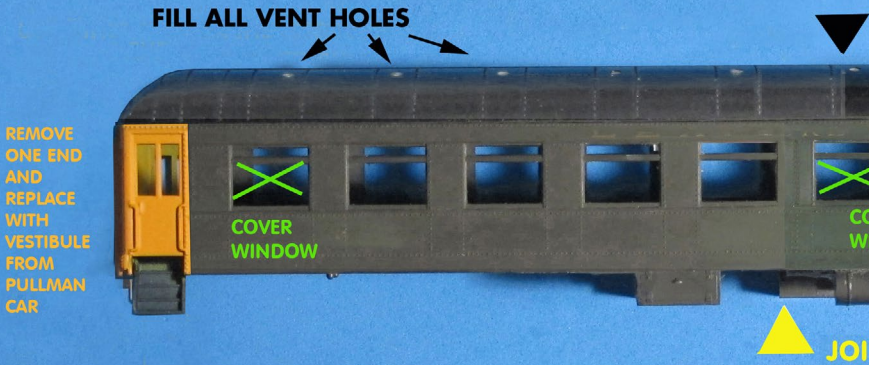

CAR REQUIRES TWO RIVAROSSI 1920 HEAVYWEIGHT DINING CAR BODIES
ONE VESTIBULE FROM RIVAROSSI 1920 HEAVYWEIGHT PULLMAN CAR
TWO ROOFS FROM MODEL DIE CASTING-ROUNDHOUSE, ATHEARN HARRIS



(WINDOW ARRANGEMENT OF OTHER SIDE OF BODY IS EXACT OPPOSITE OF THIS SIDE)

18. Model made from spliced Rivarossi diners and converted to 75-CS-2 SP lounge car as ran on San Joaquin Daylight starting 1956.

Class 75-CS-2 lounge car for San Joaquin Daylight

Several descriptions indicate that in 1956 a class 75-CS-2 lounge with wide windows and semi-circular bar was assigned to the San Joaquin, but it appears that this may have been a protect car that ran only when needed to replace an out-of-service tavern.

CLASS 75-CS-2 LOUNGE CAR

FLIGHT MID TO LATE 1950s

JOIN TWO ROOFS

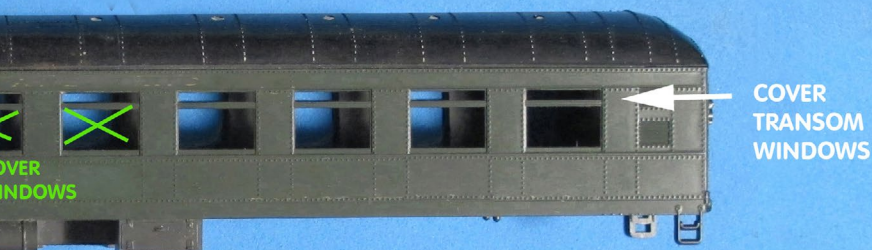

JOIN TWO BODIES

REMOVE FISHBELLY
UNDERFRAME AND REPLACE
WITH BAR FRAME

FROM RIVAROSSA DINING CARS

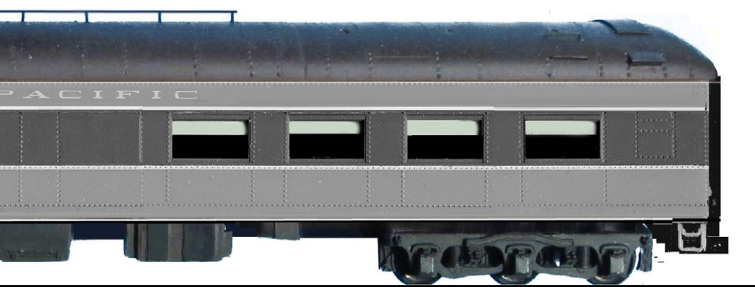

(SIDE)

A replica of the class 75-CS-2 car can be made starting with two Rivarossi 1920 series dining cars. The main part of this conversion is to splice the dining ends of the two carbodies. The source cars are each cut at the center and joined with styrene cement, although I suggest adding reinforcements such as styrene strips inside the car. A brass floor epoxied into the car will strengthen it a great deal. Transoms and the center windows are covered with .010 styrene as shown in the photos. One vestibule end from a Rivarossi 1920s

Pullman car is spliced to replace one dining end. Cut off the existing end to match the length of the new vestibule end so the car remains the same length.

A roof antenna with 16 stanchions is added for car 2980. I use .030-inch brass wire for the antenna. I cut the wires into upright supports about 1/4-inch each and tinned one end of each. I drilled the holes for these uprights and inserted the wires. I placed a piece of .060-inch square basswood on the roof as a guide to position these antenna uprights.

The top wire was soldered to the end of the uprights one at a time working from one end. I suggest using a heat sink on each upright as you solder to avoid overheating the roof. Radio Shack has a soldering heat sink clip tool (#276-1567, \$2.49 each) that works well in this application. The Class 75-CS-2 cars were all air conditioned with two-engine Waukesha units.

After adjusting the top wire to be sure it is straight and leveled, I placed a dot of super glue inside the roof at the entry of each wire and let it dry. Then I cut off the excess wire lengths. Lounge furniture is available from Precision Scale, Red Cap and other manufacturers.

While car 2980 was painted in Daylight colors in the 1950s, the other similar cars were either two-tone gray or dark olive green. These were out of service by the mid-1960s and most of them were scrapped.

Clerestory and arch roof 72-foot heavyweight coaches and chair cars

You might think these old-looking cars were the last kind of equipment the railroad would use on a streamliner, but these

PART 6 - SP PASSENGER CARS | 24



19. Model of SP lounge car Class 75-CS-2 used in mid 1950s on the San Joaquin Daylight.



Playback problems? [Click here ...](#)

SOUTHERN PACIFIC CLASS 75-CS-2 LOUNGE C

REQUIRES TWO RIVAROSSI 1920 SERIES DINING CARS, ONE
TWO HARRIMAN CAR ROOFS FROM ROUNDHOUSE/ATH

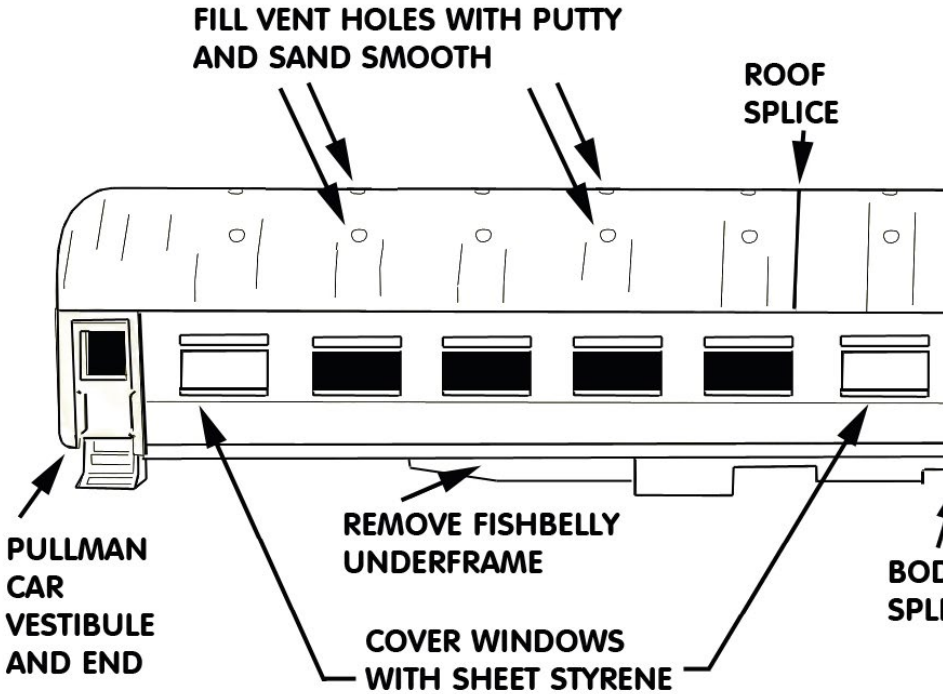

20. Changes made to the model to resemble SP prototype lounge cars.

**Did you know MRH readers
have built a free MRH index
you can search?** [click here](#)

CAR FOR SAN JOAQUIN DAYLIGHT

**RIVAROSSO 1920 SERIES PULLMAN CAR,
EARN OR MODEL POWER CARS**

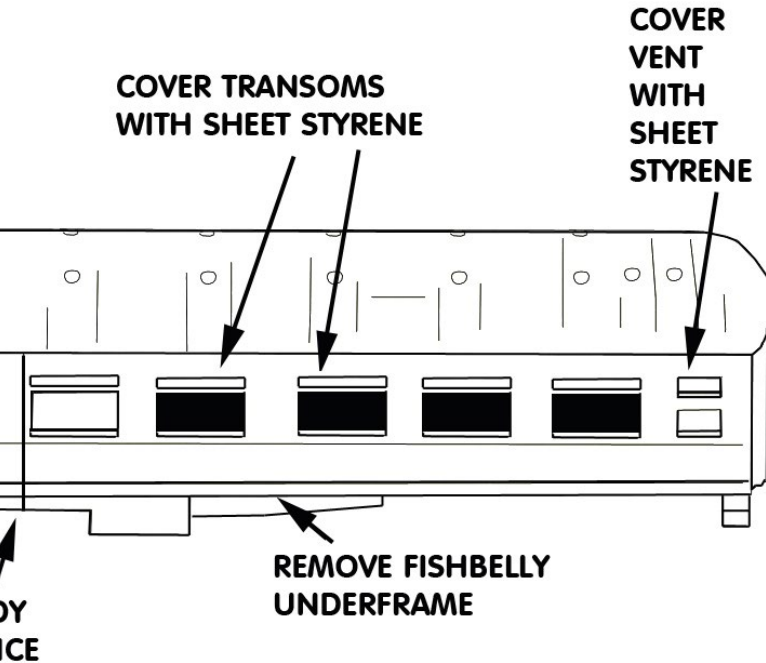

were Cadillacs of the rails. These cars rode very comfortably, and many were fitted with reclining seats and updated interiors that resembled those in the new lightweight cars.

Heavyweights like these ran in second sections of the Daylight and wherever lightweight chair cars were not available. These cars were classed as 72-foot (passenger compartment measurement) but their body length was 80 feet overall.

The Walthers paired window coach model (for example, model number 932-10124) represents a Baltimore and Ohio A-18 with York

LOUNGE CAR

AFTER THE 1947 KINGSBURG, CA. ACCIDENT, THE LOUNGE CAR #2920 WAS TO BE ONE OF SIMILAR LOUNGE CARS, THE 2920 WAS ONE OF A FEW THAT HAD THE ORIGINAL PAIRED WINDOWS OF THE SAME WIDTH CUT THROUGH TO THE LETTERBOARD PROVIDED. PAINTED IN DAYLIGHT COLORS. A NUMBER OF PHOTOS SHOW TWO TONE GREY CARBON STEEL THAT OTHER CARS FILLED IN FOR OR SUPPLEMENTED THE 2920. THE CAR OPERATED

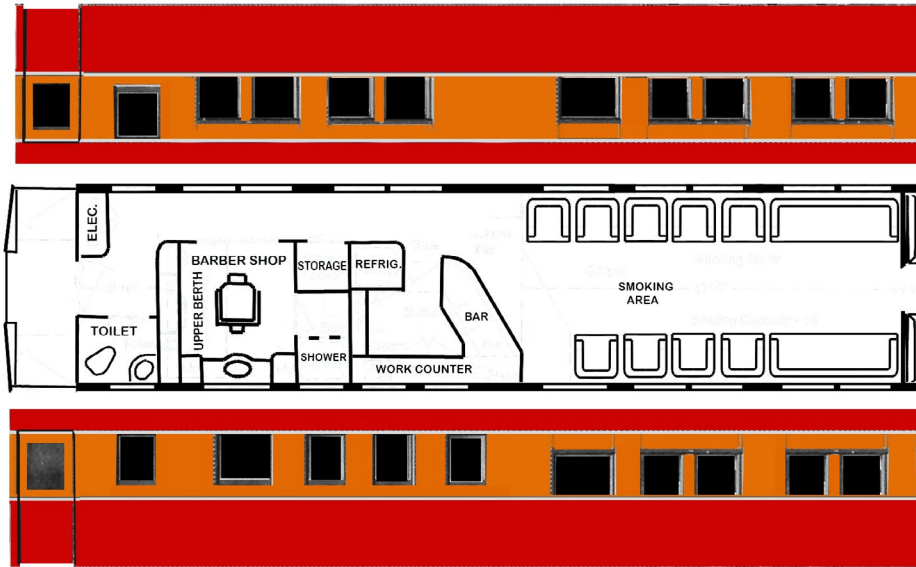

THERE IS NO EASY CONVERSION TO BUILD THIS CAR. A REASONABLE STAND-IN (SEE THE 8-5 SLEEPING CAR STAND-IN FOR THE STARLIGHT WHICH

21. Sketches of 75-CS-2 car 2920 that ran on San Joaquin Daylight 1947-1956. There is no model of this car but either a Rivarossi 1920 series Pullman or Spectrum Pullman car fitted with round roof could be used as a stand in (see [20]).



[Click here for reader comments](#)

2920

ASSIGNED TO THE SAN JOAQUIN DAYLIGHT. OF THE ORIGINAL GROUP ALL TRANSOM WINDOWS COVERED. MOST OF THE GROUP HAD NEW DOORS PRODUCING TALLER WINDOWS. 2920 WAS THE ONLY CAR IN THE GROUP WITH TALL WINDOWS ON THE SAN JOAQUIN DAYLIGHT, SUGGESTING IT WAS PAINTED IN 1947-1956 WHEN DAYLIGHT PAINTED #2980 REPLACED IT.

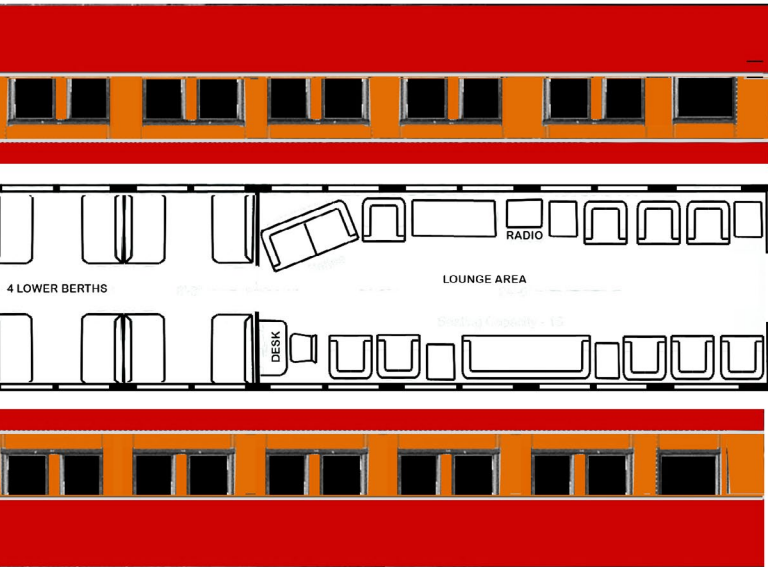

ABLE STAND IN WOULD BE THE SPECTRUM 10-2-1 PULLMAN (THIS CAR IS SHOWN WITH THE SPECTRUM SLEEPING CAR FOR COMPARISON)

air conditioner and air duct inside the upper clerestory. This is a typical 80-foot coach resembling clerestory roof cars. These cars were painted SP Dark Olive green until the mid-1950s, when many were repainted in two-tone gray.

SP cars 1048 and car 1051 in Class 70-C came to the SP from the El Paso & South Western RR in 1924. These cars received tall windows with no transoms when modernized, giving them the appearance of this model. These prototype cars had full-height doors as on the model. More typical SP cars can be modeled by cutting out the

WINDOW CONFIGURATIONS OF SP 70 FOOT COACHES

A

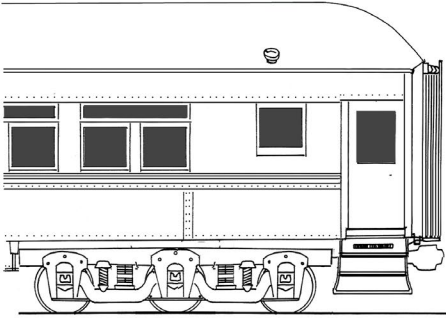

SP CARS COACHES AND CHAIR CARS WERE BUILT WITH A TRANSOM OVER EACH WINDOW PAIR.

B

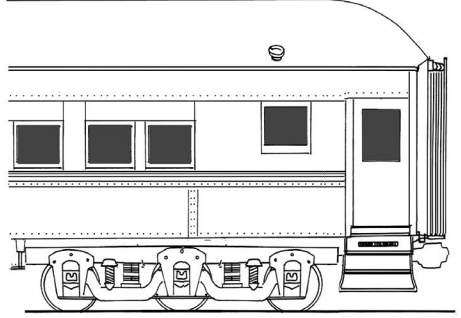

BY THE 1930S THE TRANSOMS WERE BEING PLATED OVER.

C

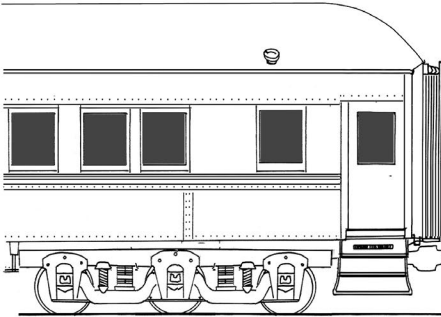

IN 1927 SPECIFICATIONS FOR COACH AND CHAIR CARS WERE CHANGED . TALLER WINDOWS WITH WIDE LETTERBOARDS AND WITHOUT TRANSOMS WERE NOW INDICATED. THE FIRST GROUP OF CARS AFFECTED WERE THE 72-C-5 ARCH ROOF CARS. THIS PRACTICE CONTINUED WITH THE CLASS 73-C-1 CLERESTORY ROOF COACHES. SOME OLDER CARS WERE REBUILT WITH THE TALLER WINDOWS.

D

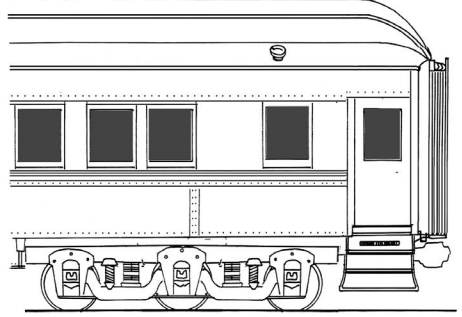

THE NINE EL PASO & SOUTH WESTERN RR. CARS ACQUIRED WITH THAT RAILROAD IN 1924 WERE BUILT WITH TRANSOM WINDOWS. WHEN REBUILT IN LATER YEARS BY THE SP, CARS #1048 AND #1051 RECEIVED THE TALL WINDOWS SIMILAR TO THE SKETCH ABOVE.

22. Sketches to show various configurations of SP coach and chair cars.

doors and extending the letterboard with styrene, then adding new low doors cut from styrene sheet.

Many or all Class 72-C-1 through 72-C-4 arch roof cars built for Southern Pacific were modernized, some receiving tall windows like the Walthers model. The model could be converted to resemble these earlier coaches (chair cars) by fitting an arch roof made by splicing the roofs of two Roundhouse-Athearn round roof cars.

The SP's clerestory roof chair cars beginning with Class 73-C-1 were built with full-height windows and rode on six-wheel trucks of Class 6-TC-6.

Some of the SP coaches and chair cars (including the former EP&SW cars) received ice air conditioning beginning in 1936.

Most of the clerestory roof cars had narrow external roof mounted air conditioning ducts. See sketch in the heavyweight diner section above. Some had an air conditioning duct inside the clerestory which did not show on the outside of the roof.

Ice air conditioning boxes are available from New England Rail Service. Some cars received Waukesha air conditioning systems, and HO scale parts are available from Train Station Products, Palace Car Co. and Precision Scale Co.

The link for New England Rail Service products is:
www.newenglandrail.net/products.html

The link for Precision Scale Co. is:
precisionscaleco.com

The link for Train Station Products is:
trainstationproducts.com

The link for Palace Car Co. is:
palacecarco.com

FULL HEIGHT DOOR ON WALTHERS MODEL
9 EL PASO & SOUTHWESTERN COACHES
ACQUIRED IN 1924 HAD FULL HEIGHT DOORS

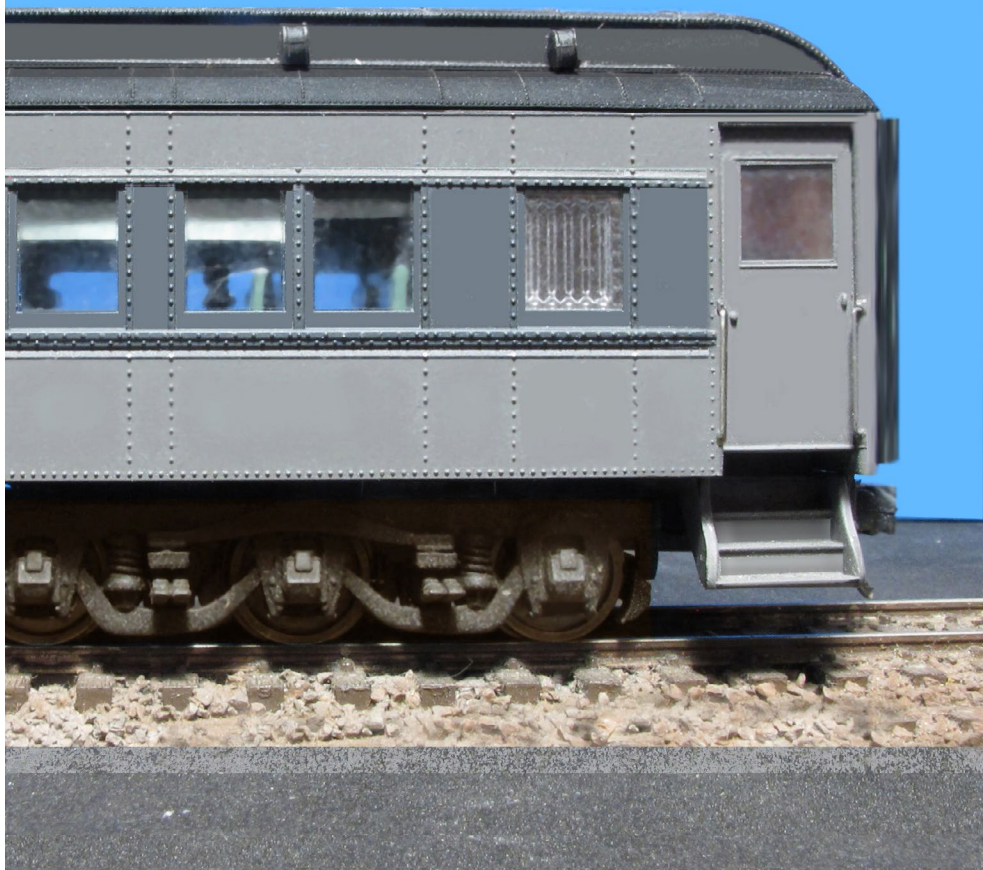

23. High and low door configurations seen on SP vestibules.
Coaches shown.



[Click here for
reader comments](#)

COACHES AND CHAIR CARS BUILT FOR SOUTHERN PACIFIC HAD FULL LENGTH LETTERBOARDS AND LOW DOORS



For a full listing of these cars' number series and details see "Southern Pacific Passenger Cars Vol. 1- Chair cars and Coaches," published by SP Railroad Technical Historical Society.

8 section-5 double bedroom sleeping car for the Starlight and others

In the 1930s and 1940s The Pullman Company rebuilt a number of older heavyweight sleeping cars into diagram 96, plan 4036, (with various sub letters indicating minor differences to the interiors)

with 8 sections and 5 double bedrooms. Southern Pacific was assigned this type of car, operated by Pullman crews.

In the breakup of the Pullman Company in 1948, the SP received 15 of these cars that had "Clover" names. The cars were all equipped with Pullman Mechanical air conditioning systems, and it appears



24. Walthers paired window coach stands in for ex-El Paso Southwestern cars absorbed by SP, car 1051. Also can stand in for various classes of SP 75-foot coaches.

that most or all cars came with auxiliary brine tanks in the air conditioning systems. The brine caused corrosion problems and the tanks were removed between 1948 and 1953. In 1956 and 1957 the car names were removed and replaced with SP numbers 8350 to 8363, plus T&NO 819 and 820.

The Pullman name was painted out by the mid-1950s and replaced with Southern Pacific lettering in the letterboard and small “Pullman” at both letterboard ends. Some cars were painted dark green with imitation gold lettering, and some were two-tone gray with pale gray lettering. The cars all rode on Pullman type 2410A six wheel trucks, except #8361 which had type 1910 trucks, and car 8356 which had type 242 trucks.



25. SP coach 2334 at Oakland. *Courtesy Bob's photos*



26. SP's arch roof coaches can be simulated by adding a round roof to the Walthers model and removing the fish belly underframe. *Courtesy Bob's photos*

PART 6 - SP PASSENGER CARS | 35

8 SECTION- 5 BEDROOM SP PULLMAN SLEEPING CAR FOR STARLIGHT SHOWN WITH SPECTRUM 10-2-1 MODEL AS A "STAND IN" CAR

8-5 SOUTHERN PACIFIC CAR "CLOVER SERIES" THAT RAN ON THE STARLIGHT AND OTHER SP TRAINS.

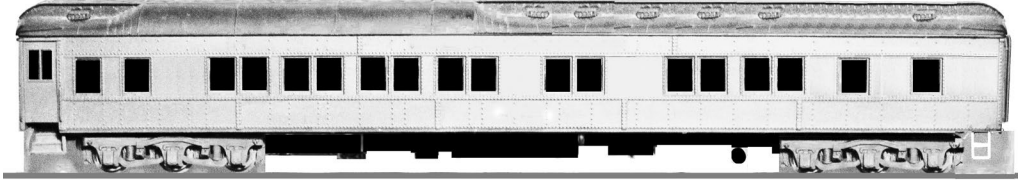

SPECTRUM HO MODEL OF 10-2-1 PULLMAN CAR AS A STAND IN FOR THE 8-5 CAR

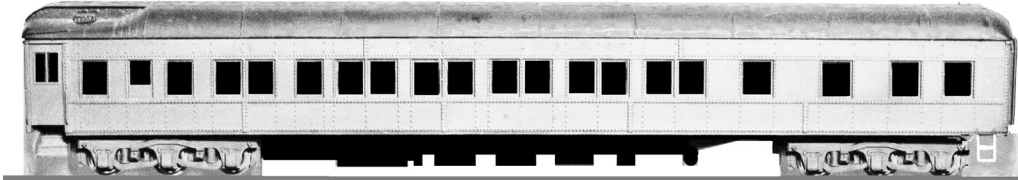

SP 8-5 CAR (VESTIBULE RIGHT)

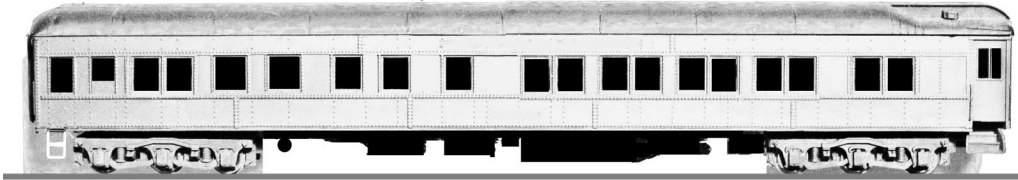

SPECTRUM HO MODEL OF 10-2-1 PULLMAN CAR AS A STAND IN FOR THE 8-5 CAR

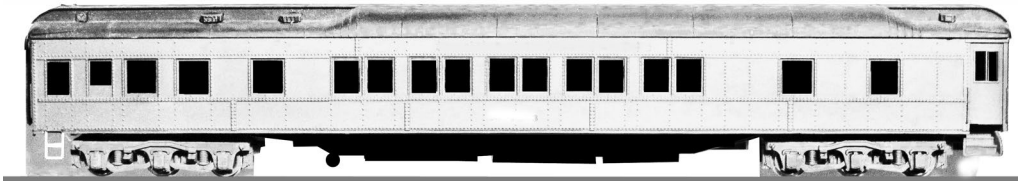

IT IS POSSIBLE TO BUILD A MODEL 8-5 PULLMAN CAR, BUT IT WOULD REQUIRE MANY CUTS TO REASSEMBLE THE WINDOWS. YOU NEED TO DECIDE IF THAT MUCH WORK IS WORTH IT TO HAVE THE CORRECT CAR, OR IF THE OUT-OF-THE-BOX SPECTRUM MODEL IS CLOSE ENOUGH TO STAND IN FOR THE CORRECT CAR. NO PLASTIC MODELS OF SINGLE-ENDED PULLMANS OTHER THAN THE SPECTRUM MODEL ARE AVAILABLE AS OF THIS WRITING.

27. SP "Clover" series named 8 section- 5 double bedroom sleeping car compared to possible stand-in car, Spectrum HO 10-2-1 sleeping car.

PART 6 – SP PASSENGER CARS | 36

This prototype model is available from Precision Scale model in brass, but no plastic model is available. Unfortunately, to make an 8-5 from any of the available plastic models would require a great deal of cutting and fitting. The fact that the 8-5 car is a single vestibule type causes additional complications for modelers.

The only plastic model resembling an 8-5 that could stand in for this car of is the Bachmann-Spectrum 10 section-2 double bedroom-1 drawing room car. Another alternative would be to model the periods when the Starlight ran with a 12 section 1 drawing room sleeper which is available as a plastic model, instead of an 8-5.

In Part 7 in November, I'll show lightweight cars you can construct, as well as provide some lightweight stand-in equipment options. ✓



VICTOR ROSEMAN

Victor got his first train, a Lionel, at age 3. Victor graduated from the Pratt Institute with BFA and MS degrees and taught fine arts in high and junior high school for 30 years and is now retired.

Victor has written many articles and several railroad related books over the past 35 years. He's also done many freelance projects for Walthers, Atlas and other model manufacturers. ■



[Click here for reader comments](#)

AN EASY WAY TO CLEAN WHEELS



BY **BRENT CICCONE**
.....

1. Brent built this cloth strip wheel cleaning apparatus using some music wire and some brass tubing mounted in the roadbed.



[Click here for reader comments](#)

AS A FOLLOW UP TO MY ARTICLE IN THE JULY 2014 MRH about track cleaning, here's an easy way I use to clean wheels.

The advantage of this method is that it cleans *all* the wheels whether powered or not. In fact you can run all of your cars through and clean the wheels on all of them. It doesn't work too well if they are really dirty, but if used periodically, it will help to keep all the wheels on your rolling stock clean.

Just a disclaimer: I didn't invent this method. It has been around for years and you can find other YouTube videos showing the method, but here is my version. Dimensions don't



Playback problems? [Click here ...](#)

matter too much. Make the cloth strips about the size of the engine trucks. If you make it too wide it will stall on the strip. If it's too narrow and there isn't enough surface for cleaning. I find around 1 ½ - 2 inches works in HO scale.

I used 3/32" steel spring wire or music wire, the same stuff you would use for controlling turnouts, to anchor the strip. I installed some 1/16" brass tube in the roadbed for holding down the ends of the wire.

The cloth used doesn't really matter, but you don't want anything too thick, or anything that releases lint.

Every so often I hook up a long train or two with all my cars and locomotives in it and simply run them a few times over a cleaning cloth soaked with my favorite wheel cleaning solvent (acetone).

You might incorporate cleaning the wheels into your normal operations or add it as another task for your operators to do. Back in the day, passenger trains were required to go through the car wash, so you could make this part of the task to be done when leaving the station!

Trainfest®

— NEW —
**2 DAY
TICKETS**

**AVAILABLE NOW
THROUGH NOV. 13**

Sponsored by the Wisconsin
Southeastern Division, Inc. of the
National Model Railroad Association 

**AMERICA'S LARGEST
OPERATING MODEL
RAILROAD SHOW**

**Saturday & Sunday
Nov. 14 - 15, 2015**

**9:00am-
5:00pm**

**WI State
Fair Park**
Milwaukee (West Allis), WI

Ticket discounts and show details at **Trainfest.com**

**ALL ACTIVITIES
INCLUDED
WITH ADMISSIONS
TICKET!**

EXPANDED TRAINFEST CLINICS

Join us for **2 full days** of clinics presented by expert modelers and model railroading manufacturers. Choose from a wide range of modeling topics at any of our **56 total clinics!** Space is limited, register for clinics today at www.Trainfest.com.

FREE

60 MODEL RAILROADING MANUFACTURERS

Come to see all **major model railroading manufacturers** at Trainfest and many **cottage industry** businesses offering unique and interesting products for your layout. Don't miss any of the exciting announcements scheduled to be unveiled at Trainfest!

NEW: PRODUCTS ANNOUNCEMENTS

70 OPERATING LAYOUTS

Make Trainfest your annual destination to meet with other modelers and find inspiration for your own layout as you walk through over **70 operating model railroads**. Experience the camaraderie of the model railroading hobby and even **operate the trains** on participating layouts!

**OPERATE
THE
TRAINS!**

CELEBRATING THE CHICAGO & NORTH WESTERN SYSTEM

This year marks the beginning of an exciting new tradition for Trainfest. Each year we will be celebrating a railroad, starting with the **Chicago & North Western System**. Discover the railroad's rich history in the museum quality historical photo display, learn about the road at C&NW clinics, and more.

**FREE
RIDE THE
MLES
TRAIN!**

NEW MANUFACTURER AND MEDIA PARTNER

Trainfest is excited to announce a brand new HO and N scale model railroading manufacturer, **ScaleTrains.com!** ScaleTrains.com will be unveiling several all-new models on **Saturday morning** at Trainfest. Be sure to visit us at Trainfest!



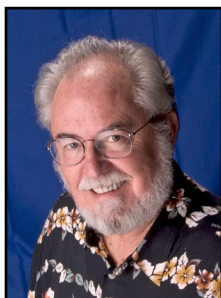

SEPTEMBER NEWS

column

RICHARD BALE *and* JEFF SHULTZ

.....



**Click here for
reader comments**

New Layout Underway at GATSME Club

GATSME Model Railroad Club, Rockledge, Pennsylvania, is open to new members, especially those interested in helping develop a new club layout. Following the loss of their 35-year residence, the club was able to purchase a 4800-square-foot mill building in Rockledge Borough. Now the work begins on planning and building a museum-quality HO scale layout that will feature the best and latest practices of model railroading. The new facility includes a museum that will pay tribute to Rockledge's history as the location of several knitting mills, all now gone except for GATSME's present building. For more information visit gatsme.org or contact Doug Baer at Dbaer@polarmicro.com.

.....

▶ THE LATEST MODEL RAILROAD PRODUCTS, NEWS & EVENTS

NEW CLUB CARS



NMRA's Northern Utah Division is selling a kit for a 40-foot plug-door steel refrigerator car decorated for Fisher Beer. The basis of the HO scale

model is an Accurail 8500-series car. The design of the fantasy reefer is based on logos from an actual Fisher Beer bottle dating from the 1950s-1960s. For additional information including ordering instructions send an inquiry to Stan at RJenn24103@aol.com.

.....

NEW PRODUCTS FOR ALL SCALES



Clever Models continues to release creative new cardstock model kits. Among the latest downloadable kits are the combination Coal/Grain Elevator illustrated here. When assembled the dimensions of the main structure are 53 feet wide x 22 feet deep x 48 feet 6 inches tall. Instructions and photos are included in the download. This file comes in O scale with instructions to print in any

smaller scale. Other items currently under development are a mill and a line of modern steel buildings. For additional information visit clevermodels.net.

.....

SEPTEMBER NEWS | 3

London Web Software has announced their TRIM 2D Building Designer and TRIM 3D Building Designer programs. Available for PC or MAC, these programs are used to design structures created using the Linka and ScaleCast molds system. Projects can be prototyped on the computer, creating a plan to be used in building the actual model. More information can be found at londonwebsoftware.com.

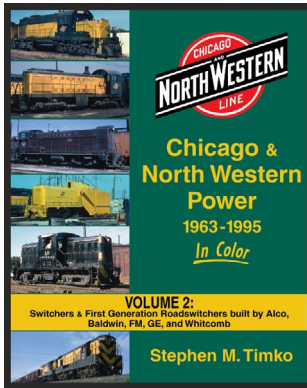
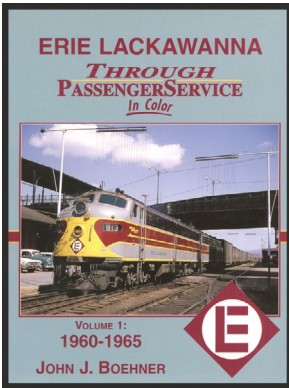

New releases from **Morning Sun Publications** includes *Erie Lackawanna Through Passenger Train Service Volume I: 1960-1965* by John J. Boehner. This is a digital reprint of

the popular hardback published in 2006. Additional digital releases include *Rio Grande: The Best of Bob Davis*, and *INSULL Chicago Interurbans* which has more than 300 color photos of the Chicago Aurora & Elgin; Chicago, North Shore & Milwaukee; and Chicago South Shore & South Bend.

New traditional hardback books include *Chicago & North Western Power 1963-1995 Volume 2*, by Stephen M. Timko. Also new from S. M. Timko is Conrail *Central Region Volume 2 1981-1986*. And finally *Chessie System in Color*, in which author Bob Withers provides readers with an in-depth look at the colorful Chessie System including ample photos of the famous feline's silhouette that appeared on everything from locomotives to cars, trucks, and belt buckles. For additional information visit morningsunbooks.com.

O SCALE PRODUCT NEWS

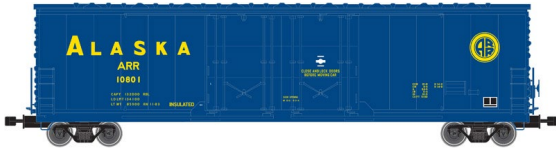

During the second quarter of 2016 **Atlas O** plans to release another run of its 53-foot Evans insulated RBL boxcar (item 301318). Features on the O scale model include Dreadnaught ends and double Superior plug-doors. New road names will be Alaska Railroad, and Western Pacific. Road names scheduled to be rerun with new numbers include Minneapolis, Northfield & Southern; Burlington Northern; and Illinois Central.



Also scheduled for release during the second quarter of next year is a PS 4427 low-side triple-bay covered hopper car. New paint schemes include ATSF "Q", Illinois Central Gulf, WC/CN, and Union Pacific. A popular Chessie System car will be rerun with new road numbers (item 3001359-62). All Atlas O models are available for either two-rail or three-rail operation. For additional information visit atlaso.com/nowshipping.htm.



Boulder Valley Models is selling a body kit for an On30 railbus. Identified as the Littlefield & New

Paltz railbus, the new model is designed to fit a Bachmann HO

scale 45-ton locomotive mechanism (not included). The kit includes detailed cast resin body parts for the sides, ends, hood, radiator, roof, headlight, bell, and steps. Illustrated instructions show how to extend the deck of the Bachmann loco to allow a pilot and coupler at each end. For additional information visit bouldervalleymodels.com.

.....

HO SCALE PRODUCT NEWS



New HO scale kits recently released by **Accurail** include a 50-foot double-plug-door boxcar decorated for Toledo, Peoria & Western (item 5414).



Also new is a Pittsburgh & Lake Erie 70-ton triple-bay hopper car with offset sides (item 7554).



Kits for ACF triple-bay covered hoppers decorated with CSX *How Tomorrow Lives* slogan are available in a three-

car set with different road numbers (item 8066).

SEPTEMBER NEWS | 6



This Milwaukee Road 40-foot wood stock car with Murphy steel ends is available now from Accurail as an easy-to-assemble kit (item 47041). For more information on all Accurail products visit accurail.com.



Athearn has issued a long list of HO scale items scheduled for release next summer. Leading the Genesis list is an SD75M diesel decorated for Norfolk Southern (item 69215-18). The model is based on former ATSF and BNSF units acquired by NS last September. Spotting features include a turbo bulge, early dynamic brake grilles, Nathan five-chime horn, two grab irons on the cab roof, tinted cab windows, nose door with window, short sunshade brackets, four-step walkway, drop-style grab irons on rear pilot, early jacking pads, round-top ditch lights, and late-style 5,000-gallon fuel tank with a stem-mounted fuel gauge. Four road numbers will be offered (2800, 2802, 2805, and 2806). Standard DC models without sound will have an MSRP of \$199.98. Models with Tsunami sound and DCC decoder will list at \$299.98. Availability is July 2016.

A new release of Genesis MP15AC locomotives (item 69400-12) will be available next June. In addition to an EMD

SEPTEMBER NEWS | 7



Demonstrator, road names will be Southern Pacific (faded paint), Ferro Valle Railroad, and CSX/YN2.



Next June will also see the arrival of class F89 TOFC flat cars. Road names on the HO scale Genesis series model will be ATSF (above), TTX Trailer Train, Southern Pacific, and KCS (item 69945-59).



Athearn HO scale Ready-to-Roll models scheduled for release in June 2016 include 40-foot tri-

ple-bay hopper cars with side extensions and a removable wood chip load. Road names will be Missouri Pacific, Bangor & Aroostook, Boston & Maine, Chesapeake & Ohio, Norfolk Southern, and Chattahoochee Industrial Railroad (item 76480-97). The cars will be sold individually as well as in four-packs with different numbers.



A 65-foot 6-inch mill gondola with working drop-ends and individually applied wire

SEPTEMBER NEWS | 8

grab irons will also be ready for release next June. Decorating schemes will be Chicago, Burlington & Quincy; Canadian National; Penn Central; Southern Pacific; and Union Pacific (item 76543-60).

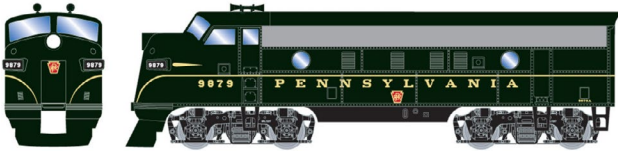

Four new
Athearn-
Roundhouse-
branded

Ready-to-Roll series models are scheduled for release in June 2016. Leading the group is an EMD F7A that will be offered separately as well as in F7A/B matched pairs with only the A unit powered. Road names will be Pennsylvania Railroad, Canadian National, Canadian Pacific, and Southern Pacific in the Daylight scheme (item 87903-10).



Pullman-Standard 2003
cu. ft. twin-bay covered
hopper cars decorated for
Santa Fe, Conrail,

Milwaukee Road, Trona Railroad, Norfolk & Western, Southern Pacific, Union Pacific, and GE Lamps (96149-72) are also scheduled for release next June.

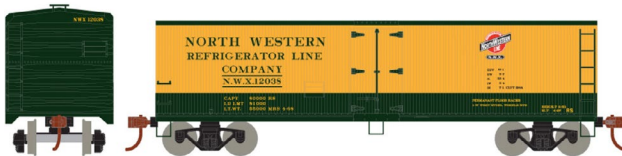

Athearn-
Roundhouse
40-foot wood reef-
ers with steel

underframe and Dreadnaught ends are included in the June 2016 release. In addition to the North Western Refrigerator Line car shown here, the Ready-to-Roll HO scale models will be

SEPTEMBER NEWS | 9

available decorated for Green Bay & Western, Northern Pacific, Rock Island, Soo Line, and PFE with dual SP and UP heralds (item 85610-27).



Completing the Athearn-Roundhouse release schedule for next June is a steel

cupola caboose. Road names will be Southern Pacific, Santa Fe, Burlington Northern, Canadian National, Canadian Pacific, and Pennsylvania Railroad (item 87818-35). For additional information on Athearn products contact a dealer or visit athearn.com.

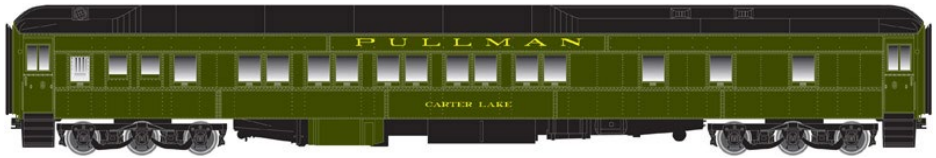

Atlas Model Railroad Company plans to release a Masterline series 10-section, one-drawing-room, one-compartment Pullman sleeper (item 20003612-631) during the first quarter of 2016. Features on the HO scale model include operating diaphragms, complete underbody detail, and full interior detailing including window glazing.

Eighteen decorating schemes will be available including Burlington-Pullman (green – Carter Lake, Linoma Lake); Chicago & North Western (green and yellow – Floyd River, Fox River, Mount Rushmore); Norfolk & Western (Tuscan red – Island Regal, Island Rose); Northern Pacific (two-tone green and

SEPTEMBER NEWS | 10

yellow – Chief Black Bear, Chief Many Horns, Chief Standing Buffalo); Pennsylvania Railroad (Tuscan red – La Reine); Southern Pacific (two-tone gray – Palouse Falls, Prior Lake); Union Pacific (yellow, gray and red – Balsam Fir, Columbia Gorge, Crown Point); and Pullman (green – Chief Red Tomahawk, Blue Bird Lake, Rice Lake). An undecorated model is also planned.



More models coming from Atlas during the first quarter of 2016 include another production run of its 53-foot Evans insulated RBL boxcar.

Features on the HO scale model include Dreadnaught ends and double Superior plug-doors. New road names will be Roscoe, Snyder & Pacific; Alaska Railroad; Brooks Scanlon; Fox River Valley; and States Veneer. Rerun road names with new numbers include Minneapolis, Northfield & Southern; and, as seen here, Bend Millwork Co (20003423-439). An undecorated model will also be available.



Completing Atlas' first quarter release of HO scale models is a Trainman series steel cabooses with a centered cupola. The model is based on a prototype Magor Car Corporation delivered to the Chesapeake

& Ohio in 1937. The design proved popular with hundreds of similar cabooses produced by American Car & Foundry

SEPTEMBER NEWS | 11

.....

and the St. Louis Car Company. Through subsequent rebuilding and modernization, many remained in service until the end of the caboose era in the 1980s. Atlas' ready-to-run model has clear window inserts and separately applied side railings. New road names will be Genesee Valley Transportation, Jersey Central, Lehigh Valley, Reading & Northern, Southern Railway, and Union Pacific. New numbers will be available for Alaska, Canadian National, CP Rail, CSX, and Virginian (item 20003671-690). For more information go to atlasrr.com.

.....



Bachmann Trains has updated its 80-foot Pullman sleeping cars with improved coupler pockets and constant amber-LED lighting. Other features include diecast trucks with low-friction eight-wheel electrical pickup for the lighting system which will function on both DC and DCC systems. Road names for the HO scale ready-to-run model are Pennsylvania Railroad (Edisonville), Santa Fe (Moose Lake), Baltimore & Ohio (Loch Lomond), New York Central (Mohawk), and Union Pacific (Lake Waccamaw). For information on all Bachmann products visit bachmanntrains.com.

.....

Broadway Limited Imports is scheduled to release its HO scale version of a Pennsylvania Railroad class L1s 2-8-2 Mikado steam locomotive this month. Both pre-1946 and post-war



versions of the L1s will be available, as well as identical models decorated for Detroit, Toledo & Ironton; and Lehigh & New England.



BLI expects to deliver this HO scale version of a Union Pacific 4-8-8-4 Big Boy next January. The prototype fulfilled UP's need for a locomotive capable of handling a 3,600-ton train

over Sherman Hill and the 1.14% grade from Ogden to Wasatch, Utah without the need of helpers. Both of these steam locomotive models feature BLI's Paragon3 Sound & Operation System. For additional information on all BLI products contact your dealer or visit broadway-limited.com/products.aspx.

.....



Dallas Model Works has introduced a new series of HO scale pre-weathered brass

wheelsets. Although the face of each wheel is covered with grime, the axle ends and wheel treads are clean. Both 33-inch and 36-inch wheel sets are available. Weathered N scale wheelsets are scheduled for release later this year. for additional information visit dallasmodelworks.com.

.....



Dr. Ben's is selling a Scale Model Masterpiece kit identified as the Short Line Freight Shed & Boiler. The kit was originally created by Thomas A. Yorke Enterprises. The structure features a free-standing vertical boiler and stone remnants of what was once

a boiler room, plus miscellaneous boxes, barrels, and stacked sacks. Labstone dental material is used to make the detailed casting using original Thomas A. Yorke master/molds. The plastic windows, doors, and other details are Grandt Line Products. Additional components include scale lumber and Doctor Ben's roofing material. Updated instructions reflect changes of materials and advances in modeling techniques, including detailed construction drawings, templates, weathering instructions, and color photos of the completed models. For additional information visit debenllc.com.

.....



The latest kit from **Fine Scale Miniatures** is Westside Auto, a multiple-structure small-town auto parts dealer. This limited-production HO scale craftsman-type kit is scheduled for release

SEPTEMBER NEWS | 14

in late September. When assembled as shown, the completed scene has a footprint of 9.5 inches x 15 inches. Vehicles and figures in the display photo are not included. The kit is priced at \$265.00. To order visit finescaleminiatures.com.

.....

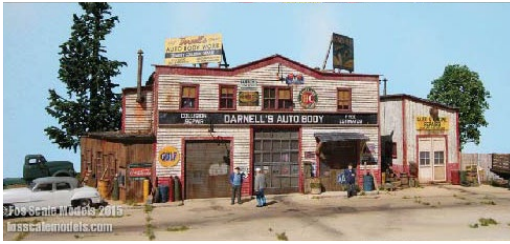

Fos Scale Models has released a kit for Darnell's Auto Body. The assembled model has a footprint of 4 inches x 11 inches. Vehicles and figures in the display photo are not

included. The HO scale craftsman-type kit is priced at \$114.95. For additional information visit foslimited.com.

.....



Imperial Hobby Products has HO scale body shells for an NYCTA Budd R32 subway

car. The floors are configured for drop-in installation (after some drilling and tapping of screw holes) in a Bowser mechanism and trucks (not supplied). For complete details on this project including ordering information visit ihphobby.tripod.com.

.....

InterMountain Railway plans to release a new production run of its HO scale General Electric U18B light road switcher early next year. Road names will be New Haven, Central

SEPTEMBER NEWS | 15



Vermont, Southern Pacific, Frisco, Maine Central/PanAm, Chessie System, Burlington Northern, Rio Grande,

Delaware & Hudson (bicentennial) Western Pacific, Great Northern, and SP/SF in the Kodachrome scheme (item series 49480-492).



The locomotive can be ordered with either FB-2 or Blomberg trucks. A DC version of the ready-to-run model will have

an MSRP of \$189.95. Models equipped with an ESU sound decoder will list at \$279.95. Other options include an undecorated kit with a full drive system at \$149.95, and an undecorated body only at \$79.95.



Also due from InterMountain in February-March is a new release of a 57-foot class R-70-20 mechanical refrigerator car.

Nine decorating schemes will be available including BNFE (white body), SPFE (white body with blue medallion), SPFE (restenciled), Soo Line, and UPFE (R-70-25). Also PFE cars with either a Keystone or Hydra-Cushion underframe and a choice of an early or late roof. Features of the HO model include metal wheelsets and Kadee couplers.

It has been several years since InterMountain made a production run of its HO scale Procor pressure-flow covered hopper car. A release has been scheduled for March-February with

SEPTEMBER NEWS | 16



cars decorated for Procor, Halliburton, British Columbia Railway, AAR-ex BCOL, Stelco, Mountain Minerals, and La Farge

Cement LAFX. The ready-to-run models will have Kadee couplers and metal wheelsets at an MSRP of \$49.95. Meanwhile, an undecorated kit with plastic wheels and no couplers is available now at \$19.95.



Kadee Quality Products has introduced an 11,000-gallon insulated tank car that adheres closely to a prototype car with a riveted underframe

as built by American Car & Foundry. The car has a step platform from the 1947-1949 period. Features include see-through Apex safety platform and running boards, complete underframe details including AB brake system and rigging, defect card holders, and hazardous materials placard stickers. Rather than being molded in place, all of the individual details are cast separately and hand-applied.



The model has the usual Kadee features including HGC self-centering two-piece equalized trucks and #158 Whisker couplers in a narrow draft gear box with delayed centering action. The initial release is decorated for TWOX 4003 - Tidewater Association Oil Co. The ready-to-run model has an MSRP

SEPTEMBER NEWS | 17

of \$44.95. For additional information see your dealer or visit kadee.com.

KatoUSA has introduced four new sound cartridges for its Analog Sound Box system. They include FEF-3/GS-4 heavy steam sound; US light-steam sound; EMD third-generation diesel sound; and GE third-generation diesel sound. To hear the sound cards in action visit youtube.com/watch?v=u_9Q45odq4E. Kato's Analog Sound Box has been developed as a joint effort by Kato and Soundtraxx to provide an effective sound system for non-DCC layouts. For information about the system visit katousa.com/news/newsletter/August15-News.html.

Q Connection has acquired a variety of HO scale parts from former brass importer Railway Classics. The parts include trucks and full-width diaphragms used on Milwaukee Road and Northern Pacific streamlined passenger cars. For additional information visit QConnection.biz. The acquisition included passenger car decals which are noted in the Decal section near the end of this News Report.



Rapido Trains has released information about its forthcoming HO scale model of the Alco/MLW FA-2 (freight version) and FPA-2 (passenger version) diesel locomotives. A total of 283

SEPTEMBER NEWS | 18

FA-2 and FPA-2 locomotives were built by Alco in Schenectady, New York, with an additional 51 units being built under license by Montreal Locomotive Works. The contour of the roof and nose are expected to be precisely accurate, since the tooling is being prepared from a 3D scan of a full-sized prototype.



Notable features on Rapido's HO version include operating number boards, headlights and two-color class lights (white/green); dynamic brakes; etched-metal grilles (chicken wire or Farr grilles as appropriate to road name); full underbody piping and conduit; road name specific fuel tanks; separate grab irons and handrails; and full cab interior. Both DC and DC/DCC/Sound models will be available with authentic ESU LokSound recordings from a real Alco 244 prime mover.



Rapido plans to replicate all of the most visible differences from railroad to railroad including such variations as water/fuel tank combinations, steam generator roof panels, vertical battery box louvers, side grilles, nose louvers (B&O), Trainphone antenna (PRR), and other prototype-specific details. The model will have an MSRP of \$225.00 (DC) and \$325.00 (DC/DCC/Sound). The MSRP in Canada may increase slightly depending on the value of the Canadian dollar at time of delivery.

SEPTEMBER NEWS | 19



For a preview of how the Rapido FA-2 and FPA-2 will look and behave, visit youtube.com/watch?v=wng1gkaWZDg&feature=youtu.be.

Road names on the initial production run will be Baltimore & Ohio, Canadian National, Canadian Pacific, Canadian Pacific (script), Erie, Great Northern, Lehigh Valley, New York Central, and Pennsylvania Railroad. An undecorated model will also be available. For additional information about Rapido's FA-2 and FPA-2 locomotive project including making a reservation visit rapidotrains.com/fa2.html.

.....



Rusty Rails has introduced two new HO scale scenic junk castings. Shown on the left is an old engine bone yard (item RRJP-H-22) that measures about 5.5 inches x 4 inches. On the right is a pile of junk for a foundry or similar industry (RRJP-H-35) that measures 3.75 inches x 3 inches. The resin castings are sold unpainted. For additional information visit rustyrail.com.

.....

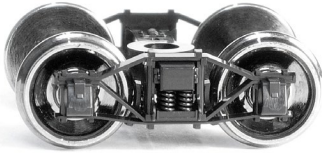

Tahoe Model Works offers a wide selection of HO scale freight

car trucks that faithfully replicate the prototype. Trucks available now range from circa-1890s ACF arch bar trucks with a 5-foot wheelbase (left) to 70-ton A-3 trucks from the late 1940s (right). Tahoe trucks are available with RP-25 or .088" semi-scale wheels. Although Tahoe does not maintain a website, details on the entire line including ordering information is available at sunshinekits.com/sunimages/tahoe/ORDERFORM15s.pdf.

.....

Tangent Scale Models has released a new production run of its General Steel Casting 60-foot flat car. The HO scale model replicates a one-piece cast steel frame prototype developed by GSC in 1956. The ready-to-run model features Tangent's usual attention to detail such as wire grab irons, wire uncoupling bars, air hoses, and prototypically accurate roller or plain bearing trucks as appropriate to the road being modeled.



Six road numbers each are available

now for Burlington Northern (1985 repaint in cascade green), Illinois Central Gulf (1977 orange repaint), Missouri Pacific (1981 eagle and buzzsaw repaint), Pennsylvania Railroad (1965 original F47 paint), and Union Pacific (original 1966 armour yellow paint). Four road numbers are available for two Missouri Pacific MOW cars in UP MOW green: post-2005 scheme and pre-2005 scheme. A Great Northern version is

SEPTEMBER NEWS | 21

available in three road numbers decorated in the original 1963 glacier green scheme. For additional information visit tangentscalemodels.com.

Also new from Tangent are assorted detail items identified as “Unique and Useful Parts.” The items include Plate ACI Labels (in packs of eight), Raised Plate ACI Labels (in packs of eight), Manitoba placards (in packs of four), and Coupler Lift Levers (in packs of five pair). For additional information including photos of the items visit tangentscalemodels.com/product-category/unique-and-useful-parts.

.....



Walthers is quoting a late November delivery date for it's

HO scale B&O Capitol Limited E9A diesel locomotive (920-48370). Special features include raised B&O Capitol Dome herald, a brass Nathan M5 air horn, single headlight with flush lens and gasket detail, flush number boards, ATS shoe on front truck, stainless steel Farr side grilles, and fuel tank skirts.

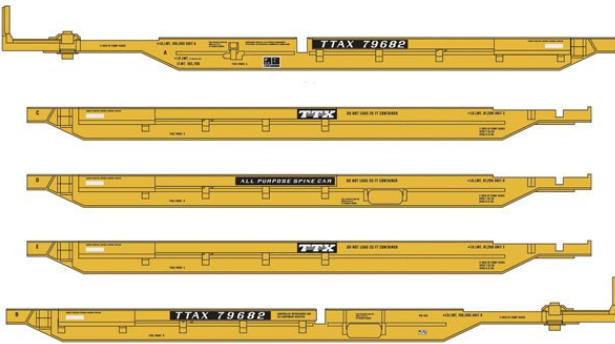

Also due from Walthers in late November is a five-unit spine car that is 263 feet in length (910-5257). The individual cars are 48 feet in length. The cars

SEPTEMBER NEWS | 22

can handle trailers from 28 feet to 45 feet in length, or containers from 20 feet to 48 feet long. Details include collapsible container pedestals, upright and closed trailer hitches, and brake gear details on the end cars. The Mainline series model will be available for Santa Fe, Burlington Northern, Conrail, Union Pacific, and TTX as shown here. The HO scale model will have an MSRP of \$119.98.



This 70-foot RPO-baggage car decorated for the Pennsylvania

Railroad (920-9240) with Tuscan body, black roof and Dulux lettering is scheduled to be released by Walthers in March 2016. For additional information on all Walthers products, contact your dealer or visit walthers.com.



Yarmouth Model

Works is selling resin kits for HO scale 40-foot ATSF 12-panel boxcars. Separate kits are available for three different versions of the prototype: 1) with a square panel roof and a

Trilock metal running board, 2) with a diagonal panel roof and a Trilock running board, and 3) with a diagonal panel roof and a USG metal running board. Each kit includes specially designed etched detail parts, Kato ASF A-3 trucks, and Speedwitch Media decals which contain all of the slogans for both Map and Ship and Travel decorating schemes. To order visit yarmouthmodel-works.com/kits.php.

SEPTEMBER NEWS | 23

Pierre Oliver, owner of Yarmouth, has dedicated this series of kits to the memory of Richard Hendrickson. In announcing the dedication, Oliver said, *“He (Hendrickson) was the grand man of prototype modeling. A better resource for freight car history just doesn’t exist, and he was a really nice guy too. Richard was very helpful to me in the creation of this kit. He shared many photos and a great car history which are included in the kit.”*

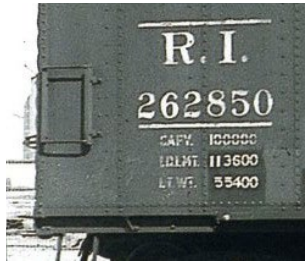
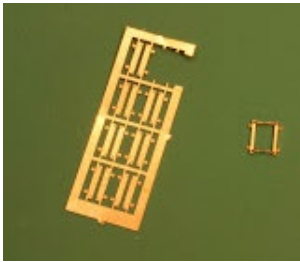

Also new from Yarmouth Model Works are left-hand side ladders for HO scale Rock Island boxcars. Although this

seems to be about as esoteric as a detail part can get, several modelers participating in the annual Cocoa Beach Shake and Take kitbash project actually requested them. They are priced at \$3.00 per fret, which is enough for four cars. Visit their website to order.

N SCALE PRODUCT NEWS

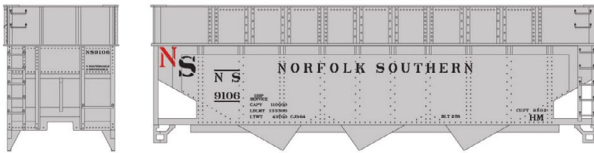

N scale Ready-to-Roll models coming from **Athearn** next June include 40-foot triple-bay

hopper cars with side extensions and a removable wood chip load. Road names will be Norfolk Southern, Missouri Pacific, Bangor & Aroostook, Boston & Maine, Chesapeake & Ohio,

SEPTEMBER NEWS | 24

and Chattahoochee Industrial Railroad (item 6582-99). The cars will be sold individually as well as in four-packs with different numbers.



Also coming from Athearn in June

are N scale 65-foot 6-inch mill gondolas decorated for Chicago, Burlington & Quincy; Canadian National; Southern Pacific; Union Pacific; and Penn Central (item 23912-50). For additional information on Athearn products contact a dealer or visit athearn.com.

.....



Atlas Model Railroad Company's new N

scale version of a 5077 cu. ft. Plate B boxcar represents one of the 4,300 prototypes FMC

built in their Portland, Oregon plant between 1975 and 1979. The cars were delivered in numerous colorful short line paint schemes, as well as the nationwide car pool fleet of Railbox. In addition to Railbox, road names will be Atlanta & St. Andrews Bay; Atlantic and Western; Burlington Northern; Cadiz Railroad; Escanaba & Lake Superior; Lake Erie, Franklin & Clarion; and Port Huron & Detroit (item 50002403-428).



Additional new N scale models from Atlas include this Trainman series steel cabooses with a centered cupola. The model is based on a prototype

Magor Car Corporation delivered to the Chesapeake & Ohio in

SEPTEMBER NEWS | 25

1937. The design proved popular with hundreds of similar cabooses produced by American Car & Foundry and the St. Louis Car Company. Through subsequent rebuilding and modernization, many remained in service until the end of the caboose era in the 1980s. Atlas' read-to-run model has clear window inserts and separately applied side railings. New road names will be Reading & Northern, Genesee Valley Transportation, Jersey Central, Lehigh Valley, Southern Railway, and Union Pacific. New numbers will be available for Alaska, Canadian National, CP Rail, CSX, and Virginian (item 50002578-597).

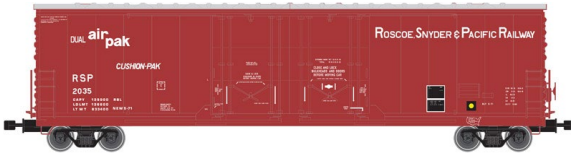

During the first quarter of 2016 Atlas plans to release another run of its 53-foot Evans insulated RBL boxcar.

Features on the N scale model include Dreadnaught ends and double Superior plug doors. New road names will be Alaska Railroad; Roscoe, Snyder & Pacific; Brooks Scanlon; Fox River Valley; and States Veneer. Rerun road names with new numbers include Minneapolis, Northfield & Southern; and Bend Millwork Co (item 50002284-299). An undecorated model will also be available. For additional information on all Atlas N scale models visit atlasrr.com/newn.htm.



InterMountain Railway is quoting a February/March 2016 release date for a new

production run of 57-foot class R-70-20 mechanical refrigerator cars. Nine decorating schemes will be available including BNFE (white body), SPFE (white body with blue medallion), SPFE (restenciled), Soo Line, PFE, and UPFE (R-70-25, above). This

SEPTEMBER NEWS | 26

ready-to-run N scale model comes with metal wheelsets and working knuckle couplers. The models have an MSRP of \$24.95. An undecorated version will be available at a list price of \$11.50. More info at intermountain-railway.com.

.....



Micro-Trains Line plans to release its SW1500 diesel switcher decorated for

BNSF and MKT. The N scale ready-to-run models are expected early next year.



A December date has been announced by Micro-Trains for the release of a set of five heavyweight passenger cars decorated for MOW service. The cars includes a bunk car (ex-sleeper), crew kitchen car (ex-diner), tool and shop cars (ex-baggage cars), and a foreman's office car (ex-observation car). The underframes and trucks of the MOW cars will be weathered.



Micro-Trains is selling a 70-foot Pennsylvania heavyweights

SEPTEMBER NEWS | 27

mail-baggage car decorated in Tuscan red with buff lettering and a black roof. The N scale ready-to-run model car comes with PRR type-3D7P2 six-wheel trucks.

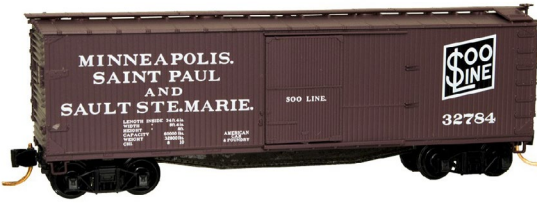

A 40-foot double-sheathed wood boxcar decorated for Soo Line will be available about the middle of this month. The N scale ready-to-run model represents a

prototype built by American Car & Foundry in 1910. For additional information on all Micro-Trains products, visit their new website at micro-trainsline.com.



Rapido Trains is currently finalizing details on a new N scale 1400-series GMD-1. The model of the modern Canadian locomotive is scheduled for release in October. Reservations close Wednesday, September 30.

In the late 1990s, CN upgraded some GMD-1 1600 locomotives to 1400s with, among other changes, the addition of a 2000-gallon fuel tank and two-axle Flexicoil trucks recycled from retired 1100-series GMD-1 locomotives. These new 1400s, numbered 1430-1444, were classified GR-412b (General Motors Roadswitcher, 4 axles, 1200 hp, group B).

Rapido will produce every number of GR-412b still operational (as of 2014), along with an unnumbered version. Additional upgrades from Rapido's introductory run last year include precisely spaced wheelsets for improved operation on commercial turnouts. The

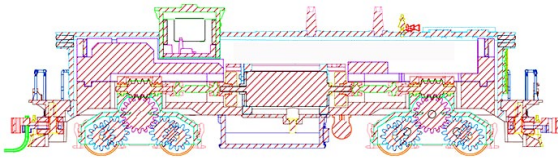

locomotive model will be available with DCC/Sound and in analog DC with standard directional wiring. This engineering drawing shows how use of the interior space has been maximized.

locomotive model will be available with DCC/Sound and in analog DC with standard directional wiring. This engineering drawing shows how use of the interior space has been maximized.

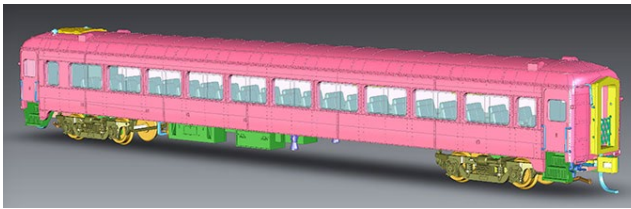

In other N scale news from Rapido, work continues on the Osgood Bradley 10-window coach.

Rapido was not happy with the preliminary samples submitted by the tool maker in August 2015. The tooling was deemed not acceptable and was one of the principal reasons Rapido pulled the project and started over with a different tool maker. In the process, the model was completely redesigned. The body shell is now a one-piece casting, including the roof. The batteries for the lighting are still easily accessible, and the gap between the body side and the roof has been eliminated. The Easy-Peasy lighting will now utilize surface-mounted LEDs. The interior detail has also been upgraded. Rapido expects to have decorated samples at the Amherst Show in West Springfield, Massachusetts next January. See rapidotrains.com.

.....

New items coming from **Trainworx** late this year include a series of Peterbilt type-379 long-nose tractors with Caterpillar 3406 engines and a 50-foot Merrit gold-line series livestock trailer. The ready-to-run N scale models will have an MSRP of \$38.95 each. New items coming during the first quarter of 2016 include a pair of FedEx tractors – Peterbilt 379 and Kenworth T800 – and trailers in seven different styles and paint schemes.

SEPTEMBER NEWS | 29

Go to train-worx.com/15-8fedex.pdf for details. Also due early next year are Peterbilt type-280 and 350 'iron nose' tractors in eight color combinations. Both tandem- and single-axle tractors will be available. For additional information visit train-worx.com/15-8pete350.pdf.

NEW DECALS, SIGNS AND FINISHING PRODUCTS



Dan Kohlberg has released new HO scale silkscreened decals for Illinois Central and Illinois Central Gulf. The IC decals include 50-foot

PS-1 boxcar with combination doors 1967 + (above), 50-foot PS-1 boxcar with 10-foot door 1968+, and 40-foot PS-1 Hi-Cube boxcar 1967+. The ICG decal set is for a 52-foot black gondola 1981+. Also new is a set of full-color ACI Labels with sufficient material for 36 cars. Photos, prototype information and ordering details are available at home.mindspring.com/~paducah.

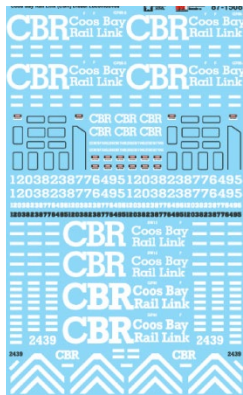

Microscale has released new decal sheets that provide lettering for a variety of reefers including Lamb Weston (REMX); Thermice (TICX); Burlington (RBBX); and Kansas, Oklahoma & Gulf (KO&G). Also new is a decal sheet for diesel

- [TABLE OF CONTENTS](#)
- [INDEX](#)

locomotives of the Coos Bay Rail Link (CBR). For information on all Microscale products, visit microscale.com. Both sets are available for N and HO scale.

.....

Q Connection has acquired the decal inventory of brass importer Railway Classics The selection includes HO scale decals for Chicago, Burlington & Quincy; Great Northern; Milwaukee Road; New York Central; and other railroads that owned Slumbercoaches. For additional information visit qconnection.biz.

.....

 **SEND US YOUR PRODUCT ANNOUNCEMENTS**

If you are a hobby manufacturer with a product announcement, just [click here](#) and submit your announcement to us. Our website and free magazine reach continues to grow, so get on board this new media train! ■

.....

**Want to help keep
MRH free?
Then click on Ads!**

DISCLAIMER

The opinions expressed in this column are those of the writer and do not necessarily reflect the opinion of *Model Railroad Hobbyist* or its sponsors. Every effort is made to provide our readers with accurate and responsible news and information, however, neither *Model Railroad Hobbyist* or the writer of this column can be held responsible for any inaccuracies or typographical errors that may inadvertently appear in this column.



**Click here for
reader comments**



.....

THIS MONTH'S BONUS EXTRAS

MRH SUBSCRIBERS GET ACCESS TO FREE BONUS extras, but you do have to be a subscriber! That's easy because [subscribing is free \(just click this link\)](#).

The bonus extras this month include:

- High quality versions of the issue videos
- Downloadable wallpaper of the best photos
- 10% off coupon code for MRH Store purchases in Sept.

To access the bonus extras, click the link below:

[**BONUS DOWNLOADS FOR THIS ISSUE**](#)

.....



BRIEFLY NOTED AT PRESS TIME ...

News From The National Train Show

We'll have lots of details and plenty of photos of new products shown at NTS in Portland, Oregon in the next edition of MRH. Meanwhile, here is a quick summary of things that caught our attention last week at the big event.

Accurail is preparing several special kits for release in November at Wisconsin-based Trainfest including an HO kit for a Wisconsin Central P-S 4750 covered grain hopper. The release includes a trio of Milwaukee Road car kits consisting of a 40-foot double-sheathed wood box car, a 40-foot single-sheathed outside braced wood boxcar stenciled for hide loading only, and a 70-ton triple-bay hopper car with offset sides.

American Z showed preliminary samples of a Z scale SD70ACe diesel locomotive, a steel caboose decorated for Santa Fe, and several samples of an impressive Procor Molton Sulfur tank car.

For many attendees, the focal point of **Athearn's** large display booth was the announcement of a new Genesis series HO scale GP39-2 diesel locomotive. The announcement was accompanied by a pre-production sample beautifully decorated for a local favorite: the Portland & Western Railroad. Additional road names will be available on the model which is scheduled for release next August. Other Genesis models on display included a new SD45-2 diesel locomotive and a 1960s-era F89 bi-level open auto rack car. A preview of future HO scale Ready-To-Roll

models included a five-bay rapid discharge hopper with removable coal load, and a 50-foot PS 5277 boxcar for BNSF, C&NW, CSX, and Rail Box, plus Canadian National and Southern in faded paint and patched reporting marks. Also on display was a SD40 diesel with BNSF/CN body details decorated for Central Oregon & Pacific.

Atlas showed their new series of ACF steel express reefers with welded sides. The HO scale model has an arched roof, 3/3 Improved Dreadnaught ends, high-speed trucks and separately applied ladders and grabs. Schemes will include REA, Great Northern, Santa Fe, Seaboard and Transport Arts Corp. Atlas also showed curved HO scale Code 83 turnouts. Atlas O's exhibit showed several impressive new models including triple-unit double-stack well-cars for 48-foot containers; nicely detailed heavyweight passenger cars, and the previously announced California Zephyr dome car.

Bachmann's large booth at NTS displayed a number of items including samples of a new N scale Pennsylvania Railroad 4-6-2 class K4 steam locomotive. Both pre- and post- World War I versions are available now with Bachmann's DCC Sound Value SoundTraxx® steam package at a MSRP of \$399.00. Additional new N scale items scheduled for release next year include a 72-foot heavyweight coaches with interior lights and a GG-1, which will be Bachmann's first N scale electric locomotive. For HO modelers, Bachmann showed a Baldwin 4-6-0 steam locomotive with 52-inch drivers. Also previewed at NTS was an EMD GP38-2, a 2-8-4 Berkshire steam locomotive, an Alco S4 diesel, and several new freight cars. All should be available before Christmas. Due next year is a new EMD E7-A diesel that will be

SEPTEMBER NEWS | 34

available with sound as well as DCC ready with an NMRA 8-pin plug. For On30 modelers Bachmann showed a 2-6-0 steam locomotive upgraded with metal gears and sound capability. Also coming for On30 modelers is a selection of Jackson Sharp passenger cars.

BLMA displayed test shots of its forthcoming Trinity 5660 PD covered hopper car. Both N and HO scale versions of the model are scheduled for release next year. Also shown were samples of new searchlight signals and a crude-oil tank car.

Bowser announced plans to produce an HO scale Canadian notched hood version of an SD50F diesel locomotive.

The newest HO scale laser-cut kit from **B.T.S.** is Fire Station No. 1. Details are available at btsrr.com/bts7235.htm. An O scale version of the kit is under development.

ExactRail showed their exquisite waffle-side car in new paint for Grand Trunk Western, and Santa Fe (as delivered in 1974). Additional waffle cars on display in ExactRail's booth were Union Pacific and Detroit Toledo & Ironton cars with new road numbers.

Kato USA displayed preliminary samples of an N scale Siemens/Amtrak ACS-64 Sprinter locomotive along with a new Amfleet I car. Both are scheduled for release next year. Kato showed their new logo-shirts that are currently for sale on their online store at goo.gl/w5m6SP.

Moloco Scale Models **showed preproduction samples of a new** General American Sill 1 10-6 boxcar offset with narrow door rods. Features include steel wire parts on underframe and corner stirrups, Kadee couplers, Kadee running boards, and

Moloco flexible air hoses made of real rubber. Some of the road names have different lettering on the sides and ends. All are priced at \$49.99 each. The stunning model is due to be released in 2016. Multiple road numbers will be available for C&NW, MODX (ART), NKP, NYC, and WADX (ART). Although similar to previous releases, owner Nick Molo assured us this version is entirely new.

North American Railcar had samples of their new 4275 cu. ft. National Steel Car triple-bay potash service covered hopper car. Both HO and N scale versions of this limited edition 2015 Portland NMRA Convention Car are available now. The model replicates Canpotex CNPX No. 150042, a prototype car that is currently in service decorated with the 2015 National NMRA Convention logo. Call 1-866-840-7777 for more information.

Rapido Trains surprised NTS attendees with the announcement of a scale Northern Pacific double-sheathed wood boxcar. Beginning in 1923, more than 4,000 of the prototype cars were built with many lasting until 1970. Details are pending on this ubiquitous car that was seen in operation all across North America. This distinctive car has never been available as an HO scale RTR model. Rapido also showed pre-production samples of an N scale Panorama baggage/express car decorated in a variety of liveries. The head-end car rides on six-wheel Commonwealth trucks with cast pedestals. Additional N scale models in Rapido's booth included beautifully decorated GARX meat reefers. They are being readied for release to dealers within the next 30 days.

Tangent Scale Models introduced an all-new HO scale Pullman-Standard PS-3 coal hopper at the National Train Show. Road names will be Clinchfield (in the "Original FH8" scheme

SEPTEMBER NEWS | 36

from 1958), Great Northern, Louisville & Nashville (in original 1957 Dixie Line scheme), Rock Island, and Utah Railway.

Also available at the show was Tangent's impressive General American three-compartment 6,000 gallon tank car in new paint schemes. They included STCX, GATX (in both early 1940s and later 1948 black schemes), COSX (Mid-Continent Petroleum Company 1929 Cosden & Co. scheme), PDAX, and WCHX (Walter C. Haffner Company). More information is available at tangentscalemodels.com.

Among the few disappointments at the National Train Show was **Walthers** announcement that, due to lack of advanced orders, the entire Fallen Flags series has been cancelled. The cancellation includes all of the Mainline Alco PA-PB diesel locomotives in Walthers 910-20051 to 20062, and 910-10051 to 10062 series, as well as all of the Proto series passenger cars. New items shown by Walthers included HO scale Mainline series EMD SD70ACe locomotives decorated for BNSF, CN, FEC, UP, UP Heritage, CNW, DRGW, and SP. They are due for release in March. Other new items included Walthers newly-tooled Proto series rebuilt Gunderson all-purpose 40' well-car that is due for release in February. Also shown were 80-foot PRR P70fBR coaches coming next summer in four versions: P70 (as built 80-seat, round roof), P70R (ice air conditioning, round roof), P70fBR (clerestory roof, mechanical air conditioning) and P70fBR (round roof, mechanical air conditioning). Walthers large display included some Mainline HO scale 89' Trailer Train channel-side flat cars scheduled for release in January. The flats are designed to handle 28-, 40-, 45- and 48-foot trailers. ■



The Amherst Railway Society Railroad Hobby Show

Our 2016 Show will be

January 30 & 31, 2016

Save the dates!

About The Show

Every year late in January or early in February, the Amherst Railway Society holds its Railroad Hobby Show at the Eastern States Exposition Fairgrounds (The home of The Big E) in West Springfield, Massachusetts. More than 25,000 railfans and public attended the Show each of the past three years.

The event features real life railroads and scale model railroads, historical societies, travel agencies, art shows, flea market dealers, importers, manufacturers and photographers. You have to see it to believe it!



**Click
to learn
more ...**



SELECTED EVENTS

September 2015

(Please note that many events charge a fee. Check individual info website for details.)

CANADA, QUEBEC, MONTREAL, September 26-27, Model Train Exposition, at Sun Youth Centre, 4251 St Urbain Street. Info at montrealmodeltrainexposition.com.

ALABAMA, DOTHAN, September 19-20, 25th Wiregrass Model Railroad Show & Sale, sponsored by Wiregrass Steel Wheels of NMRA Dixie Division at National Peanut Festival Fairgrounds, 5622 Highway 231 South. Info at ser-nmra.org,

ARIZONA, SCOTTSDALE, September 16-20, NMRA Pacific Southwest Region Convention, at McCormick Scottsdale Hotel, 7401 North Scottsdale Road. Info at psrnmra.org.

CALIFORNIA, PERRIS, September 12, Fall railroadiansa Swap Meet, at Orange Empire Railway Museum, 2201 South "A" Street. Info at oerm.org/upcoming-events.

GEORGIA, KENNESAW, September 18-19, Atlanta Railroads Prototype Modelers Meet, at the Southern Museum of Civil War and Locomotive History, 2829 Cherokee Street. Jointly presented by SRHA, Atlantic Coast Line & Seaboard Airline Railroads Historical Society, Central of Georgia Railway Historical Society, Louisville and Nashville Historical Society, and Nashville Chattanooga & St. Louis Preservation Society. Info at srha.net.

SELECTED EVENTS | 2

ILLINOIS, BIG ROCK, September 6, Illinois Live Steam & Milwaukee Live Engineers Meet, at Plowman's Park, 48W508 Hinckley Road. Info at facebook.com/PrairieStateRailroadClub.

INDIANA, EDINBURGH, September 12, 15th Annual Train Show & Swap Meet, hosted by Columbus Area Railroad Club, at Johnson County Park. Info at columbusarearailroadclub.com.

INDIANA, INDIANAPOLIS, September 18-19, Annual Convention Show & Sale, hosted by National Association of Timetable Collectors, at Clarion Hotel. Info at naotc.com.

INDIANA, SOUTH BEND, September 11-12, NMRA Michiana Division Education & Training Conference, at Comfort Suites University Arena. Info at michiana-nmra.org/events.

OHIO, MANSFIELD, September 19, Train Show, sponsored by Firelands Society of Model Railroaders, at Richland County Fair Grounds, 750 N. Home Road. Info at fsomr.com/train-show-fliers.html.

MASSACHUSETTS, TAUNTON, September 27, 15th Annual Train Show, sponsored by Old Colony Model Railroad Club, at Taunton Holiday Inn, Route 495 at Exit 9. Info at oldcolonymodelrailroad.tripod.com/train-show.html.

MINNESOTA, ST. PAUL, September 19, Fall Train Show, sponsored by Twin City Model Railroad Museum, at Minnesota State Fairgrounds, Education Building. Info at tcmrm.org/visit/exhibits-events/tcmrm-hobby-show-sale.

MISSOURI, SPRINGFIELD, September 26, Annual Fall Railroad Show, sponsored by Ozark Model Railroad Association, at Remington's, 1655 West Republic Road. Info at [omraspringfield.org/Fall Meet.html](https://omraspringfield.org/Fall_Meet.html).

SELECTED EVENTS | 3

NEBRASKA, NORTH PLATTE, September 18-20, Rail Fest 2015, info at nprailfest.com.

PENNSYLVANIA, YORK, September 25-26, East Coast Train Show, at York Expo Center, 334 Carlisle Avenue. Info at eclsts.com.

TEXAS, HOUSTON, September 2-5, 35th National Narrow Gauge Convention. Info at nngc-2015.com.

VIRGINIA, FREDERICKSBURG, September 25-26, 3rd Annual Mid-Atlantic RPM Meet, at Wingate by Wyndham Fredericksburg, 20 Sanford Drive. Info at marpm.org.

VIRGINIA, VIRGINIA BEACH, September 19-20, Tidewater Division 26th Annual Train Show, at Virginia Beach Convention Center, 1000 19th Street. Info at nmra-mer-tidewater.org.

WEST VIRGINIA, MADISON, September 12-13, Coal River Model Train Show at Madison Civic Center, 261 Washington Avenue. Info at facebook.com/pages/Coal-River-Model-Railroad-Club/288379344595756.

WISCONSIN, MADISON, September 13, NMRA South Central Wisconsin Division Meet, at Zor Shrine Center, 575 Zor Shrine Place. Info at nmra-scwd.org.

October 2015

CANADA, ONTARIO, BRAMPTON, October 3-4, Annual Brampton Model Railway Show with 33,000 square feet of display including N, HO, O and G scale operating equipment. At Brampton Fairgrounds, 12942 Heart Lake Road. Info at bramptonmodelrailwayshow.com.

- CANCELLED - CANADA, QUEBEC, LAVAL, Oct 3-4, The North Shore Train Show, Complexe Multi-Sports, 955 ave Bois-de-Boulogne. Info at salondutrainrivenord.org/english.html.

SELECTED EVENTS | 4

ARIZONA, TUCSON, November 13-14, Fall Train Show & Meet, at Tucson Expo Center, 3750 East Irvington Road, sponsored by Gadsden Pacific Division Toy Train Operating Museum. Info at gpdtoytrainmuseum.com/annual_fall_show.htm.

CALIFORNIA, SAN LUIS OBISPO and NORTHERN SANTA BARBARA COUNTIES, October 1-4, 2015. Central Coast Railroad Festival, self-guided layout tour. Details are pending. Visitors and participants contact Bob Chaparro for information at chiefbobbb@verizon.net, or go to ccrrf.com.

INDIANA, FORT WAYNE, October 29-November 1, Fort Wayne Rails 2015, NMRA North Central Region annual convention, hosted by NCR Division 3, at Hotel Fort Wayne, 305 East Washington Center Road. Info at fortwaynerails2015.ncr-nmra.org.

ILLINOIS, LISLE (Naperville), October 22-24, 22nd Annual Naperville RPM Conference, hosted by Joe D'Elia, at Sheraton Lisle-Chicago Hotel, 3000 Warrenville Road. Info at railroadprototypemodelers.org/naper_meet.htm.

NEW HAMPSHIRE, GREENFIELD, October, 17, Railroad Show, at Greenfield Historical Society, 828 Forest Road. Info from Dale Russell at dkrussell2@myfairpoint.net.

OHIO, WEST CHESTER, October 10-11, NMRA Mid-Central Region, Cincinnati Division 48th Annual Model Railroad Show at Lakota West High School, 8940 Union Centre Blvd. Info at cincy-div7.org/events.html. For table rental information contact Roy Hord at (513) 777-5337 or rhord@fuse.net.

TEXAS, FOREST HILLS, October 10-11, Texas Western Model Train Show, presented by the Texas Western Model Railroad Club, at Forest Hill Civic Center, 6901 Wichita Street. Info at twmrc.org.

SELECTED EVENTS | 5

TEXAS, FORTH WORTH, October 16-17, Southwest O scale Meet, at Forth Worth Academy, 7301 Dutch Branch Road. Info at oscalesw.com.

Future 2015 (by location)

COLORADO, LONGMONT, December 11-13, 38th Annual Model Railroad Expo, at Boulder County Fairgrounds, Hover & Nelson Roads, sponsored by Boulder Model Railroad Club. Info at bouldermodelrailroadclub.org.

MASSACHUSETTS, MARLBOROUGH, Dec 5-6, 2015, Annual New England Model Train Expo, at Best Western Royal Plaza Trade Center, 181 Boston Post Road (US Rte. 20), hosted by NMRA HUB Division. info at hubdiv.org.

OHIO, DAYTON, November 7-8, 40th Annual Dayton Train Show, at Hara Arena, 1001 Shiloh Road. Info at daytontrain-show.com.

TEXAS, SAN ANTONIO, November 21, Texas Train Show, at Christopher Hall, 16002 Thousand Oaks Drive. Info at texastrain-show.net.

WASHINGTON, KENT, November 14, Annual Swap Meet, sponsored by Boeing Employees Model Railroad Club. Event at 525 4th Ave. North. Info at swapmeet@bemrrc.com or contact Ed Sherry at 206-244-3884. Further info at bemrrc.com.

WISCONSIN, WEST ALLIS (Milwaukee), November 14-15, Trainfest, Wisconsin Exposition Center at Wisconsin State Fair Park. Info at trainfest.com.

Future 2016 and beyond (by location)

CANADA, BRITISH COLUMBIA, SALMON ARM, June 15-19, Selkirk Express 2016, Pacific Northwest Region Annual Convention and Train Show. Info at 7divpnr.ca/node/31.

COLORADO, DENVER, 2017, National Narrow Gauge Convention.

ILLINOIS, CHICAGO, October 1-2, 2016, Brass Expo, a juried show limited to pre-submitted items including brass models (all scales), brass hybrid models, publications, parts, tools, painting, repairing and custom building relevant to brass models. Admission \$25 good for both days (includes one free admission for spouse or child under age 16). At The Westin Hotel (Chicago North Shore), 601 N. Milwaukee Ave. Wheeling, IL 60090. Info at brassexpo.com.

INDIANA, INDIANAPOLIS, July 3-10, 2016, NMRA National Convention and National Train Show. Info at nmra2016.org.

MAINE, AUGUSTA, Sept. 7-10, 2016, 36th National Narrow Gauge Convention. Info at nngc2016.org.

MASSACHUSETTS, WEST SPRINGFIELD, January 30-31, 2016 Railroad Hobby Show, sponsored by Amherst Railway Society, at Eastern States Exposition Fairgrounds, 1305 Memorial Avenue. Info at railroadhobbyshow.com. ■



**Click here for
reader comments**

Clickable advertiser index – 1

[Accu-Lites](#)

[American Ltd \(San Juan\)](#)

[Amherst Railway Society](#)

[ANE Models](#)

[Archer Fine Transfers](#)

[Athearn](#)

[Atlas Model Railroad Co.](#)

[Bachmann](#)

[Backdrop Junction](#)

[Berrett Hill Trains](#)

[Black Cat Publishing](#)

[Blair Line](#)

[BLMA](#)

[Bowser](#)

[Caboose Hobbies](#)

[Canyon Creek Scenics](#)

[Clever Models](#)

[Coastmans Scenic Products](#)

[Coffman Graphics](#)

[Credit Valley Railway](#)

[Dallas Model Works](#)

[Digitrax \(2 page spread\)](#)

[ESU LokSound](#)

[Fast Tracks](#)

[Fifer Hobby Supply](#)

[Fox Valley Models](#)

[George's Trains](#)

[GLX Scale Models](#)

[Grand Central Model Railway](#)

[Great Decals](#)

[Hobby-On \(MRS Hobby\)](#)

[HO Diesel Supply](#)

[Iowa Scaled Engineering](#)

[Iwata-Medea](#)

[Jelsma Graphics](#)

[Ken Patterson](#)

[Lights 4 Models](#)

[Litchfield Station](#)

[Logic Rail Technologies](#)

[Microscale](#)

[Missouri Pacific Historical Society](#)

[Model Railroad Benchwork \(1\)](#)

[Model Railroad Benchwork \(2\)](#)

[Model Tech Studios](#)

[Motrak Models](#)

[Mountain Subdivision Hobbies](#)

[MRH Store \(Model Trains Video\) \(1\)](#)

[MRH Store \(Model Trains Video\) \(2\)](#)

[MRH Store \(Model Trains Video\) \(3\)](#)

[Nano-Oil](#)

[NCE \(2 page spread\)](#)

[Nick & Nora Design](#)

[North American Railcar](#)

[Pre-Size Model Specialities](#)

[Precision Design Co.](#)

[Railroad Explorer](#)

[Rapido \(1\)](#)

[Rapido \(2\)](#)

[Ring Engineering \(1\)](#)

[Ring Engineering \(2\)](#)

[Rulers-of-the-World](#)

[Rusty Stumps](#)

[Scenic Express](#)

[Scotty Mason Show](#)

Clickable advertiser index – 2

[Signature Press](#)

[Soundtraxx \(Blackstone\)](#)

[Southern Digital](#)

[Streamlined Backshop](#)

[TAM Valley Depot](#)

[Tony's Train Exchange](#)

[Trainfest](#)

[TrainMasters TV \(1\)](#)

[TrainMasters TV \(2\)](#)

[TrainMasters TV \(3\)](#)

[Traintek](#)

[True Scene Modeling](#)

[Vector Cut](#)

[Westerfield Models](#)

[Yankee Dabbler](#)

[Yarmouth Model Works](#)

Clickable “other” index

[Other – Bonus Extras](#)

[Other – Cover](#)

[Other – Derailments](#)

[Other – Hobby Marketplace](#)

[Other – MRH Sponsors](#)

[Other – Staff Notes](#)

[Other – Table of Contents](#)



DOWNLOAD PORTRAIT



DOWNLOAD LANDSCAPE



REVERSE RUNNING

commentary

JOE BRUGGER
.....



[Click here for
reader comments](#)

NUKE THE CLUTTER

VERNE NINER HAD A GREAT line in his July “Imagineering” column. One of his steps to moving ahead on a layout is “change or fix what doesn’t work for you.” He said, “Nuke the clutter and restore the railroad room to a pleasant environment.”

Model railroaders have too much stuff. We’re not talking about the stack of GP9s and GP30s. Those will get decoders and be super-detailed someday.

Nor the half dozen SD40s. Nor the boxes of unassembled reefers from Intermountain and Red Caboose.

We’re talking about the stuff that gets in the way, the workbench atop the benchwork that is home to a couple of power drills, boxes of assorted bits, and switch-building jigs. We mean the taped-up cartons of Scout projects, rolls of carpet, boxes of wood scraps, and holiday decorations lingering under the benchwork.



▶ **STEPPING OUTSIDE THE BOX WITH A CONTRARY VIEW**

Life's messy, clean it up.

Work on the layout grinds to a halt when you have to shift a pile of household surplus to work on the wiring. Are you really going to find a use for half-a-dozen 5 ¼" disc drives? Don't kid yourself. Call the kids and ask them to pick up their crystal-growing science project from junior high school. Better yet, have them send their kids over to help you haul boxes to the curb.

Swap meets are a big help. I reduced two banker's boxes of unneeded books, structures, locomotives, and rolling stock to a pair of Athearn locomotive boxes. That's probably a 10:1 reduction in volume.

You can install half a dozen switch machines in an afternoon – if there is easy access underneath the benchwork. You can apply static grass, and create a rutted dirt road – as long as tools and parts don't have to be swept away to reach the work area. Why, you could even spread a drop cloth under the railroad to capture all of the mess that layout and scenery work creates.

Parts you can't find are not worth having. How many sets of Detail Associates MU receptacles do you have? How many can you lay your hands on in the next five minutes? Hang them on a peg board, or find a plastic bin the right width and depth. Knock together a couple of dividers out of illustration board or styrene to keep them separated.

Hauling away excess stuff leaves you more space to arrange the items you keep. Find a roll-around cart for the tools and give it a solid work top. Add a small vise and power strip to plug in the Dremel or soldering iron. Keep the drills and jig saw in the bottom tray. The tools never have to be left on the benchwork again.

Load up another little cart with scenery supplies – tree-making materials and ground covers proliferate like bunnies, and leave little bits and pieces wherever they go.

The old-timers liked to talk about their “empires.” How much junk is in yours?



DERAILMENTS

Time Lapse - Rail Bridge Replacement, Cow Lane, Reading



1600 TON BRIDGE BUILT IN 4 MIN!

Ok, not really. But, the time-lapse photography is amazing to watch ... It's some great bridge engineering and construction in Reading, UK.

It took over 7 hours to maneuver the 1600-ton concrete and steel structure into place sitting on top of a 66-axle truck!

Learn more about it here:

trainfanatics.com/1600-ton-train-bridge-built-in-4-minutes/?a=lm&var=BridgeBuild-ILT

► BIZARRE FACTS AND HUMOR (SUPPOSEDLY)

“On which side of the platform is my train?” asked a stranger in a Jersey City depot the other day.

“Well, my friend,” replied a gentleman, passing, “if you take the left you’ll be right; if you take the right you’ll be left.”

–*Weekly Mountaineer, The Dalles, Oregon, January 6, 1877*

The introduction of so powerful an agent as steam to a carriage on wheels will make a great change in the situation of man.

–*Thomas Jefferson, 1802*

In South Dakota, it is illegal to place firecrackers on railroad track. The fine doubles if they are lit.



[Click here for reader comments](#)

Coming next issue ...

- Clark Propst builds the Allied Mills mini-layout
- Removable car loads
- SP&S switching layout
- Making a DCC test track
- Forced perspective tricks
- Building Crissa Saloon
- And lots more ...

