

HAVING FUN WITH TRAINS

AUGUST 2015 | FREE

MRH

MODEL RAILROAD HOBBYIST

Don Hanley builds
The Meadow
Gold dairy

»» READ NOW

ALSO:

- Getting started with DCC
- A railroader's layout
- Small layout operation
- Bashing passenger cars
- Timetable using Excel

... and lots more inside!

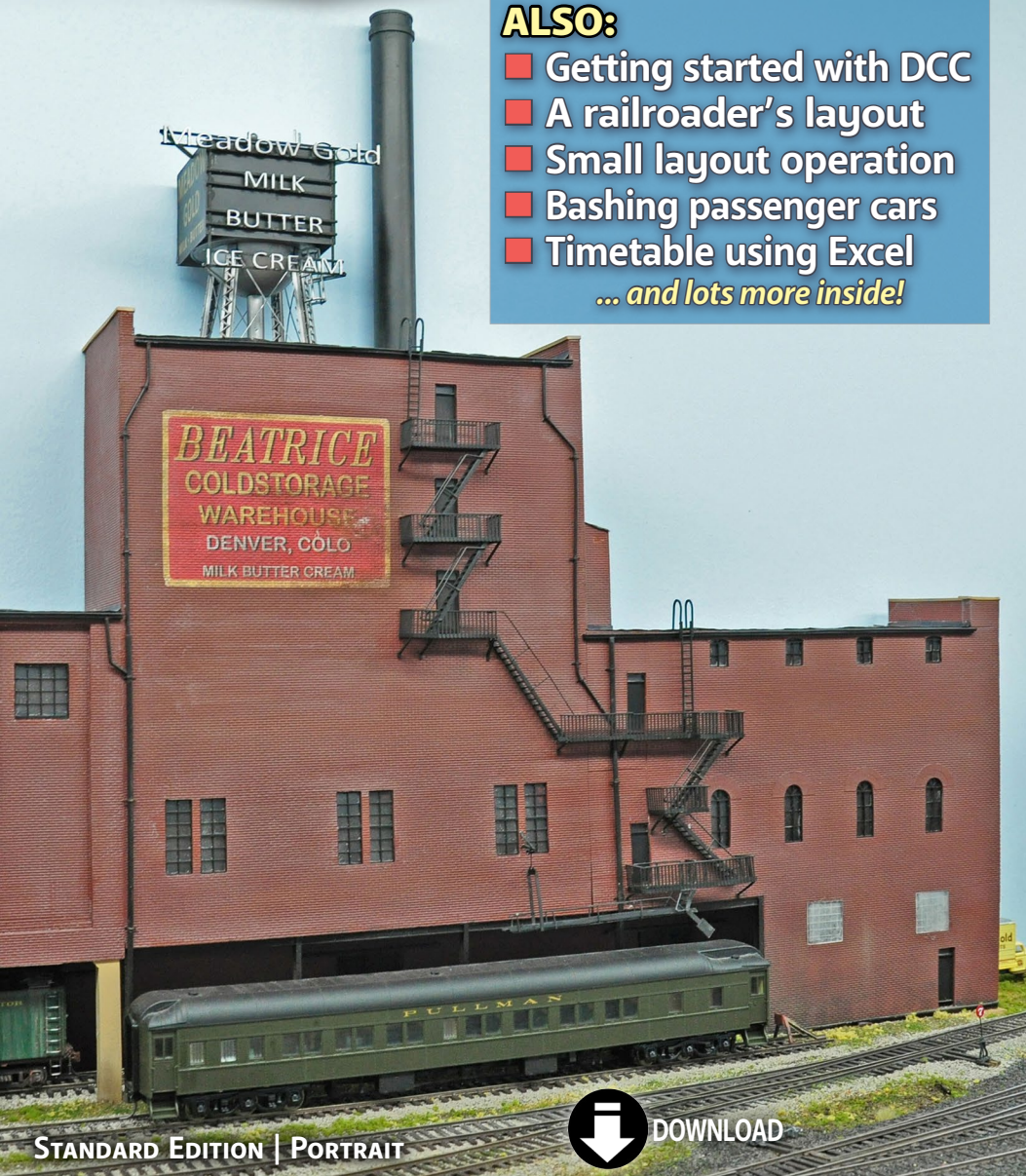

STANDARD EDITION | PORTRAIT



DOWNLOAD



BLMA MODELS

NEW TOOLING
TRINITY 5660
-PD-

FLOUR POWER

COVERED HOPPER

HO & N SCALE
ORDER ALL 24 NUMBERS TODAY!

The **5660 Pressure Differential (PD) Covered Hopper** was first introduced in 1999, by Thrall Industries, as the latest advancement in the evolution of Pressure Differential Covered Hoppers. Production continues today under the TrinityRail brand, with nearly 4,000 cars already in service. These specialized PD covered hoppers are notably different from traditional "gravity discharge" covered hoppers in both form and function. Designed to transport powdery commodities such as flour and talc, the 5660 PD Covered Hopper features five non-opening bays connected by a master pipe. The cars are unloaded by pressurizing the interior of the car with air, thus blowing the commodity out. An icon of today's railroading, the Trinity 5660 PD Covered Hopper is perfect for your modern layout! **Coming in HO & N**, collect all 24 numbers by ordering now through your favorite dealer or direct!

ORDER BY : SEPT. 15TH
DELIVERY BY: Q2 2016
BLMAmodels.com
**BLMA
BLOG**

**You
Tube**
MRHMAG.COM

- TABLE OF CONTENTS
- INDEX



Model Railroad Hobbyist | August 2015 | #66

STAFF CREDITS

Front Cover: Assistant Editor Don Hanley builds the Meadow Gold Dairy in this issue's cover story. Follow along as he does the project!



ISSN 2152-7423

Editorial Staff

Joe D. Fugate, Publisher and Editor
Don Hanley, Assistant Editor

Production

Patty Fugate, pasteup and layout
Joe Brugger, copy editing
Mike Dodd, copy editing

Technical Assistants

Jeff Shultz
Jimmy Simmons

Advertising

Les Halmos, Account Manager
Daniel Nava, Advertising Assistant
Jean-François Delisle, Marketing Assistant

Columnists

Richard Bale, News and events
Jeff Shultz, News and events
Les Halmos, Modular railroading
Larry Smith, Narrow Gauge/Shortlines
Bruce Petrarca, DCC
Ken Patterson, Reporter at large

Special Correspondents

Joe Brugger, Questions & answers
Charlie Comstock, Contributing editor
Issue password: Aug2015
Published for the glory of God. [What's this?](#)



MRH SPONSORS

A - E



acculites.com



americanlimitedmodels.com



railroadhobbyshow.com



anemodel.com



archertransfers.com



athearn.com



www.atlasrr.com



bachmanntrains.com



bachrus.com



backdropjunction.com

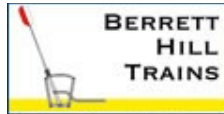

berrethill.com/trains



blairline.com



blmamodels.com



bowser-trains.com



caboosehobbies.com



coffmaneng.com



cvrco.com



www.digitrax.com



esu.eu/en

[Vendors: Get your clickable logo here ...](#)

MRH SPONSORS | 2

F - R



www.handlaidtrack.com



fiferhobby.com



foxvalleymodels.com



glxscalemodels.com

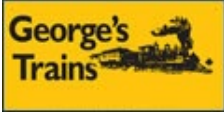

georgestrains.com



www.hobby-on.com



www.iascaled.com



iwata-medea.com



litchfieldstation.com



mapleleaftrains.com



micromark.com



microscale.com



model-trains-video.com



modeltechstudios.com



stores.ebay.com/Motrak-Models



mthtrains.com



nano-oil.com/Model%20Railroad.html



ngc-2015.com



ncedcc.com



nickandnoradesigns.com



www.pwrs.ca/main.php



nmra2015portland.org



railmasterhobbies.com



rapidotrains.com



ringengineering.com



rr-cirkits.com



rslaserkits.com



rustystumps.com

[Vendors: Get your clickable logo here ...](#)

MRH SPONSORS | 3

S - Z



sanjuancarco.com



scenicexpress.com



signaturepress.com



soundtraxx.com



sodigi.com

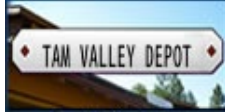

tamvalleydepot.com



tonystrains.com



trainfest.com



traintekllc.com



walthers.com



yankeedabblers.com

[Vendors: Get your clickable logo here ...](#)

Looking for something? Check our Hobby Marketplace!

The screenshot shows the Hobby Marketplace website interface. At the top, it says "HOBBY MARKETPLACE | 2". Below this, there are several advertisement tiles for various model train products and services, including "HO Scale Passenger Car Lighting Boosters", "Yankee Dabblers Model Works", "CLEVER Computer Controlled Accessories", "KLEIN'S MOBILES", "SUGAR CUBE SPEAKERS", "DuckWork", "HELIX - the WORLD'S BEST 1:24 Scale", and "True Scene Modeling". A sidebar on the left contains navigation links like "HOME", "ABOUT", "CONTACT", and "FAQ". At the bottom, there is a footer with social media icons and the text "Hobby Marketplace Ads are Economical and Effective."

Take me there!

- TABLE OF CONTENTS
- INDEX

N
SCALE



Real Trains

GET CONNECTED WITH BACHMANN'S NEWEST BOX CARS

Our N scale Silver Series® rolling stock line continues to expand with colorful new roadnames for our 50' Plug Door, 50' Sliding Door, and ACF 50'6" Outside Braced Sliding Door Box Cars. All are equipped with body-mounted E-Z Mate® Mark II couplers for under-track magnetic operation and realistic coupling and uncoupling action. These Box Cars also feature blackened metal wheels, non-magnetic axles, detailed underframes, and prototypical graphics. Visit your favorite hobby dealer to get connected with our full line of rolling stock today!

50' PLUG DOOR BOX CARS MSRP \$34.00 each



Santa Fe
Item No. 71052



Pennsylvania Railroad
Item No. 71064



New York Central®
Item No. 71070



CP Rail
Item No. 71077



New Haven
Item No. 71083

Click to learn more.

ALL SHIPPING NOW!

50' SLIDING DOOR BOX CARS MSRP \$35.00 each



Rio Grande
Item No. 19456



PRR - Merchandise Service
Item No. 19457

ACF 50'6" OUTSIDE BRACED SLIDING DOOR BOX CAR MSRP \$29.00 each



Montana Rail Link
Item No. 19657



Norfolk Southern
Item No. 19658

Click to learn more.



Bachmann Industries, Inc. • 1400 East Erie Avenue • Philadelphia, PA 19124 USA • www.bachmanntrains.com

Click for more information.

MRHMAG.COM

- TABLE OF CONTENTS
- INDEX



TABLE OF CONTENTS

FEATURES

Building Meadow Gold dairy

DON HANLEY

Techniques for scratchbuilding a large brick industry



A railroader's railroad

BARRY KARLBERG

See the layout a real-life railroader built



Saskatchewan covered hopper

GREG LUERS

Weathering a covered hopper with acrylic & chalk



Using Excel to create a timetable

KEN BILES

Simple methods for getting a great-looking timetable

SCHEDULE		SCHEDULE		SCHEDULE	
Train No.	Start	Train No.	Start	Train No.	Start
110	11:00	210	11:00	551	11:00
110	11:00	210	11:00	551	11:00
110	11:00	210	11:00	551	11:00
110	11:00	210	11:00	551	11:00
110	11:00	210	11:00	551	11:00

SP passenger cars, part 5

VICTOR ROSEMAN

Kitbashing accurate heavyweight baggage cars



ALSO: Hobby Marketplace | Bonus downloads

TABLE OF CONTENTS | 2

COLUMNS

MRH Q-A-T: Operating a small layout, and more ...

compiled by JOE BRUGGER

DCC Impulses: Getting started in DCC

BRUCE PETRARCA

Getting Real: Finishing an entire aisle, part 2

MIKE ROSE

What's Neat: Helicon focus, carving foam, and more ...

KEN PATTERSON

Imagineering: The corporate image

DOUG GEIGER

Photo feature: Yes, it's a model

compiled by DON HANLEY

Derailments: Bizarre facts & humor

compiled by the MRH STAFF

NEWS and EDITORIAL

Publisher's Musings: Attending a National Convention

JOE FUGATE

Staff notes: Special display in Portland ...

compiled by the MRH STAFF

News & Events: August 2015

RICHARD BALE & JEFF SHULTZ

Reverse running: And the winner is ...

DON HANLEY



PWRS 

Announcing our next Limited Run PWRS / Micro-Trains® Cars!!!

Canadian Pacific (CP) • 4-Pack 50' Rib Side Box Car, Plug Door, w/o Roofwalk



Joe Rogers, photo



Insulated - Heated

- Action Yellow, black lettering
- Multi-Mark
- Light weathering & medium rust

COMING
February 2016

CLICK HERE FOR
CP Boxcar 

Canadian National (CN) • 3-Packs 57' 6" Converted TOFC Flat Car

- Flat Car: Mineral Brown, white lettering

Set #1 - with CN Intermodal Trailers

Set #2 - with CN Piggyback Trailers



COMING
February 2016

CLICK HERE FOR
CN TOFC 



Pacific Western Rail Systems

MRHMAG.COM

- TABLE OF CONTENTS
- INDEX



PUBLISHER'S MUSINGS

editorial

JOE FUGATE



[Click here for
reader comments](#)

ATTENDING A NATIONAL CONVENTION

EVERY MODELER OWES IT TO THEMSELVES TO

take in at least one National NMRA Convention in their life. It's a memorable experience that will "jazz" you about doing the hobby for at least six months afterwards – at least that's how my first National NMRA Convention affected me.

The NMRA Convention and Train Show moves to a new city each year, and this year's convention is in Portland, Oregon, August 23-30 (Sunday to Sunday, the last week of August).

MRH's home office is in Woodburn, OR, some 30 miles south of Portland – so this year's National Convention is local to us. Several of the MRH staff will be showing a home layout, or they're part of a club layout that will be open for tours.

The NMRA National has two major parts: the convention (which runs from Sunday through Saturday) and the National Train Show (which runs from Friday through Sunday).

The convention events include layout tours, prototype tours, clinics (seminars), special interest group (SIG) rooms, and model displays. The special interest group rooms commonly

PUBLISHER'S MUSINGS | 2

include the Layout Design SIG, the Operations SIG, and the Railroad Prototype Modelers (RPM).

The convention itself concludes on Saturday night with the NMRA banquet, which includes various honors, awards and a special guest speaker.

The Layout Design SIG conducts its own special layout tour on Wednesday of the area's "cream of the crop" layouts, and it's a personal favorite of the MRH staff. Since it's a car tour that you take at your own pace, we typically load up a van and try to take in as many layouts as we can that day from dawn to dusk.

The Layout Design SIG also conducts its own banquet on Friday night, which often includes interesting guest speakers. This year's guest speaker is Bruce Chubb, certainly a name many who have been in the hobby for a while will recognize!

ADVERTISEMENT

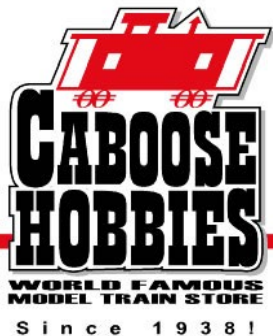

The World's Largest Model Train Store!

Model trains G to Z, DCC, brass models, kits, RTR, collectable models, scenery, structures, books, magazines, DVD's, hobby tools & supplies and a full service repair department.



WWW.CABOOSEHOBBIES.COM

MRHMAG.COM

- [TABLE OF CONTENTS](#)
- [INDEX](#)

INTRODUCING



THE NEW ATHEARN ROUNDHOUSE

Historically, the Roundhouse brand delivered quality pre-1940s era models while maintaining a terrific value. Building upon this tradition, Athearn® Roundhouse is now home to the hobby's best-loved models. No matter your era or favorite railroads, Athearn Roundhouse has a complete product selection for the beginning and experienced hobbyist.



Check out the new Athearn Roundhouse line at Athearn.com.



HORIZON
H O B B Y

VISIT
Your Local Retailer

CLICK
Athearn.com

CALL
1.800.338.4639

SERIOUS FUN™

©2004 Horizon Hobby, LLC. Athearn, Genesis, Ready To Roll, Trains in Miniature, Serious Fun and the Horizon Hobby logo are trademarks or registered trademarks of Horizon Hobby, LLC. The Union Pacific mark and other marks owned by Union Pacific are made under trademark license from Union Pacific Railroad Company. All other trademarks, service marks and logos are property of their respective owners. Final models may vary slightly from photos shown. 4/09Z

MRHMAG.COM

- [TABLE OF CONTENTS](#)
- [INDEX](#)



GLX
TOP QUALITY PRODUCTS
FOR THE MODEL RAILROAD CRAFTSMAN
WWW.GLXSCALEMODELS.COM

Sugar Cube
Speaker

Click to Order



SmartSwitch ANE model

**New SmartFrog™
is coming**

Let you rid itself of manual switching on your turnout frog
From now on, turnout Frog polarity change automatically is not a dream.
ANE MODEL New version SmartFrog™ Let your dreams come true!!

- Frog polarity change automatically
- Two LED output for turnout signal control
- Independent Operation or Connect SmartSwitch™ Interlock Control

ELECTROFROG

PUBLISHER'S MUSINGS | 3

As for the clinics, the presenters list often reads like a who's who in the hobby, including some international names from Europe and Australia. The topics cover everything from prototype information, to modeling industries, modeling scenery, tuning locos, DCC wiring, and track planning. A few clinics are hands-on, giving you a chance to get tutored by some of the best in the hobby in a particular skill.

Then there's the opportunity to rub shoulders with other modelers who share your interests. You'll have several chances to meet up with fellow modelers at clinics or on tours and then you can have a meal or two with them and share ideas. That will rev up your hobby batteries for sure!

The National Train Show often has over 80,000 square feet of modular layouts, vendor booths, and flea market "stacked to the

**LET'S FACE IT. ALL THE
FA-2 MODELS OUT THERE
SUCK!**



WELL, NOT ANYMORE.

**HO SCALE FA-2/FPA-2 COMING FROM RAPIDO.
CLICK HERE FOR INFO.**

PUBLISHER'S MUSINGS | 4

rafters” tables of things for sale. MRH has a booth at this show every year, and so do many other name manufacturers like Athearn, Atlas, Bachmann, BLMA, Bowser ... the list goes on.

The National Train Show starts out Friday morning by opening only to convention attendees, so registrants get the run of the show floor for several hours without having to deal with a show overrun by the general public. After noon, the show opens to the public and then families and local modelers who are not registered for the convention can attend. The National Train Show often sees 25-30,000 or more over the three days it runs.

We love to have modelers come by the MRH booth and share their thoughts on MRH magazine, our books, or videos, or discuss TrainMasters TV with us. We also love to hear requests for articles or topics we should put on TMTV.

And this year, my own personal event will be getting to share my Siskiyou Line layout with modelers who've been a fan of the layout through my website or via my Siskiyou Line video series.

Because the convention moves to a different part of the country each year, keep an eye out for when it comes close to you, and come say hello. You'll find your enthusiasm for the hobby will go up several notches for at least six months afterwards!

Follow my Siskiyou Line progress [on my MRH blog...](#)



**Click here for
reader comments**

You're the kid.



Welcome to the candy store.

- 180,000 square feet of sheer bliss
- Over 250 manufacturer & retailer booths
- 50,000 square feet of modular layouts
- “Ask the Collectibles” appraiser
- Trains, accessories, collectibles & more
- Hands-on demonstrations

August 28 - 30, 2015
Portland Expo Center

2060 North Marine Dr.
Portland, OR 97217

Sponsored by



**CLICK HERE
FOR ALL THE
DETAILS!**

www.nationaltrainshow.com

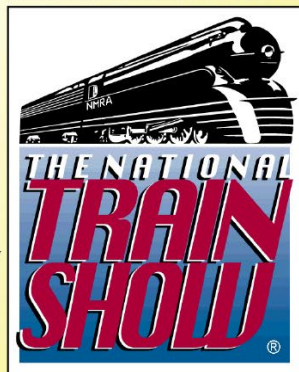

Why spend hobby funds on
TRAINMASTERS.TV ?



“TMTV has paid for itself many times over in knowledge and techniques learned.” - Peter R.

[Read more TMTV reviews here](#)

(click link)

Start saving today with TMTV

Special pricing in effect during August

[HEY! Get another 20% off - click to learn how!](#)



STAFF NOTES



[Click here for
reader comments](#)



SPECIAL DISPLAY IN PORTLAND ... AND MORE

MRH READER AND AUTHOR DENNIS MURPHY

of Olympia, WA plans to display some dioramas at the NMRA National in Portland this month, and he has an interesting approach to adding some signage to his display. We'll let Dennis tell you about it ...

“Once I knew I could attend the 2015 Portland, Oregon NMRA National Convention, I worked on some diorama displays for

STAFF NOTES | 2

the show. If you have never been able to attend one of the larger model railroad conventions, then you should certainly put it on your 'must do' list!

"I thought I would build two new (but completely different) dioramas to enter in the contest room. One is of an HOn3 rural logging camp from the 1930s. And the second diorama is as different as you can get: It's a busy downtown Chicago elevated train from the 1950s, in N-scale. What fun!

"I was having so much fun building these dioramas that I did not want the project to be over. After mulling about the need to do 'something more' – I decided to add an extra special identifying sign with the diorama name and my name as builder on it.

"For the 'extra special' part of the sign, I made a micro-miniature piece of the diorama itself! I aimed to get the same colors and textures as the full-sized dioramas, so they looked like a piece.

"For the sawmill diorama sign, I started with a chunk of excess foam left over from another project. A little cutting here and some sanding there, and I had a small hill to which I added some ground cover, a few tree stumps, a bit of sawdust, and finally some brush trees.

"For the Chicago elevated train diorama sign, I had to be more creative. By chance, the ITLA Scale Models Company had sent along some extra bits and pieces when they shipped me the original kit. I kept the bits 'just in case.' Using these extra parts I fashioned them into a facsimile of the elevated train model.

"The rest was easy. I made the signs on my computer and printed out a number of different sizes to see which would go best with my 'micro-mini' dioramas.



LAST ISSUE'S RATINGS

The five top-rated articles in the [July 2015 issue](#) of *Model Railroad Hobbyist* are:

- 4.7 Getting Real: Finishing an entire aisle, part 1
- 4.7 Publisher's Musings: Heavier cars = better performance?
- 4.6 What's Neat: July 4 photo shoot and more
- 4.5 DCC Impulses: DCC garden wiring tips
- 4.5 Imagineering: Tale of two layouts

Issue overall: **4.5**

Please rate the articles! Click the reader comments button on each article and select the star rating you think each article deserves. Thanks! ■

ADVERTISEMENT

Check out the latest Atlas All Scales Catalog!

View and pre-order all of the latest locomotive and freight announcements from Atlas now!

CLICK HERE!

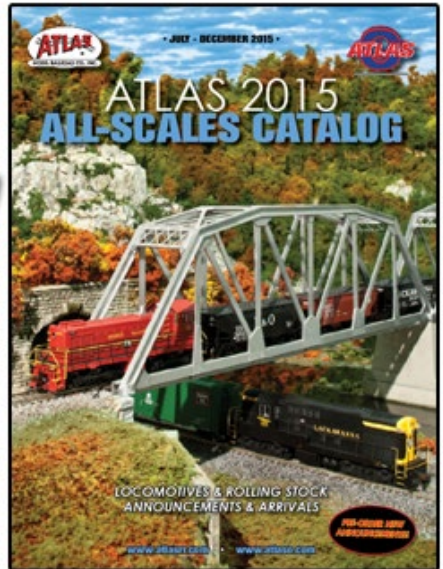

MRHMAG.COM

- [TABLE OF CONTENTS](#)
- [INDEX](#)

STAFF NOTES | 4

“This was such a fun and easy little project that I think I will continue making these micro-mini dioramas for each new ‘real’ diorama I build. In fact, I might even build new signs for some of my older dioramas! After all, a good diorama deserves a memorable nametag.

“If you’re attending the 2015 Portland, Oregon show, make sure to have a look at my cool diorama signs with their micro-mini dioramas. Oh, and you might want to also have a look at the full actual dioramas, too!”

– *Dennis Murphy*

Siskiyou Line update

Speaking of operations, Joe Fugate just had his third operating session on his Siskiyou Line after it had been mothballed for

ADVERTISEMENT



Checked us out lately?

Established 1993...
Blair Line

WHAT'S NEW? 

ADVERTISEMENT



Backdrop Junction
Your Stop for Railroad Backdrops

Click Here 

**For the Finest in Custom
Designed backdrop**

www.backdropjunction.com

STAFF NOTES | 5

three years. This third session had 10 people show up. This is the last op session prior to the special op session being held for eight convention attendees the end of August.

You can read all about it [here on Joe Fugate's blog](#), with photos.

As for conductivity, everyone agrees it's practically flawless, thanks to track cleaning and the application of graphite. Several cars, however, have some rolling problems. Apparently, the trucks could use a good reaming with a reamer (see photo).



ADVERTISEMENT



Announcing *Motrak Models Flat Paint Made by Scalecoat:*

Rail Brown – White – Black - Silver
Aluminum – Oxide Red – RR Grime #1
RR Grime #2 – Boxcar Red – Roof Brown
Aged Concrete – Dirt – Sand - Rust
MOW Gray – Engine Black

Limited quantities - place your order now!
We still have other colors available from Scalecoat.

Phone number: 813-476-4784
Email: motrakmodels@centurylink.net

**CHECK
IT OUT!**

Cars that don't roll well coupled with a slight loss in pulling power because of graphite don't help. Then there's the fact adding weight to the cars reduces the pulling capacity of the locos a bit further. So it becomes more important than ever that the cars can roll easily. Clearly, Joe has a project ahead of him before the end of August to get all 300-some cars on his layout through a rollability test and tuned as needed.

While he's at it, Joe also will check his fleet for coupler height and any minor repairs needed such as a missing brake wheel or broken stirrup step.

Nothing like a convention coming to town to get you in gear and working on the layout in earnest, is there Joe?

Besides all these operational considerations, Joe also is working to get his Dillard mill complex to a more finished look. This scene is one of the first you see when you enter the layout room, so it will help the visual impact of the layout go have something that looks more finished when you enter the room.

The latest updates on Joe's Siskiyou Line layout will be coming to [TrainMasters TV](#) in season 3 (starts in November), so check it out. MRH has summer special pricing right now on TMTV, and if you're an MRH subscriber, you can save another 20% off these already discounted prices by [using the coupon code found here](#).

You do need to be an MRH subscriber to access the code – but since subscribing to MRH is free, then [why not subscribe?](#)

What's new on the MRH website?

Here's our monthly listing of some interesting posts.

Recommend me a loco mrhmag.com/node/23161

STAFF NOTES | 7

Custom HO traffic light: mrhmag.com/node/23153

Foamcore spray booth: mrhmag.com/node/23057

Small hobby space ideas: mrhmag.com/node/23136

Flexible retaining walls: mrhmag.com/node/23148

Weird hobby injuries: mrhmag.com/node/23154

Modeling an industrial area: mrhmag.com/node/23024

Configurable servo decoder for \$5: mrhmag.com/node/19446

Is unweathered wrong? mrhmag.com/node/23071

Favorite soldering products: mrhmag.com/node/23137

Ballasting by the book or prototype? mrhmag.com/node/21976

Using sedum for trees: mrhmag.com/node/23097

ADVERTISEMENT



Rusty Stumps

Scale Models

WE ONLY SELL WHAT WE MANUFACTURE

DETAILS

IN HO, O, S & N SCALES

LASER CUT SHINGLES, DOORS & WINDOWS, FENCES, SIDING, CRATES. Also RESIN and WHITE METAL DETAILING CASTINGS.

CRAFTSMAN KITS

IN HO, O & S SCALES

CHECK IT ALL OUT AT

WWW.RUSTYSTUMPS.COM

Send \$3.50 for Catalog - Specify Scale

RUSTY STUMPS SCALE MODELS

6785 Cherry Blossom W. Dr., Fishers IN 46038

Phone (317) 595-9489

MRHMAG.COM

- [TABLE OF CONTENTS](#)
- [INDEX](#)

In the oops department ...

Something got crossed up with the coming next issue article listing in July for this issue and many of the articles listed there are not in this issue. They're actually coming in the September issue. So *mea culpa*, we goofed but good. Maybe we need new glasses? At any rate, this issue has lots of good stuff in it you probably weren't expecting, so enjoy!



[Click here for
reader comments](#)

ADVERTISEMENT



Your Local **N Scale**
Online Hobby Shop

575-523-9743
fiferhobby.com

The Get the Latest Model Railroading News, Tips, Reviews & Opinions

SCOTTY MASON

S H O W

The Original Model Railroad Podcast

-Monthly Interviews

- Modeler's Spotlight: Top Modeler's Talk
- Narrow Gauge Modeling w/Chris Lane
- Contemporary Modeling w/ Mike Rose

-More Product Announcements & Reviews

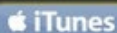

Our feed has changed! To get the latest shows, Please search Scotty Mason and subscribe to the new feed!

www.TheModelRailroadPodcast.com

Scott Mason Jimmy Simmons Mike Rose Joe Duckworth

ADVERTISEMENT



HO & N SCALE

HIAWATHAS

FINAL BOARDING CALL FOR MORE
CARS AND LOCOMOTIVES!
NOW AVAILABLE WITH SOUND!



RESERVE TODAY! www.foxvalleymodels.com

ADVERTISEMENT

NICK & NORA DESIGNS
Uniquely inspired craftsman kits



Craftsman Structure Kits,
Detail Parts, Shingles & More!
www.nickandnoradesigns.com



Nick & Nora Designs
a division of:
TMB Custom Models



MRHMAG.COM

- [TABLE OF CONTENTS](#)
- [INDEX](#)

Trainfest[®]
America's Largest Operating Model Railroad Show

— NEW —
**2 DAY
TICKETS**

AVAILABLE JULY 1

**56
CLINICS**

**JOIN
— THE —
FUN
— FIND THE —
ADVENTURE**

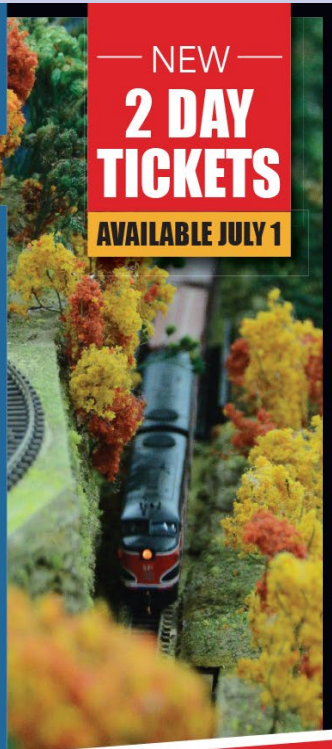
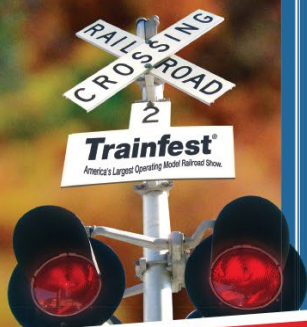

**Saturday & Sunday
Nov. 14 - 15, 2015**

**9:00am-
5:00pm**

**WI State
Fair Park**
Milwaukee (West Allis), WI

Sponsored by the Wisconsin Southeastern Division, Inc. of the National Model Railroad Association 

**DON'T MISS AN ORIGINAL ARTWORK OF
THE MILWAUKEE DEPOT AND THE C&NW**
Prints Available for Purchase

Ticket discounts and show details at
Trainfest.com



**Celebrating the Chicago &
North Western System**

This is the beginning of an exciting new tradition for Trainfest. Each year we will be celebrating a railroad through sharing memories and photos, partnering with historical societies, and modeling that road.

HAVE A MEMORY OF THE C&NW?

Did you work for the C&NW?

Did you ride the C&NW?

Submit your photos and stories to Trainfest at info@trainfest.com



MRHMAG.COM

- **TABLE OF CONTENTS**
- **INDEX**



MRH Q-A-T

column

compiled by
JOE BRUGGER



[Click here for
reader comments](#)

QUESTIONS AND ANSWERS

Operating a small layout

Q. When I built my small switching layout a few years ago it was just that, small. I have three industries on it and want to incorporate some sort of operations. I have looked at waybills but they seem to be overkill for me. I was thinking of making up a little list for me to go by.

Example:

- Deliver two empty hoppers to grain elevator
- Deliver three empty boxcars to grocery warehouse

—Jeremy

A. There are a lot of ways to get operations started, and a lot of useful posts on the MRH forums. Here's a summary, from simple to complex:

Graham: In the classic "Omaha system," each car has a small card with the car number and reporting marks printed at the

▶ **MRH QUESTIONS, ANSWERS, AND TIPS**

MRH Q-A-T | 2

top. All of the possible destinations for the car are listed in a column, and the car simply moves from one spot to another. It could be as simple as “Offline,” to “Swift Packing,” and back to “Offline.” When the car leaves a spot, draw a line through the old destination. It takes a while to set up and to fine-tune the frequency of moves, but there is no paperwork at all once that is done. Some operators use these cards with the three-box Set Out/Hold/Pick Up cycle.

rodor: One very simple approach can be found on my Kayton Shortline in the August 2014 MRH at mrhmag.com/magazine/mrh-2014-08-aug where I simply number each car spot and use small tags on each car.

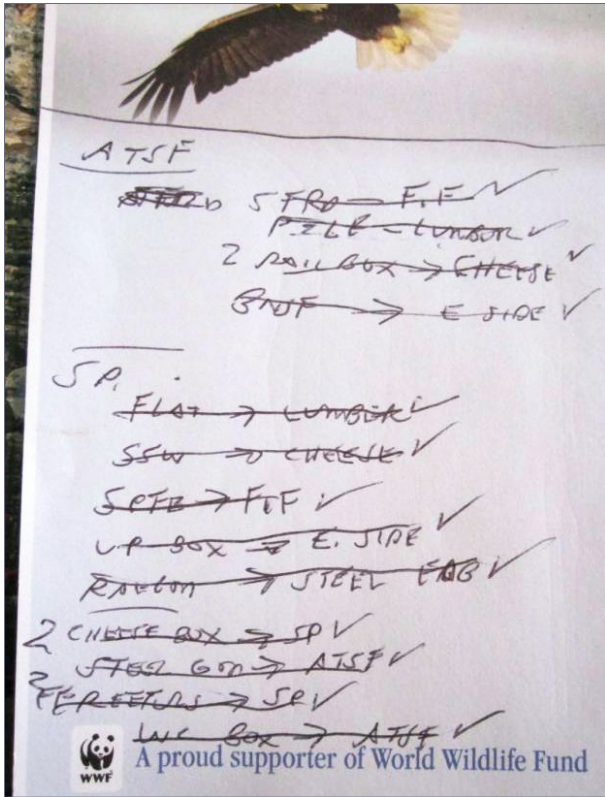

Since then I have expanded the railroad. For this I use simple two-position waybills. The trick is to have multiple sets of waybills, each slightly different,

1. Make a free switch list with a giveaway promotional pen and a notepad that came in the mail. *Dave Branum photo*

and swap them at the end of each op session. I've run 68 sessions using these with great success.

DaveB: Yeah, a switch list can be simple yet still show the work to be done. Here's one I used for an operating session on my N scale layout [1]. It has interchange with SP and ATSF so the list shows ATSF inbound as SFRD reefer to Frozen food, P&LE boxcar to lumber yard, two Railbox cars to Sargento Cheese, and a BNSF hopper to the eastside industrial area (not modeled).

The SP inbound are a bulkhead flat to the lumber yard, SSW boxcar to Cheese, SPFE reefer to USA Frozen Foods, UP boxcar to the eastside, and a Railgon to Steel Fabricators.

The outbound to be picked up are two boxcars at Cheese going to SP, the steel gon at Steel Fab goes to ATSF, two USA Frozen food reefers go to SP, and the WC boxcar from west side in the yard goes to ATSF. So, lots of operations with just a couple of minutes of list-making. As the moves are completed they get crossed off the list so nothing is forgotten.

Kevin: The good thing about going a little more complicated is that you can easily add variety. The evening goes from "deliver three empty boxcars ..." to "deliver cars xx, yy and zz." With a stack of waybills you can just grab a few and have your operating session ready, and completely different than the one you did yesterday.

"Mountain Goat" Greg: There is a discussion on random switch list generators at mrhmag.com/node/16262.

If you have a small fleet you could take a picture of each car, print it and place it on a 3 x 5 card. Shuffle the deck and draw a few cards to see which cars get spotted.

John Garaty: Low tech can provide simple solutions: three industries = three different colored dice. Before starting, roll a common six-sided die for each industry and see what you have to make happen.

How this might work:

- If 1, Industry is not worked
- If 2, Industry car is loaded – swap for loaded car for another car of same type
- If 3, Industry car is loaded – swap for a car of different type for different type of product
- If 4, priority load – remove car from industry and deliver to rest of “world” before shunting other industries. Replace with same type car.
- If 5, Industry on strike/vacation – remove car and leave spot empty
- If 6, Urgent raw materials delivery needed – remove whatever car is at industry and deliver a car of raw materials before switching rest of industries. When other industries have been switched, remove car that delivered the raw materials and re-spot the original car so loading can be completed.

Feel free to modify what is actually done for each number. Different industries will have different needs. With some of these operational wrinkles you will have to do some thinking before you start to move stuff.

With dice, there is no paperwork set up and no two shunting sessions will be alike. You have 216 different combinations possible, including triple-5 – “take everything away.” That just might keep you amused for a while

BARR CEO: Well, while most of you may be conditioned to think of dice as being numbered 1-6, as a gamer as well, I know dice come with many variations in size/numbering, such as 2, 3, 4, 5, 6, 7, 8, 9, 10, 12, 16, 20, 30, 50, and 100.

If you want to skew the odds in favor of certain results, use the high number dice (for example, a D12) and repeat results in your tables.

You can also roll them in pairs (or threes, or fours, or...), and add the numbers together – and assign the more common results to the higher probability pairs.

James McNab: Here is an excellent example of a simple switch list that looks more complicated than it is [2]. Like everything else on my layout, car forwarding is based on prototype practices. While the popular car-card and waybill systems would have given me the same outcome, individual paper waybills aren't appropriate for a modern era (post-2000) layout. Instead, the Grimes Line uses computer-generated yard reports.

The Iowa Interstate uses RMI/GE's TMS system for car tracking. This is the same system that my friend and fellow IAIS modeler Joe Atkinson based his RailQuik system on for his West End layout. Unlike Joe, I don't have to track multiple trains, interchanges, and offline destinations. Instead I only need to generate one form to handle one train.

Since the IAIS treats the entire Grimes Line no differently than a yard, a single yard report form is all that's needed for crews to work the line. The yard report lists the standing of every car, in order, on every track. From that form, train crews can determine which car to set out, pick up, or leave alone.

MRH Q-A-T | 6

Each track is listed in alphabetical order by town or area. Any cars on that track are then printed in the order they stand on the track, from timetable east to west. From left to right you're given the car's reporting marks, load status, blocking, switch instructions (such as spot at specific door), tonnage, car type, restrictions, and lading.

Moving down the form we see the flat car spotted at Chicago Bridge & Iron in Clive. Note that both the load status and commodity fields show empty, and the blocking is for the Norfolk Southern interchange in Des Moines. Crews know to pull the car and deliver it to the NS.



2. James McNab's IAIS Grimes Line yard reports look and function like prototype paperwork. *James McNab photo*

16 Awesome layouts!

Best layout tour series
ever produced

What TMTV video viewers are saying ...

"Can't leave these videos alone ..." - Bill R.

"Amazed at the quality ... dazzled!" - Pete V.

"First rate ... wonderful execution." - Dave B.

"Top notch ... keep it coming." - Daniel S.

"Watched the videos multiple times!" - Matt B.

"Feels like a network TV show ..." - Bill M.

"Interesting and engaging ..." - Scott T.

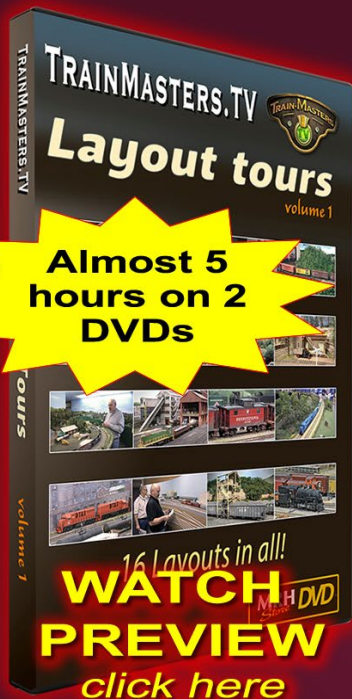

DVD media

\$27.77

~~\$39.99~~

+ shipping/handling

Instant Download

~~\$19.99~~ **\$14.77**

HD format

GET DVD SET NOW >>

GET DOWNLOAD NOW >>

Good broadband connection required!



from the
**Model Railroad
Hobbyist Store**

HobbyOn

Come & See Us
CLICK Here



www.hobby-on.com

**Name Brand
Hobby
Products
at Discount
Prices!**

MRHMAG.COM

MRH Q-A-T | 7

Back to the form, and at Millard Lumber. Again we have an empty car with block-ing to an interchange, this time the Canadian National (via the Indiana Harbor Belt) in Chicago. But since the crew of the “Tramp” doesn’t serve Chicago, they know to set out the car for pickup by the eastbound road freight at the Fleur Yard.

The yard reports aren’t that much of a change from car-card and waybill systems. It’s the same information, just presented in a different format. The combination of a simple layout, low car numbers, and a straightforward operating scheme means that even first-time visitors to my layout easily pick up on the method.

I use Robert Bowdidge’s SwitchList application for the Mac, at vasonabran.ch.com/railroad/switchlist.html. I’ve gotten to know Robert over the years, and was able to

- [TABLE OF CONTENTS](#)
- [INDEX](#)

MRH Q-A-T | 8

write a custom version of his program that generated the forms based on IAIS practices. It's a great app if you're running a small, switching style layout.

Larger layouts would benefit from Joe Atkinson's RailQuik for Microsoft Access. Go to mrhmag.com/node/17032. It's based on the TMS system that the prototype IAIS uses for car tracking and creates the same style of forms. Joe's application is free-ware, and he has written about it in his blog entries on MRH.

See James McNab's complete "Car Forwarding on the Grimes Line" post at mrhmag.com/node/17426.

Joe Atkinson: This is totally a personal preference thing, so I'm not trying to push my way of doing things on you. I think smaller layouts, or those like mine with very simple operations, really

Micro·Mark®

Berkeley Heights, New Jersey 07922

Summer
**TOOL
-A-
THON
SALE**
SAVE UP TO 75%

Now thru Sept. 10...
BIG SAVINGS
on Thousands of Items!

Click **HERE** to see
over 3,000 items!

SPECIAL BONUS OFFER!
\$5.95 SHIPPING on ANY order
over \$100 from this ad!

Offer applies to standard shipping to the 48 contiguous United States ONLY. Cannot be combined with any other offer. Pre-Order items excluded. Offer ends 9/10/15.

benefit from more prototypical operating methods. That's one of the reasons I developed RailQuik (mrhmag.com/node/17032), as it seems to give the layout more of a sense of purpose, feeling like merchandise, grain, etc. is actually being shipped and received. I believe that makes any layout feel larger than it really is.

RailQuik would likely be more involved than you might be after. However, some system that *tells you* what cars are inbound to your customers, rather than you just picking them at random, might give you a lot of enjoyment.

Randy: Joe Atkinson is exactly correct. Any system that tells you which cars need to go where is better than simply picking them at random, or even writing up a quick list yourself. It will totally change the feel of the op session.

Setting up JMRI Ops on my old small layout totally changed the entire vibe of operating it. It was way more prototypical feeling. I'd been moving cars on that layout using my own switch lists for years, but having the program generate the information changed everything. JMRI Ops would take very little time to set up for a small layout.

Look at jmri.sourceforge.net/help/en/package/jmri/jmrit/operations/Operations.shtml and ldopsigmeet.tulsanmra.org/resources/OperateRRwithSwitchlistsforFree.pdf.

Bob T.: This series of articles is a tutorial regarding using JMRI to create a switch list/manifest:

mrhmag.com/node/10834

mrhmag.com/node/10868

mrhmag.com/node/10989

mrhmag.com/node/11058

mrhmag.com/node/11211

The worked example is for a small layout, and demonstrates how you can add some intricacies to the operations with specific car spots. The product is a one-page switch list which you print and use for an operating session. You can add a train which moves cars from an interchange or yard to and from storage and bring various cars on and off the layout in a sequence. If nothing else, it is a fun project to try. I have a small single town layout with staging and find this method works great.

There is much more information in the original forum thread at mrhmag.com/node/22683.



TIPS

Hold-down device

It's not a bench dog normally used by a cabinet maker but is used in a similar fashion to hold down your delicate model or sub-assembly as you work on it. I own three of these puppies and find them indispensable while building models or soldering electronics. It simply holds down your work. Can be put in place or set aside in a split second. Doesn't damage the assembly but prevents it from moving around as you install the next component to the work piece.

It's real easy to build your tool. Grab an empty prescription bottle. Drill a 5/64" hole in the center of the top and bottom. Go easy with the drill so you don't crack the plastic. Cut a straight piece of



3. A prescription bottle, coat hanger wire, and gravel or lead make a handy hold-down tool. *Gilbert Lacroix photo*

dry cleaning coat hanger rod about 11 inches long. File one end to a point and remove any burrs off the other end. Thread the coat hanger through the bottom of the bottle with the pointy end first. Fill the bottle with weights. I used old tire weights and fine gravel. Close the lid on the bottle.

Make a bend at two inches from the pointy end. Bend the other end to make it a tee-shaped foot similar to an old-fashioned ironing board. The tee shape gives this gizmo two of the three points to rest on your work table without tipping over. The bottle shouldn't be touching the table top as the tool sits on all three points of the bent coat hanger.

Use it by resting the pointy tip in your work piece. The weights in the bottle are sufficient for the work piece to stay in place.

If you have two of the hold-down devices, one can be placed at each end of the work. Your two hands are free during use. The tool acts as a clamp for gluing parts to the work piece.

—Gilbert Lacroix, GLX Scale Models



**Click here for
reader comments**

.....
\$ GET PAID FOR YOUR TIP

We pay \$25 per tip we publish, or \$40 each if the tip also includes a photo or finished drawing. [Click here and select article type TIP.](#) ■
.....

ADVERTISEMENT



MRHMAG.COM

- [TABLE OF CONTENTS](#)
- [INDEX](#)



Complete Train Control



Digitrax No Worries Warranty

That's it! A simple, straightforward warranty with no tricky language



You're protected against

Learn

Need tech support?

www.digitrax.com/contact

Need a repair?

www.digitrax.com

**NO WORRIES
WARRANTY**

Now Keeps Your Layout Running!

**For one year
or more!**

**Protects against
defects and accidental damage.**

Learn more at: www.digitrax.com/noworries

www.digitrax.com/repair

Need a throttle conversion?

www.digitrax.com/upgrade

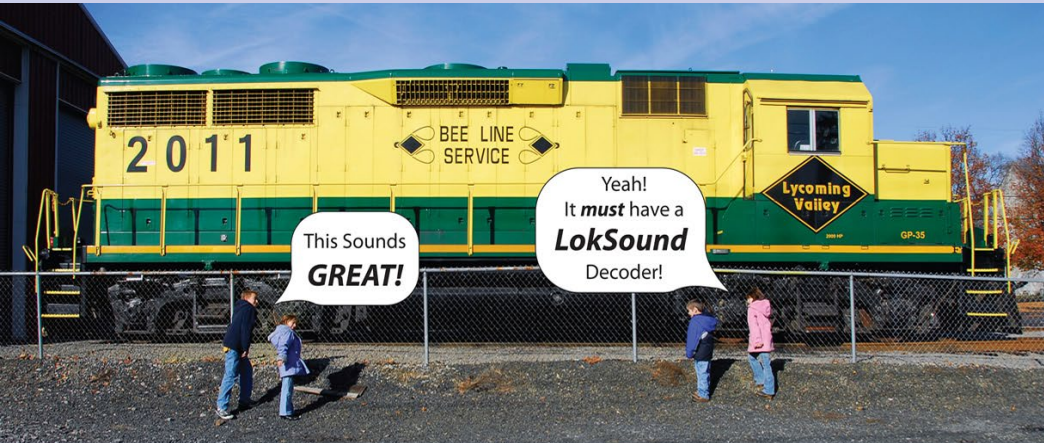

SO REAL...You'll Think You're There!

LokSound Select · 3 SIZES, ENDLESS POSSIBILITIES!

**INDUSTRY LEADING
MOTOR CONTROL**

- Multiple Bell types
- Multiple Brake squeals

**4 OR 8 Ohm
SPEAKERS!**

- 4 or 6 Output functions depending on the style
- Up to 4 Prime Movers or Steam Sounds on EACH decoder
- 16 Very Playable, LOUD Horns or Whistles depending on Profile
- All Changeable by using ONE CV! No Programmers or Boosters needed!*

**Small Size
BIG POWER! 1.1Amp!
LokSound Select
"4 AUX"**



\$99.99

NEW 2011

**LOK SOUND
SELECT**

Only Available From
ESU LLC (USA)

**ONE SIZE FITS ALL!
LokSound Select "DIRECT"**

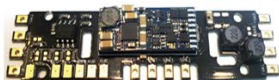

**6 Outputs!
LED Resistance
Built In!**

\$109.99

NEW 2011

**LOK SOUND
SELECT**

Only Available From
ESU LLC (USA)

**Tiny Size,
HUGE Versatility!
LokSound Select
"MICRO"**



\$99.99

NEW 2011

**LOK SOUND
SELECT**

Only Available From
ESU LLC (USA)

- Great NEW Size 1.18" x 0.61"
- Versatile DCC & DC "Dual Mode" decoder
- 8 channel sound system!
- FOUR lighting outputs and a 1.1A motor controller
- Available with ALL Current LokSound Select Sound Profiles
- Use 4, 8, or 16 Ohm Speakers

- Easy Drop in Design
- Versatile DCC & DC "Dual Mode" decoder!
- 8 channel sound system!
- SIX lighting outputs ALL with built in resistors for LEDs
- Available with ALL Current Diesel Sound Profiles
- Use 4, 8, or 16 Ohm Speakers

- Great NEW size ONLY 0.98" x .417"
- Versatile DCC & DC "Dual Mode" decoder!
- 8 channel sound system!
- FOUR lighting outputs and a .75A motor controller!
- Standard 8-pin NEM 652 plug included
- Available with ALL Current LokSound Select Sound Profiles
- Use 4, 8, or 16 Ohm Speakers!

* ESU LokProgrammer needed to "Replace" Sound and for Firmware updates, not for normal editing

www.LokSound.com • 477 Knopp Drive Muncy, PA • 570-649-5048

Now on facebook!



MRHMAG.COM

- **TABLE OF CONTENTS**
- **INDEX**



DCC IMPULSES

column

BRUCE PETRARCA
.....



[Click here for
reader comments](#)

GETTING STARTED IN DCC ...

I GOT A QUESTION IN A RECENT E-MAIL

about how to get started in DCC. This led me to go back and review the early columns that I wrote for MRH. They may have been a bit too detailed for beginners.

This column is to bridge that gap. It is aimed at folks who are not familiar with DCC, or are just starting out with DCC. Hopefully, there will be a tidbit here and there for the more experienced folks. Something for everybody is the goal. So, after reading this column, it might be a good time to work through all my columns, starting with the first: "Back to Basics" from October 2011 (mrh-mag.com/magazine/mrh-2011-10-oct/dcc_impulses).

This column will be the basis for clinics I'll be doing this year at upcoming NMRA conventions: the national convention in Portland, OR, in late August, 2015, and the Pacific Southwest Region convention in Scottsdale, AZ, in mid-September. I plan on a presentation based on topics raised here, and time for an open discussion with attendees. Plan to take one in.

► DCC TIPS, TRICKS, AND TECHNIQUES

DCC IMPULSES | 2

I'll talk a bit about my HO layout (MrDCCU.com/layouts/SMVRR) in this column, too. It is a small switching layout [1], currently under construction, that has been designed from the get-go for DCC.

Terminology

When folks are starting out on a new adventure, like DCC, they need to get a grasp on what specific words mean. A lot of that is covered in my May 2012 column, "Anatomy of a DCC System" (mrh-mag.com/magazine/mrh-2012-05-may/dcc_impulses). There is also a glossary on my web site (mrdccu.com/curriculum/glossary).



1. My HO Santa Maria Valley Layout. Benchwork in and working on the backdrop.

DCC IMPULSES | 3

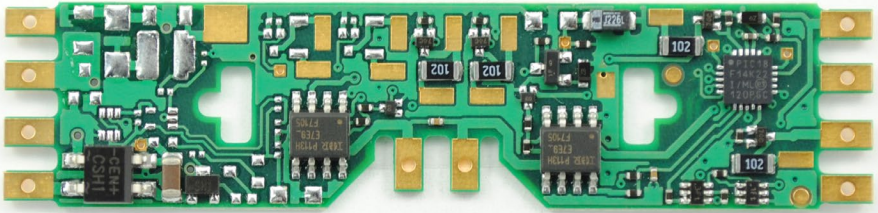

2. This DCC decoder, a SoundTraxx Tsunami TSU-AT1000, contains several chips. This model decoder is designed to replace the light board in Atlas and similar locos.

While I'm on the topic, I'll hit one term that is incorrectly used: chip. Chip is slang for an integrated circuit (IC). They are used in most of the electronics that make up a DCC system [2]. Folks incorrectly use "chip" to refer to the decoder that gets put inside a loco. "Chipping a loco" actually means breaking a piece off of it, not installing a decoder into it. Statements like this label the speaker as unaware of DCC or electronic parlance.

A spelling issue: "bus" is a term used in the computer world to refer to things that carry data, like the bus wiring from the DCC booster to the track [6]. "Buss" is a kiss.

The item that you use to control a locomotive is variably called a "throttle" or a "cab." I'll use the term "throttle" in this column.

ADVERTISEMENT

TamValleyDepot.com
Great Electronics for Great Model Railroads

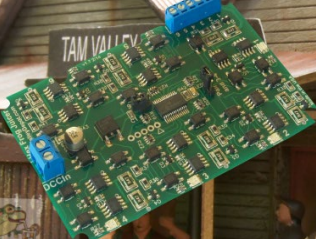

We are loading up the boxcars with Frog Juicers ready for your layout!

DCC IMPULSES | 4

Converting or building new?

The easiest time to plan for DCC is when one is contemplating a new layout. The wiring can be optimized for the DCC experience and there are no remnants from DC wiring, like undersized block selector switches or tiny bus wires.

If you have a DC layout that you wish to convert, there may or may not be a lot of work ahead of you. If you have fairly robust wiring, you may be able to use it for DCC. In a recent on-line discussion, a modeler wanted to convert a DC dual-loop layout to DCC. His layout was well enough wired that all he needed to do was install a DCC system and two circuit breakers, one feeding each loop using his existing wiring. See the section on the “quarter test,” below.

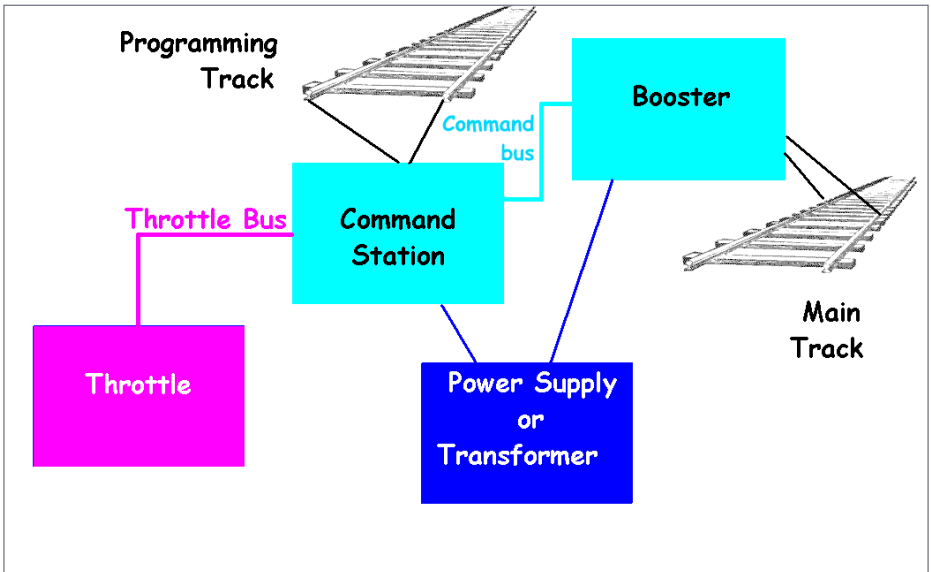

3. Functional block diagram of a DCC system. Many systems combine the functions of two, or more, of these blocks in one box.

DCC IMPULSES | 5

Even the most meticulously wired DC layouts may not be directly convertible to DCC. I was a member of a club that had spent lots of time and money on a DC rewire before they decided to convert to DCC. Their DCC layout didn't work as well as they hoped until they ripped out all the DC wiring and started over. They had many issues: tracks wired into two (or more) different districts, inadequate drops and general confusion under the layout. After several months of rework, the new "DCC designed" wiring is working fabulously and the members are less frustrated.

Mixing DC and DCC

Running both DC and DCC on the same layout at the same time is a very expensive accident waiting to happen. If the two ever get joined, by wheels bridging blocks or a tool touching both tracks, there is a high probability that it will be fatal to some or all of the DCC decoders on the layout. Also in danger would be the DCC booster, any circuit breakers installed and, perhaps even the DC power pack.

If you must run both, use a connector or a double-pole, double-throw (DPDT) switch to firmly and completely switch the entire layout at once.

That said, experience shows that once folks have fun with DCC they tend not to revert to DC. One local club switched their HO-scale standard gauge layout to DCC, while leaving the separate narrow gauge section DC. They more than doubled the participation in their operations sessions once the DCC was installed. After a year of not one train running on the HOn3, they converted it to DCC and saw a rebirth of interest there, partially fueled by the Blackstone HOn3 products.

Planning for DCC

To build a layout, it's not a good idea to just go out and buy some track and just start gluing or nailing it down. Planning is always helpful. The same holds true with DCC.

From the DCC design standpoint consider:

- Layout scale, which affects track voltage.
- The final size of the layout, which affects wire size and the number of boosters needed.
- The number of operators on the layout, which affects the number of throttles needed and the location, size and quantity of power districts.
- The number of decoders and other devices drawing power at one time, which will affect the number of amps of DCC power the system must supply.

ADVERTISEMENT

Servo control with a touch

- Elegant Touch Toggle™ controls
- All plug-in system
- Super easy setup
- RC servo motor power

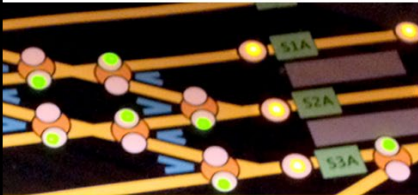

Now Touch Toggles for
Tam Valley and MRservo!

Servos, Stall Motors
Twin-coils, or Relays

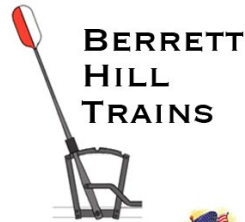

Made in the USA



What will they think of next?

www.berrethillshop.com

DCC IMPULSES | 7

- Your plans for advanced features, such as radio control or a computer interface, which will affect the choice of DCC system.
- It is always good to be able to reverse a train or, at least a loco, so a loop or wye or turntable can be helpful. The track plan and DCC plan must be coordinated for best results in a reversing section.

Wiring differences between DC and DCC

DC wiring, even on the most elaborate layouts, is designed around the ability of power packs to withstand shorting. Power packs don't need to handle large amounts of power (amps) as they are usually only powering one or two locos at a time. This frequently results in DC layouts using small gauge wires and miniature switches, which are inadequate for DCC.

ADVERTISEMENT



Econami™

NEW! Econami Digital
Sound Decoders

**Now the Biggest Name in Sound
is Also the Biggest Name in Value!**

- High-quality 16-bit sound and full features starting at \$79.95 MSRP
- Easy-fit formats for N-G scales
- Sounds for Steam, Diesel, and Electric

Hear More!

SOUNDTRAXX®

MRHMAG.COM

- [TABLE OF CONTENTS](#)
- [INDEX](#)

DCC IMPULSES | 8

The DCC booster cannot stand to operate into a short for more than a fraction of a second. Thus, they all have self-protecting circuits designed to detect a short and shut off the power until the short is removed. The trick is for the system to understand the difference between a high-current draw loco and a short circuit. Thus, DCC bus wiring needs to be much more robust than most modelers are expecting. For more information about “DCC Layout Wiring,” check out my December 2011 column (mrhmag.com/magazine/mrh-2011-12-dec/dcc_impulses).

The feeders that connect the DCC power bus and the track, if kept short (2 feet maximum), are frequently made the size that folks expect to use to wire an entire DC layout. Use table [4] to size the bus and feeder wires for your layout.

AWG gauge	Maximum Length feet
12	50
14	31.45
16	19.77
18	12.44
20	7.82
22	4.92
24	3.09

The “quarter test”

This is a way of making sure that your DCC wiring is correctly designed and installed for the booster to detect a short. The name comes from a great way to test a layout with track Sn3-gauge and narrower. Simply, it consists of putting a quarter across the rails and observing if the booster shuts down. I’m referring to the U.S. quarter-dollar coin. High con-

4. AWG vs length of DCC run.

TONY'S TRAIN XCHANGE

Committed to your DCC support!

Broadway Limited
HO Scale
EMD E Units



With Paragon2 Sound & DCC, Near brass-caliber detail at a plastic price, Authentic EMD E-Unit sounds in DC and DCC

Starting at \$179.95

Order Yours

Broadway Limited
HO PRR
M1a & M1b 4-8-2



Featuring the new Paragon3 Sound System that operates in both DC and DCC

\$329.95

Order Yours

CMX Cleaner Car

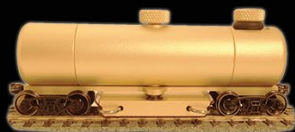

Superior, All-Brass Build Quality, Super Easy To Use & Cleans Exceptionally Well!

N, HO, S, O, & G Scales

Starting at \$144.95

Order Yours

Do you need a Sound or DCC Installation done?

Get a quote!

**TONY'S
TRAIN
XCHANGE**
DCC SPECIALISTS

Providing unmatched person to person DCC support for more than 25 years, the kind of service that has made us #1 in DCC.

DCC questions? CALL US! 1-800-978-3472

*Mention this ad for \$5.00 off your next order over \$100!

We'll get you on the right track!

Aug 2015



MRHMAG.COM

- TABLE OF CONTENTS
- INDEX

DCC IMPULSES | 9

ductivity coins from other countries can be used as well, if they can bridge both rails.

The “observing” becomes the critical issue. With a booster, such as most Digitrax units, or a circuit breaker that beeps on a short, observing is trivial – listen for the beep. For boosters that don’t beep, like the Digitrax Zephyr, or Lenz or MRC or NCE, I like to put a bulb across the track and see if it goes out when the quarter is applied. An automotive test bulb is a good choice [5].

Larger scale track can be tested, too. A larger coin, or similar object, is required. I use a bit of track as a short on my garden layout.

Buses needed

There are three sets of communication buses that may be needed on a DCC layout. See figures [6], [7] and [8].

So they may make more sense to newbies, I choose to picture these two data buses, [7] and [8], with the NCE Power House 10-amp system, as the various components are in separate boxes.

Many boosters need specific low levels of input data, called a control bus [8]. Some are designed to be hooked directly to a



5. Applying the quarter test to HO track. The light goes out showing that the booster or circuit breaker sensed the short and shut down when the quarter bridges the rails.

DCC IMPULSES | 10

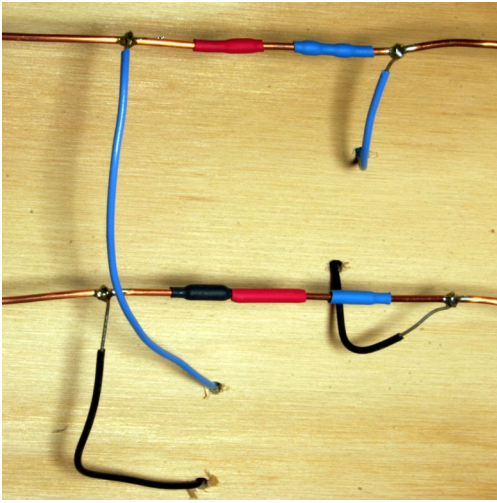

6. The DCC bus (or track-bus or booster-bus or district-bus). This is relatively large gauge wire (frequently 12 AWG or 2 mm) that runs around under the layout. Shown here is a 14 AWG district bus connected to some 20 AWG feeders. The buses are color coded. This is the blue district off the red booster. The black denotes the common side of the track signal.

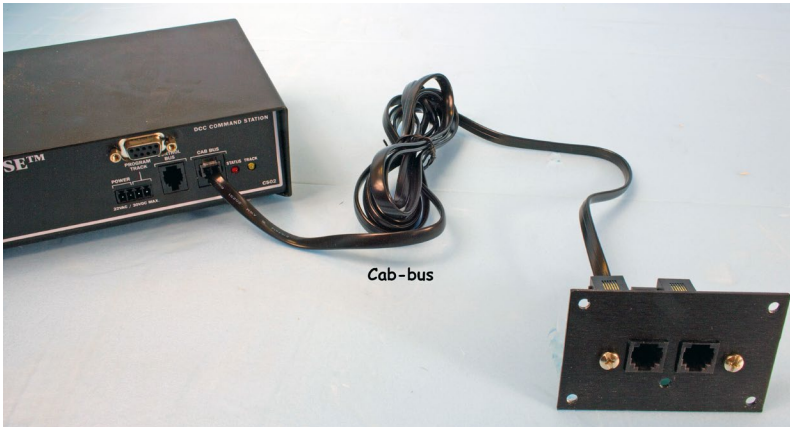

7. The cab bus (NCE term) connects throttles to the command station. Digitrax uses its proprietary LocoNet to combine both cab bus and control bus functions. This photo shows the Universal Throttle Panel (UTP) connected to the Cab Bus connector on the NCE CS02 command station. The second connector on the rear of the UTP may be used to connect additional panels in a daisy-chain fashion.

DCC IMPULSES | 11



8. The control bus connects the command station to the booster(s) on the layout. Here is the control bus between the command station box (right) and the booster box (left) in an NCE 10 amp system designed for garden layouts.

track bus, thus they don't need a control bus running around the layout. An example of the latter is the Tam Valley Depot booster. Figure [9] shows how I'm using this booster on my HO layout.

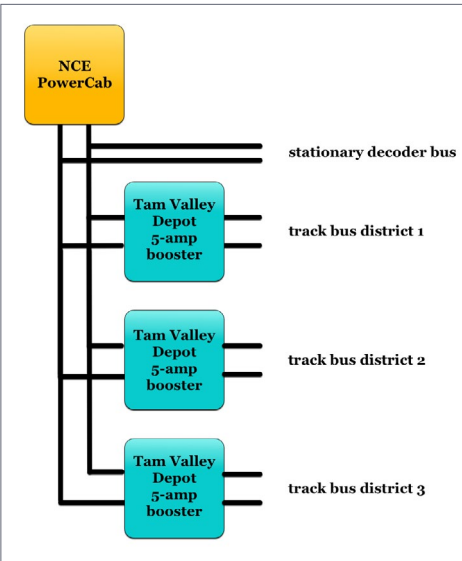

9. Bus structure on my HO SMVRR layout. NCE Power Cab drives the input to three Tam Valley Depot 5-amp boosters, one for each district. Stationary decoders will be connected directly to the Power Cab. If the draw on the stationary decoder bus becomes too large, another Tam Valley booster can be added there. Each booster provides power for its district while also providing circuit protection.



1st choice for model railway supplies and service.

Expedited mail service available across North America.

Click to visit:
WWW.CVRCO.COM
1 800 464 1730



Did you see this MRH video?



MicroEngineering Track laying tips ...

Watch the video now

Selecting a system

About 15 years ago, I started Litchfield Station as a DCC specialty shop. Since then, I have frequently been asked, “What is the best DCC system?”

My response has always been, “DCC systems are like life partners. They all have good points and they all have limitations. You need to find what fits your needs without too many things that you don’t like.”

Items to consider are:

Upgradability: Can the system you select grow with your hobby interests? More power, more throttles, radio connection and computer control are areas to analyze. Also, will what you start with be usable in your version of the final layout, or will you have to discard or sell some parts?



10. Digitrax Zephyr Xtra desk-top basic DCC system.

Do you have local support? Are there other users or clubs near you that use the system you are considering and are they available to help you? What about a local DCC-savvy dealer?

Hand-held vs. bench-top: While most basic DCC systems use hand-held throttles, some use a bench-top box with the speed and function controls on them. The Digitrax Zephyr Xtra [10] is an example of this sort of system. Frequently desk-top systems have limited usage as your pike grows. On the other hand, I had a customer use four Zephyrs to run his Sn3 layout, giving him four throttles and four boosters.

Ergonomics: How well does the throttle fit your hand and how easy is it for you to use and to see? Try all varieties of throttle for the system you are considering. For example, if you are thinking of starting with the Digitrax Zephyr, try the UT4 and

ADVERTISEMENT

END OF TRAIN DEVICE

FLASH CIRCUIT
UNDER TRUCK

TRACK
POWERED



READY TO RUN!



**Bright Red
Flashing Light!**

Installs in minutes
with no freight car
modification required!

RE RING
ENGINEERING

Patented Technology - US Patent 7,549,609

Does not affect Load!

↓ Car without Load ↓

↓ Car with Load ↓



For video
and more
click here!

DCC IMPULSES | 14

DT402 throttles, as they are the present upgrade route for the Zephyr system.

Get some “seat time” with throttles that you are considering. Learn how easy is it to perform basic actions using throttles for the system you have under consideration, such as:

- Select engine or consist
- Start, accelerate, brake and stop the train
- End your session with the loco, (“Dispatch” in Digitrax parlance)
- Build, alter, and clear consists
- Reverse direction of your consist -- many folks think NCE excels here
- Program CVs in the loco (to set its personality)
- Access a function higher than 6 or 12 or 20

ADVERTISEMENT

RailPro™
NEW TECHNOLOGY
DIRECT™
RADIO

RE RING™
ENGINEERING

NEW Starter Kit
\$399.99 MSRP

- Includes Wireless Color Touch Screen Handheld Controller and 56 Watt Power Supply
- Expandable to Virtually any Size Layout

NEW Locomotive Module
LM-2 & LM-2S

- Direct Radio RF
- Sound and Non-Sound
- New Tiny Size
- 6 Light Outputs

Click Here to Learn More

For more information visit our Internet site: www.RingEngineering.com

MRHMAG.COM

- [TABLE OF CONTENTS](#)
- [INDEX](#)

DCC IMPULSES | 15

Features: Does the system you are considering read out the track current being drawn? Does it need a programming track booster to read back what has been programmed in sound decoders? Does it read back any decoders?

Don't buy a system too soon. DCC products are basically a computer system. Like computers they get better and less expensive with time. For example, in 2000, a good non-sound four-function decoder was about \$60. Today, in a smaller package, you can get a decoder with better motor control and more lighting and control features for about \$20. I frequently hear about folks who bought systems when they started planning their layout and have to do a major update or completely replace their system when they finish their layout. Wait until you need something to buy it. Technology marches on.

ADVERTISEMENT

Make LocoNet wiring extremely simple!

ACCU-LITES, inc

Your DCC Center!

Dealer Inquiries Accepted

CELEBRATING
20
YEARS
ANNIVERSARY

PM42
breakout
board



BDL168
Multi-zone
breakout board



SE8C
breakout
board



BDL168
Single-zone
breakout board



Now Offering SNAPS! in packs of 6 or 12 pieces! [CLICK TO LEARN MORE ...](#)

MRHMAG.COM

- [TABLE OF CONTENTS](#)
- [INDEX](#)

Find a DCC dealer

I believe in supporting the dealer that supports you. The support they supply may range from e-mails to phone calls to in-person discussions. Many brick-and-mortar hobby shops have few or no DCC savvy folks, even though they may sell DCC equipment.

Find one that works with you and helps you and buy from them. Avoid the temptation to buy from someone else because they are a few pennies less expensive. If you are lucky enough to have a local shop that can help, patronize them. You may pay some sales tax but you probably won't pay shipping costs and you'll have local support.

How much power – volts and amps?

Different scales frequently require different track voltages. Many systems make it easy to change track voltage settings in a range between 12 and 18 volts. Some ardent Z scale folks want to go as low as 10 volts, while many garden railroaders push over 20 volts. Don't worry about tenths of a volt. Just get within one volt and you'll be fine.

Decide on a track voltage for your layout and make sure the system(s) you consider can support it. The Digitrax 5- and 8-amp systems have a track voltage setting of N (12), HO (15) and O/G (18) volts. These settings represent a good

ADVERTISEMENT

**IOWA SCALED
ENGINEERING**

Infrared
sensors!



LEARN MORE >



Southern Digital



**20% Discount
on most items!**

Specializing in DCC Since 1992



DCC Conversions, Service & Support

Orders Received by 3:00 pm EST ship the same day

WWW.SODIGI.COM

E-mail: sales@sodigi.com

(770) 929-1888

(Photo's are from our N-Scale layout)

DCC IMPULSES | 17

starting place for selecting your own track voltage. Many HO-scale layouts use the Digitrax N-scale setting. Locomotives will run a bit slower, which is usually good, and bulbs tend to last longer. The N-scale setting is close enough to the fixed voltage from the NCE PowerCab of 13 volts to be compatible.

Unsure about track voltage? Ask your friends. Remember, if you set the performance of your loco at 15 volts and then run them at 12 volts, they will run slower and may not be as responsive as you planned for. If you are planning on moving locos from home to the club and back, it is a good idea to adopt the club track voltage settings for your home layout.

Lots of things go into figuring the current your layout will need. Avoid the temptation to buy the biggest, baddest booster you can find for your HO- or N-scale layout. Leave those brutes for the larger scales. See my March 2014 column “A Dozen DCC Myths” (mrhmag.com/magazine/mrh-2014-03-mar/di_myths-of-dcc) for a discussion of this idea and a revealing video about possible damage to your loco wiring.

One of the surest signs that you need more power (amps) is that your system keeps shutting down.



11. RRampMeter by DCC Specialties.



12. NCE Power Pro five-amp DCC system. The control bus goes between one of the sockets on the left (booster) and the socket on the right (command station). The other left socket can be used to connect the control bus to other boosters.

The best way to measure track voltage and current is with a piece of test equipment that is specifically designed for DCC. The RRampMeter [11] is sold by most DCC dealers and can show you track voltage and current directly. In a pinch, a multimeter set on the AC scale can show you relative voltages but cannot be relied upon for accurate and precise readings.

Five-amp systems [12] are the backbone of DCC for many reasons.

- A five-amp system can operate a reasonable number of trains moving at one time, perhaps even a dozen modern locos in HO or N scale.
- Limiting the length of track bus runs helps keep the wire size to a reasonable level. A five-amp system balances well with DCC bus lengths of 12 AWG wire.

DCC IMPULSES | 19

- The instantaneous short circuit current from a five-amp system is consistent with the wiring found inside HO or N scale locos.

If you need more than five amps for your entire pike, all you need to do is add another booster, or more. Planning the power districts of your layout to accommodate this may help later.

Power districts

On my Santa Maria Valley layout, I'm planning three districts, even though I don't expect more than two, or possibly, three locos to be active at any time. Rather than using circuit breakers, each district will be driven off the very small and inexpensive five-amp booster boards from Tam Valley Depot. Figure [9] shows how this will all connect. These boosters [14] are only slightly more expensive than the PSX [13] circuit breakers. Using them eliminates a more expensive system box (command

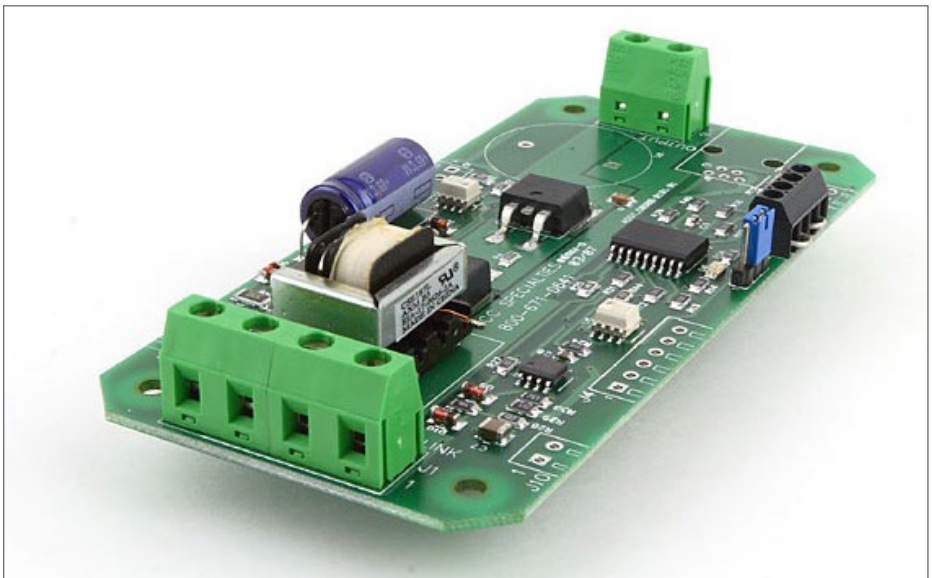

13. PSX circuit breaker from DCC Specialties.

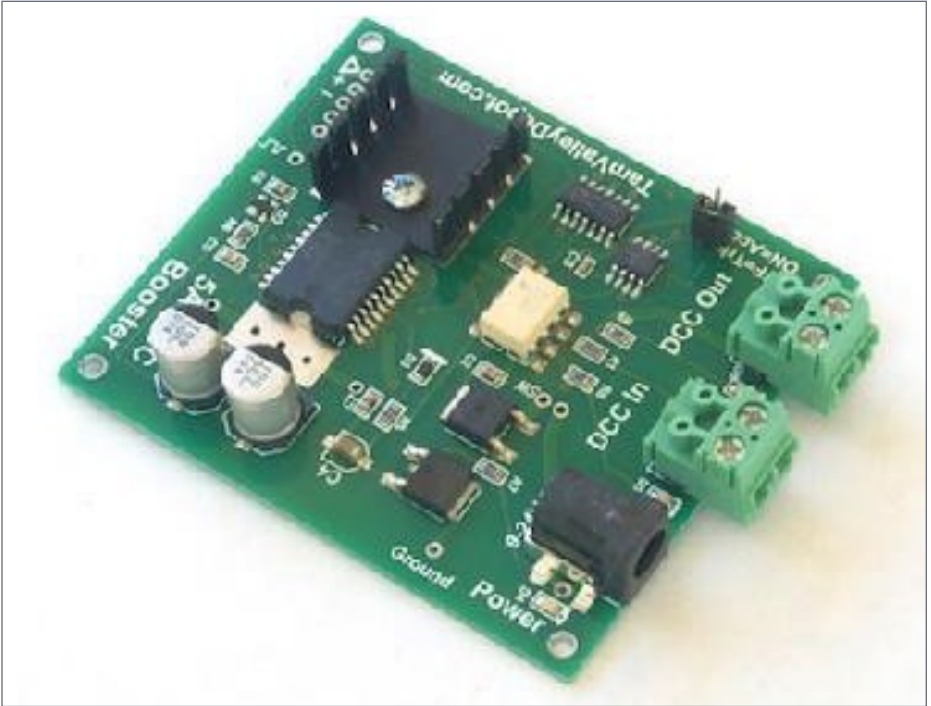

14. Tam Valley Depot 5-amp boosters, as I'm using on my layout, see [1]. and [9].

station and booster combined) and power supply. These three boosters are more economical for me.

If you want to use stationary decoders - see my June 2015 column "DCC Stationary Decoders" (mrhmag.com/magazine/mrh-2015-06-jun/di_dcc-stationary-decoders). I recommend connecting them directly to a booster [9].

The reversing situation

Whether it is a loop or a wye, a DCC reversing section needs to be designed from both a track plan and DCC system viewpoint. I'll refer to them as loops.

DCC IMPULSES | 21

Many loops are obvious, such as a teardrop. Others are subtle, like a mainline crossover on a dog-bone style layout.

The key point is that the reversing section must be longer than the longest train you will run through it. Thus, it is good if you design the track plan and the DCC plan together.

For more detailed information, see my “DCC Reversing Loops” column from January 2015 (mrhmag.com/magazine/mrh-2015-01-jan/di_dcc-reversing-loops).

There was lots of fun stuff to cover this month and lots of references to outside data. Folks always seem to have additional ideas to share. Just click on the Reader Feedback icon at the beginning or the end of the column. While you are there, I encourage you to rate the column. “Awesome” is always appreciated. Thanks.

Until next month, I wish you green boards in all your endeavors. ☑



**Click here for
reader comments**

ADVERTISEMENT



Installing DCC sound just **NOT** your thing?
Trust Traintek for sales and installation of sound decoders from these fine vendors!



RailPro™

“Taking model railroad control to the next level...”



traintekllc.com  “Traintek was the way to go!” 

Click here for more details...



**FUN
FUN
FUN**

In the Summer!



S T A T I O N

623-298-7355 • www.Mr-DCC.com

www.LitchfieldStation.com

From first train set to railroad empire...

*Our complete line of DCC products
grows with you. Discover the fun!*

- Designed and manufactured in the U.S.A.
- Preferred for ease of use and ergonomic design
- Unlimited scalability for any size model railroad
- Plug-and-play means more time running trains
- Great customer service and excellent support



See your dealer



Visit our new and improved web site for all your DCC needs!

- Get the latest new product announcements
- Watch our detailed how-to videos
- Browse the all-new Information Station
- Enjoy secure online sales, day or night!

Visit **ncedcc.com**



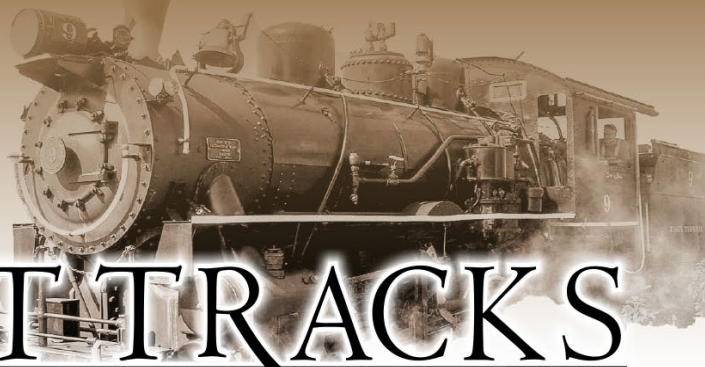

FAST TRACKS

YOUR VERY OWN TRACK FACTORY

Make the most of your modeling experience.

Build perfect trackwork easily and inexpensively when YOU want it!



★ ★ ★ ★ ★
Check out our extensive (and growing!) online video library to learn how easy it is to hand lay your own trackwork with Fast Tracks tools and supplies.

Play Video ▶



shop online 24/7

1-888-252-3895

handlaidtrack.com

service@fast-tracks.net

MRHMAG.COM

- [TABLE OF CONTENTS](#)
- [INDEX](#)

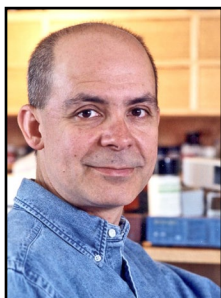

MIKE ROSE
.....

GETTING REAL

column



[Click here for
reader comments](#)

FINISHING AN ENTIRE AISLE OF LAYOUT PART 2 | MIKE ROSE WORKS ON FIVE BUILDINGS AT ONCE

SOMETIMES WHEN ONE CONSIDERS THE

arc of a project, it's important to keep the starting point in mind. The future big Masonite plant at Towanda (on the prototype it's actually in the neighboring town of Wysox) was represented for a very long time by a big ugly cardboard box. It was so ugly, in fact, that I had a very hard time finding a photo of it! Since it was so non-photogenic nobody, including myself, ever took pictures of it!

I hope Mike Confalone will forgive me for this one, but this is a shot of him switching in Towanda [1] during an op session in May of 2014. That puzzled look of consternation is what happens when you hand a Digitrax guy a full-featured NCE throttle! Almost dead center, behind the cars and cardboard cylinders, is what passed for the Masonite plant until the efforts of first quarter this year. After I had gotten Towanda Yard under

► [MODELING REAL RAILROADS AND WHAT THEY DO](#)

Grand Trunk?

CLICK TO KNOW MORE

**Grand Trunk
Railroad, is just
one example of our
extensive stable of
road names. If the
railroad existed, I'll
bet we have a decal
set for it.**

**You build it
and we supply
Graphics.**



**Proudly made in the U.S.A.
Since 1933**



www.microscale.com

**GETTING REAL | 2**

control and Masonite Road in place, that big ugly box was just not making the grade. I figured that since I was ahead of schedule, I'd take a stab at the actual structure.

The following is how I worked on five buildings at once! Why, you ask? Well, I consider most kits to be kitbash fodder. Rarely, if ever, do I build a building as the manufacturer intended. I often completely ignore the instructions and always have parts left over. I tend to want to represent particular prototypes, not what the kit manufacturers are offering.

Still, they provide a very valuable service to me. When you buy a kit, you get all the doors, windows, glass, and detail parts that would have to be scrounged up if you were using general scratchbuilding material. So the kits by Walthers, Pikestuff, etc. are gold to me, just for those reasons.

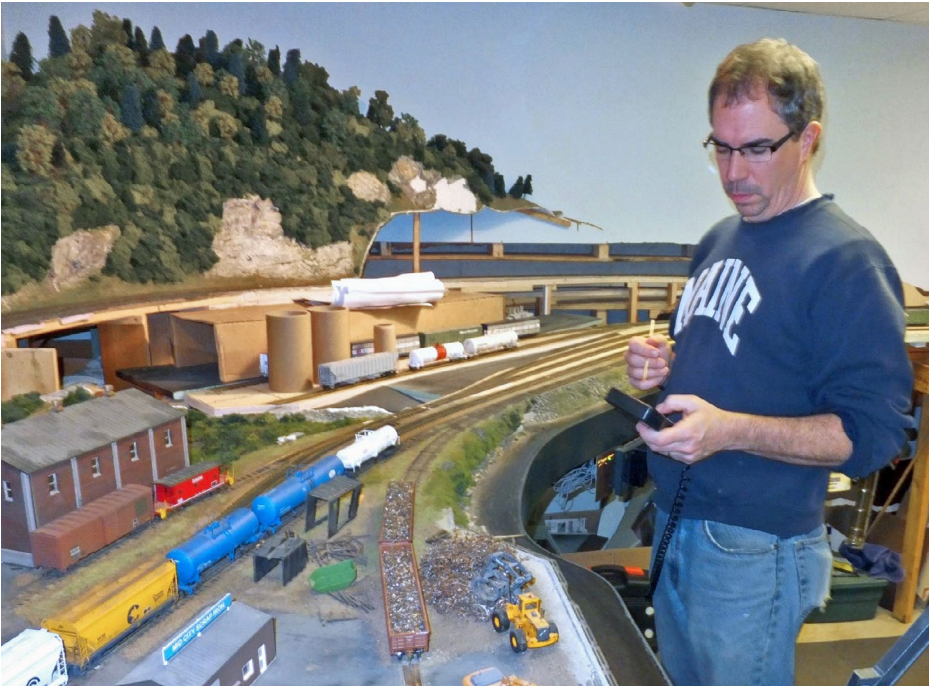

1. Digitrax user Mike Confalone learns the mysteries of NCE throttles while working Towanda.

My big Procter & Gamble plant in Mehoopany (Spring 2012 MRH) was built using much of the Walthers Paper Mill kit, but bears no resemblance to it. It was to be the same way with this group of structures:

1. Masonite
2. Osram Sylvania (building segment)
3. Agway Fertilizer Mixing Plant, Wysox
4. Purina Feed Mill, Wyalusing
5. Purina Feed Mill shed building, Wyalusing

GETTING REAL | 4

I had “x” amount of raw material on hand, including several Pikestuff kits, the big Walthers Corn Syrup facility, all the left-overs from other kitbashing projects, and raw materials. I was determined to build all of these structures and not buy anything new, since it was all there anyway.

All I had to do was figure out what to use where. This proved harder than I thought, in part because I’d done so much scenery on the layout that I was out of flat places to work! I addressed this problem by taking one of my roll-around A-Line box storage carts, and putting a plywood top on it as a portable work surface. Every one of the following structures was largely assembled on this platform.

I wanted to avoid the scenario in which you take tall walls and cut them down to make building “X,” only to realize that building “Y” needs tall walls! To avoid this, I laid out each kit’s contents along with the prototype pictures, and began to try and visualize and allocate which pieces would be used where.

I began the process by attempting to mock-up the Masonite plant [2]. I had a fairly constrained spot (don’t we always?) and really needed to do selective compression since I’d have needed an entire peninsula to do this industry full justice.

At Mehoopany, the P&G plant warrants that degree of footprint due to all the rail activity there, but Masonite has just two sidings, and one is inside. I wanted it to hold at least four Thrall-door boxcars inside, so that largely determined the length. It needed to fit lengthwise in the designated spot, but not look “too shallow,” a difficult trick to pull off. Here I’m using parts of the Walthers Corn Syrup kit for the truck and rail loading doors to see how that looked, as well as Pikestuff walls taped to a strip of wood to get the heights to match. At the time I was considering having a high foundation there.



2. Panels from Pikestuff and Walthers are mocked up on the layout site before the Masonite building construction starts.

I started by cutting a nice thick styrene base for the “slab,” removing a slot for the track so that it would be at the right height inside. This view shows the almost total lack of space behind the building, as well as the spot on the left where the yellow loader is, that would have to somehow serve as the giant sawdust pile area [3].

The entire building core is made of sheet styrene. I purchased 4x8 sheets of this material when I did P&G and the remnants were paying dividends for this particular structure. I assembled the building using standard styrene techniques, with plenty of blocks and squares to keep everything plumb. Underneath my rolling “workbench” is the aforementioned



3. The Masonite factory site mandated a long, narrow building against a hillside – common on model railroads but hard to make convincing



4. A rolling equipment cart was the only flat space available to assemble the factory/warehouse building.



5. Here's the basic box of the structure in place, with a cut of cars to test the clearances.

storage cart [4]. I never even took the A-Line boxes out of it. At least I know where my autoracks are!

Ambroid Pro Weld is the perfect styrene bonding agent for me. It's fast enough but not too fast, and it stays in the bottle, unlike some other cements. The beveled wood block is my solution to something that happens to

ADVERTISEMENT

**F59PH Kit in
HO Scale**

Available Aug. 15



GETTING REAL | 8

everybody sooner or later: you tip the bottle over and melt half the stuff on your work surface.

Grrrrrr ... not anymore. Whoever designs these bottles needs a stern talking-to by yours truly. At least Testors got the bottle right.

Once the core box is assembled, fixes are easy but get progressively harder as the building progresses. It's wise to check for size, clearances and squareness early. Fortunately everything was right on [5].



I used a triangle to mark the interior partition locations for the necessary internal supports of the structure [6]. All structures, both wooden and styrene, require robust internal bracing to avoid warping. The bigger the structure, the more important that is. Sharp eyes will note that on my laptop in the distance the calculator is

6. Using a triangle to line up internal supports.

on the screen. No doubt I was using it to help with some of the dimensional figuring!

With the basic interior bracing installed, all we need to do is plank down a big rectangle for the roof and the basic structure is roughed in [9]. Note that additional strips are added along the walls to support the roof between the partitions. I was considering stopping here, but I had a couple of more weeks, so ...

I'd never built anything like Osram Sylvania before. Some of you may have noticed that a rectangular section of the fascia at Towanda

7. I used Ambroid Pro Weld to bond the interior bracing partitions in place. Scribe, snap and bond construction like this with styrene proceeds extremely rapidly, a big help with large structures.



GETTING REAL | 10

projects above the rest. Jim Lincoln suggested some time ago that I model Osram Sylvania as having most of it off-layout, in this case in the aisle, and just building a portion of it where it faced the tracks [10].

Using the easily recognizable Pikestuff wall and roof modules, I could quickly toss this structure together. In fact, the Pikestuff roof pieces turned out to be exactly right for the building dimensions I needed. Again, note the plethora of interior braces

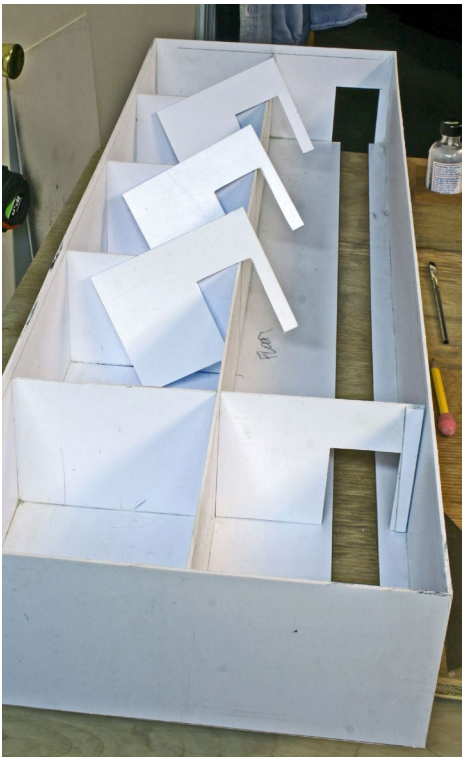

8. A long center divider makes the building more rigid. I cut out cross-bracing with room for the freight cars to pass through.



9. The internal braces and strips along the walls support the large flat roof.

GETTING REAL | 11

and the longitudinal one made out of a piece of styrene from the scrap box, hence the odd shape!



10. Osram Sylvania is between the spur track and the aisle, with most of the structure “off-layout.”



11. Spring clamps hold a stiffening panel to the fascia while the glue sets.

GETTING REAL | 12

Next I glued a stiffener to the back of the extended fascia, since I didn't want it to warp [11].

I painted the building a different color to take away the usual Pikestuff look. Little details like each doorway having a concrete stoop, and the sign (made from a photo I took of their street level sign), plus the fact that it's properly planted into the ground with a foundation make it believable. It's not supposed to be a signature structure, just to blend in and look "right." But wait, isn't that the Masonite building in the distance? It looks quite different from that ghostly white structure we last saw!



12. Notice (at left) how the fascia rises up to form a wall of the Osram Sylvania building. In this shot it does not yet have a foundation, the doors have not been painted, and the dirt has not been brought up to it. Compare this look with [13].

WOW!

Premier Scale Trees



Many species of
Conifer trees available!



Click for
more -
lots more!

Also see our other
conifer offerings ...



13. The only way to get this view is to be IN the yard! Here's the completed Osram Sylvania building.



GETTING REAL | 15

Back to Masonite. Here I'm allocating wall modules from the Walthers Corn Syrup kit, to be cut down and used as siding here [14]. Note the taped together Pikestuff wall sections being considered for the penthouse roof structure. The spotted cars and trucks help to give me a sense of proportion.

Meanwhile, at the other end of the aisle, I allocated other walls from the Corn Syrup kit for the Agway Fertilizer Mixing building. The current look of that facility is shown in the prototype picture I was using to visualize it. Again, some compression was needed but it was vital to capture the important elements [15].

At the same time, in Wyalusing, I was trying to figure out the best way to build the shed building there [16]. I decided to split one of the Corn Syrup buildings lengthwise, use a blank styrene back wall since you can't see it, throw on a Pikestuff roof section and garage doors and off we go!



14. The Walthers Corn Syrup kit supplies siding for the bare styrene Masonite factory.

GETTING REAL | 16



15. Prototype photos helped in “inventing” a believable Agway building.



16. Walthers' Corn Syrup wall panels and plain styrene make up this shed in Wyalusing.



17. Marking out the openings for truck loading bays, using a trailer as a guide.

GETTING REAL | 18

For me one of the toughest tasks is making sure the dimensions and proportions look right. And I'm not above "cheating" to get that determined! I used an Athearn trailer to make sure loading dock heights will be correct [17]. That steel base and magnets, probably a Micro Mark item from long ago, help with square assembly.



18. The seemingly chaotic nature of working on five buildings at once and jumping from one to another might seem unproductive, but once I got into the flow, it went seamlessly. Here I'm transferring one wall dimension to another for the rear wall of the Agway Fertilizer Mixing Plant main building.



19. This might be the ultimate work-in-process shot! The two main structures are mocked up and taped together. The gray shed is has been made from the other half of the Corn Syrup kit building I used for the long shed at Purina. This time I cut it in half again to make a more rectangular building. All of a sudden, the proportions and relationships of the various buildings and the track came together.

**Want to help keep
MRH free?**

Then *click* on ads!



20. The last thing I did before halting development of this scene was to mock up the elevator tower out of cardboard. It was a tricky little thing to get right, and I wanted to sleep on it to make sure I was happy with the proportions. I think I'm going to slightly reduce all three dimensions of it, just to make sure that it looks right.



**15%
OFF ON
EVERYTHING!**

**DID YOU KNOW
TRAINMASTERS TV
MEMBERS GET 15%
OFF ON ALL MRH
STORE PURCHASES?**

**CLICK TO JOIN TMTV NOW
AND START SAVING**

GETTING REAL | 21

Back to Masonite, at this stage I've cut up the rail and truck doors from the Walthers Corn Syrup kit and have positioned them in the order they need to be [21]. The door sections are not high enough, but there's a solution to that.



21. The Masonite building stands up for work in the end details.

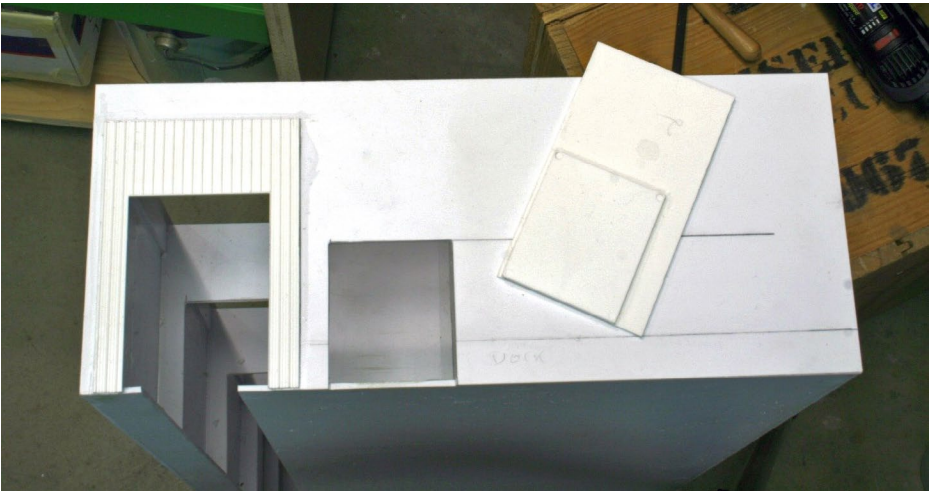

22. Door openings are marked to match the plastic castings, and trimmed.

GETTING REAL | 22

Because the doors are molded in a way that causes them to protrude behind the wall itself, I needed to cut out areas of the styrene box to allow them to fit flush.

These openings were carefully marked and the edges scribed, before I cut an X from corner to corner with a Dremel and a

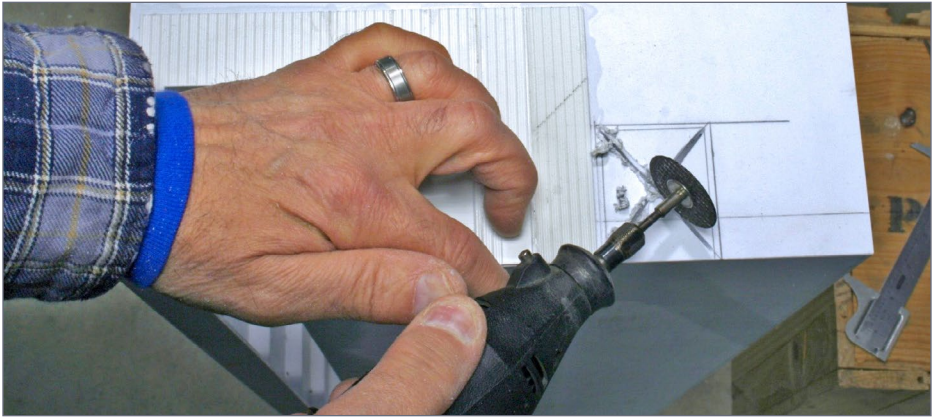

23. A Dremel tool and cutting disc make quick work of prepping the door openings.



24. Once the X is cut, scribe the top, bottom and sides of the opening to snap out the waste pieces.

GETTING REAL | 23

cutting disc. Each triangle could easily be snapped off by bending it inward. This was fairly thick styrene, so I wanted to make this as easy as possible.

Cypox quickly and permanently bonded the walls to the core. The end wall sections are applied and then trimmed to equal heights. The front wall sections were glued in place, leaving the building core as the foundation. By this time I had decided to not have a loading dock per se and built ground-level truck doors that would admit a whole trailer.

I'd have gone broke trying to paint a giant building like this with model paints! I wanted a non-standard color anyway, so with my wife's help, I was able to mix up the right blend using inexpensive latex paints that sell for about a buck apiece at the local craft store.



25. With siding, doors and tanks in place, it's time for another test-fitting.



26. A protective roof section is fabricated and mounted to the top of the walls over the loading doors. Here I'm painting it with PollyScale Aluminum prior to adding the top wall sections.



27. I mixed latex paints from a craft store to get an industrial pale blue. The foundation is masked.



28. With the building painted, it looked so much better than the old cardboard box that I became determined to finish the surrounding the scene to presentable standards.



I added a dirt access road to the rear area of the plant from the paved road.

GETTING REAL | 27

What the Masonite building needed next was some roof-top detailing, as well as the conveyors for the left side to handle sawdust. I kitbashed the conveyors from Walthers aggregate kits, and used part of their Colorado coal mine loader for a roof top bin. Parts from a Con-Cor “grain elevator” of some European origin make the circular bins shown. I’m also constructing the roof-top building. Amazing what I crammed onto that roll-around work surface!

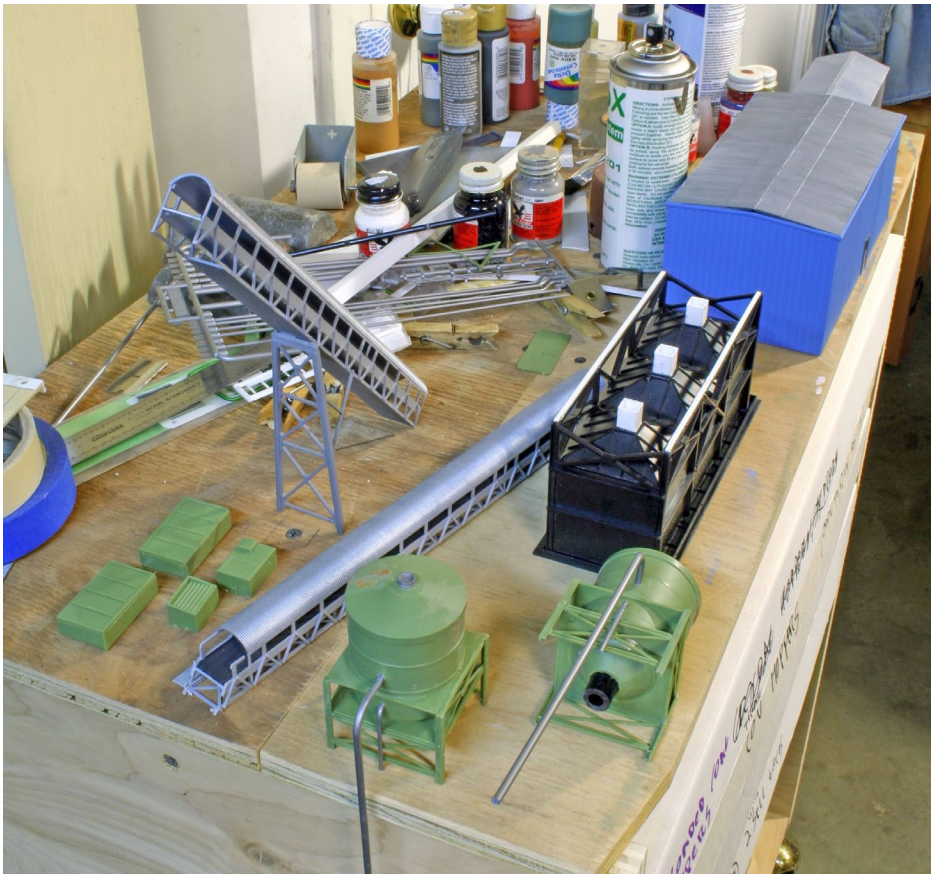

29. Bits and pieces from several kits turn into roof details, installed as need.

GETTING REAL | 28

What a difference a little paint and detailing make, along with bringing all the ground cover up to the foundation. The sawdust pile is just lumps of styrene piled up and hot-glued together, painted with some beige paint and sifted sawdust from my work shop immediately applied. Additional layers were bonded with hair spray and lots more sawdust was scattered all around the ground.



30. With details in place, paint and ground cover, the new Masonite plant is a lot more convincing than a cardboard box. The conveyor still needs the hanging “flap” at the end.

GETTING REAL | 29

While by no means finished – the building and details all need weathering, for one thing – to have this go from the scene shown at the beginning of this section to this point in just over a month is what I call high impact. I just made my deadline, but got the maximum done without feeling rushed. For me, this is when the layout definitely feels like it's Getting Real.





[Click here for reader comments](#)

31. It isn't weathered yet, but Masonite is ready for business.



WHAT'S NEW! ON TRAINMASTERS.TV

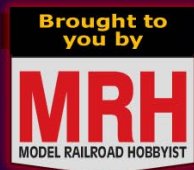

CLUB IN A 100 YEAR OLD DEPOT

Lewis County Club layout in the baggage room of the hundred year-old Chehalis, WA station.

Non-members: Watch for just \$1.49!

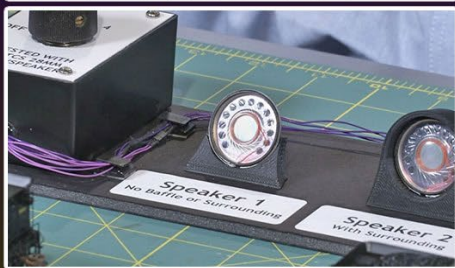

WHAT'S THE BEST ENCLOSURE?

When it comes to onboard speakers, hearing is believing. JD Forsythe demos the options so you can chose.

Non-members: Watch for just \$1.49!



FOUR WAYS TO MODEL WATER

Miles Hale makes a big splash as he demonstrates four products for creating water effects.

Non-members: Watch for just \$1.49!



HOW SCALE LUMBER IS MADE

Learn about the craft of turning raw wood into model-building products at the Mt. Albert Scale Lumber factory.

Non-members: Watch for just \$1.49!

Watch these videos on TrainMasters.TV

(Non-members can now watch one of these videos for just \$1.49, or download-to-own for \$3.49)





Model Railroad Hobbyist | August 2015 | #66

WHAT'S NEAT WITH KEN PATTERSON

KEN PATTERSON

column



[Click here for
reader comments](#)

HELICON FOCUS, CARVING FOAM, LASER TOOLS ...

THIS MONTHS "WHAT'S NEAT" VIDEO HAS

seven segments and as many interesting train runbys. We cover a lot of ground in ways we simply can't do with text and still photos. We talk about laser levels, foam carving tools, modeling from photos, and laser meters.. We visit Dirk Reynolds' bedroom-size layout. We cover night photography. I show in real time how to use the Helicon Focus depth-of-field stacking program, and we watch an entire automotive parts train made by Mike Budde.

▶ [PHOTOS AND VIDEO OF SUPERB MODELS](#)

[MRHMAG.COM](#)

- [TABLE OF CONTENTS](#)
- [INDEX](#)

WHAT'S NEAT | 2



WHAT'S NEAT | 3

1-2. We start with an overview of the tools that aid us in the carving of foam scenery on an Athearn trade show train layout. The curved and straight horse rasps are used for the rough rounding of topography and to carve run-off channels along the roadbed. I use a pruning saw for my main carving and cutting tool. A 12 inch and an 8 inch work well in combination. These saws flex, which aids in the carving of foam. I use a Surform shaver for final scenery topography. Other tools include the electric chainsaw and hot foam wire cutters of various sizes for tasks like fast cutting and precise detail cutting for control panels and electronics spaces and bridge placement cutting.



Playback problems? [Click here ...](#)



WHAT'S NEAT | 5

3. In this segment you will see how I created a still photo for Soundtraxx to demonstrate rule 17 lighting and how the decoder allows us to reproduce this feature with our models. Rule 17 involves the dimming of lights on a locomotive stopped on a track adjacent to an approaching mainline train. This can be done with Soundtraxx decoders by pressing f7 on your throttle to dim the lights and hitting f5 to cut the ditch lights on the parked train in the siding. I use a few flashlight tricks to create the effect on film outdoors in total darkness. By shining a flashlight in front of the Amtrak train it appears that the Amtrak train has a bright headlight lighting its way, while the Union Pacific train facing it in the siding has its ditch lights cut and headlight dimmed. Shot outdoors in total darkness, this shot came out just as planned.

NEW NEW Working Figures



WWW.
modeltechstudios.com





4. I really like the way laser tools have developed in the past 10 years. Laser levels are talked about in this month's video. I used one the other day to draw a 1 percent grade along a wall to position some narrow gauge track above my hidden staging yard. Before lasers, we would use a long level to draw our lines and would always have to calculate the percentage of grade to draw our lines. It always seemed to be $\frac{1}{4}$ inch off on runs of 25 to 30 feet. The laser level's red line eliminates all the guesswork and allows you to visually line things up to match existing benchwork and new grades. I drew a 4 percent grade around a corner with the red line as a perfect guide. It let me visualize things and make changes before I plotted the lines on the wall with a marker.



5. I pulled my bluff diorama out of the garage to illustrate using the Helicon Focus photo stacking program for our model railroad photography. With this program, you shoot a series of photographs focusing on a succession of points in the scene. I do this in real time and further explain the process in the video. Starting in the most distant scenery, I shot seven photos and show each one as the focus plane changes from background to foreground.



6. My father, Ken Bird, shot this photo of the Missouri Pacific Eagle running below my bluff property, back in January 1961. I wanted to shoot a similar photograph using the bluff model while showing how to use Helicon Focus.



7. We then go inside to operate the program with our seven images. You can watch in real time as the photo appears on the screen, as the computer does the calculations needed to bring the entire photo into focus.

**"When are you doing
the modern ones
we actually need?"**



Ken Goslett Photo

**How's about
NOW?**

**N scale 1400-Series GMD-1
Click here for more info.**



8. This is the final result, with the HO scale Missouri Pacific F units pulling a train on the model scene, at milepost 12.5



of the DeSoto sub. Everything is sharp, from the front of the scene to the back.

WHAT'S NEAT | 11

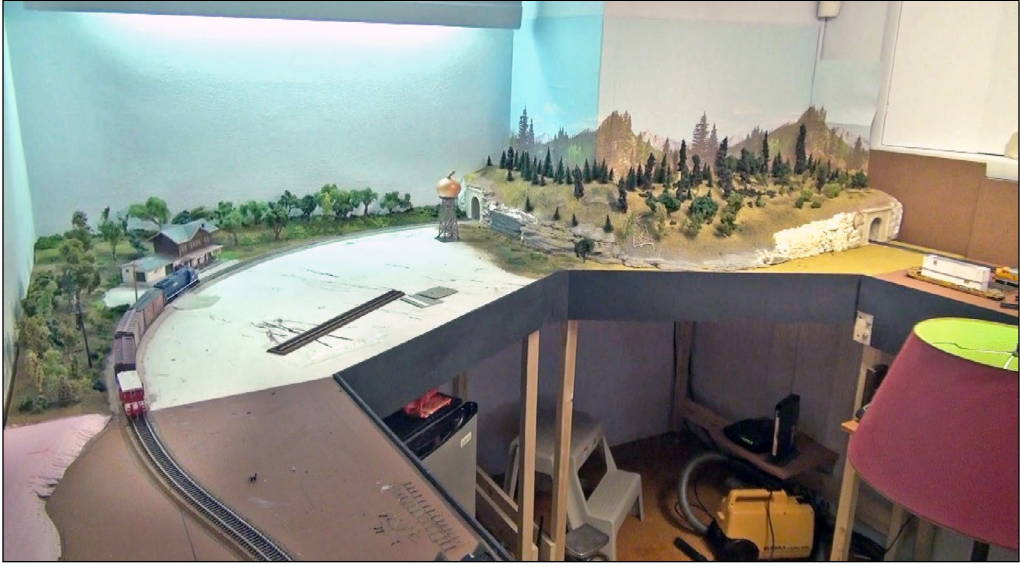

9-12. For our “What’s Neat” field trip, we visit Dirk Reynolds’ HO scale bedroom-size layout. In a room of 11 x 20 feet, Dirk has built a layout with scenes running along the wall and a liftout section through the doorway. The layout is built in modular sections, so scenes can be easily replaced with new modules or the layout can be relocated or stored. Dirk walks us through the construction process in the video, with many still photos to show his progress along the way. His Dry River

WHAT'S NEAT | 12



bridge was modeled from prototype standards, while his mountain scenes are freelanced. Dirk sums up this layout as a learning stage in his modeling as he learns and develops modeling skills.

WHAT'S NEAT | 13



13. In the last segment of the show, we have Mike Budde show us his auto parts train returning to the plant with empty scratchbuilt autoracks, well-worn box cars full of auto parts ready for the assembly line, and flatcars full of new auto frames. Because our art is not painted on a wall-sized canvas, but instead is more like three inches high by 35 feet long, I thought it would be best to film and show Mike's train in full run. Some creative editing keeps it interesting, and that is how we close out the show.

Be sure to vote in Readers Comments if you like What's Neat with Ken Patterson. Thank you for your support.



[Click here for reader comments](#)

*Build this beautiful shelf layout
step-by-step with Ken Patterson!*

**CHECK IT
OUT!**



kenpatterson.com

click here to ...

Visit Ken's website

**Ken Patterson builds a
shelf layout using
state-of-the-art methods**

Nano-Oil™

Made in U.S.A.

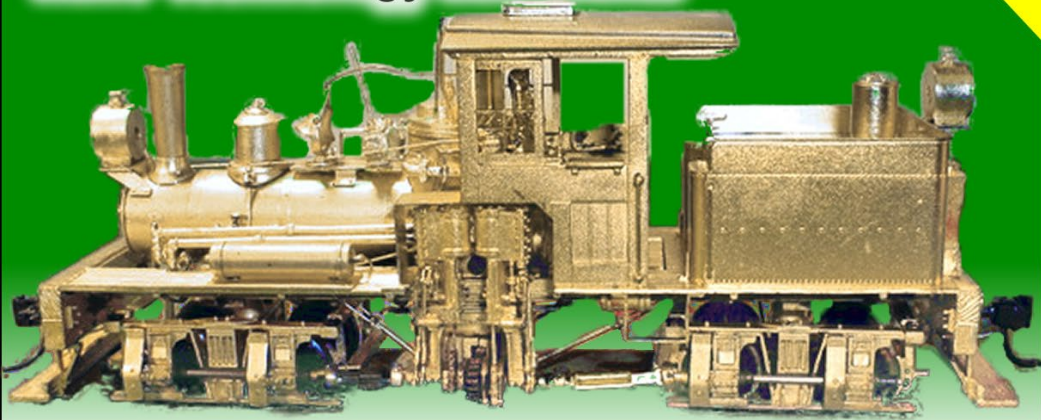
**New
Innovation****Nano Technology Lubricants**

"After eight years of extensive testing, the only lubricants now used in my shop are Nano-Oils and Nano-Grease. The extreme reduction in power draw by mechanically minimizing friction is simply technologically superior."

- Phil Floyd, 'The Shay Fixer'

**Nano-Grease**

**For more details
click here ...**

**THE SHAY FIXER**

VISIT US AT...

SHAYFIXER.COM

Specializing in brass Pacific Fast Mail / United geared locomotives

MRHMAG.COM

- [TABLE OF CONTENTS](#)
- [INDEX](#)

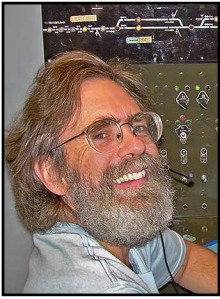

IMAGINEERING

column

DOUG GEIGER, MMR
.....



[Click here for
reader comments](#)

THE CORPORATE IMAGE ...

FREELANCING CAN TAKE MANY FORMS ON your model railroad, from developing an imagined history to making up a name to establishing a corporate theme. It can inject the fun back into model railroading. Of course, the definition of fun is probably different for each one of us. How many of us have concentrated so intently on modeling the prototype that we have forgotten to have fun? Has the technical side of the hobby so dominated the creative and artistic side, that we can no longer laugh and enjoy the hobby as it once was? I hope not, since applying freelancing ideas to your model railroading will be my subject for this new “Imagineering” column for MRH. Almost all of us freelance our track plans because no model railroad space is large enough to portray a real railroad’s physical size in perfect detail and layout. Thus no hobbyist can claim to be a true 100% prototype modeler if they have a layout.

Of course, all freelancing needs to have some grounding in prototype practices for it to be believable. Sure, you can put

▶ [EXPLORING THE CREATIVE SIDES OF THE HOBBY](#)

palm trees in the middle of your mountain scenery or have some Pennsylvania heavyweight sleepers trailing a BNSF ES44AC GEVO, but your visitors might raise an eyebrow or two. Of course, it is your layout and you can do with it what you want to. But do you really want to shout that you just play with trains? People gain credibility by showing others they are serious with their hobbies, and model railroading should be no exception.

For this column, let's treat your railroad as if it were a real company, complete with corporate images, colors, and heralds. We will also explore adding realism to your model railroad's name and location. General ideas will be illustrated by examples taken from my own Granite Mountain Railway (GMRy). It is a large HO/HOn3 multi-level, 1988-era, bridge-route, made-for-operations layout set in the Rockies and Cascade mountains. Everything about the GMRy is freelanced, including the name, locations, paint schemes, and heralds. But everything on the layout has its foundations based upon western prototype railroads, like the Denver & Rio Grande. When the GMRy was begun in 1982, the emphasis then was not on prototype modeling as it is now. Freelancing was the accepted practice. I still believe that freelancing concepts avoid some of the straight-jacket mentality that some prototype modeling develops.

This short article cannot even begin to scratch the surface of what is acceptable and pleasing. However, by drawing on actual railroad logos and colors, you can make much better choices. Don't be afraid to make mistakes – just weather them sufficiently or relegate that not-so-great painting idea to the scrap yard. Real railroads make poor choices, too.

Adding a corporate image to your railroad can be as simple as picking your railroad's name. For more challenge, consider

IMAGINEERING | 3

designing a locomotive color scheme with a unique herald. More identity can be added to your layout by painting and lettering home-road rolling stock. Finally, create on-line structures with your own color combinations. You can even have t-shirts made with your company logo and colors! You may need to learn how to make your own decals, or find a company that makes custom decals. How much corporate image freelancing you want to apply to your railroad is up to you.

For me, it's fun to treat the layout as a real corporation and go the whole distance. Working through problems with track or building design, and then applying engineering principles found in the prototype is very rewarding. How would the prototype solve a certain problem? Many times it's easier to find a real-world solution to a situation than trying to reinvent the wheel. Does the arrangement of a

Combo Right Clamp™

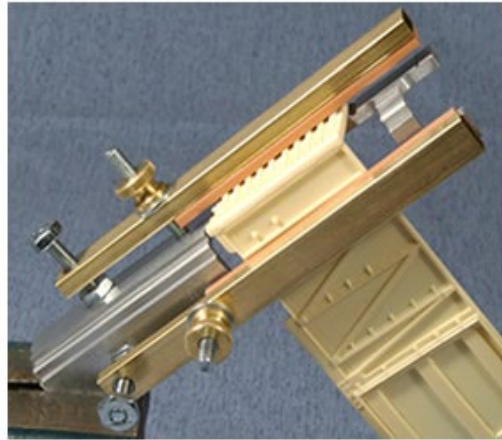

Combo Right Clamp™
with cast resin boxcar

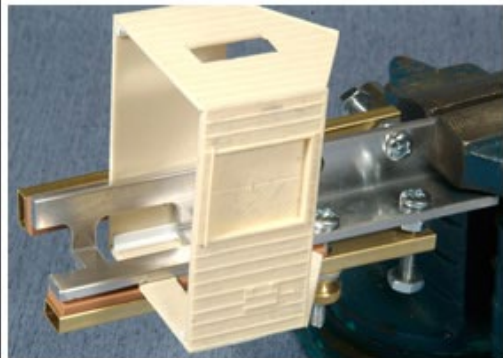

Combo Right Clamp™
with Wolf Design Pump House

**Click here for
all our products ...**

Tools for Modelers

Coffman Graphic Solutions Co.
1500 River Circle, Richmond,
KY 40475-7907

IMAGINEERING | 4

building in a setting make sense? Can the plumbing and piping surrounding the building support the product being made? Is the building big enough for an incoming covered hopper of raw materials and an outgoing boxcar with finished product? Can you justify adding a certain industry to the overall theme of the model railroad? Will the track arrangement make sense for that industry? Is adding that new locomotive really justifiable in your current roster of engines? These and other questions need to be asked and answered. Posing and solving these questions can be quite fun and mind-challenging.

One set of questions involves the corporate identity of your railroad. In the corporate environment, the name of a company and its logo can make or break them. Companies go to great lengths to protect their image. In the freelanced world, the railroad name, colors, and heralds also can define the layout and the owner's vision.



1. Although this FMC covered hopper is weathered, the reporting marks on the left end are still quite visible. These letters and numbers must be unique so that car forwarding will be accurate.

The railroad's name

Consider your freelanced name carefully. If you choose a cute or whimsical name, that first-time novelty can quickly wear off and become a chore. My Granite Mountain Railway name was chosen when I was about 16 years old and now I am 60. That name has been applied to at least three different layouts over the years, and has withstood the test of time.

In the April 1995 *Layout Design News*, the Layout Design SIG (LDSIG), published an article by R. L. Warren about prototype railroad names and how to apply them to a model railroad. That LDSIG article categorized 100 real railroad names from the transition era (1940s-1950s) into various subjects, including geographical, states, and cities. The results showed that in the 1950s, a name that combined a city and a geographical term was a top contender; with a cities-only name a distant second. Names with rivers were popular, but names with mountains and lakes were not. “Railroad” vs. “Railway” in the name can add variety.

If you model an early era, like the 1900s to 1930s, consider adding “& Western” to your name. Many of the early railroads had bold plans to run their lines all the way to the Pacific Ocean. If your chosen name is too complex, you and your visitors may have a hard time remembering it.

If you choose a more modern era, consider making your layout a division or subdivision of a prototype railroad. For example, the Fall River Division of the BNSF. Or you can call your railroad a fictional branch of a real rail line that connects your towns together.

Finally, don't be too disappointed to discover that your supposed freelanced name was an actual railroad. Few people will know it.

I discovered the Granite Mountain, although not a railroad, was the name of an infamous copper mine in Butte, Montana that holds the record for the most miners killed in that state.

You should create reporting mark letters for your fictional model railroad company. These three- or four-character abbreviations plus numbers are found on all freight cars. For example, the FMLX 45396 on a covered hopper identifies that car [1]. No other covered hopper can have that reporting mark. For prototype railroads, these reporting marks are identifiers used for billing the customers and locating missing cars. For operation-oriented layouts, each piece of rolling stock should have a unique reporting mark to avoid confusion when switching. Many private (non-railroad) companies append an X to their reporting mark letters.

Heralds and slogans

The previously mentioned LDSIG issue also contained an article covering prototype heralds. Most real heralds or emblems were either circles or rectangles. Early heralds were complex with intertwined lettering, while more modern ones are usually simple. Designing a herald design can be fun, especially if you have some artistic talent or can enlist someone who does.

Another great resource for railroad marks is the Autumn 1985 issue of the Railway & Locomotive Historical Society's publication, *Railroad History*. The author, James Ward, covers many of the prototype railroad emblems over the decades, and how they were designed. Circles, rectangles, triangles, squares, and shields are often used by railroads, and so should your free-lanced road. Consider slanting text in a herald to denote speed. According to Ward, most emblems "are conservative in their use of figures and depend heavily on ancient symbols."

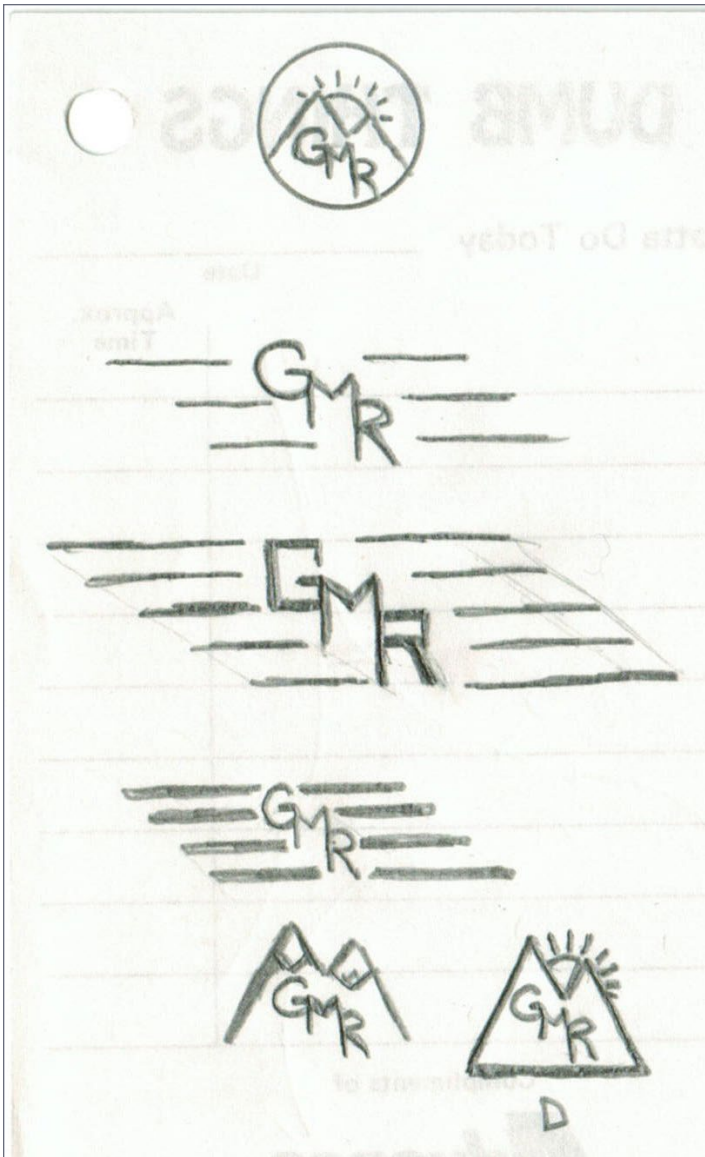

2. Here are some pencil sketch rejects of some Granite Mountain heralds. Don't be afraid to try many designs before choosing your final product, since it is much cheaper to experiment on paper before committing a design to a decal.

IMAGINEERING | 8

You can have several herald designs that tell your railroad's history. Make sketches of heralds and pick one or two. Maybe start with a simple circle enclosing the railroad's name and then add another herald that is more complex. Consider that some heralds tie the beginning letters of the railroad's name together, like Penn Central's infamous "worm" logo. Or consider cloning

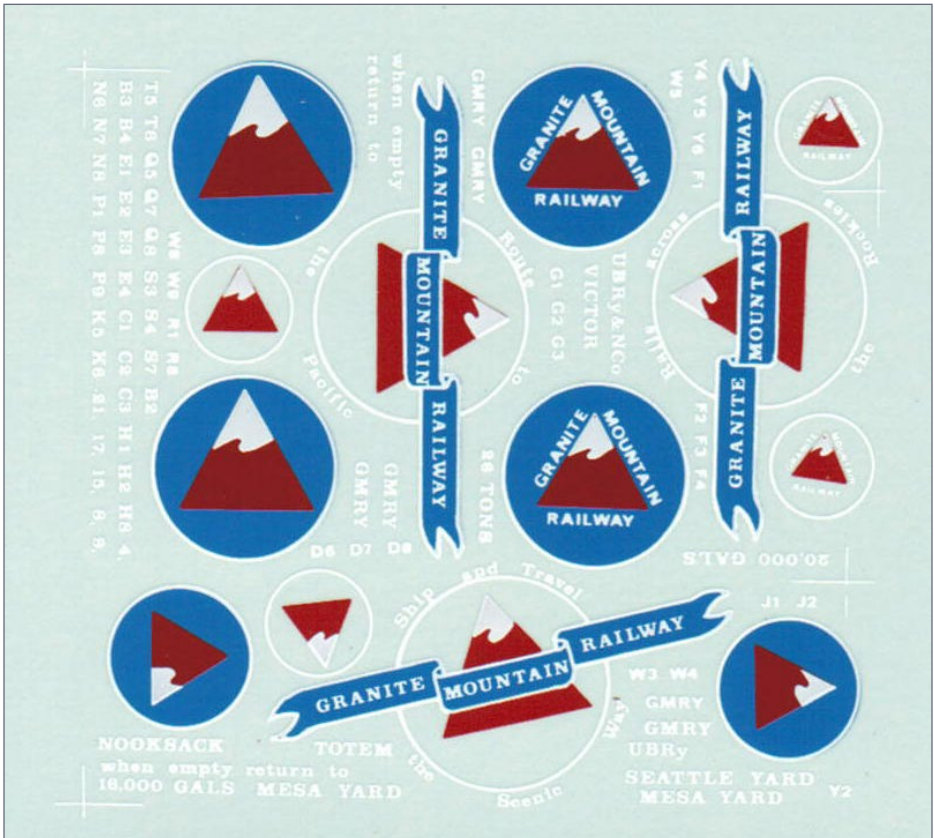

3. The final GMRy herald is three colors: red, white, and blue. There are several custom decal manufacturers available; just make sure your artwork can be duplicated with their processes. You can also make your own decals.

an existing herald by adding your railroad's name to it. Try to avoid making many finished designs, as a real company tends to stick with one emblem for years.

My advice: sketch a variety of designs and choose the one that best suits you, that can be duplicated as a custom decal. Treat logo design just like you do your track plan design. How many plans did you draw before you settled on one to build? Many designs were rejected for our GMRY [2] before a final herald was decided upon [3].

Some railroads also had slogans, like the Rio Grande's "Through the Rockies, not Around Them" or Union Pacific's "We Will Deliver." You might want to make a slogan or two for your railroad. A friend had "Fast service, no matter how long it takes." The GMRY has several slogans: "Ship and Travel the Scenic Way" and "Route to the Pacific." We have put these slogans and heralds on billboards and structures, as well as locomotives, freight and passenger cars, t-shirts, and coffee mugs [4, 5, 6].

Locomotive colors

How prosperous or bankrupt is your railroad? That will have a huge bearing on your choice of paint design. Complex images cost money for a real railroad, and you should think about that, too. Also consider if your paint scheme should be in simple blacks or grays (very conservative), or should it be colorful and bright (a progressive outlook)? Of course, if you are planning on having steam, most were painted black with simple white lettering on the tenders and cab numbers. Almost all prototype railroads in the steam era were extremely conservative. Very few steam engines were flashy. But if you really want your latest high-stepping 4-4-2 to stand out, consider a yellow or bright green paint job!





4. Home-road structures can benefit by the application of one of your custom heralds. Since the narrow gauge on the GMRy still has steam locomotives, water and coal must be provided. A close look near the top of the coaling tower reveals a faint GM&P (the name of our narrow gauge railroad) text under the GMRy logo.

5. Consider applying your finished herald to a t-shirt. Several shirt colors (black, light blue, and gray) complement the GMRy herald. For a fee, some t-shirt printing businesses will handle custom orders.

6. Even coffee mugs can have an emblem applied. Like t-shirt and decal companies, make sure those companies can handle your logo.

IMAGINEERING | 12

A source of former railroads color schemes can be found in several of Don Ball Jr.'s books like *America's Railroads* and *America's Colorful Railroads*. Find out what appeals to you and chose something similar. Also think about using an existing railroad's scheme in your own rendition. At one time, I considered applying the lightning stripes from a New York Central F-unit decal set upside-down to a Granite Mountain diesel.

Don't feel locked into one paint scheme. As with heralds and slogans, you can have several eras of paint designs to show the



7. The lead locomotive shows off one of the newer GMRy all-blue paint schemes. The colors are Conrail Blue sides and ends with a dark-gray top. The trailing unit is one of the original F45s painted in a conservative medium-gray scheme with a black roof.



8. At the Mesa yard roundhouse, we see three of the newest heritage units. A close inspection of the insignia illustrates the application of the ribbon herald instead of the more modern triangle mountain logo. Switchers also can be painted in your freelanced herald.

passing of time on your freelanced corporation. On the GMRy, the first paint job was black-and-gray – a very conservative paint scheme. Later, we developed another scheme, promoting more wealth and prosperity [7]. Another scheme was designed by using a slogan around the herald [8]. Adding a stripe can turn a freight engine into a passenger one [9].

Make copies of drawings from samples of your locomotive fleet, or just photocopy models directly. Then use colored pencils or

IMAGINEERING | 14

pens to start creating your own paint scheme. Remember that white lettering with do-it-yourself decals can be a challenge. For ease of painting, plan on using model paints directly from the jar. Custom mixed colors can be difficult to keep consistent. These days, the variety of paint colors are wide enough for any scheme you can dream up.

Develop a roster for your locomotives, just as the real railroads do. The wheel arrangements usually determined the class for steam engines. Horsepower and model numbers keep most diesels in the same category on the roster. Having several of the



9. Two of the original GMRy engines are seen poking out from the roundhouse. Although very similar in color to the freight F45 on the right, the engine on the left is a passenger FP45, as indicated by the yellow stripe and the yellow reflective rectangles along the frame.

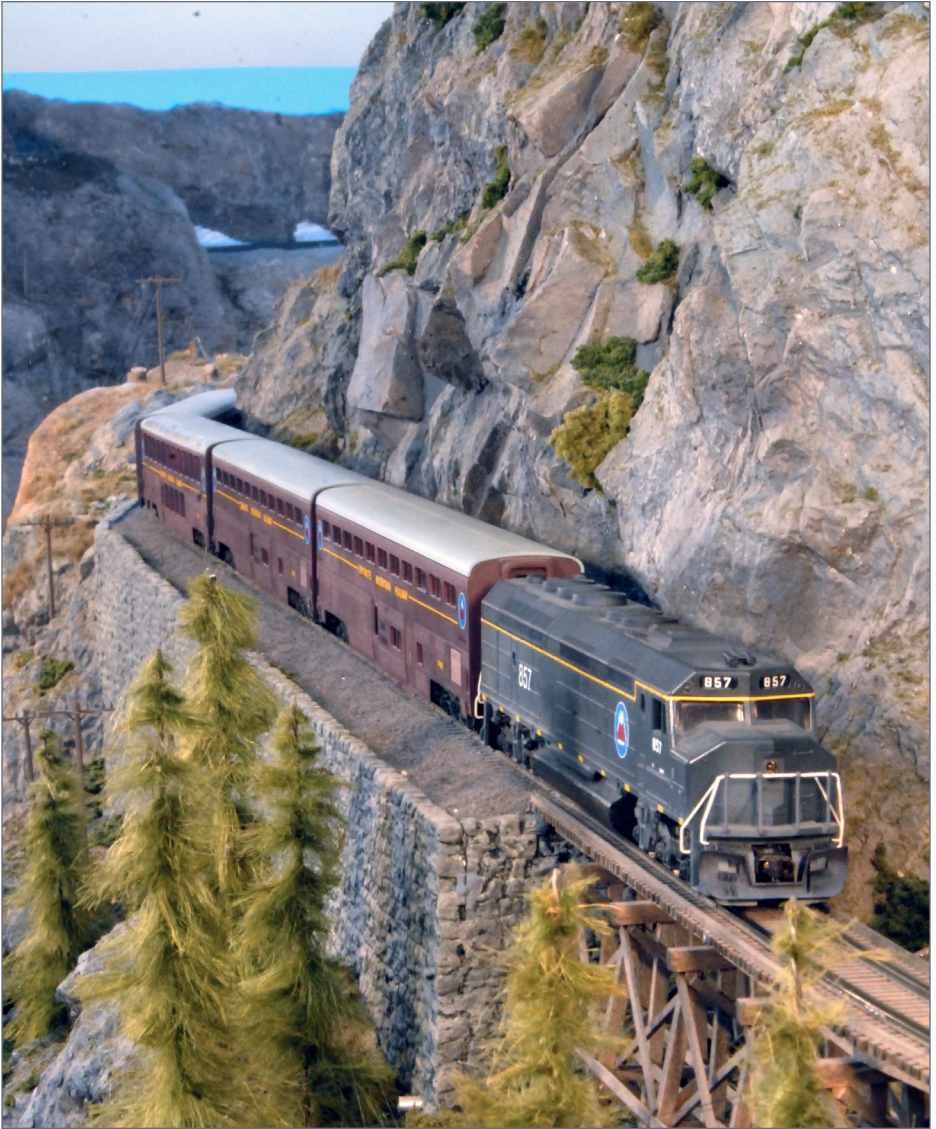

10. The Mountaineer passenger train is seen at Misery Cut, a tall retaining wall in the Rocky Mountain section of the layout. These Con-Cor superliner cars were painted and decaled in the passenger car colors (maroon and gray) of the Granite Mountain Railway.

IMAGINEERING | 16

same make and model of locos can be visually appealing. Just keep each within a specific number sequence, separated by a few digits.

Train names

Trains should have names, too. Many passenger trains had flashy names so the traveling public could remember them. Who could forget the famous 20th Century Limited on the New York Central? Or the Broadway Limited on the PRR? Freight



11. Here we see several GMRy freight cars on a large fill. The covered hoppers are painted BN-green with GMRy heralds. The Geiger's Inkwash tank car was custom-decaled by a friend because of my enthusiasm for using an india ink wash as weathering.



12. Even private-roadname tank cars have remained black over the decades. Since the GMRy is not a private industry, no 'X' has been appended to the reporting mark of GM.

trains had names as well, like the BN's Buckwheat Local where I live. Add variety to your passenger trains so crews know not to delay a certain fast flyer. Even consider renaming one of your Amtrak trains to something you decide. On the Granite Mountain, we have PigZip (a hotshot intermodal) and Grande Coal (the once-per-day coal drag from the D&RGW). And we had the Mountaineer [10] until Amtrak's California Zephyr (#5 and #6) took its place in the schedule. Some memorable train names from other folks' op sessions include: the Dirty Shirt (a mine shifter) and the Termite Train (a pulpwood local). Get

your crews to help name trains, since they are the ones that run them during your op sessions.

The family look

Most railroads customized their locomotives, both steam and diesel. Sometimes they were delivered from the factory with these custom looks, other times they were modified by the railroad's own shops. The location of the bell, whistle, or headlight varied among the prototype lines. Some roads centered the headlight on the smoke box, while others mounted it along



13. You can easily turn a factory-painted piece of rolling stock into one of your own railroad's cars by simply patching over the existing car's reporting mark. Here we see a Railbox car with a new GM identifier.

TRAINMASTERS.TV

An Sn3 beauty!



Brought to
you by

MRH
MODEL RAILROAD HOBBYIST



Coming in August!

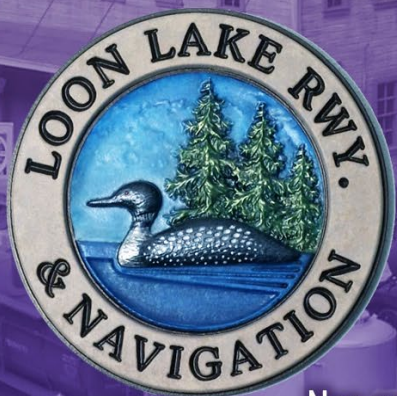

Non-members can watch for only \$1.49

Visit the TrainMasters TV website

MRHMAG.COM

- TABLE OF CONTENTS
- INDEX

the top. Same for the location of the bell. On diesels, some roads hung the bell under the chassis, while others hung it on the nose. Horns can also be mounted in a variety of locations. Regardless of where these appliances were mounted, they usually remained consistent across the entire railroad's territory.

Consider adding a family look to your locomotives. The overall look of your engines can become a family tradition. If you are modeling the pre-1990s, wide-nosed diesels should probably be avoided. Unless of course, you want to have what the hobby



14. Caboose should reflect your corporate image, too. The maroon scheme was introduced with the all-gray locomotives, and the blue scheme coincided with the delivery of a group of blue F45 engines. Since the GMRy is a bridge route, cabooses of both the ATSF and Rio Grande often show up in the caboose track at Mesa Yard.



15. This local train is waiting patiently for Amtrak's California Zephyr to clear West Totem. Note the transfer caboose in the blue scheme behind two heritage switchers.

industry is now calling a fantasy paint job! That idea too should be called freelancing. And how about all those freight cars with running boards? Should they be removed if you are modeling the post-1970s? Mixing eras can be confusing. Or it can be called freelancing, depending on your family-look preferences.

Rolling stock

Add your corporate image to your rolling stock. In the beginning, rolling stock was usually basic tuscan red or black. Usually the only splash of color was the yellow refrigerator car. As the 1970s color on boxcars became more widespread, almost to an



16. MOW equipment can benefit by an application of a company paint job and decals. Two hikers observe a GMRy hi-rail suburban vehicle deep in the Cascade Range forest.

extreme (with pinks and bright greens), covered hoppers soon followed suit. Then the Granite Mountain did the same [11]. My tank cars and hoppers, however, have remained in a basic black [12]. Modern railroads (post-2000s) mostly have the patched car look. Use an existing railroad paint scheme (usually heavily weathered and ragged) and just paint-out the existing reporting mark and add your own railroad's reporting mark [13]. Some leasing companies now just paint-out the previous owner's name and logo, and patch in their new reporting mark without adding any new logos or slogans.

Don't forget cabooses, assuming they run in your era [14]. If your cabooses are called shoving platforms, or are transfer cabooses, they still can bear your corporate image [15]. Even maintenance-of-way vehicles and equipment can have a corporate look [16].

Names on the layout

Every piece of track on a prototype railroad gets a name. Every structure gets a name, too. Some names are obvious (like the depot track), but others have a history no one can seem to remember (like the falloff track). If you are into operations, you might consider having location maps handy to help the visiting operators identify these tracks. Make sure each depot or siding has its name prominently displayed. Real railroads post signs at every meeting (or control) point, and so should your model railroad [17]. Industries also have names reflecting the product they make [18].

Have fun naming everything on your layout and enlist others to help you. Some layout owners name a few of their model railroad industries (and even towns) after family members or

!MAGINEERING | 23

crew, which is a nice thank-you. But think twice about a name that sounds too close to another name, especially for sidings. Real railroads have had to rename locations because crews could mistake one locality for another because of a similar sounding name. Tragedy could result if an order was misread or miscopied.

On our Granite Mountain Railway, we named every siding and every major scenic feature before any benchwork was built. We named each location in alphabetical order. Consider naming



17. Every depot or control point on your railroad should have a name. The GMRy depot at Nooksack handles the twice-daily Amtrak trains. The paint job on the station has its roots in The Milwaukee Road depot colors.



18. Industries also can have freelanced names. This large plant is Story Hides, an industry that converts hides (which arrive via the narrow gauge line) into leather (which departs via standard gauge boxcars). There is also a “story” with this industry: it “hides” the narrow gauge staging yard inside the building’s top level.

towns that might reflect the locale or reason for that town. On the GMRy, the lower level exists in the Cascade Mountains of Washington state, so all the names have a northwest-sounding ring to them (e.g., Stillaquamish and Totem sidings, Upsquish Ridge, and Arrow Yard).

The freelancing of a model railroad’s identity can be challenging, but the satisfaction of using your own creativity can be a lot of fun. Applying corporate decision-making processes to your

IMAGINEERING | 25

modeling can be interesting. Of course, your layout can exist for years without making any profit, as long as it exists for years of making fun!



**Click here for
reader comments**

ADVERTISEMENT

George's Trains EST. 1962
Canada's Greatest Model Train Store!

**20 NEW Colours
Just added!**

PROTO-PAINT

ACRYLIC-Air Brush Ready
NOW OVER 45 Canadian Railway Colours!

Dealer inquiries welcome.

PP-001 CNR Green #11	PP-020 TH&B Maroon	PP-038 TTC CREAM
PP-002 CNR Imitation Gold	PP-021 Primer	PP-039 TTC Maroon
PP-003 CNVIA Blue #16	PP-022 Reducer	PP-040 Warm BLACK
PP004 CNVIA Yellow #18	PP-023 Flat Finish	PP-041 Grimy Black
PP-005 VIA Grey	PP-024 Stencil White	PP-042 Anti-Glare Black
PP-006 CN Red/Orange #11	PP-025 Loco Black	PP-043 Slag Brown
PP-007 CN Lettering Grey #17	PP-026 Flat Haze	PP-044 GO Green
PP-008 CN Grey #11	PP-027 ONR LT BLUE	PP-045 GO White
PP-009 CNR Red #12	PP-028 ONR DK BLUE	PP-046 CONRAIL Blue
PP-010 CPR Tuscan	PP-029 ONR YELLOW	
PP-011 Diesel Grey	PP-030 ONR 2000 Yellow	
PP-012 CPR Diesel Yellow	PP-031 ONR GREEN	
PP-013 CPR Steam Grey	PP-032 BCR/PGE DK GREEN	
PP-014 CPR Mineral Brown	PP-033 BCR RED	
PP-015 CP Action Red	PP-034 BCR Blue	
PP-016 CP Action Yellow	PP-035 BCR Yellow	
PP-017 CP Action Green	PP-036 BCR/PGE LL GREEN	
PP-018 CP Bright Red	PP-037 GTW Blue	
PP-019 TH&B Cream		

\$8.98 each
Canadian

ORDER NOW!

550 Alden Rd. Unit 101 Markham, On, Canada L3R 6A8
Tel: 905-470-6200 Toll Free: 1-877-8TRAINS (887-2467)
www.georgetrains.com

YD 
Yankee Dabbler.Com



**Come and
see our
Savings
Today!**

(while supplies last)

Click NOW!

HO

DCC

ALL SCALES

**- Kadee - NCE - SoundTraxx
- Digitrax - And more!**



MRHMAG.COM

- **TABLE OF CONTENTS**
- **INDEX**

NEW!

STRUCTURE PLANS, VOL. 2

300 pages of wood and masonry structure plans

eBook

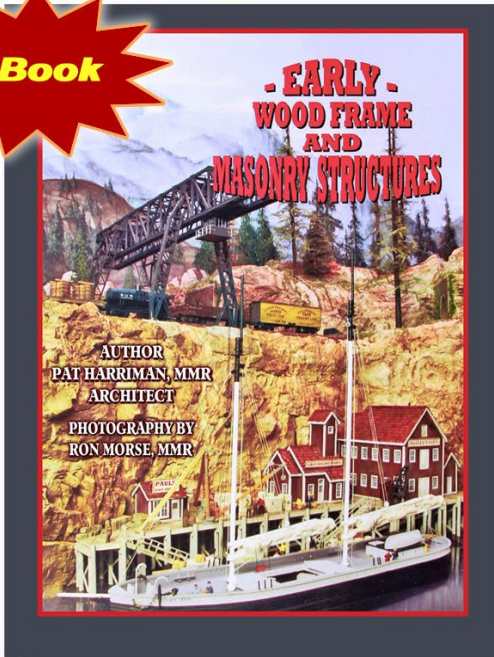

List price:

~~\$19.99~~

Special:

\$10.99

You save:

\$9.00
(45%)

eBook formats:

PDF - ePub

Designed by architect / MMR Pat Harriman for the tight spaces on a typical model railroad

**Buy instant
download NOW**



store.mrhmag.com

**Hardcopy edition
coming soon!**



HOBBY MARKETPLACE

Yarmouth Model Works

HO scale resin kits and detail parts

U.S.A. MAILING ADDRESS
3560 Pine Grove Ave. Unit 617
Port Huron, MI 48060

Tel. 519-633-7574

pierre.oliver@start.ca

www.yarmouthmodelworks.com

CANADIAN MAILING ADDRESS
85 Hiawatha St.
St. Thomas, ON N5P 2T5



NEW N.A.R. STK CAR KIT!



**RESIN KITS, DECALS,
DATA DISKS & DETAIL
PARTS AVAILABLE.**
westerfieldmodels.com



P.O. Box 6 Paonia, CO 81428

Ph. 970 527 4586

Made in The USA

Cast resin items for All Scales.
Tunnel portals, bridge piers, abutments,
culverts, and retaining walls.
Trackside details and sage brush tree
armatures.



LED LIGHTS | NEON SIGNS ASSEMBLED
UNIQUE PRODUCTS FOR UNIQUE LAYOUTS
NEW PRODUCTS
ADDED MONTHLY
[Click Here](#)

- LED LIGHTS
- ~ EASY TO INSTALL
- ~ 6 SIZES
- ~ 6 COLORS
- ~ SOLID & FLASH
- ~ SPECIALTY LED'S
- ~ COMPLETELY ASSEMBLED

MOUNTAIN SUBDIVISION HOBBIES

www.modelrrsupply.com

FREE USA SHIPPING OVER \$29.00

NCE - SOUNDTRAXX - DIGITRAX - PECO - CIRCUITRON
DCC SPECIALTIES - INTERMOUNTAIN - CMX - ATLAS
BAR MILLS - BOWSER - KATO - MRC - TOMAR - RIX -
PIKESSTUFF - LOGICRAIL - CENTRAL VALLEY AND MORE!

RULERS-of-the-WORLD

Scale Rulers \$4 each

Over 200+ scales!

Metric or Imperial

www.rulers-of-the-world.com

CLEVER
models LLC

The hottest trend in modeling... Is also the least expensive.



Try one today!

www.clevermodels.net

PRECISION DESIGN CO

Chains
Flat Car loads
Joint Bars
Signs & Posts

FREE SHIPPING

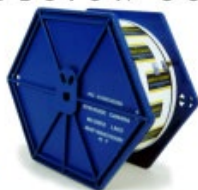

Affordable built to order Benchwork starting at only \$20 a Sq Ft.

Hobby Marketplace
Ads are
Economical and
Effective.

Click to learn more ...

Great Decals!TM

FEC, Interstate, Virginian
Railway, & L&N Titles
After Hours Graphics Line
Coupler Gages and More
In O, S, HO, and N Scales

Don't settle for lifeless signals!
We've got signaling circuits!



LOGIC RAILTM
TECHNOLOGIES

"Sophisticated
Model Railroad
Electronics"



Please visit our website and online store!

21175 Tomball Pkwy
Suite 287
Houston, TX 77070

Phone: (281)251-5813
<http://www.logicrailtech.com>
info@logicrailtech.com

LOOK
at what's new at
Black Cat this month

Click here for
our orderform

Private owner cars
We have decal sets for:
15 different tank car sets
18 trailers & piggybacks

Black Cat Publishing
234 Lindenwood Dr. W.
Winnipeg, MB R3P 1X7
(204)489-5005
ajfergus@mymts.net



AMERICA'S NUMBER ONE
RAILROAD PRINT SOURCE
Jelsma
Graphics
...America's Railroad Embroiderer

Railroad Art-Prints,
Caps, Jackets,
Shirts and More ...
Jackets starting
at \$79.95

www.jelsma.com

1-904-221-3513 • Jacksonville, FL.

Please click on ads: it helps keep MRH coming to you free!

Don't miss *The Eagle!*



- Enjoy 4 full color magazines per year
- Plus a 12-month full-color calendar
- 2015's annual meeting in Houston, TX
- On-line company store featuring special run MP models, books and much more.

To join: go to mopac.org or e-mail marketing@mopac.org for more info.
Or send \$35 for your membership to:

Missouri Pacific Historical Society
Membership Services
P.O. Box 138
Bucklin, MO 64631-0138

V2

True Scene Modeling™



FusionFiber™

Scenery Base Material for the 21st Century!

SATISFACTION GUARANTEED!

www.truescene.com or 716-523-7305

Vector Cut .com

PRECISION
Laser Cut Details & Kits

STREAMLINED BACKSHOP

Sales
... Services
..... Solutions

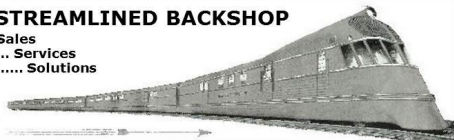

"SUGAR CUBE" SPEAKERS...

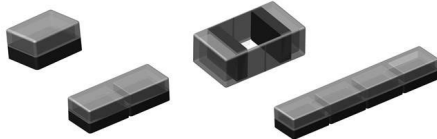

4 Sizes * 4 Baffles

... "Sweet" Speaker Options!



www.SBS4DCC.com

Trees

Evergreen
Conifers for HO,
N, S, and O Scales

Make Your Own,
Save Money and
Have Fun

Real Wood Trunks

All Components
Available
Separately

Made in Oregon, USA



coastmans.com

Please mention MRH when speaking
with advertisers.

Have you seen these popular blogs on the MRH website?

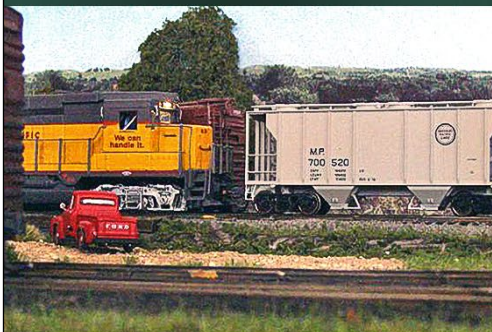

Ken Glover's Shelf Layout

57,000 reads

[CLICK TO READ IT NOW](#)



Mike Rose's N scale empire

87,000 reads

[CLICK TO READ IT NOW](#)



Your ad could be in this space for just \$57 a month.

[Click to learn more ...](#)



DID YOU KNOW MRH SUBSCRIBERS GET FREE BONUSES? [CLICK TO SUBSCRIBE NOW - IT'S FREE!](#)

MEADOW GOLD DAIRY

BY DON HANLEY
.....

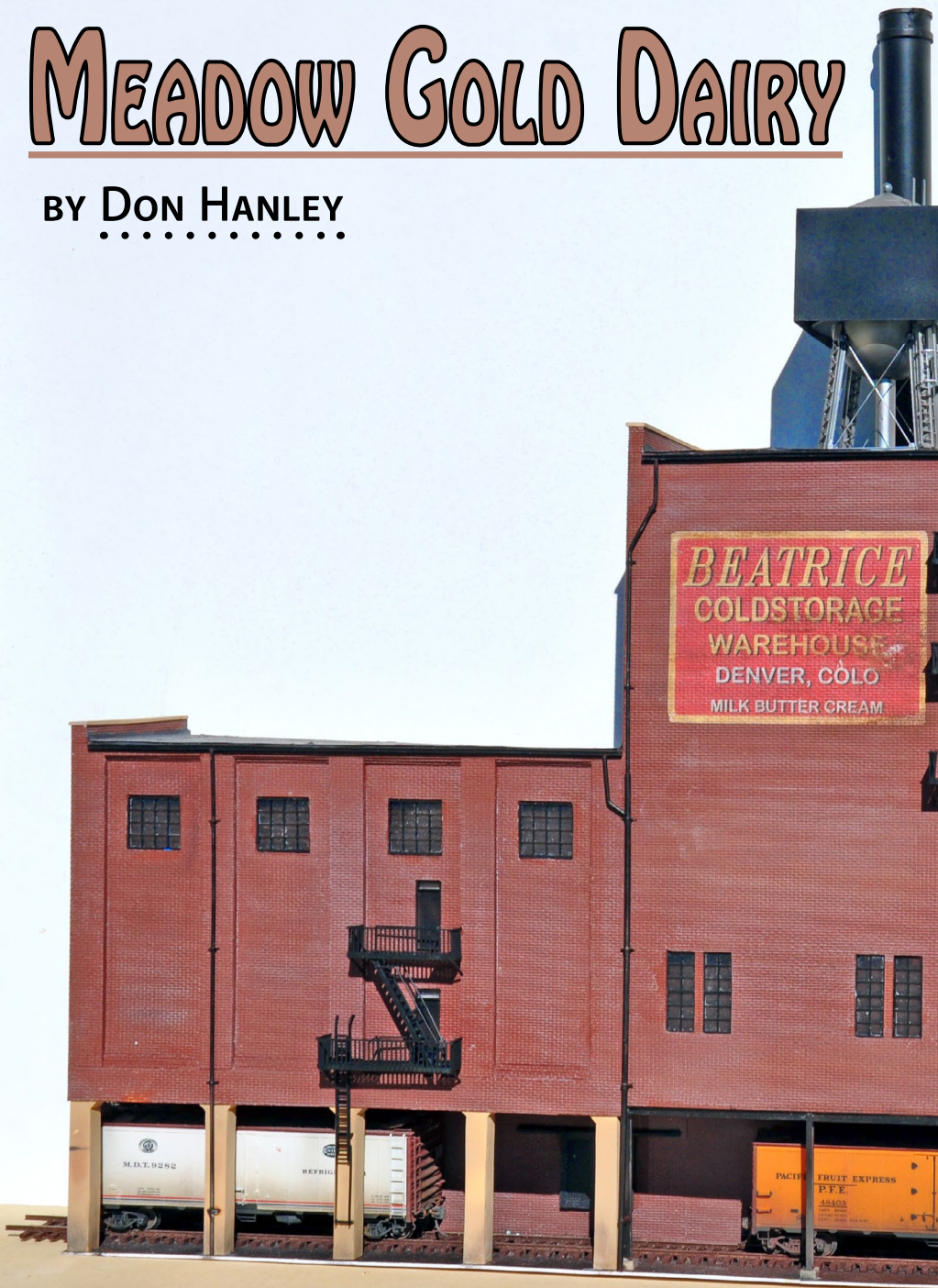

Using modeler's license to fill a unique space

I HAVE THE PRIVILEGE OF OPERATING ON A beautiful prototype-based layout built by Jim Petro. Jim models the DRG&W in Denver, CO with Union Station being a signature feature of the layout. One of the prominent prototype landmarks adjacent to Union Station is the Meadow Gold Dairy and Cold Storage building.

My initial research on the Internet provided little information. However a clue on one of the photos called the structure Littleton Dairy. Using that bit of information led to more photos, but most are of the front. Fortunately, I did finally find some of the trackside. Most of these are at shallow angles that make determining the location of window and doors a bit of a challenge,

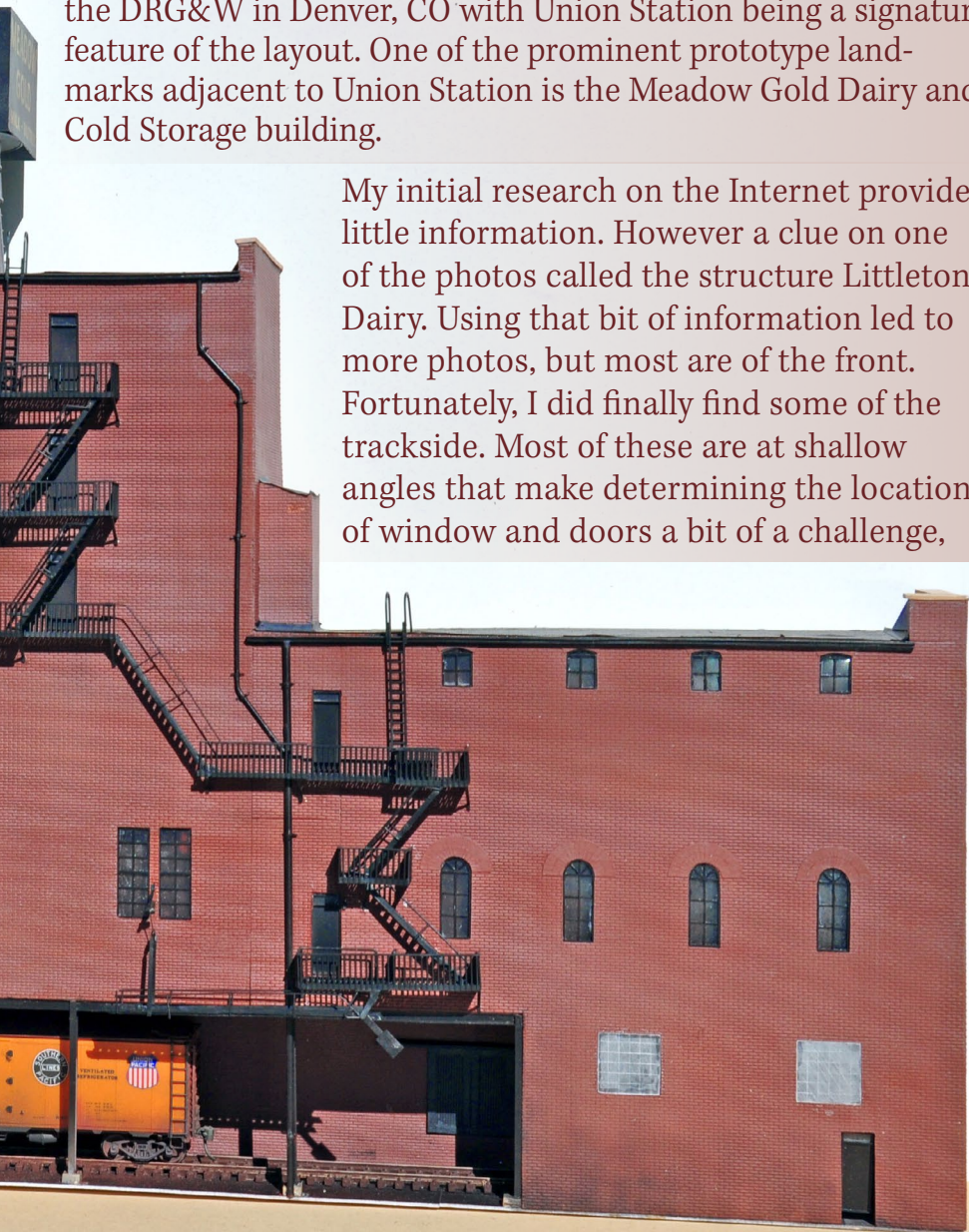

but not impossible. Using the photos, I developed plans to build the model to fit the available space, which is 3.5" x 26".



[Click here for reader comments](#)

A key consideration was to maintain the proportions the structure, matching those of the prototype. I was able to accomplish this by reducing the height of the model. The prototype is five stories tall on the sides, and I reduced these



1. A Burlington passenger train is waiting at the Denver Union Station for passengers to board. The Beatrice Foods (A.K.A Meadow Gold) building is in the background and the subject of this project.



2. Here is the poster board structure that represented Meadow Gold Dairy for too long and needed to be replaced.

areas to four stories.

While the prototype structure did not have rail service, modeler's license is the order of the day. One features on the prototype is what appears to be covered loading docks. I easily enlarged this area to accommodate reefers, while maintaining the appearance of the prototype. It also appears to have been constructed in two phases. The first phase appears to be the center, and right-hand wing. I arrived at this conclusion after noting steel columns supporting the area over the dock in the center and right-hand wing. The second is the left-hand wing, which has reinforced concrete construction.

I have been blessed to have AutoCAD for my drawing needs for many years. So I was off to the races developing the plans. When I was satisfied with the proportions and



3. The initial attempts to glue the outer 2" x 4" to form the arch failed until I induced some curvature into the 2" x 4". I found holding the piece with self-locking tweezers as shown overnight put enough curvature into the piece for the result I needed.

overall appearance of the structure, I printed a copy of the drawing for Jim's approval.

Getting started

With approval, construction of the structure commenced. I began construction with the windows. I know that this is odd, but since I had decided to scratchbuild the arched windows I needed to know if what I had in mind would work. If it didn't then I would have to backtrack and use commercial windows, and adjust the plans accordingly.

I printed copies of the windows from that portion of the structure to scale. This is very easily done with AutoCAD. Don't worry if you do not have access to a CAD program.

I printed a sheet of paper with eight windows on it. I need only six each of the arched and semicircle windows. I added the extras so that I could have some spares if one didn't turn out right, or if I managed to break one while installing it (which I did).

I did not originate the methodology, but I have found that it works very well. I begin by cutting the window

MEADOWGOLD DAIRY | 6

mullions to size. I use 2" x 4" styrene for the vertical center, top, and bottom mullions of the rectangular sections. The remainder of the mullions I cut from 2" x 2" styrene. Once I have cut enough stock, I spray the drawing with 3M spray mount adhesive, letting it sit for at least five minutes.

The wait time allows the adhesive to become tacky. It also reduces the adhesive's ability to glue things together, which is what I need. The adhesive acts as a clamp or third hand to hold the pieces in place. Also, you don't need to do everything in one setting. The adhesive will remain tacky for almost a week, so you can come back later to finish.

After the adhesive is tacky, I began placing the 2" x 4" vertical mullions on the drawing, followed immediately with the 2" x 4" horizontal mullions. By accurately placing the pieces over the drawing, I end up with square windows.

With the 2" x 4" mullions placed, I filled in the remaining mullions with the 2" x 2" pieces. I did not attempt to cut the mullions to the correct size at the top of the arch, but just let them run over the edge of the arch, trimming them to length once the glue had dried. With all of the pieces in place I use MEK to cement the pieces together. So far so good; that was the easy part.

Now it was onto the outer frame of the windows. Here I was stepping out into new territory. I have used this method to date only on rectangular or square windows. I cut some 2" x 4" styrene longer than I needed and cemented it to one side of the window.

After the cement had set, I stretched the styrene around the window using the drawing and the mullions as a guide. So good so far. I started to work my way around the arch, cementing

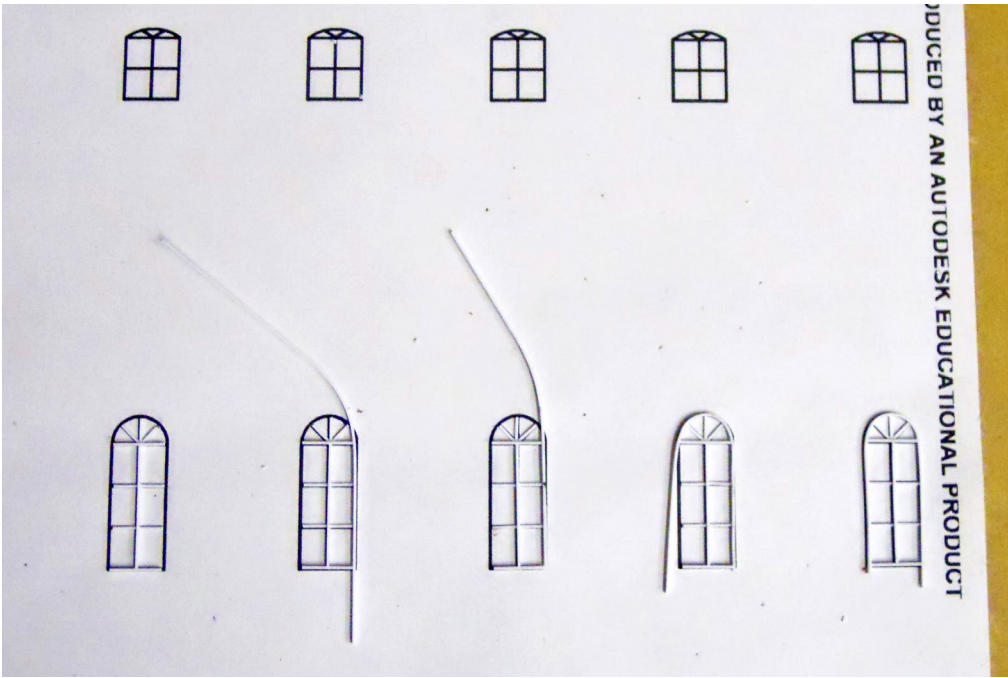

4. The drawing that I used to build the windows. As can be seen in this photo, there are 5 windows in various stages of construction.

the frame to the mullions – and snap! The instant I touched the curved portion of the styrene with the MEK, it snapped.

I cut away the broken styrene from the mullions and tried again. I ending up with the same results. After taking a few moments to think about the problem, I decided that I should try to induce some curvature into the styrene first. I did this by wrapping a piece of the 2” x 4” frame material around my X-Acto knife handle. I held the styrene for what seemed like a long time, about 1½ songs on the radio.

I managed to induce some curvature into the styrene, but it wasn’t as much as I hoped. Anyway I gave it a try, and it worked! Off to the races, or so I thought. On my second attempt the 2” x

4" frame snapped again. I was frustrated but decided to give it one more try.

This time after wrapping the styrene around the X-Acto handle, I held it together with a pair of tweezers that remain in the closed position. I also used some small pinch clamps and anything else that I could find to hold the pieces together, and quit for the night.

I actually came back two days later. The 2" x 4" frames had some arc induced by holding them in the position. Now the question I had was would it work? It was the moment of truth again. Could I cement the frames to the interior mullions of the windows? Eureka! it was successful and I breathed a sigh of relief. I finished the outer frames to the windows and let the cement set.

Once I was confident that the cement had set, I began removing the windows from the paper. I used my X-Acto knife with a #11 blade to slice in-between the window and the paper. One of the minor drawbacks to this process is that you invariably have small amounts of the paper remain attached to the window.

Once the windows are removed, it's time to pick and gently pull away the attached paper. These windows are fairly delicate, so a light touch is required. During the cleanup I did not damage one window. After cleaning-up the windows, I placed them in a small container for safety. I saw no need to let them lie around the work area while I continued with the project.

Beginning the structure

With success at making the windows, I began laying out the structure. For this structure, I used .040" plain styrene that I have on hand. I had the good fortune many years ago to obtain some large sheets of styrene that were 12" x 12" for free. Even at this size, they are not large enough to build the structure out of one piece. I decided to divide the structure into its three natural

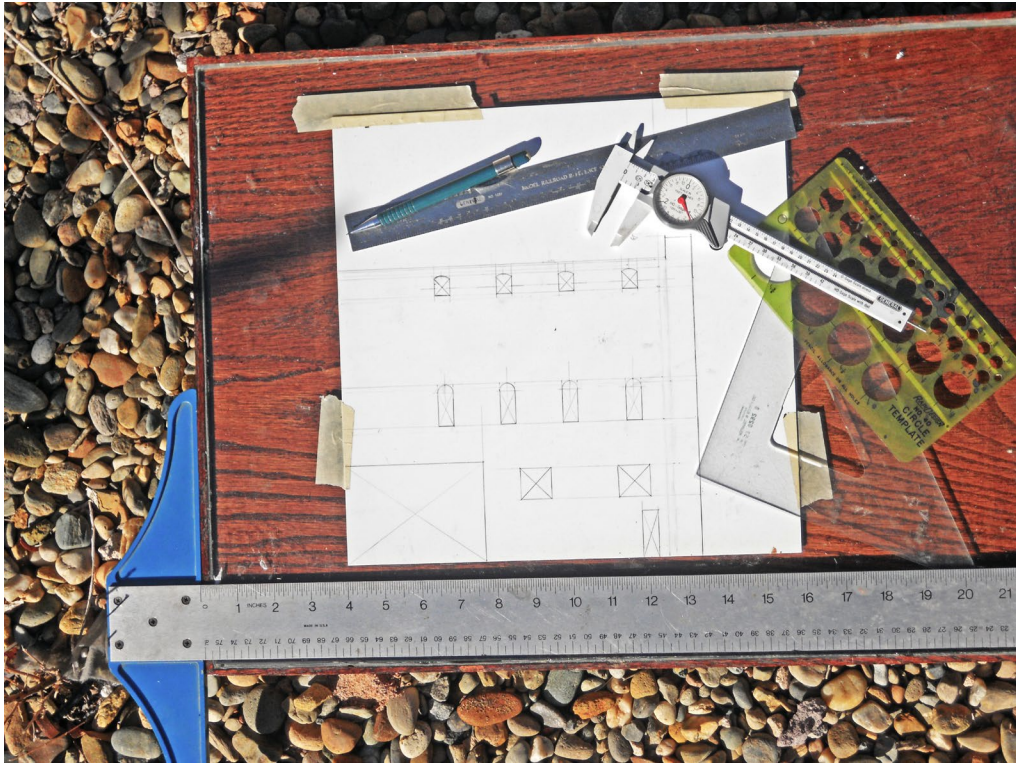

5. The tools that I use to lay out of the structure include T-square, triangle, circle template, scale, and calipers marked in HO scale feet and inches.

parts: the center, right and left wings. This will also serve well for application of the brick overlay, and it also makes it much easier for me to handle during construction.

I tape a piece of styrene to my work surface and lay out the doors, windows, edges of the walls, and anything else that defines that portion of the structure. I use my metal T-square, triangle, a mechanical pencil, and my calipers that are graduated in scale inches. I find that by using these tools and method I have a lot more accuracy. Once the layout is completed, with

MEADOWGOLD DAIRY | 10

the styrene still taped to the work surface, I use the same tools, except an aluminum triangle, to begin cutting out the windows and doors.

To make the arches, I used my circle template. Due to the strong probability of cutting the plastic template, I reversed the X-Acto blade and scratched the arc into the styrene. Hindsight being 20/20, I should have used my dividers to scribe the arc, but I didn't think of it at the time. I did use them to make the arched brick over the window a little later.

Prior to removing the styrene from the work surface, I remark the arc with a pencil and my circle template. That way I have a line to work to for clean up. I find that its much easier to re-establish the arc prior to removing the styrene, but not impossible to do after the fact. I also take time to place an X at every location where a window or door is to be removed, it clarifies the areas to be removed.

I began cutting out the windows and doors by making all the cuts that define the openings. On the arched windows I made a horizontal cut across the window at the end of the arc. I also make the diagonal cuts in each opening. This aids in snapping the plastic to remove it from the window or door opening.

On the arched windows, once I had removed the main portion of the window, I used my rail nippers to cut slots up to the top of the arc. After that, I snapped off the individual pieces with a pair of pliers. This method provides a rough arc for the windows. Once all of the windows and doors had been opened up, it was time to do the final cleanup with files. The other two sections were cut out the same way. The three sections make the face of the structure.

Sides and roof

Next to the sides and roofs. All these pieces were cut to a width of 24'-6". The sides of the center portion are simple; there are no windows, so it is a matter of cutting rectangles of the appropriate length. The same was true for the roof sections. On the end of the right-hand wing, I constructed a truck dock. Given the narrow space available, I was able to still provide room for two trucks. I also cut out the two windows on each level to match those on the main face of the right-hand wing.

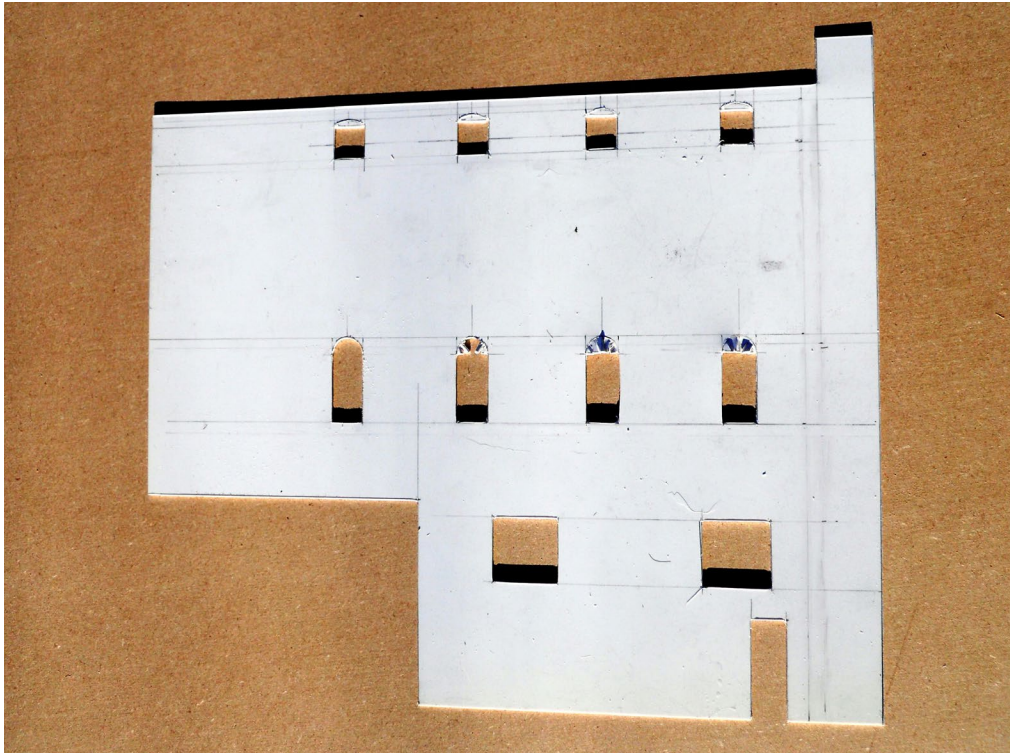

6. The windows and doors for the right hand wing have been cut out and the arches are beginning to be removed on the lower level windows.

MEADOWGOLD DAIRY | 12

On the left-hand wing, the opening was cut large enough to handle the reefers. I also cut the opening 30” wider than the NMRA clearance gauge to allow for the width of the concrete columns that will support that portion of the structure. I also cut windows along the top of the end that matches those at the top of the left wing.

When cutting out the windows for either wing, I took care to make sure that the windows lined up horizontally. Since the windows are on the same floor, this is important. It is one of

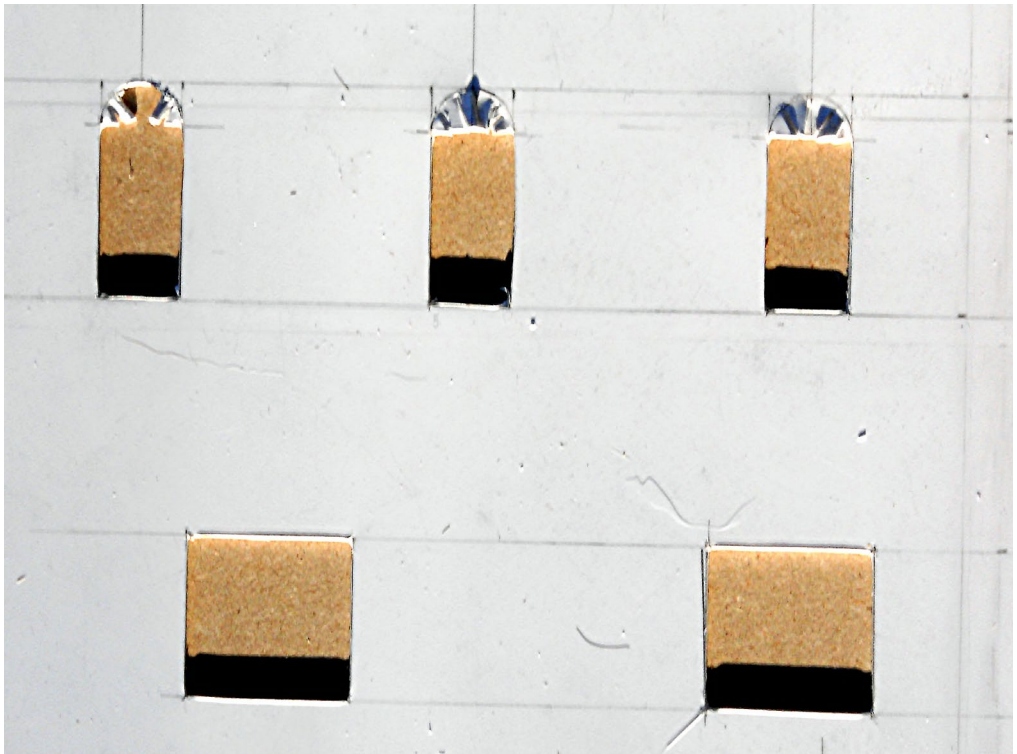

7. I used flush cutting nippers to make small cuts up to the line of the arc creating numerous little triangles. I used an X-Acto knife to cut off the small triangles

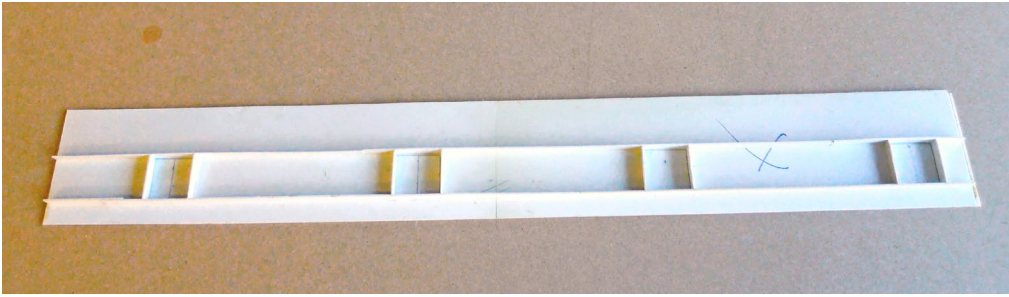

8. The rail dock wall with doors cut open. I had initially thought about building the doors on the inside of the wall. I built the openings to model the wall thickness. I ended up putting the doors on the outside so they were not needed.

those little details that can be easily overlooked. However when you look at the finished structure, your eyes would notice that something just isn't quite right.

The lower windows are paired in the center section of the structure. I decided it would be easier to cut out the opening for both windows. I was concerned that with the normal scribe-and-snap methodology, the center pieces would become warped, and warped brick walls just don't look right. Prior to covering the side with brick, I cemented a 4' x12" in the center of the window. The methodology works great.

With the sides and roofs completed, I turned my attention to the last few pieces to make the shell. The first was the back wall for the reefer loading area. I cut two strips 22'-6" tall. These were laid end-to-end and taped to my work surface for layout of the doors. The doors are 8' x 8' and spaced 45' on center. The bottom of the door is 3'-9" above the rail head, the same height has a boxcar or reefer floor.



9. Once all of the parts have been cut and the window and door openings made, I temporarily taped the walls together to make sure everything would fit. I also took the model over to its future home and set it in place. This gave Jim and me an opportunity to study the structure in its final location. This is an important step that allowed us to determine if the proposed structure would actually be a fit both physically and visually and to make any needed adjustments before investing a lot of effort in construction.

Using my T-square and triangle for layout and cutting, I cut the door openings. The finished length of the wall is 169'-9". I used some of the leftover piece to make the end wall for the reefer track. The end wall was cut to a length of 24'-6" as the other ends. I did this just to provide continuity to the back of the structure, which rests against the backdrop.

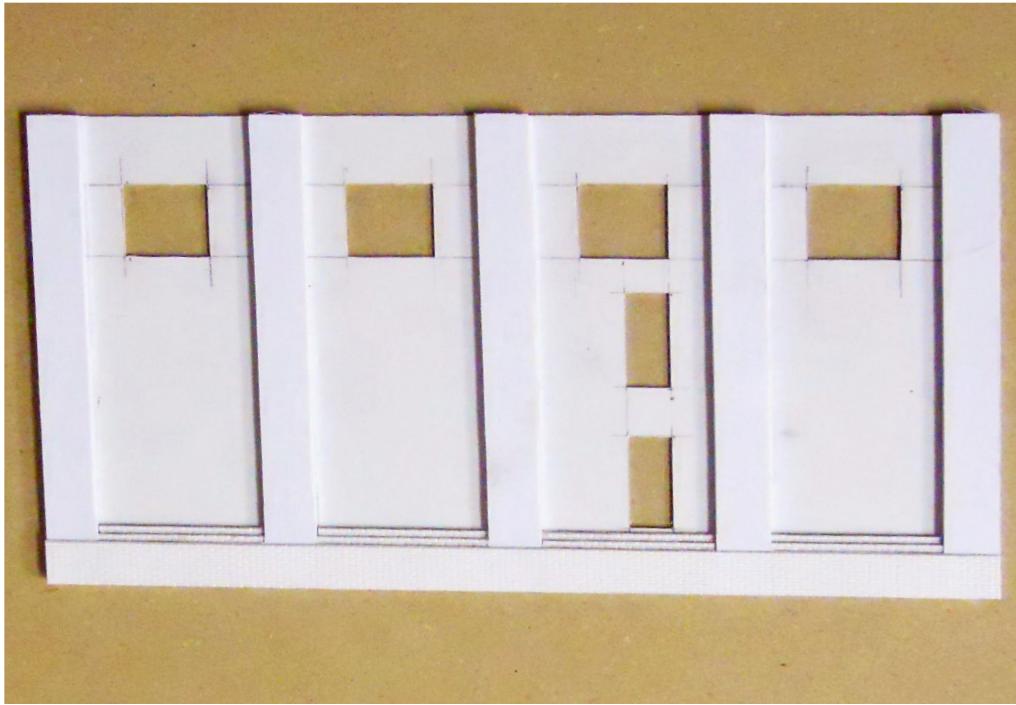

10. The left-hand wing pilasters are being built. The pilasters are made up from three layers of .040" styrene creating a thickness of approximately 12".The pieces across the top will be added after the brick sheeting has been added into the fields.

The roof of the rail dock was pieced together from various left over parts from previous cuts. I saw no need to cut into a new piece of styrene when the leftovers could be made to work. Lastly I cut out the back face of the truck dock and the roof of the truck dock following the same procedures as before.

With this last little bit done, I took time to tape the components together. This gave me an opportunity to see if I missed anything major before I went any further. I also took time to take the taped model over to its future home, giving Jim and me a chance to

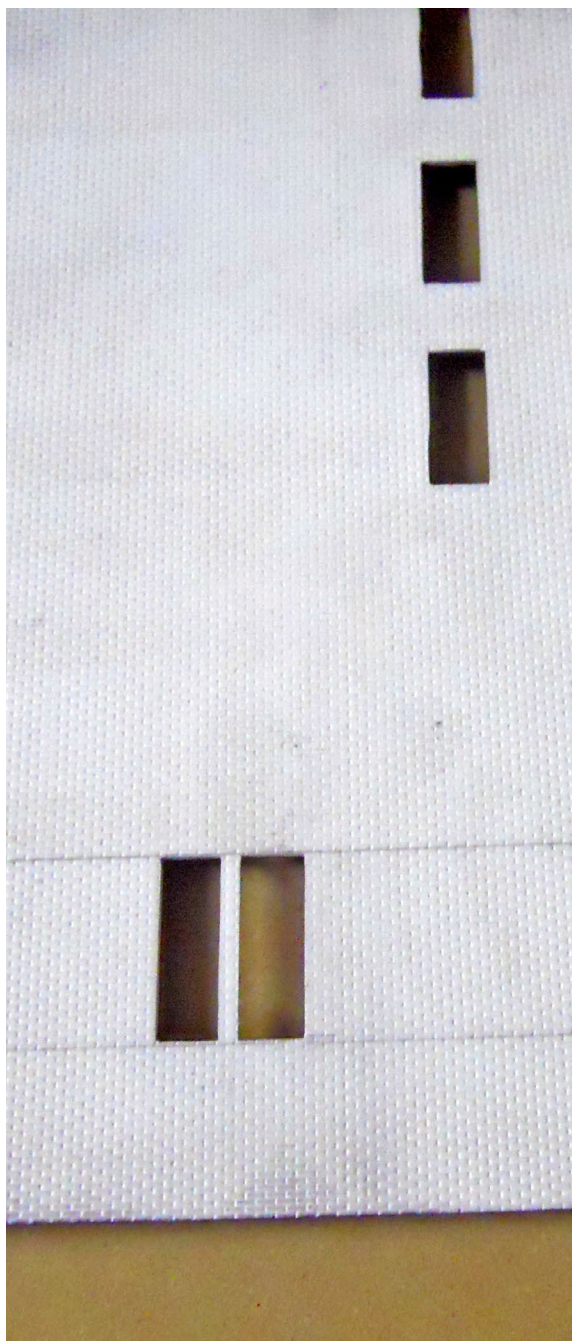

look over the structure in place. While the structure is massive, it is proportioned well and fits nicely into its future home.

Adding the pilasters

The brick sheeting I used has bricks that measure about 6" x 12". I based all the column dimensions off this brick size, making sure everything was divisible by six, or half a brick. On the left-hand wing, the wall panels are inset

11. I added 4" x 12" stock to the large openings in the center section to make paired windows. This gives a much neater center column instead of trying to leave it in place while cutting out the windows.

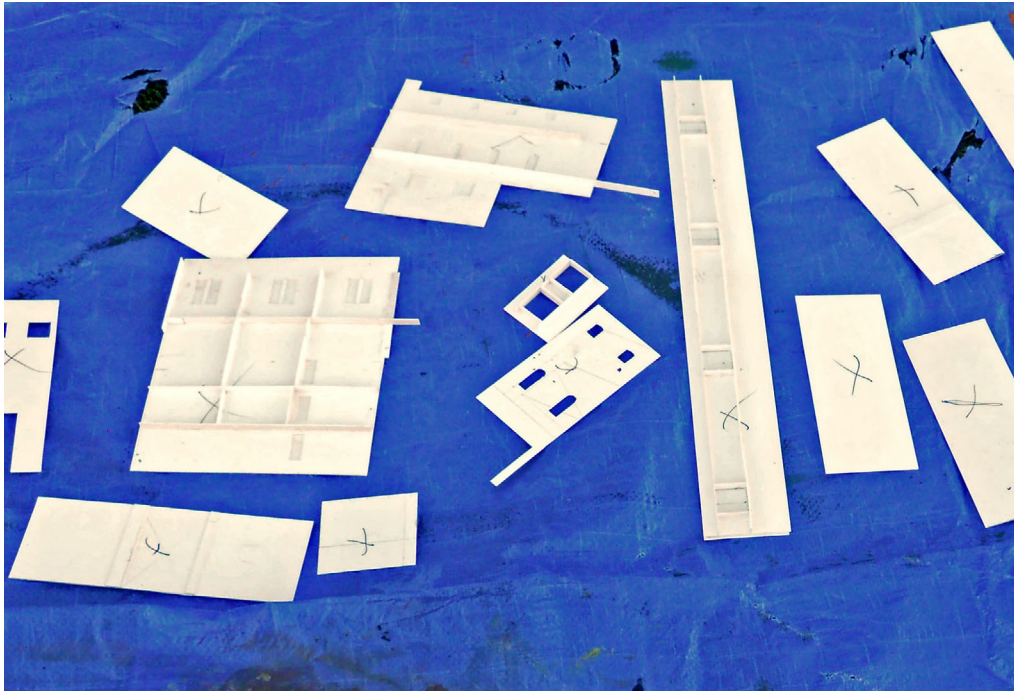

12. Prior to applying the brick sheathing, I put all of the parts on a plastic tarp and painted the insides black.

between the concrete columns. My best guesstimate is that the walls set-in 9" to 12" from the face of the columns. I made the columns from strips of 0.040" styrene that I cut to a width of 4'-6" Three pieces are needed for each column, building them to a thickness of 12".

I set the two end columns first. Next I located the center column and cemented it in place. The final two columns were then centered between the center and end columns. It is critical that the columns are square with the ends. If they are slightly off, it will be noticeable with the brick lines.

With the columns in place, it was time to fill in the top and

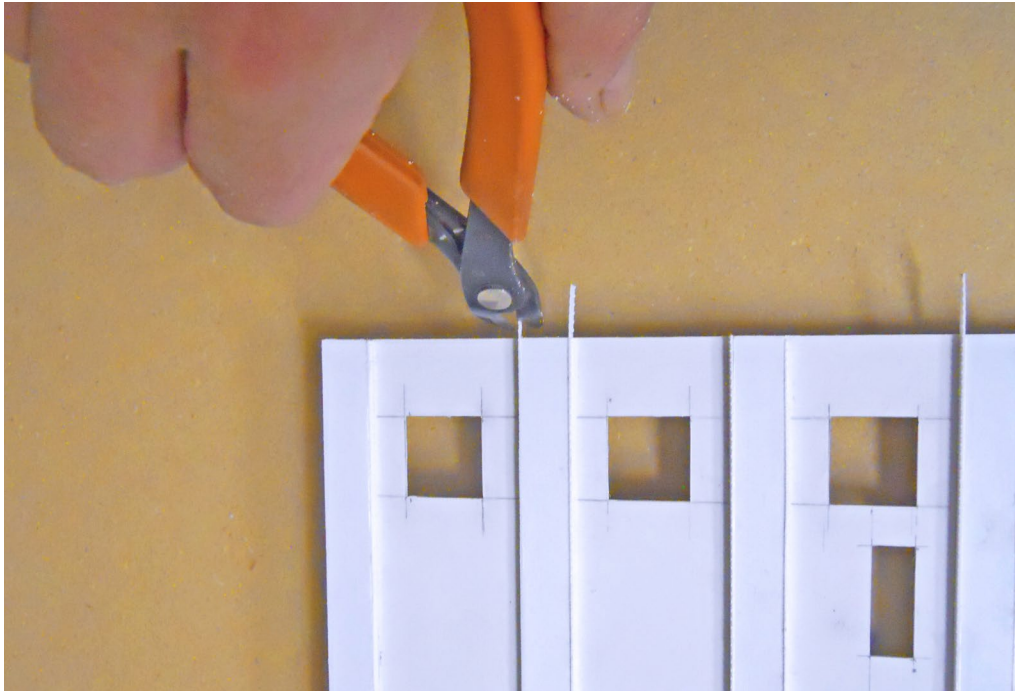

13. I began by adding the 12" wide vertical pieces of brick to the inside of the pilasters. I cut the pieces long, and trimmed them to fit.

bottom of the wall. I began with the lower section by cutting a strip of styrene 8' wide. Four pieces were cut to fit in-between the columns. I cut another strip at 6' and fit it in-between the columns like the first. This will allow for a two-brick-high step. The final strip is 4' high. At the top, the same process was followed but the strips were 24", 18", and 12" wide

Brick facing for the substructure

With all of the substructure complete, it's time to begin facing the structure with the brick sheeting. The sheeting is styrene and adheres to the styrene structure nicely. Given the large

MEADOWGOLD DAIRY | 19

areas to be covered, I didn't think that using my normal solvent would be a good idea. I wasn't sure it would be possible to make a good bond, since the solvent would evaporate too quickly. I instead used Pliobond thinned with MEK to make a contact cement wash. The process works great, and I will use it the next time I have a large area to cover.

I began covering the large center and right sections first. I didn't worry about covering over the door and window openings. They will be cut out later from the back side. Next I covered the rail loading doors and loading dock doors along with any end walls

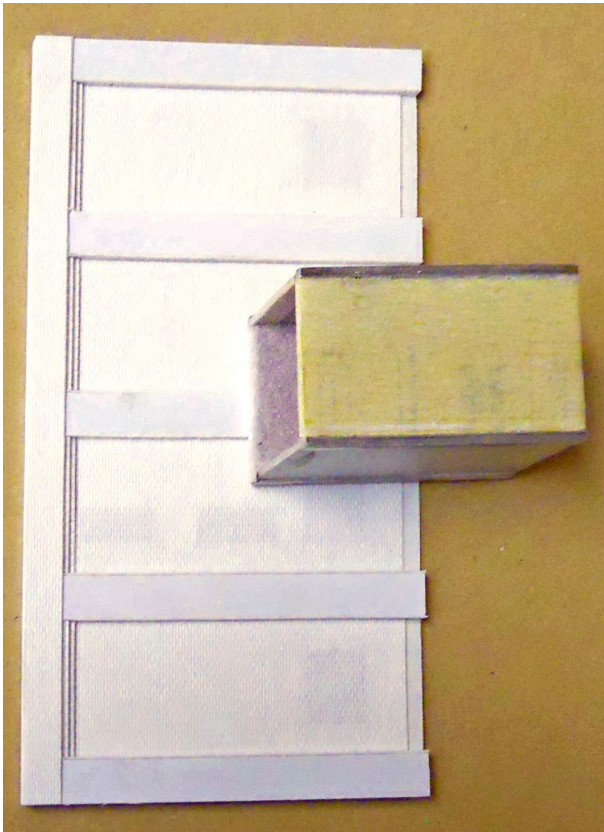

14. After I had applied the small vertical brick sheeting, I sanded them down to match the thickness of the pilasters.

with an interior corner.

Next I began facing the left section of the building. I started by facing the vertical faces of the stepped brick. The lower steps are two bricks wide. The upper step is just one brick wide. With the vertical face covered, I faced the inside edges of the pilasters. To make sure that the mortar joints would line up, I used a piece of the brick sheeting to mark where the mortar lines will end up on the face of the pilaster.

Knowing where the mortar line was, I trimmed the brick

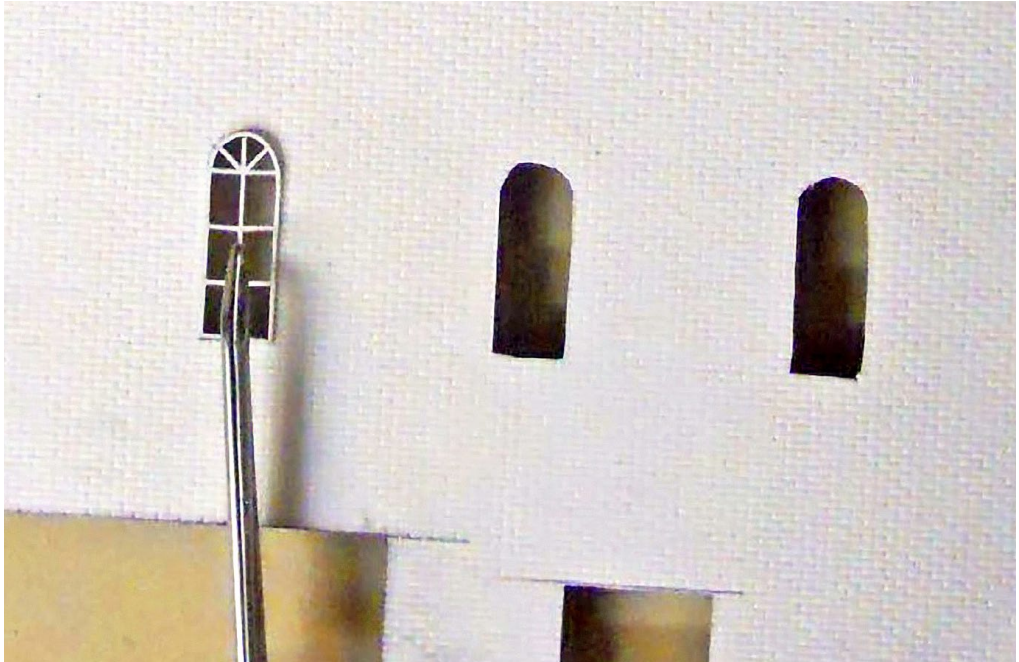

15. Here I'm fitting the arched windows. This was a file-and-trial fit process, until each window had a nice snug fit. Since no two windows were exactly the same, I numbered each one so I could put it back in the opening to which it was custom-fitted.

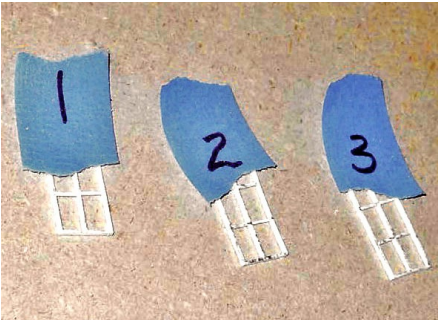

16. Since no two windows are exactly the same, I numbered each one so I could put it back in the openings they I had adjusted them to fit into.

to allow for the thickness of the 0.040” styrene. The end walls are cemented to the inside of the structure, so the sheeting has to extend past the edge. The key is to place the brick sheeting on the ends so that a half-brick lines up with a full brick on the face and vice-versa. If in doubt, look at a brick wall and you will see what I mean.

With all of the brick sheeting complete except for the parapets, I took time to add bracing to the back of all the walls. I made sure the bracing extended past the joints so that when they were cemented to the next piece, I would end up with a strong wall. Butt-joints just won't make it. After the bracing was complete I sprayed the inside of the structure with an inexpensive flat back paint.

The doors and windows

Now it was time to begin opening up the doors and windows. I began with the arched windows I had made. Since they are not exactly the same, I roughed-out the opening and then

sheeting to fit around the steps. Once all of these pieces were in place, I put the horizontal brick surfaces on. By using this procedure, I was able to cover any imperfections I had on the pieces that were trimmed to fit around the steps. After that, it was just a matter of filling in the fields as I had done on the main sections.

Now to the end walls that have an exterior corner. Here I had

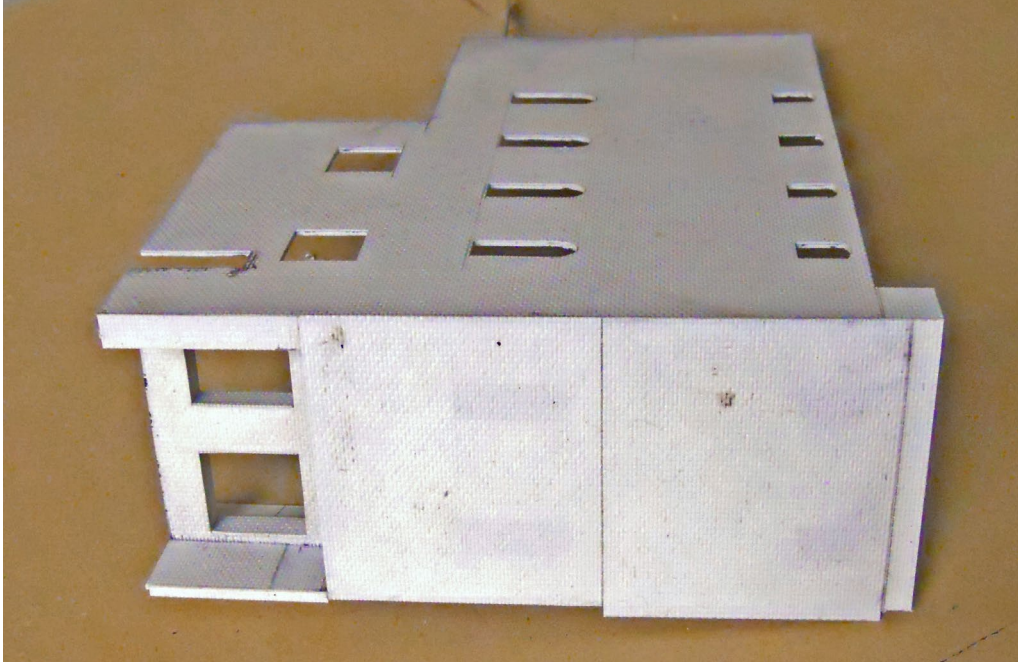

17. The right wing of the structure is beginning to come together. The window openings on this side have not been cut through the brick lamination from the inside yet.

filed it to match the window. Once I was satisfied with the fit, I placed the window on a piece of tape that was numbered to match the window.

The windows in the center and left-hand sections were made from City Classics factory windows that I cut down to size. I should mention that the window openings on these sections were designed around these windows.

With all of the window openings finished, I used a triangular file to carry the mortar lines around into the window opening, giving the impression that the bricks line the window opening.

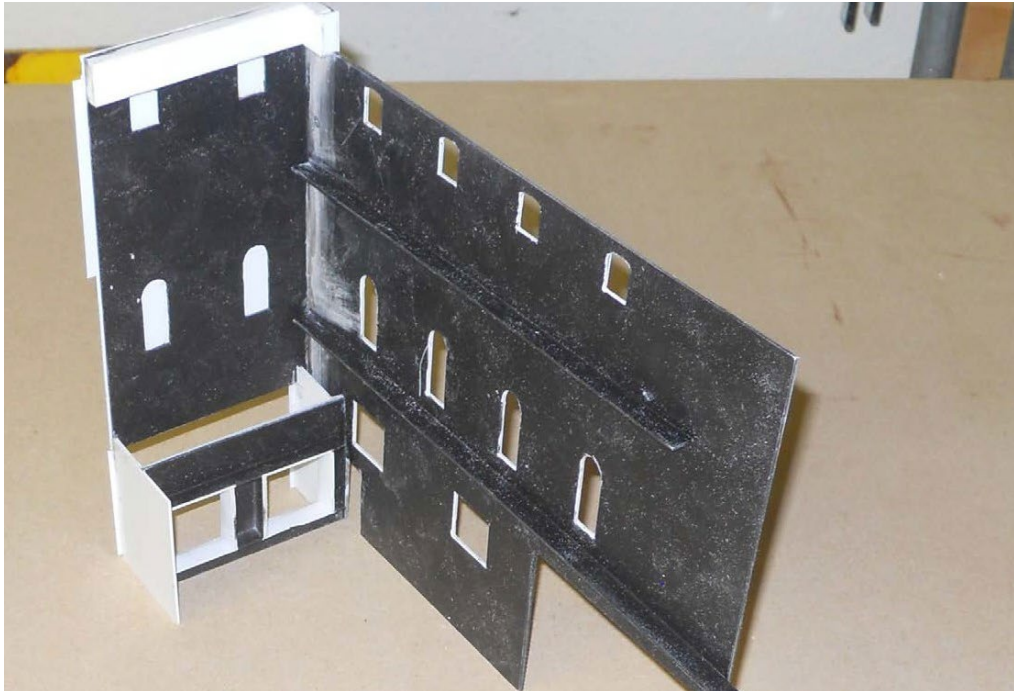

18. An inside view of the right wing. I added bracing to prevent warping of the sides. I also allowed for the bracing to overlap the joint between the sections to add strength to the structure.

Arched window header

Now to the brick arches. I made the arches from 0.010" styrene taped to my work surface. I began by drawing a line that would serve as a base for the arches. I then took my dividers and set them for the inside radius of the opening, and lightly scribed an arc.



19. One of the scribed brick arches cut from the stock sheet.

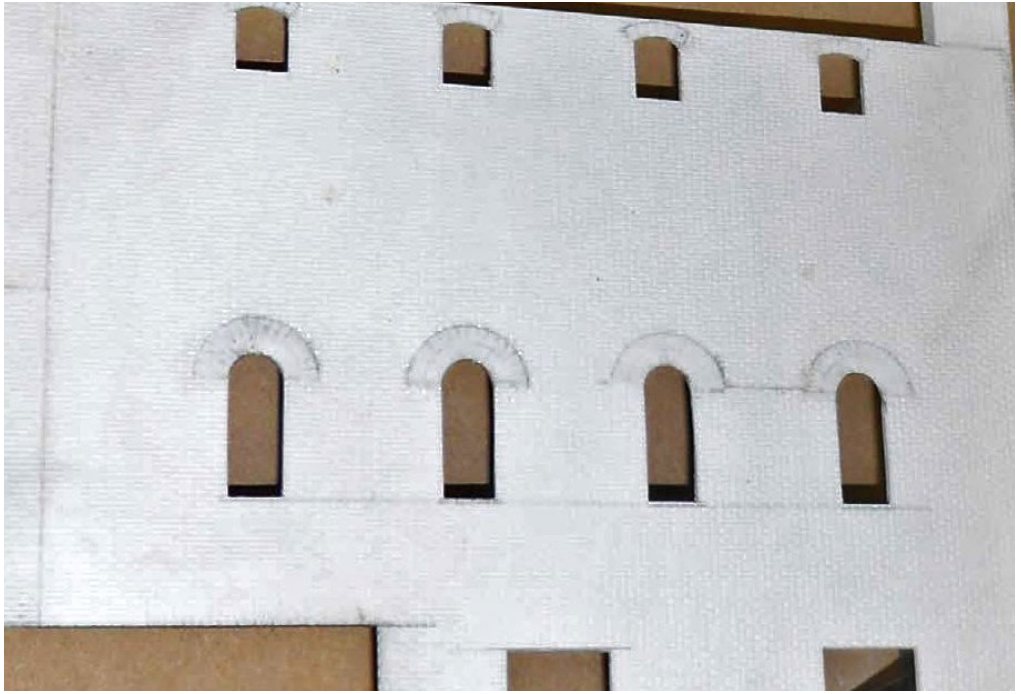

20. The brick header arches are added to the brick sheeting. The thickness of the material adds depth to the arches and helps them to stand out.

After scribing all the arcs, I increased the radius by 12” and repeated the process. I did this one more time, making two complete courses of header bricks.

Next with the dividers at 12”, I started at the top-center of the arch and walked my way around the outer arc until I got to the bottom. I repeated this, but went down the other side of the arc. While stepping my way around the arc, I used enough pressure to create a dimple in the styrene.

With the dimples marked, I used a straightedge and the backside of my X-Acto blade to scribe the mortar lines. The straightedge

was aligned with the center of the arc and a dimple. While not the most elaborate header, it looks good on an industrial building.

After I finished scribing the mortar joints, I reset the dividers to the largest outside radius, swinging consecutive arcs until I had cut through the styrene. The process was repeated on the inside arc. Lastly, the ends of the header were cut free from the styrene sheet, and then cemented over the window openings.

With the brickwork complete I used a spray can of dark brown Rustoleum Painters Touch Ultra Cover 2X satin finish. Once the paint was dry, a wash of white paint was applied to represent the mortar.

Doors

The dock doors are made from 0.020" car-siding. 2" x 6" styrene was framed around the edges of the car-siding. Two pieces of the 2" x 6" stock were centered down the door. This gives the appearance of two separate sliding doors.

I made the hanging door track by cementing a piece of 6" x 6" angle to a 2" x 12". I added a piece of 0.020" rod to the front of the angle. This adds a bit of architectural detail that would have been common on older buildings.

By turning the door track upside-down, I had my gutters for the roof. Short pieces of 1" x 4" stock were cut at a 45° angle on one end to make the bracket that mounts to the door. Once the assemblies were complete, I set them aside for painting.

The last set of doors to be made were the fire escape doors. I made the door frames from 2" x 4" styrene. I added a small transom window over the top of the doors to add a nice touch. The door frames were made in the same manner I made the windows.

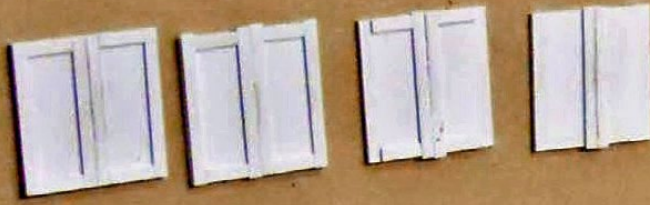

21. The dock doors, construction is from right to left.

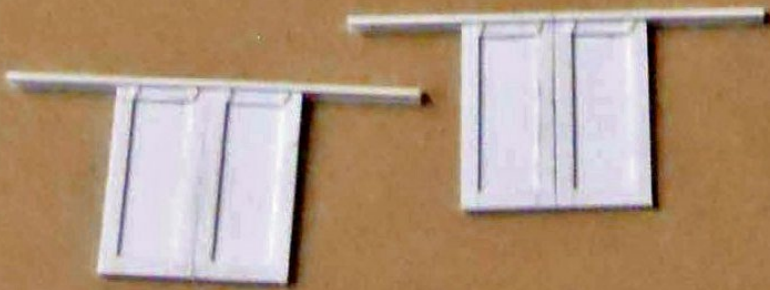

22. The doors are cemented to the door track prior to painting.



23. The completed dock roof with I beams placed in the locations of the columns. I heavily weathered the roof to represent years of loco exhaust blasting against it.

Once the frames were dry, I added a piece of 0.020" styrene to the back. I made the door larger than the opening. That way I could just cement it to the inside of the sub structure.

Putting the structure together

Now it was time to put the pieces together. Here is where having a CAD program really pays off. With everything dimensioned, the pieces fit together nicely. Prior to cementing any of the pieces together, I made sure I had the mortar lines in alignment. I didn't worry about the vertical line between the pieces. Brick walls need to have expansion joints, so my vertical lines are the expansion joints. Problem solved.

I began by putting together the pieces that make up the right and center sections first. I scraped off the paint where my bracing overlapped so that I could get a good strong bond. I also added scrap pieces over the joint to provide for additional strength.

The truck dock end and the ends of the center section were added. I also added the roofs to the right and center sections. I needed to strengthen the building. While the structure has a flat roof, it does need some slope to get the water to drain. So I made sure the roof pitched a little toward the front. The slope is noticeable when you see it against the mortar lines.

I then put together the wall with the rail doors and its roof. The roof is two parts. For the first section, I put in 4" x 12" floor joists that run the length of the steel supports, and painted them flat black. The second is just plain styrene that I painted a concrete color. Prior to mating it with the wall, I heavily weathered it with grimy black and weathered black to represent soot from locomotive exhaust.

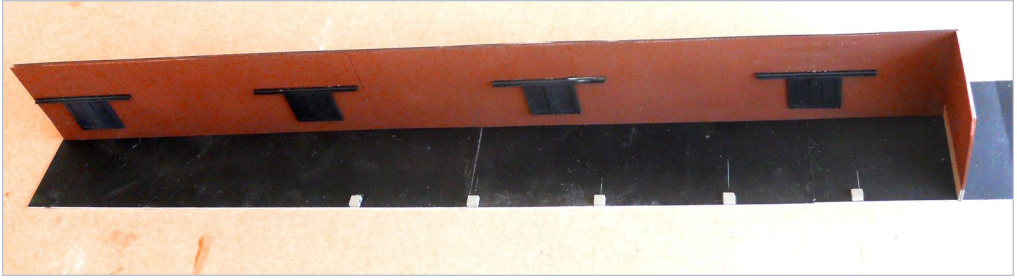

24. The dock walls have been cemented to the floor. The gray squares are the foundations for the steel columns.

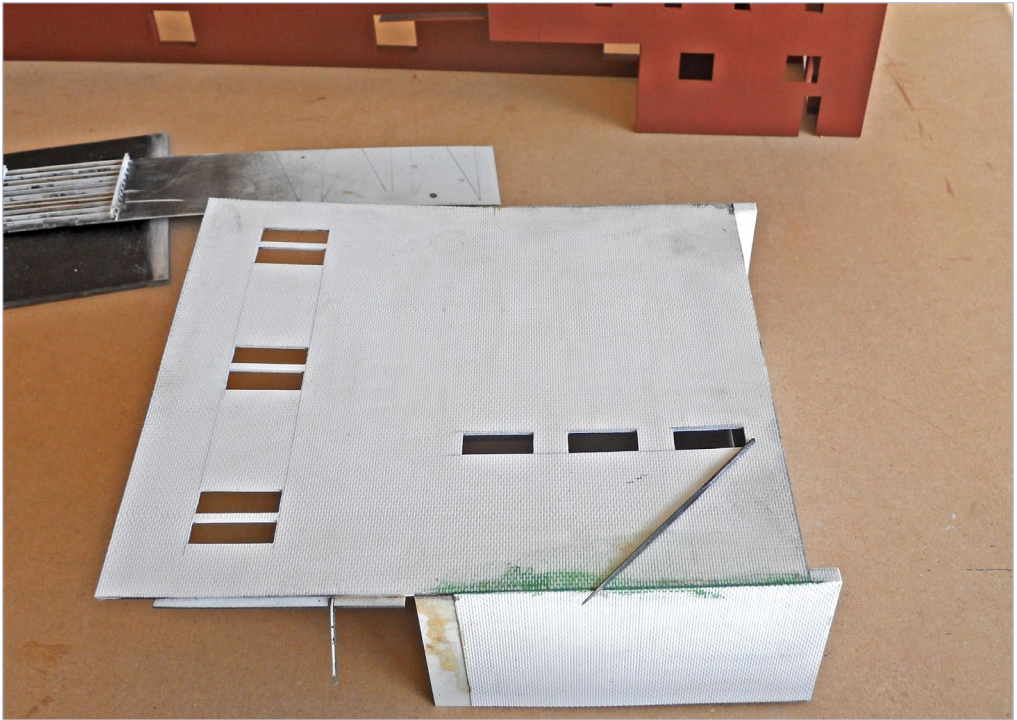

25. The center section has had the brick sheeting applied. I used Squadron Green on the corners to clean-up the joint. Each mortar line needs to be aligned around the corner. This is a tedious procedure, but it's one of the details that adds to the appearance of the building. The right side of the building can be seen in the background.

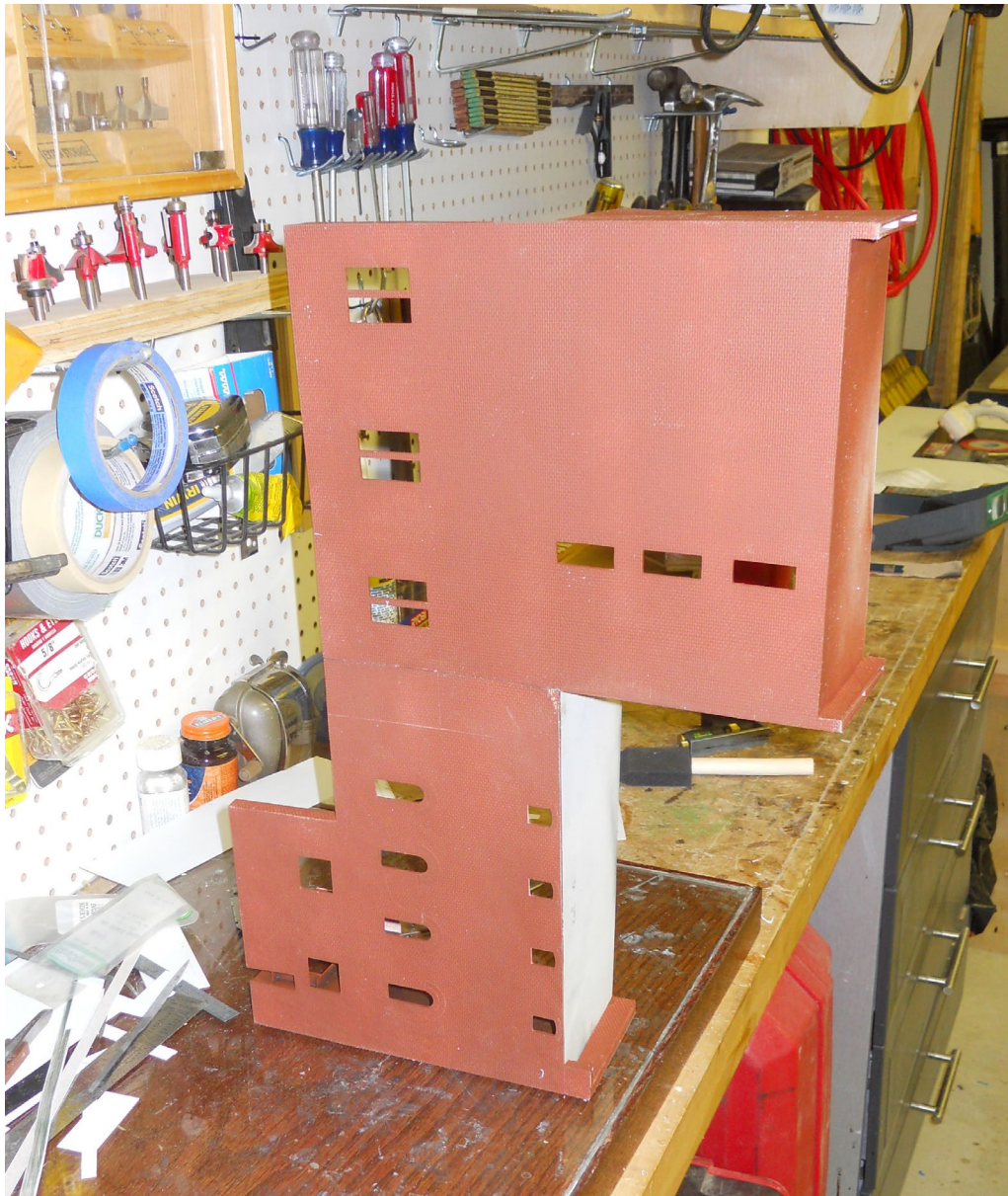

26. The center section has been cemented to the right wing. The structure is becoming rather large and awkward at this point, requiring a little creativity to glue things together.



27. The rail dock sub-section is being mated with the right wing and center section. To ensure a good joint I used a 2' steel level and some of my woodworking clamps to align the pieces and hold them in place until the glue had dried overnight.

I cemented the rail dock roof to the dock wall and the dock end wall. Once the cement for this section set, I cemented it to the front wall, adding reinforcement to the joint.

At this point of the project I had one of those I had better do this moments. I realized that I should make a floor for the structure.

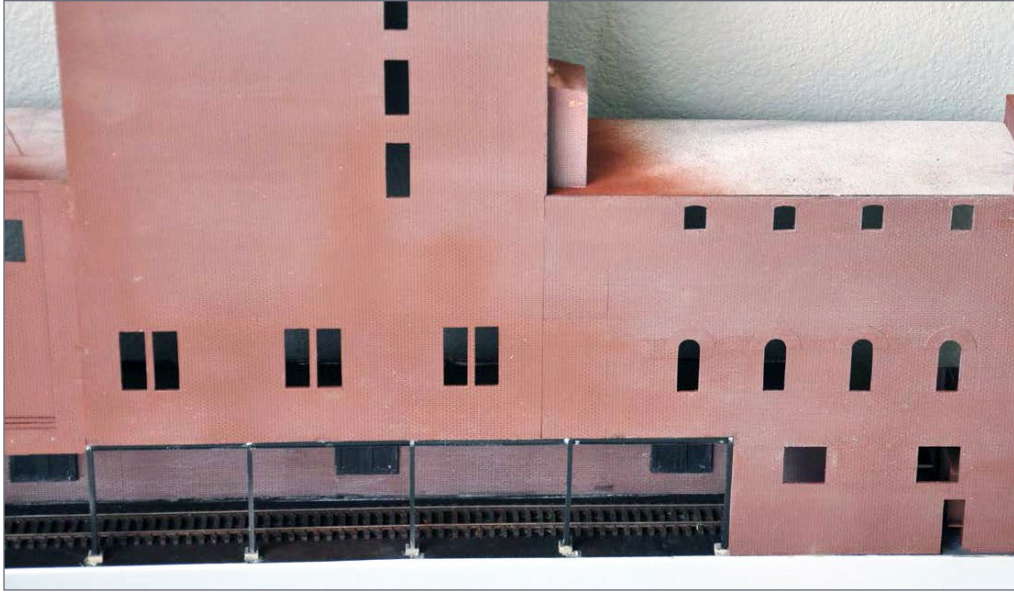

28. The steel columns are installed to keep the building from falling over. With the addition of the rail dock, the structure is front heavy and can't stand up without these columns.



29. To construct the concrete columns, I cut strips of .040" styrene 24" wide and cut to length. I then faced the center section with .030" styrene at a width of 30". I filed the columns and chamfered the corners to represent standard concrete construction practice.

I cut some 0.040" and painted it flat black. I also added a piece of code 83 flex track, I didn't have any code 70 handy or I would have used it, I figured that it would be easier now than later.

Once the base was ready, I laid the model face-down and cemented the base to the front and to the dock wall. Then I attached the end walls.

This assembly was a bit tricky since I needed to make sure that the mortar lines matched, as well as having the proper brick faces and ends match. Once I was satisfied with the alignment, I cemented the end to the face.

Now that the structure was assembled, I gave it another coat of the Rustoleum brown paint.

The structure needs to lie on its back for now. The majority of its weight hangs over the rail dock, and it wants to bend out that way. It needs to have the columns to support it.

Concrete and steel columns & steel beams

The concrete columns are 30" x 30" and made from 0.040" styrene. Strips 22" wide were made for the inside spacing. The out-facing pieces are 30" at the base, and flare out to 40" at the top. A detail that is commonly missed when modeling concrete are the chamfers. The chamfer is a small bevel on each corner. Once they were finished, I painted them with weathered concrete.

The steel columns are made from Evergreen 3/16" I-beam. The columns are set so the depth of the column faces the building. The steel columns rest on a foundation made from styrene.

Prototypical practice is to have a bearing plate for the column to sit on. I represented this by cementing a small flat piece of styrene to the bottom of each column.

I used Evergreen 1/8" I-beam material to fit between the columns. I should mention that prior to cementing any of the steel beams in place, I painted them black.

Installing the windows and other details

With the columns in place, I began installing the windows. The arched windows were matched with the appropriate opening. I also set the windows in, aligning the back of the window to the back of the substructure. With all of the windows placed, 0.005" clear styrene was used for glazing behind each window.

I made boxes to be placed behind each to avoid being able to see the backdrop through the building. Once the boxes were made, I painted them dark brown. I find that the dark brown gives a better illusion of something inside than black. The difference is subtle, but noticeable.

The prototype has glass block windows on the one end. To replicate this type of window I sanded 0.010" clear styrene with 600 grit wet/dry sandpaper. By lightly sanding, I was able to achieve the cloudy look of the glass block. I taped the glass to my work surface and scribed the mortar lines for the block. The mortar lines were scribed at intervals so that I would have whole blocks in the opening.

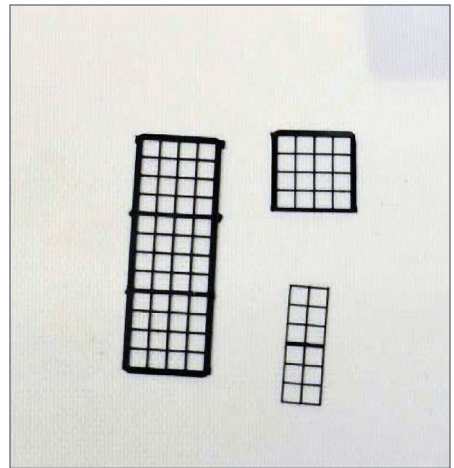

30. City Classics windows are cut down to size and are used in the center and left hand wing of the structure.

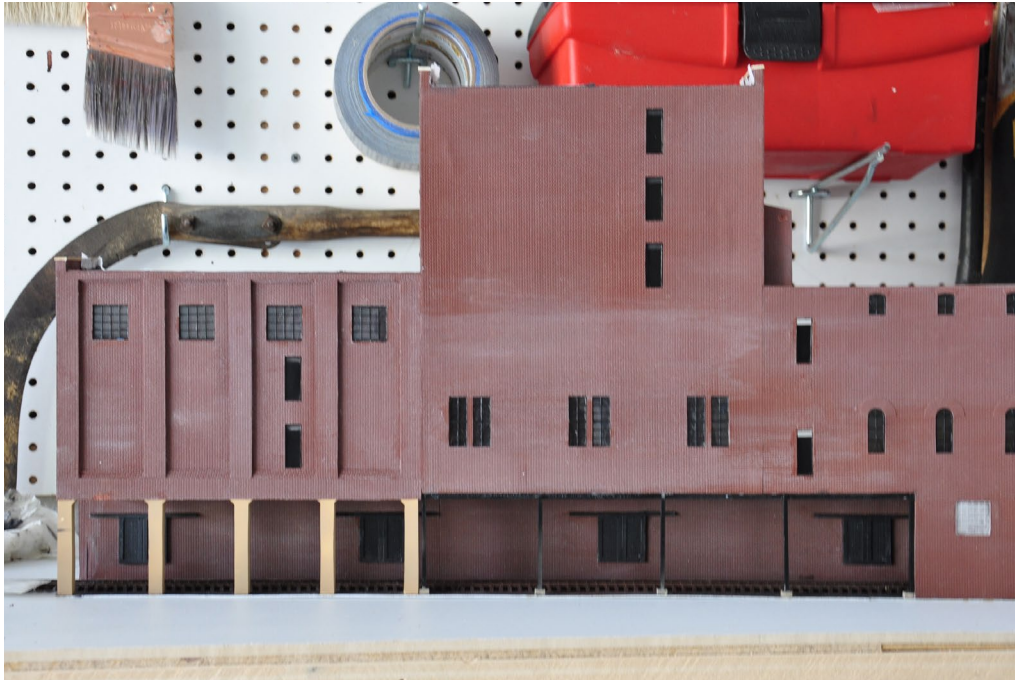

31. The building has taken shape. Now its time to begin adding the details. Some of the windows and doors are all ready in place.

One feature often missing on models are gutters and downspouts. I began by cementing a piece of 6" x 6" angle to a 2" x 10". The 2" x 10" is the back of the gutter. I added a piece of 0.020" rod to the front of the angle. This adds a bit of architectural detail that would have been common on older buildings. The gutter was painted black prior to cementing it to the building.

I made the downspouts from 3/32" and 1/8" styrene rod. I laid the downspouts on the building to determine their locations and runs. The anchors are 0.010" x 0.030" brass strip cemented with ACC to the rods. I began by bending the brass strips over the rod. The anchors are placed at key locations where the



32. I built the gutter up from sections of styrene as shown here. It's finished and ready for painting.

bends are and the joints would be. Once the cement had set, I bent the anchors out 90° from the rod, and trimmed to length. After painting, the downspouts were cemented into place.

What can I say – the fire escapes, while they are a very nice detail, can try your patience as you add them to the building. When adding the fire escapes it's important to make sure that the platform areas are horizontal, and the platforms are in alignment vertically.

The fire escapes are Walthers old-time fire escapes. The building uses five kits for the two separate escapes. I put together several sections of the kits, and began laying them out on the building. This was a cut-and-fit process. My spacing turned out to be one step less than than the kit.

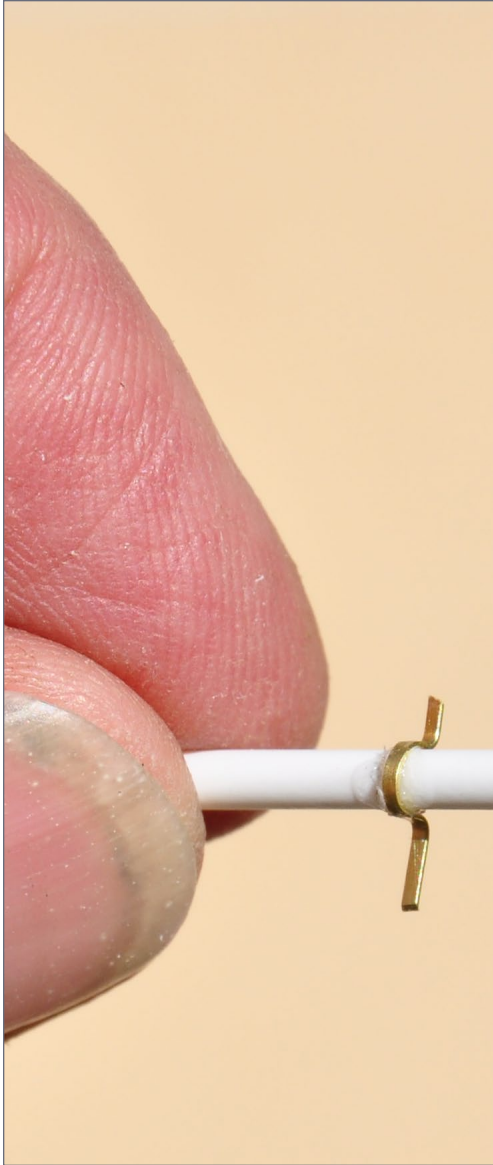

33. I made the downspouts from styrene rod with .010" x .030" brass strips added for the mounting brackets.

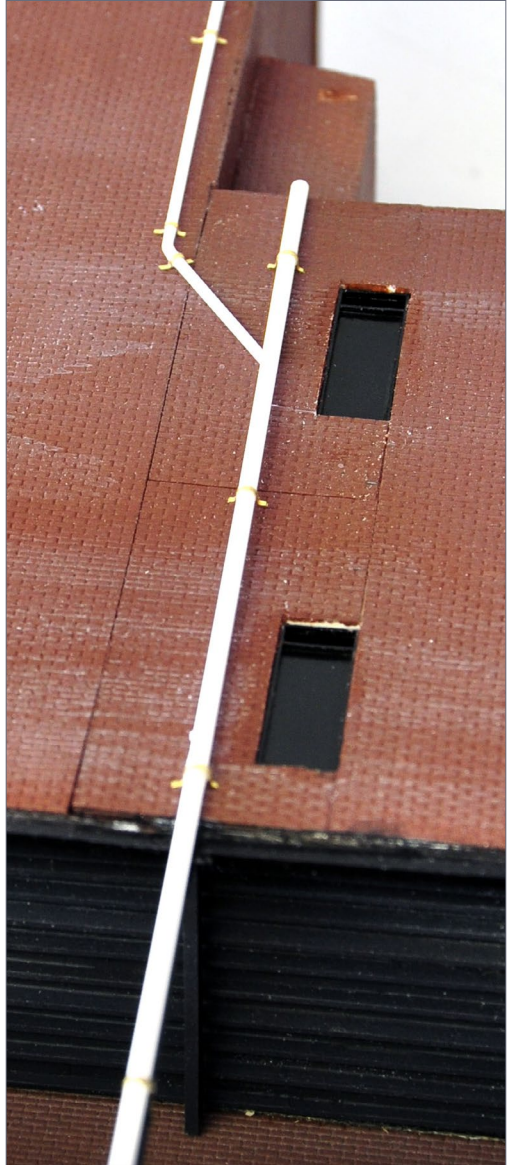

34. I dry-fit the downspouts to make sure they look right for their final locations.

MEADOWGOLD DAIRY | 37

The prototype has a long fire escape that runs from the center section to the right wing. I modified this somewhat by using a long-step section to get down to the next level. This required putting two-step sections together and making the handrail from 0.020" rod. While it may sound like a lot of work, but by using the kit's handrails as guides, it was fairly easy.

With all of the pieces ready, I painted them back, and set them aside for the next step.



35. The down spouts are installed and the Beatrice Cold Storage sign has been added.

Signs and weathering

I made the “Beatrice” with Adobe’s InDesign program, but any graphics program will do. Since most printers are not capable of printing white, I used Testors white decal paper (be sure to read the instructions if you have not used this product before).

By choosing “paper” on the lettering, the program tells the printer to not print anything in that area, giving the white letters. I made three decals, two smaller ones for each end and one large one for the face of the building.



36. The fire escape is a cut-and-file process. I began with locating the platforms and then determined the length of steps that I needed. While fire escapes are a neat detail, they can definitely try your patience.

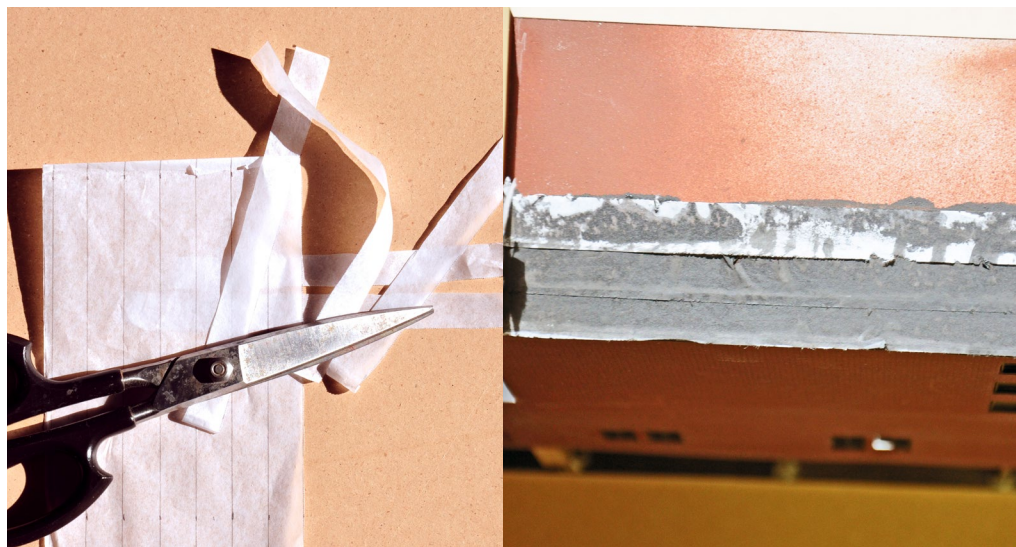

37, 38. My method for making a tar paper roof. I cut strips of tissue paper and then paint the roof with grimy black, pressing the tissue paper down into the paint.

I sprayed Floquil Hi Gloss in the areas the decals would be placed. Once it was dry, I applied the decals as you would any other decal. Once the decals were in place I sealed them in place with Dullcote.

I weathered the building with artist pastels. The two primary colors are a dark brown and an orange-brown. I scraped the pastel sticks with my X-Acto knife over a cup to collect fine powder.

I brushed this on the building with a soft artist brush. Then at the base of the building, I brushed on black to give the feel of dirt and grime that has splashed up over the years. Once all of the weathering was applied, I lightly sprayed on Dullcote to protect it.



36. The building is almost complete. All that remains to be done is to finish the water-tower sign.

Tarring the roof and installing the fire escape

The roof on the building represents a hot-tar roof. I make my tar paper from white tissue paper. You can pick this up at almost any store in the gift wrapping section. I cut the tissue paper into four-foot-wide strips with a pair of scissors.

I begin the roofing by painting on a heavy application of Floquil Weathered Black on the roof. I lay a piece of the tissue paper in the paint and press it down. The paint will seep up through the paper, attaching it to the roof. The tissue paper is

run up the brick two mortar joints, to represent tarred flashing that is very common.

Once the first piece was down, I applied more paint over the tissue paper and roof. The next piece of roofing was lapped over the first, and the process repeated until the roof was complete. Once all of the roofing paper was on, I brushed on one final coat of weathered black.

On the right and center sections I added a ladder up to the top of the roof. For the left section, I assumed the roof is accessed by a portion of the building that is not modeled.

The Walthers kit comes with the drop-down steps. However it was too short so I put together one and about a half a section of another to get the needed height. Once this was put together, it was too long for the counterweights to hold it up in place.

I inverted one of the platform brackets and added a piece of 0.040" rod to represent a spring-loaded cable housing. I then made a bracket from styrene to hold the end of the ladder. The top was cut from 0.010" plain styrene, with a notch made at the top. I then threaded a piece of 0.020" styrene rod through an eye-bolt, cementing it to the plain styrene. Two legs that attach to the steps were made from 2" x 4" styrene.

The left fire escape has a ladder that slides down when needed. I took some 2" x 4" styrene and cemented it to the sides of a ladder that comes with the kit. Another piece was added across the bottom to make the bracket where it mounts into the concrete column.

With the fire escapes added to the building, I took out the artist pastels again, dusting the fire escapes with black and some browns. I also added another coat of weathering to the building while I was at it.

Chimney and water tower

The prototype has what appears to be a steel chimney and a water tower that has a sign on it. I made the chimney from 3/4" PVC water pipe. I was able to purchase a 24" piece at my local Home Depot.

I added a 2"x4" band around the top of the chimney. I then added a 2"x8" band just below that. Both bands are two wraps of the styrene. I also made sure that the ends were in alignment vertically. That way, the chimney could be turned so the joint was to the back.

For the base, I also added two wraps of 2"x8" stock. At the very bottom, I added a piece of 0.040" quarter-round. This represents the mounting collar where the chimney extends through the roof.

Jim provided me with a water tower he had built. I cut it down so there is just one section of bracing. To get the proper angle at the base of the legs, I taped a piece of sandpaper to my workbench and just lightly sanded the legs until they would sit flush on the roof.

The water tower serves as the base for a large metal sign. On two sides, the sign is painted, and on the third there is a large hanging sign that has individual letters hanging from metal framing.

I made the housing from 0.010" styrene with 0.040" angle styrene for bracing in the corners. The cover just sits over the tank,



36. One of two Meadow Gold signs that go on the sides of the sign. I made the decals for the sign and printed them on an inkjet printer.



37. Lettering for the big display signs was custom-cut by Brian Banna using a laser cutter.

and the fit is snug enough that no glue is needed to hold it in place. I made the decals for the sign.

I attempted to cut out the letters for the hanging sign, but that was an effort in futility. Brian Banna (brian_banna@yahoo.com) cut the lettering for the sign. Even so, the lettering is delicate and can be easily broken. I made a frame from Plastruct L-shapes to mount the lettering to. The letters were cemented to the frame with ACC, painted, and then hung on the water tower. A little weathering of the sign, and the project is finished.

Conclusion

This was a fun building to make. I have never attempted to scratchbuild anything of this size before. What I learned is that by taking it in small steps, and working in sections for the majority of the project, it is very manageable.

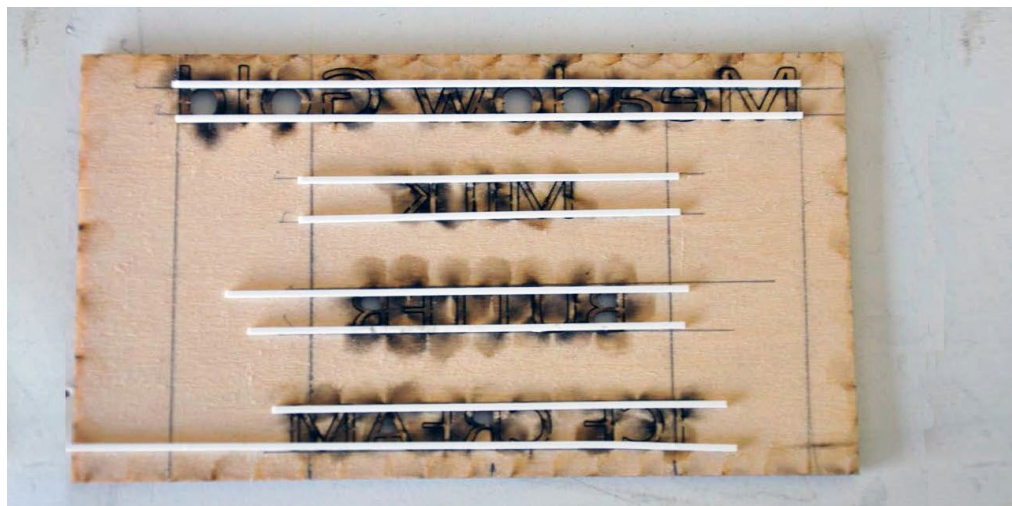

38. I cemented styrene angles to the backside of the sign prior to removing the letters.



39. The final sign hanging on the tower.

MEADOWGOLD DAIRY | 45

The tricky part comes when you have the building nearly complete and the delicate fire escape details can be easily wiped out. It is at this point that extra care needs to be taken in handling the model. ✓



[Click here for reader comments](#)



40. A shot of the finished building installed on the layout. Zoom in to study the details!

New Sharon Yard ops on ...

Mike Confalone's

ALLAGASH RAILWAY

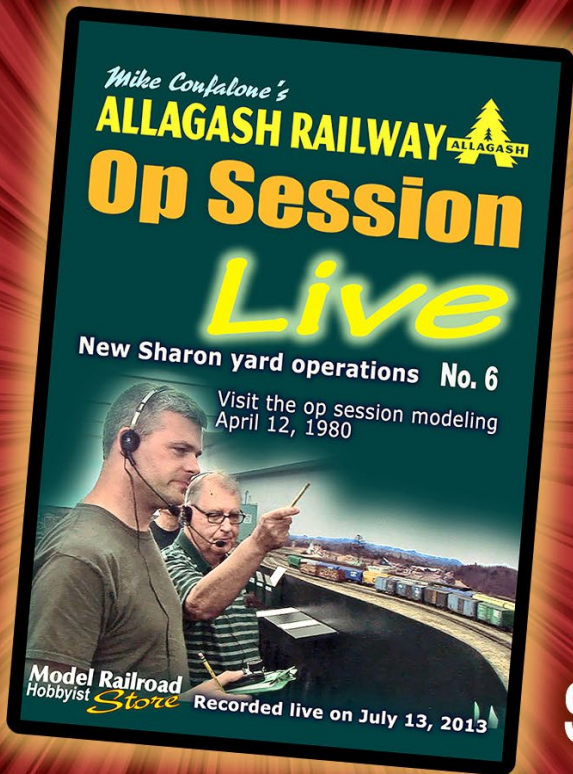

~~\$19.95~~

Special: \$14.77

Running time: 2 hrs - 16 min

 Order Allagash Ops Live - 6

from the
**Model Railroad
Hobbyist Store**

MRHMAG.COM

- TABLE OF CONTENTS
- INDEX

Heckman's Canadian Pacific

A Photographic Journey

by Ralph Beaumont

Joseph Heckman was a pioneer photographer for the Canadian Pacific Railway. He photographed the line from coast to coast between 1898 and 1915, capturing the engineering works, stations, hotels, steamships, and the people who made the railway run. More than 4,000 of these historic images are preserved in the CPR's Corporate Archives, and 380 of them have been made available for this large format, hard cover book.

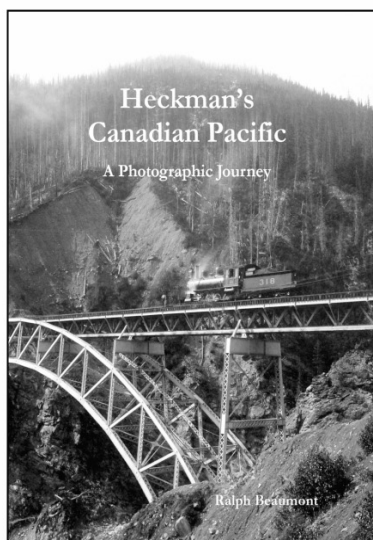

\$60.00 + Shipping & GST
ISBN 978-0-9784406-1-9
Large 9 x 12 format
Hardbound
328 pages - 380 B&W Photos
25 Maps, Index, Bibliography

Available June 2015 from:
Credit Valley Railway Company
2900 Argentia Road, Unit 24
Mississauga, Ontario, Canada, L5N 7X9
Canada/USA Toll Free: 1-800-464-1730
Online at: www.cvrco.com

MRHMAG.COM

- [TABLE OF CONTENTS](#)
- [INDEX](#)



YES, IT'S A MODEL

compiled by
DON HANLEY
.....



[Click here for
reader comments](#)



1. Jeff Yost posted on the MRH forum these photos of Seaboard 19922 that he recently finished detailing. We believe that he created the look of a car still in its prime, but beginning to show the years.



► **MRH'S MONTHLY PHOTO ALBUM**

YES, IT'S A MODEL | 2

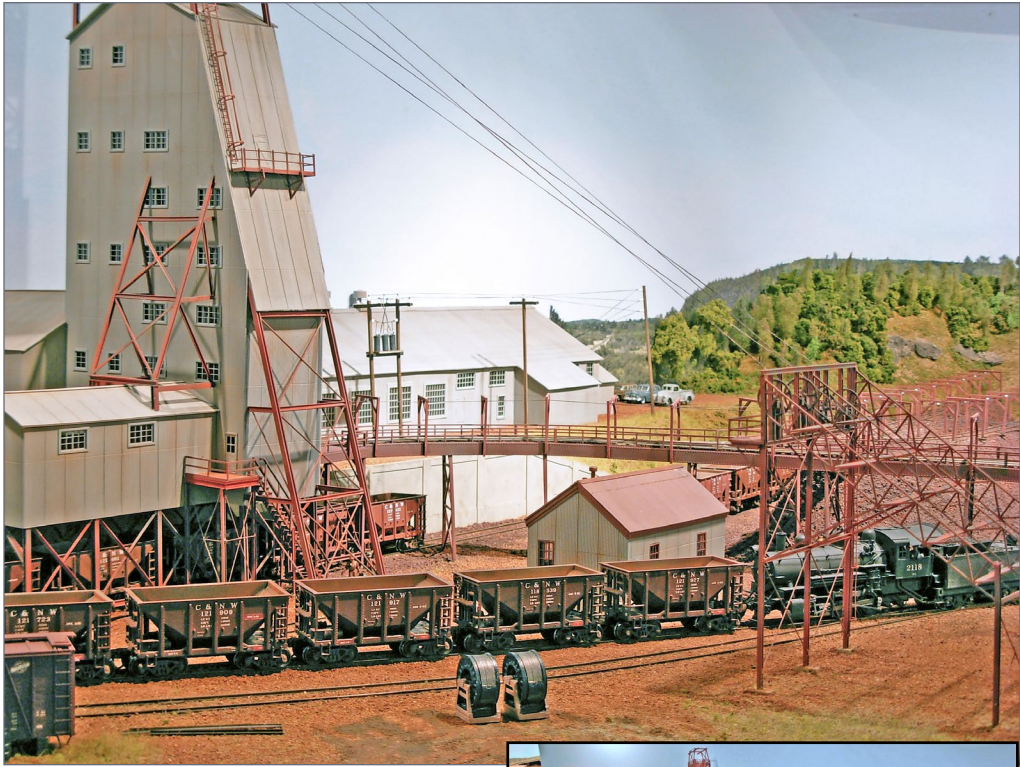

2. C&NW M-2 #2118 brings a cut of empties from Siemens ore yard to the Newport Mine near Ironwood in Michigan's Upper Peninsula. Hans Schlegel scratchbuilt this model of the Newport Mine from photos of the prototype located near Ironwood in Michigan's Upper Peninsula. The stockpiles are made of real iron ore from the actual mine. The overall scene is 3 x 6 feet, trying to capture the prototype as closely as possible. The Newport Mine operated from about 1887 to 1963. It reached a depth of 3,400 feet, and produced 32,000,000 tons of ore.



3. Kevin Packard is back with another one of his fantastic weathering jobs on BNSF 9624. What can we say but he is an artist and has a real knack for weathering diesel locomotives.



**DID YOU
KNOW MRH
SUBSCRIBERS GET
FREE BONUSES?**

CLICK TO SUBSCRIBE NOW - IT'S FREE!



4. Raymond Loewy step aside, here is a Jules Verne-inspired locomotive design Ivan Lakimenko just finished. Yes, that is polished copper, aluminum and brass – no paint, just metal. The thing is filled to the brim with electronics, controlled by an Arduino Nano board. The locomotive has a Tsunami TS1000 sound decoder in the tender.

YES, IT'S A MODEL | 5

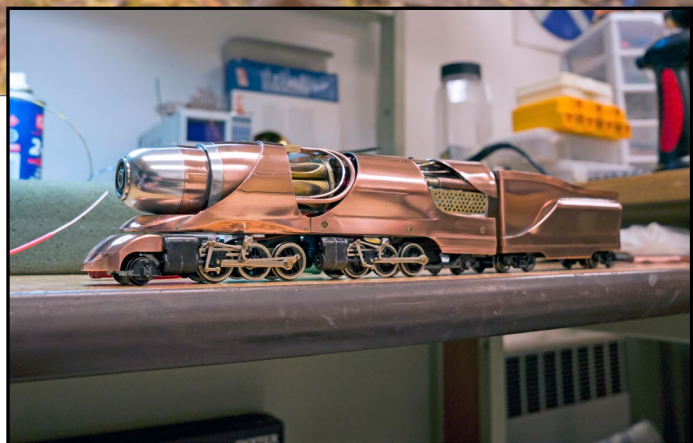



GET PAID FOR YOUR PHOTO

We pay \$40 per photo we publish. If you'd like to get your modeling in our photo feature, just start posting your photos on the MRH website, especially in the Weekly Photo Fun thread created each weekend.

See mrhmag.com/help for more on how to post an image. You need to be an MRH subscriber to post photos to our website, and becoming a subscriber is free, [just fill out this form here](#). ■



[Click here for reader comments](#)

When talking to hobby vendors, please remember to mention MRH.



The Amherst Railway Society Railroad Hobby Show

Our 2016 Show will be

January 30 & 31, 2016

Save the dates!

About The Show

Every year late in January or early in February, the Amherst Railway Society holds its Railroad Hobby Show at the Eastern States Exposition Fairgrounds (The home of The Big E) in West Springfield, Massachusetts. More than 25,000 railfans and public attended the Show each of the past three years.

The event features real life railroads and scale model railroads, historical societies, travel agencies, art shows, flea market dealers, importers, manufacturers and photographers. You have to see it to believe it!

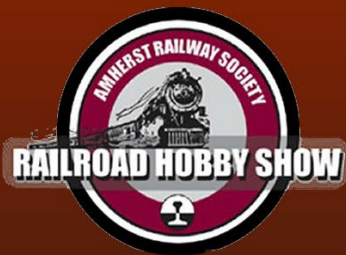

**Click
to learn
more ...**



A RAILROADER'S RAILROAD

BY BARRY KARLBERG
.....

'Throwaway' for a finished basement covers the basics ...

MY LAYOUT DOESN'T STRICTLY FOLLOW A true prototype. It is based on ideas I have seen and used on the prototype in my work. I choose what I like best and what I think will make a simple, realistic railroad.

The era is 2000 to the present. My theme is a very basic railroad which connects with the Canadian Pacific/Soo, a Class 1 railroad. The short line handles freight for a half dozen customers during the week. On the weekends it allows a local railroad museum to run steam passenger trains on its short main track, which is a little less than a scale mile long.

Construction

The layout is designed to be easy to build, maintain, and operate while at the same time doubling as a way to illustrate

railroading to a friend, neighbor or family member. The benchwork is simple box girder construction of 1x4

boards topped with 2-inch foam and screwed to wall studs, with 1x4 legs added where necessary. The layout is L-shaped, about 25 feet down each wall with a terminal at each end.



[Click here for reader comments](#)

Track and switches are Atlas Code 83 laid on cork roadbed. Power is supplied by Digitrax DCC, with reversing modules for the wye and balloon tracks. Other turnouts (switches) are thrown using a skewer stick or will eventually have N scale Caboose Industries ground throws.

The overall idea behind this layout (which replaced another like it in N scale) was to build something which looked good in a finished basement, ran smoothly and gave me an opportunity in HO to learn about DCC and scenery. It is what I call a “throw away,” so that when we move I can build another simple layout based on what I’ve learned from this one. At the same time, it won’t be hard to salvage the two main parts, the wye and balloon track, because they are roughly 4 x 8 feet in size.

Motive power

Power includes a pair of Bachmann 2-8-0s (one painted for Illinois Central to haul the excursion train), two 2-6-0s, an Athearn CP MP15 which handles interchange work from the main line connection, and a Watco CF7 for freight work on the short line. There is also an RDC-1 which handles a short commuter run from a distant city.

A RAILROADER'S RAILROAD | 3

There are more locomotives and rolling stock available, but I try to keep the level of equipment to 3 or 4 locomotives and about 15 to 20 cars so the layout isn't overwhelmed. I see from my pictures I need to have more brown, black and gray freight cars to subdue some of the bright colors on the layout. I guess a little basic weathering wouldn't hurt either.

Business

Industries, built or planned, include a grain elevator and flour mill, and a lumber yard at the wye end. Other industries include

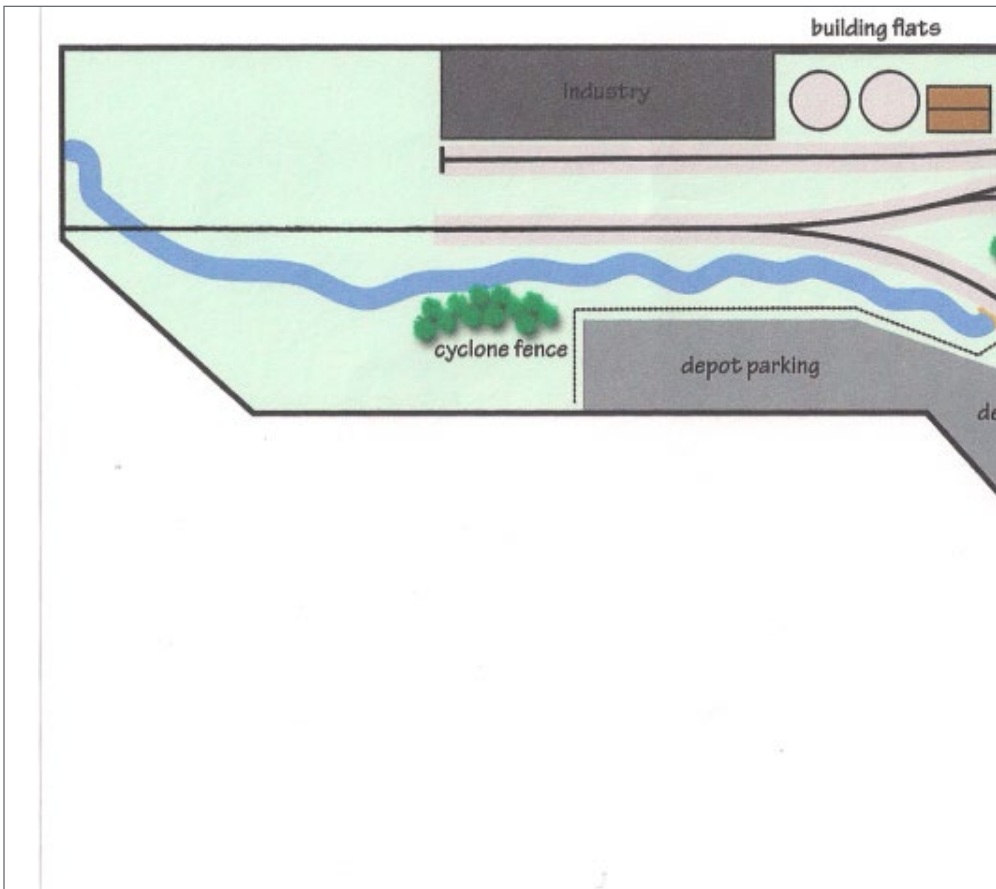

A RAILROADER'S RAILROAD | 4

a transload center, a jelly/jam/fruit preserves plant, a small chemical distributor, a plastics plant, and a paper distributor at the balloon track end.

I have found that most short lines these days have a plastics plant, some type of grain industry, often a tank car customer, like a chemical, propane or fertilizer distributor; and sometimes a lumber yard or other boxcar/reefer industry.

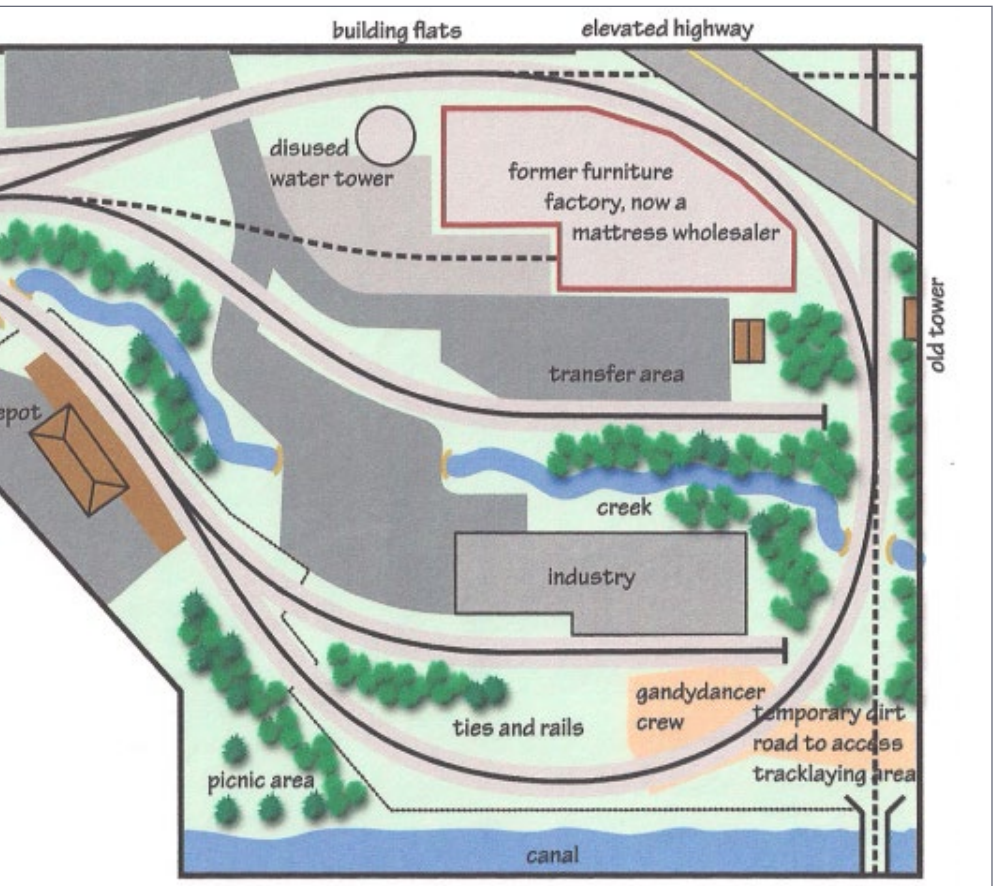

Behind the design

Because I have railroaded from the ground, cab and classroom I designed the layout to have at least a wye, a loop, interchange, a siding-runaround track, facing and trailing point spurs, and engine facilities ... the basics of railroading. I wanted it to be something I could operate as a “lone wolf,” with my grandkids when they visited, and as a way to illustrate “how it all works” to non-railroaders.

Since a part of my career has been spent teaching and training railroaders I have come up with methods to describe railroad operations to “new hire” conductors and I have incorporated some of those ideas into the layout to help non-railroaders understand what a real railroad does and how it operates using a simple format.

For example, I can show bringing an engine from the engine house, lining up a few cars off the interchange, and then making



2. Barry brings a railroader's eye to modeling, with track layouts and shippers based on places he has worked over the years. *Barry Karlberg photo*

A RAILROADER'S RAILROAD | 6

a run up the line to pick up and set out cars at industries before heading around the balloon track and returning back home to the wye junction. I also wanted the layout to be simple, with each switch and track designed for a purpose and not just as a

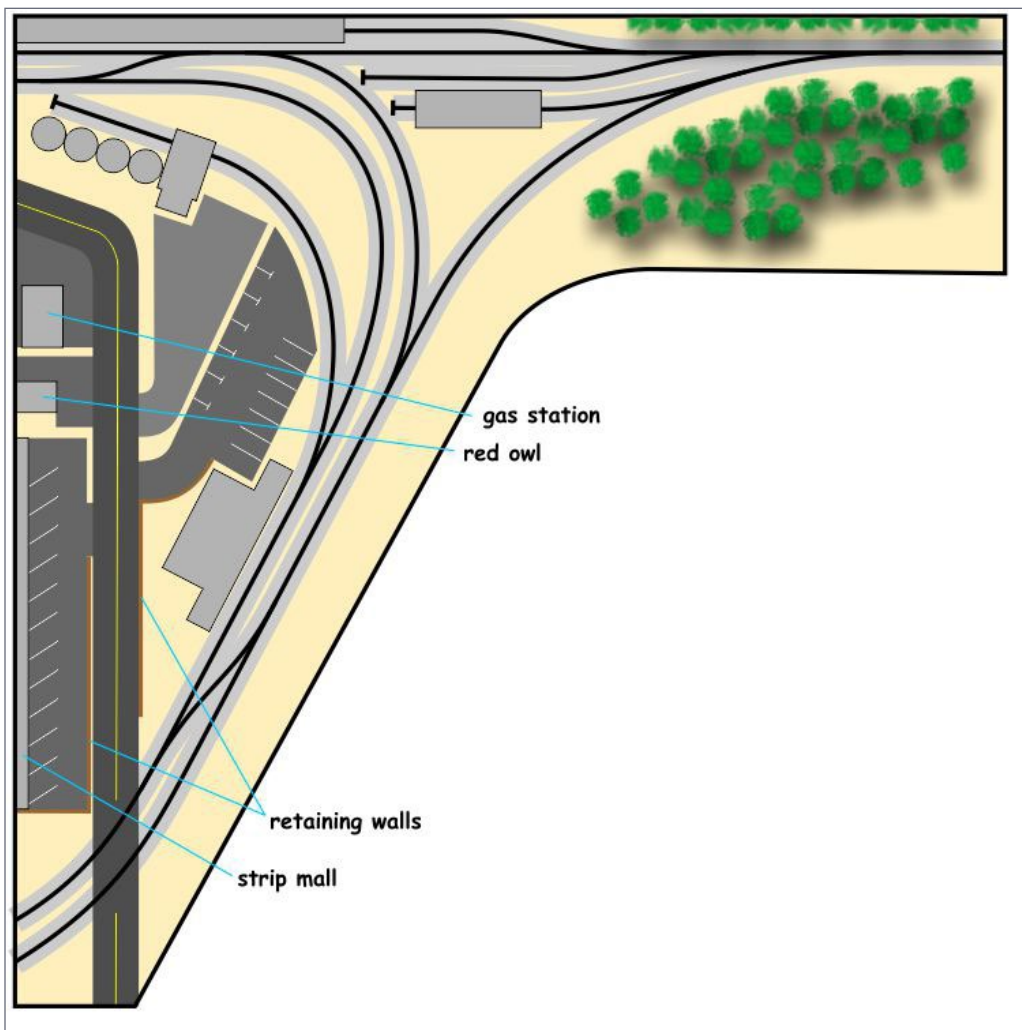

3. The wye module incorporates the short line's connection with the Class 1 CP/Soo route. *Drawing by David Smith*

model. Definitely with no “switching puzzles.” This layout had to be simple to build, maintain and operate with only a few detailed pieces of equipment and structures.

One of my favorite prototype operations was the Milwaukee Road's Fox Lake branch in Wisconsin, which came off a wye on the main east of Beaver Dam, WI and headed north a couple of miles to terminate in a balloon track with several industries tucked inside. Model Railroader and Gordon Odegard did a neat article with track plan on this branch back in the late '70s and I have always liked it, even though I don't model the Milwaukee Road or Wisconsin.

Through years of working in the field as an engineer/conductor I saw many prototype track situations which could be modeled, and I would always file them away in my memory for possible use in a layout.

Alas, the Milwaukee's Fox Lake line now exists only as a place to store cars. The industries and loop are gone, with the track removed to within a half mile of the town. However, there are plenty of new balloon track operations today as a result of unit train operations, for unloading/loading, oil, sand, grain, gravel, perishables, and so on..

The concept

Although I haven't found an exact prototype for my model balloon track, such places did exist. The reasoning behind mine is that it was once the location of a crossing between two secondary main line railroads. Neither had much local business but together they handled a handful of industries where they crossed.

After the abandonment of both lines, a local museum railroad wanted to run steam and bought the wye and stub branch up to

the old diamond crossing. Along with the track came the right to serve the two remaining industries: a food processor and a paper warehouse.

There being no room for another wye or even a runaround track at the crossing, they did the only logical thing by creating a balloon track by using the curved interchange track (right top corner of the loop plan) and then constructing additional track to come off the old north/south right of way and connect up to a new switch into the paper distributor. This created an easy way to switch the industries and “turn” the freight and passenger trains to return to the wye. It allows a handy one-switch runaround.

As the history continues, the museum was so successful hauling a few cars of freight that it set up a separate company to handle and market the freight operations. This resulted in the addition of a plastics plant, a chemical distributor and, midway between each end of the line, a transload center to handle any commodity from truck to rail or rail to truck.

If this sounds too “far-fetched” to be true, I can provide many examples of working on and managing short lines where this was accomplished, although not always with a passenger operation. One which comes to mind is the Strasburg Railroad in Pennsylvania, which primarily hauls passengers but recently started hauling more freight and has built a transload track off to the side of their yard.

What's next?

Retirement and a home move will be happening by the end of 2015. When we relocate to Minnesota I plan to move both the wye and balloon modules to have the beginnings for a new layout. This railroad was dismantled in June, with key pieces saved.

Once I determine my available space and its shape, I may use the balloon with an added siding for hidden staging behind a wall and move its industries to a simple switching layout on an 8-inch wide, 8-foot tall door. This will feature a hollow-core door with plywood sub-roadbed, Homabed, Atlas code 83 track, and foam scenic features.

The track plan will include a runaround track, a siding to meet and pass trains, three industrial spurs using various car types, a coach track with depot, 90-foot turntable, and a two-stall engine house for the steam excursion operation. This would replace the loop as the last station before entering the hidden staging balloon. The advantage of the hidden loop is that it permits more “through” movements for a regional railroad on trackage rights, while the short line provides the local freight and excursion service.

The wye module would be the same with a small engine facility for the freight diesels, a pair of interchange tracks with the CP/CN and two crossovers connecting the short line to the Class one carrier at both ends of town. If possible I would also extend the CP-CN trackage by four or five feet to show more of the higher speed main line, provide a better depot both for Amtrak and short line passenger trains, and to include a pair of CP-served industries at the junction.

As far as the connecting layout between the wye and “terminal” town, it would be an around-the-walls shelf, probably very narrow (about 8 inches) with only a couple or three industries on line and maybe another siding at a tiny rural town. I’d emphasize rolling Midwest scenery, Minnesota’s lakeside trackage, a small river, and lots of trees including a couple of “tree tunnels” plus a longer run between terminals.

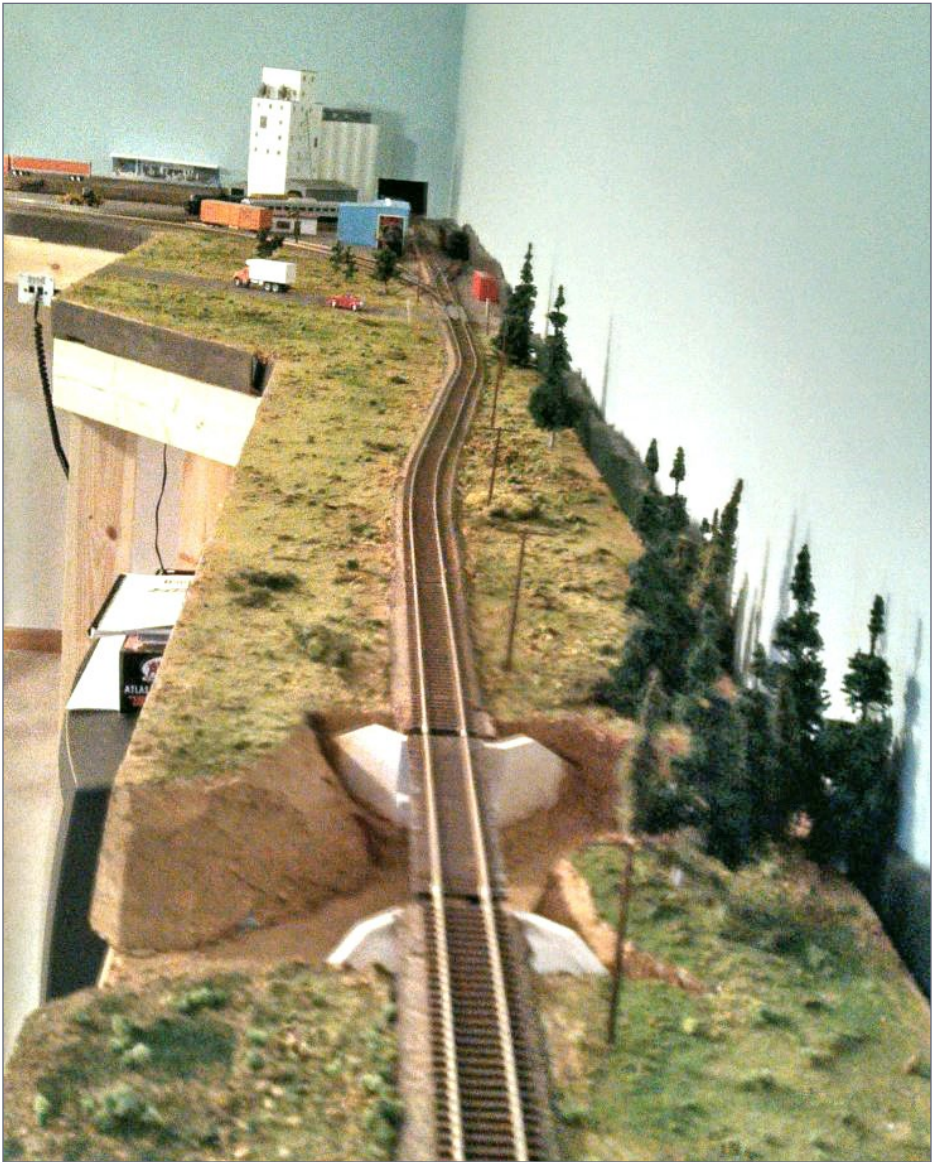

4. The connecting layout between the wye and balloon track modules proved a good place to learn scenery techniques, and is simple enough it could be sacrificed in a move. *Barry Karlberg photo*

The focus would be on a simple, easy to build, easy to maintain, and easy to operate, simple, free-lanced prototype short line railroad.

That's the dream. We will see how it turns out.

How I got started

I began model railroading at the age of 4 and moved up to a family S gauge American Flyer train set which my dad sold in the model railroad section of the family music store. Dad was a railfan back in the 1940s and the '50s, and even tried to hire out as a locomotive fireman on steam engines when he was young man. But being of slight build and wearing glasses (both of which were not permitted in train and engine service back then) it was not to be. So he managed the family music business and took me along with him to watch trains, with the result of me later choosing the railroad for my career.

My dad gave me his HO trains about the time I entered high school: Atlas fiber-tie track, Athearn and Varney cars and locomotives (fairly crude compared to today). I built a few small layouts adding Tyco trains and buildings.

These pikes were a variation of roundy-roundy fill-the-board layouts but I was becoming increasingly aware of real prototype track layouts: wyes, turntables, balloon tracks, runaround tracks, yards and industrial spurs. This led to more realistic layouts. I spent hours upon hours drawing layout plans based on various railroads.

The real breakthrough for me came in the late 1960s when Model Railroader presented its "A Railroad You Can Model" series based on prototype track plans, and ran an article on a short point-to-point Missouri branch line on the Wabash which featured diesel passenger and mixed passenger-freight trains.

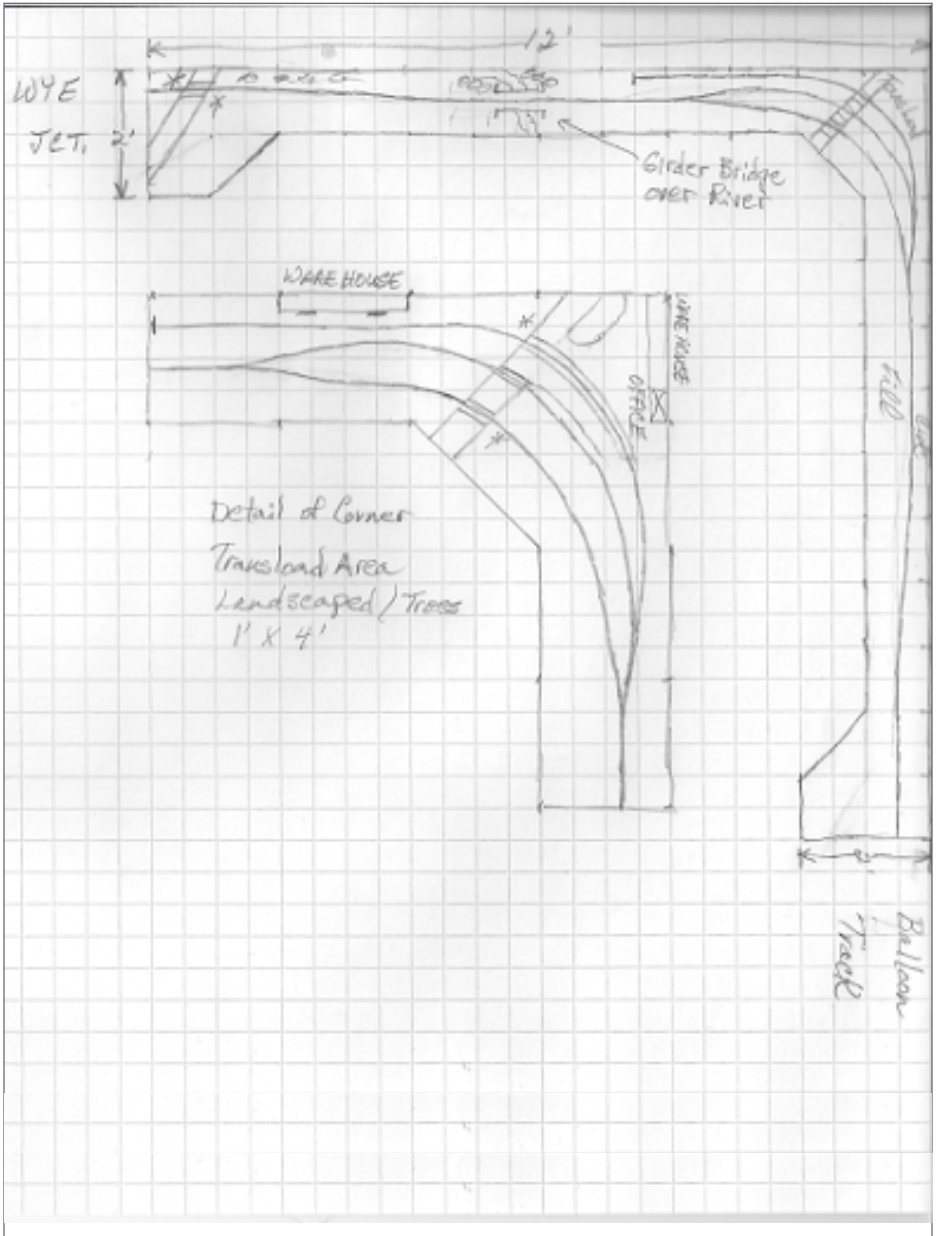

5. Pages of sketches roughed out plans before cutting wood or shaping foam insulation board. *Barry Karlberg drawing*

A RAILROADER'S RAILROAD | 13

The bonus was that instead of producing an entire track plan for a layout, they provided three separate plans, for the main line junction at Centralia, a mid-point village, and the end of the line town of Columbia with its varied small town industries. They also explained in good detail how the line was operated, what industries were served, types of freight cars, locomotives and passenger equipment.

This was the first time railroading was explained and illustrated for me. From then on, all my layouts were point to point with an option for continuous operation. While I was in college and working as a switchman, my dad – who had been out of the hobby for many years – began to show interest in the new N scale. He and I built a few layouts together, with me continuing in that scale for the next 30 years before moving to HO 10 years ago.



[Click here for reader comments](#)

Over 35,000 have seen this MRH video - *have you?*



[Watch the video now](#)



BARRY KARLBERG



Barry began his railroad career 48 years ago on the Illinois Central, then worked as a Penn Central brakeman and switchman through college.

After graduation, he worked for CNW, Soo Line, and the Columbus & Greenville as a consultant; for the Milwaukee Road as a carman and agent/operator, as an Illinois Terminal clerk, and then as a switchman on the Illinois Central Gulf.

From there, he went to the Soo Line to train new-hire conductors and

became a manager in the control center, and manager of special projects. After that, to Wisconsin Central as a trainmaster, engineer, and conductor, and the Minnesota Commercial before going to Progressive Rail at its start-up with the MN&S Highline, and Wisconsin Northern as manager, engineer, conductor.

After that it was the Kansas & Oklahoma as trainmaster, engineer, and conductor, before going to Watco as a regional safety and rules manager.

He and his wife Chris have recently left Wichita, Kansas for a retirement home near family in Minnesota.

More about Barry's modeling at: mrhmag.com/node/17086. ■

WEATHERING A

Saskatchewan covered hopper



Acrylic paint and pastel chalks are all that's needed to make a model distinctive ...

BY GREG LUERS
.....

MRHMAG.COM

- **TABLE OF CONTENTS**
.....
- **INDEX**



THE CAR IS AN HO SCALE INTERMOUNTAIN

4-bay cylindrical hopper. The goal is to have a simple weathering project that everyone can do.

Before we can begin the weathering process we have to Dullcote the model. The clear flat spray finish knocks down the plastic

shine and adds tooth for the base weathering, whether that be washes or airbrushed paint. The flat finish is the foundation of the process.



[Click here for reader comments](#)

I brushed Americana raw umber acrylic paint all over the underbody, to represent all the grime the car picks up over time. The raw umber paint is a little light in color, so to darken it up and add some texture, I use black powders and apply them with a soft brush specifically saved for this job. My chalks are pastels in stick form; you can find them at a local hobby or craft store. I grind the sticks down on a piece of sandpaper, or you can use a sharp blade and scrape powder off the stick.



1. Raw umber acrylic covers the underbody.

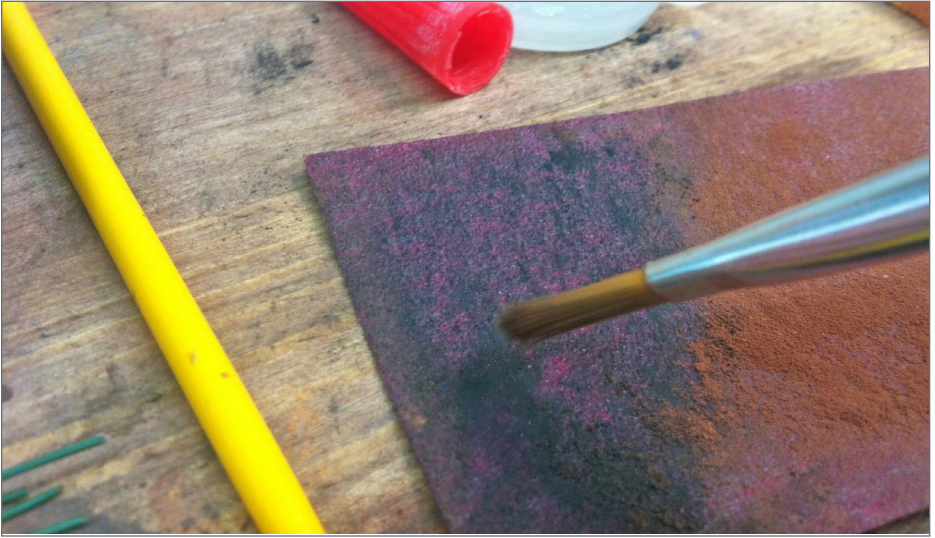

2. Use a soft brush to apply the ground chalk powders.

Wheels and trucks

For the trucks I also use raw umber paint, but first I grab a piece of scrap wood or plastic sprue and place it in the truck screw hole. Doing this gives me something to hold onto and makes it easier to paint the truck.

Apply the raw umber paint all over the truck faces; I don't apply it where the wheel axles go into the truck, because if you paint that, the wheels won't roll smoothly. After painting I use a clamp to hold the piece of scrap holding my truck and set aside to dry.

Now I weather my wheels, using a semi-fine brush. I apply my raw umber paint to the depression in the face of the wheel, being sure not to get it on the point of the axle and or on the tread where the wheel meets the rail. I then put the wheelset aside to dry and grab my now-dried trucks.

WEATHERING A COVERED HOPPER | 5

Using the same black powders we used on the underbody, I apply it to the truck faces to darken them up and add texture. I use the same technique with the wheelsets when they are all dried. This step really adds texture and makes the model look a lot more realistic. I then put the wheels back into the trucks and re-attach the trucks to the body of the car.



3. Use a piece of scrap wood to hold the truck for painting with raw umber.



4. Be careful when painting the wheels, so you don't get paint on the axle points or wheel treads.

Base weathering

The base tones are the most important step in weathering a model. They determine how light or heavily weathered your model will be. It's really important to get your base color right, because it's hard to go back when it's on the model. Using a scrap car to test your paint is a must to get the correct color.

This model will have a darker base weathering, per the prototype image. To achieve this look I will use washes. An airbrush would be easier but I prefer using a wash. Choice of technique for your models is all up to you and what you are comfortable with.

For the paint, I will be using raw umber and black. I mix the black and raw umber in a paint cup with water. I then put the lid on my paint cup and shake it up really well; if this is not thoroughly mixed, the paint won't dry correctly on the model. I test the consistency of the paint on a scrap car. The paint can't be too thin or too thick. It must be just right. When you have your paint mixed up perfectly, we can begin work on the actual model itself.



5. I use a paint cup and water to mix my washes.

WEATHERING A COVERED HOPPER | 7

Getting to work

I use a quarter-inch wide paintbrush for my washes. I dip the brush into the paint cup and apply it to the top of the panels, and then drag my brush downward making sure I cover the whole car.

Do only four or five panels at a time. The paint dries fast. Once they are covered, I move on to the rest of the panels until the whole side is covered. I keep some Q-tips on hand for when the paint begins to pool in one area of the car. I use the Q-tip to draw off the pooled paint. I then set it aside to dry.

You may have to apply several coats to get the darkness you're looking for. This car could be slightly darker but I'm afraid that adding a second coat would make it too dark. So, in this case it is dark enough and we can finish up the base coat by doing the other side and the ends. You could apply it to the top as well, if you prefer. Now we can move onto the next step.



6. Use a quarter-inch brush to apply the washes.

WEATHERING A COVERED HOPPER | 8



7. You may have to apply several coats to get the intensity you want.

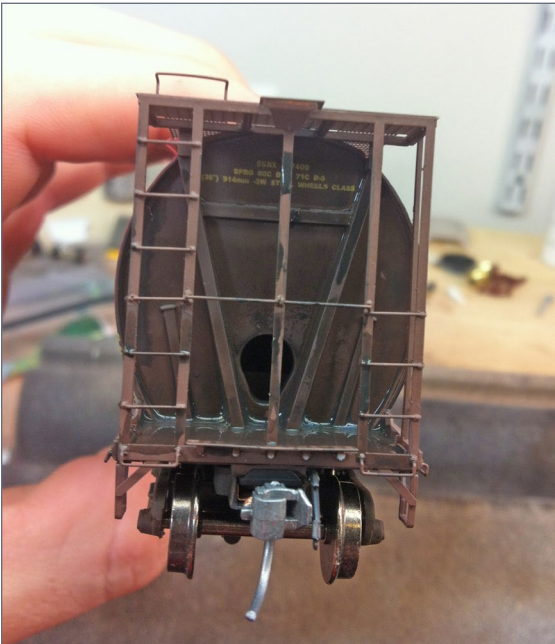

8. Don't forget to apply the wash to the ends as well.

Streaking

The next step in the process is to add scratches, dings, and dents. Checking the prototype photo, we see the car is pretty clean in that regard. So, we will move on to adding the streaks.

The prototype picture shows a lot of streaks; there are streaks coming from the roof braces down, and there are streaks that follow each panel edge where they were welded together. There are many ways to achieve the streaking. You can paint them with acrylic or enamel paint. Doing this will take a real steady hand. You could use artists oil paint and then go back over it with powdered chalk, or you could just use powdered chalk by itself.

To achieve the look I want, I'm going to use powdered chalk because I don't have the steadiest hand and the streaks don't have



9. I use powdered chalk to make the stripes.



10. The finished streaks.

to be absolutely perfect. For this I use a smaller fine tip powder brush and will be using the black powdered chalk we used on the underbody and trucks in the previous steps.

Roof

Our model is looking real good, and it's getting real close to being finished. For this step, we need to hit the roof hatches. It's up to you how the hatches will look. You could weather them to a real dark effect with powders, or use the sponge technique by dipping a small sponge in black or raw umber paint and then spotting it on the roof hatches to give a spot rusting effect. You could also paint the hatches a gray or white color to make them look like they were recently painted or replaced. I'm going to stick to the basics on this one and just add some black powder to the roof, and that's it.



11. I added black powder to the roof to finish the car off.

Couplers and final seal

We now have our completed model. We have just one small but huge step to go. We need a light coat of red/orange colored powder for the couplers to give them a rusted effect; this is a small detail that a lot of people forget about. Next is the final dull coating. It is very important for a spray of Dullcote or clear matte finish to be your final step because it will seal in all the weathering work, and when someone picks up the model the weathering won't get messed up.

The model is fully weathered and completed. The whole process takes me about 2 1/2 hours from start to finish.



12. The finished model.



[Click here for reader comments](#)

GREG LUERS

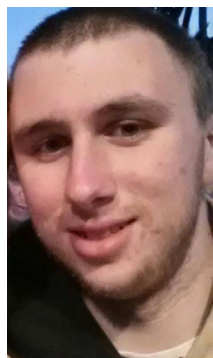

Greg Luers is an animation student at Purdue University, and got into the hobby about five to six years ago when he found some realistic model train layout photos on the Internet that sparked his interest.

He is now working on his Terre Haute, IN module, inspired by his childhood days watching trains from his family's property on the CSX single mainline.

He is a member of the Purdue University model railroad club where they are in the process of building a three-room, double mainline, two-deck layout of the Chicagoland rail area.

His other hobbies include basketball, football, and graphic design. ■

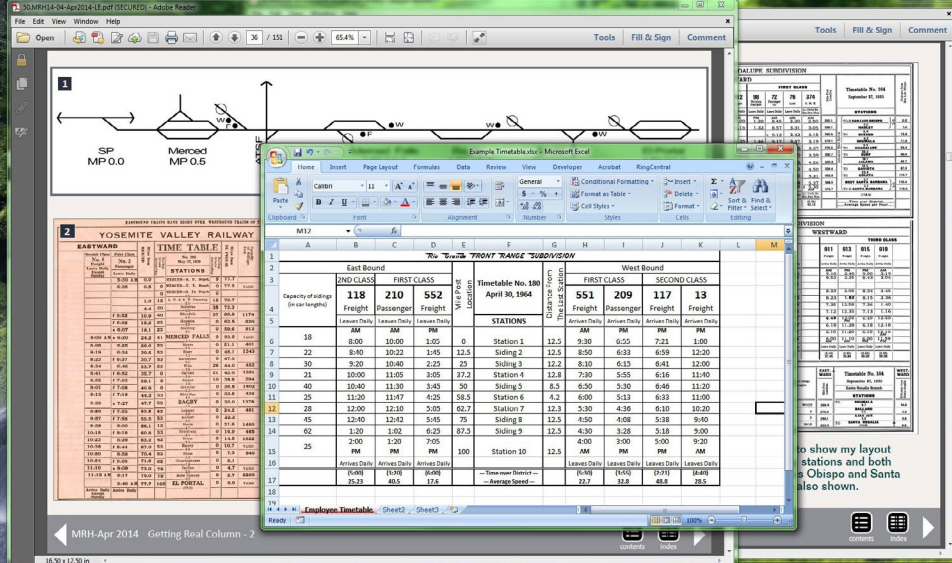

USING EXCEL

to create your employee timetable

BY **KEN BILES**
.....

A simple way to create a timetable ...

IN HIS OCTOBER 2014 “GETTING REAL” COLUMN “Creating A Realistic Model Timetable,” Tony Thompson pointed out how realistic paperwork, and an employee timetable specifically, helps operators of your railroad learn and understand how your layout works. Back in April 2014 Jack Burgess, in his “Getting Real” column on “Dispatcher Sheets,” described just how the employee timetable works, using his Yosemite Valley RY as an example [2].

1. Creating your own employee timetable in Excel is easier than you think! It’s also extremely flexible, so that changes can be made in a few seconds.

- **TABLE OF CONTENTS**
- **INDEX**

Both columns did a fantastic job of describing how the timetable could be adapted to use with a model railroad, and why you might want to

use one. In fact, it was the column by Jack Burgess that finally got the light to go on in my head, and I finally understood how to read a timetable. Until that point, it was a confusing jumble of numbers that I couldn't make heads or tails out of.

The one thing that I haven't seen discussed is, how can I easily create my own employee timetable? I read MRH every month, so I have a computer. I also have basic office applications loaded onto that computer, so I thought I should be able to create something absolutely unique to my layout, but also something that looks professional. The beauty of the technology we have today is that we can custom-make paperwork for our layout that would have been impossible, or prohibitively expensive to have professionally printed just 30 years ago. Now we have the means and the ability to create just about anything we want, for just a few pennies.

Looking at a typical employee timetable, the first thing I noticed was that it looked very much like a ledger, or spreadsheet. I have Microsoft Excel on my computer, so I should be able to use that to recreate an exact duplicate of a standard timetable, but make it for my railroad. If you don't have Microsoft Excel, there is a nearly identical spreadsheet included in Open Office (openoffice.org) that works the same way, and even reads and saves Microsoft Excel files. The software is known as "open source," which means that it is free to download and use. Unlike some shareware, the applications are full versions, and free to use any way you like [3].



**Click here for
reader comments**

USING EXCEL FOR TIMETABLES | 3

Looking at the blank spreadsheet, the first thing we notice is that it is made up of rows and columns, just like an employee timetable. The big difference is that the employee timetable has some of the grid lines removed from the graph. We are going to use this to our advantage in creating our own timetable [3].

The first things we need to know are, how many trains, and of what class, run in each direction. This will determine how many columns we need. For a large layout with many trains, your employee timetable may end up looking much more like the prototype. Also, we need to know how many stations we have. This will determine how many rows we will use. For our purposes, a **Station** can be considered anywhere a train may stop, so this would include sidings and towns, even if there isn't

EASTBOUND TRAINS HAVE RIGHT OVER WESTBOUND TRAINS OF THE SAME CLASS													
YOSEMITE VALLEY RAILROAD COMPANY													
EASTWARD			Miles from MERCED	TIME TABLE				Miles from EL PORTAL	Capacity of Storage, etc. (No. of Cars, etc., and details)	Fuel, Water, Tim. tables, Wyes and Phases	WESTWARD		
Second Class	Second Class	Second Class		No. 103a May 27, 1939		Miles from MERCED	Miles from EL PORTAL				Second Class	Second Class	Second Cla
No. 14 Freight	No. 12 Freight (Rock)	No. 8 Freight (Log)		STATIONS							No. 9 (Log) Freight	No. 11 (Rock) Freight	No. 15 Freight
Leave Daily	Leave Daily	Leave Daily	0.0	MERCED-S.P.Depot	5	77.7							
9:55 AM	2:45 PM	7:30 AM	0.5	MERCED-Y.V.Depot	0	77.2	YARD	W.F.T.P.	8:05 PM	1:00 PM	6:05 PM		
			0	MERCED-S. Fe Depot	0								
			1.0	A.T.S.F. Crossing	15	76.7							
	4:15		2.5	Portland Cement	35	75.2				12:55			
			10.9	Edendale	37	66.8	4						
			15.2	Hopeton	0	62.5							
10:30	4:30	8:05	24.2	MERCED FALLS	0	53.5	8	F.W.T.P.	5:45 ¹² 4:42 ¹³	11:45 ⁹ 11:40	4:50 ¹² 2:30		
11:45 ¹¹	4:45 ⁹ 15	9:34	29.6	Starr	0	48.1							
			30.7	Exchequer	0	47.0		P.					
			44.2	Kittridge	0	33.5							
12:55	5:25	10:27	47.7	BAGBY	0	30.0	4	W.T.P.	3:50	8 11:00	14 12:55		
1:10 ¹⁵	5:35	10:45 ¹¹	60.8	Briceburg	0	16.9		P.	3:30	10:40	12:30		
3:10 ⁹	6:55		67.0	Emory	0	10.7	5	P.	3:15 ¹⁴	10:25			
			70.4	Bloss	0	7.3		P.					
		11:15	73.0	Incline	0	4.7	14	P.	3:05	9:37	8 11:20		
3:40	7:12	11:38 ¹⁵	75.0	Moss Canyon Tank	0	2.7		W.P.	1:17		11:10		
4:00	7:24	12:01	76.7	Moss Canyon Wye	0	1.0	5	Y.	12:50 PM	8:50	10:30		
5:00 PM	7:40 PM		77.7	EL PORTAL	0	0.0	YARD	T.P.		8:10 AM	9:50 AM		

2. Image of Jack Burgess' employee timetable for his Yosemite Valley RY.

USING EXCEL FOR TIMETABLES | 4

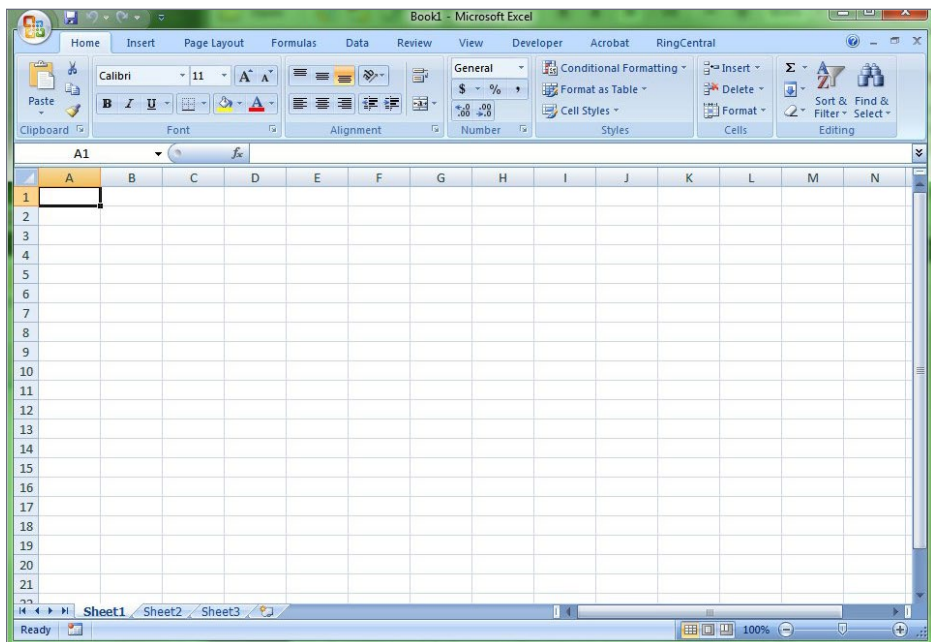

3. A blank Excel spreadsheet, as it looks when the application starts.

an actual train station there. Remember, the prototype railroads name *everything*, so even a lone siding out in the middle of nowhere, will have a name that can be used in the timetable.

Because I don't yet have a layout up and running, I'm going to create an example timetable just to show you how you can do it. Because it's an example, I'm going to use things like "**Station 1**" or "**Siding 1**" instead of actual place names. This will at least give you the general idea of what you would put in those places. I'm going to have four first class trains, two in each direction, and three second class trains, two westbound, one eastbound. I'm also going to have the timetable cover 100 miles of track with 10 stations, so Station 1 will be at mile 0, and Station 10 will be at mile 100. The reason for 100 miles is simple – it's a round number,

USING EXCEL FOR TIMETABLES | 5

and the union used to have rules that a train crew couldn't travel more than 100 miles in a day.

This means I'm going to be using a total of 17 rows (10 stations plus information for subdivision, direction, class, train number, departure, arrival and a final row showing the time that train takes to get between the first and last station, as well as average speed of that train). I'm also going to be using a total of 11 columns (one column for each train, plus a column each for siding capacity, mile post of each station, the list of stations, and the number of miles from the last station). This is standard information you would find on an employee timetable [4].

View the steps on the following pages ...

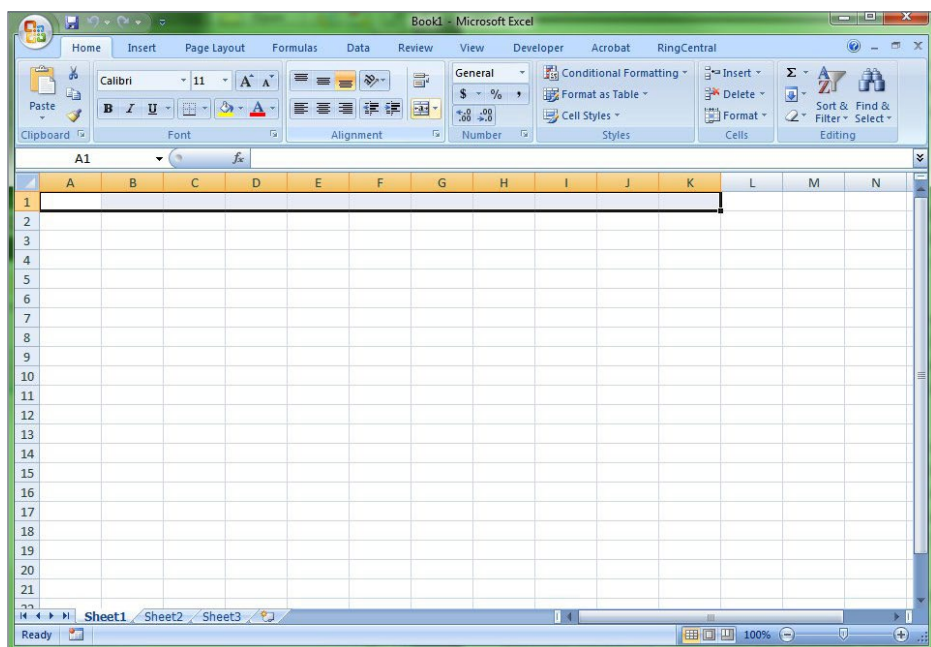

4. The first thing I do, is highlight the first 11 cells of the first row. This is the entire width of my employee timetable.

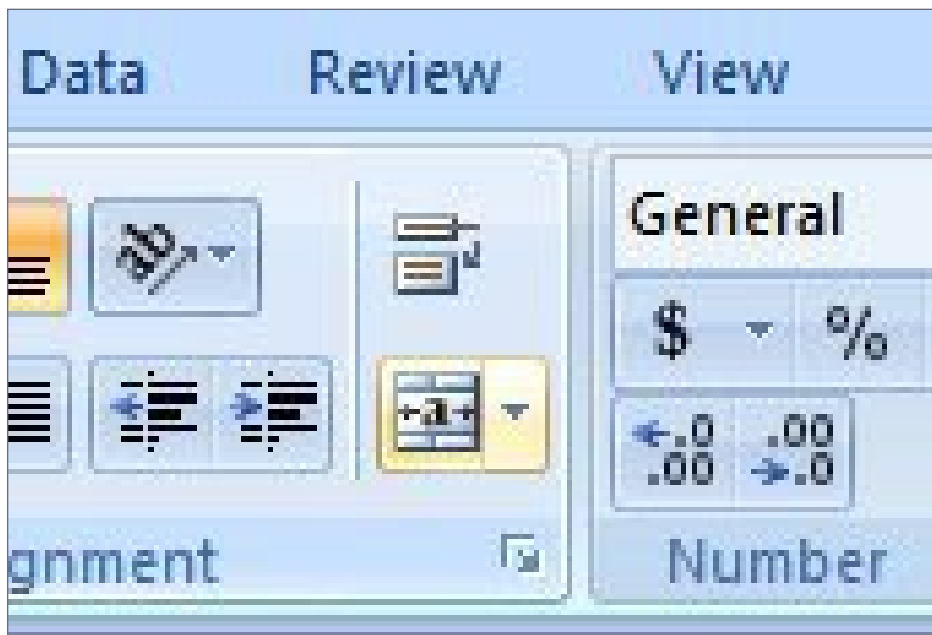

5. I'm using Excel 2010, which has the "ribbon" at the top, as well as tabs. Everything I will be doing is on the Home tab. Near the center of the ribbon (left to right) on the Home tab, is the Merge & Center button. If I click it while the 11 cells are highlighted, it will merge those 11 cells together, and any text I type will be centered in the new large single cell.

**Want to help keep
MRH free?**

Then *click on ads!*

USING EXCEL FOR TIMETABLES | 7

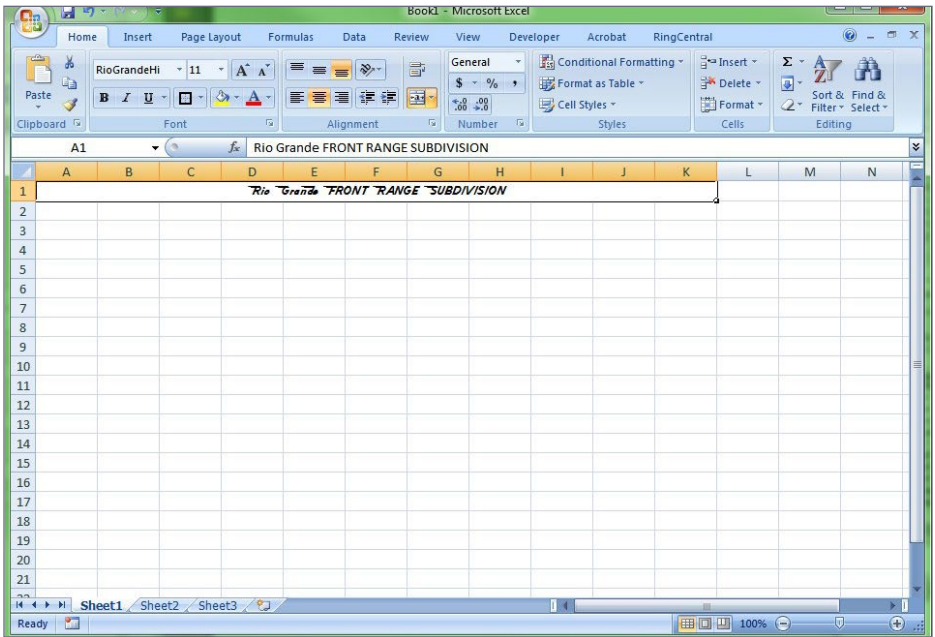

6. Having merged the top 11 cells, I typed in the name of the subdivision the timetable covers. I changed the font to make it look right. I also changed the border from **Underline** to **Thick Box Border**. The button for that is between the **Underline** button and the **Highlight/Background** color button. If you click the down arrow, it lists the different options. I selected the **Thick Box Border** and now when I want to add that type of border anywhere else, I just have to click the button again.



[Click here for reader comments](#)

USING EXCEL FOR TIMETABLES | 8

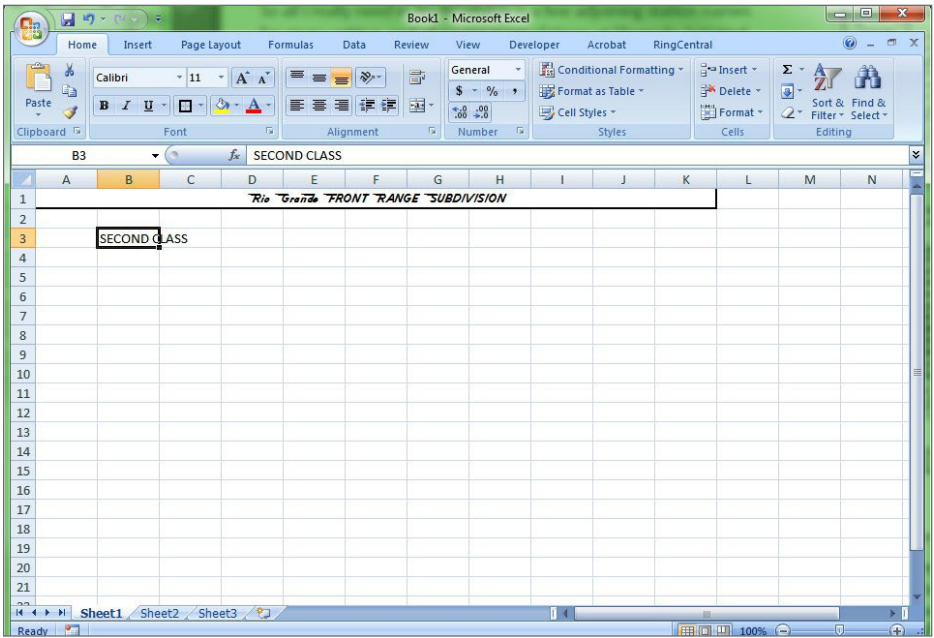

7. I now skip down to row 3. This is where the label for train class will go. The left-most column is for siding capacity, so I highlight the second column – column B. As you can see, the cell is not long enough to hold everything I typed. If I put my cursor on the line between B and C at the top, it will change to a double-headed symbol. Double-clicking with that symbol will expand the column to fit what I typed.

USING EXCEL FOR TIMETABLES | 9

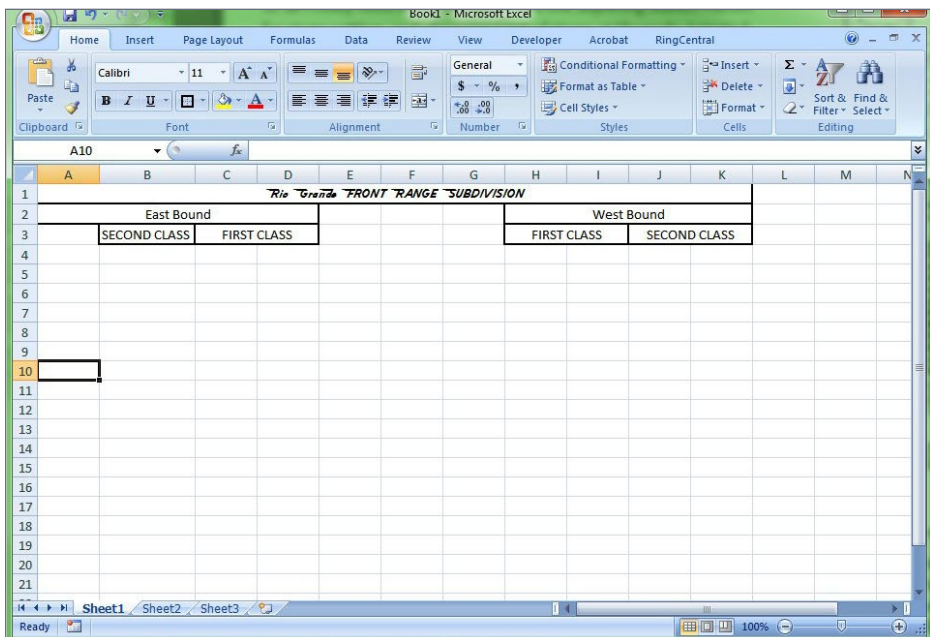

8. Using the tools I explained earlier, I have now added the **East Bound** and **West Bound** headers. As you can see, I merged two cells for each of the east and westbound first class trains, and did the same for the westbound second class trains. This is because I have two first class trains in each direction, and two westbound, but only one eastbound second class train. I also added **Thick Box Borders** around each of the labels.

USING EXCEL FOR TIMETABLES | 10

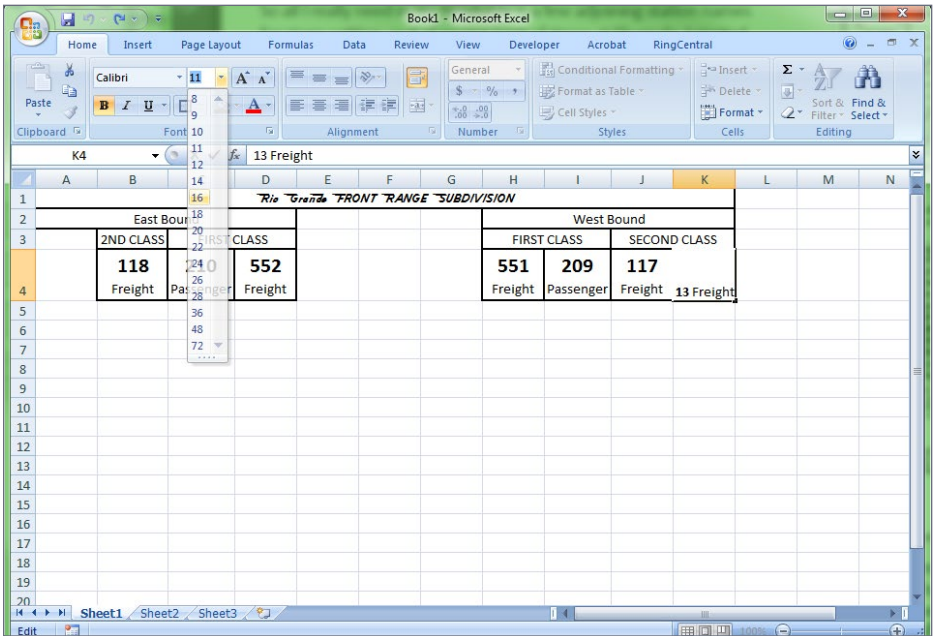

9. I changed **SECOND CLASS** for the eastbound train to **2ND CLASS** because it allows me to make the width of that one column the same as all the others. If I had kept it spelled out, that one column would have been about twice as wide as all the others, and that would have looked odd.

I've added all the train numbers, and what type they are. I used the Wrap Text button to get the train type to show up below the train number. I also highlighted the train number in the function bar (just above the column letters) and bold-faced it, and changed the font size to 16. I pressed Alt+Enter between the train number and train type in order to put the train type on a second line. I did this for several other trains as well. Last, I added the **Thick Box Border** to each cell.

USING EXCEL FOR TIMETABLES | 11

Rio Grande FRONT RANGE SUBDIVISION									
East Bound					West Bound				
2ND CLASS		FIRST CLASS			FIRST CLASS		SECOND CLASS		
118	210	552			551	209	117	13	
Freight	Passenger	Freight			Freight	Passenger	Freight	Freight	
Leaves Daily	Leaves Daily	Leaves Daily			Leaves Daily	Leaves Daily	Leaves Daily	Leaves Daily	

10. Below each train I put the frequency of departure. In this case, each train leaves daily. I also changed the font size to 8 points so that it would fit inside the cell, and centered the text both vertically and horizontally. Lastly, I change the **Thick Box Border** to outside borders (just above **Thick Box Border** on the drop-down menu) because it is a thinner line.

I did this because I want a thin line between the train number and the frequency. As I add the **Thick Box Border** to the cells all around, it will leave the thin line just between the train number and frequency.

Get the first 50 issues of
**Model Railroad
Hobbyist magazine™**

Save
yourself
endless
hours of
downloading

On a data DVD for \$10!

Send me one!

(Sold by the MRH Store)

*Includes a coupon
good for \$20 off on
TrainMasters TV*

*Over 5000
pages of
how-to
information
on model
railroading*

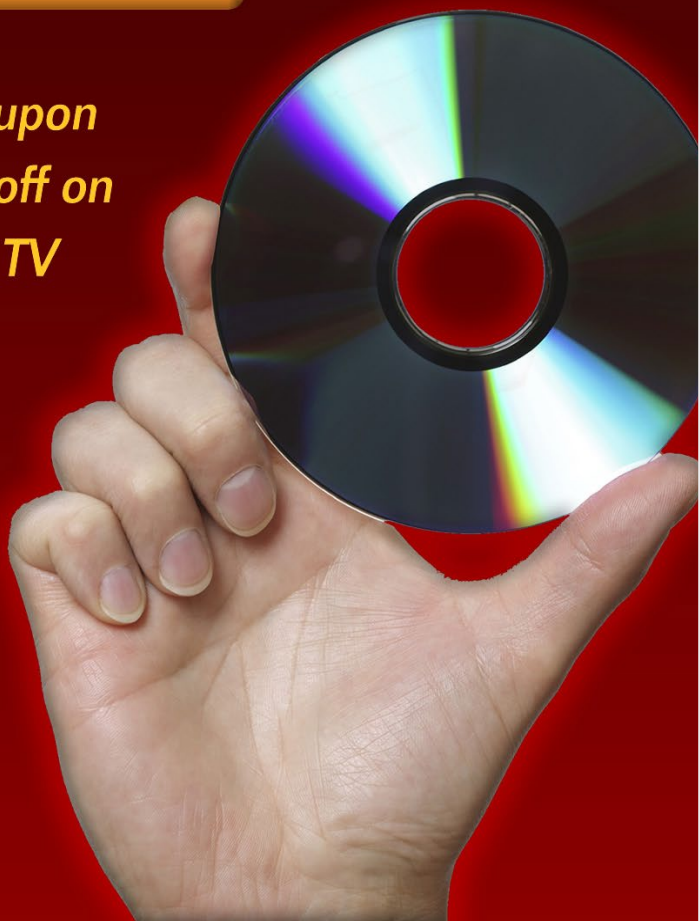

USING EXCEL FOR TIMETABLES | 12

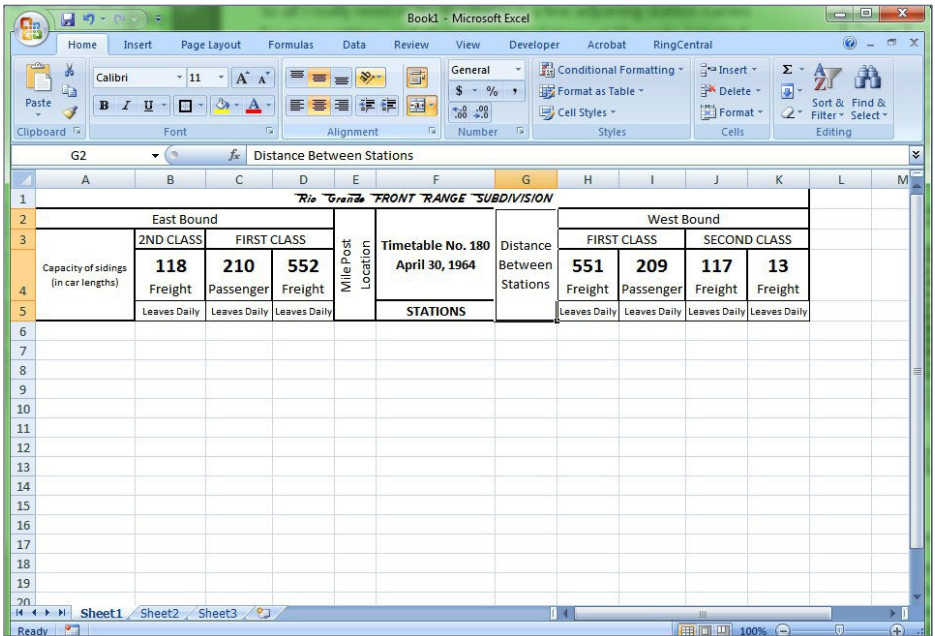

11. The timetable header is almost complete. I've merged cells A3 - A5 to create the **Siding Capacity** header. I merged cells F2-F4 for the timetable number and the date it covers, again. I again pressed Alt+Enter to get the line to break where I wanted.. Below that I added the heading of **STATIONS**. I also merged cells E2 - E5 and G2 - G5 to create the mileage headers.

I still have to rotate the text for **Distance From The Last Station**. I do that using the **Orientation** button in the **Alignment** area of the ribbon. It's the button showing the ab with an arrow under the letters, that's tilted at a 45-degree angle. I click the down-arrow to show the menu, then click the **Rotate Text Up** option. Finally, I add the **Thick Box Border** to all the appropriate cells.

I use font size and bolded text to get everything to fit just the way I want it. If something doesn't fit just right, I'll change

USING EXCEL FOR TIMETABLES | 13

Rio Grande FRONT RANGE SUBDIVISION											
East Bound					West Bound						
Capacity of sidings (in car lengths)	2ND CLASS		FIRST CLASS		Mile Post Location	Timetable No. 180 April 30, 1964	Distance From The Last Station	FIRST CLASS		SECOND CLASS	
	Freight	Passenger	Freight	Freight				Freight	Passenger	Freight	Freight
118	210	552						551	209	117	13
Leaves Daily	Leaves Daily	Leaves Daily						Leaves Daily	Leaves Daily	Leaves Daily	Leaves Daily
STATIONS											
Station 1											
Siding 2											
Siding 3											
Station 4											
Siding 5											
Station 6											
Station 7											
Siding 8											
Siding 9											
Station 10											

the font size larger or smaller. I may bold part or all of the text as well, and play with spacing for wrapped text. This is all trial-and-error. I play with it until it looks just as I want it to. You can't hurt anything that you can't undo, so it's worth the time to experiment.

Now this is starting to look like a timetable!

12. I add all of the stations, and put an outside border around each cell to get a thin line between the stations. I also make sure to center the text.



[Click here for reader comments](#)

USING EXCEL FOR TIMETABLES | 14

Ria Grande FRONT RANGE SUBDIVISION										
East Bound					West Bound					
Capacity of sidings (in car lengths)	2ND CLASS	FIRST CLASS		Mile Post Location	Timetable No. 180 April 30, 1964	Distance From The Last Station	FIRST CLASS		SECOND CLASS	
	118 Freight	210 Passenger	552 Freight				551 Freight	209 Passenger	117 Freight	13 Freight
	Leaves Daily	Leaves Daily	Leaves Daily				Leaves Daily	Leaves Daily	Leaves Daily	Leaves Daily
STATIONS										
				0	Station 1	12.5				
				12.5	Siding 2	12.5				
				25	Siding 3	12.2				
				37.2	Station 4	12.8				
				50	Siding 5	8.5				
				58.5	Station 6	4.2				
				62.7	Station 7	12.3				
				75	Siding 8	12.5				
				87.5	Siding 9	12.5				
				100	Station 10	12.5				

13. I add in the mile posts and distance between each station. Since I am pulling this information out of thin air for this example, you'll notice the stations are all almost equal distance from each other. You would of course use the information for your actual stations and other places where trains can meet. I again center the text, and place an outside border around each cell, to get a thin line.

**When talking to
hobby vendors, please
remember to mention
MRH.**

iwata

by ANEST IWATA

Just Rolling By...

Make It **REAL** With Iwata
Climb Aboard!



**Eclipse
HP - CS**

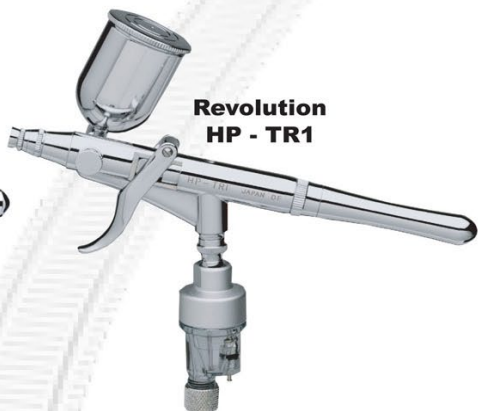

**Revolution
HP - TR1**

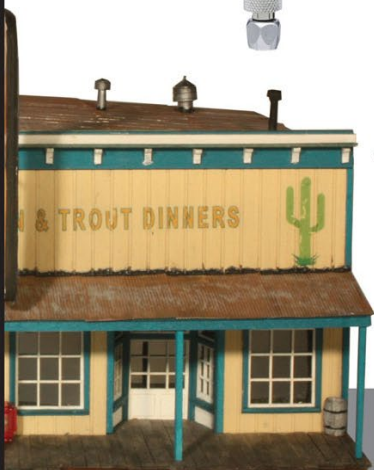

Visit...
www.iwata-medea.com
**To Check Out Our
Full Product Line!**

*Models By... Alan Houtz,
North American Prototype Modelers*

USING EXCEL FOR TIMETABLES | 15

Rio Grande FRONT RANGE SUBDIVISION											
East Bound					West Bound						
Capacity of sidings (in car lengths)	2ND CLASS		FIRST CLASS		Mile Post Location	Timetable No. 180 April 30, 1964	Distance From The Last Station	FIRST CLASS		SECOND CLASS	
	118 Freight	210 Passenger	552 Freight					551 Freight	209 Passenger	117 Freight	13 Freight
	Leaves Daily	Leaves Daily	Leaves Daily	Leaves Daily				Arrives Daily	Arrives Daily	Arrives Daily	Arrives Daily
	AM	AM	PM				AM	PM	PM	PM	
	8:00	10:00	1:05	0	Station 1	12.5	9:30	6:55	7:21	1:00	
	8:40	10:22	1:45	12.5	Siding 2	12.5	8:50	6:33	6:59	12:20	
	9:20	10:40	2:25	25	Siding 3	12.2	8:10	6:15	6:41	12:00	
	10:00	11:05	3:05	37.2	Station 4	12.8	7:30	5:55	6:16	11:40	
	10:40	11:30	3:45	50	Siding 5	8.5	6:50	5:30	6:46	11:20	
	11:20	11:47	4:25	58.5	Station 6	4.2	6:00	5:13	6:33	11:00	
	12:00	12:10	5:05	62.7	Station 7	12.3	5:30	4:36	6:10	10:20	
	12:40	12:42	5:45	75	Siding 8	12.5	4:50	4:08	5:38	9:40	
	1:20	1:02	6:25	87.5	Siding 9	12.5	4:30	3:28	5:18	9:00	
	2:00	1:20	7:05				4:00	3:00	5:00	9:20	
	PM	PM	PM	100	Station 10	12.5	AM	PM	PM	AM	
	Arrives Daily	Arrives Daily	Arrives Daily				Leaves Daily	Leaves Daily	Leaves Daily	Leaves Daily	

14. Now it's looking like a timetable! I've added all the times for each station. I've also centered all the text, and put an outside border around each cell. The top and bottom of each column, where the **AM/PM** appears, I had to do a little playing with. Excel doesn't usually care what you put into a cell, but if the cell contains a number in front of text, it changes the format to **Custom**. This means that you can't change the formatting on text. When you have a number in front of text, as you see at the bottom, with the arrival and departure times, be sure to go up to the **Number** section of the ribbon, just under **View**, and change General to **Text**. That way Excel knows everything in the cell is to be treated as text.

In fact, since we calculated the number of rows and columns at the beginning, I could have highlighted them all, and changed them all to **Text** at the same time. Unfortunately, these are some of the things you don't think of until you run into a problem.

USING EXCEL FOR TIMETABLES | 16

Ria Grande FRONT RANGE SUBDIVISION											
East Bound					West Bound						
Capacity of sidings (in car lengths)	2ND CLASS		FIRST CLASS		Mile Post Location	Timetable No. 180 April 30, 1964	Distance From The Last Station	FIRST CLASS		SECOND CLASS	
	118 Freight	210 Passenger	552 Freight	551 Freight				209 Passenger	117 Freight	13 Freight	
	Leaves Daily	Leaves Daily	Leaves Daily	Arrives Daily				Arrives Daily	Arrives Daily	Arrives Daily	
	AM	AM	PM		Station 1	12.5	AM	PM	PM	PM	
18	8:00	10:00	1:05	0	Station 1	12.5	9:30	6:55	7:21	1:00	
22	8:40	10:22	1:45	12.5	Siding 2	12.5	8:50	6:33	6:59	12:20	
30	9:20	10:40	2:25	25	Siding 3	12.2	8:10	6:15	6:41	12:00	
21	10:00	11:05	3:05	37.2	Station 4	12.8	7:30	5:55	6:16	11:40	
10	40	10:40	11:30	3:45	50	Siding 5	8.5	6:50	5:30	6:46	11:20
25	25	11:20	11:47	4:25	58.5	Station 6	4.2	6:00	5:13	6:33	11:00
12	28	12:00	12:10	5:05	62.7	Station 7	12.3	5:30	4:36	6:10	10:20
13	45	12:40	12:42	5:45	75	Siding 8	12.5	4:50	4:08	5:38	9:40
14	62	1:20	1:02	6:25	87.5	Siding 9	12.5	4:30	3:28	5:18	9:00
15	25	2:00 PM	1:20 PM	7:05 PM	100	Station 10	12.5	4:00 AM	3:00 PM	5:00 PM	9:20 AM
16		Arrives Daily	Arrives Daily	Arrives Daily				Leaves Daily	Leaves Daily	Leaves Daily	Leaves Daily
17		(5:00) 25.2	(3:20) 40.5	(6:00) 17.6		-- Time over District -- -- Average Speed --		(5:30) 22.7	(3:55) 32.8	(2:21) 48.8	(4:40) 28.5

The last thing I did, was highlight the areas I wanted to put a **Thick Box Border** around. You can see in the picture above that I've highlighted all the cells on the westbound side containing times. Once I click the button, the border will appear around the outside of the highlighted area.

15. Here you have the finished timetable. I've added the last of the information, and played around with some of the borders to get the double lines. I adjusted the columns so that all the times are the same width. That did squeeze the 2ND Class label for the one eastbound train. I could widen it a bit, and readjust the other time columns to that new width in a few seconds.

USING EXCEL FOR TIMETABLES | 17

From start to finish, the employee timetable is probably a couple of hour's work or less (it took me a lot longer because I was taking screen shots and writing this article at the same time), and the beauty of it is, this isn't just for TT&TO operations. Even a fully signaled layout can benefit from having an employee timetable, since it lists all the trains, all the places the train might stop, and roughly what the fast clock should read when the crew gets to each station.

Because this is an example, and not a real timetable, the times are fictitious, though I did try to make them relative to the prior station. I noticed that through freight No. 13 comes into the station five minutes before train No. 552 departs. There's also a possibility of train 13 and passenger train 210 meeting at Siding 5. The passenger train has priority, so train 13 will have to wait. Had this been an actual timetable, I would have tried to arrange more potential meets.

You can print as many timetables as you need before the operating session, and you can modify any part of it in a few seconds, so as conditions of the ops sessions change, you can keep the timetable up-to-date. Another advantage is that you can highlight the entire timetable, or any part of it, and copy-and-paste it to Sheet2, or Sheet3. By right-clicking on a tab, you can change the name of that sheet, or change the color of the tab so it stands out.

This means you can have several different variations of the employee timetable to choose from. This comes in handy when a shortage of operators means that some trains won't run that day, or you want to add extra trains for difficulty.

USING EXCEL FOR TIMETABLES | 18

Hopefully I've given you a good enough example of how you can use Excel to create an employee timetable, that you'll make your own. You can make the timetable as simple as you want, or as complex as you need. The only limit is your imagination, and the time you want to put into the project. ✓



**Click here for
reader comments**

KEN BILES



Ken Biles has been interested in model railroading since his dad first brought out the HO scale train, and the hobby how-to books from the early 1960s. By day he works as a computer operator for a financial company. By night he has been known to head out with his brother and friends to play guitar, mandolin, or drums at an open-mic event around town.

In his spare time, Ken has been slowly working on a website to help people learn how to build their own model railroad (modelrailroadhowto.com). Ken bought an easement for his railroad (a house) about three years ago, but has yet to break ground on the right-of-way. His cunning plan is to shoot video of building the layout from start to finish, and make the videos available through his website. ■

SOUTHERN PACIFIC'S

Passenger cars:

More than just the Daylight, Part 5

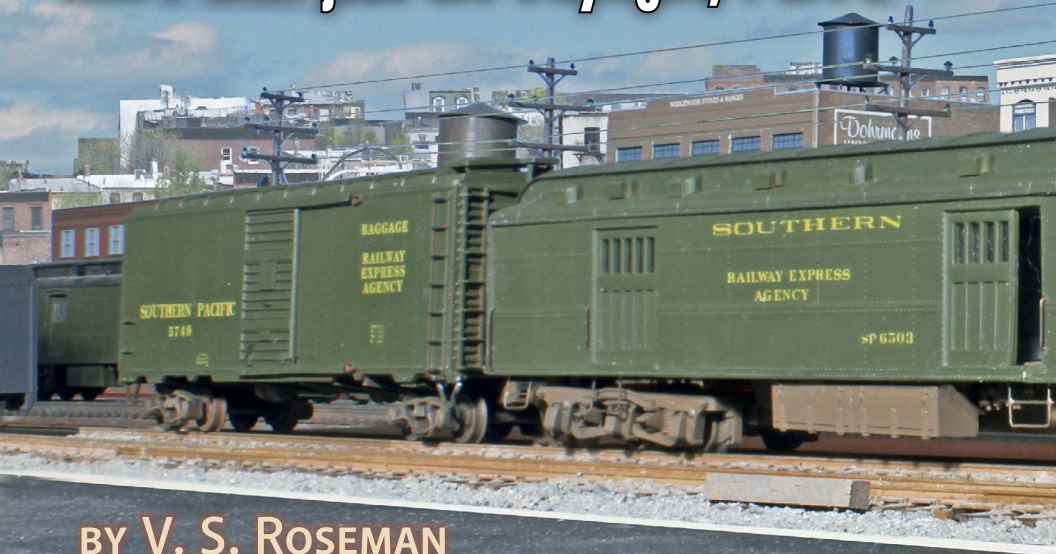

BY V. S. ROSEMAN

.....
*Photos by V. S. Roseman
unless otherwise noted*

PART 5: HEAVYWEIGHT CARS YOU CAN BUILD

THE AVAILABLE READY-TO-RUN DAYLIGHT car sets generally represent prewar cars of the 1941 Daylight train and post-World War II (circa 1946-1953) trains.

The SP consists evolved as the train adapted to meet the needs of the public. The Daylight-type chair cars and feature equipment filtered down to long distance SP trains at various times, usually when replaced with new equipment on the Daylight.

MRHMAG.COM

- [TABLE OF CONTENTS](#)
- [INDEX](#)



1. Here is the auto door end of a Class 80-BH-1 model in dark olive green. The prototypes were converted from 1937-built horse cars. This article covers how to model these cars accurately, along with many other types of heavyweight passenger cars used by the SP.

Many of the cars needed to model different time periods or other trains are not available as ready-to-run models, although a number of kits and some stand-in cars are available.

In most cases, a stand-in model or one of these conversions, when seen on a moving train on a model railroad, will give the



[Click here for reader comments](#)

impression of the correct car. Some of the suggested projects leave you with a model that might be one or two windows different from the prototype, or with some other minor differences.

These models will not win prizes at contests for conformance to the prototype, but this is called modeling for effect, which requires certain compromises.

Some readers will only be satisfied with fully accurate models, and fortunately, a great number of SP passenger cars are available as handmade brass models. The diagrams and text should serve as a guide for those modelers who want to search down brass models made over the years.

I have attempted to show several different methods of construction, keeping to the simplest means, and avoiding a lot of cutting and splicing of carbodies where possible.

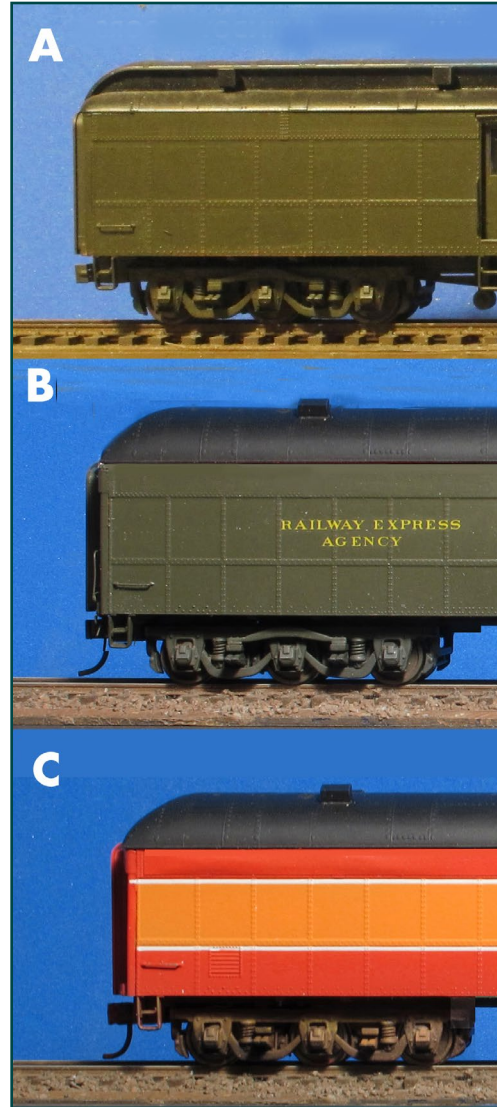

PART 5 - SP PASSENGER CARS | 4

WALTHERS UNDECORATED MODEL WITH MULTI-WINDOW DOORS



2. Walthers ACF Missouri Pacific Baggage Express car (932-10500) in panel A. Panel B shows my conversion to an SP 70-B car. Panel C shows a conversion in Daylight colors. Fortunately, detailed resin kits of this car are available from Southern Car and Foundry.

80-BH-1 CLASS BAGGAGE EXPRESS

TWO BETHLEHEM CNJ BAGGAGE CAR SIDES ARE NECESSARY TO MAKE EACH SIDE OF

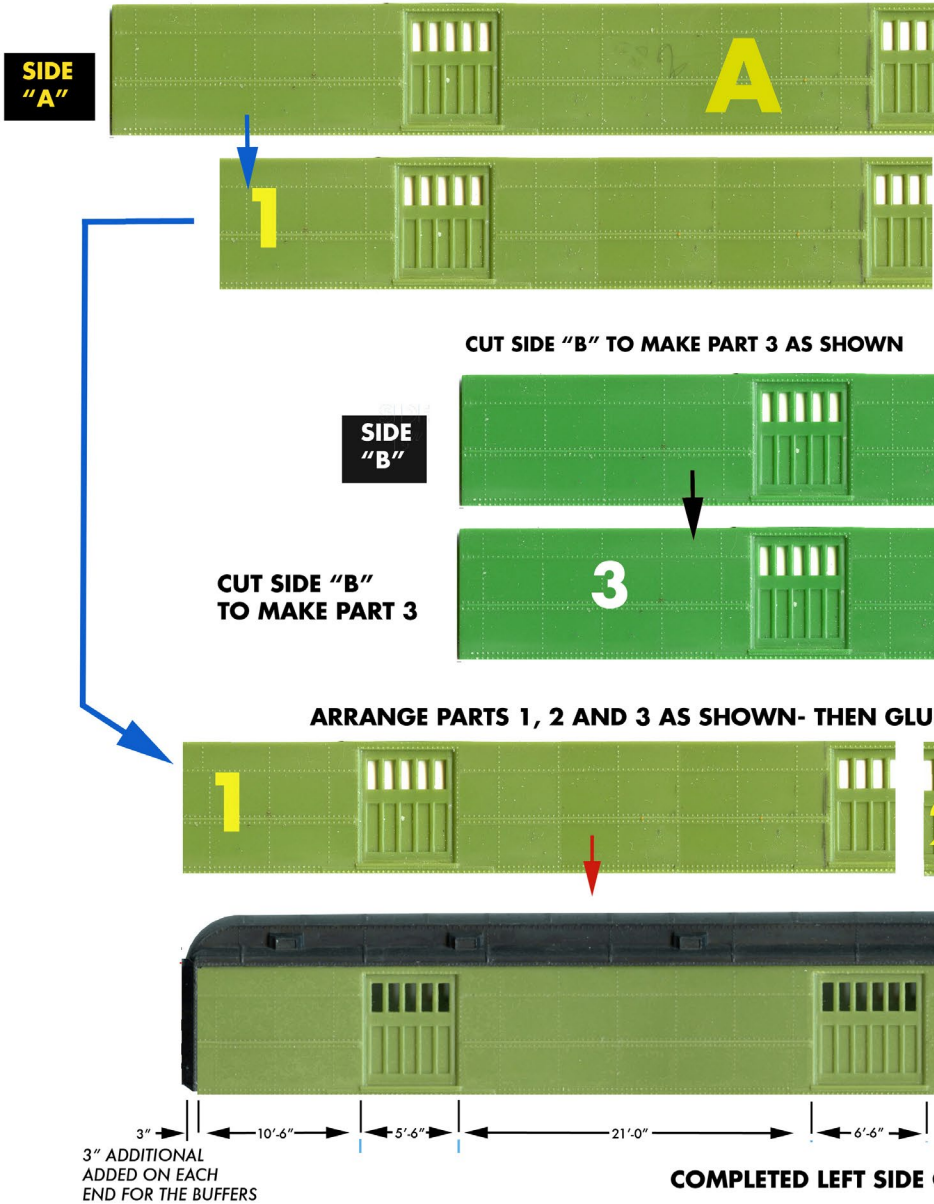

3. Left side part diagram for Class 80-BH-1 model. The parts are Bethlehem Car Works CNJ baggage car sides as

CESS CAR - LEFT SIDE

THIS MODEL- COLORS ARE TO IDENTIFY PARTS USED FROM EACH SIDE.

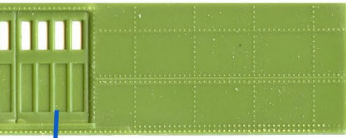

CUT SIDE "A"
TO MAKE PARTS
1 AND 2 AS SHOWN

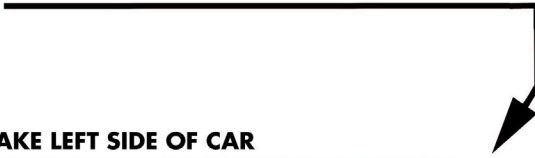
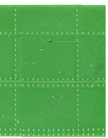
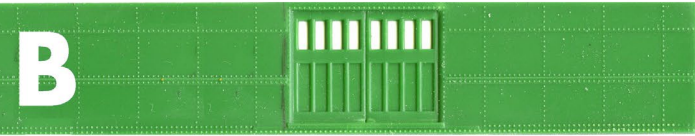

TO ROOF TO MAKE LEFT SIDE OF CAR

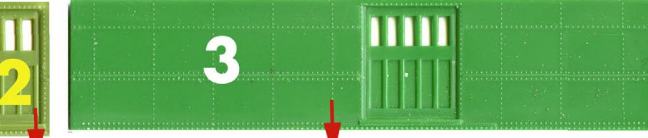

AUTO DOOR
END

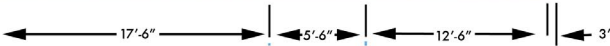

OF CAR

fitted to a Rivarossi or similar roof.

“Until about 1955, heavyweight cars regularly assigned to streamliners were supposed to be painted to match their trains.”

Details of equipment classes varied not only from car to car, but also over the years, sometimes considerably for some of the cars the SP completely rebuilt. I have included some links for those who want to add more specific detailing, and the bibliography shows the books used which provide much more information.

I have concentrated on the car bodies, although I have hopes of eventually correcting any outstanding details such as the underbody equipment.

Listing all of the car assignments month by month would require a book in itself. The subject is complicated and beyond the scope of this series. Cars were often deadheaded to servicing points and might be seen in one photograph only.

Some cars were assigned to a run for a few months at a time, such in the peak periods, or might be called in for a short time in protect service.

Dennis Ryan and Joseph Shine have done a great deal of work to this end in their two volume set *SP Passenger Trains of the Coast Line*. (Vol. 1, *Night Trains* and Vol. 2, *Day Trains*)

In general, until about 1955 the streamliners ran with matching equipment, but after this time, it was more likely to see cars of most any SP color scheme on a train.

Notes about SP heavyweight cars used on Southern Pacific streamliners

It is unlikely that the Coast Daylight (Morning Daylight) ever ran with any heavyweight cars, although some heavyweight cars did run on second sections.

However, most of the other Southern Pacific trains have been documented with heavyweights either as regular assigned equipment, or as replacement cars that were called in when lightweight cars were being serviced.

On occasions when a feature car was in the shops, or when a tour group was bigger than expected and lightweights were not available, so that the consist swelled beyond the available lightweight equipment, then heavyweight cars would appear on these trains.

Until about 1955, heavyweight cars regularly assigned to streamliners were supposed to be painted to match their trains, while others were being repainted into the two-tone gray scheme.

By 1958, intercity cars began to be repainted in imitation stainless steel using a red letterboard with gray lettering, but some cars served in whatever color they were last painted until they were scrapped.

Southern Pacific heavyweight cars were constructed differently than those on most other railroads. The Harriman-owned roads, including SP, Union Pacific, Alton and other associated railroads, first ordered cars designed by the Common Standard design team. This association, however, was broken up in 1913 due to anti-trust laws.

80-BH-1 CLASS BAGGAGE EXP

COLORS ARE TO IDENTIFY PARTS USED

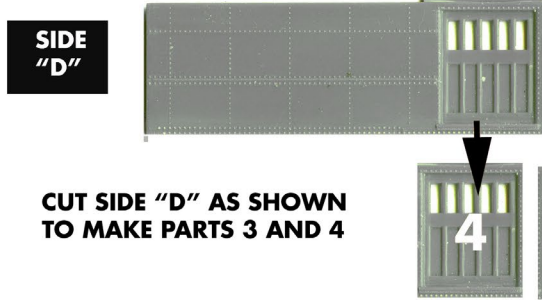
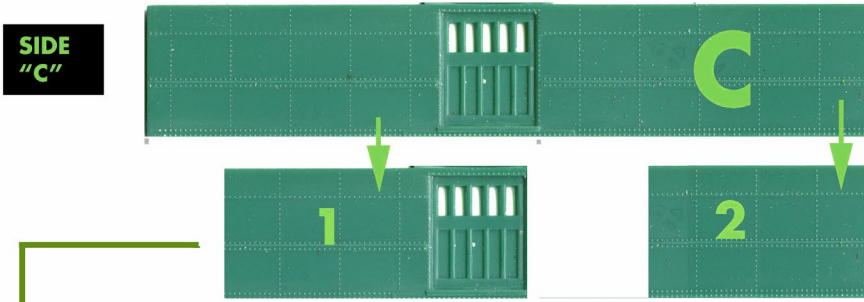

ARRANGE PARTS 1, 2, 3, 4 AND 5 AS SHOWN AND GLUE

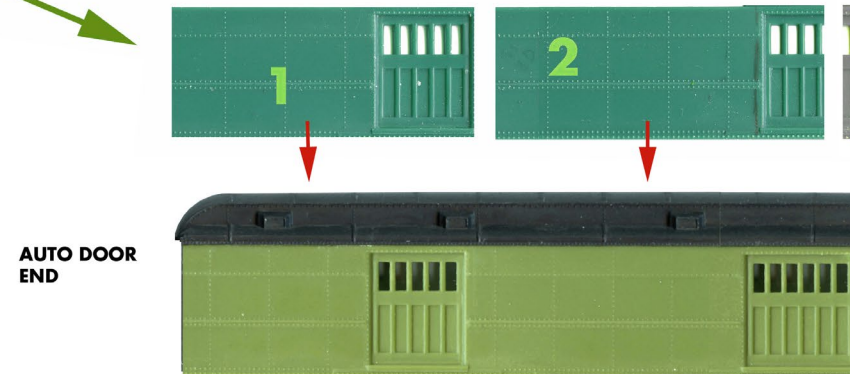

3" → | | ← 12'-6" → | ← 5'-6" → | ← 17'-6" → | ← 6'-6" →

3" ADDITIONAL
ADDED ON EACH
END FOR THE BUFFERS

PRESS CAR - RIGHT SIDE

FROM EACH SIDE.

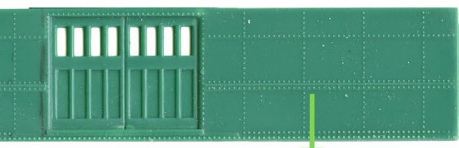

CUT SIDE "C" AS SHOWN TO MAKE RIGHT SIDE OF CAR PARTS 1, 2 AND 5.

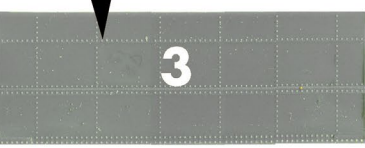
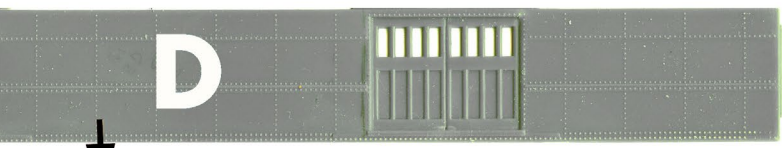

TO ROOF TO MAKE RIGHT SIDE OF CAR

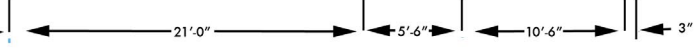
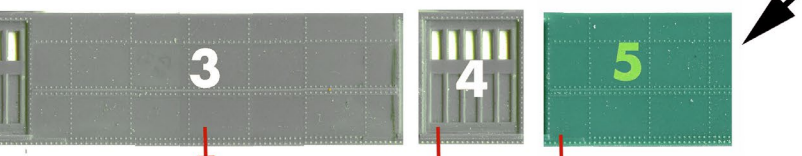

RIGHT SIDE OF CAR

4. Right side Class 80-BH-1 parts diagram.

PART 5 - SP PASSENGER CARS | 11

Southern Pacific cars built up to the 1930s employed Common Standard design paired 15 inch I-beam frames tapered down to 10 inches near the ends to clear the trucks.

Nearly all other heavyweight steel cars had built-up steel fish belly frames. Instead of the clerestory or monitor roof found on most railroad passenger cars, Common Standard passenger cars had arch roofs.

Beginning in 1927, the Southern Pacific switched their specification to clerestory roofs on passenger cars, possibly because of lower prices being offered by the car builders for standardizing parts.

Common Standard car ends had their end sheets mounted to the outside of the collision posts. Most other cars had steel sheets mounted to the inside of the collision posts on blind (non-vestibule) ends. SP cars built after about 1928 had this conventional type blind end.

Between 1930 and 1940 a number of SP cars received ice bunker air conditioning. In 1937 the new lightweight streamlined cars received Carrier Steam Ejector air conditioning. Some heavyweight cars received Steam Ejector a/c units, and some of the ice a/c cars were converted to this system.

Due to problems encountered with steam leaks on long trains, the railroad switched to ordering Waukesha ICE engine systems by 1938. ICE = Internal Combustion Engine, propane powered.

Some cars received a second Waukesha unit called an Enginator for powering lights. Some postwar-built cars had Pullman Electromechanical type air conditioning units. Until 1948, sleeping cars were owned by the Pullman Co., not by the SP.

“Most Southern Pacific passenger trains ran with heavyweights in the consist...”

The air conditioned clerestory roof SP cars usually had narrow ducts on the outside of the roof or ducts inside the clerestory that did not show. Pullman cars had the wide type of duct on their car roofs.

In HO scale, Precision Scale Co., Train Station Products, and New England Rail Shops offer air conditioning equipment that can be used on the models. The Cal Scale UC passenger brake set has the components for most heavyweight cars, although some cars had two brake cylinders.

I have been gradually replacing the original trucks on my models with more correct classes of trucks. Most of the cars shown here still have Rivarossi six-wheel trucks. I have replaced many of the original plastic wheels with Northwest ShortLine 36 inch wheels. I file down the mounting boss of the bodies slightly to get the correct car height. Railhead to top of roof is 14 feet in HO scale for Common Standard heavyweight cars.

On most of the 60-foot cars I use the Model Power four wheel trucks that come with their round-roof passenger cars, to which I add end beams and metal wheels. The new Roundhouse round roof cars in the Athearn line come with good trucks resembling the prototype, and they already have metal wheels. Various types of other trucks are available patterned after the actual truck classes used on the SP prototypes.

Some models mentioned here are discontinued and may not be available through hobby retailers, but as most have been produced in huge quantities for up to 50 years, they are usually easy to find at model train swap meets or online.



5. "B" or brake end of Class 80-BH-1 baggage car in Daylight colors.

Class 80-BH-1 mail and express cars, ex-horse cars

Many photos of the postwar San Joaquin Daylight, the Starlight, Lark and the Noon Daylight show these huge 80-foot head end cars in their consists. These cars were refurbished versions of the horse cars built by St. Louis Car Company with fish belly underframes in 1937. Other than the lettering, these cars had little or no change of the exterior from their horse carrying days.

One end of the car was completely open with hinged automobile doors to admit large loads, while the other end was a railroad-type blind end. These cars had flat steel sheets mounted to the inside of the collision posts in typical railroad style.

While these cars could be used to haul automobiles, theater scenery or other large express loads, their usual loads were sealed mail sacks, express and passenger checked baggage.

PART 5 - SP PASSENGER CARS | 14

CLASS 80-BH-1 HORSE CARS WITH INTERIORS CONVERTED FOR BAGGAGE, MAIL AND EXPRESS SERVICE

AUTOMOBILE DOOR END OF CAR

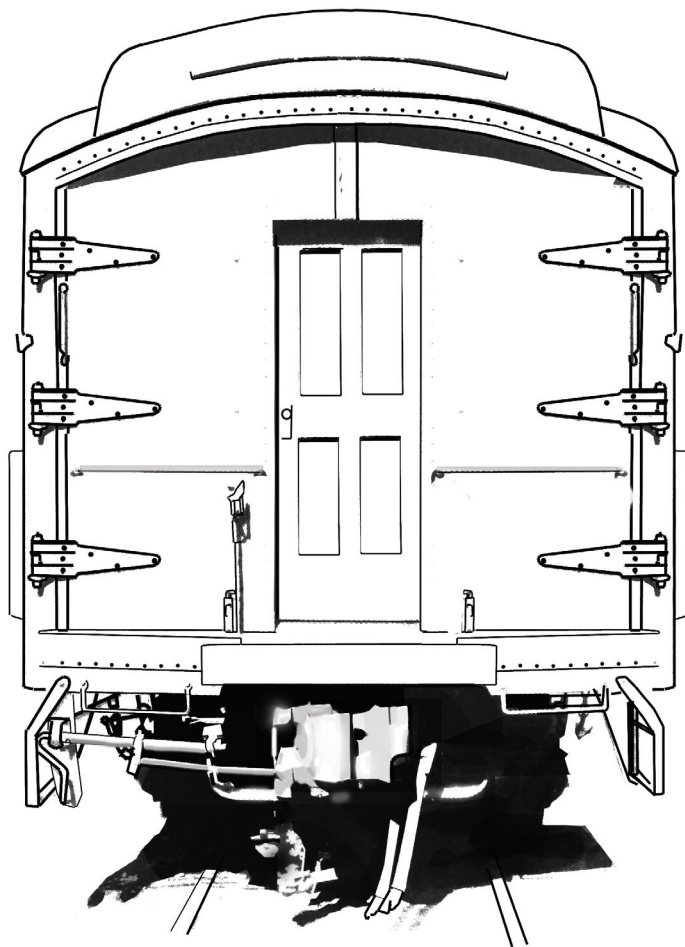

6. Sketch by author showing automobile doors of Class 80-BH-1.

PASSAGEWAY DOOR IS SUSPENDED FROM BAR ATTACHED TO AUTO DOOR ON RIGHT SIDE TO PERMIT SLIDING IT OUT OF THE WAY WHEN AUTOMOBILE DOORS ARE OPENED

No plastic cars of this type are available, but it is possible to make a close replica from plastic parts. Bethlehem Car Works

has several flat injection molded baggage express car sides in their “Kitbit” line. This link brings their catalog of parts:

bethlehemcarworks.com/Products/Kit_Bits/index.html

The sides are nicely detailed, made of styrene and available at very modest prices. I used two pairs of their #21E Central of New Jersey sides for my 80-BH-1 cars.

The roofs are from a Rivarossi 1920 series Pullman car. The Garland vents (if using the Pullman roof) should be sanded down or cut off and new box vents added. Box vents can be made by cutting 12 squares of Evergreen strip styrene and gluing them to the stumps of the Garland vents along the clerestory. I measured the spacing and added shims so all the vents would appear the same. I left the additional molded vents, but these could be removed.

The car sides are based on the prototype measurements shown, but are adjusted slightly to fit the length of the roof (it is a few scale inches off from the prototype).

Making the car a couple of inches different to conform to the prototype is possible if you cut and splice the roof. Since this does not correct other details such as the height of the letterboard, riveting pattern, door type and others, adjusting the length of the sides to the existing roof length makes this a much easier project.

On the clear molded Rivarossi roof, I made marks 1/8-inch below the roofline into the clear window area, and scribed this line with an acrylic cutter. Olfa and X-Acto are two brands. I sawed along the line leaving a 1/8-inch clear flange below the roof to glue the car sides. The sides have a notch at the bottom to accept a snap-in floor.



7. Here are the automobile doors in open position to unload a shiny Buick at San Francisco. Shown is an SP baggage express 70-B type, but doors are similar to the 80-BH-1. The passage-way door and frame are mounted on a slide and moved behind one of the opening doors..

Following the diagrams provided, the middle door must be spliced. File the parts so when joined, there are six windows of equal size. The two smaller doors should be cut from the sides leaving about 1/16-inch outboard of the rivet strips adjacent to the doors as the sheet metal cap that meets the sides of the prototype car.



8. Blind end of Lackawanna baggage car, a typical arrangement similar to SP 80-BH-1 cars. The end sheets of the car are flat and are mounted to the inside of the collision posts framing the door.

PART 5 - SP PASSENGER CARS | 18

The blind end (with the brake wheel) from the Rivarossi car should be cut from the Pullman body and glued to the roof, making sure it is a 90 degree angle to the roof. Begin gluing the sides to the roof starting from this end, one piece at a time. Test fit each part and sand each to fit square. I use a Northwest ShortLine TruSander.

The doors of the model have five windows as does the SP car, but the doors of the model are wider and shorter than the prototype SP car. You could frame out the doors yourself with Evergreen styrene quarter round strips, and you can make accurate doors from styrene by hand or by using a digital cutter such as the Silhouette products. I used the doors of the kit. The sides can be reinforced from the back with strip styrene after all of the side panels in place.

I made my own automobile door end, by tracing the Rivarossi end on a sheet of .015-inch thick styrene. I cut the opening for the passageway door and used a Micro Engineering #80-063 four-panel house door glued from behind the opening. I glued the new end to the sides and roof. I added Grandt Line #4014 hinges from their set of S scale refrigerator door hardware.

Six hinges are used. I bent Evergreen strip to conform to the underside of the roof for the arch form fascia on the end. The buffer made of strip styrene was glued in place at this time. I drilled the car for wire hand grabs and added these. I built these cars before Archer rivet decals were available, but these could be added to improve the look of the automobile doors.

The car floor is made of .040 -inch thick Lexan sheet, (styrene or acrylic will work as well) and I cut this to snap into the slot in the back of the car sides so it remains removable. I used two Bethlehem Car Works Kitbits fish belly underframes spliced to fit this long car.

PART 5 - SP PASSENGER CARS | 19

As I was using Rivarossi trucks, I drilled the kingpin hole and built up the mount with short lengths of styrene tubing to copy Rivarossi's truck mount. I used a nut and bolt to hold the truck instead of the Rivarossi plastic pin. Side bearers made of styrene strips were added on one bolster forming a three point suspension to prevent the model from excessive rocking back and forth. I replaced the plastic wheels were replaced with 36-inch metal wheels with RP25 flanges, which make the trucks look much better.

The drop equalizers could be filed down and covered with thin styrene cut to the more rounded equalizer form used by the Southern Pacific, or several types of six wheel trucks are available from aftermarket part manufacturers.

I added the large air pressure water system tank (available from Precision Scale) and a Cal Scale UC passenger airbrake set.

My car is plumbed with styrene rod, but brass rod could be used if you prefer. The underbody can be more fully detailed if you wish. I did not find any corner steps that looked much like the ones on this prototype, so I cut some from brass rod and soldered the crossbar in place. Lost wax castings for SP steps are available now, but were not back when I built my cars.

The cars are lettered with Microscale decals. In addition to the olive green and the Daylight colors, some 80-BH-1 class cars were painted two-tone gray in the 1950s and at least one of the prototype cars was finished in silver with red stripe after 1955.

Many other head end cars can be made using this simple method of construction. The main advantage is that all the splices are done next to a door so they are not obvious.

The plan size offered here can be adjusted in a picture or photo program. If you don't have the necessary software, make a screen

“In addition to the olive green and the Daylight colors, some 80-BH-1 class cars were painted two-tone gray.”

image by clicking the “print screen” key on a PC or on a Mac computer, press command+shift+3. This will make a .png file of your screen image. You can convert this to a .jpg file if you like. If you have a photo manipulation program such as Photoshop, you can scale the plan and print it. Otherwise, print the image and use a copying machine to enlarge or reduce it to scale.



9. A prototype SP Class 60-B-4, with equal size doors in Fresno, 1955 in two-tone gray. *Courtesy Bob's Photos*



10. Out of the box HO Athearn-Roundhouse round roof car, Similar to SP prototype 60-B-9, but with a slightly different door spacing.

60-B-9 baggage express car, 70-foot baggage express car

Photos of the Athearn-Roundhouse 60-foot baggage express car resembling the prototype 60-B-9 and a prototype 60-B are shown for reference. Photos indicate that some were used often enough to have been painted in streamliner colors. The 70-foot car is not available ready-to-run, but Southern Car and Foundry lists a 70-foot Harriman baggage car resin kit that appears to be an SP prototype, as kit #1002:

southerncarandfoundry.com



11. Rivarossi Pennsylvania prototype baggage/RPO stands in for SP 77-BP-60 class car 6045.

Railway Post Office-baggage cars 77-BP-60-1, 80-BP-60-1 for San Joaquin Daylight, West Coast and The Owl

In 1950, three 80-foot long RPO cars in Class 80-BP-60-1 were built from heavyweight horse cars and were numbered 5217, 5218, and 5219.

Two similar 77-foot RPO cars in Class 77-BP-60-1, numbered 5044 and 5045, were built from heavyweight dining cars in 1954. No plastic models of these cars are available.

REBUILT RAILWAY POST OFFICE DESIGN OF THESE CARS WAS DETERMINED BY THE SPECIFICATIONS AND OTHER RAILROAD

RIVAROSSO MODEL RPO/BAGGAGE, 1930 SERIES, SHOWN WITH CLERESTORY ROOF CONVERSION
(MODEL REPRESENTS PENNSYLVANIA RAILROAD MODERNIZED RPO/BAGGAGE CAR FOR 1948 BROADWAY LIMITED)

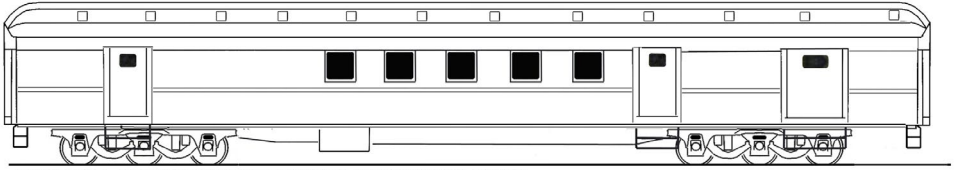

THIS MODEL CAN STAND IN FOR THE SP CLASSES SHOWN ABOVE

CLASS 77-BP-60 CARS 6044, 6045 BUILT 1954
REBUILT FROM OLD DINING CARS

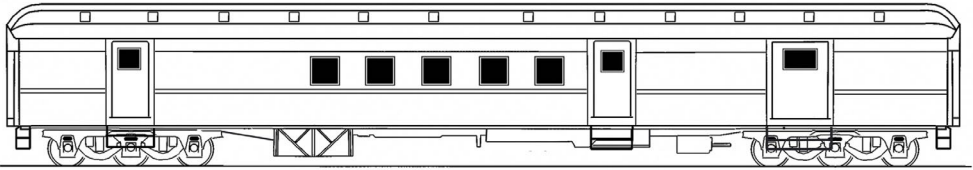

12. Sketches of the prototype SP Railway Post Office Cars, Class 80-BP-60 and 77- BP-60, also showing appearance of Rivarossi Pennsylvania Railroad RPO model that can be used as a stand-in car.

The Rivarossi 1930 series RPO car can be used as a stand-in model. The clerestory roof from a Rivarossi 1920 series heavy-weight coach could be fitted to this car.

Sections of the clear window flange behind each door must be cut away around the door protrusions molded into the body. It is possible to extend the length of these cars to more closely resemble the prototype, but the number of cuts and splices make that a complicated project, and I left my models at their 75-foot lengths.

The 77-BP-60 cars were built with single window ply metal doors resembling those on the Rivarossi model. The 80-BP-60-1

OFFICE/BAGGAGE CARS

MODIFIED GREATLY BY POST OFFICE

ROADS HAD SIMILAR CARS

Class 80-BP-60, Cars 5217, 5218 built 1950, CAR 5219 built 1954 - converted from 80-BH-1 horse express cars. Shown as built with original wooden doors.

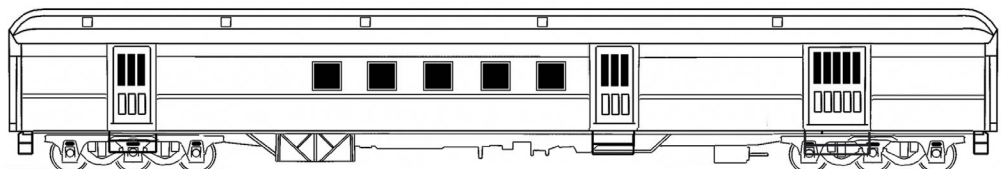

Class 80-BP-60 cars as rebuilt with ply-metal doors, c1960.

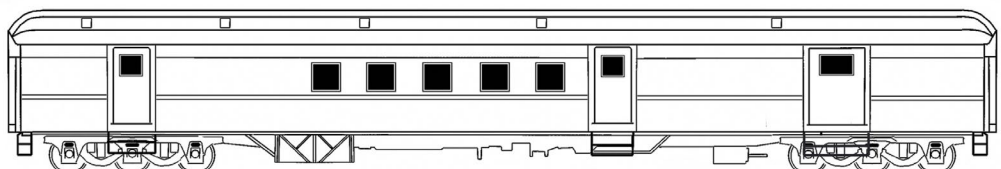

cars were built with multi-window wooden doors which were changed to the ply metal type within a few years. It is possible to make styrene panel doors and fit these over the model's doors to simulate the original appearance of the 80-BP-60-1 car, or to remove the model's doors and make new ones. See the lightweight Sunbeam baggage express car for a diagram.

Both classes of cars had distinctive Budd battery box covers available from Train Station Products, as #465 in HO, used on a lot of SP lightweight cars. 80-BP-60-1 cars had a fish belly frame similar to the Rivarossi model, but the 77-BP-60-1 cars had a Harriman type bar frame. Cut away the parts of the Rivarossi fish belly frame or replace the floor of the model with a bar frame.

FITTING CLERESTORY ROOF TO RIVAROSSO RPO

SOUTHERN PACIFIC REBUILT RAILWAY POST OFFICE CARS

CLASS 77-BP-60-1 (# 5044, 5045)

CLASS 80-BP-60-1 (#5217, 5218, 5219)

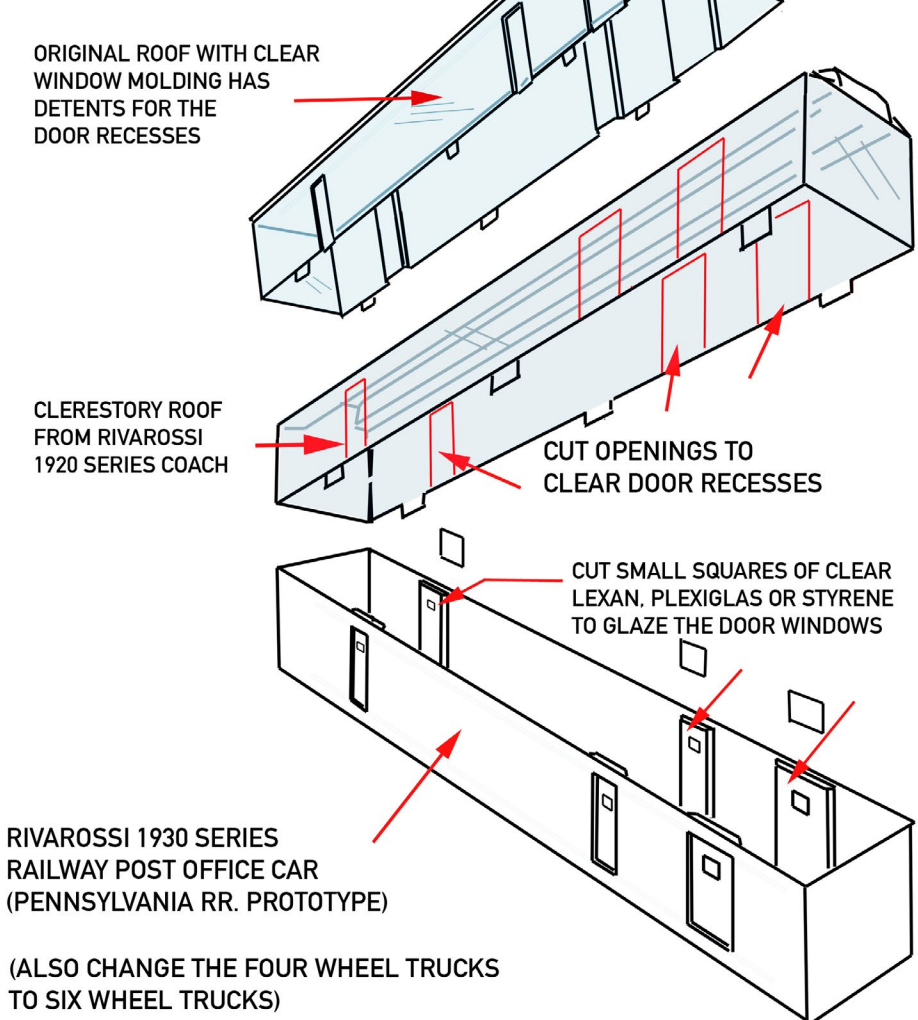

12. Converting a Rivarossi 1930 series postal car to resemble SP 77-BP-60 and 80-BP-60 RPOs. Substitute the roof from a 1920 series coach. Cut out door areas from clerestory roof.



14. Rivarossi model as described here, in Daylight colors as it ran on the San Joaquin Daylight.



15. Prototype SP 80-BP-60 baggage/RPO cars in service, mid 1950s. *Courtesy Bob's Photos*

PART 5 - SP PASSENGER CARS | 27

CLASS 69-BP-30-3 BAGGAGE-RPO CAR, T&NO #139 - 250 FOR THE S
A DETAILED RESIN CAST KIT OF THIS CAR IS AVAILABLE FROM SOUTHERN CAR

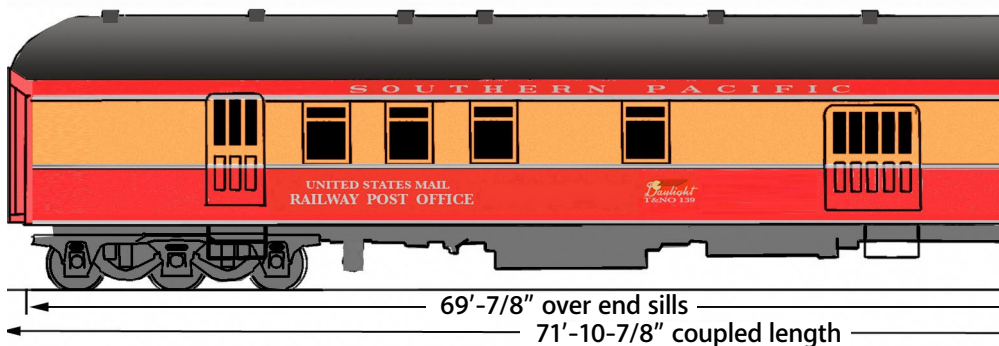

ATHEARN HEAVYWEIGHT BAGGAGE/RPO CAR AS STAND-IN FOR SP PP

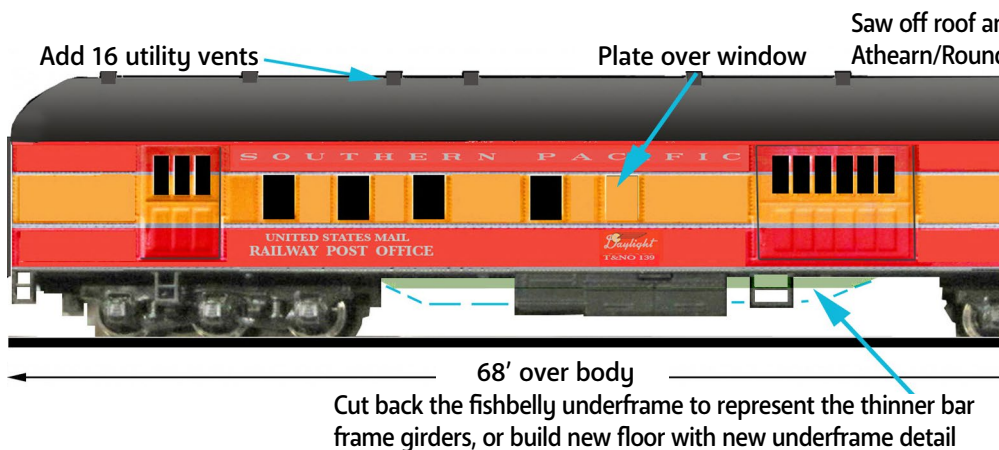

16. With no ready-to-run model of the Sunbeam's RPO car available, the Athearn 75-foot Baggage-RPO car can act as a stand in by adding Harriman type roof from two Roundhouse cars. There is a resin kit of this car available from Southern Car and Foundry.

SUNBEAM
AND FOUNDRY CO.

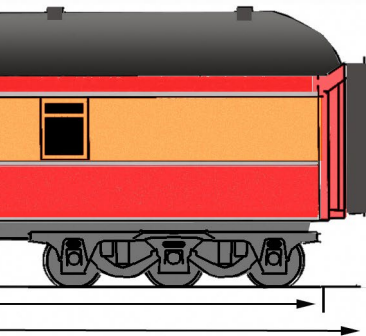

PROTOTYPE

and replace with lengthened roof from
Roundhouse or Model Power Harriman car roof

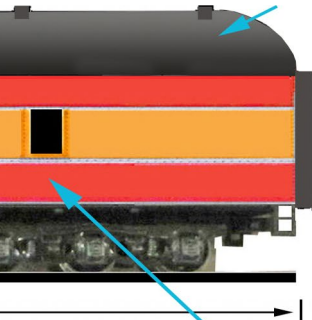

Cut new window frame with styrene
strips, use archer decal rivets to finish

Baggage-RPO cars, Class 69-BP-30-3 and 70-BP-30-3

No ready-to-run model is available of a baggage-RPO car in HO scale, but a resin kit for the Class 69-BP-30 car that ran on the Sunbeam is available from Southern Car and Foundry Co. at www.southerncarandfoundry.com

Their address is:

Southern Car & Foundry
970 Sunshine Lane, Suite D
Altamonte Springs, Florida 32714

Fax: (407) 389-3101

Email: jon@southerncarandfoundry.com

The closest ready-to-run model I could find was the Athearn (blue box) heavyweight baggage-RPO car. Use the car in Daylight colors, or saw the roof off and replace it with two Athearn-Roundhouse round roofs spliced as shown in the illustration.

Either of these could also stand-in for the 70-BP-30-3 cars that ran on the San Joaquin Daylight until 1951-'52. This car has a wider seven-foot opening double baggage door.

The San Joaquin Daylight operated until 1950 with a class 70-BP-30-3 car (#5124) which was very similar to the above car, but had a double baggage door. This was a protect car, and the usual

CLASS 70-BP-30-3 FOR SAN JOAQUIN DAYLIGHT

The San Joaquin Daylight ran with RPO cars 5069 and 5070 in class 70-BP-30-3. These cars had rooves with tapers at each end and skirts were added to the cars which were in Daylight colors. A third car was painted in Daylight colors and is shown below. To make the streamstyled roofs, I made the roof b basswood strips and carved to shape. In 1950 these cars were replaced by rebuilt RPOs with long



BEGIN WITH A BAGGAGE-COACH COMBINE- USE THE BAGGAGE SECTION TRIM

REMOVE
CAR END

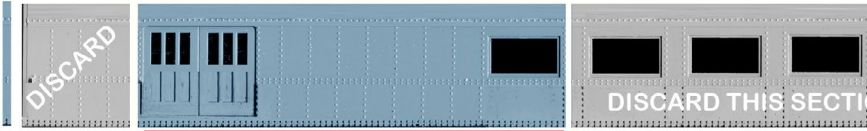

FROM THE RPO CAR, USE THE 3 WINDOW SECTION



JOIN THE TWO SEGMENTS

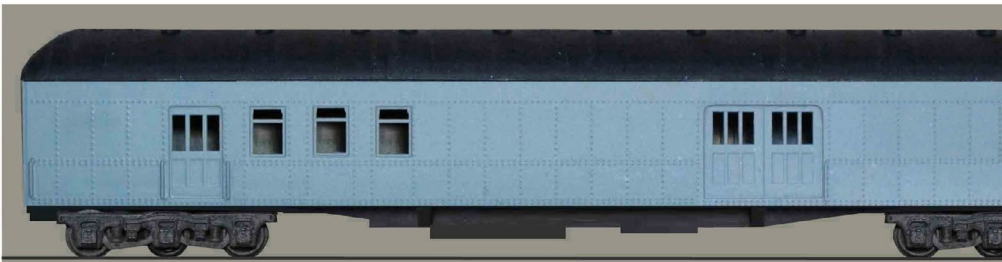
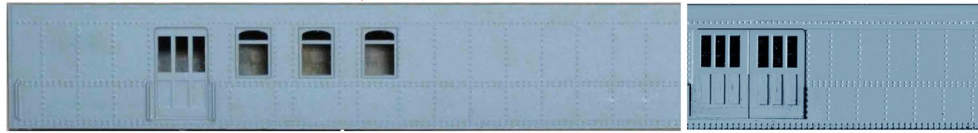

CUT NEW W

PART 5 – SP PASSENGER CARS | 30

of streamstyles
car, 5124 was also
y laminating
er RPO sections.

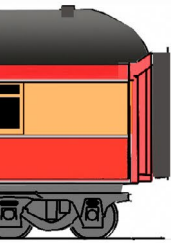

MODERNIZED AS SHOWN

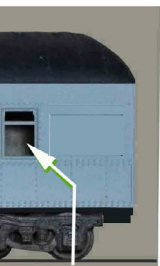
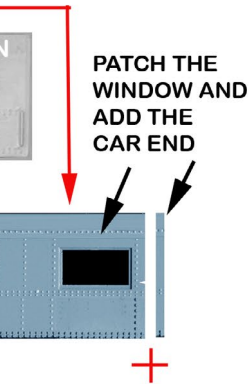
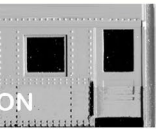

WINDOW

assigned cars, 5069, 5070 were “stream styled” with a tapered roof and skirts.

I spliced a Roundhouse/Athearn round roof (Harriman) RPO and a combine.

I sawed off the baggage end of the combine and cut so the baggage portion plus one coach window (which I patched over with styrene) could be reversed in its orientation with the long blank wall outboard of the baggage door. The cut was made just outside the rivet strip along the door. Two roofs could be spliced to make a round conventional roof. However, the cars assigned to the San Joaquin that I wanted to simulate had modernized tapered roofs. I cut several strips of basswood that I laminated together with Elmer’s glue and held in a clamp overnight to dry.

I used a Surform file to make the overall cylindrical form of the roof, then drew a line with pencil 1/2-inch in from each end as a guide from which the end would be tapered. I tapered the roof downwards as on the prototype to match stream-lined roof traced from a coach.

I finish the roof with homemade sanding sealer. Mix up to 50% solvent paint with powdered talc or ordinary talcum powder. This should have about the consistency of honey. Mix well and paint on the outside of the roof. Do not throw

17. (Left) Railway Post Office protect car for the San Joaquin Daylight.



18. Model of Railway Post Office car SP-3070 as remodeled with tapered roof to blend with lightweight cars and skirts ("streamstyled") for the San Joaquin Daylight.

your roof away when you see it dried because it may look awful. Instead, sand the roof till you see the color of the basswood with the paint color filling the grain. You can finish your roof or give it another sanding sealer coat. Usually one is enough to make a very smooth surface with no grain visible when painted over.

Add the roof vents, in this case a mixture of flat Garland vents for the roof top and utility vents along the middle of the roof. Add any other details, and paint the roof.

I made skirting from styrene sheet and added this to the bottom of the body, making sure I had clearance for the six-wheel trucks. The original model floors were spliced and I added a bar frame.

In later years the center skirt was removed. I used Microscale Daylight car decals and a Cal Scale UC brake detail set.

I finish the roof with homemade sanding sealer. Mix up to 50% solvent paint with powdered talc or ordinary talcum powder. This should have about the consistency of honey. Mix well and paint on the outside of the roof. Do not throw your roof away when you see it dried because it may look awful. Instead, sand the roof till you see the color of the basswood with the paint color filling the grain. You can finish your roof or give it another sanding sealer coat. Usually one is enough to make a very smooth surface with no grain visible when painted over.

Combine 3176, Class 60-CB-1 for the Sacramento Daylight

The San Diego and Arizona Eastern Railroad received two Harriman type passenger-baggage cars built in 1915-6. These came to the Southern Pacific when that railroad was integrated into the system. The cars were numbered SP 3176 and SP 3177. The original transoms over the paired windows were covered over in the 1940s.

Seating capacity was increased over the years with the interior partition being moved, but with no change in the exterior windows. In 1946 car 3176 was painted in Daylight colors and became a regular on the new Sacramento Daylight train, lasting until retired in 1961. These cars had a coupled length of 65 feet, 8-13/16 inches.

In daily service, this car was brought from the terminal at Tracy, CA with express cars that were dropped at Lathrop. The engine (usually an Atlantic until about 1950, then Pacifics or Mountain types later), combine and any through express cars picked up streamlined chair cars from the San Joaquin Daylight.



19. Model of SP 3176 combine for the Sacramento Daylight.

The two trains entered the station in opposite directions, and the Sacramento cars had to be turned. These were placed behind this combine using the road engine, and were run to Sacramento.

An Athearn/Roundhouse round roof Harriman model combine can stand in for this car, but a more accurate model can be built.

The window openings of the model are narrower than on the prototype, and when divided with a scale 3-inch strip, result in approximately 24-1/2-inch wide windows instead of the prototype 28-1/2-inch. The model's overall length is 60 feet, while the prototype length of these cars was 68 feet plus a few inches. There may be other variations from the prototype which is typical with plastic models.

Begin with two combine cars. Arrange them on your work table with the baggage sections on the left to conform to the diagrams. Cut body #1 through the baggage door, outboard of the first three windows saving the passenger end of the body. I used a miter box and fine cut backsaw (X-Acto fine cut blade) and



20. Photo of the prototype 3176, probably at Tracy, CA. *Courtesy Bob's Photos*

then trued up the cut using a Northwest ShortLine TruSander. I used a digital caliper to confirm measurements. The diagrams show the body cutting arrangements.

From body #2, make a cut to retain the two windows of the left hand side of the door. This part should be matched, door to door with the first segment described above. Cut off either car body end from the scrapped parts of body #2 and attach to the assembled car.

Cut and splice the two round roofs to total 65 feet, 8-13/16 inches in scale, or as close as you wish to come to this measurement.

When the body segments are joined, most of the strength of the joint will be in the car floor, for the walls are not the same thickness. I added some shims made of Evergreen styrene strips to equalize the wall thickness, and then added a piece of styrene behind the door to strengthen the body. This sounds far more complicated than it is to actually build.

SACRAMENTO DAYLIGHT

ORIGINAL
60 ft MODEL
COMBINE



USE MODEL POWER HARRIMAN ROOF, OR SPLICE TWO ATHEARN
SEAL VENT HOLES AND USE SIX UTILITY VENTS OVER THE BA
EIGHT UTILITY VENTS OVER THE COACH SECTION. ADD A SM

MODIFIED
MODEL

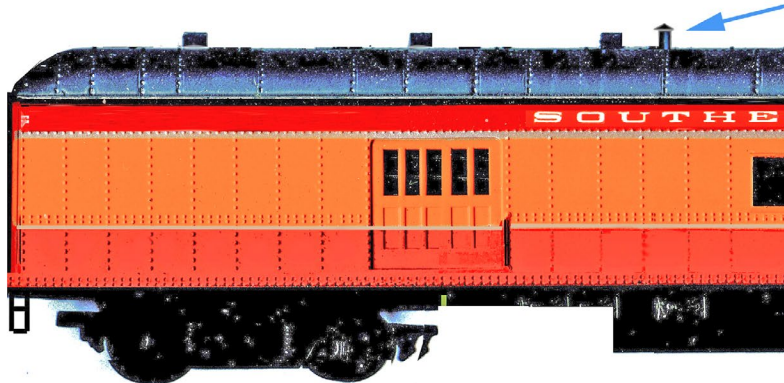

← NEW LENGTH OF CAR IS 65'-8" OVER B

USE CURRENT ATHEARN HARRIMAN COMBINE, OR OL

One steel car weight from the models can be added inside the body to permit a slightly recessed floor, although this is still not as deep as the prototype car. I suggest reinforcing the joint by

HT COMBINE #SP3176



IN / MDC ROOFS.
GAGGE SECTION,
OKEJACK FOR THE HEATER STOVE.

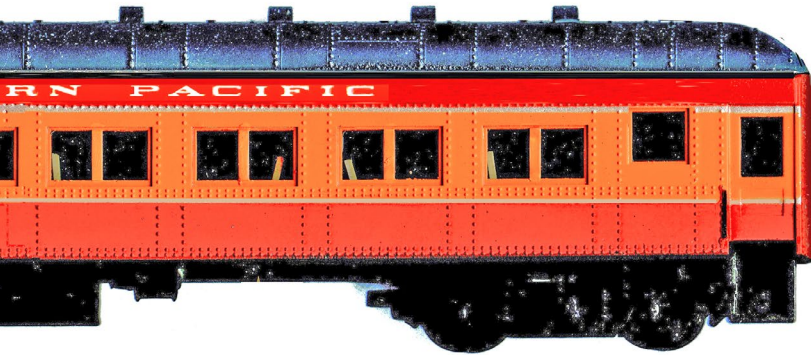

BODY →

↑
USE 8'-0" WHEELBASE
4 WHEEL PULLMAN TRUCKS

D KIT VERSION MODEL DIE CASTING CAR CAN BE USED.

21. Photos of original combine model and stretched results to make the 3176.

SACRAMENTO DAYLIGHT COMBINE

BEGIN WITH TWO ATHEARN-ROUNDHOUSE ROUND ROOF COMBINE CARS

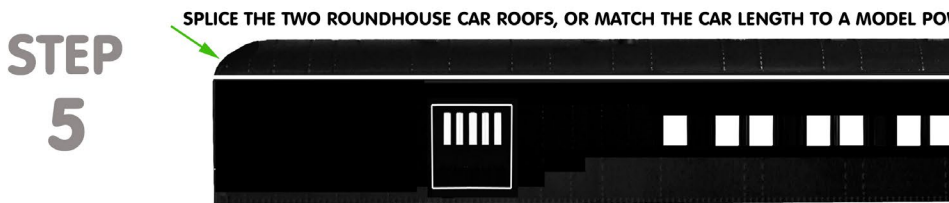
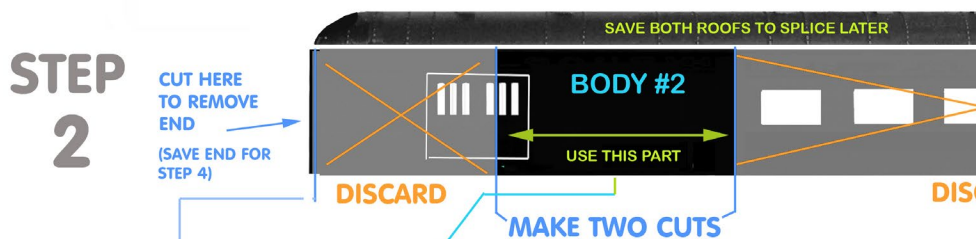
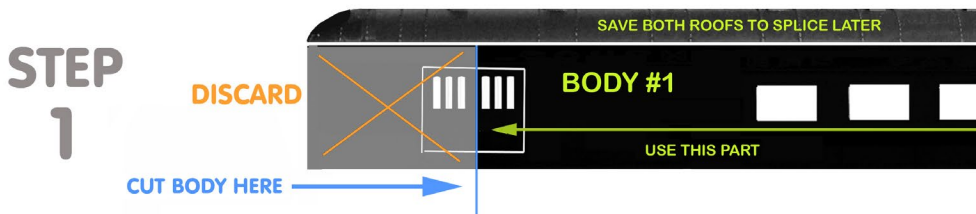

SP3176

CARS:

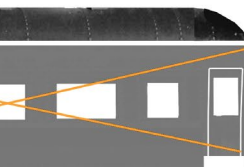
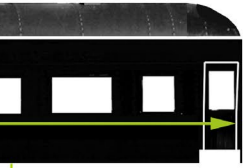

LOWER HARRIMAN CAR ROOF

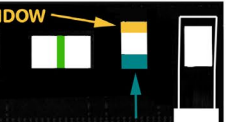

LOWER HARRIMAN CAR ROOF.

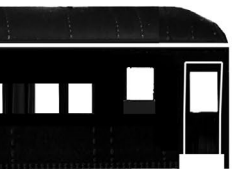

22. Steps to build 3176 combine illustrated.

adding plastic strips in the two corners and along the interior of the sides where they will not show or interfere with the roof flanges.

Pullman-Standard 8'0 -inch wheelbase passenger car trucks were used on the prototype, and the trucks from the new Athearn versions of these cars could be used. For metal trucks, the Bethlehem Car Works #95a or 95b are similar to the prototype trucks for this car. (The old Roundhouse-MDC trucks are too short for this application.

Mount Kadee coupler boxes or your favorite draft gear on the car floor. Be sure to check the floor height and add shims or file away material if necessary. The original floor detail is simplified, and can be made more realistic by adding plastic strips to represent the center of the bar frames of this type of car. The Cal Scale UC brake system will upgrade the underbody equipment which includes a gas cylinder and brake cylinder. The car should have a battery box as shown in the photos.

The holes in the roof for the globe vents should be filled with putty and sanded smooth. Save the globe vents for other projects for they were replaced on this car in the 1940s. I also suggest filing off the oversized rivets on the roof. Utility vents should be fitted to the roof because globe vents supplied with the model had been replaced on the

RAISING THE WASHROOM WINDOW

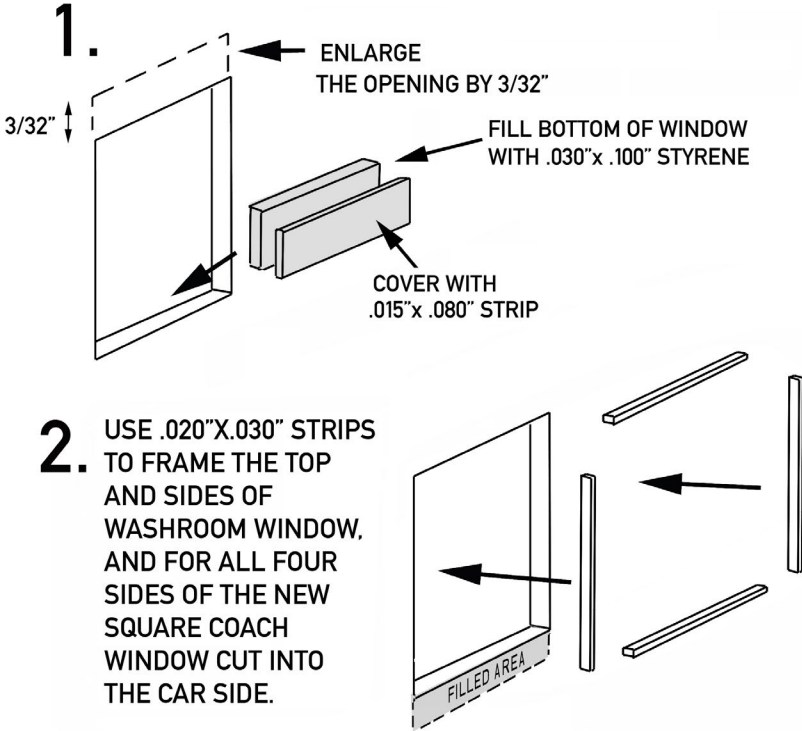

23. Raising the bathroom window on model combine.

prototype by the early 1940s. Vents are available from several aftermarket manufacturers or can be made up from styrene strip.

There are eight vents over the passenger compartment, with an additional one over each washroom window. A smoke jack should be fitted to the end of the baggage compartment nearest to the passenger compartment for a stove.

There are six widely spaced roof vents over the baggage (express) portion of the car, with grab irons on the roof as

shown in the photo. This car also had a metal tube running nearly the whole length of the roof either for gas lights or electrical conduit between the rows of roof vents. The car was painted in Daylight colors in 1946 and remained in these colors till it was scrapped.

PAIRED WINDOWS

FIT AN .030"x.060" STRIP INTO EACH WIDE WINDOW FRAME TO MAKE PAIRED WINDOWS

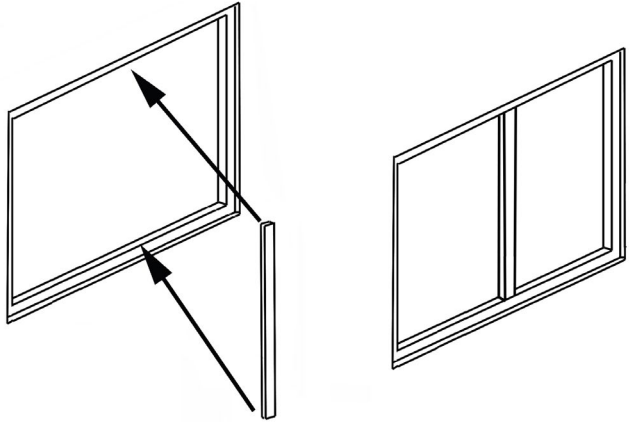

24. Making paired windows on model combine.

In Part 6, I'll get into how to model still more SP heavyweight passenger cars.

108,000 have seen this MRH video - *have you?*

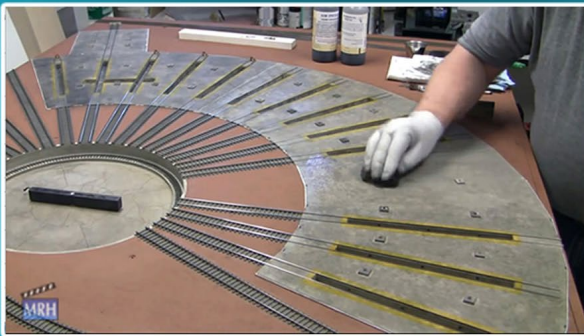

Watch the video now





VICTOR ROSEMAN

Victor got his first train, a Lionel, at age 3. Victor graduated from the Pratt Institute with BFA and MS degrees and taught fine arts in high and junior high school for 30 years and is now retired.

Victor has written many articles and several railroad related books over the past 35 years. He's also done many freelance projects for Walthers, Atlas and other model manufacturers. ■



[Click here for reader comments](#)

ADVERTISEMENT

ADVERTISEMENT



Archer
FINE TRANSFERS
PROUDLY SERVING MODEL BUILDERS SINCE 1989

THE ORIGINAL
SURFACE DETAILS™

WE NOW HAVE MORE THAN 100 SHEETS OF RIVETS, LOUVERS, TREADPLATE AND MORE CAST ONTO MICROSCALE CLEAR DECAL FILM

FREE SHIPPING:

- DOMESTIC USA ORDERS \$50 OR MORE
- INTERNATIONAL ORDERS \$100 OR MORE

CLICK HERE TO VISIT OUR WEBSITE!

Archer Fine Transfers • PO Box 1277 • Youngsville, NC 27596 • USA (919) 570-1026 • info@archertransfers.com • archertransfers.com

MADE IN THE USA

"Archer rivets are easy to apply and look great. To me, they are now a vital tool in building railroad models."
Tony Thompson, Model Railroad Author/Historian

American Limited

HO AND N DIESEL AND PASSENGER CAR DIAPHRAGMS.

THE FINISHING TOUCH.

AT YOUR DEALER OR DIRECT.
www.americanlimitedmodels.com

Bowser

EXECUTIVE LINE

HO Kansas City PCC Streetcars

Our model features: injection molded plastic body, window glass, operating roof poles, operating headlight. Analog cars are DCC Ready with 21 pin plug, accurate painting and decorating, can motor drive with flywheel. Sound trolleys equipped with LOK Sound Decoders (DCC and Sound).

MSRP: Dummy \$59.95, DC Powered \$159.95, DCC & Sound \$259.95

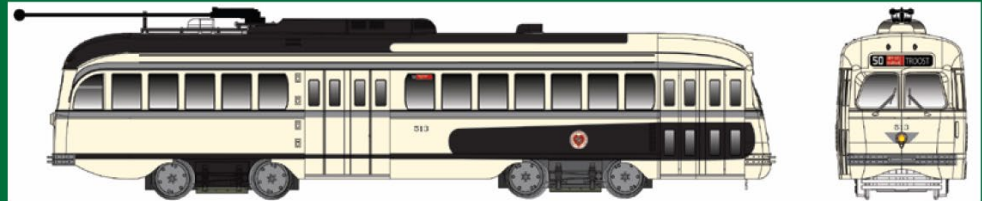
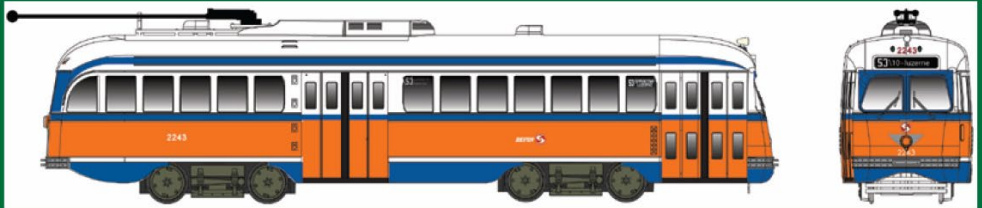
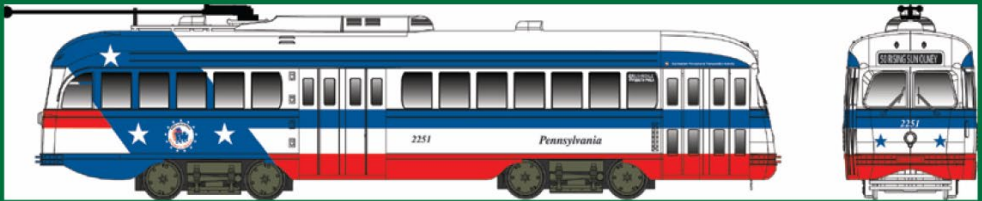

Click here to check out the details for these and other great Bowser products!

MRHMAG.COM

- [TABLE OF CONTENTS](#)
- [INDEX](#)



**35th Annual
National Narrow
Gauge Convention
Sept. 2nd-5th, 2015
in Houston, Texas**

**Click here for
more info ...**

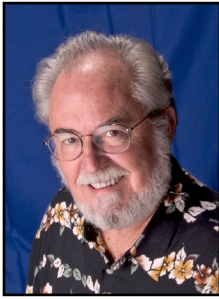

AUGUST NEWS

column

RICHARD BALE *and* JEFF SHULTZ

 [Click here for reader comments](#)



Rapido donates to Lung Association

Jason Shron, founder of **Rapido Trains**, is shown presenting a check for \$20,314 to the Ontario

Lung Association (OLA). Accepting the check is George Habib, president and CEO of OLA and lead executive of the *Breathing as One* campaign. Staff members from Rapido and OLA flash the “*Live long and prosper*” hand sign made famous by Mr. Spock, the Star Trek character played by actor Leonard Nimoy. Rapido made the donation in memory of Nimoy who had long

▶ THE LATEST MODEL RAILROAD PRODUCTS, NEWS & EVENTS

AUGUST News | 2

been associated with the fight against COPD. Rapido raised the money through an online silent auction of 40 LRC locomotive models nicknamed *Shuttlecraft*. Almost 100 bids from around the world were submitted with the top 40 bidders each receiving an individually numbered copy of the museum-quality HO scale model ...

Athearn rebrands Roundhouse

Athearn Division of Horizon Hobby is repositioning the Roundhouse brand as the home for its entry level models. According to Athearn product manager Chris Palomarez, the new Athearn Roundhouse brand will encompass the bulk of the Blue Box and MDC models that are currently cataloged. In most cases pre-orders will not be solicited on these models although there will be some exceptions such as multi-packs. Targeted pricing for the Athearn Roundhouse brand will be within a \$19.98 to \$26.98 price range for rolling stock and \$89.98 to \$129.98 for locomotives. Phasing in the change is currently underway ...

Amtrak merchandise honors Vets



Amtrak's official online merchandise store is selling P42 locomotives decorated with a patriotic Salute Our Veterans scheme. The exclusive design is part of a U. S. Army program to promote hiring of veterans. By federal law, licensing fees paid to the U.S. Army for use of its trademarks are designated

AUGUST News | 3

to U.S. Army morale, welfare, and recreation programs. The HO scale version of the locomotive was produced by Athearn; the N scale version by KatoUSA. To order visit store.amtrak.com/ProductDetail.aspx?did=17265&pid=160217 ...

Train store for sale

Roger's Railroad Junction in Lodi, California is for sale. Owners Roger and Nancy are ready to retire and would like to talk with anyone interested in acquiring an active model railroad shop.

Interested parties should call the store during business hours (10-5 Pacific Time) at 209-334-5623 ...

NEW PRODUCTS FOR ALL SCALES

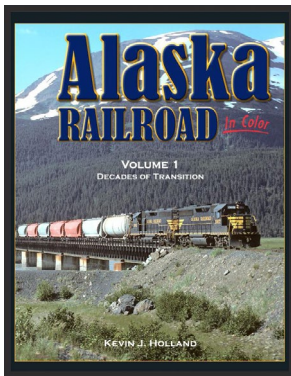
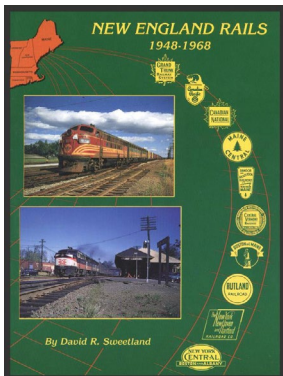

Morning Sun Publications has released a digital reprint of *New England Rails 1948-1968*, an out-of-print book originally published in 1989. Authored by David R. Sweetland, the book

features steam, diesel, and electric operations of the railroads and short lines of the New Haven, Boston & Maine, Central Vermont, Bangor & Aroostook, Rutland, and Maine Central.

Alaska Railroad In Color Volume 1: Decades of Transition, is a conventional hard cover book available now from Morning Sun.

AUGUST News | 4

The study serves as an introduction to the railroad in the scenic glory of Alaska from the 1950s to the 1980s. It combines a capsule history and tour of the line with profiles of the rolling stock and diesels rostered on this unique railroad.

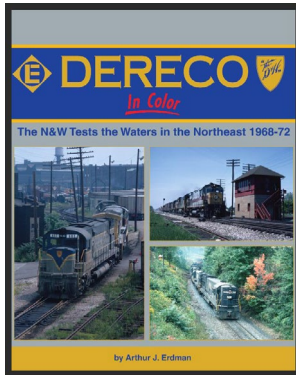
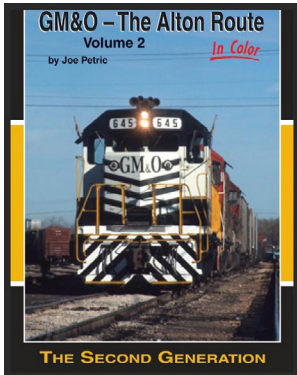

Also new from Morning Sun is *GM&O, the Alton Road in Color volume 2*. The book focuses on the second generation of the GM&O Railroad from the 1960s-70s period. This era

included the purchase of new diesels, introduction of the unit coal train, continued development of online customers, and passenger train operation in the Chicago-St. Louis corridor.

Dereco In Color is a pictorial examination of Norfolk & Western Railway's attempt to stabilize its freight business pending a merger of the Penn Central. Acquiring the Delaware & Hudson and the Erie Lackawanna allowed the N&W to enter the lucrative Northeast market, but the PC's failure and an early season hurricane resulted in dissolution. For additional information on these publications visit morningsunbooks.com.

Deepwoods Software has released version 2.1.35 of the *Model Railroad System*. The package reportedly includes a collection of libraries and programs designed to help the modeler with many of the more tedious aspects of the hobby. Included are libraries for

AUGUST News | 5

communication with Chubb and Lenz XPressNet networks, a user-mode driver for the Rail Driver control console, a library to peruse XTrkCAD layout files, as well as utilities for computing dropping-resistors, camera view areas, creating railroad time tables, and a switch-list based freight car forwarder system. The release includes several updates. For more information, including download links, visit deepsoft.com/ModelRailroadSystem.



The **Missouri Pacific Historical Society** is selling ball caps with embroidered logos representing Mopac predecessor railroads. Caps with colorful logos available now include the Kansas, Oklahoma & Gulf; International-Great Northern; Gulf Coast Lines; C&EI; and the San Antonio, Uvalde & Gulf Railroad. For more information go to mopac.org/store/mphs-gear.



The **Sunshine Region of the National Model Railroad Association** is selling “*The Juice Train – Then and Now*”, a fantasy painting by Andrew Harmantas. Set in the 1970s, the scene depicts the Manatee River bridge with a U-boat led Juice Train moving north while a GEVO pulling empties heads south. An 18 by 24-inch archival print is priced at \$175.00 plus \$20.00 shipping. An 11 by 14-inch non-archival print is \$80.00 plus \$12.00 shipping. For additional information contact Dan Cioffi at dcioffi@tampabay.rr.com.

AUGUST NEWS | 6

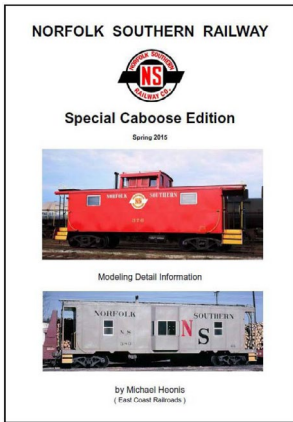

Norfolk Southern Railway Special Caboose Edition, by Michael Heonis is available now from East Coast Railroads. The 8.5 by 11-inch, 44-page book of color and black & white photos provides information on all Norfolk Southern caboose models that have been produced, as well as information on future models and parts under development. Measurements are included for some NS cabooses. This is a good reference book on different paint schemes and lettering styles used on various 300-series NS cabooses. The book has an MSRP of \$12.00. It is available through EastCoastRailroads.com/books.htm.

O SCALE PRODUCT NEWS



Atlas O is selling two nostalgic vehicles decorated for Coca-Cola. The 1:48 scale models include a 1959 VW van and a 1953 Chevy pickup. A metal ice chest is included with the truck.



A 40-foot steel ice refrigerator car is scheduled to arrive from Atlas O during

AUGUST News | 7

the first quarter of 2016. The Master series model is based a PFE class R-40-10 prototype delivered in the mid-1930s. In addition to the twin-herald PFE car shown here, road names will be BREX-Burlington, Erie-URTX Union, FGE, MDT, and Illinois Central.

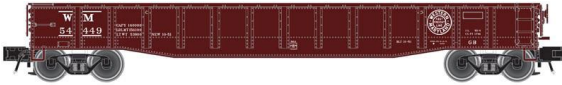

Also due in the first quarter of next year is a 52-foot 6-inch

14-panel steel gondola. The O scale Trainman series model will have separately applied ladders, brake wheel, and brake line. Road names will be Penn Central, Rock Island, Soo Line, Southern Pacific and Western Maryland. All Atlas O rolling stock is available for either two-rail or three-rail operation. For more information see your dealer or visit atlaso.com.

S SCALE PRODUCT NEWS



Smoky Mountain Model Works is selling a kit for a 53-foot

6-inch CB&Q class FM14/FM14A flat car. The model faithfully replicates the prototype flat cars CB&Q's Galesburg and Havelock Shops built between 1940 and 1957. Many of the cars remained in service well into the 1970s wearing the Roman-font lettering. The S scale kit includes a one-piece cast urethane frame, laser-cut wood deck, a steel bar for a center sill weight, Grandt Line details, Tichy wire, K&S brass strip, and Kadee #802 couplers. Decals are provided to letter a new car from 1940 to 1957. A post-1960s car can be represented by changing the reweigh/repack data. To order visit [smokymountainmodel-works.com/S scale kits.html](http://smokymountainmodel-works.com/S_scale_kits.html).

HO SCALE PRODUCT NEWS



New HO scale car kits from **Accurail** include Chicago & North Western 50-foot steel boxcar with an 8-foot

Superior door. All Accurail kits include appropriate trucks and Accumate automatic couplers.



Also new is a kit for a 40-foot New York Central Merchants Despatch Dairy Line reefer with wood sides and ends (above), and a Milwaukee Road

40-foot wood stock car (below).



Kits for a USRA twin-bay open hopper car (below) and a 40-foot steel reefer decorated for Fruit Growers Express (left) are also new.

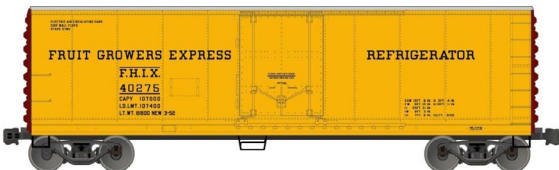
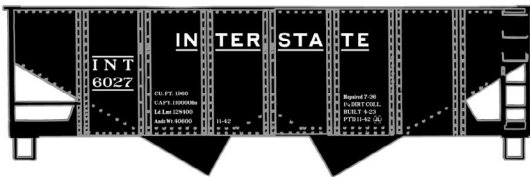

Additional kits available now include this Santa Fe 40-foot AAR steel boxcar with double Youngstown doors and Improved Dreadnaught

AUGUST News | 9



ends. The car is decorated with the road's large post-1966 herald (left). Also new is a Northern Pacific 50-foot riveted-side boxcar with double Youngstown corrugated doors (below).

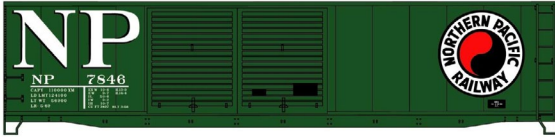

Completing Accurail's current release of HO scale kits a BNSF P-S 4750 cu. ft. covered hopper, a Louisville & Nashville 50-foot four-door boxcar with welded sides, and a special three-car set of 41-foot Western Maryland AAR steel gondolas with 11 side panels. See more info at accurail.com.

.....



Athearn has announced details on seven train sets for the 2015 holiday season. Each set includes a diesel locomotive, a boxcar, gondola, tank car, a wide-vision caboose, power pack, and an oval of Bachmann nickel-silver E-Z Track; all packed in a single display box. Train sets with a GP38-2 will be available for CP Rail (above),

AUGUST NEWS | 10

Alaska Railroad, Nacionales de Mexico, Union Pacific, and Grand Trunk Bicentennial scheme. Norfolk Southern and BNSF train sets will come with a GP50 locomotive. The MSRP on the seasonal train sets is \$209.98. They are scheduled for release in October of this year.



Athearn's production schedule for May 2016 includes HO scale

36-foot wood reefers. The models will be among the first products packaged under the new Athearn Roundhouse brand. Features include wire truss rods and arch bar trucks with machined metal wheelsets. Three numbers each will be available for Pacific Fruit Express, AT&SF Refrigerator Line, Decker Meat, and California Fruit Express.

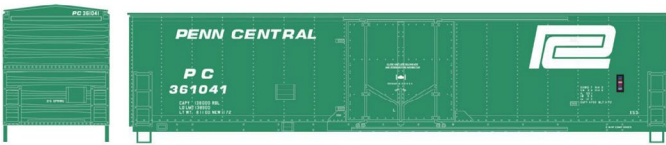

Also coming in May are 50-foot FGE-built steel boxcars.

Decorating schemes will be FGE-Solid Cold, Burlington Northern, B&O, CSX, L&N, and Penn Central as seen here.



The May schedule includes this RTC 20,900-gallon acid tank

car that rides on 100-ton trucks with 36-inch machined metal wheelsets. The General Electric Rail Services Corp car shown

AUGUST NEWS | 11

here will also be available in a black scheme. Other road names will be LLCX Inc., Regents Chemical & Research, Union Tank (two schemes), and undecorated.



A TOFC flat car with a metal underframe

upgraded for improved performance and correct rail height is also scheduled for release next May. In addition to the WP version shown here, the HO scale model will be available for Santa Fe, Great Northern, Chesapeake & Ohio, North American Freight Car Co., Western Maryland, and Western Pacific. Features include wire grab irons and detailed trailer hitches. A minimum track radius of 22 inches is recommended for trouble free operation of the 85-foot car.



Athearn has also scheduled a 53-foot Wabash Duraplate

trailer for release in May. Features include rubber tires, a sliding tandem, etched metal hazmat placards, a six-piece landing gear assembly, and individually decorated etched-metal mud flaps. Roadnames will be Crete, Heartland, Roadway, Swift, U.S. Express Enterprises, and Knight Transportation.

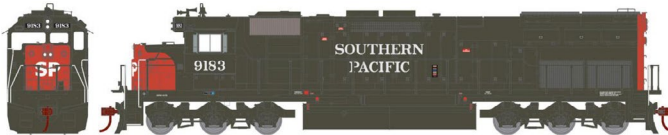

Athearn's production schedule for June 2016 includes a Ready-To-Roll

SD45T-2 Tunnel Motor diesel. The HO scale DC model will have a Quick Plug to ease installation of an aftermarket DCC

AUGUST NEWS | 12

.....

decoder. In addition to the SP lettering shown here, the same SP scheme will be available with speed lettering. Other roadnames will be Duluth, Missabe & Iron Range; Bessemer & Lake Erie; Genesee & Wyoming; and Union Pacific. A new production run of EMD GP35 diesels in Athearn's Ready-to-Roll series are scheduled for release in October. Features include a scale-width hood, Celcon handrails, and several road-specific details. Road names on the Ready-to-Roll models will be Chesapeake & Ohio and Penn Central.



Completing Athearn's scheduled releases for

next June is a Genesis series SD70. The HO scale model will be available decorated for New York, Susquehanna & Western; Conrail; Illinois Central; Southern Pacific, Union Pacific, and Santa Fe in warbonnet scheme.

Additional Genesis products coming later next summer include a Norfolk Southern SD75M; MP15AC locomotives decorated for CSX/YN2, Ferro Valle, SP (new and faded paint); EMD Demo; and Undecorated; and class F89 TOFC flat cars. Athearn HO scale Ready-to-Roll models will include 40-foot wood chip hopper cars (with a load), and 65-foot 6-inch mill gondolas for Chicago, Burlington & Quincy; Canadian National; Penn Central; Southern Pacific; and Union Pacific. New Athearn Roundhouse branded models will include PS-2 2003 twin-bay covered hoppers, 40-foot wood reefers, a cupola caboose, and F7A and F7A/B diesels decorated for Canadian National, Canadian Pacific, Pennsylvania Railroad, and Southern Pacific. For more information, go to athearn.com.

.....

AUGUST NEWS | 13

Atlas Model Railroad Company has scheduled the next release of



its ACF 4650 cu. ft. triple-bay Center Flow covered hopper cars for the first quarter of 2016. Features of the HO scale Master series model include an etched metal roof walk and 100-ton roller bearing trucks. Decorating schemes will be PCC-Palouse River & Coulee City Railroad, Reading, Blue Mountain & Northern, Georgia Pacific Chemical, Sid Richardson Carbon, Wagner Mills, Kansas City Southern de Mexico, and Far-Mar-Co.



Also due to arrive in the first quarter of next year is a group of REA steel express reefers.

The HO scale version is based on an

arched roof prototype with welded steel sides and 3/3 Improved Dreadnaught ends. The Atlas Master series model has separate steam, air, and signal hoses; individual uncoupling levers; and separate ladders and grab irons. Road names will be Great Northern-REX, Santa Fe-REX, Seaboard Coast Line, and TACX-Transport Arts Corp. Also early 1950s REA (dark green body, gold lettering), and REA-mid 1950s (dark green body, gold lettering, red and white herald). Three road numbers will be available for each scheme.

Atlas plans to release an ACF 3560 cu. ft. triple-bay Center Flow covered hopper in the first quarter of 2016. New paint schemes

AUGUST NEWS | 14



for this Trainman series model will be Canpotex. Southern Railway, CN- ICG, and Potash

Corporation. Previously released road names reissued with new numbers include Chessie System and FMC. This Milwaukee Road twin-bay hopper car with offset sides and flat ends is part of a group of HO scale Trainman series cars Atlas has scheduled for release during the second quarter. Other road names will be Baltimore & Ohio, Bessemer & Lake Erie, Central of Georgia, and Lackawanna.

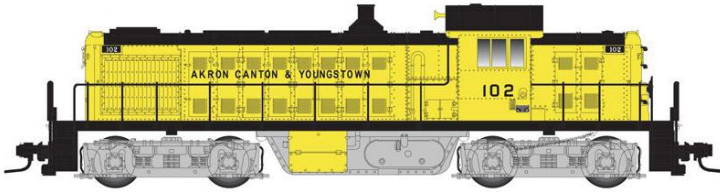

Atlas's second quarter schedule for 2016 includes the release of an Alco

RS-1 with a retooled diecast metal chassis. Additional features include separately applied wire grab irons, individual uncoupling levers, trainline hoses, and lift rings. Road names will be Akron, Canton & Youngstown; Susquehanna; Minneapolis & St. Louis; Spokane, Portland & Seattle; Chicago & Eastern Illinois; Northern Pacific; Rutland; and Long Island Railroad. The HO scale locomotive will be available for standard DC operation and with a six-function DCC decoder. For additional information on all Atlas products contact your favorite dealer or visit atlasrr.com.

AUGUST NEWS | 15



BLMA has announced plans to produce a Trinity 5660 cu. ft. PD

covered hopper with five non-operating bays. Unlike a traditional gravity discharge car, the PD (pressure differential) covered hoppers are unloaded by pressurizing the interior of the car with air, thus blowing the commodity out through a master discharge pipe connected to the bays. Introduced in 1999 by Thrall Industries, production continues today under the TrinityRail brand with nearly 4,000 of the prototype cars currently in service.



BLMA's all-new ready-to-run HO scale model will have separately applied

wire uncoupling levers, trainline air hoses, body mounted couplers, and appropriate trucks with 36-inch metal wheelsets.

The initial release is scheduled for the second quarter of 2016 with six numbers each for CITX, GACX-ConAgra Mills, CEFX-North Dakota Mill, and TILX as shown here. The HO scale ready-to-run model will have an MSRP of \$49.95 each. Contact your dealer for reservations or visit blmamodels.com.

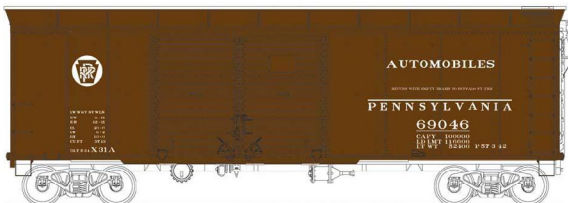

Bowser is selling three versions of Pennsylvania Railroad class X31a boxcars with double Youngstown corru-

AUGUST NEWS | 16

gated steel doors. In addition to an X31a with a large PRR shadow keystone, the HO scale model is available with a *Buy War Bonds* slogan, and a car designated for automobile service displaying a small PRR circle keystone herald.

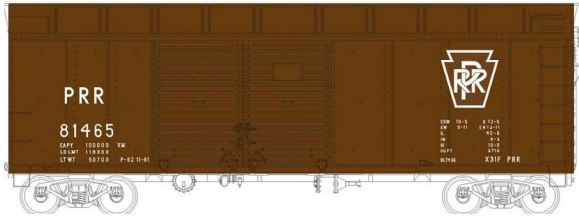

Also available is a PRR class X31f boxcar with a distinctive turtle roof and double Youngstown doors.

Decorating schemes include a plain key-

stone (above), a shadow keystone, and a circle keystone on a car designated for automobile service.



Class X31a boxcars with single Youngstown corrugated doors are available decorated for Duluth, South Shore

& Atlantic (above); Spokane, Portland & Seattle; Norfolk & Western; and Seaboard Air Line.

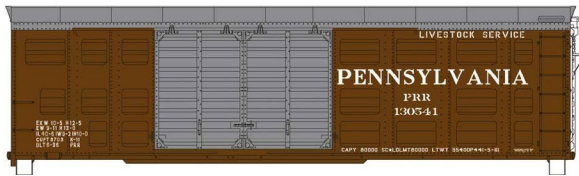

Bowser is also selling a PRR class K11 steel double-door stock car with the roof and doors painted silver.

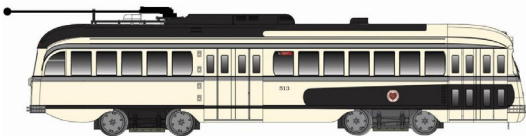

Bowser is developing an HO scale Kansas City PCC car for

release next February. The Executive series model will replicate

AUGUST NEWS | 17

.....

the post-war all-electric cars that operated on Route 50 8th St. Walnut- Troost, and Route 53 48th Troost-Rockhill. The injection-molded plastic body features window glass, operating roof poles, operating headlight, and a can motor fitted with a fly-wheel. Models equipped for analog operation will have a DCC-ready 21-pin socket for an aftermarket decoder. DCC models come with a factory-installed LokSound decoder. Contact your dealer for availability of all Bowser products or visit bowser-trains.com.

.....



AAR boxcar. These 1947-era cars had Youngstown corrugated steel doors and diagonal roofs.

East Coast Railroads has new HO scale kits for three Norfolk Southern freight cars. Shown above is a 40-foot

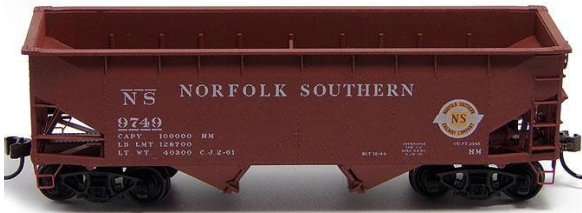

Kits for this Norfolk Southern 50-ton twin-bay hopper car are available in three road numbers.



This 50-foot Norfolk Southern boxcar with external bracing is available in two road numbers from East

Coast Railroads. The kits are decorated and come with

AUGUST NEWS | 18

appropriate trucks and Accumate knuckle couplers. The above kits are priced at \$18.95 each. Assembled models are available for an additional \$8.00 each.



Completing East Coast Railroads' latest product release is a ready-to-run Norfolk Southern steel caboose with distinctive arch lettering. Two numbers

are available at \$29.95 each. For additional information visit eastcoastrailroads.com/models.



Eastern Road Models is selling 3D-printed body kits for HO scale Canadian National flangers with centered cupolas. Available now are a

single-sheathed car (above) and a double-sheathed version shown below in a computer drawing. Each kit includes 3D-printed body components, flanger blades, stirrup steps, cupola wind deflectors, brake cylinders, handbrake wheels, and smoke jacks for coal or oil fired stoves. The air brake reservoir and valve are not included since they were located inside the car body.

The kits do not include trucks, couplers, screws, paint, or lettering. The 3D-printed kit is available in either FXD acrylic

AUGUST NEWS | 19

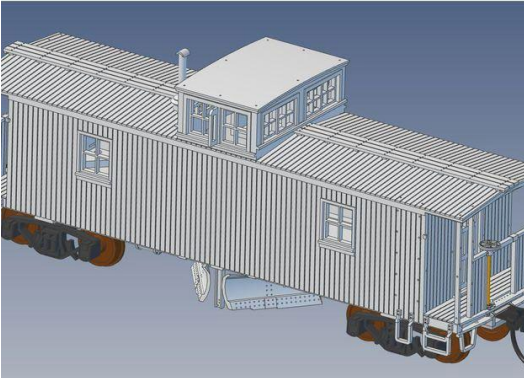

(yields the highest quality) or FUD acrylic (good quality at a lower price). For additional details including pricing and prototype information visit [shapeways.com/product/W2F79WXWD/ho-cnr-single-sheathed-center-cupola-](https://shapeways.com/product/W2F79WXWD/ho-cnr-single-sheathed-center-cupola-flanger?li=shop-results&optionId=57304368)

[flanger?li=shop-results&optionId=57304368.](https://shapeways.com/product/W2F79WXWD/ho-cnr-single-sheathed-center-cupola-flanger?li=shop-results&optionId=57304368)



Funaro & Camerlengo is selling resin body kits for twin-bay open hoppers that are prototypically accurate for Baltimore & Ohio class N12G and Berwind class BW-1 cars. The HO scale kits include cast resin

detail parts, a one-piece body, grab irons, wire for air lines, appropriate decals, and Tichy cast styrene brake components. The B&O kit is available with either AB or K-type brakes. F&C cast resin craftsman kits are sold without trucks or couplers. For additional information including a list of dealers visit fandckits.com.

Imperial Hobby Products is selling a one-piece cast resin body shell for a circa-1949 Pittsburgh Railways 1700-series PCC

AUGUST NEWS | 20

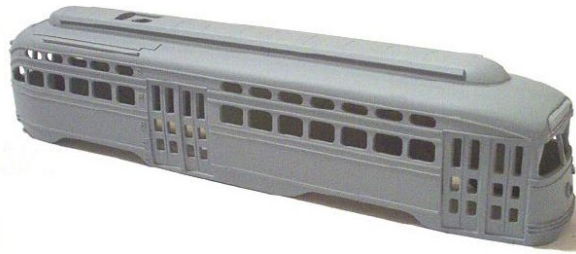

street car. The shell is designed for Bowser's #125141 or #125100 mechanism and IHP's 3D-printed PCC frame (not included). For additional information visit ihphobby.tripod.com.

tion visit ihphobby.tripod.com.



InterMountain Railway is selling an HO scale version of a 1937 AAR 40-foot boxcar. Road names

include Atlantic Coast Line, Central of Georgia, Boston & Maine, Southern Pacific, Minneapolis & St. Louis, and Northern Pacific.

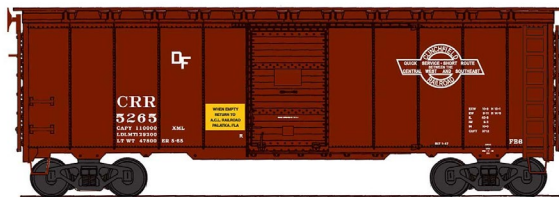

Also available now from InterMountain is a new release of post-war 10-foot inside-height boxcars.

In addition to the Clinchfield Railroad car shown here, road names are New York Central, N de Mexico, Chesapeake & Ohio, Erie Lackawanna, Penn Central, and Southern Pacific.

InterMountain plans to release a group of General Electric ES44AC diesels early next year. Road names will include (next column - from the top down) GE Demonstrator, Iowa Interstate,

AUGUST NEWS | 21

Union Pacific, and Ferromex Diex Anos. Also ArcelorMittal, BNSF, and an alternate UP scheme.



InterMountain's 2016 January-February schedule includes six new cylindrical covered-hoppers with trough hatches for ALNX-Alberta Heritage Fund (top)

and SKNX-Saskatchewan (bottom).



Also a Canadian Pacific cursive scheme (top) and SCOX-Scoular (bottom).



Additional decorating schemes include CNW and Procor. Contact your favorite dealer for information on all InterMountain products or visit intermountain-railway.com.

.....

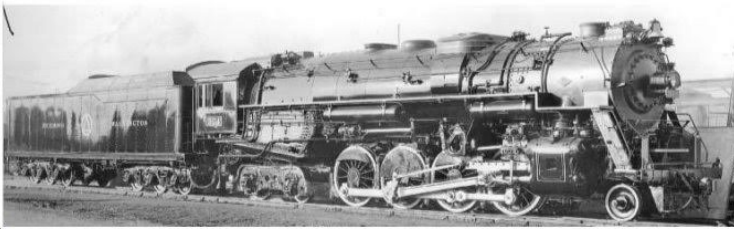

Precision Scale Models has announced plans

to import an HO scale model of a Richmond, Fredericksburg & Potomac 2-8-4 Berkshire-type steam locomotive. The all-brass model will be handcrafted in Korea by Boo Rim Precision Co. Planned features include an open main frame, sliding cab windows, complete brake rigging, opening turret covers and water hatches, gauge faces, and an operating stoker door. Cab interior lights, markers, backup light and headlight will all function. Three versions of the prototype will be available, representing 1943 as-delivered construction, as modified in 1945 with striping on the locomotive and tender, and as modified in 1945 without striping. See your dealer for additional information or visit precision-scaleco.com.

.....



Tangent Scale Models is offering its ACF 52-foot 6-inch welded 70-ton drop-end gondola

in seven new decorating schemes. The prototype was initially produced for Pennsylvania Railroad as a class G31b gondola by American Car & Foundry in 1948. Over a period of time PRR purchased 11,600 of the cars and routed them to every corner of the nation. In addition to PRR, other railroads purchased these gondolas from ACF, and some former PRR cars were acquired second-hand by various railroads.

Decorating schemes available now include Erie Lackawanna with Gothic marks and an EL diamond in repainted black scheme, 1974+; Erie Lackawanna, 1964+ in black paint labeled for rail train service without drop end to facilitate rail loading, 1964+; Penn Central in PC green, 1971+; Southern Pacific class G-70-8 in original black scheme, 1951+; Southern Pacific with Gothic lettering with a 1966 repaint date; and Southern Pacific class G-70-12 in freight car red, 1953+ (above).



Tangent is also offering the gondola decorated for Allagash Railroad in spruce green with gold lettering. The Allagash

is an outstanding example of a quality proto-freelanced model railroad. The brainchild of Mike Confalone, the Allagash is a regional carrier based in Maine in the mid-1980s. Mike's layout has been featured prominently in this magazine and Model Railroad Planning. This is Tangent's first car representing a

AUGUST NEWS | 24

model railroad. Tangent owner David Lehlbach told MRH he has issued the Alagash cars in response to numerous requests for models representing well-known model railroads.

Notable features of the dimensionally accurate model includes scale-sized side tie-downs, see-through tie down holes, stand-off ladders, wire grab-irons and coupler lift bars, see-through brake platforms, interior detail, road-specific handbrakes, separate air hoses, a hidden weight, and Kadee couplers. The cars ride on 70-ton ASF A-3 Ride-Control trucks with metal wheelsets. The ready-to-run model has an MSRP of \$34.95 each. Quantity discounts are available on direct purchases. For ordering information visit tangentscalemodels.com.

.....

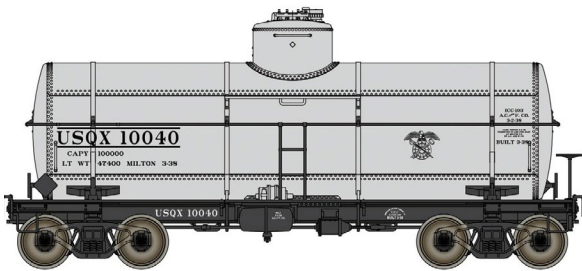

Coming next month from **Walthers** is another release of its Proto series ACF Type 21 10,000 gallon tank car. Decorating schemes will include

the USQX-War Department Quartermaster Corps car shown here. Additional roads will be UTLX, KTX-Keith Tank Lines, and SHPX-Pan Am Oil.



Walthers will begin delivering several new Pullman-

Standard 85-foot passenger cars beginning with this 56-seat coach in October. Road names for this series of HO scale ready-to-run cars will include Erie-Lackawanna, Delaware & Hudson, Missouri Pacific-The Eagle, Denver & Rio Grande Western, and Nickel Plate.

AUGUST NEWS | 25



for release in November.

A 52-seat coach and a 48-seat diner (left) are scheduled

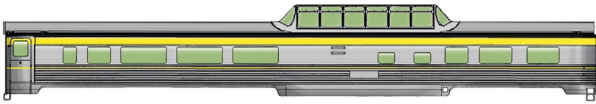

10-6 sleepers are scheduled for release in December. The sleepers will be available in both 4140 and 4167 floor plans.

A Budd-built dome car (left) and two Pullman-Standard

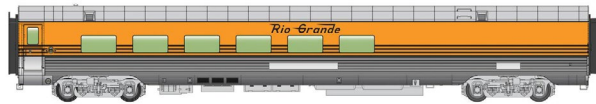

The January release will include P-S lunch counter-lounge-buffet car (top) and a P-S 5 bedroom-lounge



car (bottom).

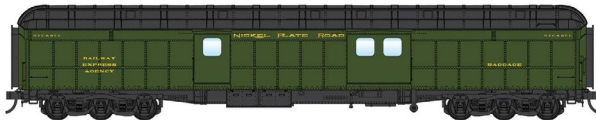

a 70-foot ACF-built heavyweight baggage car shown here in Nickel Plate livery. The series will be available both with and without interior lighting.

The final model in this series is due to be released in February. It will be



Walthers has scheduled the release of DM&IR class G2 wood cabooses in November. The HO scale model will be offered as shown here with the red arrow,

AUGUST NEWS | 26

as well as in the modern scheme without the arrow. The model will also be available decorated for New York Central, Northern Pacific, Soo Line, and Pere Marquette. For additional information on all Walthers products contact your dealer or visit walthers.com



Westerfield Models has released another production run of its 5760 series kits for Pennsylvania 30-foot twin-bay hopper cars as modernized with AB

brakes. The HO scale models faithfully replicate Pennsy's all-steel GLA hoppers of which more than 25,000 were built. The cars remained essentially unchanged until AB brakes were applied in the 1940s. The kits are composed of flat cast urethane body parts with a one-piece hopper assembly and prototypically correct decals. Detail parts for completing the kit are included along with extensive history/assembly sheets. Trucks and couplers are not included. Kit No. 5761 (above) includes PRR circle keystone decals. Kit No. 5762 (below) comes with a PRR shadow keystone decals. The kits are available now at \$34.00 each. A kit is also available without decals at \$33.00.



For ordering details as well as availability information on earlier versions of GLA hoppers visit westerfieldmodels.com.

N SCALE PRODUCT NEWS

Athearn N scale items coming next summer include a 40-foot wood chip car complete with a removable load. Also a 65-foot 6-inch mill gondola decorated for Chicago, Burlington & Quincy; Canadian National; Penn Central; Southern Pacific; and Union Pacific. More info at athearn.com.

.....



New N scale models coming from **Atlas** late this year include this Trainman series triple-bay covered hopper. The model is based on a 3600 cu. ft. plate B prototype

built by American Car & Foundry. In addition to the ACFX-FMC Chemicals version shown here, decorating schemes will include Chessie System, Canoptex, CN-ICG, Potash Corp., and Southern Railway. An undecorated model will also be offered.



Atlas has scheduled this Trainman series 90-ton triple-bay open hopper car for release during the first quarter of 2016. Road names will be Kansas City Southern, Burlington

Northern, Conrail, Reading, Santa Fe, Blue Mountain & Northern, and PPLX-Pennsylvania Power & Light.

The next release of Atlas's Master series VO-1000 diesel locomotive is scheduled for the second quarter of next year. The N scale

AUGUST NEWS | 28

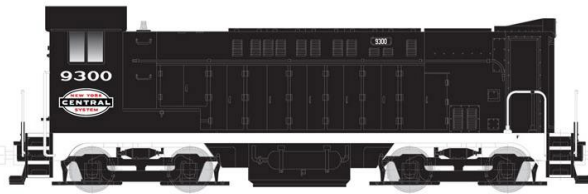

locomotive will be available for standard DC as well as DCC decoder equipped. Road names will be New

York Central, Central of Georgia, Chicago & North Western, Pittsburgh & West Virginia, Southern Pacific, and Belt Railway of Chicago. An undecorated version will also be available. See your dealer or visit atlasrr.com for complete details on these and other Atlas N scale products.

.....

Bachmann Trains (bachmanntrains.com) has an N scale Baltimore & Ohio class EM-1 2-8-8-4 steam locomotive. It is equipped with a Bachmann/Lenz DCC decoder that controls speed, direction, and lighting. Additional features include twin flywheels, all-wheel pickup, traction tires, soft-white LED headlight, and backup light, chemically blackened wheels, and separately applied handrails and stanchions. Four road numbers are available with variants including single or dual headlights in combination with small and large boiler domes. See your dealer for additional details including pricing.

.....



BLMA has announced plans to produce a Trinity 5660 cu. ft. PD

covered hopper with five non-operating bays. Unlike a traditional gravity discharge car, the PD (pressure differential) covered hoppers are unloaded by pressurizing the interior of

AUGUST NEWS | 29

.....

the car with air, thus blowing the commodity out through a master discharge pipe connected to the bays. Introduced in 1999 by Thrall Industries, production continues today under the TrinityRail brand with close to 4,000 of the prototype cars in service.

BLMA's all-new ready-to-run N scale model will have separately applied wire uncoupling levers, trainline air hoses, body mounted couplers, and appropriate trucks with 36-inch metal wheelsets.

The initial release is scheduled for the second quarter of 2016 with six numbers each for CITX, TILX, CEFX-North Dakota Mill, and GACX-ConAgra Mills as shown here. The N scale ready-to-run model will have an MSRP of \$29.95. Contact your dealer for reservations or visit blmamodels.com.

.....



Eastern Seaboard Models has released to

dealers its initial run of GSC well-deck flat cars. The N scale ready-to-run model features an ABS plastic body, a diecast well/underframe, Atlas Barber S-2a truck frames fitted with Fox Valley 28-inch metal wheelsets, and Micro-Trains body-mounted couplers. Road names on the initial release are Delaware & Hudson, Lehigh Valley, New York Central (above), Penn Central, Conrail, and Allis-Chalmers. A second production run with new road numbers is scheduled for later this year. Additional road names on the late 2015 run will include Pennsylvania, Department of Defense, and ESM's 2015 Holiday Car. For additional information visit esmc.com.

.....

AUGUST NEWS | 30

.....



New N scale motive power coming from **InterMountain** includes a group

of EMD SD45-2 diesel locomotives. In addition to this Santa Fe scheme shown here with BNSF reporting marks, the N scale model will be available decorated for Reading, Blue Mountain & Northern, Clinchfield Railroad, SP/SF (Kodachrome scheme), BNSF, MEC/Pan Am, and Erie-Lackawanna. The ready-to-run model will be available in three operating options: DC, DCC, and DCC with sound.



InterMountain is taking reservations for an N scale 1937 AAR boxcar shown here decorated for Union Pacific O.W.R.& N (Oregon-Washington Railway &

Navigation Co). Additional road names will be Chesapeake & Ohio, Texas & Pacific, Santa Fe, Boston & Maine, and Southern Pacific. Contact your dealer for additional information on all InterMountain products or visit intermountain-railway.com.

.....



Micro-Trains Line is selling an N scale version of EMD's SW1500 diesel switcher. After acquiring Wisconsin Central, CN

repainted the locomotive in the distinctive wet noodle scheme. Although under CN ownership, the prototype locomotive retained its WC reporting marks.

AUGUST NEWS | 31

.....



A group of four D&RGW 100-ton triple-bay hopper cars are available from Micro-Trains. The N scale models come with a removable coal load.



Micro-Trains has released a set of three 12-1 heavy-

weight sleepers decorated for the Royal American Shows. For additional information on Micro-Trains products contact your dealer or visit micro-trains.com.

.....

NEW DECALS, SIGNS AND FINISHING PRODUCTS

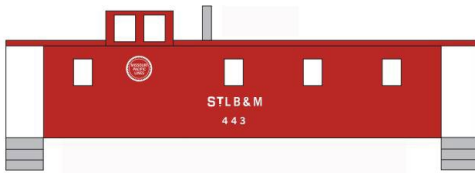

Mask Island has released five new decal sets for Missouri Pacific cabooses. They cover the period from 1930 to the 1960s. They

include Missouri Pacific St. Louis, Brownsville & Mexico (item #87- 297, above); New Orleans, Texas & Mexico caboose (#87-298); Missouri Pacific 1229 series caboose (#87-299); yard and transfer cabooses (#87-300); and Missouri Pacific caboose series 616 and 1112 (#87-301, below).

Also new from Mask Island are decals for a Rock Island 40' boxcar with a roof hatch for bauxite loading (above) and a

AUGUST NEWS | 32

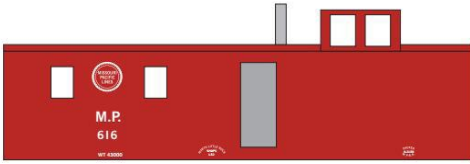

Texas & Pacific 40' boxcar. Visit the above website for full details. For more information visit maskisland-decals.com. These decals

are also available through the MoPac Historical Society store at mopac.org/store.

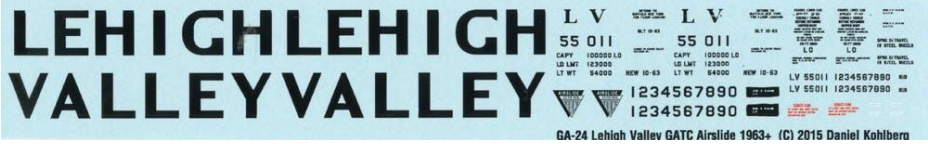

Four new HO scale decal sets from **Dan Kohlberg** will letter different eras of Lehigh Valley GATC Airslide covered hopper cars. Set GA-23 for early cars 1957+ is priced at \$8.00. The following sets are \$6.00 each: GA-24 early cars 1963+, GA-25 early car 1973+, and GA-26 late cars 1966+.



Each set includes a detailed lettering diagram. Kohlberg's website at paducah.home.mindspring.com includes prototype details, photos and ordering information.



**Click here for
reader comments**

SEND US YOUR PRODUCT ANNOUNCEMENTS

If you are a hobby manufacturer with a product announcement, just [click here](#) and submit your announcement to us. Our web site and free magazine reach continues to grow, so get on board this new media train! ■

.....

DISCLAIMER

The opinions expressed in this column are those of the writer and do not necessarily reflect the opinion of *Model Railroad Hobbyist* or its sponsors. Every effort is made to provide our readers with accurate and responsible news and information, however, neither *Model Railroad Hobbyist* or the writer of this column can be held responsible for any inaccuracies or typographical errors that may inadvertently appear in this column.

.....

THIS MONTH'S BONUS EXTRAS

MRH SUBSCRIBERS GET ACCESS TO FREE BONUS extras, but you do have to be a subscriber! That's easy because [subscribing is free \(just click this link\)](#).

The bonus extras this month include:

- High quality versions of the issue videos
- Downloadable wallpaper of the best images this issue

To access the bonus extras, click the link below:

[BONUS DOWNLOADS FOR THIS ISSUE](#)

.....



BRIEFLY NOTED AT PRESS TIME ...

... **Bowser's** Lee English plans to show decorated samples of the Canadian-style SD40-2 diesels at the NMRA National Train Show in Portland later the month. The HO scale model should be in full production before the end of September.

... **Despatch Junction**, an independent hobby shop in Rochester, New York, has reopened following the devastating 2013 fire that destroyed the original 1884 New York Central depot where the store was located.

... **Kadee** has expended its selection of basic car body types with the introduction of an ACF 11,000 gallon insulated tank car. The HO scale ready-to-run model has a riveted underframe and will be offered with both step platforms (1947-1949) and full platforms (1947-1950). Available now is a step platform version with a black tank, white dome and red lettering for Tidewater Association Oil Co. #4003 with TWOX reporting marks (built by ACF in 1948). Features of note include Apex see-through running boards and safety platform, full underframe details, AB brake rigging, prototypical ladders, separate grab irons, and defect card holders with hazardous material placard stickers. The model comes with Kadee self-centering equalized trucks and #158 Whisker couplers.

... **KatoUSA** has announced N scale Santa Fe F7A & F7B locomotives in both the dual headlight Blue Bonnet and



BRIEFLY NOTED, PAGE 2 ...

single-headlight Cigar Band paint schemes. Two F7As and one F7B will be available in each scheme. The models have been retooled to make them DCC friendly with drop-in decoders. Currently scheduled for a late 2015 delivery, the locomotives have an MSRP of \$90.00 for the F7A models and \$85.00 for the F7Bs. In the past Kato offered the Blue Bonnet scheme only on it's F7 freight starter set.

... **Rapido Trains Inc.** has shipped its new HO scale FPA-4 and FPB-4 diesels to dealers. Road names on this release include VIA Rail Canada, Grand Canyon Railroad, Napa Valley Railroad, and New York & Lake Erie. To see a video with details about Rapido's FPA visit [youtube.com/watch?v=h0qg7BB_z0k&feature=youtu.be](https://www.youtube.com/watch?v=h0qg7BB_z0k&feature=youtu.be). There was a slight overrun on this release so if your dealer doesn't have what you want, send an inquiry to rapido3@rapidotrains.com. The initial release of Rapido's new HO scale FL9 locomotives is running ahead of schedule and should be at dealers as you read this report. Road names on this combined Rapido/MLW joint project are New Haven EDER5 (three versions), Penn Central (three schemes), Conrail, MTA, Metro North, and Amtrak (phases II and III). Both DC and DCC equipped models are available.

... The release of Volume 30 of **Railway Prototype Cyclopedia** has been postponed until later this year. The



BRIEFLY NOTED, PAGE 3 ...

original spring release date was delayed by the printer, and since a summer delivery was deemed less desirable for the model railroad community, Pat Wider and Ed Hawkins elected to put the issue on hold until this fall. Future plans call for a continued publication schedule of about two volumes per year.

... Long range projects at **Resin Car Works** include an HO kit for an Illinois Central class B electric locomotive with correct four-spring trolley poles and two Stanton drives. Owner Frank Hodina says he is trying to keep the price close to \$200.

... **Ring Engineering** has a new ETD (end of train device) that offers a bright red flashing light. The unit installs easily and requires no modification or wiring to the freight car. In addition to ETD, the devices are also known as EOT (end-or-train) and FRED (flashing rear end device). For additional information visit ringEngineering.com.

... **SoundTraxx** has introduced a new low-cost line of sound decoders named "Econami." With prices starting at \$79.95, the Econami decoders are significantly lower in cost than SoundTraxx's flagship Tsunami decoders. The new decoders feature SoundTraxx's 16 bit sound, Hyperlight lighting effects and Hyperdrive2 motor control. Available with both



BRIEFLY NOTED, PAGE 4 ...

steam and diesel sounds, the Econami hardware comes in three versions, a 1 amp, 4 output “hardwire” shrink wrapped decoder (ECO-100), a 1 amp, 21-pin, 4 output board (ECO-21P), and a 4 amp, universal style six output board (ECO-400). The ECO-100 is shipping now with the ECO-400 and ECO-21P following shortly thereafter. Visit soundtraxx.com/dsd/econami for more information as well as sound samples.

Tangent Scale Models production schedule calls for another release of it’s HO scale 6,000 gallon 3-compartment tank car in early fall. No details yet but owner David Lehlbach says the run will include some cool new decorating schemes. ■

MRH
MODEL RAILROAD HOBBYIST

Model Railroad Hobbyist magazine™

YES, subscribing MATTERS!
(even though it's free)

It helps MRH get more advertisers

Click here to subscribe!



SELECTED EVENTS

August 2015

(Please note that many events charge a fee. Check individual info website for details.)

CANADA, ONTARIO, MUSKOKA, August 8-9, Model Train Show sponsored by Muskoka Model Railway Club, at Bracebridge Fairgrounds. Info at muskokamodelrailwayclub.org/annual-summer-train-show.html.

ARIZONA, PRESCOTT VALLEY, August 15, Beat The Heat Swap Meet, at Liberty Traditional School, 3300 N. Lake Valley Road. Sponsored by Central Arizona Model Railroad Club. Info at trainweb.org/camrrc/SwapMeet/SwapMeet.html.

CALIFORNIA, SIMI VALLEY, August 15, Swap Meet, sponsored by Santa Susana Railroad Historical Society, at Santa Susanna Train Depot. Info at santasusannadepot.org/swap-meet.htm.

CALIFORNIA, FREMONT, August 1, Third Annual Model Railroad Swap Meet, at Niles Depot, 37592 Niles Blvd, 94536. Co-sponsored by the Niles Depot Historical Foundation and Tri-City Society of Model Engineers. Vendor info available from Mike (650) 207-4397 or Bob (510) 325-2092.

CALIFORNIA, TEHACHAPI, August 8-9, Train Show, sponsored by Tehachapi Loop Railroad Club, 410 West D Street. Info at tlrc.club/events.

SELECTED EVENTS | 2

FLORIDA, THE VILLAGES, August 22-23, Summer Train Show & Sale, Savannah Regional Recreation Center, 1545 Buena Vista Blvd. Info at villagerailclubs.blogspot.com.

ILLINOIS, COLLINSVILLE (Metro St Louis), August 7-8, St. Louis Railroad Prototype Modelers Meet, featuring 16,000 sq. ft. of display area, at Gateway Convention Center, One Gateway Drive. Co-sponsored by RPM committee and the Gateway Division, Mid-Continent Region, NMRA. Info at home.mind-spring.com/~icg/rpm/stlrpm.pdf.

NORTH CAROLINA, DENVER, August 28-30, HO modular layout display by The Sipping and Switching Society of North Carolina, at Salem United Methodist Church, 378 North Pilot Knob Road. Info at groups.yahoo.com/neo/groups/SandSSofNC/info.

NORTH CAROLINA, SPENCER, August 22-23, Spencer Shops Railroad Show and Swap Meet, at North Carolina Transportation Museum, 411 South Salisbury Avenue. Info at nctrans.org/Events/Historic-Spencer-Shops-Train-Show.aspx.

OHIO, CINCINNATI, August 8, Summerail at C.U.T., featuring a day of quality railroad photography, at Cincinnati Union Terminal, 1301 Western Avenue. Info at cincinnatiirclub.org/Summerail/index.shtml.

OHIO, MARION, August 22, 11th Annual Everett's Train Show, at Marion Union Station, 532 West Center Street. Info at visitmarionohio.com/event/11th-annual-everetts-train-show-swap-meet.

OREGON, PORTLAND, August 23-30, NMRA National Convention, at Double Tree by Hilton Hotel Portland. Info at nmra2015.org.

SELECTED EVENTS | 3

OREGON, PORTLAND, August 28-30, National Train Show, at Portland Expo Center. Info at nmra2015.org/trainshow.

September 2015

CANADA, QUEBEC, MONTREAL, September 26-27, Model Train Exposition, at Sun Youth Centre, 4251 St Urbain Street. Info at montrealmodeltrainexposition.com.

ARIZONA, SCOTTSDALE, September 16-20, NMRA Pacific Southwest Region Convention, at McCormick Scottsdale Hotel, 7401 North Scottsdale Road. Info at psrnmra.org.

GEORGIA, KENNESAW, September 18-19, Atlanta Railroads Prototype Modelers Meet, at the Southern Museum of Civil War and Locomotive History, 2829 Cherokee Street. Jointly presented by SRHA, Atlantic Coast Line & Seaboard Airline Railroads Historical Society, Central of Georgia Railway Historical Society, Louisville and Nashville Historical Society, and Nashville Chattanooga & St. Louis Preservation Society. Info at srha.net.

ILLINOIS, BIG ROCK, September 6, Illinois Live Steam & Milwaukee Live Engineers Meet, at Plowman's Park, 48W508 Hinckley Road. Info at facebook.com/PrairieStateRailroadClub.

INDIANA, SOUTH BEND, September 11-12, NMRA Michiana Division Education & Training Conference, at Comfort Suites University Arena. Info at michiana-nmra.org/events.

OHIO, MANSFIELD, September 19, Train Show, sponsored by Firelands Society of Model Railroaders, at Richland County Fair Grounds, 750 N. Home Road. Info at fsomr.com/train-show-fliers.html.

SELECTED EVENTS | 4

MASSACHUSETTS, TAUNTON, September 27, 15th Annual Train Show, sponsored by Old Colony Model Railroad Club, at Taunton Holiday Inn, Route 495 at Exit 9. Info at oldcolonymod-railroad.tripod.com/train-show.html.

MINNESOTA, ST. PAUL, September 19, Fall Train Show, sponsored by Twin City Model Railroad Museum, at Minnesota State Fairgrounds, Education Building. Info at tcmrm.org/visit/exhibits-events/tcmrm-hobby-show-sale.

MISSOURI, SPRINGFIELD, September 26, Annual Fall Railroad Show, sponsored by Ozark Model Railroad Association, at Remington's, 1655 West Republic Road. Info at [omraspringfield.org/Fall Meet.html](http://omraspringfield.org/Fall_Meet.html).

NEBRASKA, NORTH PLATTE, September 18-20, Rail Fest 2015, info at nprailfest.com.

PENNSYLVANIA, YORK, September 25-26, East Coast Train Show, at York Expo Center, 334 Carlisle Avenue. Info at eclsts.com.

TEXAS, HOUSTON, September 2-5, 35th National Narrow Gauge Convention. Info at nngc-2015.com.

VIRGINIA, FREDERICKSBURG, September 25-26, 3rd Annual Mid-Atlantic RPM Meet, at Wingate by Wyndham Fredericksburg, 20 Sanford Drive. Info at marpm.org.

VIRGINIA, VIRGINIA BEACH, September 19-20, Tidewater Division 26th Annual Train Show, at Virginia Beach Convention Center, 1000 19th Street. Info at nmra-mer-tidewater.org.

WEST VIRGINIA, MADISON, September 12-13, Coal River Model Train Show at Madison Civic Center, 261 Washington Avenue.

Future 2015 (by location)

CANADA, ONTARIO, BRAMPTON, October 3-4, Annual Brampton Model Railway Show with 33,000 square feet of display including N, HO, O and G scale operating equipment. At Brampton Fairgrounds, 12942 Heart Lake Road. Info at brampton-modelrailwayshow.com.

– **CANCELLED** – **CANADA, QUEBEC, LAVAL**, Oct 3-4, The North Shore Train Show, Complexe Multi-Sports, 955 ave Bois-de-Boulogne. Info at salondutrainrivernord.org/english.html.

CALIFORNIA, SAN LUIS OBISPO and NORTHERN SANTA BARBARA COUNTIES, October 1-4, 2015. Central Coast Railroad Festival, self-guided layout tour. Details are pending. Visitors and participants contact Bob Chaparro for information at chiefbobbb@verizon.net.

COLORADO, LONGMONT, December 11-13, 38th Annual Model Railroad Expo, at Boulder County Fairgrounds, Hover & Nelson Roads, sponsored by Boulder Model Railroad Club. Info at bouldermodelrailroadclub.org.

ILLINOIS, LISLE (Naperville), October 22-24, 22nd Annual Naperville RPM Conference, hosted by Joe D'elia, at Sheraton Lisle-Chicago Hotel, 3000 Warrenville Road. Info at railroadprototypemodelers.org/naper_meet.htm.

NEW HAMPSHIRE, GREENFIELD, October, 17, Railroad Show, at Greenfield Historical Society, 828 Forest Road. Info from Dale Russell at dkrussell2@myfairpoint.net.

OHIO, DAYTON, November 7-8, 40th Annual Dayton Train Show, at Hara Arena, 1001 Shiloh Road. Info at daytontrainshow.com.

SELECTED EVENTS | 6

OHIO, WEST CHESTER, October 10, NMRA Mid-Central Region, Cincinnati Division 48th Annual Model Railroad Show at Lakota West High School, 8940 Union Centre Blvd. Info at cincy-div7.org. For table rental information contact Roy Hord at (513) 777-5337 or rhord@fuse.net.

TEXAS, FOREST HILLS, October 10-11, Texas Western Model Train Show, presented by the Texas Western Model Railroad Club, at Forest Hill Civic Center, 6901 Wichita Street. Info at twmrc.org.

TEXAS, SAN ANTONIO, November 21, Texas Train Show, at Christopher Hall, 16002 Thousand Oaks Drive. Info at texastrain-show.net.

WISCONSIN, WEST ALLIS (Milwaukee), November 14-15, Trainfest, Wisconsin Exposition Center at Wisconsin State Fair Park. Info at trainfest.com.

Future 2016 and beyond (by location)

CANADA, BRITISH COLUMBIA, SALMON ARM, June 15-19, 2016, Pacific Northwest Region Annual Convention and Train Show.

COLORADO, DENVER, 2017, National Narrow Gauge Convention.

INDIANA, INDIANAPOLIS, July 3-10, 2016, NMRA National Convention and National Train Show. Info at nmra2016.org.

MAINE, AUGUSTA, Sept. 7-10, 2016, 36th National Narrow Gauge Convention. Info at nngc2016.org. ■



**Click here for
reader comments**

Clickable advertiser index – 1

[Accu-Lites](#)

[American Ltd \(San Juan\)](#)

[Amherst Railway Society](#)

[ANE Models](#)

[Archer Fine Transfers](#)

[Athearn](#)

[Atlas Model Railroad Co.](#)

[Bachmann](#)

[Bachrus](#)

[Backdrop Junction](#)

[Berrett Hill Trains](#)

[Black Cat Publishing](#)

[Blair Line](#)

[BLMA](#)

[Bowser](#)

[Caboose Hobbies](#)

[Canyon Creek Scenics](#)

[Clever Models](#)

[Coastmans Scenic Products](#)

[Coffman Graphics](#)

[Credit Valley Railway](#)

[Digitrax \(2 page spread\)](#)

[ESU LokSound](#)

[Fast Tracks](#)

[Fifer Hobby Supply](#)

[Fox Valley Models](#)

[George's Trains](#)

[GLX Scale Models](#)

[Grand Central Model Railway](#)

[Great Decals](#)

[Hobby-On \(MRS Hobby\)](#)

[Iowa Scaled Engineering](#)

[Iwata-Medea](#)

[Jelsma Graphics](#)

[Ken Patterson](#)

[Lights 4 Models](#)

[Litchfield Station](#)

[Logic Rail Technologies](#)

[Maple Leaf](#)

[Micro Mark](#)

[Microscale](#)

[Missouri Pacific Historical Society](#)

[Model Railroad Benchwork \(1\)](#)

[Model Railroad Benchwork \(2\)](#)

[Motrak Models](#)

[Mountain Subdivision Hobbies](#)

[MRH Store \(Model Trains Video\) \(1\)](#)

[MRH Store \(Model Trains Video\) \(2\)](#)

[MRH Store \(Model Trains Video\) \(3\)](#)

[MRH Store \(Model Trains Video\) \(4\)](#)

[Model Tech studios](#)

[Nano-Oil](#)

[National Narrow Gauge Conv.](#)

[NCE \(2 page spread\)](#)

[Nick & Nora Design](#)

[North American Railcar](#)

[Portland National Train Show](#)

[Pre-Size Model Specialities](#)

[Precision Design Co.](#)

[Rapido \(1\)](#)

[Rapido \(2\)](#)

[Ring Engineering \(1\)](#)

[Ring Engineering \(2\)](#)

[Rulers-of-the-World](#)

Clickable advertiser index – 2

[Rusty Stumps](#)

[Scenic Express](#)

[Scotty Mason Show](#)

[Soundtraxx \(Blackstone\)](#)

[Southern Digital](#)

[Streamlined Backshop](#)

[TAM Valley Depot](#)

[Tony's Train Exchange](#)

[Trainfest](#)

[TrainMasters TV \(1\)](#)

[TrainMasters TV \(2\)](#)

[TrainMasters TV \(3\)](#)

[Traintek](#)

[True Scene Modeling](#)

[Vector Cut](#)

[Westerfield Models](#)

[Yankee Dabblor](#)

[Yarmouth Model Works](#)

Clickable “other” index

[Other – Bonus Extras](#)

[Other – Cover](#)

[Other – Derailments](#)

[Other – Hobby Marketplace](#)

[Other – MRH Sponsors](#)

[Other – Staff Notes](#)

[Other – Table of Contents](#)



DOWNLOAD PORTRAIT



DOWNLOAD LANDSCAPE



REVERSE RUNNING

commentary

DON HANLEY
.....



[Click here for
reader comments](#)

AND THE WINNER IS ...



IT'S AUGUST, AND THE

NMRA National Convention is just around the corner. Part of the convention is the celebration room, where models and photographs are judged for merit achievement and First, Second, and Third place awards are given in various categories.

For some the competition is important, and for others, well, let's just say it's the dark side of the hobby. Does competition have a place in model railroading? I am referring specifically

to the competition that happens at regional and national NMRA meets, called contest awards. Models are judged, points awarded and a winner declared. You can learn more about contest guidelines at <http://nmra.org/celebration-contests-5>

▶ STEPPING OUTSIDE THE BOX WITH A CONTRARY VIEW

As a culture we are very competitive, in sports, business, and in life. I believe there is a place for competition, and then there are places where it is not appropriate.

Competition is the basis for sports. Rules and the objectives may differ, but games are based on competition. Who would want to watch a football or basketball game if the players weren't trying to best their opponents? The game wouldn't be very entertaining.

To the NMRA's credit, they do have a defined point system along with a group of judges to eliminate any bias that an individual judge may have. I am confident that the judges do their best to be honest and fair during the judging.

While a category may be Freight Cars, Steam Locomotives or Structures, you are not necessarily competing against similar cars, locomotive, or structures. A 4-8-4 Northern could be competing against a 0-4-0 tank switcher. In the structures category, you could have a lift bridge competing against a station or signal tower.

Comparing a beautifully detailed 4-8-4 to a similarly detailed 0-4-0, more often than not the larger locomotive will win. Why? Most people like bigger things over smaller ones. It seems to be a part of our human nature, a subconscious bias we all have.

I believe that merit judging of models is good. It allows you to have your work critiqued by other competent modelers. Until someone tells us otherwise, it is easy to have an unrealistic view of our own skills. I recently had two bridges judged for merit awards. The comments were helpful, giving me guidance on my modeling abilities.

I am all for *this type* of competition, because I am competing *against myself*.

But is competition against other modelers a good thing? We all have a choice to either enter a contest, or to not. As for me, my general choice is to not.



DERAILMENTS



click to play video
(YouTube video only)



OVERHANG ON CURVES ...

In this video, you can see even the prototype can have problems with overhang on curves. We bet even model railroads rarely have it this bad!

▶ BIZARRE FACTS AND HUMOR (SUPPOSEDLY)

“THE LIGHT YOU SEE AT THE END OF THE TUNNEL IS THE FRONT OF AN ONCOMING TRAIN.”

DAVID LEE ROTH

“THE ONLY WAY TO BE SURE OF CATCHING A TRAIN IS TO MISS THE ONE BEFORE IT.”

GILBERT K. CHESTERTON

“WHEN I WAS A KID, I WENT TO THE STORE AND ASKED THE GUY: DO YOU HAVE ANY TOY TRAIN SCHEDULES?”

STEVEN WRIGHT



**Click here for
reader comments**

Coming next issue ...

- Bob Rivard weathers a 20-year old Alco
- Modeling fall colors
- Prepping cars for operation
- Making a DCC test track
- Forced perspective tricks
- Conveying era effectively
- And lots more ...

