

HAVING FUN WITH TRAINS

MARCH 2015 | FREE

# MRH

MODEL RAILROAD HOBBYIST

ALSO:

- What is JMRI?
- Build a turntable
- Tune up brass steam



MRH visits  
Wally Brady's

## CN Railroad

» READ NOW

EMBEDDED EDITION | PORTRAIT



DOWNLOAD



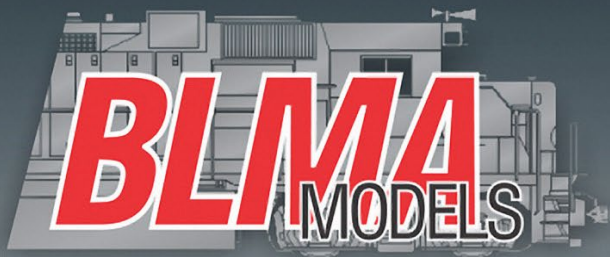

# 52' Gondola

ACF 70-TON

6 NEW PAINT SCHEMES

**N**SCALE



▶ ORDER BY: March 15th  
▶ DELIVERY BY: Late 2015

**CLICK HERE TO SEE MORE**



[MRHMAG.COM](http://MRHMAG.COM)

- [TABLE OF CONTENTS](#)
- [INDEX](#)





# STAFF CREDITS

**Front Cover:** This month we visit Wally Brady's picturesque HO Canadian National layout via a photo tour authored by Mike Tylick.

**ISSN 2152-7423**

## Editorial Staff

Joe D. Fugate, Publisher and Editor  
Don Hanley, Assistant Editor

## Production

Patty Fugate, pasteup and layout  
Joe Brugger, copy editing  
Mike Dodd, copy editing

## Technical Assistants

Jeff Shultz  
Jimmy Simmons

## Advertising

Les Halmos, Account Manager  
Daniel Nava, Advertising Assistant  
Jean-François Delisle, Marketing Assistant

## Columnists

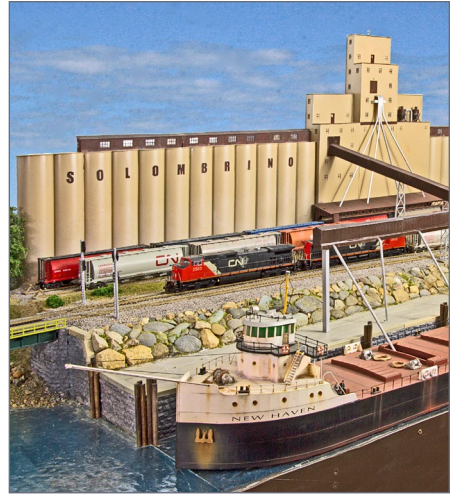

Richard Bale, News and events  
Jeff Shultz, News and events  
Les Halmos, Modular railroading  
Larry Smith, Narrow Gauge/Shortlines  
Bruce Petrarca, DCC  
Ken Patterson, Reporter at large

## Special Correspondents

Joe Brugger, Questions & answers  
Charlie Comstock, Contributing editor  
Issue password: Mar2015

Published for the glory of God. [What's this?](#)





# MRH SPONSORS

## A - E



[acculites.com](http://acculites.com)



[www.americanlimitedmodels.com](http://www.americanlimitedmodels.com)



[railroadhobbyshow.com](http://railroadhobbyshow.com)



[archertransfers.com](http://archertransfers.com)



[athearn.com](http://athearn.com)



[www.atlasrr.com](http://www.atlasrr.com)



[bachmanntrains.com](http://bachmanntrains.com)



[bachrus.com](http://bachrus.com)

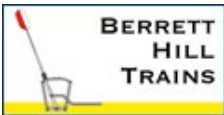

[berrethill.com/trains](http://berrethill.com/trains)



[blairline.com](http://blairline.com)



[blmamodels.com](http://blmamodels.com)



[bowser-trains.com](http://bowser-trains.com)



[brassexpo.com](http://brassexpo.com)



[caboosehobbies.com](http://caboosehobbies.com)



[coffmaneng.com](http://coffmaneng.com)



[con-cor.com](http://con-cor.com)



[cvrco.com](http://cvrco.com)



[www.digitrax.com](http://www.digitrax.com)



[crest-electronics.net](http://crest-electronics.net)



[www.esu.eu/en](http://www.esu.eu/en)

[Vendors: Get your clickable logo here ...](#)



# MRH SPONSORS | 2

## F - P



[www.handlaidtrack.com](http://www.handlaidtrack.com)



[fiferhobby.com](http://fiferhobby.com)



[modelrailroadexpo.com](http://modelrailroadexpo.com)



[foxvalleymodels.com](http://foxvalleymodels.com)



[georgestrains.com](http://georgestrains.com)



[glxscalemodels.com](http://glxscalemodels.com)



[www.hobby-on.com](http://www.hobby-on.com)



[www.iascaled.com](http://www.iascaled.com)



[iwata-medea.com](http://iwata-medea.com)



[litchfieldstation.com](http://litchfieldstation.com)



[microscale.com](http://microscale.com)



[micromark.com](http://micromark.com)



[model-trains-video.com](http://model-trains-video.com)



[modelrectifier.com](http://modelrectifier.com)



[stores.ebay.com/Motrak-Models](http://stores.ebay.com/Motrak-Models)



[mtalbert.com](http://mtalbert.com)



[mthtrains.com](http://mthtrains.com)



[nano-oil.com/Model%20Railroad.html](http://nano-oil.com/Model%20Railroad.html)



[necedcc.com](http://necedcc.com)



[nickandnoradesigns.com](http://nickandnoradesigns.com)



[www.pwrs.ca/main.php](http://www.pwrs.ca/main.php)



[ottawatrainexpo.com](http://ottawatrainexpo.com)



[nationaltrainshow.com](http://nationaltrainshow.com)

[Vendors: Get your clickable logo here ...](#)



# MRH SPONSORS | 3

## R - Z



[railmasterhobbies.com](http://railmasterhobbies.com)



[rapidotrains.com](http://rapidotrains.com)



[ringengineering.com](http://ringengineering.com)



[rr-cirkits.com](http://rr-cirkits.com)



[rslaserkits.com](http://rslaserkits.com)



[rustystumps.com](http://rustystumps.com)



[sanjuancarco.com](http://sanjuancarco.com)



[scenicexpress.com](http://scenicexpress.com)



[signaturepress.com](http://signaturepress.com)



[soundtraxx.com](http://soundtraxx.com)



[sodigi.com](http://sodigi.com)



[sunsetmodels.com](http://sunsetmodels.com)



[tamvalleydepot.com](http://tamvalleydepot.com)



[tcsdcc.com](http://tcsdcc.com)



[tonystrains.com](http://tonystrains.com)



[traintekllc.com](http://traintekllc.com)



[trainworld.com](http://trainworld.com)



[walters.com](http://walters.com)



[yankeedabblers.com](http://yankeedabblers.com)

[Vendors: Get your clickable logo here ...](#)



Looking for something? Also check our Hobby Marketplace!

Take me there!



# N SCALE

# GARX 37'

# MEAT

# REEFER

**ORDER DEADLINE  
MARCH 17, 2015.  
MODELS DUE FALL 2015.  
\$34.95 SINGLES, \$139.80 4-PACKS**



[www.rapidtrains.com](http://www.rapidtrains.com)

[MRHMAG.COM](http://MRHMAG.COM)

- TABLE OF CONTENTS
- INDEX



# TABLE OF CONTENTS

## FEATURES

### Wally Brady's Canadian National

MIKE TYLICK

Extensive photo tour of a great looking layout



### Scratchbuild a turntable & pit

MIKE HOLLY

Adding a turntable to your layout, step-by-step



### Brass steam engine tuneup & repair

BOB BATTLES

Get those locos to run as good as they look



### Southern Pacific's GE Dash 7s: 1

JEFF SKINNER

Part 1 of how to easily add detail your GE locos



### First Look: Michael Rose's LED boards

DAVE KILBORN & KEVIN ROWBOTHAM

Adapting modern technology for layout lighting



**ALSO:** Hobby Marketplace | Bonus downloads



# TABLE OF CONTENTS | 2

## COLUMNS

**MRH Q-A-T: Silver solder, Kato pickups**

*compiled by JOE BRUGGER*

**DCC Impulses: JMRI - More than DecoderPro: 1**

*BRUCE PETRARCA*

**Getting Real: More signature freight cars**

*TONY THOMPSON*

**What's Neat: Photo shoot with Athearn**

*KEN PATTERSON*

**Photo feature: Yes, it's a model**

*compiled by DON HANLEY*

**Derailments: Bizarre facts & humor (supposedly)**

*compiled by THE MRH STAFF*

## NEWS and EDITORIAL

**Asst Editor's Thoughts: Getting unstuck**

*DON HANLEY*

**Staff notes: Getting ready for August 2015**

*compiled by THE MRH STAFF*

**News & Events: March 2015**

*RICHARD BALE & JEFF SHULTZ*

**Reverse running: The end of youth in the hobby?**

*JOE FUGATE*



**NEW ANNOUNCEMENT**

**A AND B-UNIT GENESIS GP9S**

ATHEARN BRINGS BACK THE PRR/UP GP9B IN GENESIS HO SCALE!

Taking a page from the F-units, EMD developed the GP9B to cut down on maintenance costs. The PRR and UP were the only railroads to order these units from EMD. As the GP9 saw service, these units also ventured into other paint schemes as well.

- Era: 1959+ GP9B
- Brand new tooling
- Separately installed wire handrails and wire grab irons
- Fully assembled
- Etched metal fan grille
- Razor-sharp printing and painting
- McHenry® scale knuckle spring couplers
- Machined metal wheels
- Minimum radius: 18"



Cab-Less with the most detail



Union Pacific A and B Units



Penn Central GP9B



**VISIT**  
Your Local Retailer

**CLICK**  
Athearn.com

**CALL**  
1.800.338.4639

**SERIOUS FUN®**

©2015 Horizon Hobby, LLC. Athearn, Genesis, Ready To Roll, Trains in Miniature, Serious Fun and the Horizon Hobby logo are trademarks or registered trademarks of Horizon Hobby, LLC. The Union Pacific mark and other marks owned by Union Pacific are made under trademark license from Union Pacific Railroad Company. All other trademarks, service marks and logos are property of their respective owners. Final models may vary slightly from photos shown. 4/9/15





# ASSISTANT EDITOR

editorial

.....  
DON HANLEY



[Click here for  
reader comments](#)

## GETTING UNSTUCK

**IT HAPPENS TO EVERY ONE OF US – WE COME** to a point in the construction of our layout or operations on the layout where things don't work, and we are stuck. Ideas that we thought would work don't. The switching of a town or industry doesn't work the way envisioned. Often the ideas that we put down on paper are missing something. A contractor once told me "nothing messes up a set of plans like reality," as he was pointing out a problem with a project I was in charge of.

So what do you do when you get stuck, when reality rears its ugly head and progress comes to a standstill? You discover that some part of your layout don't work very well, or worse, not at all.

The first thing I do is to step away from the problem. Often it is just a simple matter of taking time to clear my mind and then later come back to study why something isn't working. I would say that this works 75%-80% of the time. In these instances, I come up with a new or different way of doing a particular task.

I find occasions where a specialty item or tool is needed. Those times I take the opportunity to clean up and look around to

## ASSISTANT EDITOR'S THOUGHTS | 2

determine if I need those items or tools for other areas on the layout. If so, I purchase them and get on with the task.

When purchasing a tool, I look for quality tools and pay more if needed. I have learned that cheap tools cause more headaches and problems, and the small savings isn't worth it. When a cheap tool proves to be inferior, I go back and purchase a quality tool like I should have in the first place.

There are times when I have gotten stuck because I did not have sufficient knowledge or skills to overcome the obstacle. Sometimes this requires me to ask for help. I've learned to not be too embarrassed to ask for help – the only dumb questions are those that are not asked.

Then I've found instances where my track plan just doesn't work. Maybe there's a major bottleneck that causes operational

### ADVERTISEMENT



**1<sup>st</sup> choice for model railway supplies and service.**

**Expedited mail service available across North America.**

Click to visit  
**WWW.CVRCO.COM**  
**1 800 464 1730**





# FAST TRACKS

## YOUR VERY OWN TRACK FACTORY

Make the most of your modeling experience.

Build perfect trackwork easily and inexpensively when YOU want it!



Check out our extensive (and growing!) online video library to learn how easy it is to hand lay your own trackwork with Fast Tracks tools and supplies.

*Play Video* 



shop online 24/7

1-888-252-3895

[handlaidtrack.com](http://handlaidtrack.com)

[service@fast-tracks.net](mailto:service@fast-tracks.net)

[MRHMAG.COM](http://MRHMAG.COM)

- [TABLE OF CONTENTS](#)
- [INDEX](#)



**NICK & NORA DESIGNS**

Uniquely inspired craftsman kits

Craftsman Structure Kits,  
Detail Parts, Shingles,  
Vehicle kits from:  
Sylvan & Jordan  
Tru-Color paint, glues & more!



LIKE US ON  facebook

**The Fine Scale  
Model Railroader Expo**  
THE EXPO STEAMS INTO  
SCRANTON, PA **2015**

**Checked us out lately?**



**WHAT'S NEW?** 

Established 1993...  
**Blair Line**

## ASSISTANT EDITOR'S THOUGHTS | 3

problems or the interest I thought a specific switching pattern would create just falls flat, causing me to lose interest.

In those instances, I study the track pattern and the train movements I'm attempting to create. I find the source of the problem and where the track pattern can be changed. Also, I study the prototype – I sometimes find my solution there.

I've found a great source for studying the prototype is Google maps (see: [maps.google.com](http://maps.google.com)) or Google earth ([earth.google.com](http://earth.google.com)) which can be downloaded for free. The advantage of using programs like these is that I get an overhead view of many track arrangements to study. Railroads need to get it right. Excessive switching or track work costs money, affecting the bottom line.

I've also learned to not be afraid to tear out track and realign it. Jim Petro, the owner of a layout I operate on, has torn out

**HO**  
SCALE



SHIPPING NOW!

VERMONT RAILWAY #6  
Item No. 63111 **NEW**

**THE CHOICE IS YOURS!**  
**DCC-READY OR DCC-SOUND EQUIPPED HO ALCO S4**

This sturdy Switcher was the choice of many railroads. Featuring six new roadnames, Bachmann offers the Alco S4 Diesel in a DCC-ready model with factory-installed 8-pin socket for the DCC decoder installation of your choice. The S4 is also available in a DCC sound-equipped model that includes our Sound Value SoundTraxx® diesel sound package with prototypical prime mover, 3 air horns, and bell—all in polyphonic 16-bit sound. Whether you are a DC modeler who wants the option to add DCC or a DCC modeler who enjoys sound, the Alco S4 is a great choice for your HO railroad!

Alco S4 features include:

- choice of DCC-ready and DCC sound-equipped models
- operating dual directional headlights
- die-cast chassis
- die-cast fuel tanks and underframe
- E-Z Mate® Mark II couplers

DCC-READY S4 MSRP \$129.00 each



GRAND TRUNK #8087  
Item No. 63107

NORFOLK AND WESTERN #2046  
Item No. 63108

NORTHERN PACIFIC #713  
Item No. 63109

NEW YORK CENTRAL® #8598  
Item No. 63110

PRR #8490  
Item No. 63112

Click to learn more.

DCC-SOUND EQUIPPED S4 MSRP \$235.00 each

Item No. 63209 ATSF #1529

Item No. 63211

MILWAUKEE ROAD #816

Item No. 63210 UNION PACIFIC® #1167

Item No. 63212

ERIE LACKAWANNA #528



Bachmann Industries, Inc. • 1400 East Erie Avenue • Philadelphia, PA 19124 USA • [www.bachmanntrains.com](http://www.bachmanntrains.com)

Click for more information.

MRHMAG.COM

- TABLE OF CONTENTS
- INDEX

## ASSISTANT EDITOR'S THOUGHTS | 4

track and realigned it three or four times, all to make passenger car terminal switching and storage flow more smoothly with arriving and departing passenger trains, freight trains, and local industrial switching. Switching is still tight and cooperation is required, but the same is true of any prototypical Union Station area. Jim's willingness to "rip and replace" track when needed has made a portion of his layout that was difficult to operate into a fun but challenging area.

I find I also sometimes need to take the approach that Tom Johnson took on his Indiana Northern layout: just remove some of the track and industries. Sometimes we just have too much track in a certain area, and it causes problems. As the famed architect Mies van der Rohe said, "less is more."

Whatever it is that has you stuck in the hobby, don't give up, Clear your head, take the time to figure it out and you will overcome it and enjoy the hobby even more than ever.



[Click here for  
reader comments](#)



# Here's how to quench your thirst for specialty cars.

## MRC-Model Power's Limited Edition, 6-Piece, Micro-Brew Beer Cars.

Looking for something out of the ordinary? Put a cool one on your layout with our colorful, 6-pack of reefers.

Genuine color schemes and brewery specific logos.

- HO scale craft beer cars in 6-pack Gift Carry Case

- Quality construction. Knuckle coupler equipped



AMERICAN MAID BEER  
PENNSYLVANIA



BLACK FOREST BREWERY  
NEW YORK



ONE SOUND STATE BEER  
NEVADA



LAND OF LAKES BEER  
ILLINOIS



STRAIGHT EIGHT BEER  
FLORIDA



COOK'S "500" BEER  
INDIANA

To see what Model Power has to offer, click here or see your dealer.

**CLICK HERE**



MODEL RECTIFIER CORPORATION  
80 Newfield Ave. ■ Edison, NJ 08837 ■ Phone: 732.225.6360 ■ [www.modelrectifier.com](http://www.modelrectifier.com)

TECHNOLOGY. PERFECTED.

Model railroads  Plastic model kits  Battery chargers  Radio control  Scenery  Die cast

# MODEL RAILROAD HOBBYIST MAGAZINE

## STATEMENT OF OWNERSHIP, MANAGEMENT, AND AUDIENCE<sup>1</sup>

Title of publication: Model Railroad Hobbyist Magazine

- ISSN: 2152-7423

Date of statement: 1 February 2015

Frequency of issue: monthly

- Number of issues published annually: 12
- Lifetime subscription: No charge (just supply email)

Location of office of publication:

Woodburn, Oregon 97071

County, Marion

Names of publisher, editor:

Publisher: Joe Fugate

Editor: Joe Fugate

Owners: Joe and Patty Fugate

Known bondholders, mortgagees, and other security holders

owning or holding one percent or more: none

### Extent and Nature of Audience<sup>2</sup> as of Feb 1, 2015

Total monthly unique device views: 117,831 (based on unique IPs)

Total monthly unique users: 76,590 (determined per [IAB guidelines](#))

Total monthly website visits: 203,686

Average duration of website visit: 6:24

Percentage of OS/devices used to visit:

Windows: 60.7%

iOS: 17.1%

Macintosh: 10.2%

Android: 10.0%

Linux: 1.3%

All others: 0.7%

Percentage of browsers used to visit:

Chrome: 30.3%

Internet Explorer: 21.8%

Safari: 21.5%

Firefox: 20.1%

All others: 6.3%

Total mailing list subscribers: 31,376

We certify that the statements made above are correct and complete.

Joe D Fugate Sr., CEO and Publisher; Patricia C. Fugate, Co-owner

Model Railroad Hobbyist Magazine

<sup>1</sup> Per the Alliance for Audited Media and the Interactive Advertising Bureau (IAB), a totally digital publication such as Model Railroad Hobbyist must measure "circulation" by tracking *Audience* per publishing cycle (monthly in the case of MRH) since there is no direct physical publication to count. The Audience statistics reported here follow the strict guidelines set forth in this document published by the IAB and endorsed by the AAMI: <http://www.iab.net/media/file/IABAudienceReachMeasurementGuidelines.pdf>

<sup>2</sup> Computed and provided by Google Analytics (and can be independently verified by Google as correct and complete).



Model Railroad Hobbyist | March 2015 | #61

# STAFF NOTES



[Click here for reader comments](#)

## GETTING READY FOR AUGUST 2015, NEW IMAGINEERING COLUMN UPDATE, AND MORE ...

**IN HIS FEBRUARY EDITORIAL, JOE FUGATE** talked about looking at his layout and how to get it ready for the 2015 NMRA National Convention that's coming to Portland, Oregon the last week of August 2015.

Here's what Joe said is happening lately:

“My wife Patty said she wants to help get the layout ready (she loves scenery work and building structures), so we walked around my Siskiyou Line layout and made a list of all the things we'd like to do to the layout. Of course, the list is more than we could ever hope to finish by August, so we're prioritizing the things on the list.



**Patty Fugate**



“It’s proving easiest to organize the list of things to do by town. We’re planning to also time-box the work. With a time-box, you set a time limit and when the time’s up, you move on. We have six towns on the upper deck and five towns on the lower deck. With 24 weeks left and 11 towns, that gives us about 2 weeks per town.

“We’re also prioritizing the towns, with the towns nearest the entrance getting attention first and the towns farthest from the entrance on the bottom of the list. So if we don’t get to the towns at the bottom of the list, at least we’ve enhanced the look of the layout most when you first enter the layout room, giving you the best first impression.”



## LAST ISSUE’S RATINGS

The top 5 rated articles in the [February 2015 issue](#) of *Model Railroad Hobbyist* are:

- 4.8 Multiple compartment tank cars
- 4.7 Build a Schlessler coal loader
- 4.4 DCC Impulses: Brass steam loco DCC installation tips
- 4.4 Modeling the loading dock at Burlingame, KS
- 4.4 Getting Real: Seeing it all the way through

Issue overall: **4.5**

**Please rate the articles!** Click the reader comments button on each article and select the star rating you think each article deserves. Thanks! ■

# STAFF NOTES | 3

Good thinking, Joe and Patty. We'll be looking forward to hearing more about your work on the Siskiyou Line as the convention approaches.

Oh yes, before we leave talking about Joe Fugate's Siskiyou Line, 2016 is the Siskiyou Line's 25th anniversary (Joe started the layout in early 1991), and we've got a number of big things planned. We're talking videos, eBooks, and a cover story in MRH to celebrate this milestone event. Stay tuned ...

## MRH's new imagining column update

Last issue we mentioned we'd introduce you to the six new columnists here in staff notes. As we met with the columnists and talked about the first column, we all felt it might make the most sense if we devote the first column to a more robust introduction to this new "gang of six".

### ADVERTISEMENT



con-cor.com

Click here for Con-Cor:  
[www.con-cor.com](http://www.con-cor.com)



**NEW ROADS**  
*HO 65' Heavyweight  
and Old Time  
Passenger Cars*  
4 Body Styles  
Spring, 2015 Delivery



Virginia & Truckee: 01-322 Baggage-Mail



Canadian Pacific: 01-223 Coach



Pennsylvania "Futura": 01-94231 Coach



Union Pacific: 01-94333 Baggage-Mail



N&W (tuscan): 01-94382 Combine



N&W (Pevier blue): 01-94434 Solarium.



You already knew that Labelle was the #1 selling lube in the model railroad industry.

But, did you know that Labelle also makes products for the drone and robotics industry, as well as lubes and cleaners for the E-cig & Mod market?

Click here for Labelle:  
[www.labelle-lubricants.com](http://www.labelle-lubricants.com)



## STAFF NOTES | 4

The idea is to provide a nice mug shot and some hobby background on each columnist and to also provide some room for each columnist to discuss their take on the new column. Should make for a great introduction to each of these modelers and what each hopes to bring to our new column for exploring the more creative sides of the hobby.

### To authors: Photos matter most

We often get new authors who will send an article idea our way and when we tell them to go ahead they'll then forward us a text-only draft and ask us what we think.

There's actually some problems with this approach – namely that photos matter most with us. Superb photos and so-so

ADVERTISEMENT

# Rslaserkits

Laser kits, Scratch building supplies

## 10th Anniversary Sale

### 20% off in March

Dealers welcome  
Salem, OR  
503-371-4290



Custom Laser Cutting  
and design  
Sales@rslaserkits.com



## STAFF NOTES | 5

text will still fly with us most of the time, but so-so photos and superb text is very likely to get rejected. So if you really want to help us see what you have in mind and are capable of providing as an author, you need to focus on *photos first*, not the text.

The reason photos matter most is pretty simple. We have copy editors who know their craft and can make any coherent text sound very good. And with a good word processor, cleaning up text is pretty straightforward.

Not so with photos. Photoshop is good, but it's not *that* good. If you send us poorly composed, poorly lit, blurry photos, we can't "just fix them" in Photoshop. You need to know your way around a camera – or have a friend who does.

### ADVERTISEMENT

# Check out the latest Atlas All Scales Catalog!

View and pre-order all of the latest locomotive and freight announcements from Atlas now!

**CLICK HERE!**

ATLAS  
JANUARY - JUNE 2015  
ATLAS 2015 ALL-SCALES CATALOG

RAILROAD CROSSING  
STOP  
LOOK AND LISTEN

Introducing the ALL NEW N Scale Alco S-2 Locomotive!

LOCOMOTIVES & FREIGHT STOCK  
ANNOUNCEMENTS & ARRIVALS

www.atlas.com • www.atlas.com

MRHMAG.COM

- TABLE OF CONTENTS
- INDEX

# March 1829?

CLICK TO KNOW MORE

Here at Microscale we are constantly researching and updating our product lines to keep current and relevant to the ardent builder. We listen to our customers input and try our best to meet all of your modeling needs.

Proudly made  
in the U.S.A.



Family owned  
for over 75 years.



[www.microscale.com](http://www.microscale.com)



## STAFF NOTES | 6

There's another reason too. Text can only go so far in telling us what you're trying to convey. Photos will tell us not only if you're a decent photographer, but also if you're a fair modeler as well. You don't need to be a super modeler, but you do need to have some modeling others could benefit from seeing for one reason or another.

Photos will help us decide more quickly than just about anything else you might send us how what you have to say could help our readers.

It's not that the text does not matter. Photos are the car and text is the fuel, to use a simple analogy. You can have fuel (text) that is awesome, but if the car won't run (poor photos), all the fuel in the world won't get you where you're going.

With both fuel and the car, you're good to go. When you pick the car, you don't look much at the fuel (the text),

## STAFF NOTES | 7

you want to see the car (the photos). With good photos and reasonable text, we have the combination we need to produce a decent article for our readers. You can't have one without the other, so authors keep that in mind!

### What's new on the MRH website?

Helpful discussion threads get posted to our website every day, and if you're eagerly awaiting the next monthly MRH magazine, you can find material that's almost like more articles on our website. Here's a sampling of these posts, some as forum discussions, and some as personal blogs (diaries).

First, let's list a few of the more helpful (or entertaining) forum posts that have shown up on our website recently:

#### ADVERTISEMENT

**Now available – in a limited, revised edition!**

### **Southern Pacific Freight Cars**

Volume 4: Box Cars (revised edition)

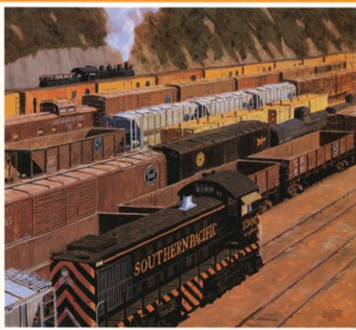

Anthony W. Thompson

This thorough and complete history by SP freight car authority Tony Thompson has been revised and is back in print. It contains a phenomenal amount of information about the SP. How can I learn more about this book? How can I buy it?

**Click here for  
the answer ...**

*SIGNATURE PRESS*

**MRHMAG.COM**

- **TABLE OF CONTENTS**
- **INDEX**



## STAFF NOTES | 8

When railfanning trips go wrong: [mrhmag.com/node/21449](http://mrhmag.com/node/21449)

Airbrush advice: [mrhmag.com/node/20239](http://mrhmag.com/node/20239)

Using polyfiber with ground foam: [mrhmag.com/node/8639](http://mrhmag.com/node/8639)

Custom coal load tips: [mrhmag.com/node/21642](http://mrhmag.com/node/21642)

MicroLED source: [mrhmag.com/node/21653](http://mrhmag.com/node/21653)

Resistance soldering station: [mrhmag.com/node/21415](http://mrhmag.com/node/21415)

Modern logging layouts: [mrhmag.com/node/21541](http://mrhmag.com/node/21541)

Cup holder ideas: [mrhmag.com/node/21619](http://mrhmag.com/node/21619)

Improving small loco pull: [mrhmag.com/node/21364](http://mrhmag.com/node/21364)

GP20 rebuild into WR GP28M-2: [mrhmag.com/node/21257](http://mrhmag.com/node/21257)

3D printed detail parts: [mrhmag.com/node/21585](http://mrhmag.com/node/21585)

### ADVERTISEMENT



# The World's Largest Model Train Store!

Model trains G to Z, DCC, brass models, kits, RTR, collectable models, scenery, structures, books, magazines, DVD's, hobby tools & supplies and a full service repair department.



[WWW.CABOOSEHOBBIES.COM](http://WWW.CABOOSEHOBBIES.COM)

[MRHMAG.COM](http://MRHMAG.COM)

- [TABLE OF CONTENTS](#)
- [INDEX](#)

# STAFF NOTES | 9

And here's a few of the more interesting recent blogs (personal diaries) from the MRH website:

Arizona & California RR in N Scale: [mrhmag.com/node/19198](http://mrhmag.com/node/19198)

“Boulder Ridge” Free-moN Module: [mrhmag.com/node/21655](http://mrhmag.com/node/21655)

Engine house project: [mrhmag.com/node/20992](http://mrhmag.com/node/20992)

Richlawn RR - LED lighting: [mrhmag.com/node/21248](http://mrhmag.com/node/21248)

Somewhere southwest switching layout: [mrhmag.com/node/21520](http://mrhmag.com/node/21520)

Model RR operation tips: [mrhmag.com/node/11187](http://mrhmag.com/node/11187)

Working coal dumper in N:  
[mrhmag.com/node/21243](http://mrhmag.com/node/21243)

Enjoy the March MRH!



**Click here for  
reader comments**

## ADVERTISEMENT

### Rocky Mountain Train Show

March 7th & 8th Denver, Colorado

All Scales 600+ Sales Tables

30 Operating Layouts Clinics

National Manufacturers-



Bachmann

Broadway

Walthers

MTH

Sunset

Kato

Hornby

[Click for More Info](#)

[MRHMAG.COM](http://MRHMAG.COM)

## ADVERTISEMENT



### N SCALE RD-4 HOPPERS



CHICAGO & NORTHWESTERN



BNSF (CIRCLE CROSS)

12 NEW ROAD NUMBERS  
ON EACH SCHEME

BODY MOUNTED  
COUPLERS



UNION PACIFIC (CMO)

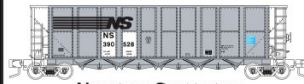

NORFOLK SOUTHERN

METAL WHEELSETS

**RESERVE  
TODAY!**



BNSF (SWOOSH)

[www.foxvalleymodels.com](http://www.foxvalleymodels.com)

- [TABLE OF CONTENTS](#)
- [INDEX](#)

# You're the kid.



## Welcome to the candy store.

- 180,000 square feet of sheer bliss
- Over 250 manufacturer & retailer booths
- 50,000 square feet of modular layouts
- "Ask the Collectibles" appraiser
- Trains, accessories, collectibles & more
- Hands-on demonstrations

**August 28 - 30, 2015**  
**Portland Expo Center**

2060 North Marine Dr.  
Portland, OR 97217

Sponsored by



**CLICK HERE  
FOR ALL THE  
DETAILS!**

[www.nationaltrainshow.com](http://www.nationaltrainshow.com)

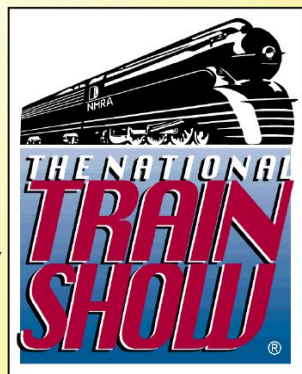

[MRHMAG.COM](http://MRHMAG.COM)

- [TABLE OF CONTENTS](#)
- [INDEX](#)





Model Railroad Hobbyist | March 2015 | #61

# MRH Q-A-T

column

compiled by  
**JOE BRUGGER**  
.....



[Click here for  
reader comments](#)

## QUESTIONS AND ANSWERS

### Silver solder

**Q.** I have my soldering work station set for 750° F. Does it need to be higher for silver solder? My station goes up to 850° F. I'm making a very long N scale chain link fence, planning to sweat the joints together with silver solder which is supposed to be stronger than normal solder. The contact points of the two fence poles are very tiny indeed, hence the need of something strong to work. I've tried all kinds of glues but they're a no-go.

—rsn48

**A.** The easy answer is to experiment with the solder and set the heat so the solder will melt at the touch, without waiting.

**Pelse:** I think there is some confusion between silver solder, which is a type of brazing wire, and silver-bearing solder. These are often called hard solder and soft solder. Silver solder is an alloy of silver and indium or copper (there are other varieties),

▶ MRH QUESTIONS, ANSWERS, AND TIPS

## MRH Q-A-T | 2

and melts at well above 1000° F. You need a torch to solder with it. Soft solder was classically lead and tin, but lead is out of favor and has been largely replaced with zinc and a small amount of silver.

I used to use both kinds as a musical instrument repairman, building sub-assemblies like a flute rib and posts with hard solder, then soft soldering the assembly to the body. I may try this technique the first time I build an etched brass kit.

**Ken K.:** No open flames are necessary. I moved with the electronics industry as it transitioned from lead solders to lead-free solders which do not require significantly higher temperatures for soldering.

For electrical work I almost exclusively use tin-silver-copper solder which melts effectively at temperatures between 215° C to 220° C (419° F to 428° F). These and similar solders are used



**1. Radio Shack sells .015" silver-bearing solder in 1 ounce spools. Radio Shack photo**

in the cosmetic jewelry industry because of their increased strength, so they should meet your fencing needs. I have seen tin-silver-copper solder for sale at Radio Shack.

The melting point of the various silver-bearing solders [1] can range from under 200° C to greater than 360° C, but most of the solders in general hobby use, including most lead-free alloys, have melt temperatures in the range of 215° C to 220° C

## MRH Q-A-T | 3



(419 °F to 428 °F). This is only 20 to 30 °C higher than 60/40 tin/lead (183° C/351° F) but substantially below 750° F (399° C).

If your silver solder is not melting with your iron set to 750° F, I would suspect that your iron is out of calibration or you have a very high temperature solder.

(Note: The tip could also be worn out and in need of replacement.)

**2. A variable power soldering station allows adjusting heat levels to handle different types of solder.**

**Rich:** I use a Weller WLC100 station [2]. I use 4 (75%) on the control, with a wedge tip for soldering feeders. For decoder wires, 50 percent heat with a fine conical tip. I use Cardas Quad Eutectic .032” solder which has silver, copper, tin and lead in it. Been soldering since 1953 and the best solder by far.

Silver-bearing solders:

[grainger.com](http://grainger.com)

[radioshack.com/search?q=solder](http://radioshack.com/search?q=solder)

[mouser.com/ds/2/213/kester\\_300105-317675.pdf](http://mouser.com/ds/2/213/kester_300105-317675.pdf)

[mouser.com/Tools-Supplies/Soldering/Solder/\\_/N-b11qq?P=lyzt5jn](http://mouser.com/Tools-Supplies/Soldering/Solder/_/N-b11qq?P=lyzt5jn)

For the complete discussion: [mrhmag.com/node/21136](http://mrhmag.com/node/21136).



## Kato Dash-2 pickups

**Q.** I'm running a pair of Kato SD40-2 CP snoot locos with Tsunami sound decoders. After a few hours of run time one of them simply stopped working. The slightest rocking of the loco interrupts power. Front truck crosses a frog, stall. Rear truck crosses a frog, stall. Wobble in the track, stall. Reach out and tap it while it's moving, stall. Anyone have any ideas?

—Hobbez

**A. Nelson Beaudry:** The issue I have come across with the Kato/Atlas/Athearn Genesis diesels – they all use the same form of power pickup – is where the axle end fits into the bronze plate. This area relies on the axle making contact with

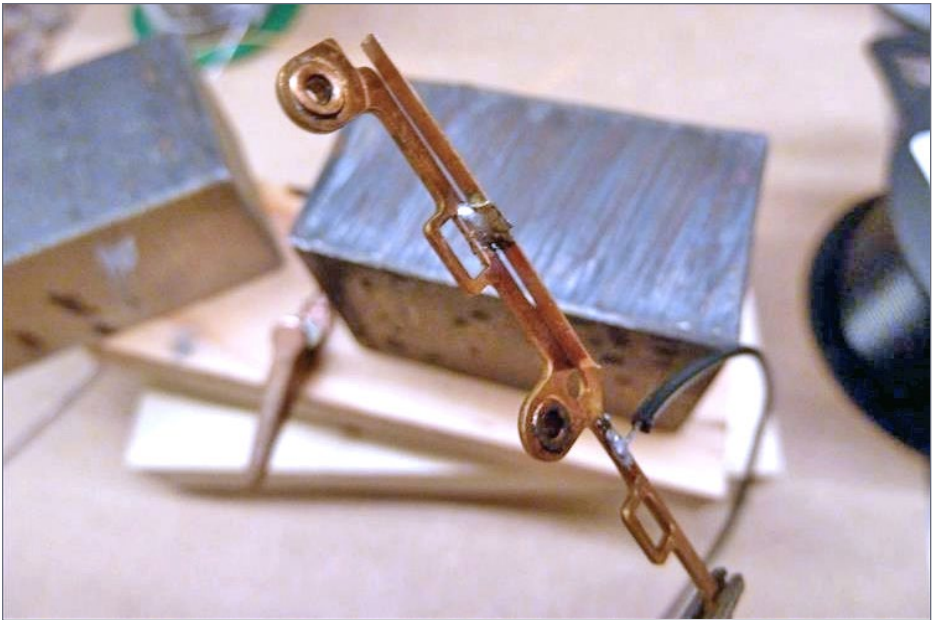

3. Bill Brillinger removed contact strips running on the top of the Kato SD40-2 chassis, trimmed them, and soldered them to the stamping which carries the axle bearings.

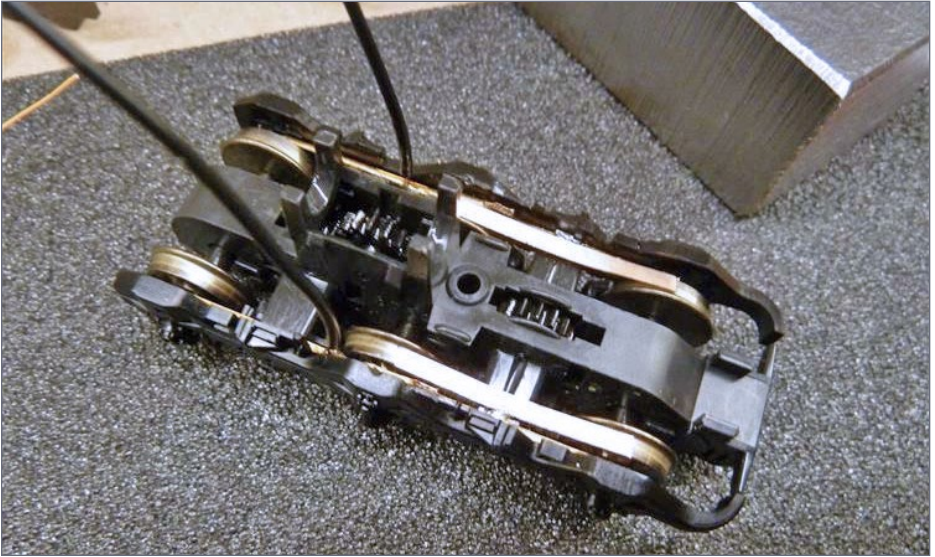

4. The modified contacts are lightly sprung against the wheel treads to give a positive current path. The same idea can be applied to Atlas and Athearn locomotives.  
Bill Brillinger photos

the bearing surface. Any lint/dirt/crud will interfere with electrical pickup. I solder a short piece of springy wire to act as a wiper so that when the axle is installed into the plate, the wire will put a slight amount of pressure against the axle, providing positive contact. I use .008" phosphor bronze wire from Tichy.

**Bill Brillinger:** The contacts from the truck to the chassis on these stink. I made and wired direct wiper pickups for mine [3,4] using the original power strips from the Kato unit.

**Rob Spangler:** I have three of these, and have worked on a couple others for friends. There's nothing inherently wrong with the mechanisms, but the power pickup just doesn't work.

Hard-wire the system (instead of using the under walkway pick up strip) and the Kato SD40-2 is trouble-free. When you're done, the result should look essentially like a typical Kato with the wires coming up from the trucks, and will work just as well.

**Alco Ted:** Those brass contact strips in the SD40-2 units are a poor design, one of very few bad engineering ideas from Kato. Aside from electrical pickup issues, they also cause the trucks to be too rigid and can result in derailments if your track is anything other than 100% dead-flat.

Soldered wires from the truck pickups solve the problem for good, and as an added bonus your Kato SD40-2s can navigate sloppy pre-fab code 100 and 83 turnouts, super-elevated curves, and elevation transitions without derailing. What a concept!

Take care in taking apart and reassembling the trucks. Aside from that, it should be a pretty straightforward process.

**Jurgen Kleylein:** When you have the bearing piece off of the truck, it's your chance to remove part or all of the prong that sticks up towards the frame. This was the contact wiper which rode on the contact strip under the frame, which causes the intermittent contact. Removing this prong allows the truck more lateral motion, which may be what it needs to track better on superelevation and other uneven tracks. A pair of heavy nippers should do the job.

**Rob Spangler:** There's also a plastic extension molded onto the side frame to hide the prong which can be removed now, as it will have nothing left to hide. The plastic can also hang up against the frame and cause derailments.

More input can be found at:



# Bowser

## *EXECUTIVE LINE* HO New Orleans Streetcars

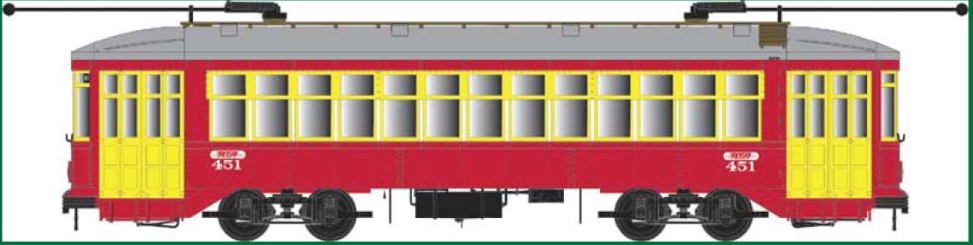

### Features:

Features: Injection molded plastic body, window glass, operating roof poles, operating headlight, DCC Ready with 21 pin plug, accurate painting and decorating, can motor drive with flywheel. Sound trolleys equipped with LOK Sound Decoders (DCC and Sound). We do not recommend them for use on DC (analog) layouts

MSRP \$149.95 w/Sound \$249.95

Click here to check out the details for these and other great Bowser products!

## HO GLa 2 Bay Hopper Cars

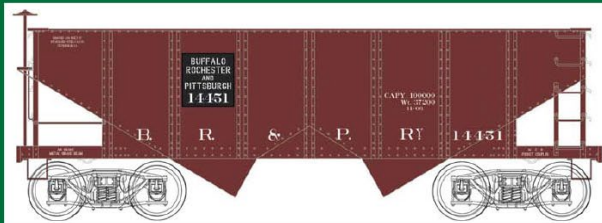

### Features:

One piece plastic molded body, under frame, brake wheel, air tank, brake cylinder, triple valve, free rolling trucks with metal wheels and knuckle couplers  
\$23.95 each

**A "Right Clamp"™ Mini Project**

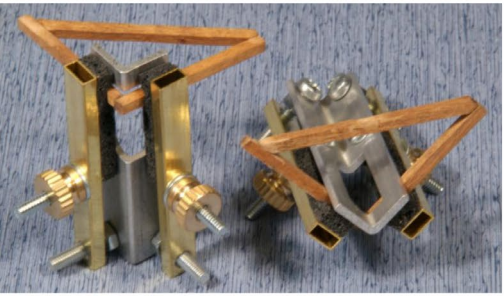

AC-2-2 "Mini Right Clamp"™ used for gluing Bulkhead Frames.

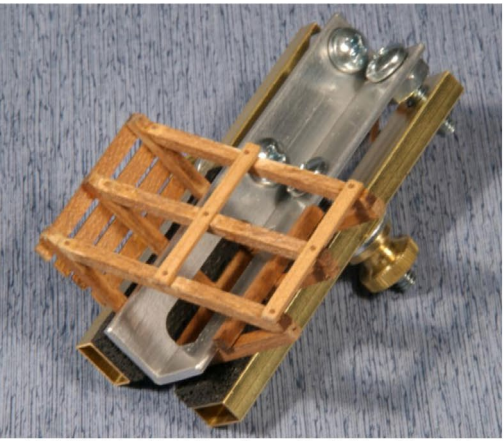

AC-1-1 "Original Right Clamp"™ used for Bulkhead Assembly.



Assembled Bulkhead in gondola with load of ring castings.

**Right and Splice Clamp – Tools for Modelers**

See all our products at:

[www.coffmaneng.com](http://www.coffmaneng.com)

**Coffman Graphic Solutions Co.**

1500 River Circle, Richmond, KY 40475-7907

Phone: 859-527-0476, Fax: 859-527-0485

**MRH Q-A-T | 7**

[katousa.com/consumers/HO-SD40-2-Truck-removal-instructions.html](http://katousa.com/consumers/HO-SD40-2-Truck-removal-instructions.html)

[mrhmag.com/node/17516](http://mrhmag.com/node/17516)

[mrhmag.com/node/17538](http://mrhmag.com/node/17538)

[dufordmodelworks.com/katohardware.html](http://dufordmodelworks.com/katohardware.html)

**Detour moves**

**Q. When trains are detoured over another railroad because of derailments or bad weather, who will operate the engine?**

**A.** The engine will be operated by an engineer who is an employee of the railroad whose train is being detoured, unless otherwise instructed by officers of the railroad over which the detour movement is being made.

A pilot will generally be aboard to keep the engineer informed as to opposing trains, speed restrictions, signals, sidings, water stations (in the steam era) and

- [TABLE OF CONTENTS](#)
- [INDEX](#)

## MRH Q-A-T | 8

other physical characteristics of the road necessary for safe and prompt operation.

—Rock Island Catechism on the Uniform Code of Operating Rules, 1950



### TIPS

#### Tubing storage

A handy compact way to store your brass wire and small tubing is in a fat Big Gulp straw from 7-Eleven. Cap the ends with 3/8" vinyl thread protectors from your local

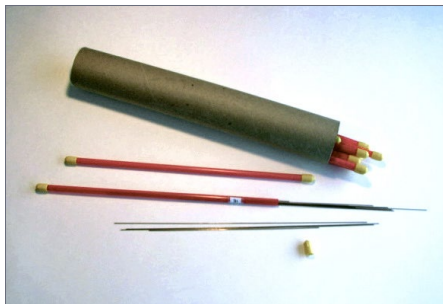

5. Sort wire and tubing sizes into fat plastic straws, cap them, then store the straws in a mailing tube cut to length. Michael Whiteman photo

**DISCOVER**  
Your **POT** of  
**Golden**  
**Savings!**



YD



Yankee Dabblers.Com

**Click NOW!**

*(while supplies last)*

HO

DCC



All Scales

- Kadee - NCE - SoundTraxx  
- Digitrax - And more!





hardware store. A mailing tube cut to length makes a nice storage container.

—Michael Whiteman

## Styrene rack

I like to scratchbuild or kitbash a lot of models with styrene plastic. The problem is how to keep it organized. Going through a stack of packs looking for the size you need is frustrating. I got a wine box from a local store. These cardboard boxes have dividers to hold a dozen bottles of wine, and the sections are perfect for storing my styrene packs.

In the first row, I put the .010", .015", .020", .030" thicknesses. In the second row are .040", .060", and .080". The next row holds my scrap cut-off pieces, and in the back row are structural shapes. In the last two openings I fold the divider over to make a space perfect for my sheet stock packs.



—William W. Davis

6. Adapt a cardboard wine case from the grocery store to protect plastic sheet and strip stock. William W. Davis photo



[Click here for reader comments](#)



GET PAID FOR YOUR TIP

We pay \$25 per tip we publish, or \$40 each if the tip also includes a photo or finished drawing. [Click here and select article type TIP.](#) ■  
.....

**When talking to hobby vendors, please remember to mention MRH.**

ADVERTISEMENT



**Your Local N Scale  
Online Hobby Shop**

**575-523-9743  
fiferhobby.com**

# ***NCE The Po***

**New Web Site!**

**www.ncedcc.com**

**New products**

**How to Videos**

**New Listings**

**Information Station**

**Secure Online Sales**



**NCE**  
*The Power of DCC*

C  
for F  
support@



# Power of DCC

The screenshot shows the NCE website homepage. At the top, there is a navigation bar with links for Information, How To Video, Online Store, Dealer List, and Login/Sign up. A Facebook icon is also present. Below the navigation bar, there are two main links: "Go to the NCE Information Station" and "What is DCC?". The main content area is a grid of product categories, each with a representative image, a category name, and two buttons: "Information" and "Buy Now".

New Products	DCC Systems	Mobile Decoders	Throttles and Cabs	Accessory Decoders
Information	Information	Information	Information	Information
Buy Now	Buy Now	Buy Now	Buy Now	Buy Now
Cab Bus Accessories	Circuit Breakers	Boosters	Command Stations	Parts and Pieces Depot
Information	Information	Information	Information	Information
Buy Now	Buy Now	Buy Now	Buy Now	Buy Now
Automation and Detection	Jacks and Panels	Cables	Power Supplies	NCE Merchandise
Information	Information	Information	Information	Information
Buy Now	Buy Now	Buy Now	Buy Now	Buy Now

## Discover the FUN!

• Made in the U.S.A. •

Call or Email  
FREE Brochure  
@ncecorporation.com

585.265.0230  
9am-4pm EST.  
www.ncedcc.com

MRHMAG.COM

- TABLE OF CONTENTS
- INDEX



# Southern Digital



**20% Discount  
on most Items!**

*Specializing in DCC Since 1992*



## DCC Conversions, Service & Support

Orders Received by 3:00 pm EST ship the same day

**WWW.SODIGI.COM**

E-mail: [sales@sodigi.com](mailto:sales@sodigi.com)

(770) 929-1888

*(Photo's are from our N-Scale layout)*



# DCC IMPULSES

column

BRUCE PETRARCA  
.....



[Click here for  
reader comments](#)

## JMRI: MORE THAN DECODERPRO | AN INTERVIEW WITH SOME OF THE FOLKS BEHIND JMRI, PART 1

**THIS MONTH'S COLUMN DEALS WITH A COR-**  
ner of the DCC world: JMRI. While folks know a lot about the DecoderPro suite from this extensive software package, there is a lot more software behind the curtain. See: [jmri.sourceforge.net/help/en/html/apps/index.shtml](http://jmri.sourceforge.net/help/en/html/apps/index.shtml).

Also, it's worth noting that with JMRI being an open source software project, there's an army of volunteers who can "make it happen."

There are lots of people listed at [jmri.sourceforge.net/help/en/Acknowledgements.shtml](http://jmri.sourceforge.net/help/en/Acknowledgements.shtml) and some of their stories are there, too. I interviewed a few of the hundreds of folks who work to bring JMRI to you as a free-to-the-user application. While JMRI is free open source software, I recommend that

► DCC TIPS, TRICKS, AND TECHNIQUES



## DCC IMPULSES | 2

everybody who uses it contribute, say \$10 per year, to the cause at [jmri.sourceforge.net/donations.shtml](http://jmri.sourceforge.net/donations.shtml).

(You will see why later in the column.) By the way, I'm contributing my income from this column to JMRI.

We start with Bob Jacobsen. Bob is the focal point for JMRI. He coordinates the releases of the JMRI package and has tirelessly worked on and promoted JMRI and open-source software. I've communicated with him via email for years. It was nice to have dinner with him at the 2011 NMRA convention in Sacramento ....

### Bob Jacobsen discusses JMRI history

#### What does JMRI stand for?

**Jacobsen:** It doesn't really stand for anything anymore; it's become just a name. Originally, it was intended to be a

ADVERTISEMENT



**TrainTek tests to make sure every loco sound install we do will blow you away!**

(Yep, that one's good!)

*"Taking model railroad control to the next level ..."*

click here for more details...

**www.traintek.com**





library for programmers to use, in the Java language, so it got the name “Java Model Railroad Interface, JMRI for short. But now it’s much more aimed at individual users with things like DecoderPro and PanelPro. There are a few programmers using it as a library. CATS [Crandic Automated Traffic System] is the best known result of that, but there are a few people using it with their own code for their layouts.

### What is Java and how does it run JMRI?

**Jacobsen:** The “Java Runtime Environment” (JRE) is something that’s needed for a computer to run programs written in the Java language. Some computers come with one, some have to have it installed. On Windows, the JMRI installer will look at what’s already present and prompt you through what needs to be done. Linux machines usually have a suitable Java installed, but if not you can install it with the tools built into your Linux distribution. On Mac OS X, Java has been installed automatically for a long time, but this is starting to change. That’s going to be a confusing situation for a little while.

**Petrarca:** I just installed JMRI on a couple of Macs with Mavericks (OS X 10.9) and it was pretty easy. I checked for Java, using their site ([java.com/en/download/installed.jsp](http://java.com/en/download/installed.jsp)) and installed it where needed. Then I downloaded the JMRI file from website at [jmri.sourceforge.net](http://jmri.sourceforge.net) and installed it. No other fiddling required!

# DCC IMPULSES | 4

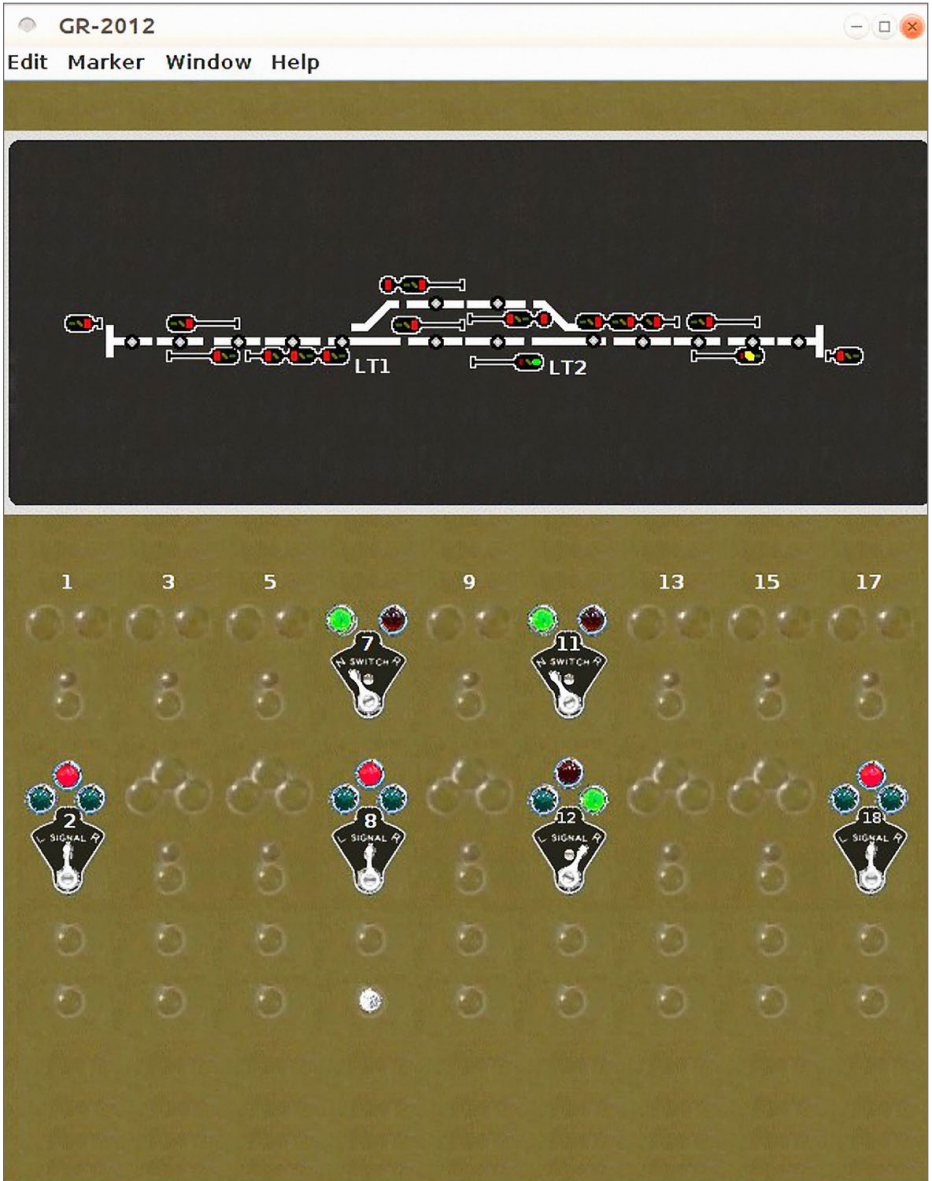

2. PanelPro emulates a classic CTC Panel. Photo courtesy Dick Bronson

## What are the major sections of JMRI and who is the lead team member for each section?

**Jacobsen:** We don't really have "lead members." We have people who like to work on things. Some parts of JMRI were constructed by lots of people; more than 40 people have done parts of the decoder definitions in DecoderPro. At the same time, there can be a few people who've done a lot of work in an area. Michael Mosher, for example, has done a large part of the decoder definitions. As another example, Kevin Dickerson and Dick Bronson have done a lot of work on the prototypical "Signal Mast" support, but a lot of other people have contributed too. David Duchamp started Logix and continues to work on it, as does Pete Cressman. Dan Boudreau has done most of the work on operations.

The code that makes up JMRI is common property, in the sense that anybody can contribute a change to any part of it, and developers can improve any part. The idea is to encourage people to improve it, not build structures that make it harder to improve the code. Whether it's a patch contributed by somebody new, a little improvement that somebody thought of one afternoon, or a big project, JMRI needs continuing improvements to keep becoming even more excellent.

## Tell us a little about JMRI's history

**Jacobsen:** JMRI emerged from a couple of independent efforts around 2000-2001. Technology had reached the point where it had become possible for a small group of people to get together online and develop software even if they weren't in one place. By pulling together some work on decoder programming (the original DecoderPro), interfacing to DCC



## DCC IMPULSES | 6

systems (the original JMRI) and some other bits, the early versions of JMRI could do something for a wide range of people. That in turn attracted more people to add little bits, which got more people interested, etc. Within a couple years, it was a nice little community working on something of value to hobbyists.

After DecoderPro, the next big thing to be added to JMRI was control panels. The original idea was to just have a few icons on the screen that would let you do simple things on the layout, but through the work of Dick Bronson and others it rapidly grew to allow emulation of a complete CTC machine [2]. That, along with the signaling support that was being developed in parallel, then laid the groundwork for the “prototypical signaling” development work that’s going on now. This is now known as PanelPro.

### ADVERTISEMENT



**IOWA SCALED  
ENGINEERING**

### MR servo Slow Motion Turnout Controller

- Features PowerFrog technology
- Low profile
- Short-proof power routing
- No calibration required

[LEARN MORE >](#)



[MRHMAG.COM](http://MRHMAG.COM)

- [TABLE OF CONTENTS](#)
- [INDEX](#)

More recently, JMRI has continued to grow through new efforts that certainly weren't imagined back at its beginning, such as wireless throttles and the operations support. In part that's because all the code is available to everybody, so you can build new things on top of it pretty easily. In part it's because general technology, like iPhones and WiFi are becoming more common and more powerful. But the most important thing is that JMRI is still a nice place to work on things like this. That attracts new people, and makes longer-term members more enthused because it's still fun to work on.

## Where do I buy JMRI?

**Jacobsen:** You don't have to buy JMRI. You already explained how you went about installing it on some Macs. The same method works for Windows or Linux.

The really adventurous can also download a copy of the source code from the JMRI web site and build their own version.

If you don't want to download it, you can get a CD or USB stick with JMRI on it from several places. Your former business [Bruce], Litchfield Station, was one of the first to offer this service to its customers. These people tend to offer them for a very small price and don't make any money on them, so they generally prefer that you download it if you can. It's just easier for everybody.

## How does one become a member of the team?

**Jacobsen:** Do stuff. Seriously, that's all there is. Help answer user questions, write a better explanation for the help pages, improve a decoder definition, or write some code.

### You were part of a landmark legal settlement involving software rights. Would you explain, please?

**Jacobsen:** Starting in 2004, somebody wanted to be paid for every copy of JMRI downloaded, because he claimed he had patents that cover some of the things JMRI (and other programs) do when talking to DCC systems.

This couldn't be allowed to happen, because it would have resulted in the destruction of the JMRI community and the JMRI program. So, I fought it in federal court with the help of Victoria Hall and David McGowan, two fantastic lawyers, and the team they assembled.

Two illegally obtained patents were eventually invalidated at the Patent Office, but we also had to appeal to the World Intellectual Property Organization to get the decoderpro.com domain name back, and file copyright actions over misuse of the DecoderPro decoder definitions.

JMRI is available “free” in the sense of no-cost, but not “free” in the sense of “no restrictions.” There are a few restrictions on what you can do with it in the license. One of the things you can't do is claim it as your own work. A lot of people have worked on it, and they deserve to be recognized for that. If we were to allow somebody else to claim it as their own, a lot of the joy of working on JMRI would go away, and the community would be badly damaged.

These aspects of Open Source law had never really been tested in the courts, and we ended up having to take the case to the Court of Appeals for the Federal Circuit in Washington, D.C. That was a really time-consuming and nerve-wracking thing, but it had to be done, and in the end we won. A settlement agreement covered the last parts, and it was finally over in 2010.

# TONY'S TRAIN XCHANGE

*Committed to your DCC support!*

## ALL-NEW! TDS SuperSonic Speakers



Incredibly Big, High Quality Sound, From Incredibly Small, High Quality Speakers. Don't Forget Enclosures!

Starting at \$5.95

**Order Yours**

## TCS WOW Diesel & Steam Sound Decoders



Superior Audio Quality and Motor Control. 6 Function Decoder With Audio Assist. For Any Steam Loco or EMD Diesel.

Starting at \$74.95

**Order Yours**

## PSX Circuit Breakers



PSX1, PSX2, PSX3, PSX4:  
Protect up to 4 DCC Power Districts!  
PSX-AR: Integrated DCC Circuit Breaker and Auto-Reverser!

Starting at \$37.95

**Order Yours**

**Do you need a Sound or  
DCC Installation done?**

**Get a quote!**



Providing unmatched person to person DCC support for more than 25 years, the kind of service that has made us #1 in DCC.

**DCC questions? CALL US! 1-800-978-3472**

\*Mention this ad for \$5.00 off your next order over \$100!

*We'll get you on the right track!*

April 2015



MRHMAG.COM

- TABLE OF CONTENTS
- INDEX



# DCC IMPULSES | 9

Folks wanting more details can find them on the web at: [jmri.sourceforge.net/k/summary.shtml](http://jmri.sourceforge.net/k/summary.shtml).

## What were the financial impacts of this lawsuit and upon whom?

**Jacobsen:** The costs of a federal lawsuit are pretty severe. The settlement dollars helped, but I'm still significantly in the red.

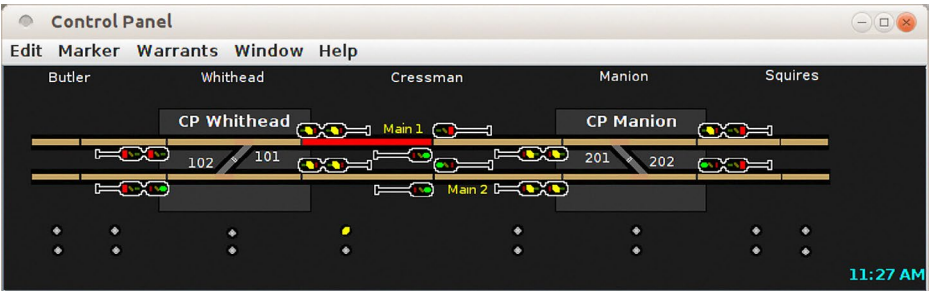

3. PanelPro emulates a modern ABS panel. Photo courtesy Dick Bronson

### ADVERTISEMENT

**Make LocoNet wiring extremely simple!**

Dealer Inquiries Accepted

**ACCU-LITES, inc**

Your DCC Center!

"... great time saver as well as providing flexibility to change things ..." - Terry Nathan



**PM42**  
breakout  
board



**BDL168**  
Multi-zone  
breakout board

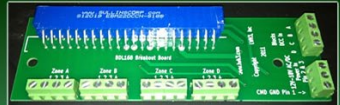

**SE8C**  
breakout  
board



**BDL168**  
Single-zone  
breakout board



Now Offering SNAPS! in packs of 6 or 12 pieces! [CLICK TO LEARN MORE ...](#)

[MRHMAG.COM](http://MRHMAG.COM)

- [TABLE OF CONTENTS](#)
- [INDEX](#)

# DCC IMPULSES | 10

## Since this benefited the group, how can JMRI users help?

**Jacobsen:** Contribute. There's a contributions link on the JMRI web page. Contributions go first to cover the costs of running JMRI (web site and domain name fees, copyright registration fees, etc).

**Petrarca:** The remainder then goes to reimburse you for your five-digit legal expenses. This decision was very far-reaching in the area of open source software. Not only will your contributions help JMRI, but there are lots of bits of free software that will benefit, at least obliquely. I recommend folks give a small amount, say \$10 per year, if they are using any part of JMRI.

### ADVERTISEMENT

## Small Miracles

End wiring frustration with Touch Toggles™



- Elegant controls
- No drilling
- No soldering

See our website for a video introduction!



Made in the USA



What will they think of next?

[www.berretthillshop.com](http://www.berretthillshop.com)

[MRHMAG.COM](http://MRHMAG.COM)

- [TABLE OF CONTENTS](#)
- [INDEX](#)

*“Two illegally obtained patents were invalidated and we had to file copyright actions over misuse of the DecoderPro decoder definitions. We ended up having to take the case to the Court of Appeals for the Federal Circuit in Washington, D.C.”*

## How do I use JMRI with my DCC system and what DCC systems can interface with JMRI?

**Jacobsen:** Most DCC systems that have a computer interface of some kind can be used with JMRI. There's a list here: [jmri.org/help/en/html/hardware/index.shtml](http://jmri.org/help/en/html/hardware/index.shtml).

The manufacturers of the most common ones are uniformly helpful people who've worked with JMRI developers so that their systems are well-supported. Look up the page for your particular equipment to see what kind of interface you might need, if there are any limitations, etc.

For programming decoders, DecoderPro basically works like a throttle on your DCC system. So if you can program the locomotive manually, DecoderPro will be able to take over for you and automate that.

## What about MRC systems?

**Jacobsen:** MRC had gone its own way, relying on its own software and not providing the code so that JMRI could interface with their system. However, in the spring of 2014, they decided to share the interface specifications with the JMRI group. So the MRC system support began with the 3.9.1 test release version of JMRI. That or any later version will do the trick. [Version 3.10.1 is the current release as of this writing.]

# Get Better Sound from your Locomotives

Can't get a good sound from your sound decoder?  
Give our speakers a test drive with your ears.



**RAILMASTER HOBBIES**  
**9812 BELMONT**  
**BELLFLOWER, CA 90706**

Bass Reflex  
Speakers



High Bass  
Speakers



When it comes to speakers we have high quality speakers to fit many different applications.

We are also a full line hobby shop. Need anything? We are an authorized dealer for Soundtraxx, Digitrax, Athearn, Walthers and many others. We provide quality speakers for your DCC sound systems and quality service.

**Click here for  
the answer ...**



## DCC IMPULSES | 12

### What help is available for JMRI newcomers?

**Jacobsen:** The JMRI community is large and helpful. A good place to start is either at a local club, where you'll likely find somebody who can help you in person, or by joining the JMRI users mailing list (<mailto:jmriusers-subscribe@yahoogroups.com>) and asking there. Whether the question is simple or complicated, there's somebody around who'd like to help you get it answered.

In my next column, I have more conversations with others who have worked on some of the other parts of JMRI as I continue my look inside *JMRI*:

*More than DecoderPro.*



[Click here for reader comments](#)

#### ADVERTISEMENT



## Celebrate with us!

As we celebrate 25 years of innovation, we have a few surprises up our sleeves! Visit our website on the 25th of each month for our Silver Specials.

[See our gift to you!](#)

SOUNDTRAXX®

[MRHMAG.COM](http://MRHMAG.COM)

- [TABLE OF CONTENTS](#)
- [INDEX](#)

# Litchfield



## S T A T I O N

**Looking for DCC  
products?  
We carry the  
BEST!**



**623-298-7355 • [www.Mr-DCC.com](http://www.Mr-DCC.com)  
[www.LitchfieldStation.com](http://www.LitchfieldStation.com)**



Complete Train Control



NO  
WA

# Digitrax No Worries Warranty

That's it! A simple, straightforward warranty with no tricky language

You're protected against

Learn

Need tech support?

[www.digitrax.com/contact](http://www.digitrax.com/contact)

Need a repair?

[www.digitrax.com](http://www.digitrax.com)



**NO WORRIES  
WARRANTY**

**Now Keeps Your Layout Running!**

**For one year  
or more!**

**Protects against  
defects and accidental damage.**

**Learn more at: [www.digitrax.com/noworries](http://www.digitrax.com/noworries)**

[www.digitrax.com/repair](http://www.digitrax.com/repair)

**Need a throttle conversion?**

**[www.digitrax.com/upgrade](http://www.digitrax.com/upgrade)**



**New  
Innovation**



## Nano Technology Lubricants

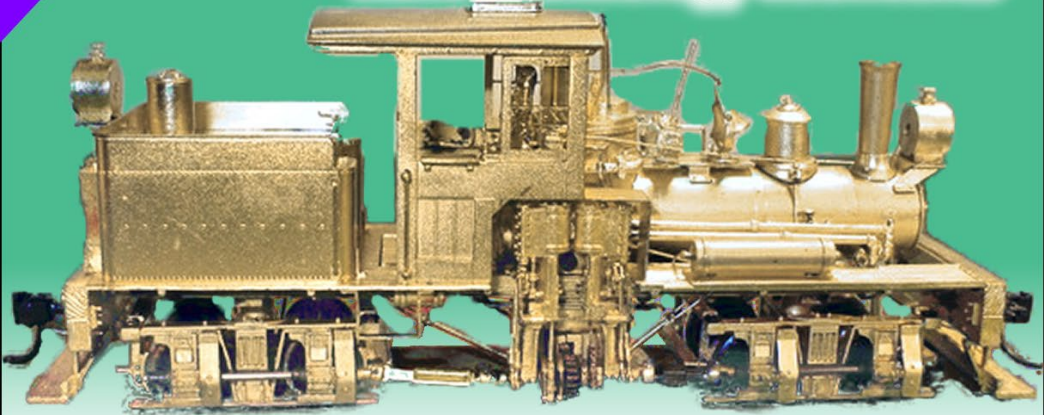

"After eight years of extensive testing, the only lubricants now used in my shop are Nano-Oils and Nano-Grease. The extreme reduction in power draw by mechanically minimizing friction is simply technologically superior."

- Phil Floyd, 'The Shay Fixer'

**THE SHAY FIXER** 

VISIT US AT... [SHAYFIXER.COM](http://SHAYFIXER.COM) 

*Specializing in brass Pacific Fast Mail / United geared locomotives*

**For more details  
click here ...**

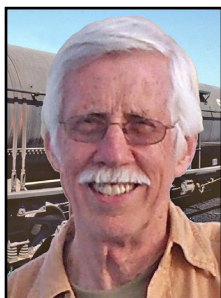

# GETTING REAL

column

TONY THOMPSON  
.....



[Click here for  
reader comments](#)

## MORE “SIGNATURE” FREIGHT CARS | ADDITIONAL EXAMPLES OF ESSENTIAL ADDITIONS TO YOUR FLEET

**IN A PREVIOUS MRH COLUMN, FOR APRIL 2013** (available at: [mrhmag.com/magazine/mrh-2013-04-apr](http://mrhmag.com/magazine/mrh-2013-04-apr)), I provided a set of what I called “signature” freight cars for nine railroads, deliberately omitting some of the largest roads. In this column I extend and complete that set of cars by adding more railroads.

The previous column covered the Milwaukee, B&O, Missouri Pacific, Denver & Rio Grande Western, Northern Pacific, Great Northern, Seaboard, Illinois Central, and Boston & Maine. In this column, I recommend signature cars for 10 additional freight car owners: Pennsylvania, New York Central, Santa Fe, Southern Pacific, C&NW, CB&Q, PFE, Southern, UP, and Western Pacific.

What is a “signature” freight car? The term is sometimes used for unique cars of a particular railroad, such as the famous Milwaukee

► **MODELING REAL RAILROADS AND WHAT THEY DO**

## GETTING REAL | 2

Road rib-side boxcars that I described in the first column, but to me the meaning is broader than that. I use the term “signature” to mean a freight car which is *characteristic* of its owning railroad, meaning that it is reasonably distinctive *and* is a car of which the owner’s roster contained a relatively large number. Unique cars can certainly qualify, but there are many cases where a “standard” car design also qualifies, just because its owner had so very many of them. There are examples in this article.

### Background

Before we talk about individual cars, how were these railroads chosen? In my first column in this series, in *MRH* for December 2011 (download it at: [mrhmag.com/magazine/mrh-2011-12-dec](http://mrhmag.com/magazine/mrh-2011-12-dec)), I showed some comparative data for the freight car fleets of a range of railroads, emphasizing their size. I show an expanded set of the

ADVERTISEMENT

**ONE STOP SHOP**

**N, HO, O, ON30, S & G**

**SHOP ON-LINE 24/7**

**FOR YOUR FAVORITE PRODUCTS:**

ATHEARN | ATLAS | ARISTO-CRAFT | BACHMANN | BROADWAY LTD.  
DIGITRAX | KADEE | KATO | K-LINE | LIFE-LIKE | LGB  
LIONEL | MANTUA | MICROTRAINS | MODEL POWER | MRC  
MTH | NCE | PECO | PIKO | SOUND TRAXX | TCS  
WALTHERS | WILLIAMS | WOODLAND SCENICS | AND MORE...

**SIGN-UP FOR OUR E-MAIL SALES**

**TRAINWORLD.COM**

**1-800-541-7010 e-mail: [ORDERS@TRAINWORLD.COM](mailto:ORDERS@TRAINWORLD.COM)**

**TRAINWORLD®/TRAINLAND® - AMERICA'S LARGEST INTERNATIONAL MAIL ORDER DISCOUNT TRAIN STORE**

**MRHMAG.COM**

- [TABLE OF CONTENTS](#)
- [INDEX](#)

## GETTING REAL | 3

same kind of data, slightly differently arranged, in Figure 1 to explain my railroad choices. The fleets are shown minus the car types which

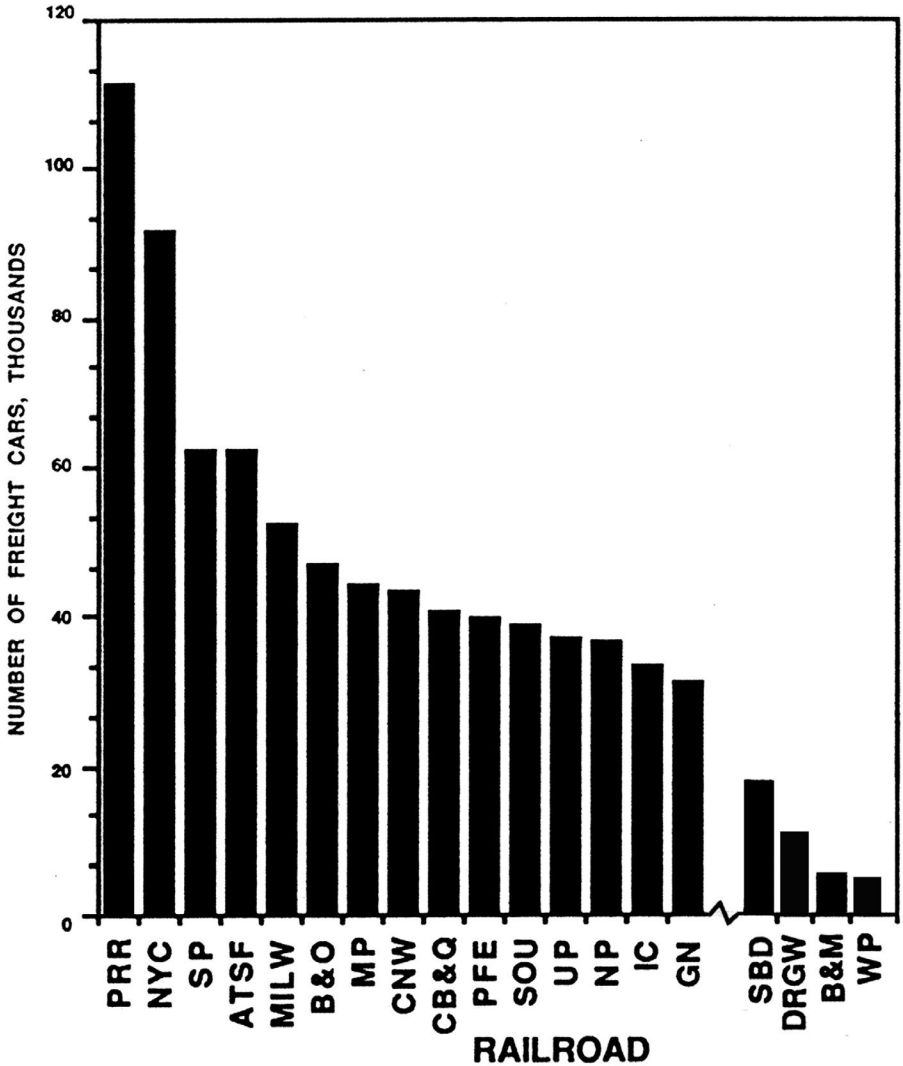

1. Sizes of freight car fleets of individual railroads in 1950, minus coal, ballast, and ore cars, shown in size-order, with a break after Great Northern.



interchanged less frequently than the remaining car types, as I described in my first column, December 2011.

The 19 railroads shown in size-order in Figure 1 are the same railroads listed at the start of this column, with the four smaller ones (Seaboard, D&RGW, B&M and WP) at far right. That is the simple basis for railroad choice: fleet size. This accords with the Gilbert-Nelson idea which I discussed in that first column, and won't repeat here, except to say that the proportional visibility of a railroad's car fleet throughout the nation is believed to reflect the proportion of the size of that car fleet to that of the whole nation.

### Individual railroad selections

There is not space to show the composition of each individual railroad's fleet as to car types. I will just mention that the most comprehensive source of such data is the *Official Railway Equipment Register* or ORER. Historical issues dated between 1885 and the present are available in both digital and print form from libraries and other sources.

Also of great value, if they are available, are the freight car diagram books of individual railroads. Several historical societies have reproduced these, and originals may be found for sale in Internet auctions from time to time.

Turning to the specific railroads, I will present them in order of size, starting with the Pennsylvania Railroad.

**Pennsylvania.** For decades the owner of the largest fleet of freight cars in North America, the Pennsylvania Railroad dominates any summary of freight car ownership. A single class of PRR boxcars, the X29, was built in numbers of more than 29,000 cars, more in that one class than the entire fleets of all but a handful of American railroads. Though they are not treated



2. This Red Caboose model, with some detail upgrades, and heavy weathering typical of PRR in the transition era, represents well the iconic X29 of the Pennsylvania Railroad. The model was built and weathered by Richard Hendrickson.

here, there were classes of hopper cars even larger than the X29 class. So one could readily select several freight cars to represent the PRR. But I will restrict myself to three.

First, of course, is the X29. Its distinctive appearance, with flat roof and ends (on most cars) and low car height, is easily recognized. It is so major a feature of the freight car scene that Ted Culotta, in his outstanding series of articles on “Essential Freight Cars,” devoted two articles to this one class. They are articles 35 and 36 in the series, published in *Railroad Model Craftsman* for January and February 2007.

There is also a very complete and detailed article about the X29 cars by Patrick C. Wider in *Railway Prototype Cyclopedia* No. 24 (2012), which does full justice to this distinctive car design.

## GETTING REAL | 6

Luckily we now have an excellent model basis for this car, the Red Caboose X29, which I show in [2].

Perhaps the next most distinctive Pennsy boxcar design would be one of the round-roof or “wagon-top” designs, 9,000 of which were built in both 40 foot and 50 foot versions and with two different roof styles. An excellent article about these designs, by Patrick C. Wider, was in *Railway Prototype Cyclopedia* No. 22 (2011). Additional modeling information can be found in Ted Culotta’s “Essential Freight Cars” series, article 27, in *Railroad Model Craftsman*, January 2006. I have chosen the X31c to represent this group, [3]. It has a “flush” roof, meaning that the roof sheets curve smoothly onto the sides. Earlier X31 cars had a “notched” roof, with a narrow ledge between the roof sheets and the top of the side.



3. An example of PRR class X31, in this case subclass X31c, with the “flush roof.” Note that the car, originally equipped with auto racks and thus with a white stripe on the right-hand door, has been taken out of that service and the stripe painted over. This car is a W&R Enterprises brass model.

# GETTING REAL | 7

Finally, the Pennsylvania also had a considerable number of gondolas. The elderly gondolas in the PRR fleet up to World War II were rapidly retired thereafter, as the railroad built more than 11,500 new gondolas, placed in several subclasses of class G31. Most were of welded construction, and an excellent article about these cars by Ed Hawkins was published in *Railway Prototype Cyclopedia* No. 19 (2009). I have used the outstanding Tangent model of a member of this class as my signature PRR gondola. It is shown in [4].

**New York Central.** Just as the Pennsylvania Railroad built a huge number of cars of a single all-steel boxcar design, the X29, so did the New York Central build many thousands of all-steel boxcars, but of a different design, based on improvements to the USRA steel boxcar (which was not built under the USRA). A good background of this was provided by Ted Culotta in article 34 in his series,

## ADVERTISEMENT

**RailPro™**  
**NEW TECHNOLOGY**  
DIRECT™ RADIO

**RE RING™**  
ENGINEERING

**NEW Starter Kit**  
**\$399.99 MSRP**

- Includes Wireless Color Touch Screen Handheld Controller and 56 Watt Power Supply
- Expandable to Virtually any Size Layout

**NEW Locomotive Module**  
LM-2 & LM-2S

- Direct Radio RF
- Sound and Non-Sound
- New Tiny Size
- 6 Light Outputs

**Click Here to Learn More**

For more information visit our Internet site: [www.RingEngineering.com](http://www.RingEngineering.com)

MRHMAG.COM

- [TABLE OF CONTENTS](#)
- [INDEX](#)



## GETTING REAL | 8

“Essential Freight Cars,” in *Railroad Model Craftsman*, for October 2006, and Richard Hendrickson covered them in *Railmodel Journal* for March 2007. A much more detailed account by Patrick C. Wider, was in *Railway Prototype Cyclopedia* No. 21 (2010).



4. Starting in 1950, the Pennsylvania built more than 11,500 gondolas as subclasses of class G31. This excellent Tangent model of class G31B shows the welded construction used for most G31 cars.



5. The many thousands of New York Central steel boxcars built to a modified USRA design, together with their long survival in service, made them an unmistakable signature NYC car. This model is by Broadway Limited, with added weathering and an indication of the beginning of paint failure on the roof.

## GETTING REAL | 9

The recent release by Broadway Limited of styrene models of these cars is a great convenience for modelers who need a bunch of them. One of the Broadway cars is shown in [5], with added weathering and a little paint failure indicated on the roof.

Also noteworthy for the New York Central were rebuilding programs they carried out with older cars. I have chosen one representative. During 1916–1918, New York Central acquired 9,500 double-sheathed auto cars. In the 1930s, over 5,800 of these cars were rebuilt as boxcars with steel sides. There were over 4,000 such rebuilt cars in service in 1953, when I model; the car shown in [6] is from a Sunshine resin kit.

Lastly, the New York Central, like the Pennsylvania, had a very large fleet of gondolas, and they went everywhere in the country. After World War II, the Central purchased 4,600 Greenville-design gondola cars of 52-foot, 6-inch interior length, and 6,000 more for subsidiary Pittsburgh & Lake Erie. By 1953 these were

# HobbyOn

Come & See Us  
CLICK Here



[www.hobby-on.com](http://www.hobby-on.com)

**Name Brand  
Hobby  
Products  
at Discount  
Prices!**



6. Before 1920, New York Central acquired 9,500 double-sheathed auto cars. In the 1930s, most of these cars were rebuilt as single-door boxcars with steel sides. This is a representative example of one of the rebuilds (there were over 4,000 such rebuilt cars in service in 1953); it is Sunshine kit 64.1, built by Dennis Williams and lettered and weathered by me.

a visibly dominant part of the NYC System fleet, thus their selection as a signature NYC car. For more about these cars, there is a fine article by Ed Hawkins and John Spencer, in *Railway Prototype Cyclopedia* No. 3 (1999), about all of the Greenville-design 70-ton mill gondolas. Figure 7 shows my model of one.

**Santa Fe.** This large railroad car fleet is like other Western railroads in that it was dominated by boxcars. But an additional feature of interest is that it included refrigerator cars, unlike practically all other roads shown in [1]. Because such cars were not part of other railroads, they were excluded from the Santa Fe data in [1], but if added to [1], would make Santa Fe easily the third-largest car fleet, behind the New York Central.

For all Santa Fe boxcars up to the 1950s, there is no better reference than John C. Dobyne's magisterial book, *Santa Fe Boxcars*



# GETTING REAL | 11

1869–1953 (Santa Fe Railway Historical & Modeling Society, 2001). He covers both the boxcars I selected.

The first boxcar I selected is the distinctive rebuild Santa Fe performed on its Bx-12 and -13 classes, to raise their roof height for service in World War II. During 1929–1931, Santa Fe had purchased 6,500 cars in classes Bx-11, -12 and -13, and early in the war, 4,200 of them had their roofs raised. There is a very good Westerfield kit for the rebuilt car, and mine is shown in [8].

My other Santa Fe boxcar choice is the largest group of all-steel boxcars on the railroad, class Bx-37. They were slightly modified versions of the 1937 AAR standard boxcar. In addition to Dobyne’s coverage, there is also a detailed article about these cars by Patrick C. Wider in *Railway Prototype Cyclopedia* No. 25 (2012). The model is shown in [9].

As I said in opening this section, Santa Fe also had a large contingent of refrigerator cars under its own Santa Fe Refrigerator



7. Among the large New York Central gondola fleet was this design from Greenville Steel Car. There were more than 10,000 steel gondolas like this one in the NYC System fleet by the early 1950s. It is built from a Proto2000 kit, with a load of aluminum pipe.





8. The distinctive Santa Fe raised-roof rebuilds of classes Bx-12 and -13 are true signature cars, being unlike any other railroad's boxcar. This model is from Westerfield kit no. 4751.



9. Santa Fe's biggest class of steel boxcars was Bx-37, 5,010 cars strong. This is an Innovative Model Works kit product, built and weathered by Richard Hendrickson. Note door and end placards, and scraped paint next to the door.



10. A representative of 18,000 refrigerator cars operating under SFRD reporting marks, this model of class RR-32 shows the inward-opening ice hatches standard in SFRD practice until the 1950s (they were later reversed to accommodate icing machines). It was built from an InterMountain kit by Richard Hendrickson.

Department (SFRD), and as there were some 18,000 of the cars in a wide variety of arrangements, it seems incumbent on any serious prototype modeler to have models of one or more of them. The considerable complexity of their construction, rebuilding, and history can be found in an excellent book, *Refrigerator Cars*, subtitled *Ice Bunker Cars 1884–1979*, by C. Keith Jordan, Richard H. Hendrickson, John B. Moore, and A. Dean Hale (Santa Fe Modelers Organization, 1994). with their 5-foot doors and unusual ice hatch arrangements. I was lucky enough to receive a model of one, an RR-32 class car, from Richard Hendrickson, and it is shown in [10]. This class was a group of 500 cars, rebuilt from



11. Southern Pacific's class B-50-14 cars were built in large numbers, but were being scrapped rapidly after 1950. This photo shows a model of one of these cars with a retrofitted Dreadnaught end, a change made for most -14s in the 1930s. It was built from Sunshine resin kit 17.18.

USRA refrigerator cars in 1940, and though a small group, it well represents one of the 18 classes within which Santa Fe classified more than 10,000 USRA rebuilds.

**Southern Pacific.** I turn next to the SP, another Western railroad whose fleet was dominated by boxcars. The primary prototype reference here is Volume 4, "Boxcars," in the series, *Southern Pacific Freight Cars*, which I wrote (Signature Press, revised edition, 2014).

One candidate car type would be the Z-bar-braced, single-sheathed cars of classes B-50-13 and -14, of which over 7,000 were built in the early 1920s. Ted Culotta, in fact, included this car in his "Essential Freight Cars" series, article 6, in *Railroad Model Craftsman*, September 2003. As late as 1950, a lot of these cars still survived in service, but extensive scrapping started soon thereafter. Figure 11 on the previous page shows a model





**12. This Innovative Model Works kit represents SP class B-50-21, which were 2,000 of the 5,244 cars built like this for SP, with the distinctive W-corner-post ends.**

of one of these cars, but as I am indicating, they probably should not be among the primary SP choices, for my own modeling year of 1953.

Among the biggest purchasers of the 1937 AAR standard boxcar was Southern Pacific. They bought 2750 cars of the original design, followed by 5244 cars of the modified design with W-corner-post ends (only 750 of those cars were for the Texas & New Orleans). The latter group, then, is a major part of the SP fleet, representing SP classes B-50-20, -21, and -23, and is illustrated in [12].

There were two big postwar groups of SP boxcars. One group, with 12-panel car sides, totaled 5,600 cars (of which 2350 were for T&NO). These can be modeled with a few upgrades to the InterMountain 12-panel boxcar. But I choose the other group,



## GETTING REAL | 16

3,350 cars of class B-50-27. This is a distinctive group of cars, with diagonal-panel roofs, and some had Superior panel doors [13].

Lastly, SP did have a fairly large number of gondolas, most of them drop-bottom or GS (General Service) types. All are described in Volume 1 of the series, *Southern Pacific Freight Cars*, which covers gondolas and stock cars. The 4250 cars of this type that SP purchased in the 1920s were mostly still in service in the 1950s. I added brake piping and rigging to an Ulrich kit, along with Tahoe Model Works Dalman trucks, to create a model of class G-50-12. The completed model is presented in [14].

**Chicago & North Western.** This large Midwestern railroad had many different groups of its dominant car type, the boxcar, so some discrimination is needed to choose which ones might be signature cars. I have chosen one of the rebuilds done by C&NW



13. SP class B-50-27, modeled with a C&BT Shops kit cut down to 10 feet inside-height, with an added top end rib, upgraded detail parts, and Superior doors.



14. An example of a classic HO kit still useful is this Ulrich gondola, with some detail upgrades to represent a GS gondola of SP class G-50-12.

of its numerous USRA double-sheathed boxcars. A description of these rebuilds is contained in Patrick C. Wider's article, "Rebuilt USRA Double-Sheathed boxcars," in *Railway Prototype Cyclopedia*, No. 24 (2012). A model of one of these is shown in [15], built from a Sunshine resin kit. It represents the replacement of wood superstructure framing and sheathing by addition of steel sides and roof, with increased size evidenced by the inserted smooth panel to increase the height of the corrugated end.

Another choice of boxcars to model for C&NW would be the single-sheathed cars the railroad owned, which were similar to USRA cars but still distinctive. These were described by Ted Culotta in the "Essential Freight Cars" series, article 7, in *Railroad Model Craftsman*, October 2003.

After World War II, C&NW continued to buy new boxcars. Among these all-steel cars bought new by the C&NW, the



15. This model depicts one of C&NW's rebuilt USRA double-sheathed boxcars, with extended height indicated by the smooth added panel in the corrugated end. It was built from the second kit ever produced by Sunshine Models (kit 2.1) by Dennis Williams, and lettered and weathered by me.



16. One of Pullman-Standard's best customers for the all-welded PS-1 boxcar design was C&NW. This model, built from an InterMountain kit, represents those cars.





17. This model represents one of the 5,000 cars built by the Burlington at its Havelock shops during 1940 through 1944, all with W-corner-post ends. It is an InterMountain ready-to-run model.

standout type is the Pullman-Standard PS-1. The North Western was one of the biggest buyers of these cars, which arrived in a substantial number of small orders (some of them riveted rather than welded). Considerable information on these cars is in Edward S. Kaminski's book, *Pullman-Standard Freight Cars, 1900–1960* (Signature Press, 2007). The model I built is from an InterMountain PS-1 kit, and is shown in [16].

**CB&Q.** The Burlington choices are clear from CB&Q rosters. Among the cars built in the immediate pre-war and postwar period, the XM-32 class stands out, eventually totaling more than 16,000 cars, built at the company's Havelock shops in Lincoln, Nebraska. But not all cars in the class were the same, because ends, roofs, and doors varied over time. The large single group of 5,000 cars, built during 1940 to 1944, all had the same ends (W-corner-post), roofs and doors, so they make an obvious choice. My model is from that group, as shown in [17].



## GETTING REAL | 20

There was a special issue of the Burlington Society magazine, *Burlington Bulletin No. 7*, entirely devoted to the XM-32 cars. Written by Hol Wagner, it covers 25 pages and would be hard to beat as a source of complete freight car information.

For more than 25 years, nearly all new Burlington boxcars were single-sheathed. The most numerous group was the 1922 class, XM-25 (and the twins of XM-26), so these are my choice as a second signature car for the Burlington.

These 3,000 cars were described by Ted Culotta in his “Essential Freight Cars” series in *Railroad Model Craftsman*, article no. 10, in February 2004. There were 2,000 cars built in 1922 for class XM-25, and 1,000 more built in 1926 as class XM-26. I built one of the Speedwitch Media kits for the XM-25 boxcar.



18. The largest class of single-sheathed boxcars, among many such boxcars on the Burlington, was class XM-25 and its near-twin, XM-26. This model was built from Speedwitch Media kit K106.1, equipped with Andrews trucks (the original XM-25 trucks) from Accurail, and lettered with the Speedwitch kit decals.



19. Easily the stand-out group of PFE refrigerator cars in the transition era was class R-30-9 (among which were a few cars with 40-ton underframes, designated as class R-40-9). Red Caboose makes an excellent model of this wood-sheathed rebuilt class, which totaled more than 7,700 cars. The model shown here has its ice hatches latched open in ventilator service. The car represents one of the late rebuilds (PFE 95737–98718) which received pressed-steel ice hatch covers, and is shown in the 1950 paint scheme.

**PFE.** Pacific Fruit Express, though of course not a railroad, was the owner of an immense fleet of refrigerator cars, the largest in the world. Information about the PFE fleet was contained in a previous “Getting Real” column, in October 2013 (it’s at: [mrh-mag.com/magazine/mrh-2013-10-oct](http://mrh-mag.com/magazine/mrh-2013-10-oct)), so I will only highlight here the most important cars you might choose. There is extensive background available, much of it contained in the detailed book, *Pacific Fruit Express* (2nd edition), by A.W. Thompson, R.J. Church and B.H. Jones, Signature Press, 2000).

The largest single group of cars on the PFE roster in the

## GETTING REAL | 22

transition era was rebuilt class R-30-9, more than 7,700 cars. If a modeler were to have only one PFE car, this would be the one to have. There is an accurate Red Caboose model of this class, available intermittently as a ready-to-run car, and an example is shown in [19].

To choose a second PFE car, the largest group of steel reefers was the 5,000-car R-40-23 class, available as a superb kit and in ready-to-run form from InterMountain. I illustrate this model in [20].

This class is also the prototype of the old Athearn steel ice reefer, and though that model has its shortcomings, it can be upgraded to serve as a representative of this class also. My model in [21] was built with open ice hatches, suitable for placement at an ice deck, though not for use in moving trains.



20. The InterMountain model of PFE class R-40-23 is excellent in all respects. This one was built from a kit, with open ice hatches to represent a car in ventilation service. Having a representative of this 5,000-car class is essential as a PFE signature car.



21. The prototype of the old Athearn steel ice reefer is PFE class R-40-23. As it comes from the box this is not a model with details and accuracy that are up to today's freight car standards, but the car can be upgraded to better represent the prototype. This car was modeled with open ice hatches to be photographed at an ice deck like this one.

**Southern.** The Southern was the largest railroad in the South, and rostered a very wide variety of cars. But boxcars were dominant, as for most railroads. Here the best reference is George Eichelberger's book, *Southern Railway Equipment Drawings and Photographs*, Volume 1, Book 1, 40-ft. boxcars (Southern Railway Historical Association, 2004). Its very complete contents enable choice of two major car types.

In the mid-1930s, the Southern was saddled with an aging and substantially obsolete fleet of 36-foot box cars. In response, then, from 1937 to 1940 the Southern purchased 8,500 new steel boxcars, following the 1937 AAR standard boxcar design, though all were of 40-ton capacity. [22] shows one of these cars, in the form of an Innovative Model Works kit.

In 1946 and 1947, Southern again purchased some groups of



40-foot cars. Among them were 1,000 cars with 8-foot doors, an unusual size at the time, and Improved Dreadnaught ends. Speedwitch Media had a conversion kit, KC111.1, to build one of these cars with a Branchline body. There also was a C&BT Shops kit with an 8-foot door; that kit was built and upgraded, as shown in [23].

**Union Pacific.** One of the busiest bridge roads in the U.S., Union Pacific also owned a considerable freight car fleet of its own. The cars are ably summarized by Terry Metcalfe, in his pioneering book *Union Pacific Freight Cars, 1936–1951* (Metcalfe Publications, 1989). This book, in fact, inspired the creation of several of the books cited earlier in this column.

Like many railroads, UP added new boxcars to its fleet as soon as the 1937 AAR standard boxcar design was available. There were two big classes purchased during 1936 to 1938, B-50-19

## ADVERTISEMENT

**George's Trains**  
EST. 1962  
Canada's Greatest Model Train Store!  
www.georgetrains.com 1-877-8TRAINS

**Exclusive VIA Rail P42 #920 In solid Blue**

**P42 \$179.98** each  
Reg. \$199.98 each.

**Combo Deal!**  
Buy a Rapido F40PH-2D with Sound and a Athearn P42 and receive a 15% discount on a LOK Sound Decoder for the P42! (Not Installed)

**RAPIDO F40PH-2D** \$349.98 DCC/Sound  
\$249.98 DC

**HO Scale**

**Buy it NOW!**

MRHMAG.COM

## ADVERTISEMENT

**GLX**

**TOP QUALITY PRODUCTS**  
FOR THE MODEL RAILROAD CRAFTSMAN

**WWW.GLXSCALEMODELS.COM**

**RESIN CASTINGS**  
**SCENERY DETAILS**

- TABLE OF CONTENTS
- INDEX



22. This model, built from an Innovative Model Works (IMWX) kit, represents one of the Pullman-Standard-built cars among the 8,500 cars purchased by Southern before World War II, all with only 40 tons capacity. It carries the pre-war Southern emblem.



23. After World War II, Southern was among the pioneers of the 8-foot door on boxcars, as represented in this model. It was built from a C&BT Shops kit with upgraded details, and is lettered (top right corner) for one of Southern's subsidiaries, the New Orleans & Northeastern (NO&NE). It also has the 1945 emblem.

and B-50-21, containing a total of 3088 cars. All had “original” or sharp-cornered Dreadnaught ends. Red Caboose has a fine kit (also available as ready-to-run) for this car, and mine is shown in [24].

But the truly distinctive part of the UP boxcar fleet, with far more cars of this type than any other road, was its cars with Alternate Center Rivet (ACR) construction. The idea behind this construction method was to use thinner steel for side sheets, thus saving weight; but thinner sheets were also less stiff, and one solution was to add an additional side post in the center of each side sheet panel, and attach it with double-spaced rivets (compared to those along panel seams).



24. Between 1936 and 1938 Union Pacific bought two big classes of cars that followed the 1937 AAR standard design. This is one of them, repainted into the sans-serif or “Gothic” lettering scheme adopted in June 1939. The model is a Red Caboose kit.





25. This builder photo of UP 187085, class B-50-24, was taken in July 1939 and shows the ACR rivet pattern. (photo from Terry Metcalfe collection, courtesy Richard Hendrickson)

The prototype photo in [25] shows the ACR appearance clearly. Between 1938 and 1953, UP bought more than 14,000 boxcars with ACR construction. As time went on, ends and then roofs changed, but the distinctive side panels are a signature appearance essential to modeling UP boxcars.

In addition to a detailed ACR description and photo coverage in the Metcalfe book cited above, Ted Culotta discussed many of the ACR car classes in a ten-page article in his “Essential Freight Cars” series, article 44, in *Railroad Model Craftsman*, February 2009.

There have not been many HO scale models made to accurately represent this rivet pattern. Trix made a ready-to-run car like this (though its underframe would require considerable modification to operate on an American model railroad). Speedwitch Media made a resin underframe to substitute in the Trix model, and there was a Sunshine kit for an ACR UP class B-50-32. Speedwitch also made a kit for the UP class B-50-38.

One could also convert an otherwise-correct car body from any of several sources. The way to do that would be to use an Archer



## GETTING REAL | 28

Transfers set of decal rivets, specifically researched for use as ACR rivet rows. It is set AR88030.

The simplest approach, used for the model in [26], was to substitute an Innovative Model Works underframe for the underframe in the Trix model of a class B-50-24 ACR car. My model specifically represents that 1,900-car class, but with modifications could represent other classes among some 12,700 boxcars of UP classes B-50-23 to B-50-33 and also B-50-41. In 1947, UP changed its boxcar paint scheme to an all-yellow version of the previous scheme, so the model in [26] represents a repaint some years after construction.



26. This model represents the thousands of Alternate Center Rivet (ACR) construction boxcars owned by Union Pacific, shown as repainted after 1947 into the all-yellow lettering scheme. The model comprises a Trix B-50-24 body with an Innovative Model Works underframe and floor.



27. Here is my single signature car for the Western Pacific. For many years the most numerous cars on the WP, the 16001–18300 series of double-sheathed boxcars had steel underframes; the first 800 cars were built in 1917, the balance in 1918. The WP applied steel ends in the 1930s and thereafter. The model was built from Sunshine kit 59.3 by Dennis Williams and lettered and weathered by me.

**Western Pacific.** The Western Pacific was a small road, far smaller than any of those in the preceding material, and I only include it here, as I did in the first column on this topic, to illustrate that the same kind of “signature car” approach can be used with smaller roads also, though I have only chosen one such car in this instance.

WP had several groups of boxcars, but one car group stands out as a signature design, WP 16001–18300, cars which were built by Mt. Vernon Car Company, in 1917–1918. These double-sheathed boxcars later received steel ends, and these survived in service well into the 1950s. My model, built from a Sunshine kit, is shown in [27].

## Concluding comments

An important goal of mine in assembling the material of this column, as with its predecessor on signature freight cars, was to illustrate a method of choosing freight cars from railroads other than your personal favorite. This approach can be used if you are evaluating additions to your freight car fleet with cars from the major railroads, or equally well if you are refining the content of your fleet to better reflect realistic fleet proportions.

Use of resources such as books and magazines, especially the *Railway Prototype Cyclopaedia* issues and the Ted Culotta series, “Essential Freight Cars,” provides both information and helpful photos. For the actual data, there is no substitute for the ORER. Both can be essential in making the kinds of choices I have described.

I should also mention that I have omitted Canadian railroads CN and CP from [1] and from this discussion, even though they had fleets which would rank them numbers 3 and 4 in [1]. Why? Because most data indicate that 10% or less of Canadian freight cars moved to and from the United States, so realistically the huge CN and CP fleet numbers have to be divided by 10 to show their U.S. interchange impact, dropping them out of [1].

Beyond that, I have also made assumptions and simplifications which suit my modeling, but which may not suit yours.

ADVERTISEMENT



**Archer**  
FINE TRANSFERS  
PROUDLY SERVING MODEL BUILDERS SINCE 1969

THE ORIGINAL  
**SURFACE DETAILS™**

WE NOW HAVE MORE THAN 100 SHEETS OF RIVETS, LOUVERS, TREADPLATE AND MORE CAST ONTO MICROSCALE CLEAR DECAL FILM

**FREE SHIPPING:**

- DOMESTIC USA ORDERS \$50 OR MORE
- INTERNATIONAL ORDERS \$100 OR MORE

CLICK HERE TO VISIT OUR WEBSITE!

MADE IN THE USA

Archer Fine Transfers • PO Box 1277 • Youngsville, NC 27596 • USA  
(919) 570-1026 • info@archertransfers.com • archertransfers.com

*“Archer rivets are easy to apply and look great. To me, they are now a vital tool in building railroad models.”*  
Tony Thompson, Model Railroad Author/Historian

For example, as a Western modeler, I removed coal, ore and ballast cars from [1]. Modelers in other regions likely will wish to reverse that removal in thinking about these issues. Knowing the railroad you model, as well as its region and its traffic, are vital to these decisions. However, I hope the ideas of how to identify, extract and use the various pieces of information which can go into a model freight car fleet will be useful.

## Summing up

Choosing whether to have signature freight cars in your model fleet is obviously a personal decision. I advocate it because these are interesting cars in their own right, and help represent the style of their owning railroads. I have deliberately mixed models made from resin kits, from styrene kits and ready-to-run cars, and brass models. All have their place, in my opinion.

### ADVERTISEMENT

## TRINITY 3281



CMO - 12 road numbers \$48.95 each



CSX - 12 road numbers \$48.95 each



TILX - 6 road numbers \$48.95 each



WSOX - 6 road numbers \$48.95 each plus CRDX and MCEX



www.americanlimitedmodels.com

But as I have discussed previously, the further choice is whether you wish to make sure you have representative cars from the largest railroads, as [1] suggests. This has been demonstrated to be a realistic and prototypical approach for many model railroading situations, but does remain a personal choice.



[Click here for reader comments](#)



**Coming this month:**

A layout so *big* we could barely fit it into the March edition of TrainMasters TV!



The March show on  
**TRAINMASTERS.TV**

Brought to  
you by



Yes I want to see this: 99 cents for 1st month!





# WHAT'S NEAT

column

KEN PATTERSON  
.....



[Click here for  
reader comments](#)

## A PHOTO SHOOT WITH CHRIS PALOMAREZ OF ATHEARN ...

**IN THIS MONTH'S VIDEO I WAS CAREFUL TO** match the moving pictures to the still text here in the magazine. The video features live steam In 1:20.3 large scale, an interview and a photo shoot with Chris Palomarez of Athearn.

Mike Budde stops by with an incredible set of auto racks loaded with station wagons he made from a Mini Metals Impala.

We cover three photo shoots this month: a daytime shoot featuring the new Athearn autoracks, then we are live for two sunrise shoots featuring a BLMA bridge in the first and Athearn and Mike's auto racks in the second with the morning sun licking every fine detail.

And that is this month's "What's Neat" video for March 2015.

▶ PHOTOS AND VIDEO OF SUPERB MODELS

## WHAT'S NEAT | 2



1. We start with Chris Palomarez, who came by with some beautiful models. I spent 11 hours with him, shooting Southern Pacific tunnel motors and a mix of professionally weathered freight cars created from prototype photos.

103,000 have seen this MRH video - *have you?*

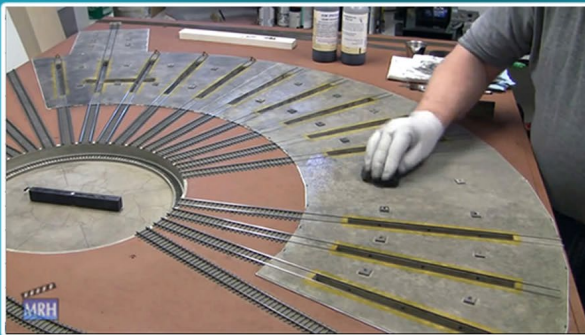

Watch the  
video now





## WHAT'S NEAT | 3



Playback problems? [Click here ...](#)

ADVERTISEMENT



# Rusty Stumps

Scale Models

WE ONLY SELL WHAT WE MANUFACTURE

**DETAILS** IN HO, O, S & N SCALES  
LASER CUT SHINGLES, DOORS & WINDOWS,  
FENCES, SIDING, CRATES. Also RESIN and  
WHITE METAL DETAILING CASTINGS.

**CRAFTSMAN KITS**  
IN HO, O & S SCALES

CHECK IT ALL OUT AT  
**WWW.RUSTYSTUMPS.COM**

Send \$3.50 for Catalog - Specify Scale  
**RUSTY STUMPS SCALE MODELS**  
6785 Cherry Blossom W. Dr., Fishers IN 46038  
Phone (317) 595-9489

[MRHMAG.COM](http://MRHMAG.COM)

- [TABLE OF CONTENTS](#)
- [INDEX](#)



# WHAT'S NEAT | 4



2. This CSX car is an ex-New Hope and Ivyland boxcar Chris painted with an airbrush, spraying jade green and olive, masking here and there. He then painted clear decal paper to make the patches as per a prototype photo.

Over 31,000 have seen this MRH video - *have you?*



**Watch the  
video now**





3. To create the effect on this Southern Pacific refrigerator car, Chris mixed chalk with acrylic paint to make a textured rust paint mix. He blotted the car with this mix to make the rust spot marks. He followed up with a wash of streaky orange-brown and used a pencil for the graffiti as per the prototype photo.



[Click here for reader comments](#)



4. We shot this SP GP40 rebuild on my Kimswick diorama, with a sky of clouds that made the shot. Chris painted and decaled the model after tricking it out with detail parts. The end result makes a fantastic shot, one of my favorites so far this year.



**DID YOU KNOW  
MRH SUBSCRIBERS  
GET FREE  
BONUSES?**

**CLICK TO SUBSCRIBE NOW - IT'S FREE!**





5. Southern Pacific tunnel motors weathered , detailed and painted by Chris Palomarez are the main prop in this yard shot. The use of Helicon Focus and stacking 11 photos together, focusing through the shot, gives us total depth of field that makes the model photo realistic.

37,000 have read this MRH forum thread - have you?

[Home](#) / [Forums](#) / [Track and electrical/DCC](#) / [What DCC system do you use - and why?](#)

## What DCC system do you use - and why?

Mon, 2010-08-02 11:03 — [joef](#) [Track and electrical/DCC](#) [DCC - Electrical](#)

I'm curious what DCC system various modelers on here are using, and why? I think it's useful - so post a bit about the system you use and how you came to choose it. Also if you have any learnings, that's always helpful!

**Read  
now**







6. Chris's models take a long run in the open plains. A few railfans pace the four-unit power set. The Southern Pacific model locomotives were all painted, decaled, and weathered by Chris.

Get the Latest Model Railroading News, Tips, Reviews & Opinions

# The SCOTTY MASON SHOW

S H O W  
*The Original Model Railroad Podcast*

**-Monthly Interviews**

- Modeler's Spotlight: Top Modeler's Talk
- Narrow Gauge Modeling w/Chris Lane
- Contemporary Modeling w/ Mike Rose

**-More Product Announcements & Reviews**

 Our feed has changed! To get the latest shows Please search Scotty Mason and subscribe to the new feed!

[www.TheModelRailroadPodcast.com](http://www.TheModelRailroadPodcast.com)

Scott Mason Jimmy Simmons Mike Rose Joe Duckworth



7. Mike Budde came by with some beautiful autoracks loaded with Chevrolet station wagons made from Mini Metals HO scale Impala four-door sedans. He cut off the back window and trunk, and formed the shape of the station wagon's body-work with styrene. After completing the first model he made a mold and cast enough cars to fill two autoracks. The windows are clear tape, complete with dealer price stickers in the glass.

**When talking to hobby vendors, please remember to mention MRH.**







8-10. These three photos are the results of a sunrise shoot. Shooting exposures of one second netted these beautiful photos. In the video, you are there for the shoot. Mike's station wagons add to the scene with the sun reflecting off the glass. Morning photos give a dramatic light that makes the models' details pop.



[Click here for reader comments](#)



# WHAT'S NEAT | 12



# WHAT'S NEAT | 13



11-13. These three photos were made during a daytime photo shoot with Athearn's new autoracks. The detail on this "plastic brass" is exquisite. They are so nice I don't think I would put loads in them. I look forward to the tri-levels that may be available this summer or so.



[Click here for reader comments](#)



*Have you seen this?*

**CHECK IT  
OUT!**



**kenpatterson.com**

*click here to ...*

**Visit Ken's website**

**Ken Patterson  
reveals his modeling  
secrets on video!**





# HOBBY MARKETPLACE



**NEW N.A.R. STK CAR KIT!**



**RESIN KITS, DECALS,  
DATA DISKS & DETAIL  
PARTS AVAILABLE.**

[westerfieldmodels.com](http://westerfieldmodels.com)

**CLEVER** models LLC  
**Cardstock models & Building materials**

**CLICK HERE**

[www.clevermodels.net](http://www.clevermodels.net)

**SmartSwitch**™ **ANE model**  
[www.ane-model.com](http://www.ane-model.com)

**Route Control device  
for SmartSwitch**

*Which track is correct line?  
We can solve your confusion.*

**East Penn Traction Club  
22nd National Trolley Meet  
Pennsylvania Convention Center  
Hall G, Broad And Race Sts  
Philadelphia, PA  
May 15-16, 2015  
Layout visits May 17**

**Clinics, layouts in all scales,  
model contests, vendors, films,  
photos.**

[www.eastpenn.org](http://www.eastpenn.org)

**P R E C I S I O N   D E S I G N   C O**

**Chains  
Flat Car loads  
Joint Bars  
Signs**

**FREE SHIPPING**

MRH *allowed* this video to be posted?



Watch the video now 

## Backdrop Junction

Your stop for  
Model Railroad Backdrops



 *click here to visit our website*  
**backdropjunction.com**  
N, HO, O Scales • Custom Orders



MODEL RAILROAD  
STRUCTURE KITS  
AND ACCESSORIES



[WWW.MONROEMODELS.US](http://WWW.MONROEMODELS.US)

Minimalist Model Railroad Design



All New 2nd Edition!

[Click Here](#)



## True Scene Modeling™



### FusionFiber™

Scenery Base Material for the 21st Century!

**SATISFACTION GUARANTEED!**

[www.truescene.com](http://www.truescene.com) or 716-523-7305



[www.modelrailroadtunnels.com](http://www.modelrailroadtunnels.com)

**MODEL RAILROAD  
TUNNELS**

## Great Decals!™

FEC, Interstate, Virginian  
Railway, & L&N Titles  
After Hours Graphics Line  
Coupler Gages and More  
In O, S, HO, and N Scales 



On Sale This Month...

## SuperTrunks!

Made from real cedar. 11-inch "Old-Growth" trunks for making trees in HO, N, S, & O.

Get 'em at:

**Coastmans**  
Scenic Products

**CLICK AD**

### STREAMLINED BACKSHOP

Sales  
... Services  
..... Solutions

### "SUGAR CUBE" SPEAKERS...

4 Sizes \* 4 Baffles

... "Sweet" Speaker Options!

## What's Inside Your Windows?

[www.davesmrs.com](http://www.davesmrs.com)

[Click Here](#)

## Model Railroad BenchWork.com

Affordable Modular (domino) Benchwork in 200+ sizes  
Custom built to order benchwork also available!

**NEW!** Fusee Pro

Realistic looking and operating railroad flares! See the video!

**LOGIC RAIL™ TECHNOLOGIES**

"Sophisticated Model Railroad Electronics"

Please visit our website and online store!

21175 Tomball Pkwy Suite 287 Houston, TX 77070

Phone: (281)251-5813  
<http://www.logicrailtech.com>  
info@logicrailtech.com

## Mr. Detail Parts

New Parts Added Weekly!

[Click Here](#)

[www.mrdetailparts.com](http://www.mrdetailparts.com)



Have you seen these popular blogs on the MRH website?

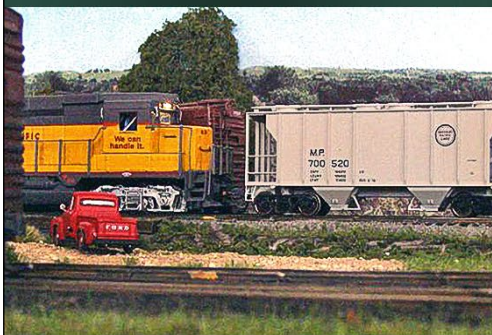

**Ken Glover's Shelf Layout**

57,000 reads

[CLICK TO READ IT NOW](#)



**Mike Rose's N scale empire**

87,000 reads

[CLICK TO READ IT NOW](#)



**Yarmouth Model Works**

HO scale resin kits and detail parts

U.S.A. MAILING ADDRESS  
3560 Pine Grove Ave. Unit 617  
Port Huron, MI 48060  
Tel. 519-633-7574  
pierre.oliver@start.ca  
www.yarmouthmodelworks.com

CANADIAN MAILING ADDRESS  
85 Hiawatha St.  
St. Thomas, ON N5P 2T5



[CLICK HERE](#)



Can't remember which cars you've bought?

**Yard Boss**

**Model Train Inventory Software**

from DCC by Design

Under \$15

**Download free trial now**

[www.dccbydesign.com](http://www.dccbydesign.com)

**Hobby Marketplace  
Ads are  
Economical and  
Effective.**

[Click to learn more ...](#)

# HOBBY MARKETPLACE | 5



**BenchWork**  
Affordable built to order Benchwork starting at only \$20 a Sq Ft.



P.O. Box 6 Paonia, CO 81428  
Ph. 970 527 4586  
Made in The USA

Cast resin items for your O & On layout. Tunnel portals, bridge piers, abutments, culverts, and retaining walls. Trackside details and sage brush tree armatures.



**DEEPWOODS SOFTWARE**  
C, C++, LISP CONSULTING / PROGRAMMING

Click Here

Run your model railroad!



**LIGHTS 4 MODELS**

LED LIGHTS | NEON SIGNS

NEW PRODUCTS ADDED MONTHLY



**WELDING!**

- 3 Super Bright LEDs
- Resistor
- Connector Wires

Assembly Input Voltage: 9-18 Volts  
Lasts 100,000 hours!

Learn more about our Simulated Welding LED

Almost NO Heat Generation  
Only Draw 20 millamps



AMERICA'S NUMBER ONE RAILROAD PRINT SOURCE

**Jelsma Graphics**

...America's Railroad Embroiderer

Railroad Art-Prints, Caps, Jackets, Shirts and More ...  
Jackets starting at \$79.95

[www.jelsma.com](http://www.jelsma.com)  
1-904-221-3513 • Jacksonville, FL.

**Nashua Valley Railroad Assoc. RAILFAIR 2015**

Train Show and Open House  
Sunday March 29<sup>th</sup> 2015 (10-4)  
Ayer/Shirley Middle School  
1 Hospital Rd., Shirley MA

**RULERS-of-the-WORLD**

Scale Rulers \$4 each  
Over 200+ scales!  
Metric or Imperial  
[www.rulers-of-the-world.com](http://www.rulers-of-the-world.com)

**MOUNTAIN SUBDIVISION HOBBIES**

[www.modelrrsupply.com](http://www.modelrrsupply.com)

FREE USA SHIPPING OVER \$29.00

NCE - SOUNDTRAXX - DIGITRAX - PECO - CIRCUITRON  
DCC SPECIALTIES - INTERMOUNTAIN - CMX - ATLAS  
BAR MILLS - BOWSER - KATO - MRC - TOMAR - RIX - PIKESTUFF - LOGICRAIL - CENTRAL VALLEY AND MORE!

When talking to hobby vendors, please remember to mention MRH.



# WALLY BRADY'S

*Canadian National Railroad*

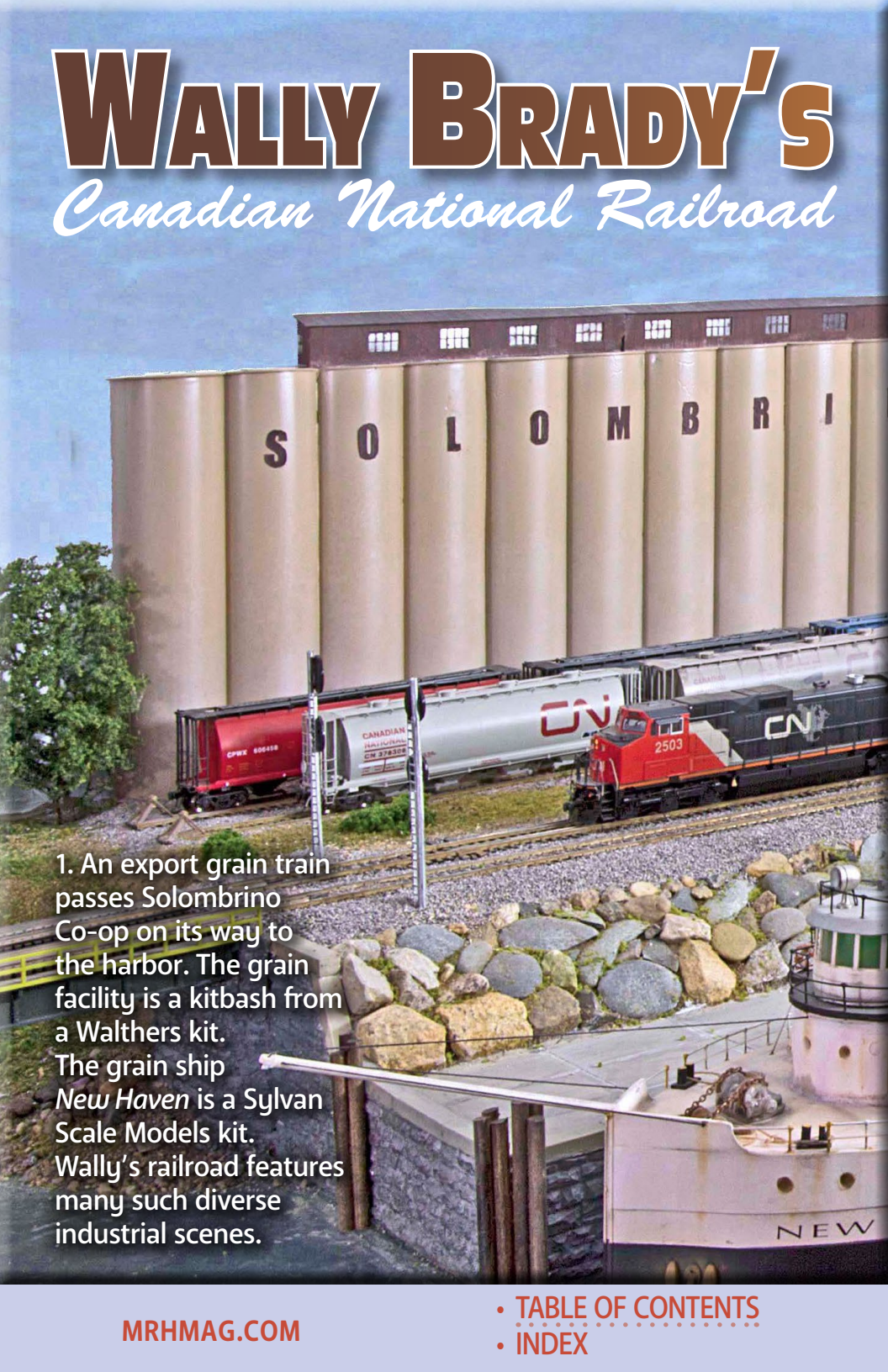

1. An export grain train passes Solombrino Co-op on its way to the harbor. The grain facility is a kitbash from a Walthers kit. The grain ship *New Haven* is a Sylvan Scale Models kit. Wally's railroad features many such diverse industrial scenes.





BY **MIKE TYLICK**  
.....  
Photos by Doug Scott



[Click here for  
reader comments](#)

## *Photo tour of a fabulous contemporary CN layout ...*

**WALLY BRADY IS A THIRD-GENERATION RAIL-**roader – his grandfather and father worked for the Boston and Albany. Among numerous other occupations, Wally started his railroad career as a driver for the (Boston) Metropolitan Transit Authority, eventually becoming an inspector. Like many of us, he was introduced to the hobby with childhood electric trains which became the basis of a lifelong hobby. But not wanting to purchase the same models everyone else had, Wally eventually gravitated to the Canadian National as his railroad. The Plymouth Subdivision is his third and largest layout.

Wally moved to Boston's South Shore to better serve the customers of Brady's Hauling, a trucking company which ferries animals for the numerous local area horse farms. After finishing the basement train room, he began working on the layout, bringing the entire layout to the stage of completion seen in these photos.

It was serendipity that brought us to together and to enjoy his fine model railroad. I first learned about Wally when his layout was showcased in the Southeastern New England (Model Railroad) Tour #1. I was unable to attend that year, but tour director Ray Schofield was kind enough to give me his address.



# CANADIAN NATIONAL | 4

A few weeks later I called Wally and quickly found a new friend near my home. What follows is a photo tour of Wally's impressive Canadian National HO layout. Enjoy! ✓ *-Mike Tylick*



2. An eye-level view of the same scene as the lead photo above [1].





3. A run-through with BNSF 4929 leads the train in this photo. Since the foreign road unit is at the point, we can assume this stretch of track does not have cab signals. Wally's locomotive fleet is custom-detailed and weathered.



4. A little later, another through train with UP 5961 in the lead rumbles past.

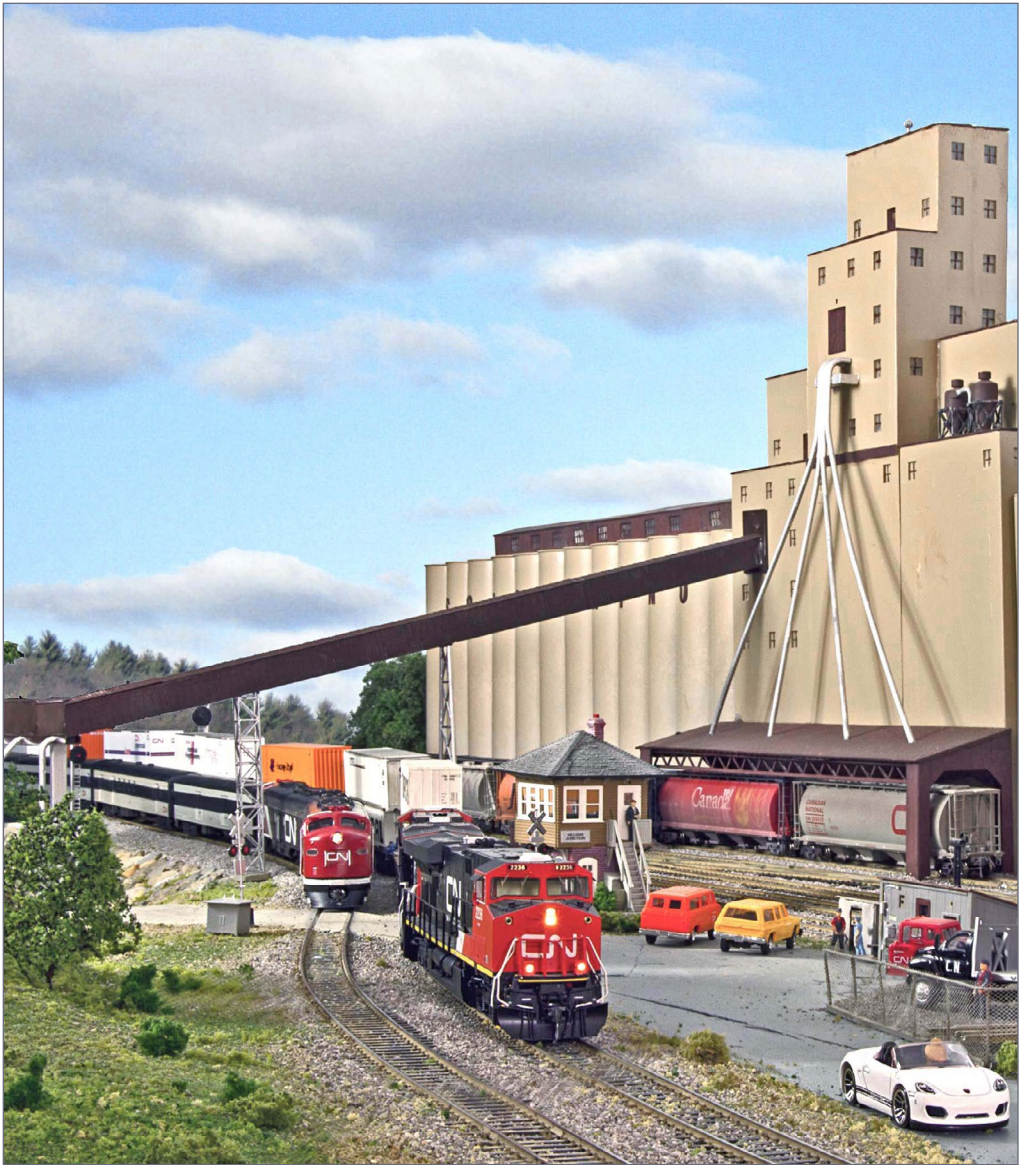

5. The business train waits on the siding just north of Solombrino's as a CN stack train passes. It is good business to show the shippers aboard the train the excellent service their goods are receiving. Wally uses Shinohara Code 83 flex track on the layout.





6. A Chesapeake double-stack departs Hampton News, Virginia on the first leg of its trip to the Pacific. The Chesapeake Railroad is operated by the North Shore Model Railroad Club in Wakefield, Massachusetts. Wally is a long-time club member.

**Want to help keep  
MRH free?  
Then *click* on ads!**





7. More of Wally's collection heads west from Murray Yard in Kansas City. Wally's design and scenery reflect his imaginative approach to the hobby. It is quite possible to change the locale merely by substituting the railroad equipment.



[Click here for reader comments](#)



8. The CN business train approaches the Cabot Bay lift bridge. Engines 102 and 103 sport custom schemes painted by Wally. The lift bridge is an HO kit from CMR (Custom Model Railroads) which has been modified by Wally. Gusset plates were added for detail and strength. The bridge is non operating.

9, 10 (next spread). More views of the CN Business train rolling across the Cabot Bay lift bridge.













11. The local switches Barrow's Barrel in Plymouth as UP 5961 heads a through train. The engine is an SW1200 RSm. This unusual locomotive was built by combining a wrecked GP-9 with an SW cab. It is a one-of-a-kind engine that was kitbashed by Wally. The model may also be the only one in existence. UP run-through power rolls by in the rear.





12. A more common SW900 switches the Steff and Izzy complex. A track car finds the S&I a convenient place to pull off the main so revenue trains can precede. Steph and Izzy is named after Wally's granddaughters. Peco turnouts and switch machines, operated by fascia pushbuttons, are used throughout the layout.



[Click here for reader comments](#)



13. Another BNSF stack train enters the tunnel to the hidden staging, our version of the Continental Divide.





14. A CN stack leaves Mount Royal Tunnel (and hidden staging) near Montreal. Steff and Izzy's is on the far right.



[Click here for  
reader comments](#)





15. A BN SD70 departs the tunnel.





16. A CN transcontinental double-stack passes by the Plymouth Farm Union. Wally makes extensive use of structures derived from readily available kits.



[Click here for  
reader comments](#)

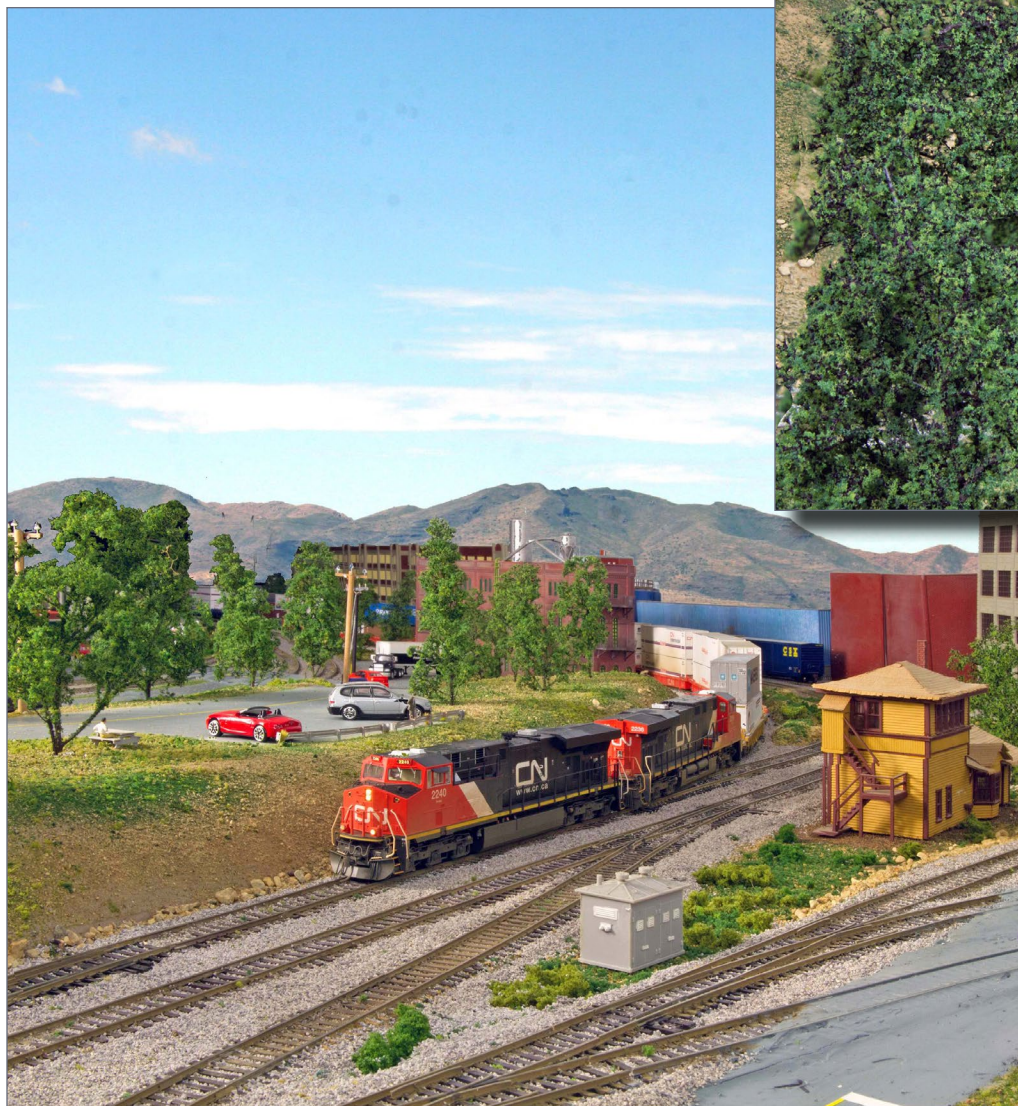

17. Our train rounds the curve past Plymouth Tower as it departs the yard. Much of Wally's equipment has been "tricked-out" with added detail, but the newest locomotives are so well detailed that only weathering is necessary.





18. A stack train with UP run-through power passes one of our favorite photo locations. Scenery is plaster cloth laid over foam insulation. Super Trees and ground foam are used throughout the layout.

**When talking  
to hobby  
vendors, please  
remember to  
mention MRH.**

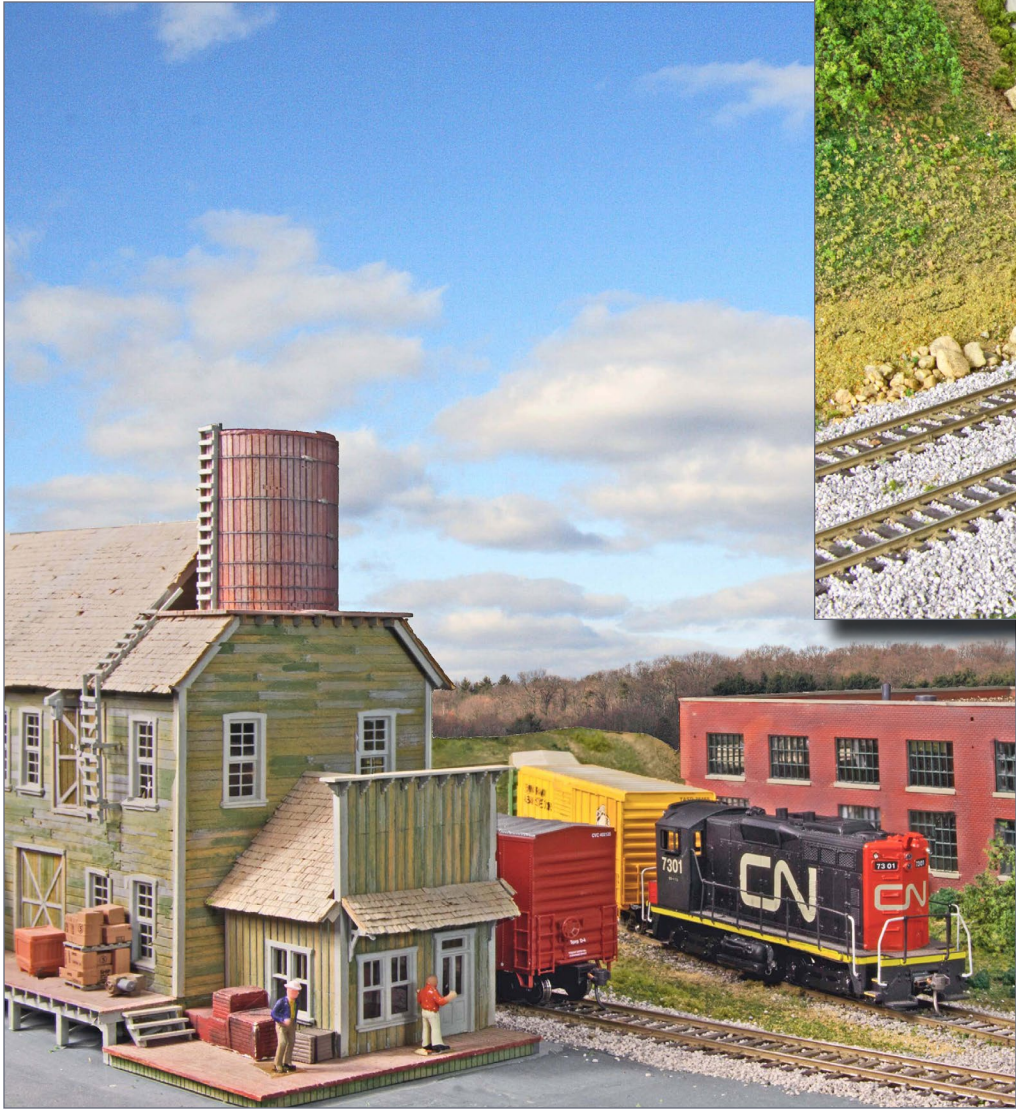

19. CN local 7301 switches the Brewery, a scratchbuilt structure Wally purchased at a train show. Wally built this unusual locomotive. It is an RM412A rebuilt from an SW 1200 at the CN St. Charles Shops.



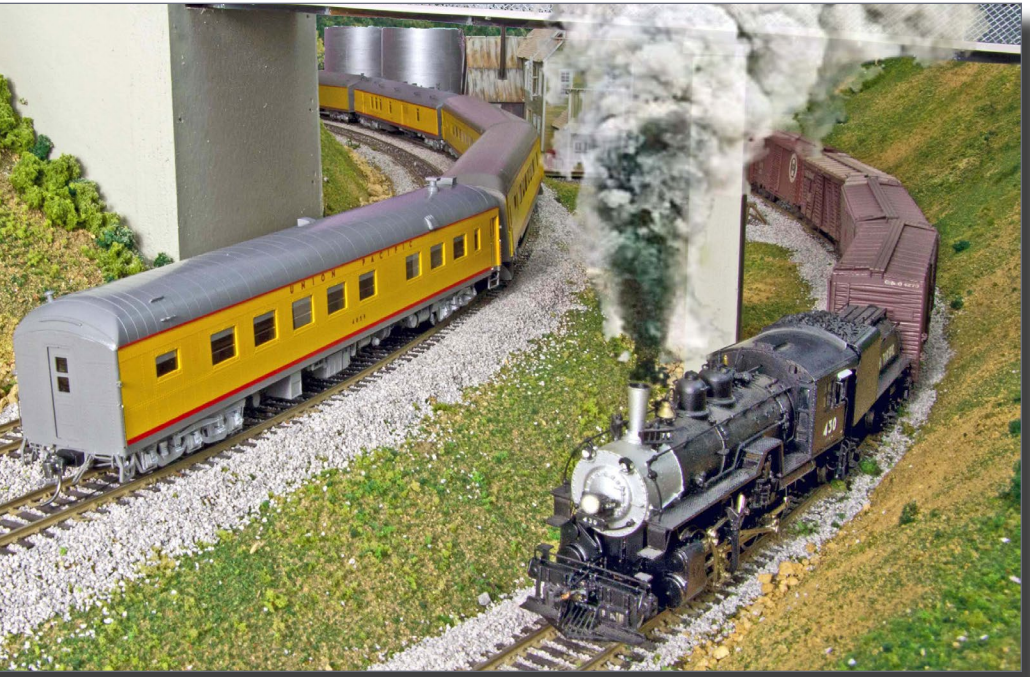

20. A favorite aspect of Wally's railroad is that visiting locomotives and cars are welcome and look correct. Steve Solombrino has supplied caption information for these using equipment from his extensive collection. Union Pacific train #40, *The Kansan*, passes a local freight in near Lawrence on the last leg of its journey to Kansas City. A little Photoshop magic supplied the smoke.





21. This unusual photograph was taken when the then brand-new UP gas-turbine was testing in the Blue Mountains of Oregon. After several months of trials with the 50, the UP ordered their famous fleet of gas turbines. Wally's broad main-line curves have a minimum radius of 40" or more.



22, 23. A UP freight headed by #321 and two GP9Bs passes along the Portland, OR waterfront with a train of export grain for Asian markets. The B units were kitbashed using Life Like GP9s.













25. A Chicago-bound merchandise freight is passed by the morning Zephyr as it departs St. Paul, MN. It should have a fast run following the express.



[Click here for reader comments](#)





26. UP train #67 heads west for Tekoa, WA on its daily (except Sunday) trip from Wallace, ID. In addition to providing local passenger service along the Wallace Branch, the 40' postal car carried valuable ore to the smelter.





27. A local freight performs its chores near Omaha as an eastbound extra freight passes on the main line on its trip to Council Bluffs, IA.



[Click here for  
reader comments](#)



28. We've quickly changed our setting from the West coast to the East. B&M (Boston & Maine) SW1 #1121 switching cars near Lawrence, Massachusetts. The faded paint was done by Bob Foley.









29, 30. CN 2253 passes Brady Excavation, Wally's main place of business.



[Click here for  
reader comments](#)

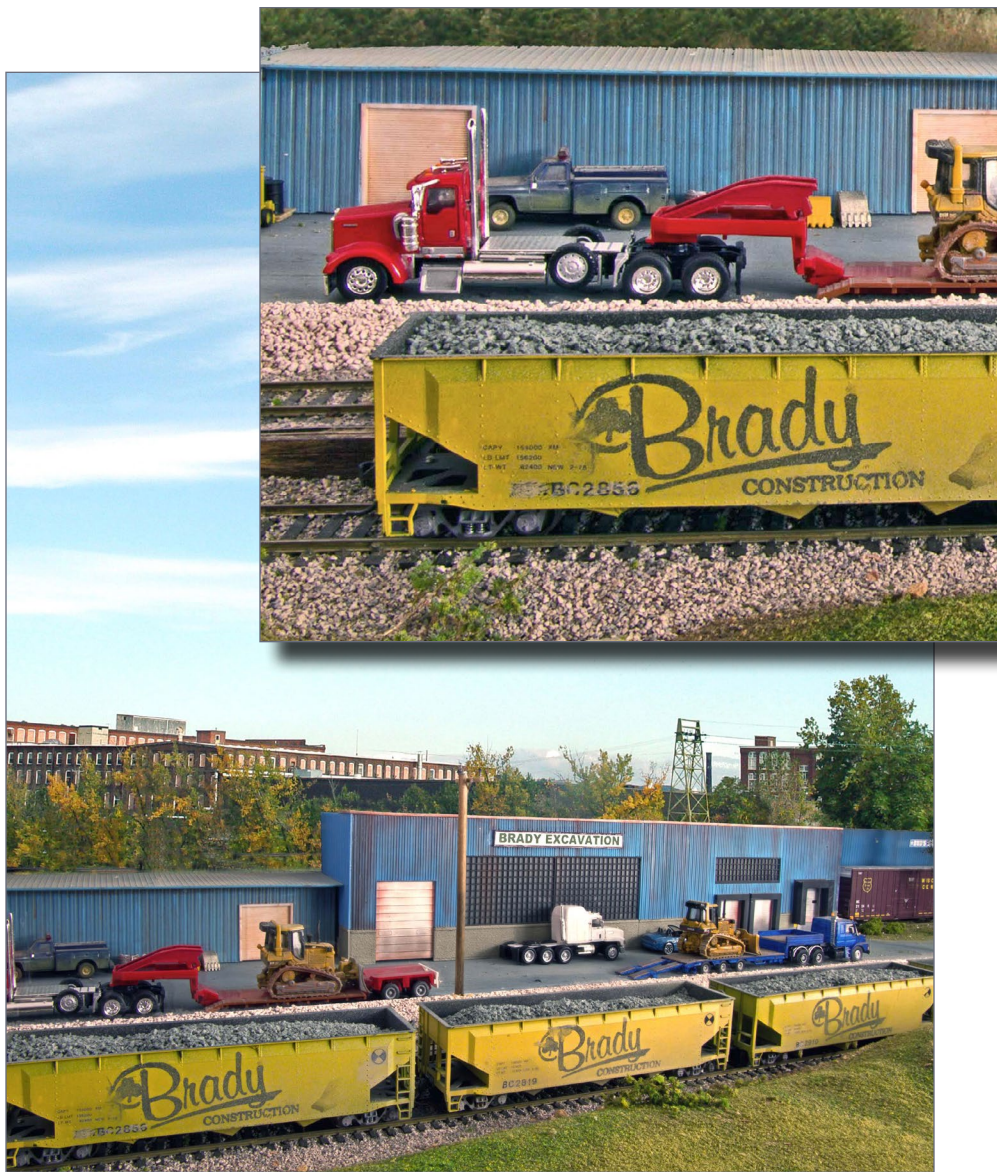

31. In the HO scale universe, Brady Construction is large enough to own an extensive fleet of ballast cars.





32. Close-up views of Brady's ballast cars. The cars are Roundhouse (MDC) models. The lettering was printed directly on the cars with an old business rubber stamp and ink pad. When the lettering was dry, the cars were weathered and sealed with Dullcote.



[Click here for  
reader comments](#)





33, 34. The Guelph steel mill was scratchbuilt by Wally from sheet styrene. The crane is by Sheepscoot Scale Models with a hand-made brass boom. The custom load was made from a piece of styrene tubing. Its function is left to the viewer's imagination.





35. CN 5004 is working as the yard power today and switches unusual loads in the yard.

Want to help  
keep MRH free?  
Then click on  
Ads!





36. An export grain train approaches the engine terminal. All of Wally's mainline curves are superelevated. The outer ends of the ties are placed over lengths of .030" square styrene.



37. A major scene on the layout is Kimbil Sand and Gravel. The asphalt plant is to the left.





38. The gravel pit at the gravel plant. Wally's construction vehicles come from a number of manufacturers. Everyone loves construction equipment!





39. Trucks waiting to be loaded at the gravel plant.



40. An overall view of the Halifax layout peninsula with Kimbil Sand and Gravel.



[Click here for  
reader comments](#)

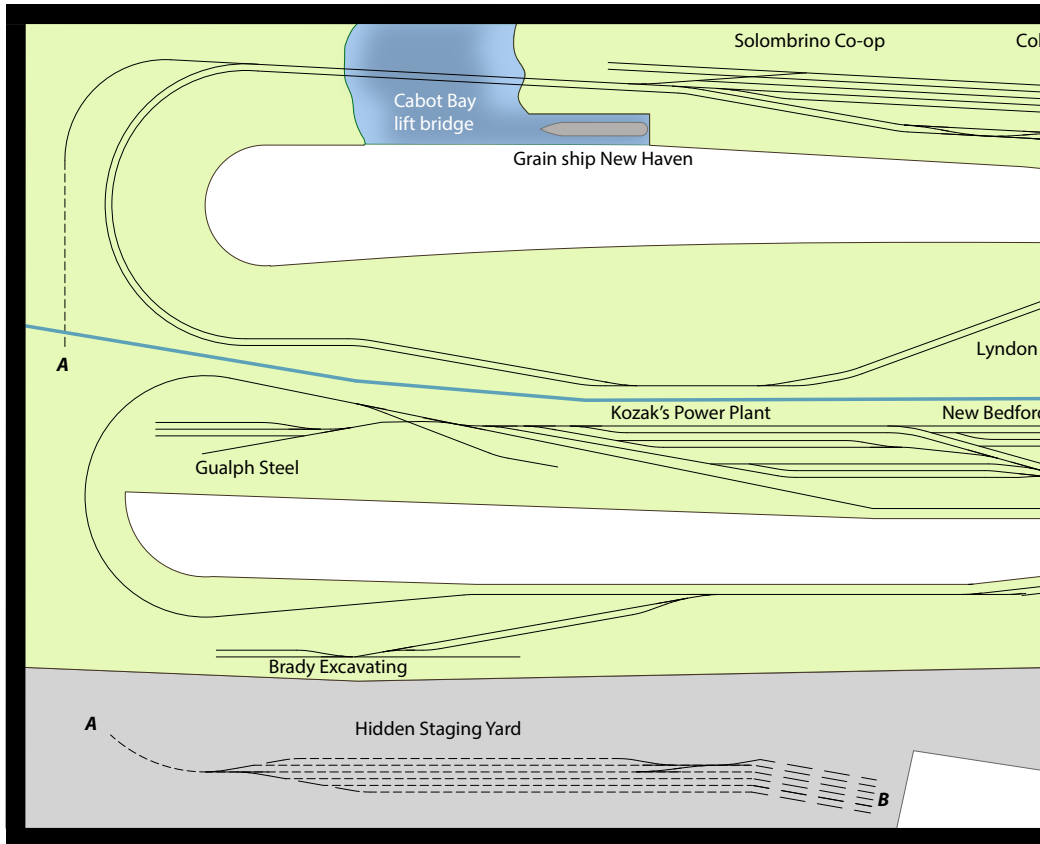

# WALLY BRADY'S CANADIAN NATIONAL RR PLYMOUTH DIVISION TRACK PLAN ROOM DIMENSIONS: 50 FEET X 20 FEET



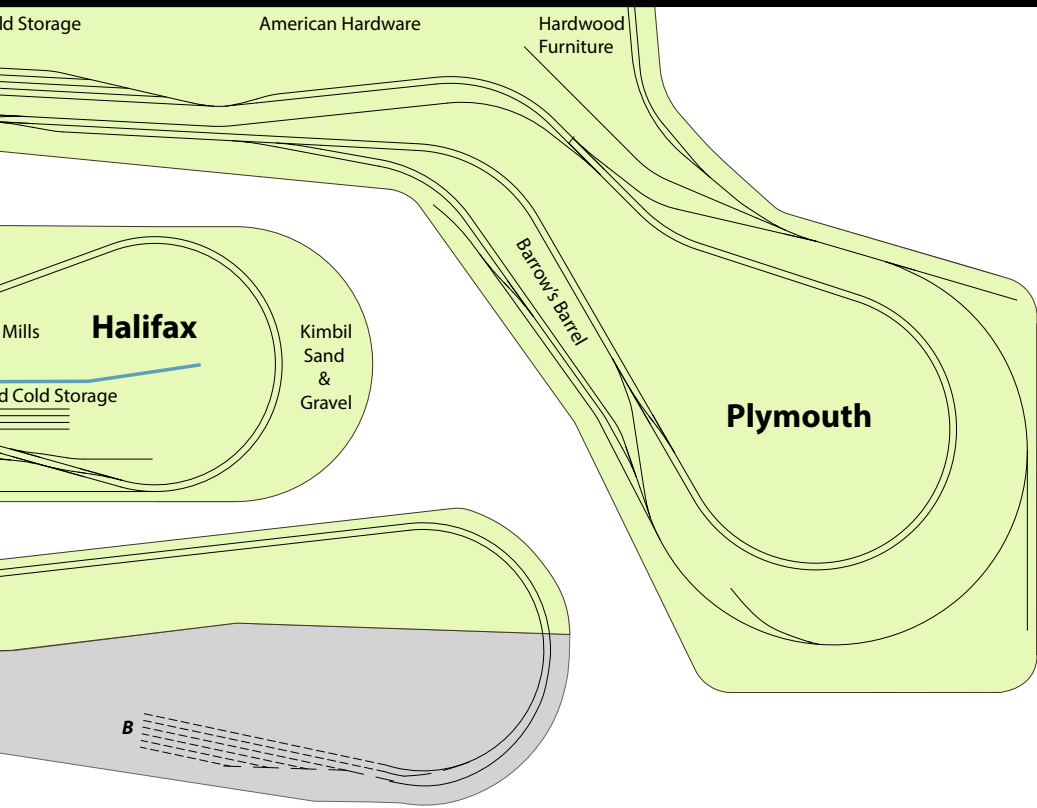

NOTE: Zoom in plan to study track arrangement details ...



[Click here for reader comments](#)



41. Overlooking the town of Plymouth. Wally very wisely finished his layout room before starting on his railroad.



[Click here for reader comments](#)



42. The run-through staging yard can hold eight trains and is quite accessible.





43. Here are Wally Brady (left) and Steve Solombrino (right) doing what they like best – sharing their hobby together.



[Click here for  
reader comments](#)

MIKE TYLICK, MMR



Mike Tylick has built several smaller layouts of various types and scales over the years. He has been a long time contributor to *Model Railroader*, *Railroad Model Craftsman*, the *NMRA Bulletin*, and other hobby publications. Mike has also given numerous clinics and presentations on railroad and historical subjects.

Mike now works as a custom builder of railroad structures and rolling stock, and has recently formed **RailDesign Services** ([raildesignservices.com](http://raildesignservices.com)) to assist hobbyists with their model railroad design and graphic needs. ■

.....

ADVERTISEMENT



Announcing  
*New home for Motrak Models*

Motrak Models Headquarters is now at  
717 Windsor Lane, Martinsville, VA. 24112



Phone number: 813-476-4784  
Email: [motrakmodels@centurylink.net](mailto:motrakmodels@centurylink.net)

# The Fine Scale Model Railroader Expo 2015

THE EXPO STEAMS INTO  
SCRANTON, PA

MARCH 26, 27 & 28

● LEARN ● BUILD  
● ENJOY ● CREATE

**MODELING AT IT'S BEST**

## SOME OF OUR VENDORS & MANUFACTURERS:

Laser Modeling 3	MRH Magazine	Crow River Products
Sterling Models	SierraWest Scale Models	Scale Creations
Train Troll	Bar Mills Scale Model Works	FSM Kits
Motrak Models	Gatorfoam	Harbor Belt Lines
Stoney Creek Designs	Fos Scale Models	Backdrop Junction
Microlumina	Atlantic Scale Modelers	Mt. Albert Scale Lumber
Rail Scale Miniatures	Sea Port Model Works	Downtown Deco
Nick & Nora Designs	VectorCut	KC's Workshop
Crusader Rail Services	Carolina Craftsman Kits	Model Tech Studios
New England Brownstone	Paw of a Bear	Scenic Express
Hunterline	Mount Blue Model Co	BEST Trains

## HANDS-ON, SMALL GROUP, PLATINUM CLINICS:

- Contest Quality Weathering & Finishing Model Methods w/ Bob Mitchell
- Soldering & Structure Lighting with LEDs w/ Bill Sartore of Microlumina
- Using Digital Photos for Modeling Surfaces with author Lance Mindheim
- Carving Realistic Stonework w/ Russ Greene of New England Brownstone
- Techniques Using Pan Pastels w/Roger Malinowski - Stoney Creek Designs
- Build a Mini Board-by-Board Kit w/ Brett Gallant - SierraWest Scale Models
- Build a Truss Bridge Beginning to End. Maureen & Rick Hunter - Hunterline
- Mastering The Application of Static Grass w/ Jimmy Elster of Scenic Express
- Scratch Building and Boats - Using Card Stock with modeler Jon Addison
- Bring Life to Your Figures Dave Revelia Suncoast Center for Fine Scale Modeling
- Get Wet - A Fantastic Resin Water Clinic w/ modeler Bill "Michaels" Obenauf
- Hydrocal Kits Don't Bite Really They Don't Randy Pepprock Downtown Deco

**40 AWESOME CLINICS TO CHOOSE FROM!  
THE BEST VENDORS & MANUFACTURERS!  
ALL JUST STEPS AWAY FROM STEAMTOWN!**

**WWW.MODELRAILROADEXPO.COM**

MRHMAG.COM

- [TABLE OF CONTENTS](#)
- [INDEX](#)





Model Railroad Hobbyist | March 2015 | #61

# YES, IT'S A MODEL

*compiled by*  
**DON HANLEY**  
.....



**Click here for  
reader comments**



1. BM 77318, a well-weathered Boston and Maine boxcar, crosses a small creek on Neil Schofield's layout. The model is a Kadee Boston & Maine 50' PS-1 Neil weathered to reflect a tired boxcar with running board nearing the end of its service life in the early 1980s.

▶ **MRH'S MONTHLY PHOTO ALBUM**

**MRHMAG.COM**

- **TABLE OF CONTENTS**
- **INDEX**

## YES, IT'S A MODEL | 2



2. Ray Dunakin posted on the forum this radio repair/barber shop that he built for the town of Mineral Ridge on his IN-KO-PAH garden railroad. Ray took the time to detail the interior of the model with radios he built from scratch. This is G scale and the work is outstanding. To follow the building of this structure visit Ray's blog at [raydunakin.com/Site/IRR\\_Mineral\\_Ridge\\_3.html](http://raydunakin.com/Site/IRR_Mineral_Ridge_3.html).



## YES, IT'S A MODEL | 3

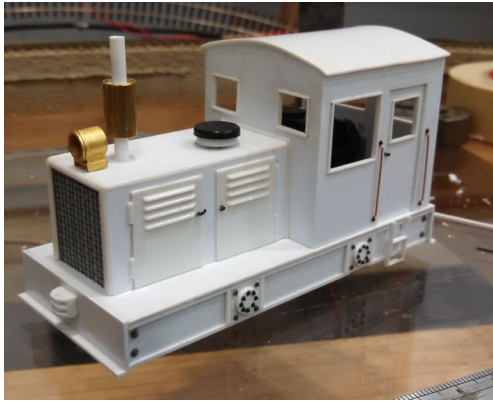

3. Ross Ames scratchbuilt this On30 critter for his required scratchbuilt motive power for an NMRA AP. Ross took the motor, gears and wheels out of an old Life-Like HO Lil Hustler. "After looking at bunches of images on Google I pieced together some features of locos I liked to come up with my 'imagineered' On30 critter," Ross said. He used Gary Christensen's Rustbucket Weathering article from *Model Railroad Hobbyist* in August 2014 ([mrhpub.com/2014-08-aug/land/#76](http://mrhpub.com/2014-08-aug/land/#76)) to try his hand at some extreme weathering.



## YES, IT'S A MODEL | 4



4. T ASD 78198, an old rust bucket, finally gets picked up from a siding for the last time. A new owner and new patch road number await. The model is an old HO scale kit from Roundhouse. Before weathering, the car was lightly sanded with 1200 to 2000 super-fine wet-and-dry sandpaper to fade the lettering and printing on the car side. Weathering was done using burnt sienna, burnt umber, and yellow oil paint, and weather powders to create the effect. Terence Boardman weathered and photographed the car. ATSF 152618 is another example of his work.

## YES, IT'S A MODEL | 5



5. Trevor Sokolan built CN 1080, a GMD-1, after Jason Shron posted a challenge to model CN 1080 on the Rapido Trains website. Trevor removed the radiator hatch frame and grilles from the roof of

the unit, and mounted photo-etched grille pieces directly to the hood. He added a grab iron to the outside edges of the long hood as well as on the conductor's side of the short hood near the cab door. He weathered his model with a combination of black pencil and multiple color passes with an airbrush. The factory gray paint was masked, and a light coat of PollyScale Engine Black was sprayed over the yellow and blue paint along the long hood to represent the patch job applied by the CNR. While the paint was drying, he scraped off some of the black to expose the yellow paint underneath, as per prototype photos.



## GET PAID FOR YOUR PHOTO

We pay \$40 per photo we publish. If you'd like to get your modeling in our photo feature, just start posting your photos on the MRH website, especially in the Weekly Photo Fun thread created each weekend.

See [mrhmag.com/help](http://mrhmag.com/help) for more on how to post an image. You need to be an MRH subscriber to post photos to our website, and becoming a subscriber is free, [just fill out this form here](#). ■

---



[Click here for reader comments](#)

**When talking to hobby vendors, please remember to mention MRH.**





In the spirit of improved America-Cuba relations (and crass, opportunistic marketing strategies), we think you should buy a whole truckload of our new

# HO Scale Cuban GMD-1 locomotives!



\* The broken headlight in the picture is not included. But you can always break it yourself if you really want to.

**Click here to order. Deadline is March 17th!**



BY **MIKE HOLLY**  
.....  
Photos by the author

**AFTER RUNNING A COUPLE OF OPERATION** sessions on my N scale Elizabeth Oaks layout, I was uncomfortable with the track configuration of the small engine shop. Running trains powered by cab units terminating at Elizabeth Oaks Yard revealed problems with turning engines, so I sat down at the drawing board, looking for a way to bring a turntable into the shop area.





# Scratchbuild a **TURNTABLE and PIT**

*Follow along,  
step-by-step!*

Commercially available turntables turned out either to be too large in diameter, or didn't have an appealing appearance, so I decided to build a 80' turntable from scratch using materials in my shop.

On the following pages, follow along as I describe how I built my turntable, step-by-step.



## STEP 1: INITIAL CONSIDERATIONS

My first question was about the rotation mechanism. I'm switching the turnouts on my layout using push rods, so I decided to use a hand-powered turning mechanism for the turntable, too. A worm gear drive with a 1:50 ratio, which I purchased several years ago, came in handy. This would allow 50 turns on the fascia lever resulting in one complete circle of the turntable bridge, slow enough to align the bridge to the shop tracks.

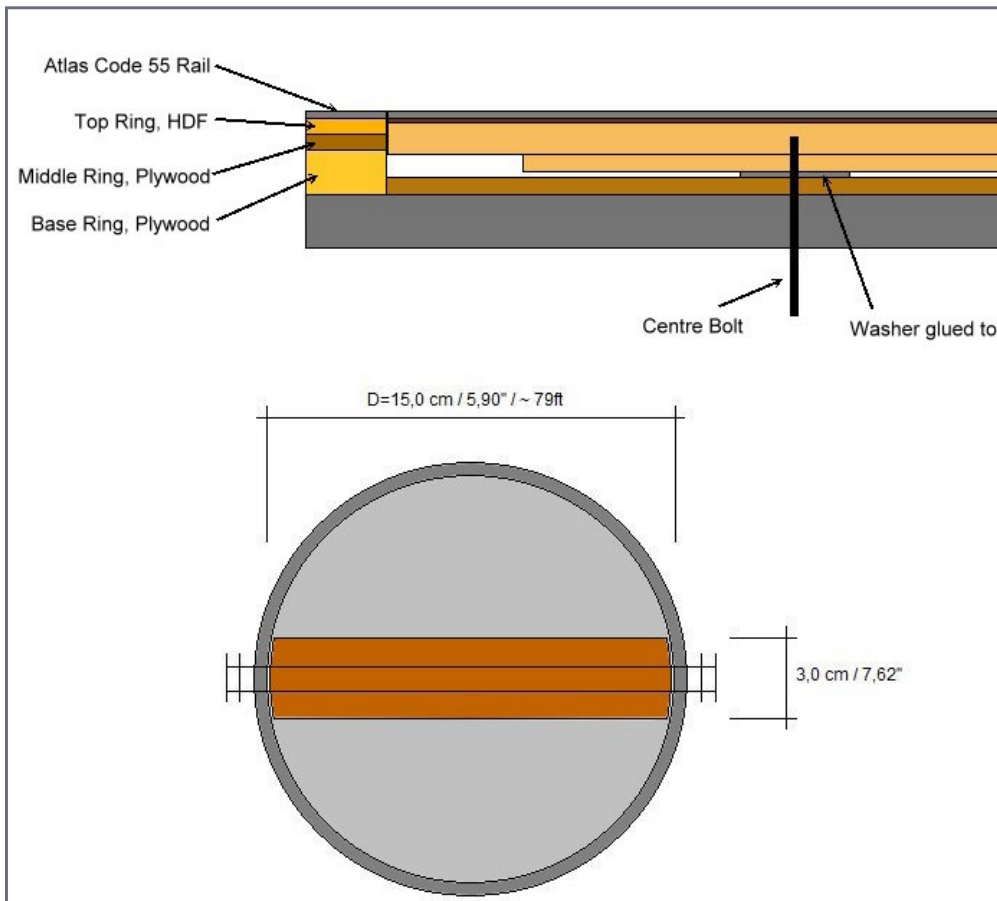

# TURNTABLE AND PIT | 4

A second question was how to fit the turntable into its designated place. Because I'm adding the turntable to an almost-finished part of my layout, I needed to adjust the height of the pit walls to match the sub roadbed which is already in place, and had to design and construct a turntable bridge not exceeding the pit height.

I drew a little construction sketch to visualize the different given construction points.

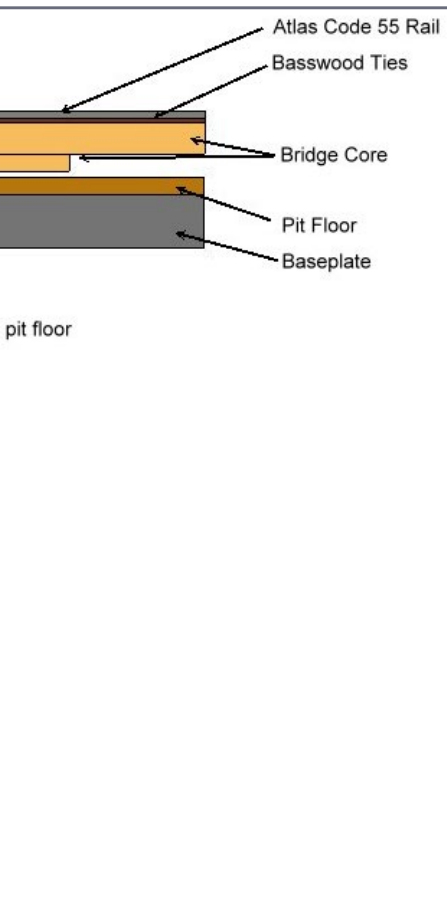
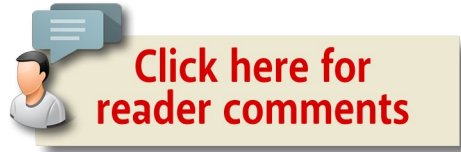

1. Sketch-up of the turntable. The basswood ties are for visual appeal only; I soldered the rails to copper coated hardboard.

### STEP 2: TURNTABLE BRIDGE

To build the core of the turntable bridge I used three layers of 0.12” high-density-fiberboard (HDF). I cut two strips each 1.1” x 5.9” and one strip 1.1” x 3.9” long. First, I glued the two long strips together using waterproof white glue. After the glue had set I marked the center point by drawing straight lines from diagonal edges [2].

Since a rectangular turntable bridge wouldn't run smoothly in a round pit I had to curve the edges of the bridge to a little smaller radius than the radius of the turntable. I used a Proxxon micro-router with a circle guide attached to shape the edges of the turntable bridge [3]. After the radius was cut, I glued the short strip centered to the underside of the bridge base.



2. Clamps helped to keep the three layers of HDF in place until the glue had set. On this photo you can see the diagonal-lines that helped me to find the center of the turntable bridge.



# TURNTABLE AND PIT | 6



3. A close up shot of the rounded bridge edge.

## ADVERTISEMENT

Mt.  
Albert  
Scale  
Models

\$95.00  
PLUS  
SHIPPING

**ORDER  
NOW**

Detail Parts  
shown included  
905.664.3400

Our First HO Kit!

About 6" x 6"



**NORTHWAY TRACTOR REPAIR**

MRHMAG.COM

- TABLE OF CONTENTS
- INDEX

## STEP 3: CREATING THE TURNTABLE PIT

For this step I had to remove some of the foam board to uncover the plywood. I used my Proxxon micro-router to cut a 7.87" diameter hole that will hold the future turntable pit [4].

I decided to build up the turntable off the layout using a separate base plate because it is easier to finalize the build-up steps away from the layout. I used 0.4" thick plywood measuring 10" x 10" for the base. The first task was to determine the center point of the plywood by drawing diagonal lines from the opposing corners. Then I marked a 5.9" radius off the center mark to have a visual guide to center the turntable pit floor exactly on the base plate [5].

Next step was to cut the pit floor and two layers of pit rings out of 0.12" high-density fiberboard and one ring out of 0.3" plywood. All ring measurements are outer diameter 7.87" and inner diameter 5.90". For the cutting I used a Proxxon micro-router with a circle guide attached. To avoid losing the center point while cutting the rings, I first cut the outer diameter and then the inner diameter [6].

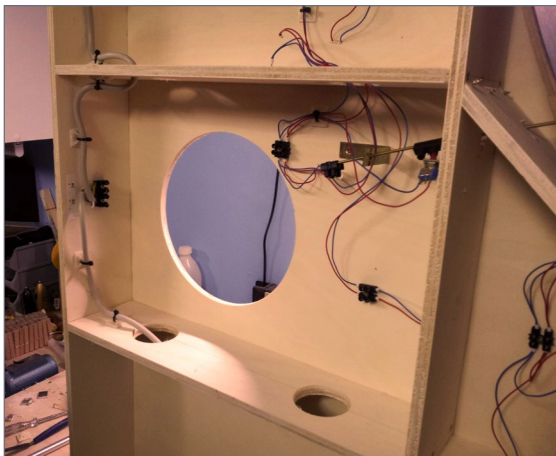

4. The hole for the turntable pit which is built-up aside from the layout. View from underside of the layout segment.

## TURNTABLE AND PIT | 8

After all rings are cut, they are glued to the plywood base ring using waterproof white glue and clamped to keep the rings in place until the glue has set [7].

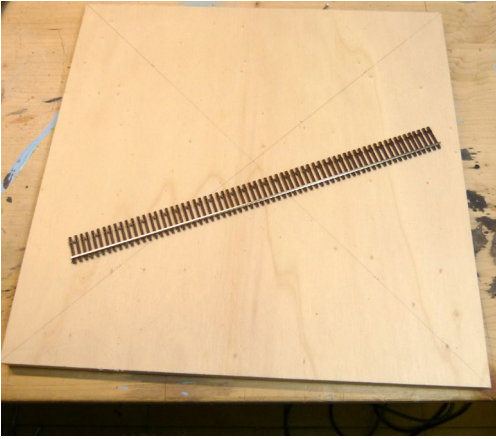

5. I estimated the center point of the base plate by drawing two diagonal lines. Marking the 5.9" radius on the diagonals helped me to place the turntable-pit floor exactly centered on the base plate.

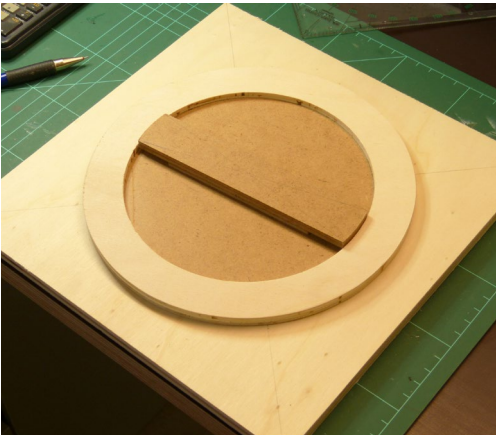

6. The first test assembly shows the pit wall rings fit around the pit floor, which was cut out of 0.12" high-density fiberboard using a Proxxon micro-router.



### STEP 3: CREATING THE TURNTABLE PIT (CONT.)



7. The final ring assembly which will later form the turntable pit wall. I used clamps to keep the rings aligned to each other until the white glue had set. The different thick layers were needed to compensate for the odd thickness of the base of the layout segment.

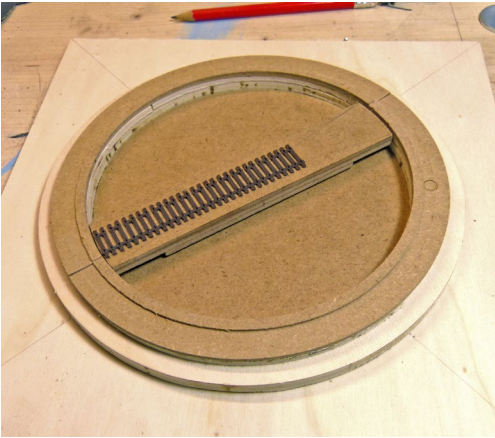

8. A test assembly to ensure all parts fit together. I later added a 0.04" squared styrene ring to the HDF top-ring to simulate the head end of the concrete pit wall.

## STEP 4: MAKING A CONCRETE FLOOR

I added construction joints to the pit floor, separating it into concrete segments. I created a template on my PC, printed it on cardboard, and then placed the template over the HDF base plate and transferred the joint edges using a pushpin. After I marked the edges, I removed the cardboard template and used the back of a hobby knife to scratch the joints.

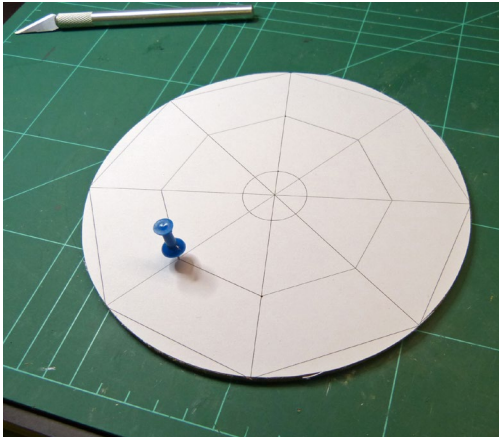

9. As I wanted to model a concrete pit floor, I need to add some construction joints, separating the pit floor into single concrete segments.

## TURNTABLE AND PIT | 11

### STEP 4: MAKING A CONCRETE FLOOR (CONT.)

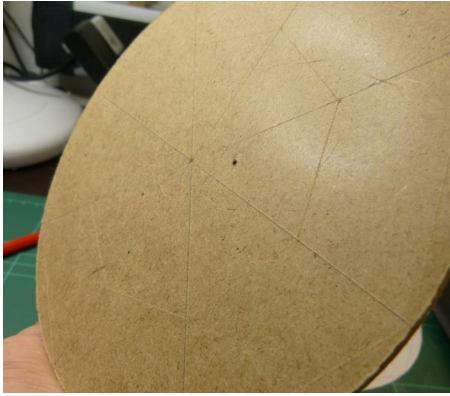

10. After I marked the edges, I removed the cardboard template and used the back of a hobby knife to scratch the joints according to the template.

11. To finalize the step for the turntable pit I had to glue the floor disk to the base-plate and drill the hole for the turntable bridge shaft.

To get an exact straight hole I used a power drill attached to a drilling stand. I first drilled the hole with a #46 drill bit, and in a second step I drilled the final hole with the same diameter as the later center bolt.



12. After all parts were ready to assemble I glued the pit ring to the base plate using white glue. I added wood screws to fix the ring to the base plate until the glue set. The picture on the left shows the turntable already colored in a concrete color mix of acrylic paint applied with an air-brush. The assembly of the ring rail is described in the next step.

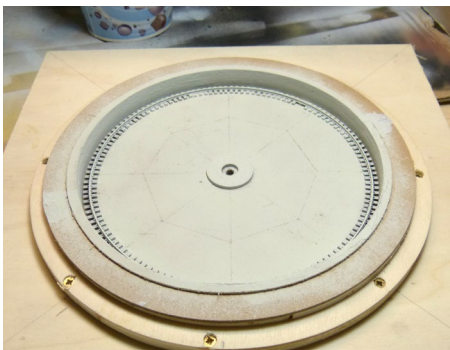



## STEP 5: INSTALLING THE PIT RAIL

While studying several prototype turntables, I noticed in most cases the turntable bridge was sitting on a rail ring running alongside the pit wall. To add this ring to my turntable, I cut a piece of Atlas N scale Code 55 flex track in the middle of the ties with a Proxxon micro table saw with a guide. The guide was used to provide an even cut throughout the full length of the piece of flex track. This gave me two different types of tie alignment, one where all ties are sitting separately on the rail and one where the ties connect to each other underneath the rail. Discard the first one, save the last; it will help you a lot.

Next, I needed a jig to bend the rail in order to create a round shape matching the pit floor diameter. You can buy several special tools for this task, but I didn't want to spend money on a tool that I will use only once. I made my own jig using some math, three push pins and a piece of scrap plywood.

For the math part :

Given : Radius R : 2.95 “, Chord length chosen : 3.15”

To be determined : segment height

$$h = R - \sqrt{R^2 - \frac{c^2}{4}}$$

With the two given values the result for the segment height was 0.456”.

More about circular segments can be found on Wikipedia : [en.wikipedia.org/wiki/Circular\\_segment](http://en.wikipedia.org/wiki/Circular_segment).

## STEP 5: INSTALLING THE PIT RAIL (CONT.)

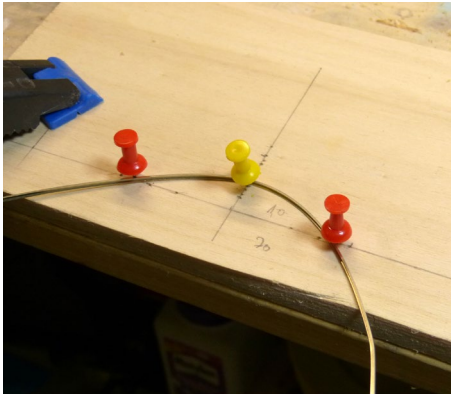

13. The self-made jig for bending the Code 55 Rail. I used pushpins to guide the rail into the radius. The red pushpins are 3.15" apart, the distance from the base-line to the yellow pushpin is calculated as written above. Use a longer piece of rail as the beginning and end will be straight which is normal because the rail will not run through all three points. Moving the rail slowly back and forth several times thru the jig forms the curved rail.



14. Testing the bended rail on the turntable pit. It needs not to fit perfectly as it will easily follow the final position as soon as the ties are in place. Notice the two straight sections and the overlapping parts of the rail. I marked a cutting point to receive a full radius. Leave a little more rail as needed for final length adjustments. You can still cut off the excess rail later.

## TURNTABLE AND PIT | 14

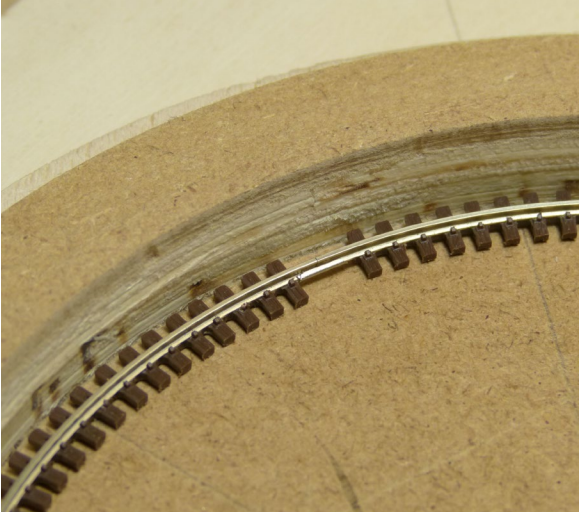

15. A close-up of the ring rail, showing the bended rail glued in place with the ties attached. I use the connected side of ties from an Atlas Code 55 flex track and slide portions of 10 ties onto the rail, keeping the original distance between the ties.



Playback problems? [Click here ...](#)



## STEP 6: ELECTRICAL CONNECTION

Speaking about electrical pickup for a turntable can bring a lot of distress to you. I wanted to keep things plain and simple, so I chose a two-way pickup using the ring rail as one potential and the center-bolt of the bridge as the second potential. To avoid short circuits after a full turn, I used a Digitrax AR-1 Auto-Reversing Controller between the turntable and the DCC power district.



16. For electrical connection via the guardrail, I soldered an AWG 24 feeder wire to a rail-joiner connecting both ends of the ring rails. To provide a narrow space between the ties adjacent to the rail joiner, I cut the joiner by half. I used a feeder wire almost 1 foot long, in order to have

enough wire to position the AR-1 at an easy to reach location under the layout.

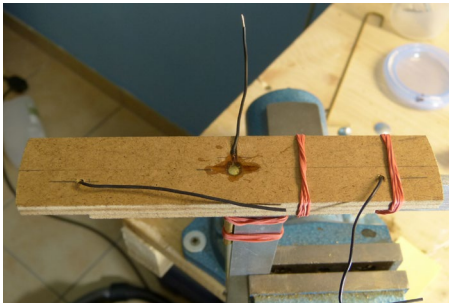

17. Prior to soldering the AWG 24 wire to the center bolt I used a cutting disc and grooved a notch into one end of the bolt. I slid the wire into the notch and started soldering.

The picture (left) shows the center bolt with attached wire glued into the turntable bridge using an arc as a guide to keep the bolt upright to the bridge. I drilled the hole into the turntable bridge using a drill stand.



**SO REAL...You'll Think You're There!**

**LokSound Select · 3 SIZES, ENDLESS POSSIBILITIES!**

**INDUSTRY LEADING  
MOTOR CONTROL**

- Multiple Bell types
- Multiple Brake squeals

**4 OR 8 Ohm  
SPEAKERS!**

- 4 or 6 Output functions depending on the style
- Up to 4 Prime Movers or Steam Sounds on EACH decoder
- 16 Very Playable, LOUD Horns or Whistles depending on Profile
- All Changeable by using ONE CV! No Programmers or Boosters needed!\*

**Small Size  
BIG POWER! 1.1Amp!  
LokSound Select  
"4 AUX"**

**ONE SIZE FITS ALL!  
LokSound Select "DIRECT"**

**Tiny Size,  
HUGE Versatility!  
LokSound Select  
"MICRO"**

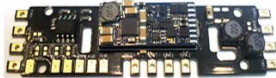

**6 Outputs!  
LED Resistance  
Built In!  
LOK SOUND  
★ SELECT ★**

**\$109.99**



Only Available From  
ESU LLC (USA)

**\$99.99**



**LOK SOUND  
★ SELECT ★**

Only Available From  
ESU LLC (USA)

**\$99.99**

**NEW 2011**

Only Available From  
ESU LLC (USA)

**\$99.99**

**NEW 2011**

Only Available From  
ESU LLC (USA)

- Great NEW Size 1.18" x 0.61"
- Versatile DCC & DC "Dual Mode" decoder!
- 8 channel sound system!
- FOUR lighting outputs and a 1.1A motor controller
- Available with ALL Current LokSound Select Sound Profiles
- Use 4, 8, or 16 Ohm Speakers

- Easy Drop in Design
- Versatile DCC & DC "Dual Mode" decoder!
- 8 channel sound system!
- SIX lighting outputs ALL with built in resistors for LEDs
- Available with ALL Current Diesel Sound Profiles
- Use 4, 8, or 16 Ohm Speakers

- Great NEW size ONLY 0.98" x .417"
- Versatile DCC & DC "Dual Mode" decoder!
- 8 channel sound system!
- FOUR lighting outputs and a .75A motor controller!
- Standard 8-pin NEM 652 plug included
- Available with ALL Current LokSound Select Sound Profiles
- Use 4, 8, or 16 Ohm Speakers!

\* ESU LokProgrammer needed to "Replace" Sound and for Firmware updates, not for normal editing

[www.LokSound.com](http://www.LokSound.com) • 477 Knopp Drive Muncy, PA • 570-649-5048

Now on facebook!



**MRHMAG.COM**

- **TABLE OF CONTENTS**
- **INDEX**

## STEP 6: ELECTRICAL CONNECTION (CONT.)

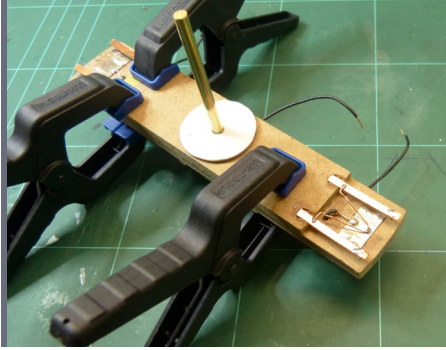

18. Next step was to construct the power pickup. I cut 0.02" copper-coated hardboard into strips, each long enough to fit between the turntable bridge and ring rail. I glued the strips into drilled 0.08" diameter notches using UHU Epoxy 2K glue. A clamp on each strip helped to keep it in

place until the glued had set.

Next step was to connect both strips of one side using an AWG 24 solid wire. I bent the wire in a sort of V-shape and soldered it to a connection plate where the pickup wire for the rails is soldered to too.

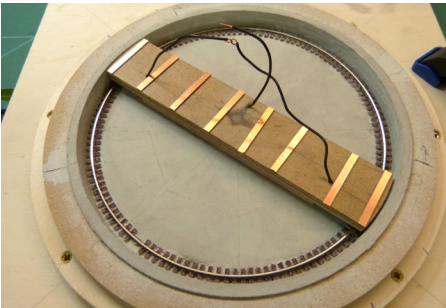

19. With all wires in place I grabbed my multi-meter and did a continuous run test, manually circling the turntable bridge on the ring rails. After receiving a full-turn "beep" I was sure continuous electrical connection will be provided later.



## STEP 7: SLOW-MOTION GEAR

After testing the power connection, it is time to bring in the turning mechanism. To provide an easy and reliable turning mechanism I settled so a manual turning-lever crank which is driving a 50:1 plastic-worm gear. My first attempts connecting the turning lever directly to the worm gear failed. The turntable didn't move smoothly and the lever stuck several times. I added a single universal joint between the worm gear and the turning lever for only a slight improvement. The sticking was gone but there appeared to be some sort of tension on the turning lever. I added a second universal joint, and now the full turn is smooth and quiet.

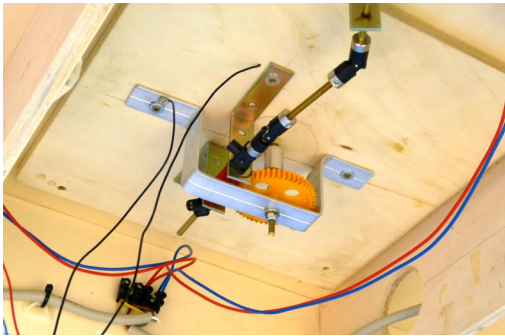

20. The turntable with the finalized turning mechanism in place.

I used a connecting bolt [20] to extend the bridge pivot to the worm gear, switching from a plain brass rod to a geared brass rod. I glued the red worm to a plain copper rod using UHU Epoxy 2K glue – leaving the rod approximately 1” longer on each side than the worm itself. This allowed me to adjust the position of the worm later. To assure the worm will stay in place and will not slip from the gear I used standard brass arcs. I fitted them tightly to the worm and added one-pole electronic clamps outside the arcs to secure the worm in place.

## STEP 7: SLOW-MOTION GEAR (CONT.)

After testing the power connection, it is time to bring in the turning mechanism. To provide an easy and reliable turning mechanism I settled so a manual turning-lever crank which is driving a 50:1 plastic-worm gear. My first attempts connecting the turning lever directly to the worm gear failed. The turntable didn't move smoothly and the lever stuck several times. I added a single universal joint between the worm gear and the turning lever for only a slight improvement. The sticking was gone but there appeared to be some sort of tension on the turning lever. I added a second universal joint, and now the full turn is smooth and quiet.

I used a connecting bolt [20] to extend the bridge pivot to the worm gear, switching from a plain brass rod to a geared brass rod. I glued the red worm to a plain copper rod using UHU Epoxy 2K glue – leaving the rod approximately 1" longer on each side than the worm itself. This allowed me to adjust the position of the worm later. To assure the worm will stay in place and will not slip from the gear I used standard brass arcs. I fitted them tightly to the worm and added one-pole electronic clamps outside the arcs to secure the worm in place.

Grease helps to reduce friction and assures smooth turning.

The guide of the turntable pivot was made of custom bend square alloy. The turning wheel of the gear is fixed in place by two self-locking nuts. The self-locking nut beneath the alloy strip provides the down force for the turntable bridge. Don't provide too much down force to the bridge pivot, as it might pull the pivot out of the bridge body.

All in all the alignment of the turning mechanism requires a little trial-and-error to bring everything flush and in alignment. However, measuring twice before bending, screwing or cutting anything helped me to keep the error part as small as possible.

### STEP 8: FINALIZING THE TURNTABLE BRIDGE

After placing the turntable pit in the designated space on my layout and testing the turning mechanism several times, it was time to fasten some rails to the bridge. For this, I removed the bridge from the turntable and worked on my workbench. My plan was to replicate the look of narrow tie spacing in the middle of the turntable bridge and long walking boards alongside the rails, flush with the rail heads.

Prior to this step I decided to add PC ties to the turntable bridge. They provide a reliable base for the code 55 rails. The strips are approx. 0.1” wide and cut to length to match the turntable bridge width. After soldering the rails to the PC strips, I removed the hardboard section between the rails completely and filled the space with basswood cut to match the width of standard ties.

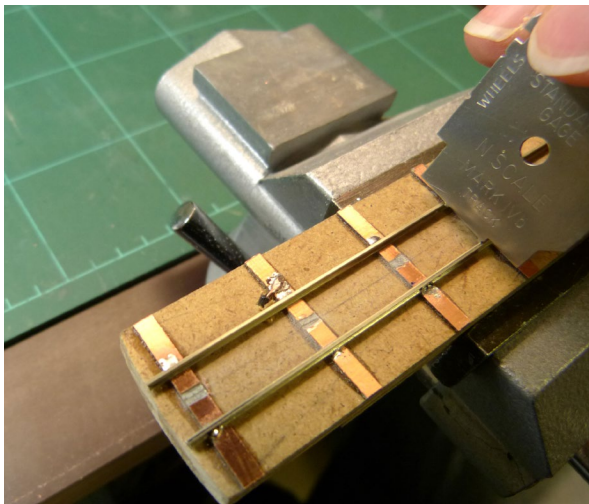

21. First I soldered one rail to the copper-coated hardboard strips. The second rail was aligned to the first using a standard N-scale gauge. You can see the marked centerline of the turntable bridge, which is very helpful while placing the rails.



## STEP 8: FINALIZING THE TURNTABLE BRIDGE (CONT.)

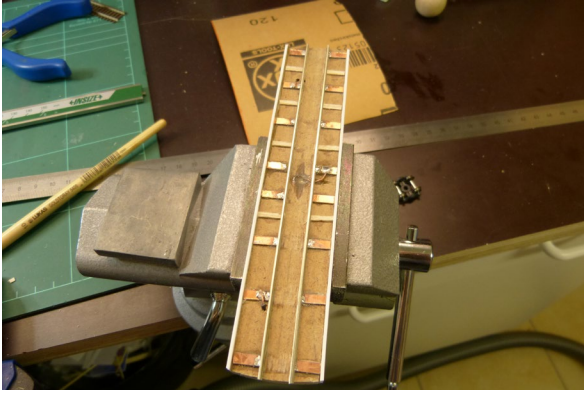

22. Before adding the ties between the rails, I removed the hardboard strips using a diamond cutting disc on my Proxxon hand tool.

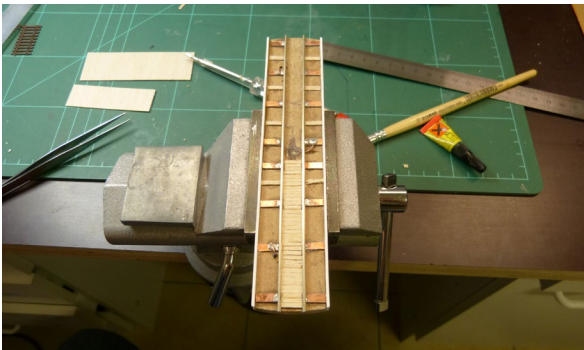

23. With the middle sections of the hardboard strips removed, I added wood ties, I cut from 0.04" basswood. I glued the ties to the turntable bridge using cyanoacrylate glue.



24. The finished bridge deck. I made the walkway boards from 0.04" basswood strips. To add some weathering to the wood, I applied several coats of a black wash made of black acrylic paint and 70% isopropyl alcohol (Mixing ratio 1:10).

## TURNTABLE AND PIT | 21

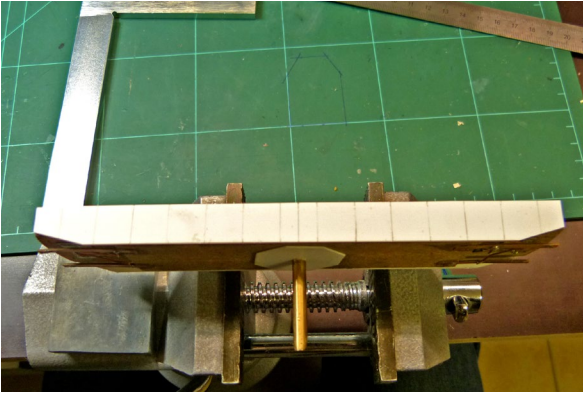

25. To simulate the look of sheet-metal sides on the turntable bridge I first cut out two 0.04" styrene sections and glued one on each side of the turntable bridge. Using clamps helps to keep the styrene in place until the glue had

set. For the shape of the sections I drew a template on my PC and printed it out on self-adhesive paper.

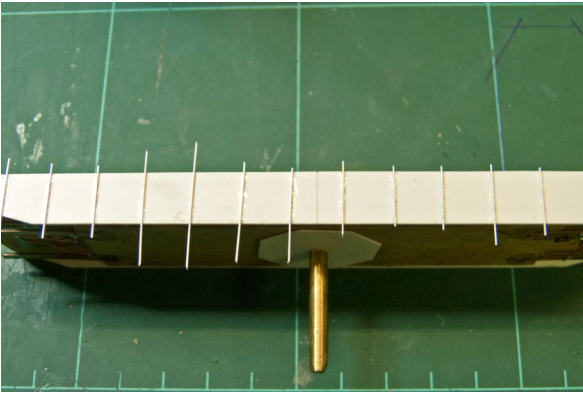

26. After the side-parts are in place, I need some metal braces. Therefore I marked the center line of the styrene side with a pencil and drew helper lines at approximately .05" spacing on to the sides. Later I glued Plastruct 0.01" x 0.02"

styrene strips with the narrow side along the markings using plastic cement. I left the strips a little longer than the height of the side and snapped the excess material off after the glue dried throughout, using a sharp hobby knife.

Not shown on this photo : I later added a Plastruct 103 (0.01" x 0.06") styrene strip as a top brace.

## STEP 9: FINAL TOUCHES

I added a curved H-beam arch to simulate a power connection I found on several smaller turntables. I described the construction of this H-beam in MRH in the Sept. 2014 issue, [mrhpub.com/2014-09-sep/land/#113](http://mrhpub.com/2014-09-sep/land/#113).

The electrical connection box on top of the arch is made up of styrene squares cut out of various thicknesses. The service steps are made of AWG 28 copper wire glued to the beam using CA glue. For the power wire running inside the beam, I also used AWG 28 copper wire.

With all details in place, I painted the bridge flat black using my airbrush. I protected the rails and the bridge deck by masking them off using yellow painters tape.

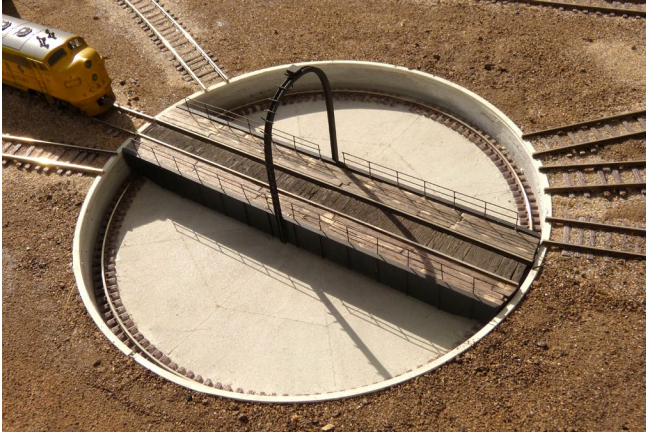

27. The finalized turntable as it now sits on my little engine shop. The turntable pit received a coat of concrete colored acrylic paint. I simulated the rusted rails using maroon colored acrylic paint. To tone everything down several coats of thinned black acrylic color are applied. I used a mixture of 1 part black and 10 parts 70% isopropyl alcohol. ☑





### MIKE HOLLY

Mike Holly lives in Germany near Weisbaden. He got his first train set at the age of 10 and started two German-themed layouts. After visiting a local U.S. model railroad convention a couple of years ago, Mike got infected by the U.S. model railroad virus.

While planning his house, he convinced his wife to add a dedicated room in the basement for a model railroad. He built the proto-freelanced “Elizabeth Oaks Branch Line” which is operated by the fictional Cleveland & Eastern Railroad Co. and is set in northeastern Ohio and Pennsylvania. Construction of the layout started in 2011.

He has a Bachelor of Engineering degree in road design and construction.

Mike is 38 and lives with his wife, Nicole, and his 4-year-old daughter, who loves railfanning. ■

---



[Click here for reader comments](#)

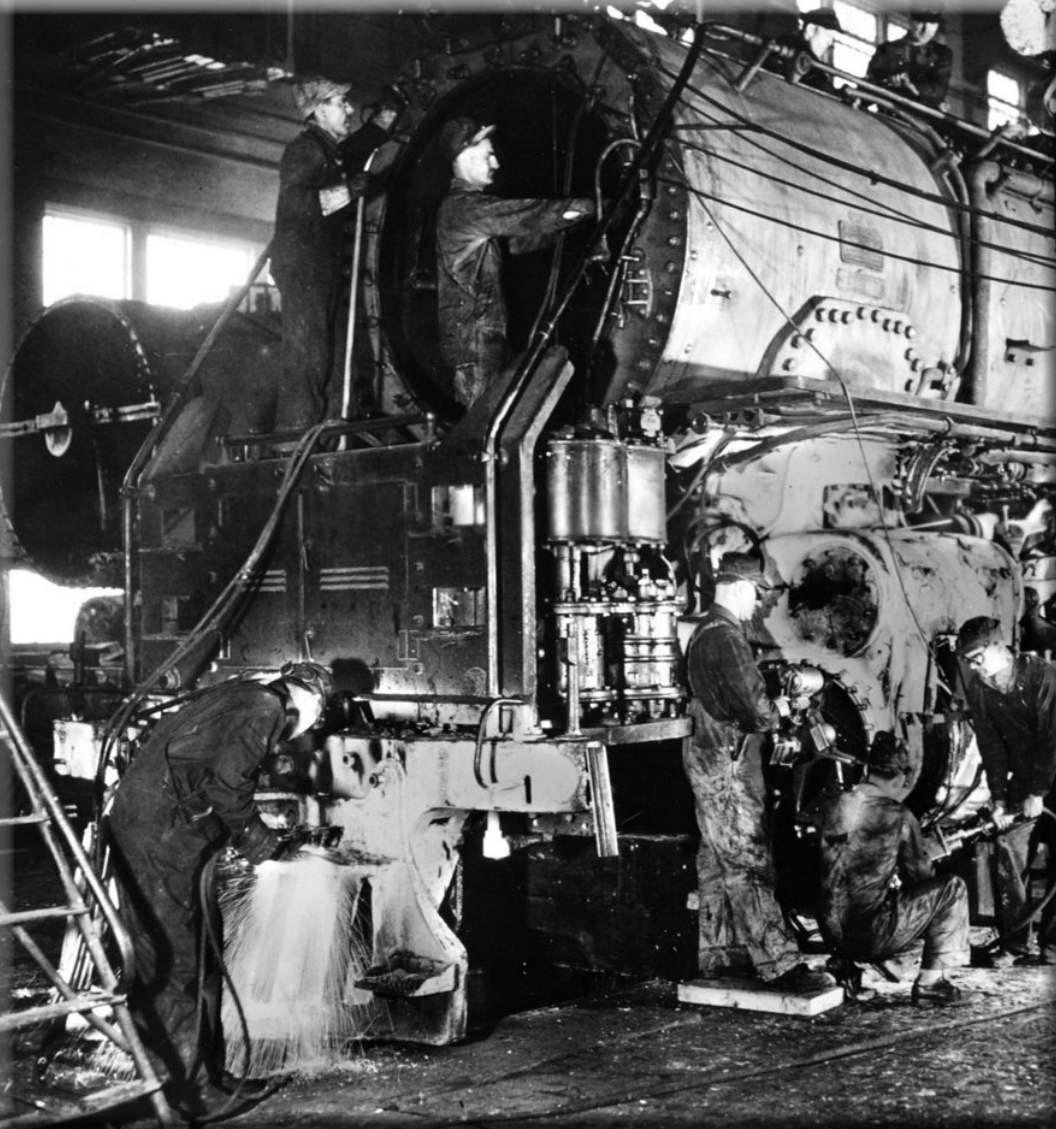

## *Keep your brass engines running well...*

**HUNDREDS OF BRASS STEAM ENGINES HAVE** been built over the last 60 years or so and most are probably still running, which attests to their sturdy construction and lasting appeal. Like a real locomotive, they need maintenance and occasional repairs. While specialized or highly technical equipment



# BRASS STEAM ENGINE

## *Tune-up and Repair*

BY BOB BATTLES  
.....

Union Pacific Railroad Photo,  
Don Strack Collection.

is not necessary to repair them, a brass engine is just complex enough that not everyone can keep one running.

It my intention to help a modeler who has a good mechanical aptitude, an ohmmeter, a power pack with alligator clip leads, and some good-quality modelers hand tools to keep their engines running well, and assist in solving most problems that arise.





[Click here for  
reader comments](#)

I cannot list every possible problem and a quick solution, but after doing brass engine repairs for a busy hobby shop for over 16 years, I will cover the most common problems. I will also give you some hints and shortcuts to find potential trouble spots and remedy them.

You will need either an ammeter or a “Short-Circuit Indicator” on your power pack, since you must be able to tell if you have an open or a short circuit. If you do not have an ammeter, pick up an 1154 (or any 12-volt auto dome light bulb) at your local auto parts store. Solder it in series with one of the leads out of your power pack and paint it red [1]. When you apply power, if you have a short the “Short Indicator” bulb will light, if you have an open, it will not.

**Note:** This is absolutely vital. You will need to know for certain whether you have a short or an open when working on an engine that will not run!

## THE BASICS

Because brass locos probably have as many electrical problems as they do mechanical ones, it is vital that you know the basic electrical circuitry. On about 99.9% of brass steam locos, the tender trucks draw power from the left rail (as the engine is facing forward) and the engine picks up power from the right rail. This means the entire tender has the left rail power on it. It also means the whole loco frame and boiler have the right rail power on them [2].

# BRASS STEAM ENGINE REPAIR | 4

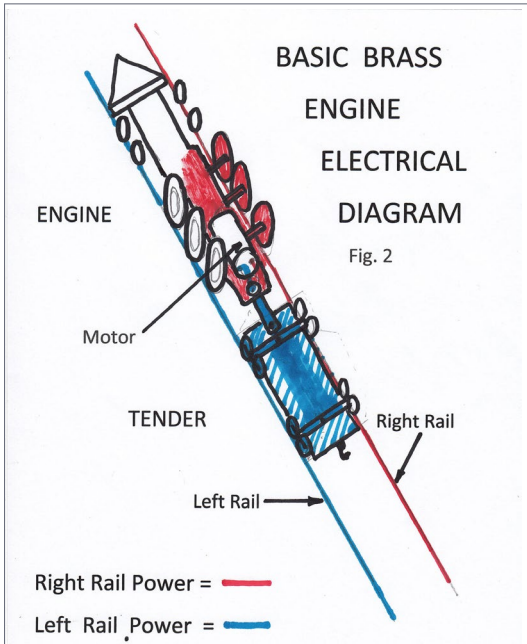

1. Basic electrical diagram of a typical brass steam loco, showing paths for track power to the motor. Right rail power is shown in red, left rail in blue.

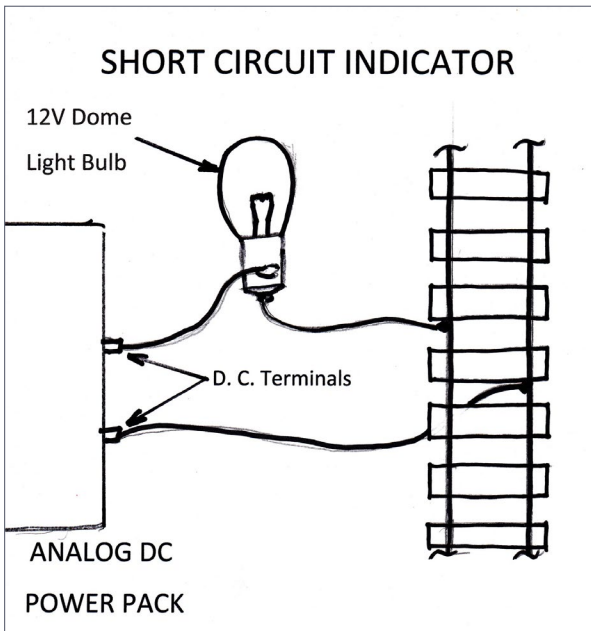

2. How to connect a "Shorts Indicator" 12-volt automobile dome light bulb into your power pack wiring.

## BRASS STEAM ENGINE REPAIR | 5

Brass locomotives manufacturers avoid shorting the two rails together by using insulated wheels on the right side of the tender and the left side of the engine. If anything metal on the frame of either one touches an insulated wheel, you will have a short.

To get power from the tender trucks to the motor in the engine, an insulated drawbar on the engine connects with a stud fastened to the tender frame, passing power from the left rail through the tender frame to the insulated brush of the motor. The other motor brush is connected to the engine frame and back to the right rail, completing the circuit. Tank engines will have pickup wipers on the left side drivers.

To perform any work on a brass engine motor or drive, the boiler must be removed. You will need a cradle of soft foam rubber or similar material to hold the engine upside down.

There are usually two screws at the back of the cab and a longer one directly under the stack going up through the frame between the cylinders. Remove them and the boiler should be loose, so you can now carefully lift out the frame and running gear (watch out for headlight wires) and set it aside. To run the upside-down “chassis” or drive without the boiler, put one power pack clip lead on the drawbar and the other anywhere on the bare frame and the engine should run.

**CAUTION!** Keep your fingers away from the valve motion and side rods while it’s running – they can give a painful pinch hard enough to draw blood!

### LUBE AND INSPECTION

With the loco frame upside down on a soft surface, clean all of the wheels. I use a Dremel with a wire wheel. Check that all driver crank pin screws are tight, and all screws visible from the



underside are tight. Remove one screw from the gearbox cover. Loosen the other and pack some light grease into the gears. Oil the worm shaft and motor bushings with a hypo oiler. I use LaBelle oils and they seem to work well.

Oil the side rod crank pins and valve motion parts lightly. Do not oil driver axle bushings or you will be sorry! Gummy or excessively dirty axle bushings can be flushed generously with alcohol or brake cleaner until they turn freely. If they squeak, apply some powdered graphite and work it in with a little alcohol.

Clean the tender wheels if the loco hasn't been run for a long period. Remove each tender truck and, using the wire wheel, clean the truck and body bolster surfaces where the trucks bolt to the body – this is a common source of poor contact. Be sure you reinstall the tender trucks with the insulated wheels on the right side.

*“I cannot list every possible problem and quick solutions, but after doing brass engine repairs for over 16 years, I will cover most common problems.”*

Check the drawbar for tightness, making sure it is parallel to rails. Secure the contact wire, make a solid connection for the wire on the upper terminal, check couplers for low “hoses,” and check all wheelsets for correct gauge. Wheels out of gauge should be regauged. If you are having mysterious derailments or shorting out on switches, you will need to remove a wheelset in order to press it into proper gauge.

## TROUBLESHOOTING

### **1. The engine is dead and won't move.**

Apply power and determine if you have a SHORT or an OPEN circuit.

If you have an open, look for a broken wire from drawbar to motor, reversed tender trucks, or dirty/gummy tender truck bolsters. If you have a gummed-up motor, flush the brushes and commutator with isopropyl alcohol, remove the flex coupling, and run the motor under power until its speed stabilizes.

If you have a short, lean the tender over so the left side wheels are off the rails, and see if the short goes away. If it doesn't, the short is in the engine. Things to look for are a driver brake shoe on the left side touching a wheel. On the leading and trailing trucks, check for a reversed wheel or wheels. If a short goes away with the tender lifted half off the rails, check the tender looking for a reversed, truck, contact between the drawbar and the loco frame, or something touching an insulated wheel.

### **2. The engine runs poorly, is noisy, or won't pull much**

If the motor turns freely, with the drivers lifted off the workbench, turn the worm shaft on the gearbox by hand. It should turn freely. If it doesn't, remove the gearbox bottom cover screws, lift the gearbox out from the top, and check if worm gear turns freely. Grease can congeal and make it very difficult

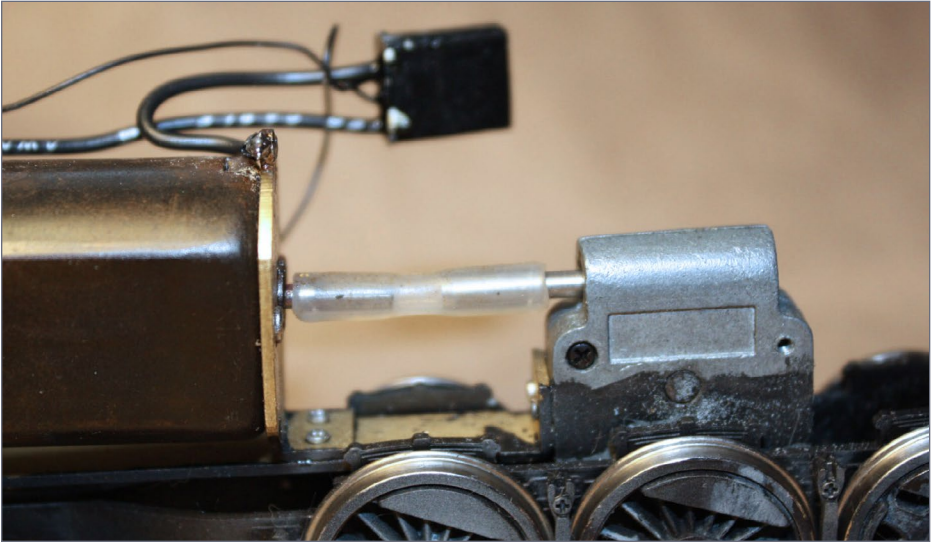

3. The flex coupling between the motor and gearbox. Note they are in a straight line and there is clearance between the neoprene coupling and the gearbox and motor.

to turn the worm shaft. Clean out the old grease with brake cleaner or lacquer thinner.

With the gearbox removed, roll the engine back and forth on the workbench. It should roll freely. Check this with a light push by hand and minimal downward pressure. If there is a bind, it must be fixed. See the section on valve gear. When reassembling the gearbox, pack it with light grease, and oil the worm shaft bushings.

Make a new flex coupling from neoprene tubing, adjusting it so it doesn't wobble or bind, and allow for a little end play.

**HINT:** Many loco vibrations and noisy operation are often caused simply by a poorly adjusted flex coupling. Take a little extra time to adjust it and make sure it runs straight and doesn't wobble. It must not touch the gearbox or the motor cases. The



motor shaft and worm shafts must both be in a straight line. If the shafts are not bent, the bushings are tight and the flex coupling is properly adjusted, it will run almost silently with no vibration [3].

If the locomotive still runs poorly, check for excessive end play in the gearbox worm shaft. This can cause lurching and very uneven running, especially downhill. To remedy this, disassemble the gearbox and add washers to the worm shaft. Be sure you have a slight end play when you finish, with no binds.

### **3. Intermittent stalls and poor pickup**

Check for one of the following: Dirty wheels, dirty tender truck bolsters, drawbar contact wire loose, bent drawbar. Equalized

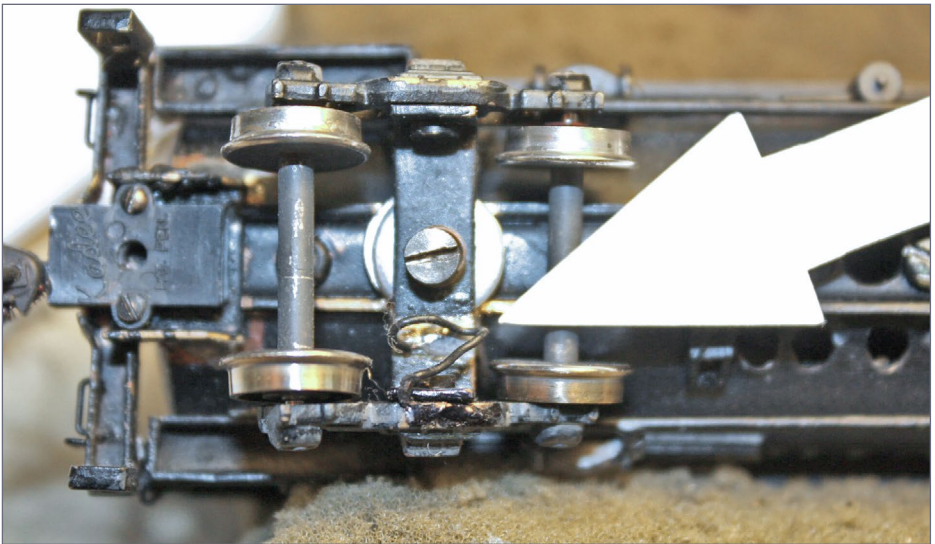

4. The arrow points to the short jumper wire going from the left-side tender truck side frame to the bolster, to bypass a potential poor connection on equalized trucks. This is done to both trucks.

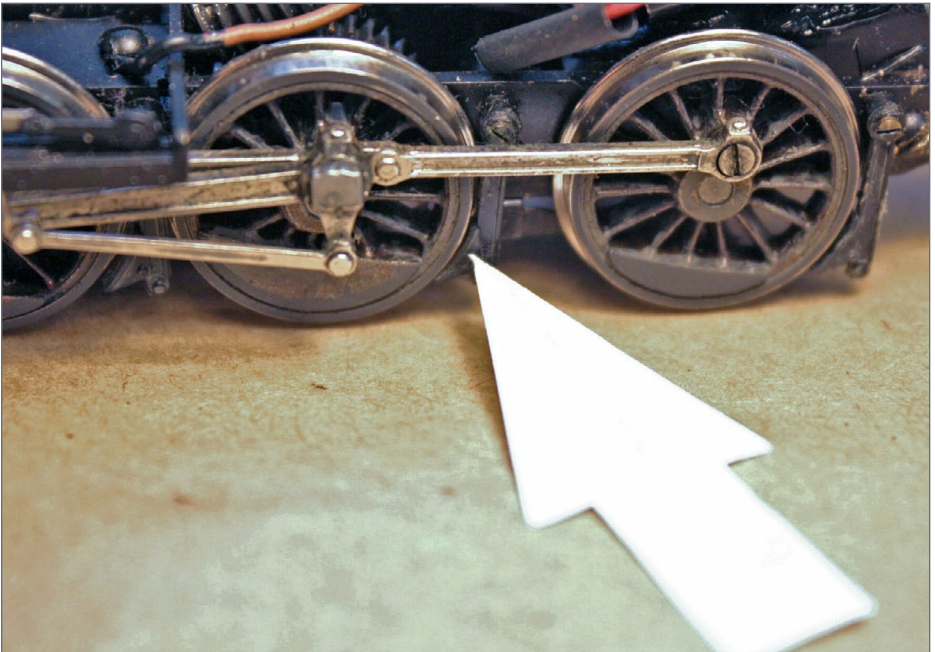

5. The arrow points to a left side metal brake shoe, a common source of short circuits. Newer engines usually have plastic brake shoes instead.

tender trucks sometimes make poor contact with side frames and may need jumper wires soldered from the left side frame to bolsters using small stranded wire [4].

#### **4. Intermittent shorts**

Most shorts occur on the left side of the engine, the side with insulated wheels, and often when making left turns. Using an ohmmeter, turn the engine upside down and with one meter lead on the frame. Make sure you do not have continuity to any wheels on the left side. I have seen people assemble an engine and get one driver pair installed backwards.

Check the drivers and wheels. Drivers and wheels out of gauge can short out at switch points with solid frog switches. Metal driving wheel brake shoes on the left side are a common source of short circuits. A low pilot or footboard, front or rear, can touch a rail causing a short at changes in track grade.

On small engines: Look for lead truck shorting to cylinders, or left-hand metal brake shoes touching a driver [5].

On large engines: Check for left side leading or trailing truck wheels touching the truck frame. Fix by putting insulated spacer washers on axle ends. Lead truck wheels on the left side can touch the underside of the cylinders. Tape or grind away part of the cylinder to fix it.

Other possible causes are left-hand driver brake shoes, a drawbar loose and touching the loco frame or trailing truck. See the section on drawbars (page 14). A missing washer on a side rod crank pin can occasionally allow a side rod to touch an insulated driver tire. Piping out of place can touch the left-hand driver tire.

If the drawbar is in the short hole, make sure the cab isn't touching the tender in curves. If all else fails, run the engine in a darkened room at a good clip and look for sparks on the left side. Insulated drivers shorting out is very rare, but I have seen a shorted driver caused by a tire pressed too far on the axle.

Fine metal particles in the insulated gap can also cause a short. If you suspect a shorted insulated driver, check it with an ohmmeter to be sure. A strong magnifying glass can be a big help in finding the actual short in a wheel, and most times you can fix it yourself. Removing an insulated tire is not recommended. They are very difficult to get back on straight without a special jig.



## INTERMITTENT DERAILING

The leading and trailing trucks must have enough vertical movement, both above and below the railhead plane, to follow any uneven track profiles or they will derail. Also check the wheel gauge. Horizontal movement of the truck must be free to get around any curve without binding on piping, frame, or the drawbar.

Excessive lead truck spring pressure can lift the front drivers off the rails and cause strange derailments. Assuming the loco is sprung, many times driver springs are uneven so not all wheels touch the rails. A binding drawbar can also cause weird derailments, as it can lift the tender or the rear of engine up off rails. It can also prevent enough movement on curves.

*“The leading and trailing trucks must have enough vertical movement.”*

## DRIVER SPRINGING

Driver springs are tiny and are very easy to lose. Once inserted they usually stay in place but when you remove the bottom plate holding them in, they can fall out and get lost. A dab of grease can keep them in place as you reassemble the drivers. Some engines have springs that are way too stiff. Pacific Fast Mail (PFM) engines are probably the worst offenders. If you need replacement springs, I recommend NorthWest Short Line’s “Wimpy” springs.

## BRASS STEAM ENGINE REPAIR | 13

Sprung engines pull better than non-sprung engines because locomotives should have all the drivers contacting the rails at all times. But if the springs are too stiff, jammed, or missing, it's not going to pull well. While you have the engine upside down with the bottom plate off, check that all drivers move up and down freely in their pedestals, the guides in the frame. If not, file them smooth after removing the driver springs.

When all the driver bushings and springs are inserted properly and the bottom plate is back on, place the engine on a hard smooth flat surface and be sure that all drivers touch. You can check this by sliding a thin strip of paper under the engine. If the gap is more than a few thousandths of an inch, something is askew or assembled wrong and should be fixed.

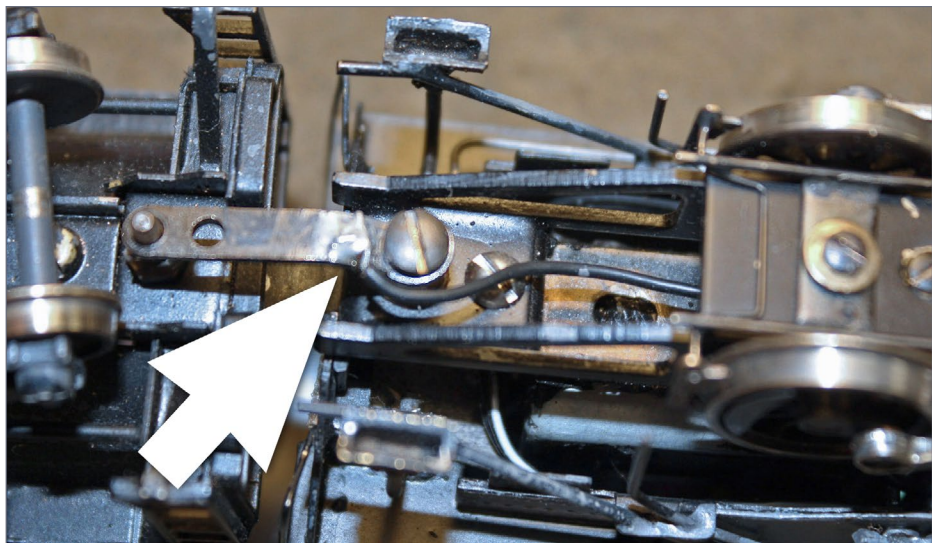

6. This picture illustrates how the power wire from the drawbar is soldered to the drawbar itself, to eliminate possible poor connections in the drawbar screw and spring.

## DRAWBARS

I think at least half of the locos I've worked on had something wrong with the drawbar. Because they have plastic or fiber washers and spacers, they are subject to wear and damage, especially on big engines that pull heavy trains. They are probably the most critical electrical part on the engine, especially if it has a decoder installed.

The drawbar must swivel freely, the spacers must be snug, and drawbar electrically isolated from the frame. It must be straight and parallel to the rails, so it can slide up and down freely on the tender stud without binding. The contact wire must be securely soldered so it gives medium pressure on the stud at all times but still allows easy movement.

The bar itself must ride around mid-point on the tender stud so it can move up and down without coming off or lifting the tender off the rails. In extreme close quarters I have cut the coil spring in two and put the drawbar between the two halves. You can solder the motor lead right to the drawbar itself. If you do this, make sure you don't unsolder the contact wire [5]. This eliminates the drawbar-to-screw touching as a source of a poor connection.

## FOUR-WHEEL LEAD AND TRAILING TRUCKS

Trucks have, in rare cases, been out of tram, meaning the axles are parallel but not at right angles to the track [7]. When this happens, the wheels will not roll down the rails straight. They will be at a slight angle to it. For example, they will take a left curve just fine, but stumble and derail on right turns, or vice-versa. You can check for this by putting a steel ruler along the backs of two wheels making sure the ruler fully touches



both wheels at the same time. Out of tram is usually caused by faulty assembly at the factory, but in most cases the truck frames can be bent to get them back in alignment. Four-wheel lead or trailing trucks must not be twisted. They must have all four wheels sitting squarely on the rails or they will derail.

## VALVE GEAR

Many times a bind in valve gear or side rods is caused by the crosshead hitting the side rod on the lead driver [8]. Sometimes the cylinders can get knocked out of alignment to a point where the crosshead guides are not centered, giving little or no clearance between the side rods and the crosshead. This can be easily checked from the underside. Make sure the guides are equidistant from the side rods on each side. On most engines, the cylinder saddle assembly can be loosened and realigned. The crossheads must slide free in their guides, eccentric rods must not hit the crank. Crank pin screws often come loose and back out, protruding just enough to jam against other parts.

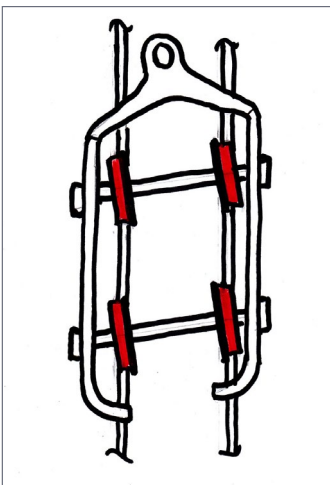

7. Pictorial, exaggerated, of a four wheel trailing truck "out of tram." Note how the wheels do not roll straight on the rails, which will cause derailments.

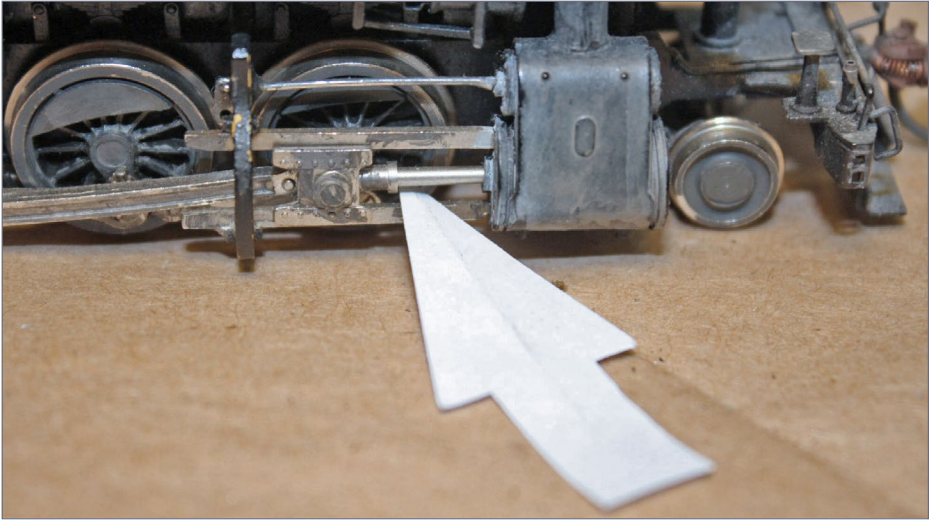

8. The arrow points to a common source of interference between the sliding crosshead and the side rod and pin behind it. Careful positioning of the cylinders and alignment of parts will usually cure the bind and jamming.

## MALLETS

Mallets are really just two engines under one boiler but they can be cumbersome to troubleshoot when it comes to drive and propulsion parts. If all else fails, remove the front engine, or rear if it's a cab-forward, and run the front engine by itself. If it's OK, the other one is at fault. The criteria is that the front engine, under the smoke box, must have a small amount of vertical movement like 1/8" to 3/16", to allow for uneven track, but all drivers on both engines must still sit firmly and squarely on the rails, ideally with about the same amount of weight on both.

Real mallets had a large shoe on the underside of the boiler that rode on a sprung guide on the frame, called the "waist

## BRASS STEAM ENGINE REPAIR | 17

bearer,” to support the front half of the boiler as the articulated front engine pivoted on curves [9]. Most models have these although some are pretty crude. HO mallets will track better and pull more when both engines carry their share of the boiler weight. Some of the larger mallets have a screw on the underside to adjust this. Do not increase the weight on the front engine to the point where the rear engine no longer has all its drivers firmly on the rails.

Mallet drives must have U-joints that do not bind. They must be able to move freely, and they must be kept lubricated with light grease [10]. I have seen noisy drives that turned out to be worn bushings in the front drive shaft to the articulating joint. Happily, they were the same size (3/32”) as the bushings in

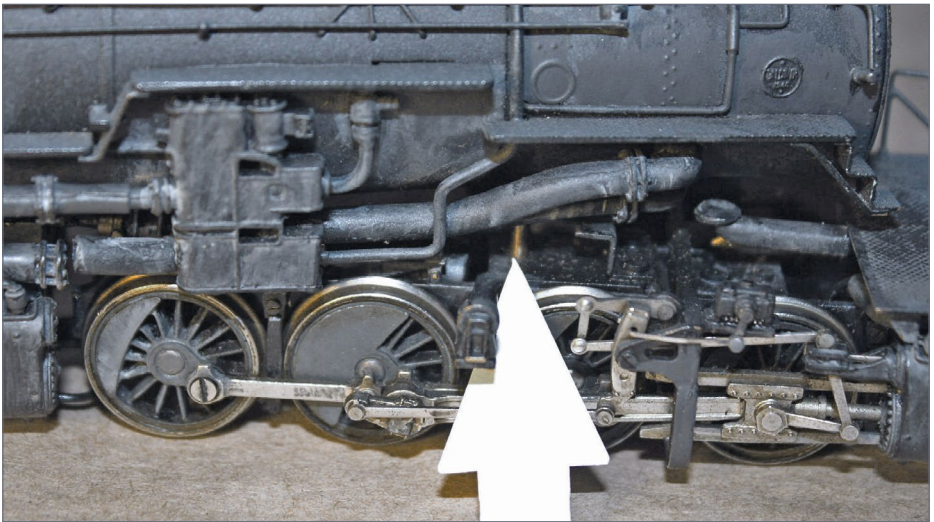

9. The arrow is pointing to the area of the sliding waist bearer, which supports the section of the boiler over the articulated engine. This is a Katsumi SP cab-forward. Smaller Mallets may have a less sophisticated arrangement.



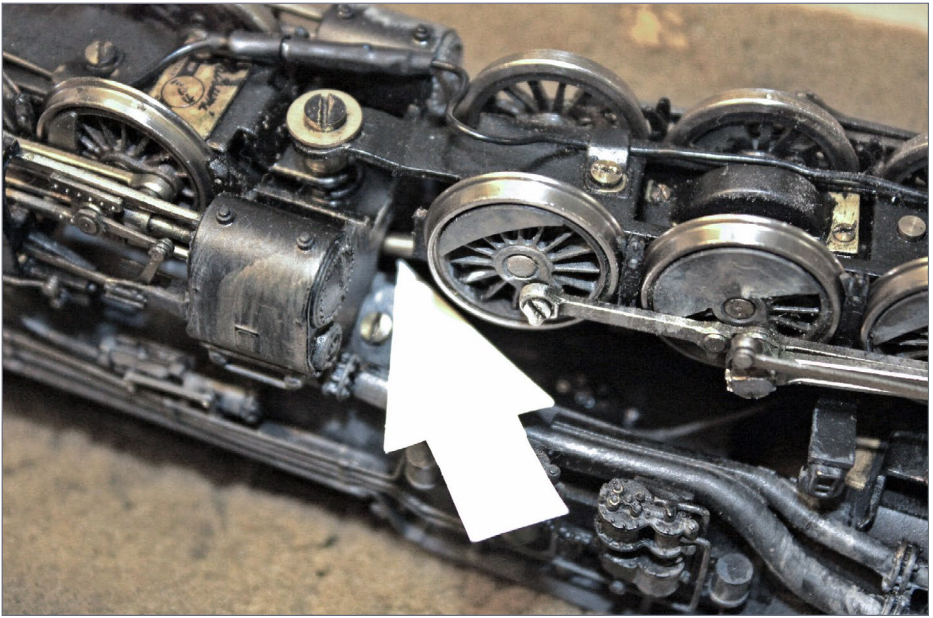

10. The arrow shows the location of a Mallet U-joint, often the source of poor performance and annoying noises.

old open-frame motors and I was able to find one that fit very nicely, eliminating the noise.

For a big engine like a cab-forward or 2-8-8-2, try to keep the engine weight just at or under 24 ounces. Adding more and more weight will not give more pulling power; the motor will work harder just pulling the loco itself and it will actually pull fewer cars rather than more.

### MOTOR REPLACEMENT

Replacing an open-frame motor with a can motor is not difficult on an engine with a gearbox and the usual flex coupling. Modern can motors have more torque than an open-frame motor and it will make a huge improvement in the way the

## BRASS STEAM ENGINE REPAIR | 19

engine runs. After removing the old motor, select a motor that is as large as will physically fit into the boiler. Test-fit it onto the motor mount or frame, holding it in with a rubber band. Some motor swaps on small engines can require a bit of metal work and cutting around the firebox to squeeze it in. Make sure you can get the boiler down over the motor!

Ideally, you want the motor shaft within about 3/8" of the worm shaft in the gearbox. Any longer than this will cause excessive vibration at all but very low speeds. Install a new flex coupling, preferably out of neoprene tubing. Model airplane fuel hose works fine, and make certain that the motor and worm shafts are in a straight line. Also, the motor must be straight longitudinally.

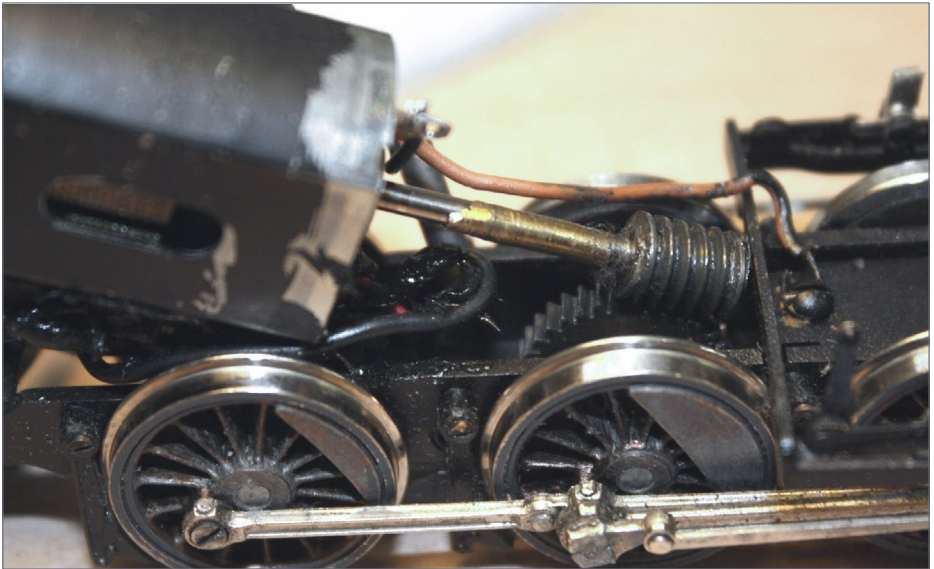

11. A close-up of a can motor that has been fitted with a shaft extension. This engine, a PFM 4-6-0, is not sprung and does not have a gearbox.

I usually mount can motors with silicone RTV allowing it to cure overnight. It holds firmly but the motor can be removed if necessary without breaking anything. In some cases I've had to fabricate a motor mount out of brass and bolt or solder it to the frame. If you go this route, try to bolt the mount to the front of the motor rather than the cab end. It will make a much more solid mount.

Installing a can motor can get complicated on a loco without a gearbox. One solution is to make a shaft extension on the new motor the same size as the old shaft and press the old worm onto it [11]. The problem here is that the new motor usually doesn't have the same size shaft as the old motor and some adaptation is needed. Most open-frame motors had a 3/32" shaft but can motors are almost always some smaller metric size.

**CAUTION:** If you make a shaft it must be absolutely straight. Use telescoping pieces of brass or aluminum tubing and epoxy them together. Make sure it has no wobble or run out or it will be very noisy, vibrate excessively, and wear the gear and worm rapidly.

You can also install a new gearbox, but this entails removing the driver pair, pulling off the right hand wheel and the old gear with a puller, then pressing on the new gear and pressing on the driver, making sure it is in "quarter," normally done with a quartering jig. Driver axles are not all the same size so you will need to measure your axle when you order the new gearbox. Northwest Short Line has many replacement gearboxes.

### RESURRECTING OLD BASKET CASES

When the old foam rubber in the box has deteriorated into a big mess and gummed up the engine, remove the motor and put the engine through one dishwasher cycle. Be sure to lubricate it



afterward. Soaking the boiler, but not the running gear, in diluted ketchup or tomato sauce overnight will make it look like new.

I hope this article has been helpful and informative and will get your brass engines out of the shop and back on the high iron!

 [Click here for reader comments](#)

---

## BOB BATTLES

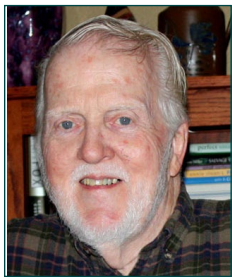

Bob grew up around the Western Pacific railroad as his father was an agent and telegraph operator in such places as Shafter, Nevada and Hawley, California. He joined the Navy and learned electronics, working on aircraft avionics.

After his discharge he worked as a field engineer on large IBM mainframe computers for 25 years and later as a Field Tech on large credit card embossing equipment. He got into model railroading in 1964 and enjoys HO, HO<sub>N3</sub> and even HO traction. He did HO repairs and decoder installs for Just Trains Hobby Shop in Concord for 14 years and is also an active member of the NWP Railroad Historical Society. He is retired, married with two grown children, two grandchildren and lives near Santa Rosa, California. ■

---

# BRASS EXPO



## BRASS MODEL TRAINS ALL SCALES

April 11-12, 2015 • Saturday 9-4 • Sunday 10-4.

Maryland State Fairgrounds • 2200 York Rd. • Timonium, Maryland 20193

---

For More Information Go To:

[www.brassexpo.com](http://www.brassexpo.com)

---

HOWARD ZANE

5236 Thunder Hill Rd • Columbia, MD 21045 • 410 730 1036

email: [hzane1@verizon.net](mailto:hzane1@verizon.net)

VISA AND MASTERCARD ACCEPTED

BRASS EXPO WILL RUN TANDEM WITH  
THE GREAT SCALE MODEL TRAIN SHOW

# Southern Pacific's *GE Dash 7s Part 1*



BY JEFF SKINNER  
.....

## **BEING A SOUTHERN PACIFIC MODELER PROVIDES**

many options of locomotives to model. I have always been a fan of the General Electric (GE) models, and decided to model the GE B36-7. The Southern Pacific purchased 16 B36-7s in 1984 and they were delivered with all the typical “Espee” options of the time. The initial assignment for these units were intermodal trains on the Sunset Route.





## *In-depth on how to detail a GE diesel for the SP*

While researching the prototype B36-7, I discovered various differences with the General Electric 4-axle Dash 7 line. Since the Southern Pacific and its subsidiary Cotton Belt had all three Dash 7 models, I have provided information on each model's specific details. You can use this information and some of my processes to create reasonable replicas of each model.

A description of the different wheelbases and phases follows.

## Wheelbase and phases

Models (Production dates)	Length	Wheelbase	front pilot to front bolster
U23/25/28/33/36B	60' 2"	36' 2"	12'
B23/30/36 dash 7 Phase-1 (Early '77 into spring '79)	58' 4"	36' 2"	11' 1"
B23/30/36 dash 7 Phase-2 (Spring '79 to fall '80)	58' 4"	37' 2"	11' 1"
B23/30/36 dash 7 Phase-3 (Fall '80 to end of production)	57' 4"	36' 8"	10' 6"

## General detail summary

Model	Phase	Built	Window	Air Filter	E Loc
SP B23-7 5100-5114	1	1980	L-Shape	Salem Medium Sized DW AF225 front and rear	Rig
SP B30-7 7800-7823	1	1978	L-Shape	Salem Medium Sized DW AF225 front and rear	R
SP B30-7 7824-7883	1	1979	L-Shape	Salem Medium Sized DW AF225 front and rear	Rig
SSW B30-7 7774-7799	2	1980	L-Shape	Salem Medium Sized DW AF225 front and rear	Rig
SSW B36-7 7770-7773	2	1980	L-Shape	Salem Medium Sized DW AF225 front and rear	Rig
SP B36-7 7754-7769	3	1984	Standard	Salem Large rear DW AF226 Salem Small front similar to small filter in DW AF139	Rig

rear pilot to rear bolster
12'
11' 1"
10' 1"
10' 2"



**Click here for reader comments**

Bell Location	Roof Hardware	Exhaust	Rear Light	Antenna
ht Sill	Warning Light, A/C, Antenna Ground Plate, Antenna	Large	Twin Sealed-Late	Sinclair
Roof	Warning Light, Antenna	Small	Embedded in body	Whip
ht Sill	Warning Light, Antenna	Small	Embedded in body	Whip
ht Sill	Warning Light, A/C, Antenna Ground Plate, Antenna	Large	Twin Sealed-Late	Sinclair
ht Sill	Warning Light, A/C, Antenna Ground Plate, Antenna	Large	Twin Sealed-Late	Sinclair
ht Sill	Warning Light, A/C, Antenna Ground Plate, Antenna	Large	Twin Sealed-Late	Sinclair



## SP B23-7

5100-5114 B23-7, 14 units, ordered in 1979 and delivered in the first half of 1980.

## SP B23-7 specific details

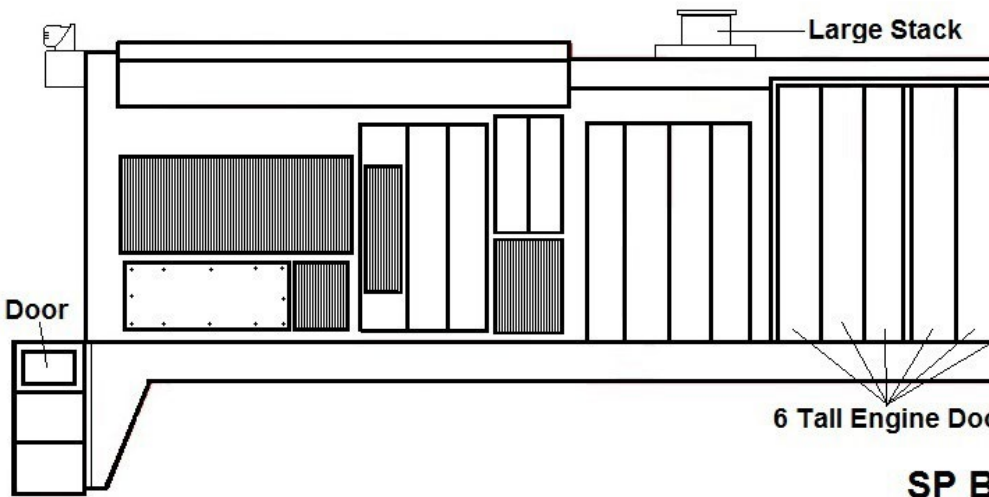
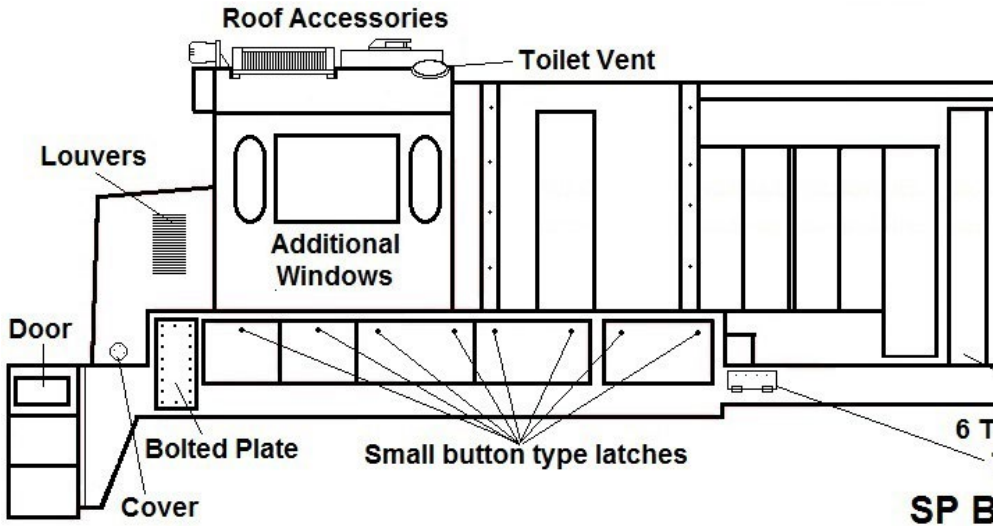

## 1-2. Specific details of the SP B23-7.

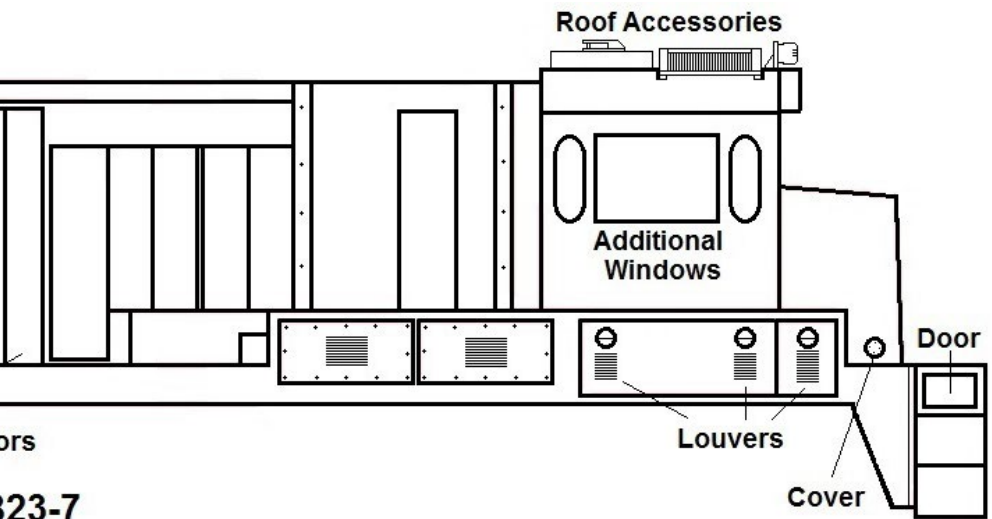
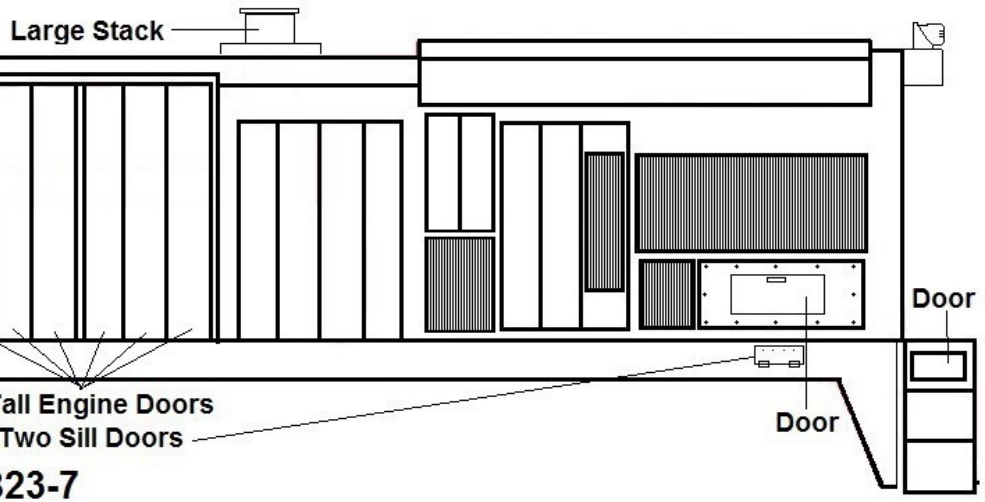

## SP B30-7

7800-7823 B30-7, 24 units ordered 1977 and delivered in 1978. 60 additional units ordered in 1978 and delivered in 1979. Number 7810 was destroyed in a wreck in 1979 and removed from the roster.

## SP B30-7 specific details

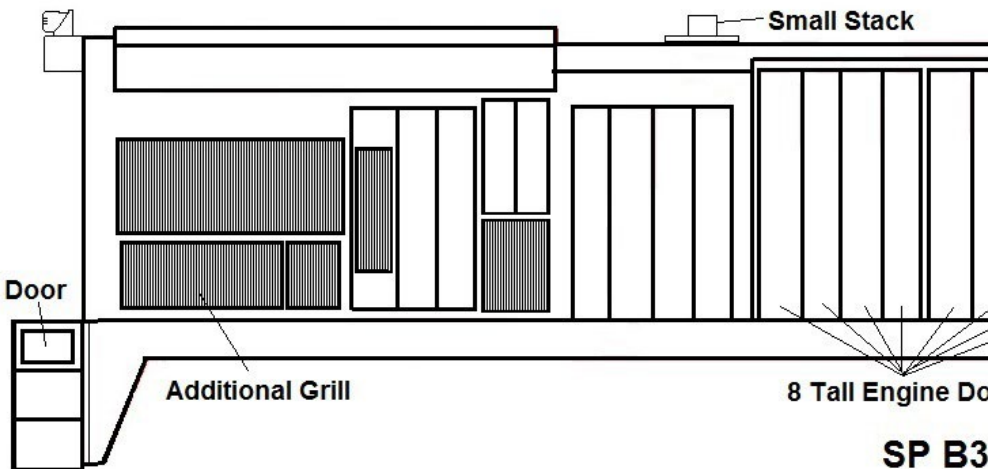
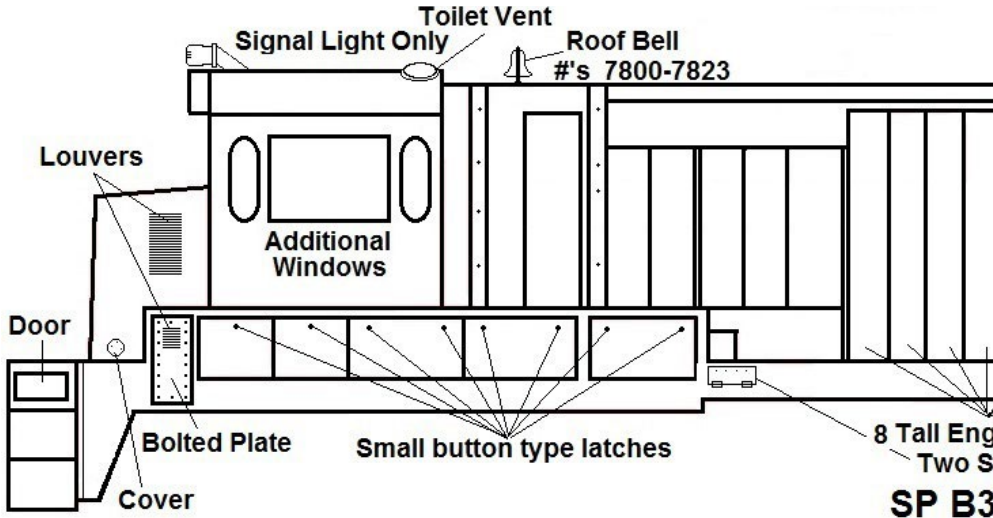



## 3-4. Specific details of the SP B30-7.

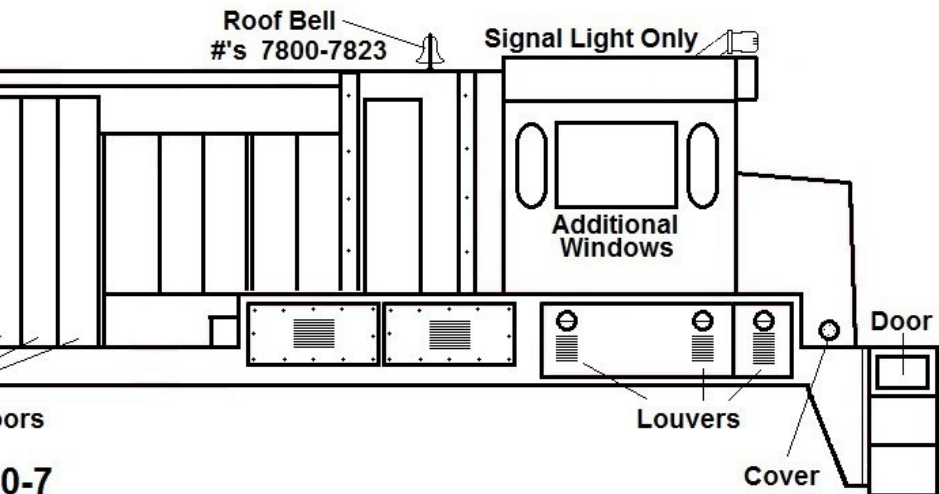
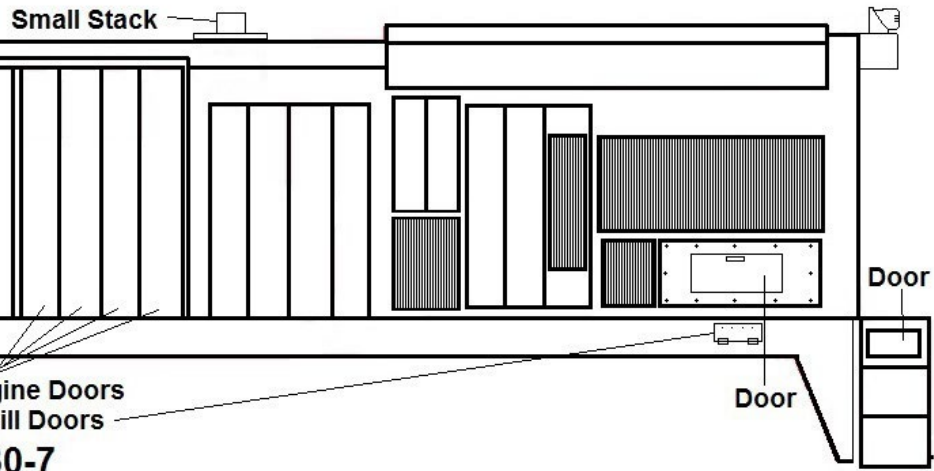

## SSW B30-7 & SSW B36-7

7770-7799 B30-7, 30 units ordered 1979 and delivered in 1980. Units 7770-7773 were delivered with a 3600-HP test bed configuration. After a year of testing in Southern California they were

## SSW B30-7 & SSW B36-7 specific details (both models externally identical)

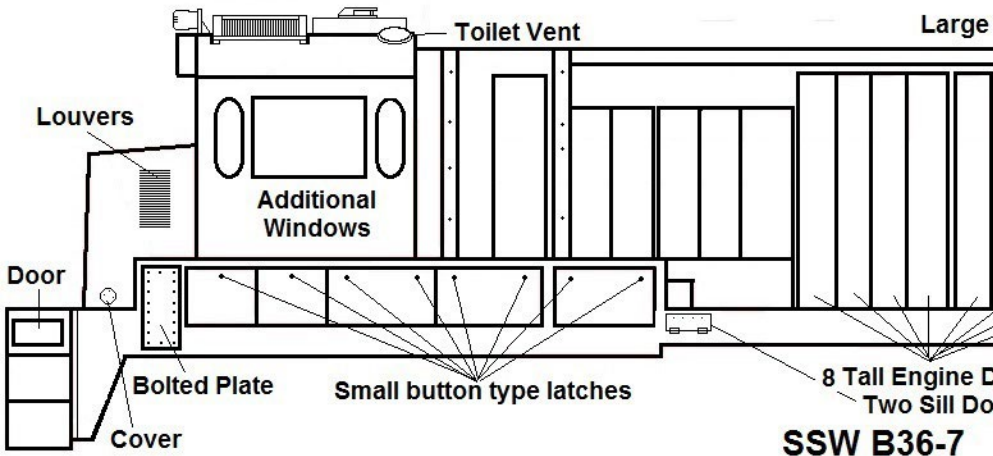
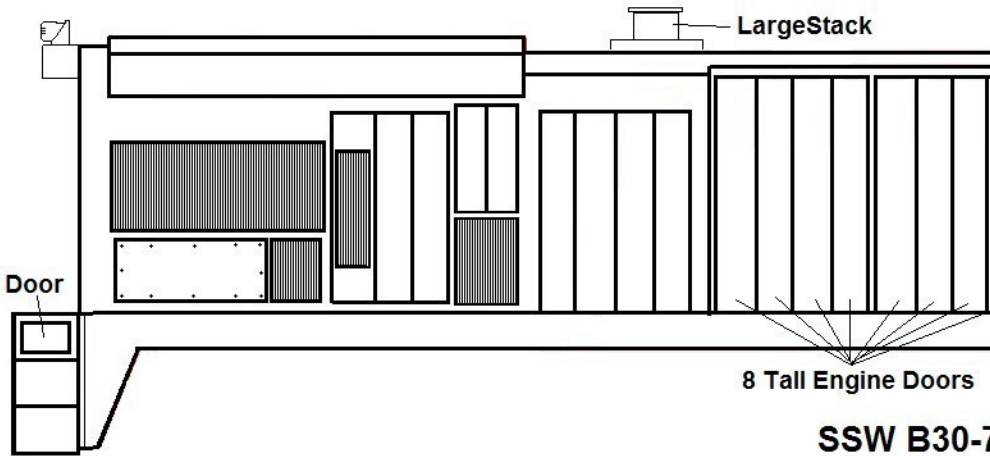

# SP's GE DASH 7 | 10

to be de-rated to 3000 HP and assigned to Pine Bluff. All information I have read, it seems they remained 3600 HP. Number 7771 was involved in a wreck early in its career and was rebuilt as a cabless or "B" unit.

## 5-6. Specific details of the SSW B30-7 & SSW B36-7.

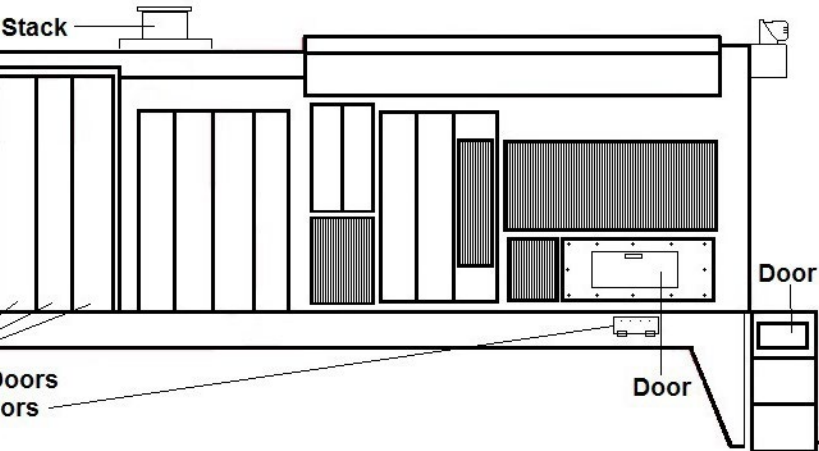
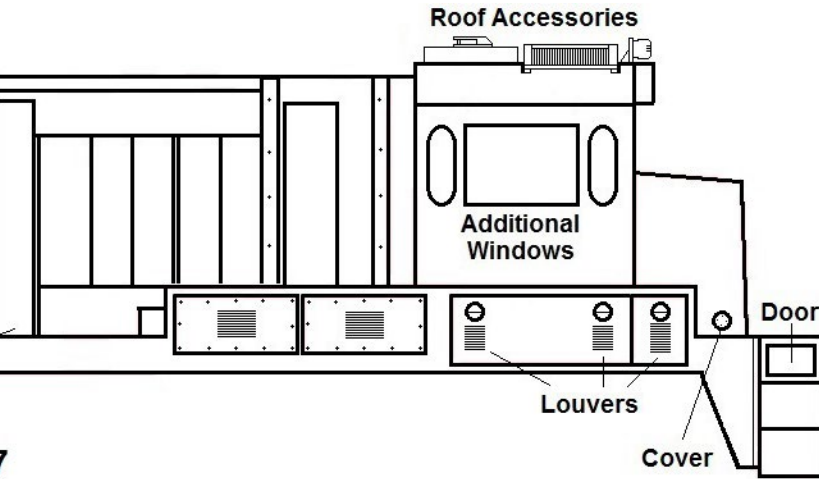



## SP B36-7

7754-7769 B36-7, 16 units numbered ordered 1984 and delivered in early 1985. It appears the standard-issue horn is the Nathan P3. But at least two units carried two sets of Nathan P5 horns.

## SP B36-7 specific details

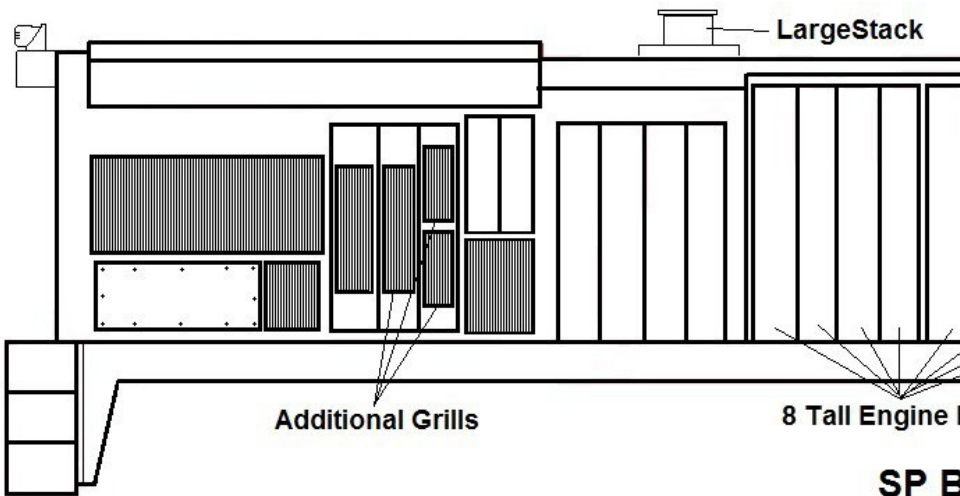
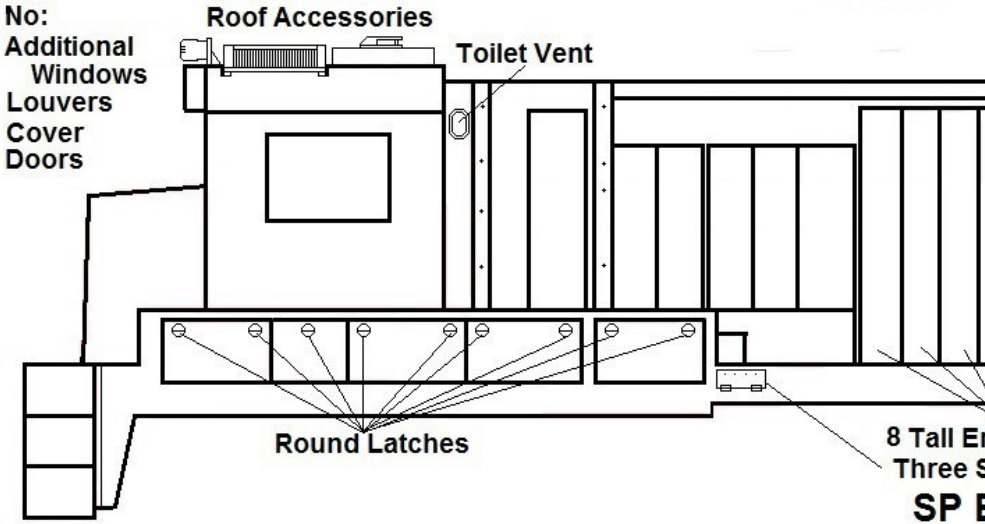

# SP's GE DASH 7 | 12

One is positioned on the roof behind the cab, the other on the rear end behind the radiator.

One other note of interest – the various equipment doors beneath the cab are interchangeable and, after maintenance,

7-8. Specific details of the SP B36-7.

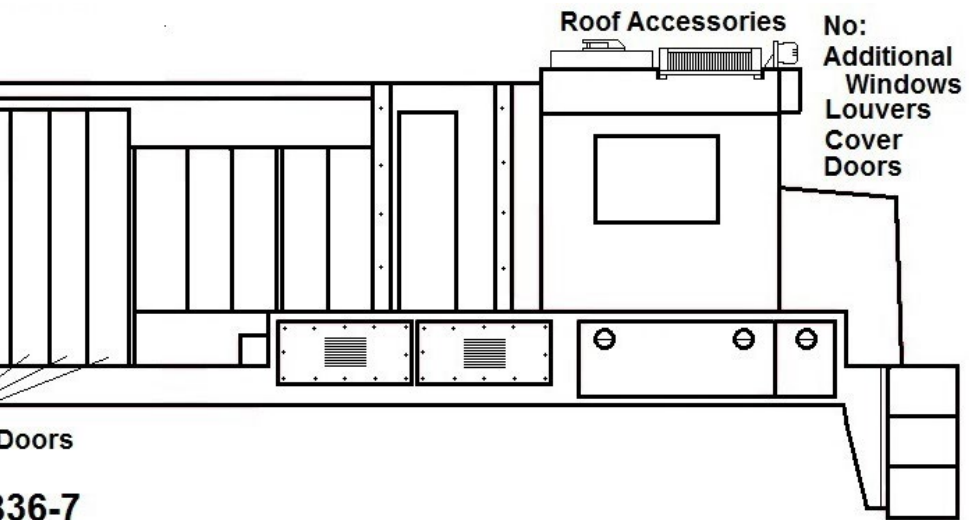
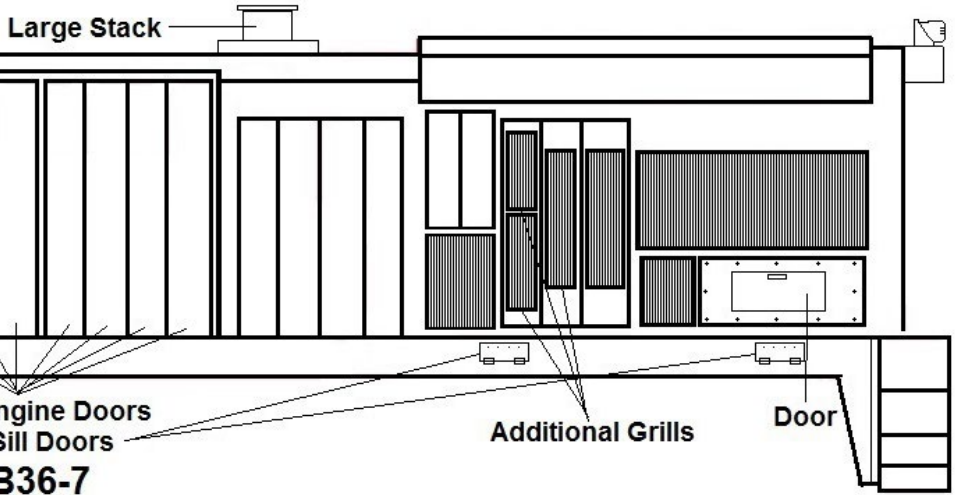

the original door may not have been returned to the original locomotive. Check photos of the unit you are modeling, as it can have any combination of louvers on the doors.

After this research and looking through my materials, I decided to use an Athearn B boat chassis and a damaged Rail Power Products (RPP) B23-7 shell I had on hand. The Athearn chassis has a wheelbase of 36' 2". You can stretch the wheel base a scale 6", 0.069", but I concluded I could live with the slight difference in the wheelbase.

## Cutting

I started by cutting horizontally under the front nose and rear hood, shown as cut 1 [9]. I then cut the walkway and pilots off with a vertical cut 2 [9], leaving the pilot and steps as one piece. I removed a scale 6" off this piece at both ends and re-glued the walkways back on. Little splices of 0.015" styrene were used to fill in the amount the saw cut removed. Once glued together, the length has been shortened by one foot. Another detail of note – the angled portion next to the steps is 12" at the top on the SP B36-7, but on the RPP B23-7 model it is 17". I shaped these items to this dimension at this time, removing the gray areas [9].

After the cut and reassembly, I fit the shell on my modified Athearn chassis (see chassis below for details). I slid the chassis until the front jack pads lined up with the front bolster. The rear jack pad was about a scale six inches farther from the pilot than the bolster; [11] is an example of the fit. Since I was scratchbuilding new jack pads, the offset could be compensated.

I cut 2.643" from the hood "step" forward toward the cab of the locomotive [12]. A piece of 0.060" styrene is used for the new roof. I carefully sanded it to the same profile, matching that of the existing roof.

Next I filled in the door areas that had been cut out. The RPP side is 0.050" thick. Since I was planning to use Cannon doors, I put a



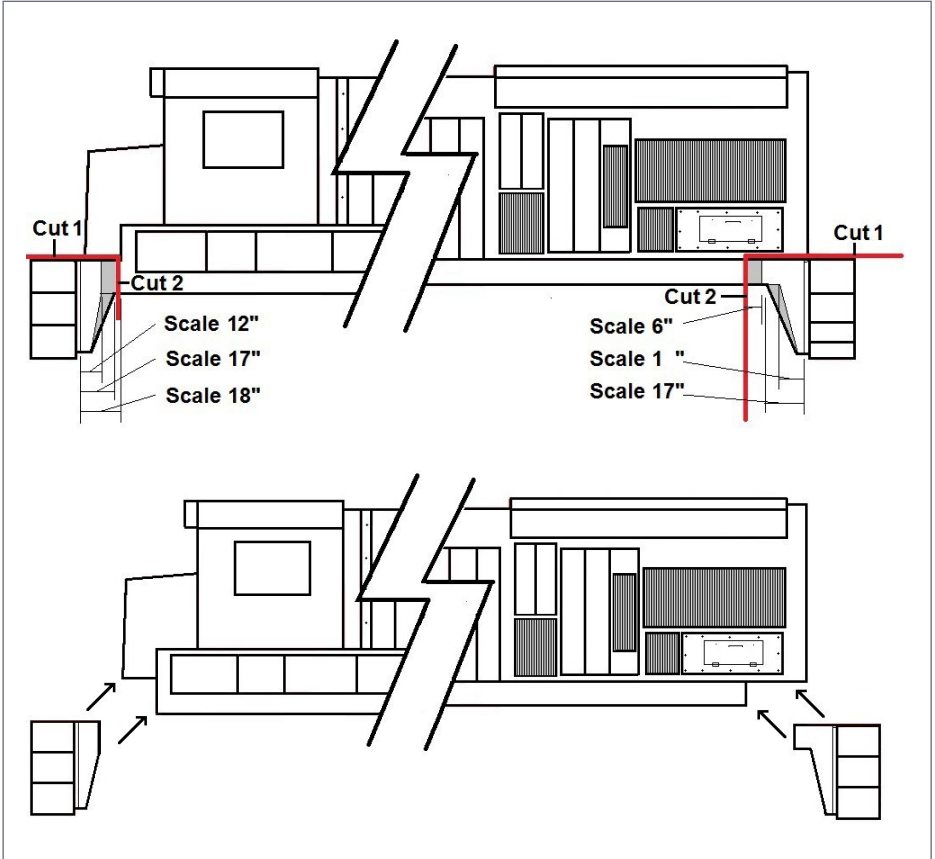

9-10. Cuts to the model.

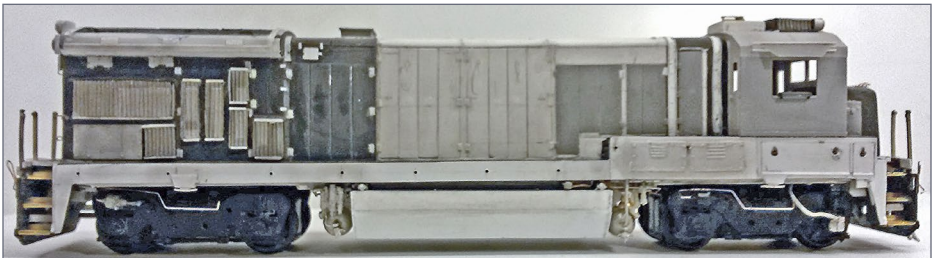

11. An example of the fit.

piece of 0.030" in and left the remaining 0.020" to be filled in with doors. I kept the doors on the rear sides but sanded off the RPP hinges and latches. I also sanded off all the details located on the rear end of the hood.

## Hood sides

When I began adding the doors, I hit another snag. After looking at prototype pictures from various sources, I discovered the doors were not a consistent width and with no real pattern. However, a convenient detail is the locations of the doors are the same on both sides of the body.

I proceeded to lay out the door configuration on paper and came up with the following: Conductor's side from the hood step toward the cab, 0.020" divider, four full-height doors, 0.040" divider, four full-height doors, 0.040" divider, a ¾ height door, two half-height doors, 0.040" divider, two half doors, a rivet strap, 0.060" wide. There is one last ¾-height door positioned between the two rivet strips just behind the cab.

I settled with the following configuration for door widths starting from the rear hood "step" forward: 16" + 18" + 16" + 18" + 16" + 18" + 16" + 18" + 18" + 16" + 18" + 12" + 18" scale inches [13]. With the conversion chart and a calculator the door widths total 2.503". Sum the

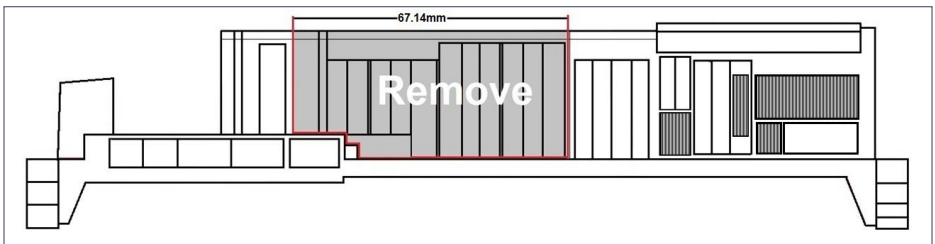

12. Remove this section.

spacers and you get 0.140". Adding the spacer total to the door width total you get 2.643", which is the length cut out of the shell.

I used modified Cannon doors on all doors except the eight all-engine doors. These doors are taller than the Cannon doors. The tall engine doors I built from 0.020" styrene. I used Cannon hinges where I used Cannon doors. The rest of the hinges I used a combination of 0.005" sheet styrene and 0.010" diameter styrene rod [14]. I also used this hinge method for the RPP doors that I did not completely remove at the rear flank of the hood.

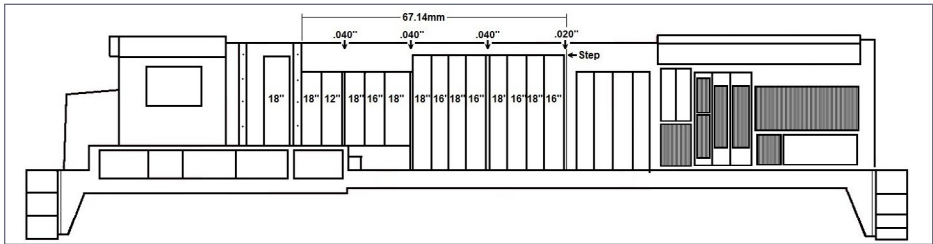

13. Last door.

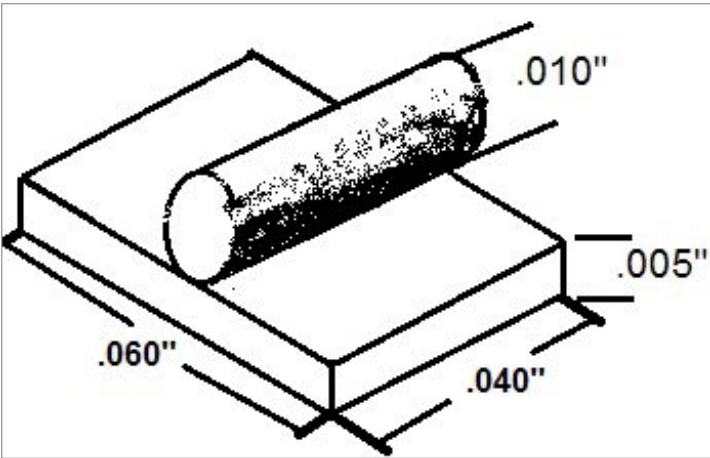

14. Hinges.



I scratchbuilt the single Gyralight bracket and the twin Gyralight box using styrene as shown in [15]. The cast-in door at the end of the hood was replaced with a Cannon door, and I added the SP light package I had previously assembled. I added the blanked-out class lights using pieces from a Cannon nose kit.

I installed new number boards from a Details West (DW) set, add the nut/bolt/washers (NBW) and the grab irons as identified from prototype pictures. Notice the unique grab on the rear corner of the engineer's side [16]. I added the two bottom doors with hinges on the hood end (unique to the SP B36-7) using 0.005" styrene with hinges created using 0.010" styrene rod as shown [14]. I did not add the square 0.005" piece of styrene identified earlier.

## Hood roof

The top of the Dash 7s have access doors that need to be mod-

eled. To create this detail I scored the access door lines on the roof. Next Detail Associates (DA) hinges and lift rings were installed. Since I am modeling a later unit, I replaced the exhaust with a Hi Tech Details late-dash-7 to dash-8 stack.

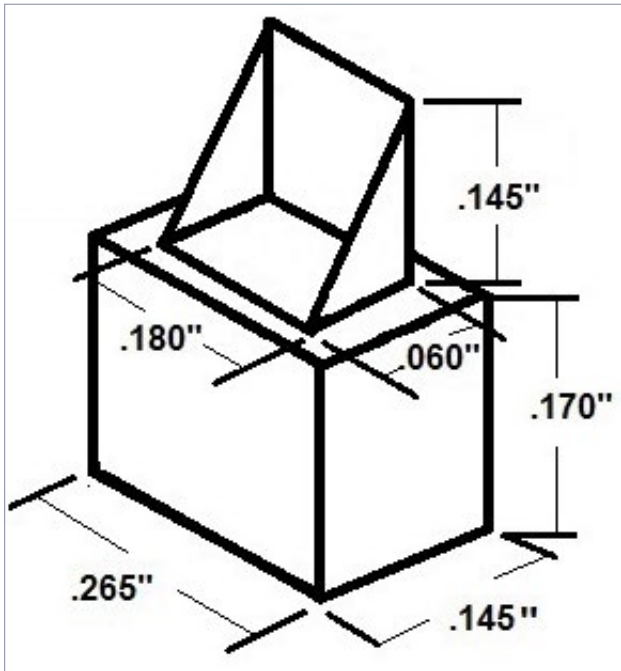

15. Gyralight.

I chose to model a unit with multiple horns, so I added the Nathan P5 horn on the hood just behind the cab on the engineer side. The second horn was placed behind the radiator offset to the engineer's side. Rivet strips that surround the exhaust bracket and the riveted access hatch forward of the roof hatches were added.

## Rivets

I created rivets in two different ways. The first is to press a pin in the back side of the styrene piece. I used this process on the access hatch [18]. Photo [19] is another example on a different hatch.

The second method is to drill holes with a #79 drill bit. Place a small length of 0.010" styrene rod and glue. After it dries, trim it back to give the representation of a rivet. I used this method on the rivet strips on the radiator. Other options are to use commercially available rivets, such as Tichy Train Group styrene rivets or Archer's rivet decals.

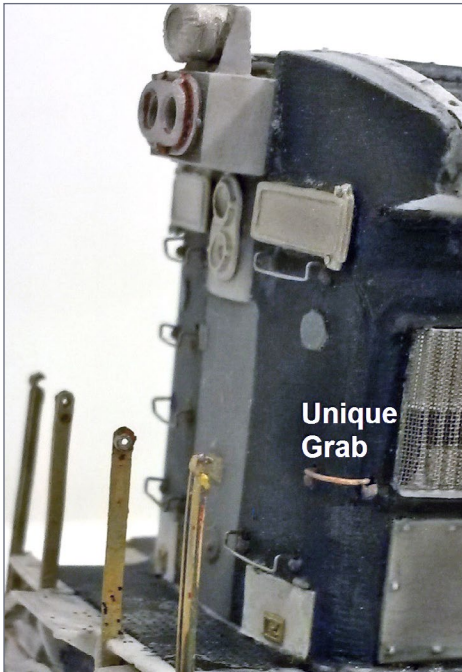

## Louvers

Louvers are a vital detail on locomotives. Louvers can be purchased from different sources that use different materials. Plano produces photo-etched louvers, and Archer produces a decal version of louvers. After using the GE tread from Archer, I will look at that option on my next project.

For this project I came up with a way to model vents that is

16. Unique grabiron.

fairly easy. I lined up and glued 0.010" styrene rod on the surface, spaced equally apart. Once dried, I filed them into the shape of the louver. The louvers in the battery access doors on the engineer's side were made using this technique.

## Nose

The SP B36-7 has no louvers on the conductor's side of the nose. If the shell you are working with has them you will need to sand the area smooth. Next add the late Pyle twin-beam light on the nose with the grab irons as shown [22].

I added the blanked-out class lights using pieces from a Cannon nose kit in the same manner done on the rear of the locomotive [22]. The doors on the bottom of the nose were added in the same manner performed on the end of the hood.

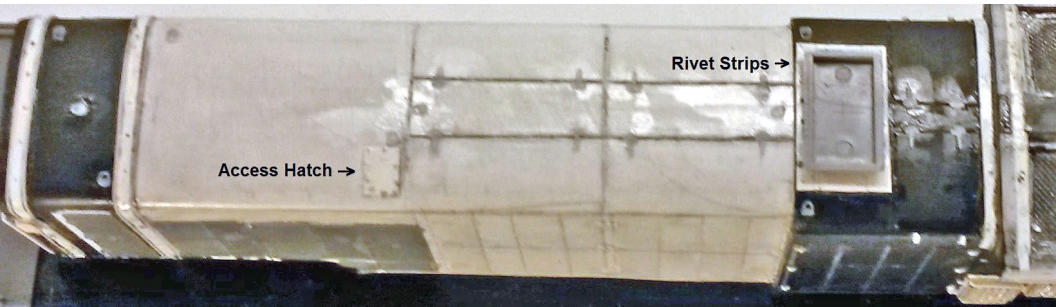

18. Access hatch area.

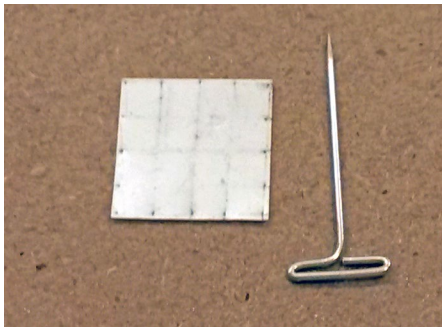

19. A different hatch.



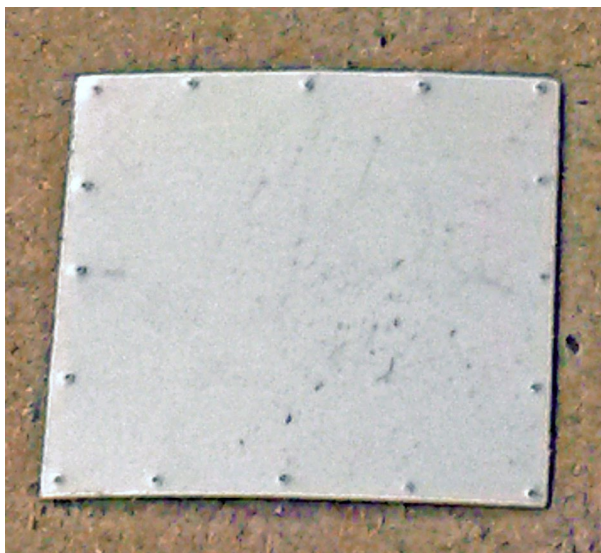

20. Rivet detail.

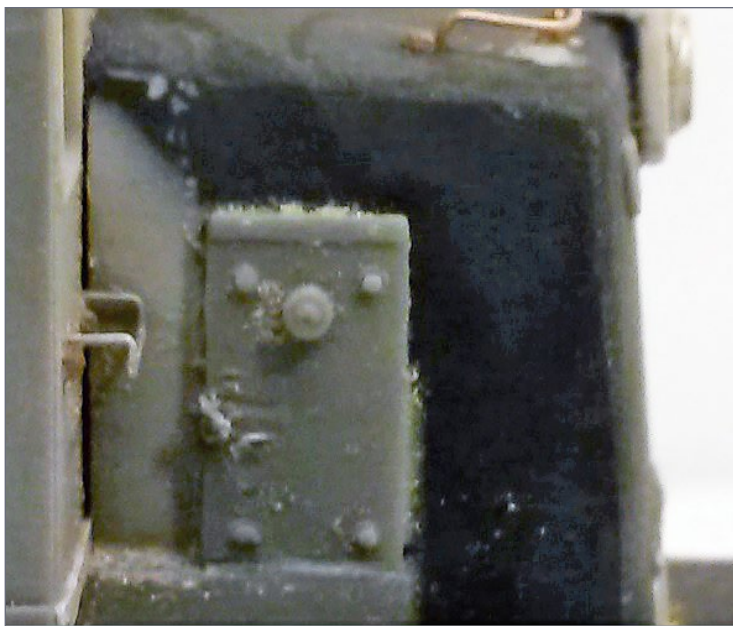

21. Brake.

To create the brake housing, another piece from a Cannon nose kit was used. I sanded the back side of this piece very thin and installed it at the side of the nose [21]. Finally I added the front walkway light centered between the two bottom doors. I used a spare blank class light from the Cannon EMD nose kit and poked a pin hole through the center to represent the light.

To represent the GE Dash 7 door latches, I used cannon dynamic brake door latches. I cut them out along the lines shown [23], using cutters for photo-etched material. I glued the latches on all of the appropriate doors using cyanoacrylate. The excess photo-etched material is good to keep, and I used this kind of material later in this project.

## Under-cab sill and doors

I am not a fan of the RPP details, so I sanded off 0.015" from each sill. I replaced the material with pieces of 0.015" sheet styrene. I cut the shape of the sill on both sides, then measured and cut out the areas where the access doors are located. The configuration of

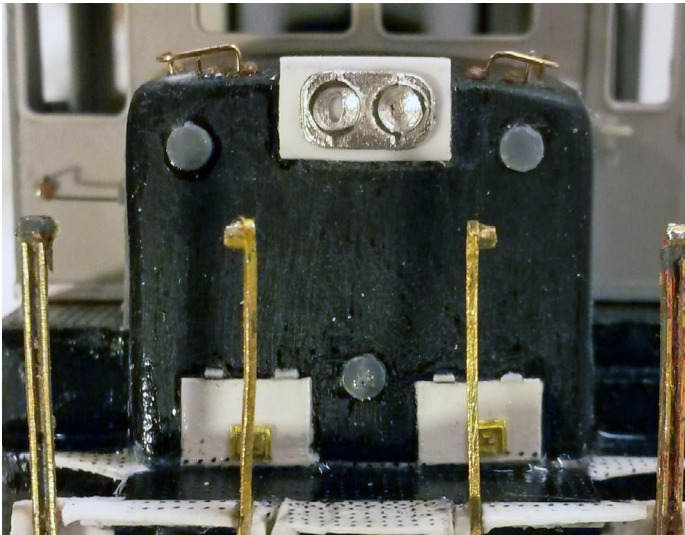

22. Nose.

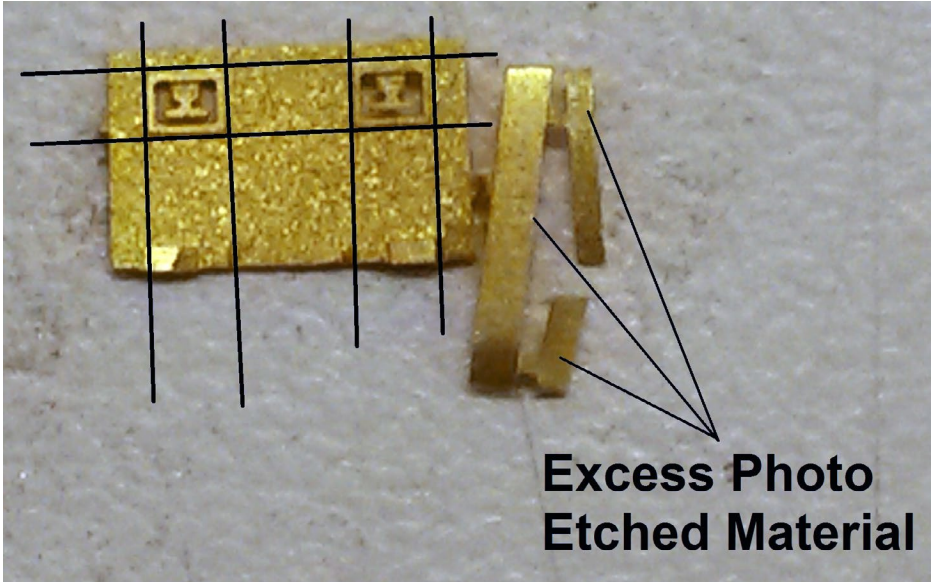

### 23. Hood door latch cuts.

the equipment doors is a little different between the models of the Dash 7. The differences are shown in [1-8]. The doors will be added separately. The prototype doors sit flush with the sides, so I used 0.015" sheet styrene for them.

If you want a little more definition around the door, you can use .020" sheet styrene to raise the door 0.005" above the surrounding side. This creates a raised door surface similar to manufactured models.

Since no models of GE equipment doors are available commercially, they must be scratchbuilt. Cut out the door from 0.015" sheet styrene (you can use 0.020" styrene as described earlier). The doors will be installed in the openings previously cut out of the sills. Once the door is cut, add a 0.020" square styrene strip at the bottom of the doors. File them into a triangle shape more resembling the prototype. To model the hinge on the doors, I cut out the lip and added



0.010" styrene rod to the gap. The graphic below indicates the steps in building the doors [24].

The latches have to be scratchbuilt too. After the doors are installed, mark the location of the latches. The latches are round with a horizontal latch handle in the center. I drilled the hole through the 0.015" door using a 1/16" (.0625") sized drill bit, but only drilled about 1/16" into the RPP shell. After drilling the latch hole, I used a small saw designed for the modeling knife and carefully created the vertical slit at the top of the latch. Figure [25] shows the fundamental shape of the latch hole.

I made the latches from excess photo-etch material (shown previously). I shaped and glued it in the hole to give a reasonable representation of the latch, as [26] shows.

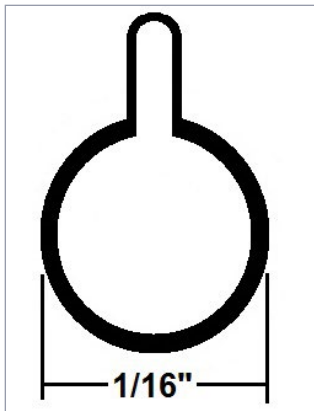
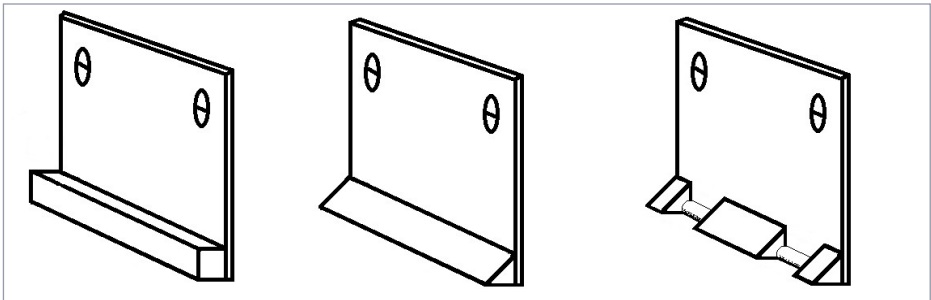

24. Hood door latch cuts.

25 Equipment door latch.

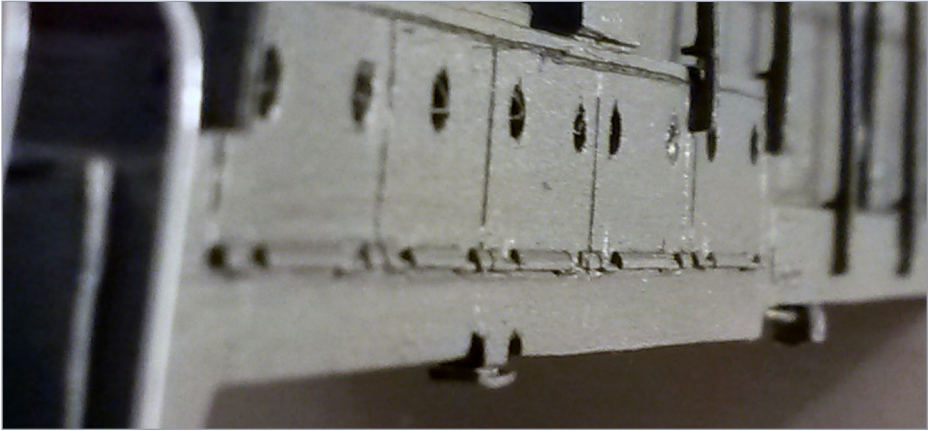

## 26. Equipment doors.

In addition to the equipment doors under the cab, there are three small doors farther back along the sill on the conductor's side. Using pictures, I located the position of the doors and made the doors and hinges with 0.005" styrene. Then I used a pin to create the button latches.

## Pilots

I began by sanding the pilots to remove the cast-in details and reduce their thickness. Since the length of the shell is reduced, the front and rear walkways are shorter. I modified the walkways using styrene over the steps as shown [28a] to match the prototype. Due to the variations of length when the pilots are reassembled, this piece of styrene is a cut-and-fit detail. Next I added the walkway and stanchion configuration on the pilot as shown [28b-28c]. I scratchbuilt the drop step using 0.015" styrene. At this time, I removed the cast steps and installed the A-Line steps per the directions.

Details West scale coupler pocket, hoses, and mu cables were added. Using styrene, I built the lift holes and strengthening plates.

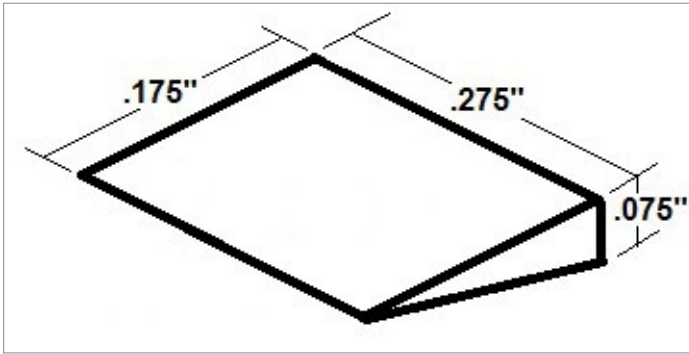

27. Drop steps.  
28A. Pilot.

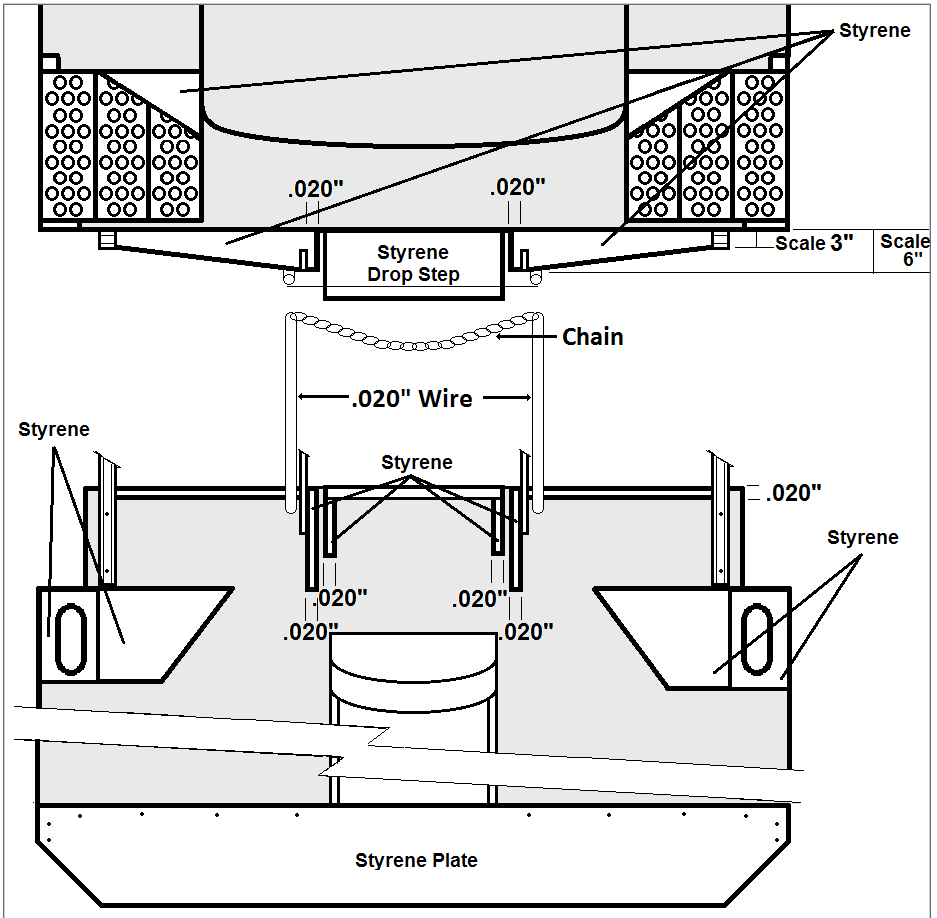



## SP's GE DASH 7 | 26

The pin lifter is installed angled down toward the coupler. This is another unique feature to the SP B36-7. The other Dash 7 models' pin lifters are horizontal. The rear pilot is configured the same as the front except the rear pilot has a steel plate bolted on with Multiple Unit (MU) hose retainers mounted to the plate.

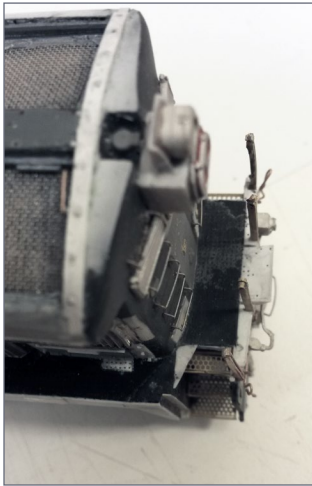
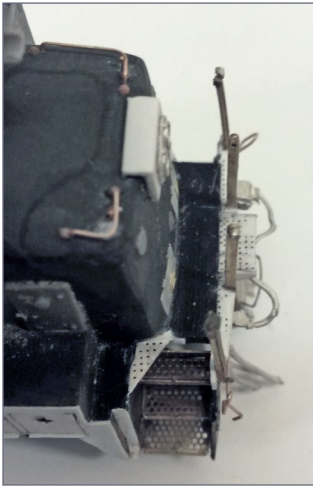

28b. Pilot top-front and top-rear.

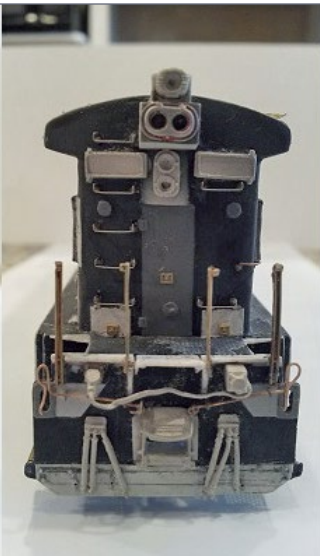

28c. Front and back.

# SP's GE DASH 7 | 27

While preparing the steps for the A-Line etched replacements, I noticed a little door above the top step under the walkway at all four corners. This detail is present on all of the SP/SSW Dash 7s except the SP B36-7 so I removed this too. Photos [30, 31] are from [espee.railfan.net](http://espee.railfan.net).

30. Step door.

31. Step no door.

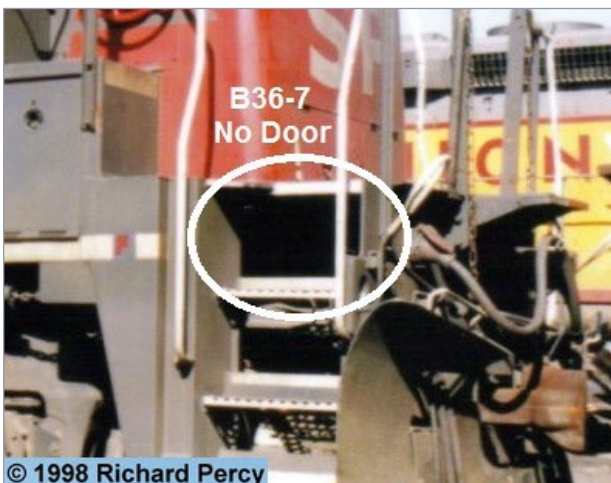

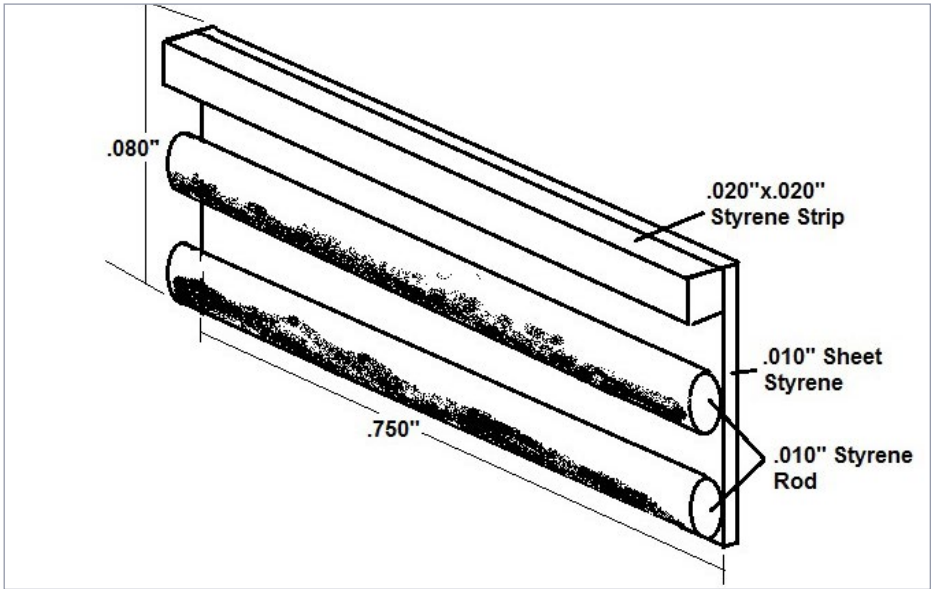

32. Sunshade bracket.

## Cab

I discarded the cab and replaced it with a post-1972 two-windowed cab from Hi Tech Details. The lack of the oval windows common on GE units of that era is another unique detail to the SP B36-7. All previous GE locomotives were delivered with the additional oval windows. I assembled the cab per the instructions provided with the kit. I scratchbuilt and installed the sun shade bracket as shown in [32], then installed the shades.

The cab roof has a vapor air conditioner mounted on a flat portion of the roof. I created the flat portion of the roof by starting 0.040" back from the front wall, and continuing for the length of the air conditioner as shown in [33]. To make this level, I filed through the thin styrene roof. I filled all openings with styrene. Once all openings were filled in, I sanded the additional styrene to blend the



# SP's GE DASH 7 | 29

surfaces. The air conditioner is mounted on two rails, using .015" x 0.020" styrene strips to represent the mounting rails.

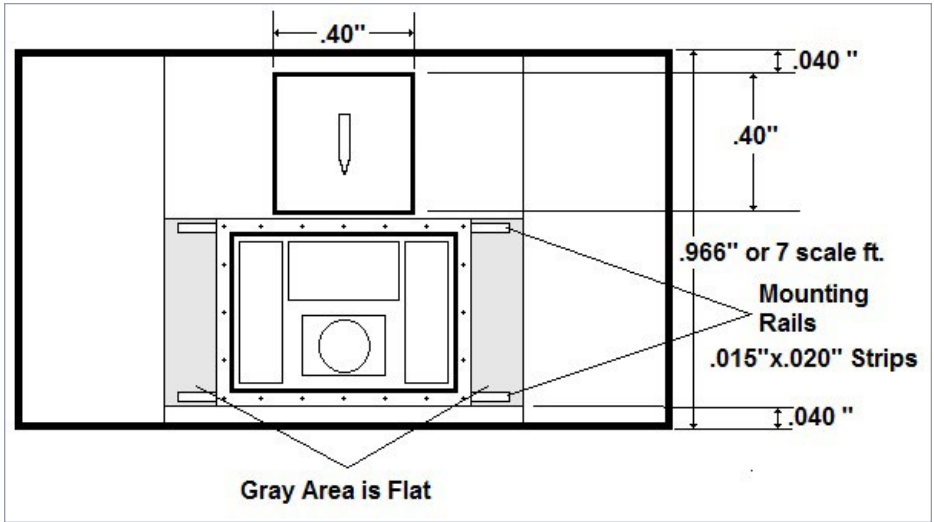

33. Cab roof.

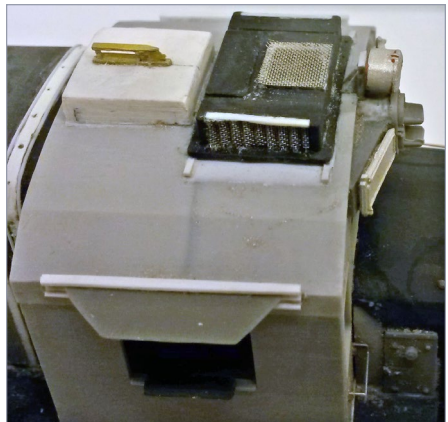
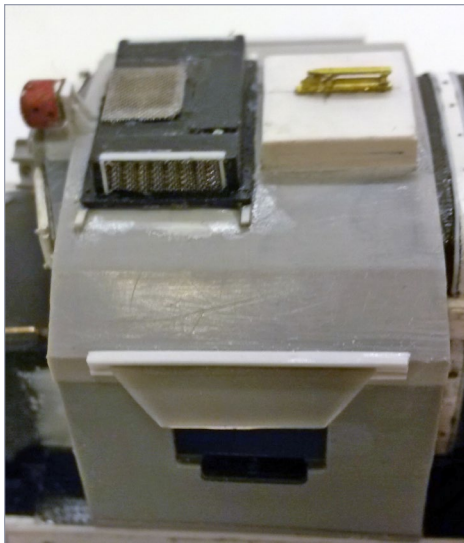

34. Cab left and right.

Next I scratchbuilt the antenna box that sits at the rear of the cab roof using styrene to a dimension of 0.4" x 0.4". I installed a Sinclair antenna in the center of the box.

I scratchbuilt the single Gyalite light bracket and added the single Gyalite light. Next I added the twin beam Gyalite between the number boards. Updated the number boards with Details West number boards. Drill the holes for the grab iron under the engineer's window and the windshield wipers. Lastly I added the arm rests under the side windows to finish the cab exterior [34,].

Next month we will continue detailing the cab interior and complete the model.



[Click here for reader comments](#)

.....

## JEFF SKINNER



Jeff Skinner is married with 3 grown children, and works as an engineer in the aerospace industry. He has always had an interest in trains, but it really took off with an HO scale Bicentennial train set that he received when young. As a child he was always interested in the Southern Pacific and Rio Grande. This was primarily because he didn't see them half as much as he saw the Union Pacific.

He is currently working on a Southern Pacific layout modeling the line from Eugene to Summit, Oregon. He currently enjoys detailing locomotives and freight cars. In addition to trains, he enjoys off-road motorcycle riding, and playing the guitar. ■

.....

## Parts list

<b>Archer</b>		FF 149	GE fuel filler
AR88047	GE U and -7 locomotive treadplate	AF 149	Salem air filter use small for forward filter
<b>A-Line</b>		AF 226	Salem air dryer large-small, use large for rear dryer
29233	GE B23-7 steps	AT 263	Detail air tank kit
12410	GE B motor weight	MU 221	MU cable with receptacle
<b>Aber</b>		MU 226	MU hose 3 cluster set
S03	Photo-etch Net 1.0mmx1.0mm	<b>Evergreen</b>	
A016	1:35 Chains 35	9109	.005" sheet styrene
<b>Cannon &amp; Co</b>		9101	.010" sheet styrene
1551	Cab shade	9102	.015" sheet styrene
1554	Cab interior	9103	.020" sheet styrene
1015	22"x78" plain doors	9104	.030" sheet styrene
<b>Detail Associates</b>		<b>Hi-Tech Details</b>	
1603	p3/5 horn	5003	post '72, 2-window cab
2308	prime air conditioner	6001	GE Exhaust Stack -- Dash-7 Thru Dash-8
1803	Sinclair antenna	<b>Microscale</b>	
2201	drop grab irons and n/b/w	87-527	GE EMD 1980 Locomotive Data
3001	sand filler hatches	87-447	SP/SSW Hood Diesels White Lettering 1980-1991
1108	Lift Rings -- GE w/Hinges	105	Micro Sol
1101	Lift rings	114	Kristal Klear
<b>Details West</b>		<b>Plastruct</b>	
HL 115	Pyle gyalite	90850	.010" styrene rod
HL 117	Pyle twin sealed-beam late	<b>Smokey Valley</b>	
HL 148	Pyle twin gyalite flush mount	14	GE B Handrail kit
AH 175	Nathan p-3	<b>Tichy train group</b>	
AH 187	Nathan m-5	1100	.008" Phosphor bronze wire
HL 291	Gyalite twin signal with visor	1101	.010" Phosphor bronze wire
PL 140	SP snow plow	1103	.020" Phosphor bronze wire
		1106	.0125" Phosphor bronze wire
VE 122	Cab vent (used as toilet vent)	<b>Tru-Color Paint</b>	
NB 249	GE number boards "hi-lo" mount	TCP-56	Light Primer
WS 350	Wheel slip modulation device	TCP-66	SP Scarlet Red
		TCP-134	SP Lark Light Gray
		<b>Train Control Systems</b>	
		A6X	6 function drop in decoder



# General Electric HO GEVO Now Arriving



**DCC Sound Equipped With Remote Couplers**



80-2344-1 G.E. Evolution E544AC Diesel Engine w/Proto-Sound 3.0 M.S.R.P. \$319.95  
80-2344-5 G.E. Evolution E544AC Diesel Engine w/Proto-Sound 3E+ (3-Rail) M.S.R.P. \$339.95

## Features

- Intricately Detailed ABS Body
- Metal Chassis
- Metal Body Side Grilles
- (2) Engineer Cab Figures
- Authentic Paint Scheme
- Metal Wheels and Axles
- RP25 Metal Wheels
- (2) Operating Kadee Compatible Remote Controlled Proto-Couplers\*\*

- Prototypical Rule 17 Lighting
- Directionally Controlled Constant voltage LED Headlights
- Lighted Cab Interior
- Illuminated Number Boards
- Flashing Charging Lights
- Powerful 5-Pole Precision Flywheel Equipped Skew-Wound Balanced Motor
- Locomotive Speed Control In Scale MPH Increments

- Operates On Code 70, 83 and 100 Track
- 1:87 Scale Proportions
- Built-In 28-Function DCC Decoder
- Proto-Sound 3.0 With The Digital Command System Featuring Freight Yard Proto-Effects
- Operates On 22" Radius Curves
- Proto-Sound 3E+ Models Operate on R2 Radius Curves (Marking C or K Track HO Stud Rail Only)

\*\*Proto-Sound 3.0 Models Only

M.T.H. Electric Trains is bringing the first HO GEVO diesel locomotive to market this Fall with operating charging lights\*. Outfitted with a powerful five-pole skew wound flywheel equipped motor, LED lighting, remotely operated Kadee® compatible couplers, user-installed Kadee® replacement couplers, full digital sound and a 28-function DCC decoder with Advance Consisting, Feature Mapping and Speed Mapping make this and all M.T.H. diesel locomotives HO's best motive power value.

\*Only 80-2344-1 and 80-2344-5 have charging lights

**M.T.H.**  
ELECTRIC TRAINS®

HO TRAINS THAT DO MORE

[www.mthHOtrains.com](http://www.mthHOtrains.com)



Follow Us  
Online!



©2015 M.T.H. Electric Trains

[MRHMAG.COM](http://MRHMAG.COM)

- [TABLE OF CONTENTS](#)
- [INDEX](#)



**TRAINMASTERS.TV**

*Recent new videos ...*



## BACK TO THE BASEMENT

Track and switch machine wiring tricks - and introducing the amazing A-Frame-O-Matic!



## EVENT REPORT

We visit the 2015 Amherst Railway Society's Springfield show ...



## LAYOUT TOUR

Station-by-station tour of Mike Porter's impressive CGW layout ...



## THE ROADSHOW

Building an overpass with sheet styrene, including an awesome trick for uber-realistic concrete texture!

Watch these videos on **TrainMasters.TV**





# FIRST LOOK feature



[Click here for  
reader comments](#)

DAVE KILBORN & KEVIN ROWBOTHAM

## MICHAEL ROSE'S LED BOARDS DISTRIBUTED BY PRECISION DESIGN CO...

**SINCE MICHAEL ROSE FIRST SHOWED THE** MRH community his LED circuit boards, used for lighting, a couple of years ago, people, including the authors, have been bugging him to sell them to the general public. Well, Michael finally caved in and asked Bill Brillinger of Precision Design Co. (PDC), if he would be willing to handle the sales of these boards, and Bill agreed. Let's take a look at these boards and see what they are all about.

The first thing to understand is PDC sells the bare circuit boards and required resistors, three per board, while the resistor supply lasts. It is up to the purchaser to buy appropriate LEDs, 21 per board, and power supply. PDC provides links on the website to the recommended products, as well as a link [mrhmag.com/node/20664](http://mrhmag.com/node/20664) to the MRH forum thread that not only discusses the boards, but includes a video Rick Wade shot of Michael demonstrating how he assembles the boards.

► NEW PRODUCT FIRST LOOK



## FIRST LOOK | 2

The boards measure 12” by 0.7” and include two thru-hole solder terminals at each end to connect power feeders or to wire multiple boards together [1]. Two mounting holes are included, making it easy to secure the boards to your mounting surface. Due to the board design, they cannot be mounted against a conductive surface without using insulating stand-offs, as the boards will short out.

A 24V power supply is recommended, but they will operate at lower voltages. The boards consume about 7 watts per board, or about 300mA, so you’ll need to determine an adequate supply based on how many boards you will use. With the recommended LEDs, each board is rated for 672 lumens and they are dimmable with controls employing pulse-width modulation.

Assembly was fairly straightforward following Michael’s video and the included instructions from PDC. Anyone with basic soldering skills shouldn’t have too much difficulty, though with the small size of the components, there is a learning curve, and it can be a bit of a challenge until you get the hang of it. The LEDs also need to be oriented correctly, and to assist, the recommended LEDs have a dot on top, opposite the side of pin 1. A magnifier is a handy, if not necessary, tool to have during assembly.

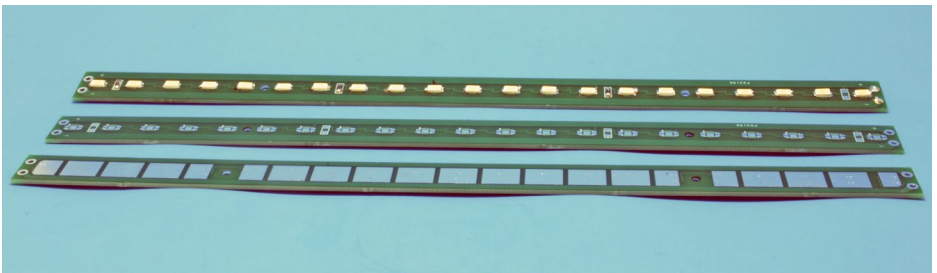

1. Back side of board, front side of board, and completed board.



## 2. Comparison between 5050 LED strips, and the LED board.

When first applying power to a completed board, you may find one or more lights out. As Michael shows in his video, this isn't unusual, but with more practice, most boards will work fine when complete. Generally, a quick touch with the soldering iron to the connections, most often the second soldered connection, will resolve any issues. Do not look directly at the LEDs when applying power, as they are very bright and you could see spots before your eyes for a while!

We compared light output and visual quality of light from the boards against 3M adhesive-backed 5050 white LED strips in a photo booth environment and against T8 fluorescent tubes in a layout room. In our comparisons, using a lux meter, it took approximately 3.5 feet of 5050 LED strips to get the same output as one LED board [2]. When compared to the fluorescent lights,

## FIRST LOOK | 4

one LED board put out about 90% of the light as two four-foot tubes at layout height. The LEDs were mounted approximately 24” closer than the ceiling-mounted fluorescent lights. These tests demonstrate the generous light output of these relatively small boards.

What looks good to one person doesn't always look good to another, so while both authors are quite satisfied with the look of the lights, the beauty is really in the eye of the beholder. We took several comparison photos to let you decide [3-9]. The first two pictures are taken in a photo booth, while the last three are taken on the layout. In the layout room, the intent of the LED lighting is to create a shadow box effect with fluorescent lighting's purpose to be room lighting only. Thus, the “combined” photo is the norm for the layout room.

There are many options for lighting your layout, and plenty that are less expensive than these LED boards from PDC and Michael Rose. Still, these boards are well-designed and engineered, and produce a lot of pleasing light for their small footprint and low energy consumption. It requires some work to implement this lighting system but for many, the increased cost and effort are justified by the end result.

### Cost comparison:

3.5 feet of 3M adhesive-backed 5050 LED light strips – ~ \$3.00

Cost of one complete LED board from PDC (bulk purchase of 50 boards) - \$11.67 (\$5.25 per board, \$6.42 for LEDs)

Cost of fluorescent fixture and two T8 tubes - ~ \$62.00



ADVERTISEMENT

# Railroad Explorer Magazine

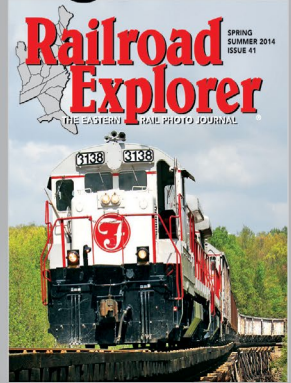
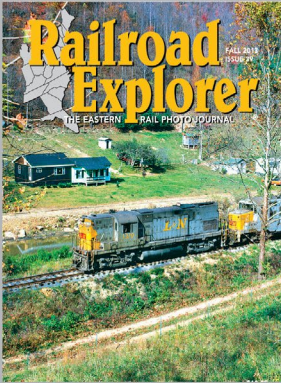

## THE EASTERN RAIL PHOTO JOURNAL

- Three all-color issues per year. Exciting feature stories and spectacular photos of Eastern Railroading
- Best-in-class photo reproduction. Printed on heavy, glossy paper. Zero advertising.
- Three times per year - Winter, Spring/Summer and Fall editions.

**Subscribe today!**

[www.railroadexplorer.com](http://www.railroadexplorer.com)

ADVERTISEMENT

**TamValleyDepot.com**

Great Electronics for Great Model Railroads

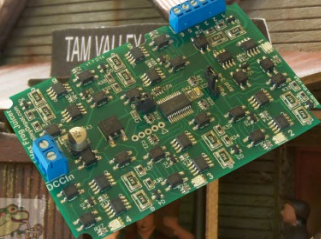

**We are loading up the boxcars with Frog Juicers ready for your layout!**

[MRHMAG.COM](http://MRHMAG.COM)

ADVERTISEMENT

**RR-CirKits, Inc.**

Affordable Electronics for Model Railroads

- Computer Interface
- Signaling
- General I/O
- Block Detection



**SignalMan**



**32 Aspects!**

[Learn More ...](#)

- [TABLE OF CONTENTS](#)
- [INDEX](#)

# FIRST LOOK | 5



3. 5050 LED strips with automatic camera settings.



4. LED board with automatic camera settings.

# FIRST LOOK | 6



5. LED board set to ISO100 F29.



6. 5050 LED strips set to ISO100 F29.



# FIRST LOOK | 7

## Links:

Link To Vishay Resistor at Mouser (3 per board) – 33 Ohm, ¼ Watt, 5% tolerance – [mouser.com/ProductDetail/Vishay-Dale/CRCW120633R0JNEA/?qs=sGAEpiMZZMtlubZbdhIBIFcnuHQ2TlqEfG7aLChfVaQ%3d](https://www.mouser.com/ProductDetail/Vishay-Dale/CRCW120633R0JNEA/?qs=sGAEpiMZZMtlubZbdhIBIFcnuHQ2TlqEfG7aLChfVaQ%3d).

Link to Vishay Resistor Datasheet – [mouser.com/ds/2/427/dcrcwe3-109170.pdf](https://www.mouser.com/ds/2/427/dcrcwe3-109170.pdf).

Link to Seoul LED at Mouser (21 per Board) – High Power – White 4500K 80CRI 3.4 Volt – [mouser.com/ProductDetail/Seoul-Semiconductor/STW8Q14BE-U0U7-DA/?qs=%2fha2pyFadujT8aCQjaEQGoJ4oesEU2mb6Vg4y3oJvgofzTWKww8TUQ%3d%3d](https://www.mouser.com/ProductDetail/Seoul-Semiconductor/STW8Q14BE-U0U7-DA/?qs=%2fha2pyFadujT8aCQjaEQGoJ4oesEU2mb6Vg4y3oJvgofzTWKww8TUQ%3d%3d).

Link to LED datasheet – [mouser.com/ds/2/363/STW8Q14BE%5B1%5D-198290.pdf](https://www.mouser.com/ds/2/363/STW8Q14BE%5B1%5D-198290.pdf).

Link to Vishay Resistor at Digikey – [digikey.ca/product-detail/en/CRCW120633R0JNEA/541-33ECT-ND/1181279](https://www.digikey.ca/product-detail/en/CRCW120633R0JNEA/541-33ECT-ND/1181279).

Link to Seoul LED at Digikey – [digikey.ca/product-detail/en/STW8Q14BE-U0U7-DA/897-1089-1-ND/2700967](https://www.digikey.ca/product-detail/en/STW8Q14BE-U0U7-DA/897-1089-1-ND/2700967).

Link to LED boards – [pdc.ca/rr/catalog/5000](https://www.pdc.ca/rr/catalog/5000).

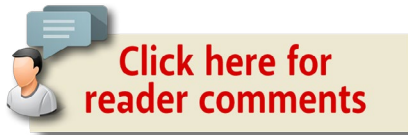

 NORTH AMERICAN RAILCAR CORPORATION  
ПОСЛОНН АМЕРИКАН РИЛКАР КОРПОРАШОН  
ПОСЛОНН АМЕРИКАН РИЛКАР КОРПОРАШОН

*They're Here!*



SKNX 397233

LD LMT 223,200 LBS 101,200 KG  
LT WT 62,800 LBS 28,500 KG



*Saskatchewan!*



CLICK HERE FOR

[Saskatchewan](#)



*Take an Alberta Break... visit* Three Hills

ALPX 628350

Heritage Fund



**Alberta**

CLICK HERE FOR

[Alberta](#)

**HO Scale**

Photo - Collin Reinhart

**Hawker Siddeley 4550 cu.ft. Cylindrical Hopper**

**All new Road #s!**

*Most Pre-Sold! Get yours before they are gone...*

NARC Cars are sold exclusively through

***Pacific Western Rail Systems***

[MRHMAG.COM](http://MRHMAG.COM)

- [TABLE OF CONTENTS](#)
- [INDEX](#)

# FIRST LOOK | 8



7. Room lighting only, ISO100, F8.



8. Combined Room and LED Lighting ISO100, F8.





9. LED boards only, ISO100, F8.

---

## DAVE KILBORN



Dave has authored two Reverse Running columns in *Model Railroad Hobbyist*, November/December 2010 and March 2013 , and is also a regular on the MRH forums under the user-name: skiloff. Dave is currently working on his small modular layout while he develops plans for a new layout. Dave lives with his wife and two children in Saskatoon, SK, Canada.

## KEVIN ROWBOTHAM



Kevin had two previous articles appear in *Model Railroad Hobbyist*, building a static grass applicator, March/April 2010, and building an audible short detector, March 2012. Kevin and his family live in rural Saskatchewan, and are building a freelanced HO scale model railroad. ■

# ALL ABOARD!



## EASTERN CANADA'S LARGEST TRAIN SHOW APRIL 25th & 26th, 2015



# WWW.OTTAWATRANEXPO.COM

MANUFACTURERS, VENDORS, LAYOUTS, CLINICS AND DISPLAYS.  
ALL DEDICATED TO THE PASSION OF TRAINS

**CANADIAN INTERNATIONAL HOCKEY ACADEMY**

8720 COUNTY ROAD 17

ROCKLAND, ON K4K 1T2

ADULTS - \$10.00 STUDENTS (13-17 YEARS) - \$5.00

CHILDREN (12 & UNDER) - \$2.00

EVERY \$2.00 TICKET WILL BE DONATED TO ROGER'S HOUSE



*We proudly support  
Rogers House*



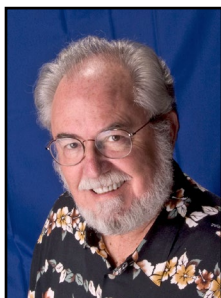

Model Railroad Hobbyist | March 2015 | #61

# MARCH NEWS

column

RICHARD BALE *and* JEFF SHULTZ



[Click here for  
reader comments](#)

## Richard Truesdale 1923-2015



Dick Truesdale, founder of Westside Models Company, died February 3, from complications of diabetes and subsequent kidney failure. He was 92 years old. Truesdale grew up in the Big Sur region of coastal California. He joined the U. S. Marine Corps at the beginning of World War II and piloted F4U Corsair fighter planes in the South Pacific.

After the war Truesdale went to work for Pan American World Airways. As the war in Vietnam escalated, he resigned from Pan Am and entered the U.S. Air Force where he flew B-57 bombers. Later Truesdale returned to Pan Am where he eventually qualified to pilot Boeing 747 jumbo jets to Asia.

▶ THE LATEST MODEL RAILROAD PRODUCTS, NEWS & EVENTS

[MRHMAG.COM](http://MRHMAG.COM)

- [TABLE OF CONTENTS](#)
- [INDEX](#)



## MARCH NEWS | 2

During one of his early flights to Japan, Truesdale, who was a lifelong rail fan and modeler, arranged for a local craftsman to fabricate an HO narrow gauge steam engine out of brass. One thing led to another, and in 1967 Westside Model Company (WSM) imported its first model – an HO scale Southern Pacific narrow gauge Consolidation. The business expanded rapidly, and in 1977 WSM had four Japanese and Korean builders working on 27 different HO locomotive projects. By 1980 WSM had imported over 100,000 brass models to America. Truesdale liked to say that the model business grew so big he had to retire from Pan Am. A lifetime NMRA member, Truesdale was inducted into the Narrow Gauge Hall of Fame in 2004. After selling his company to Precision Scale Models in the early 1980s, Truesdale and his wife retired to Arizona. (Jim Vail contributed to this report) ...

### Atlas Recall

Atlas Model Railroad Company has discovered a potential defect with its Deluxe Switch Control Box model #57. Some buttons on the controller may stick, causing continuous power to the switch machine. Any #57 controllers on hand may be returned directly to Atlas for a credit for \$14.25 (in US dollars). The credit may be applied to any future purchase directly from the Atlas factory store. For additional information go to [atlasrr.com/News/number57-recall.htm](https://atlasrr.com/News/number57-recall.htm) ...

### Fox Valley Acquires Red Caboose N Scale Line

Fox Valley Models of Des Plaines, Illinois is the new owner of the Red Caboose brand of N scale rolling stock and parts. In making the announcement, Matt Gaudynski said his company was committed to continuing the entire Red Caboose N scale

# MARCH NEWS | 3

.....

product line including the return of the Unimate couplers as early as this summer. Fox Valley is currently accepting new reservations for the entire product line. Gaudynski noted that previously announced releases will be met, however there may be a reduction in the selection of road numbers. For additional information go to [foxvalleymodels.com](http://foxvalleymodels.com) ...

.....

## NEW PRODUCTS FOR ALL SCALES

**Doctor Ben's** has released a 2015 Scale Consortium Catalog. It is available at \$3.99 or free with any purchase of \$20.00 or more. The catalog can also be downloaded as a PDF file and printed. For details visit [debenllc.com](http://debenllc.com).

.....



**Morning Sun Publications** has released two new electronic books including “GG1: The World’s Greatest Electric Locomotive Volume 1: PRR 1948-1967.” The Pennsylvania Railroad expected a lot from the GG1 electric locomotive it created in the mid-’30s, and it was not

disappointed. This book follows its everyday duties from the late-’40s to the last days of the PRR. Long-distance passenger service, commuter trains, drag freight, manifest freight, wrecks, and paint variations are all presented in more than 250 color images.

Also new from Morning Sun is “Erie Lackawanna Color Photography of Robert F. Collins, Volume 2: 1970s.” This second

# MARCH NEWS | 4

.....

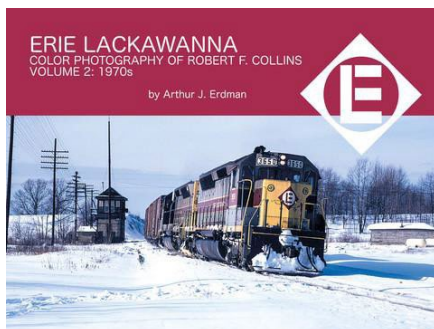

electronic volume by photographer Collins includes SD45s and U33Cs heading EL's hotshots, while new U34CHs are depicted in the road's final years. Both PC and Apple versions of these e-books are available. For additional information including FAQ

about e-books go to [morningsunbooks.com/collections/ebooks](http://morningsunbooks.com/collections/ebooks).

Traditional hardcover printed books recently announced by Morning Sun include "Milwaukee Road Power In Color Volume 3;" "1961-1986 Electric Locomotives and Diesel Action Volume 3;" "Boston & Maine in Color Volume 3;" "The B&M in the Guilford Years;" and "Trackside in California 1964-99 with George H. Drury." Visit [morningsunbooks.com/collections/all-hardcover](http://morningsunbooks.com/collections/all-hardcover) for details.

.....

## O SCALE PRODUCT NEWS



### **3rd Rail Division of Sunset Models Inc.**

is taking reservations for O scale models of Pennsylvania Railroad class FF-2 electric locomotives. The prototype locomotives

were built in 1929 for Great Northern as 1-C+C-1 class Y-1 heavy electrics. Also supplied the car bodies, with General Electric



# MARCH NEWS | 5

.....

responsible for electric components and the drive system. GN dieselized operations through the Cascade Tunnel in 1956 and decommissioned the road's electrical system. Seven of the Y-1s were sold to the Pennsylvania Railroad, who rebuilt them to PRR standards and classified them as FF-2. They were renumbered and placed in service as road numbers 1 through 7.

3rd Rail's O scale models feature manual working pantographs and two Pittman motors powering a newly designed chassis and drive mechanism. The models may be ordered for two-rail or three-rail operation. Only 40 of these handcrafted brass models will be produced. For additional information visit [3rdrail.com/reservation.html#PRRFF2](http://3rdrail.com/reservation.html#PRRFF2).

.....



**Atlas O** plans to release this Master series 17,600 gallon Trinity tank car with new road names during the third quarter

of 2015. Both two-rail and three-rail models will be available for Cargill, Dow Chemical, ADM, Occidental Chemical, and Southern Pacific.



Also coming in the third quarter are new paint schemes and road numbers for Atlas O's 42' coil steel car.

Road names will be AK Steel (above), Armco Steel, Bethlehem Steel, CSI, Nucor, Republic Steel, Union Railroad, US Steel, and US Steel Geneva Works.

.....

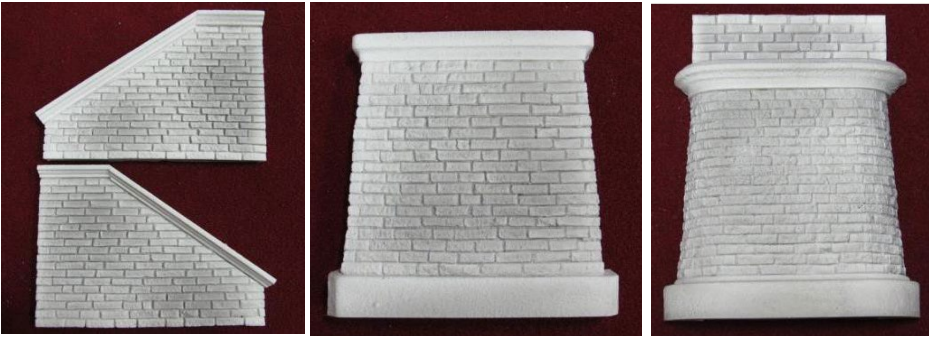

**Pre-Size Model Specialties** offers a wide selection of resin cast items in most popular scales. The new O scale bridge abutments shown here replicate dressed-stone structures. The resin may be finished with paint, stain, or dry powders. For details on the entire line, including additional new items, visit [pre-size.com/index.html](http://pre-size.com/index.html).

.....

## HO SCALE PRODUCT NEWS



**Accurail** Accurail has announced a new kit for an HO scale 50' steel boxcar with 8' Superior sliding doors.

Two versions of the model will be released, a Riveted-Side with roofwalks and high ladders/brake wheel (13 roadnames) and a Welded-Side with no roofwalk and low ladders/brake wheel (12 roadnames). Models will be available as undecorated as well as data only in both mineral red and oxide colors. The Superior Doors are also now available separately.

Accurail is selling an HO scale kit for a 40' plug door insulated steel boxcar decorated for Northern Pacific. The model kit is based on a prototype built in 1958 with Dreadnaught ends,

# MARCH NEWS | 7

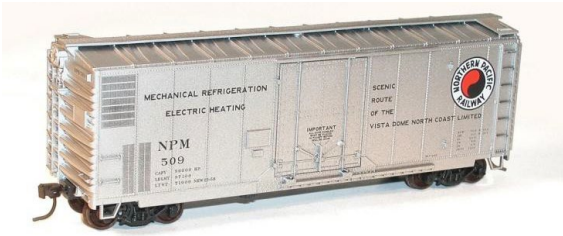

diagonal panel roof, and Equipco plug doors. All Accurail kits include Accumate couplers and appropriate trucks.



An HO kit for this Union Pacific wood stock car is available now from Accurail. The model has Murphy ends, a fishbelly underframe, and brake

wheel mounted on a vertical shaft.



This Great Northern 40' steel boxcar from the early 1950s has Dreadnaught ends and combination sliding and plug doors.



Accurail's HO scale kit for this P-S 4750 triple bay covered grain hopper follows a prototype built in 1975.



Additional new HO kits from Accurail include an 89' bi-level partially enclosed auto rack. The CNW rack

rides on a flat decorated for Trailer Train.



# MARCH NEWS | 8

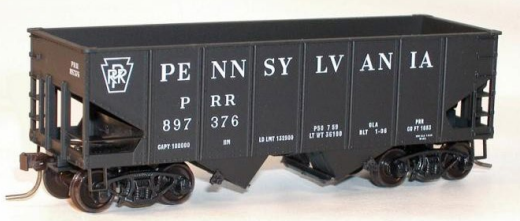

Accurail has released a new run of HO kits for this USRA 55-ton twin-bay hopper car decorated for PRR. The United States Railroad

Administration authorized the construction of 25,000 cars that eventually went to 17 different railroads including the Pennsylvania. The standardized cars were built between 1917-1920, with many continuing in service into the 1960s. A special three-pack of this car is available at an MSRP of \$46.98.



This HO scale kit models a CPR 40' plug-door reefer with Dreadnaught ends and a diagonal panel roof with ice hatches. Contact your

dealer or visit [accurail.com](http://accurail.com) for additional information on Accurail products.

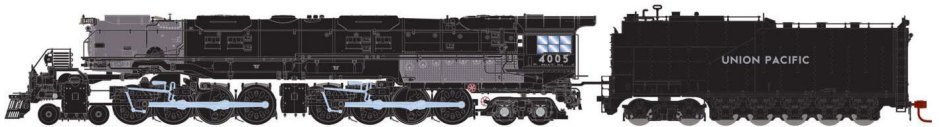

**Athearn** is quoting a November release date for the next production run of its Genesis series 4-8-8-4 Big Boy steam locomotive. The HO scale model is patterned after 20 of the giant locomotives Alco built for the Union Pacific in 1941. An additional five were ordered in 1944. Despite the UP's heavy reliance on diesels, the Big Boys were not retired until the early 1960s. Athearn will offer

## MARCH NEWS | 9

seven road numbers with oil tenders plus one model with a tender equipped to handle coal. The model requires a minimum radius of 22". Visit the Athearn website for pricing and details on DC and DCC Tsunami Sound options.



New Genesis diesels coming in November include EMD GP7 locomotives with high hood (above) and low hood (below) decorated for Chicago & North Western.

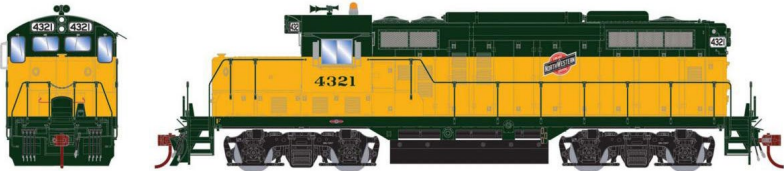

Also GP9 HEP units with short, high hoods (above) and GP9B cabless units (below) for UP and PRR.

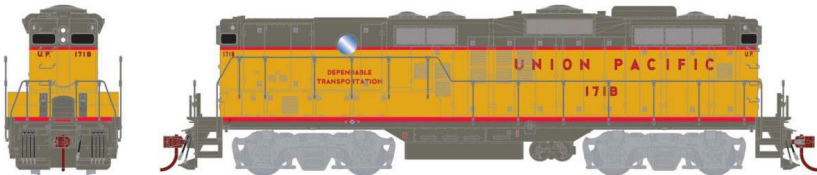

Multiple road numbers are available with all units featuring road-specific details. DC models will have an MSRP of \$189.98, with DCC dual-mode SoundTraxx sound decoder listing at \$289.98.

# MARCH NEWS | 10



Athearn's November schedule includes Genesis series SDP45 diesel locomotives decorated for Great Northern (blue and white scheme), Burlington Northern (GN blue and white with patch), Conrail, and Erie Lackawanna as seen here.



SD40 diesel locomotives are also in Athearn's November release. Road names will be Burlington Northern, C&O, Conrail, Montana Rail Link (two schemes), and the Santa Fe's 1970s-era yellow warbonnet shown here. The Ready-to-Roll® series models feature 88" hoods, 48" radiator fans, and HT-C trucks with Hyatt bearings.



Freight cars due in November include a Genesis series 50' SEICO boxcar with 70-ton trucks with rotating roller bearing caps. In addition to the St Lawrence Railroad car shown here, road names will be Boston & Maine, Milwaukee Road, Pittsburgh & Lake Erie, Norfolk Southern, and Bay Colony Railroad.

Athearn's November schedule lists several HO scale Ready-to-Roll® freight cars including 34' open hoppers with offset sides and flat ends. Road names will be Baltimore & Ohio, Canadian



# MARCH NEWS | 11



Pacific, Great Northern, Erie, and Reading. A Chesapeake & Ohio car with notched ends is also in the mix.



A GATC 2600 Airslide covered hopper with photo-etched roof walks and wire grab irons is also scheduled for arrival in

November. Road names will be BSMX-Baystate Milling, GACX-Golden Loaf, GACX-Pillsbury, CB&Q, Northern Pacific, and Rock Island. The run includes an undecorated version.



An Eastern-style steel caboose with a centered cupola will be available in November for Conrail, Western

Maryland, Pittsburgh & West Virginia, Rock Island, and Missouri Pacific.

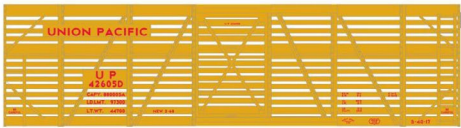

A single level steel stock car with Dreadnaught ends will be available in

November for Great Northern, Denver & Rio Grande Western, CP Rail, CB&Q, and Union Pacific. The UP car will be available in oxide red and yellow as seen here.

Athearn's November schedule includes two pieces of intermodal equipment. The 45' trailer seen here will be decorated for

# MARCH NEWS | 12

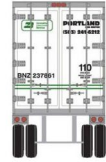

BN (Portland), Santa Fe, Conrail, Milwaukee Road-Preferred 45, Transamerica, and Southern Pacific–Golden Pig Service. Forty-foot containers with separately applied door closure rods will be available in 3-packs for Transamerica, Seaco, Waterfront (Hyundai), Capital Intermodal, Safmarine, and Wan Hai. See your dealer or visit [athearn.com](http://athearn.com) for pricing information on all of these items.



**Atlas** has released its production schedule for the third quarter of 2015.

At the top of the list is a new run of Atlas Master® series Alco Century C420 phase 2 diesel locomotives. The HO scale ready-to-run models will have newly redesigned AAR type B truck sideframes with optional bearing covers. Phase 2A units with a high nose hood will be available for Norfolk & Western (two schemes), Long Island Railroad (two schemes), and Louisville & Nashville (above).



Phase 2B units with low noses will be available for Seaboard Coast Line, Cuyahoga

# MARCH NEWS | 13

Valley Scenic, Guilford (D&H), Tennessee Central, and Lehigh & Hudson River (above).



New decorating schemes will be available on Atlas's Master® series Trinity 17,600 gallon corn syrup tank car. They include

CRGX-Cargill (above), ADMX-Corn Sweeteners, DOWX-Dow Chemical, HOKX-Occidental Chemical, RRBX-Rampart Range, UNVX-Univar Canada, and Southern Pacific.

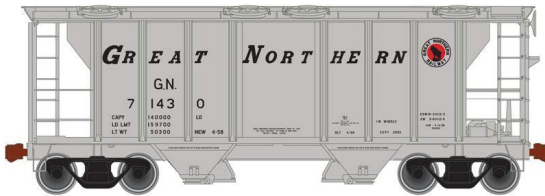

The final ready-to-run model coming from Atlas during the third quarter of 2015 is a Trainman® series PS-2 covered hopper.

In addition to the GN version shown here, road names will be Ann Arbor, American Potash & Chemical, BNSF, DM&IR, Illinois Central Gulf, Pittsburgh & West Virginia, and Rutland. For additional information on Atlas products including pricing visit [atlasrr.com](http://atlasrr.com).



**Bachmann Trains** is selling a USRA 0-6-0 steam switch engine with a slope back

tender. The model comes with Bachmann's DCC On Board™



## MARCH NEWS | 14

.....

with a dual-mode digital decoder that enables operation with a standard DC analog power pack or any NMRA-compliant DCC system. DCC functions are limited to speed, direction, and lighting control. The model also has smoke generating equipment. In addition to the CB&Q Burlington Route scheme shown here, the HO scale ready-to-run model is available decorated for New Haven Railroad. See your dealer or visit [bachmann-trains.com](http://bachmann-trains.com) for pricing.

.....

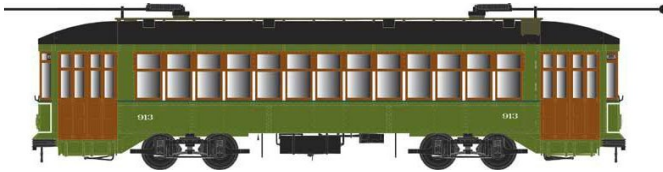

**Bowser Trains** is developing a new HO scale New Orleans streetcar with

availability planned for this fall. The Executive Line model will have an injection molded body with window glazing, operating roof trolley poles, operating headlight, and a drive system that uses a can-motor fitted with a flywheel. Accurate painting schemes will be available for New Orleans (red scheme with yellow trim and two green schemes), and PTC Hog Island Suburban-K cars. The trolleys will be available for DC operation (with DCC 21-pin plug), and for DCC with LokSound decoders. Dealer reservations are due by March 27, 2015. Visit [bowser-trains.com](http://bowser-trains.com) for details.

.....

The latest HO scale craftsman kit from **Fos Scale Limited Models** is The Metzger Building. The kit makes into a four story apartment building with commercial store fronts at street level. The kit is composed of laser-cut structure parts including clap-board walls and numerous metal detail parts. Additional features

## MARCH NEWS | 15



include a sidewalk, a flat roof with roof access sheds, two billboards, and a roof-top water tank. This 6" x 8" kit is part one of Pearl Street, a new series from Fos that will extend the scene for an entire block. For additional information visit [fosscalemodels.com](http://fosscalemodels.com).



**Full Steam Ahead** is selling Colonial Distillery, a complex new HO kit based on a prototype in Toronto, Canada. The walls of both buildings are resin with all details, including fenestration lintels and granite bases, cast in place. The windows are composed of two layers of laser-

cut material and include window glazing. Additional features include three styles of billboards with a choice of signs, three cast resin tanks, a variety of doors, laser-cut rolled roofing material, and cast roof vents. Only 100 of this limited run kit will be produced. Pricing is pending but should be firm by mid-March when the kit is scheduled for release. For additional photos and ordering information visit [fullstemahead.ca](http://fullstemahead.ca).

**InterMountain Railway** is scheduled to release a new production run of 1937 AAR boxcars next month. In addition to the Northern Pacific scheme shown here, road names will be

# MARCH NEWS | 16



Nashville, Chattanooga & St. Louis; Atlantic Coast Line; Central of Georgia; Boston & Maine; Minneapolis &

St. Louis; Norfolk Southern; and Southern Pacific. The run includes hopper cars with round ends decorated for Clinchfield, Montour, Nickel Plate Road, and Interstate.



Also due for release next month are SFRD-Santa Fe steel ice reefers in eight decorating schemes. Class Rr23

cars will be available for El Capitan and Grand Canyon (above). Class Rr28 cars will be available for Super Chief (straight map), and Texas Chief. Class Rr32 will display Super Chief, The Chief West, and The Scout slogans. A class Rr21 reefer will be offered fully painted and lettered but with no slogan. These outstanding HO scale models are from the highly regarded SFRD cars InterMountain created in 1996 for Long's Drug Store. Contact your dealer or visit [intermountain-railway.com](http://intermountain-railway.com) for additional information including pricing.



**Kadee Quality Products** plans to release this Great Northern 50' PS-1 box-

car in April. Spotting features on the HO scale ready-to-run model include a StanRay roof, 12-panel welded sides with 10' Youngstown sliding doors, Pullman-Standard washboard ends,



# MARCH NEWS | 17

and a cushion underframe. The model replicates a prototype built for GN in 1966 and comes decorated in the original glacier green scheme with red doors and the GN goat herald on the left side. See your dealer or visit [kadee.com](http://kadee.com) for additional information.



Kadee has scheduled a May release date for a new version of its PS-1 50' 12-steel panel boxcar. The new model features an 8' sliding door

with the Pullman-Standards distinctive peaked shape stamped in each of the door's six panels. The underframe is also different from Kadee's earlier 50' PS-1s. The initial release will be decorated for Missouri Pacific with a Route of the Eagles slogan. Also coming in May is a pair of AAR 50-ton twin-bay hopper cars with Wine latches and offset sides decorated for CIL Monon. Two road numbers will be offered.

**Rail Crew** is a new accessory supplier recently established by Rapido Trains. Their introductory products are switch machines and a remote uncoupler.

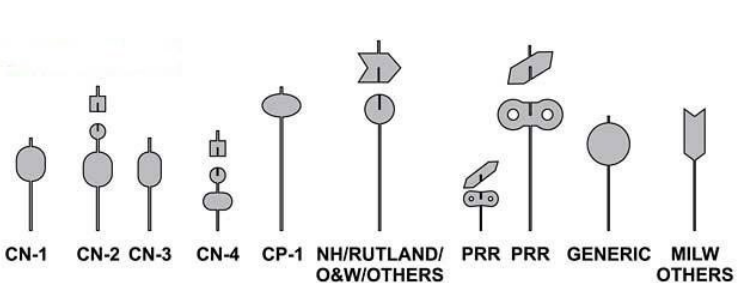
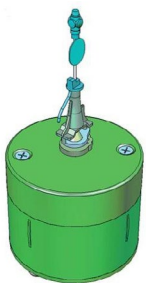

## MARCH NEWS | 18

.....

The Rail Crew switch machines are mounted below the roadbed. A vertical switch stand at the top of the machine rotates when the switch is actuated. Ten different photo-etched metal targets are supplied with each switch machine. Also included are two styles of non-functioning switch lanterns. The unit has SPDT auxiliary contacts to route power to frogs and signals. The machine is an on-off type that momentarily uses 12 volt DC power. Additional switch stands and targets will be available separately.

RailCrew's remote uncoupler is an on-off device that mounts under the roadbed. It is reported to function reliably with all brands of HO magnetic couplers. The device measures 1.75" (44mm) wide and .875" (22mm) deep and can be controlled by DCC accessory decoders. The location of the hidden uncoupler is indicated by an LED between the rails that only operates when the controller is in the on position.

Both the switch machine and uncoupler are scheduled to be available in May. Additional information is available at [rapido-trains.com/railcrew.html](http://rapido-trains.com/railcrew.html).

.....

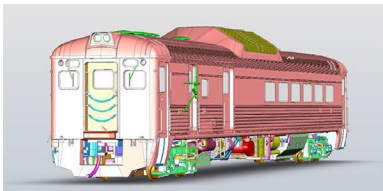

**Rapido Trains** has reported major progress in their project to produce accurate HO scale models of Budd-built RDC self-propelled commuter units. Phase 1 and Phase 2 versions of RDC-1, RDC-2 and RDC-3 units are on schedule with the initial release expected early next year. Electronic scans of full-size prototypes have been completed which will insure the accuracy of the exterior configuration.

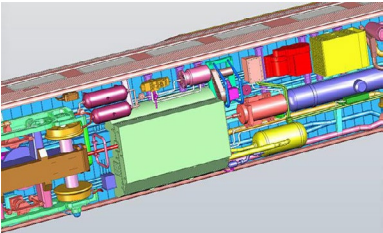

# MARCH NEWS | 19

All underframe details will be replicated along with a fully detailed interior. A hidden twin-motor drive system will power the ready-to-run models (more info available at [rapido.com](http://rapido.com)).

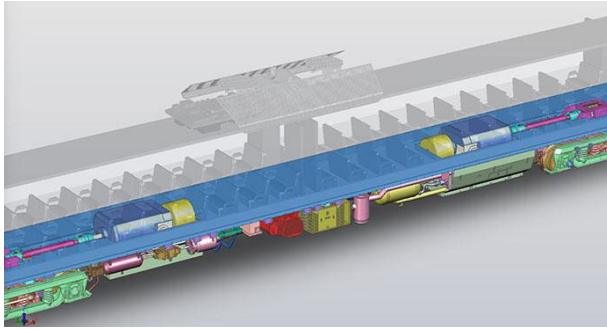

Although the difference between Canadian and American versions of the RDC are subtle, Rapido says it is committed to replicate each of them. American

variations include two different roof blister designs for the Phase 1 units, etched window safety grilles, unique headlight assemblies, diaphragms, and pilots or no pilots as appropriate to each road.

American roadnames will be in Amtrak, Boston & Maine (Minuteman), B&M (McGinnis), Baltimore & Ohio, Chicago & Eastern Illinois, Central New Jersey, Long Island Railroad, MBTA-Massachusetts Bay Transportation Authority, New Haven (script), New Haven (McGinnis), New York Central, Penn Central, Pennsylvania-Reading Seashore Lines, Reading, Southern Pacific, and painted but unlettered.

Variations on Canadian RDCs include diaphragms, horn arrangements, and the unusual headlight and number board assemblies on CN's Phase 1 units. Canadian road names will be VIA Rail Canada, VIA-CN, Canadian National (as delivered), CN (noodle), Canadian Pacific (maroon), CP Rail (action red), Dominion Atlantic, Pacific Great Eastern, British Columbia Railway, and painted but unlettered.





# MARCH NEWS | 20



**Red Caboose** plans to release a group of HO scale 1937 AAR boxcars next month. The ready-to-run models feature

Youngstown double sliding doors, a Murphy roof, running boards, and a geared handbrakes. Road names include three versions of Union Pacific cars including an automobile car with both yellow and white lettering (above).



Also a yellow UP car with three-color shield and “automated railway” slogan (above), and an oxide red car with a colored

shield and “Ship & Travel” slogan (below).



Other road names for the 1937 boxcar will be Soo Line, Lehigh Valley, New York Central (jade green), Northern Pacific, Seaboard

Railway, Southern Pacific, Atlantic Coast Line, Missouri-Kansas-Texas, and SSW-Cotton Belt.



Also due from Red Caboose next month are 10,000 gallon Type 103W welded tank cars. In addition to the Conoco car illustrated here, road

names for the HO scale ready-to-run model will be UTLX, SHPX, SHPX-FMC, DODX, Texaco, Sunoco, Flying A, Tidewater Flying

# MARCH NEWS | 21

Richfield, Phillips, Sinclair, and Sinclair Oil. InterMountain Railway is responsible for marketing Red Caboose HO products. For additional information visit [intermountain-railway.com](http://intermountain-railway.com).

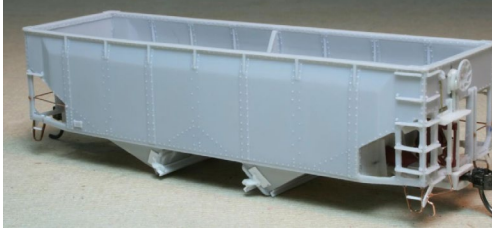

Here is a preview look at an HO scale resin kit for an IC hopper under development by **Resin Car Works**. Note the cast-on ladder rungs. Resin models have generally had free-standing grab irons and ladder rungs fashioned from wire which prototype modelers often cite as one of the inherent attractions of resin kits.

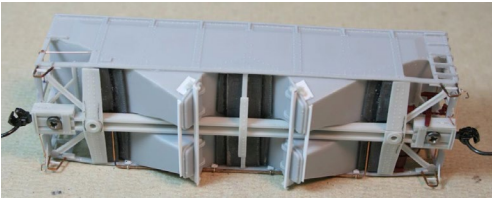

However, hobbyists attempting to assemble a fleet of a particular prototype such as this hopper car may welcome the practicality of judiciously designed cast-on details.

RCW's introductory resin kits for ACF type 27 acid tank cars in both 7,000- and 8,000-gallon versions are still available. For information including ordering instructions visit [hansmanns.org/resincarworks/about.htm](http://hansmanns.org/resincarworks/about.htm).

**Tangent Scale Models** is now shipping the new PRR X58 box-car it introduced at the Amherst Railroad Hobby Show in late January. The HO scale model is a faithful replica of the fleet of multi-purpose cars Pennsylvania built between 1964 and 1966. Constructed as class X58, many of the big boxcars lasted beyond the Conrail era with some surviving into the NS take over. Most were retired in the mid-2000s. Here is a look at the four ready-to-run models Tangent is offering:

## MARCH NEWS | 22



This is the original Pennsylvania X58 from 1965 in PRR freight car red. It has an unpainted galvanized roof and running board.



In 1973 Penn Central repainted their X58s in distinctive PC green with the large worm logo.

Features on the PC car

include a hydra-cushion underframe, no running board, lowered brake appliances on the end, and lowered ladders.



The Conrail X58B repaints from 1987 also have the running board removed however the brake appliances and ladders on the

B-end remain in their original high position. Ladders on the A-end have been lowered and a third door arm and top cam lock have been added at the center of the plug door.



The final variation of the X58 boxcar is the 1999 NS class BP8 repaint with no running board, high brake appliances, and lowered

ladders at the A-end of the car.

For hobbyists wishing to do their own decaling, Tangent has undecorated X58 boxcars painted in PRR freight car red, PC



# MARCH NEWS | 23

green, and Conrail red. A limited supply of unpainted kits are scheduled for release later this month. Note that Tangent allows mixing for multiple car discounts on quantity purchases. For additional information including a detailed history of the X58 boxcars go to [tangentscalemodels.com](http://tangentscalemodels.com).

As noted in this month's decal report Daniel Kohlberg has released decals designed for use on Tangent's X58 boxcar.

.....

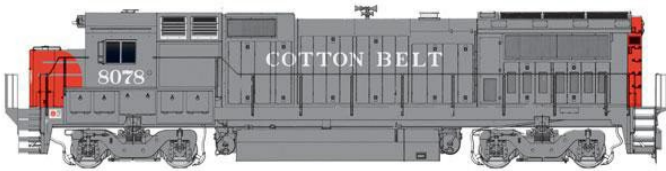

**Walthers** has released two versions of General Electric's Dash

8-40B diesel locomotives. The HO scale ready-to-run model is available with a standard cab decorated for SSW-Cotton Belt, CSX, and undecorated.

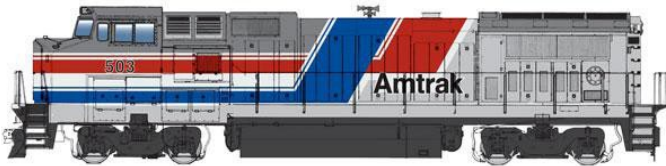

A Dash 8-40BW wide cab version is available for Santa Fe (war

bonnet) and Amtrak (Pepsi scheme, above). Both versions of the ready-to-run locomotive are available for DC operation and with DCC SoundTraxx system.



A newly tooled HO scale ACF 50' exterior post boxcar is scheduled to make its debut from Walthers in April. The Mainline series

# MARCH NEWS | 24

ready-to-run model will be available decorated for Santa Fe, CSX, Kansas City Southern, Missouri Pacific, Pickens Railroad, and two versions of Railbox.



Walthers has scheduled another release of its highly-regarded Proto® series 32' ACF Type 21 10,000 gallon tank car in June. The HO scale model

is based on a prototype introduced in 1921 that continued in service into the 1960s. Ready-to-run models with arch bar trucks and K brake systems will be available in two numbers each for M-K-T, Chicago & North Western, and White Eagle Oil. The Clark Oil model shown here has AB brake gear and rides on Bettendorf-style 50-ton spring plankless trucks. For additional information on these models including pricing contact your dealer or visit [walthers.com](http://walthers.com).

## N SCALE PRODUCT NEWS

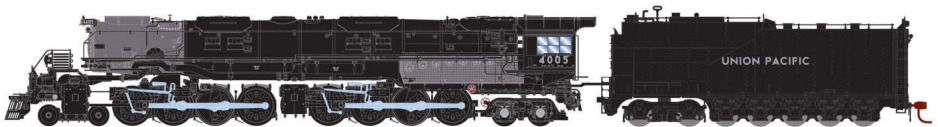

**Athearn's** November production schedule includes an N scale 4-8-8-4 Big Boy steam locomotive. The scale model is patterned after 20 of the giant locomotives Alco built for the Union Pacific in 1941. An additional five were ordered in 1944. Despite the UP's heavy reliance on diesels, the Big Boys were not retired

# MARCH NEWS | 25

until the early 1960s. Athearn will offer seven road numbers with oil tenders plus one model with a coal tender. The N scale model can handle curves with an 11” radius but Athearn recommends a 15” radius for reliable operation. Contact your dealer or visit [athearn.com](http://athearn.com) for pricing and details on DC and DCC Tsunami Sound options.



An N scale 50’ SEICO boxcar is included in the November release. In addition to the

Pittsburgh & Lake Erie car shown here, road names will be Boston & Maine, Milwaukee Road, Norfolk Southern, Bay Colony Railroad, and St Lawrence Railroad.

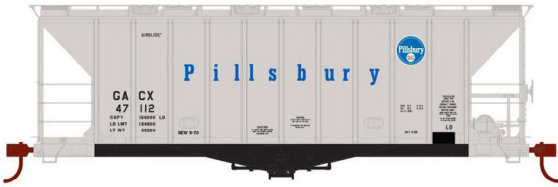

Completing Athearn’s N scale releases for November is a GATC 2600 Airslide covered hopper that features

photo-etched roof walks. Road names will be BSMX-Baystate Milling, GACX-Golden Loaf, GACX-Pillsbury, CB&Q, Northern Pacific, and Rock Island. See your dealer or visit the above website for pricing and additional details.



**Atlas’s** N scale production schedule for the third quarter includes



## MARCH NEWS | 26

GP38-2 diesels decorated for Ontario Northland, Conrail, Massachusetts Central, Missouri Pacific, Union Pacific, and Seaboard System. All of the above mentioned units have a low hood.

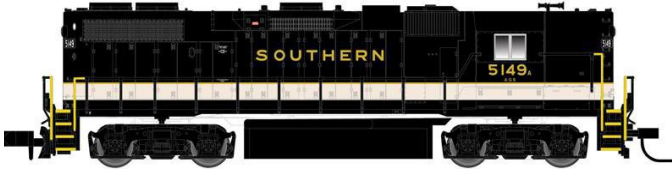

GP38-2s with a high nose short hood will be available for N de

M (Ferrocarriles Nacionales de México), Norfolk Southern, and Southern as shown here. Both DC and DCC versions will be available.



Also coming in the third quarter is a new N scale model for an NSC 50' 6" plug-door boxcar. The Atlas Master® series model will have 9' or 10' plug doors as appropriate to the prototype road, which includes British Columbia Railway, Canadian National, and Grand Trunk Western.

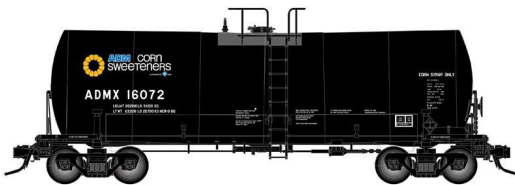

New decorating schemes will be available on Atlas' Master® series Trinity 17,600 gallon corn syrup tank car. They include

ADMX-Corn Sweeteners (above), CRGX-Cargill, DOWX-Dow Chemical, HOKX-Occidental Chemical, RRBX-Rampart Range, UNVX-Univar Canada, and Southern Pacific.

The final N scale ready-to-run model coming from Atlas during the third quarter of 2015 is a Trainman® series PS-2 covered

# MARCH NEWS | 27



hopper. Road names will be Ann Arbor, American Potash & Chemical, BNSF, DM&IR, Great Northern, Pittsburgh & West

Virginia, Rutland, and ICG shown here. For additional information on Atlas products including pricing visit [atlasrr.com](http://atlasrr.com).

**BLMA** has announced six new decorating schemes for the next production run of its ACF 70-Ton 52' steel gondola. The N scale ready-to-run model is based on the more than 11,000 prototype cars built beginning in 1948 for the PRR and several other railroads. Many remained in service until the 1990s.

In addition to Pennsylvania cars with a choice of plain or late keystone, road names will be Delaware, Lackawanna & Western, Southern Pacific, Wabash, and Sacramento Northern. Visit [blma-models.com](http://blma-models.com) for pricing and ordering information.



**Bowser Trains** is quoting a late summer release date for the next production run of N scale class H21a quad-bay coal hop-

pers. More than 31,000 of the massive prototype cars were built starting in 1915 with many still in service into the early 1970s. Oxide red cars will be available for Pennsylvania Railroad in circle and shadow keystones as well as with a Coal Goes to War slogan. Also Norfolk & Western and Virginian. Black cars in the production run will be available decorated for Penn Central,

# MARCH NEWS | 28

PRR with a keystone, and a similar car with block lettering. Visit [bowser-trains.com](http://bowser-trains.com) for pricing information.

.....



New N scale releases from **Micro-Trains Line** include a Canadian Pacific 40' boxcar with Youngstown steel door that can be positioned to reveal an interior load.



Micro-Trains heavyweight passenger car series continues with the release of this New York Central dining car.



Also new is a single-dome tank car decorated for UTLX-Hercules Powder Company and a Conrail depressed-center flat car that comes with a load.



Micro-Trains has an 89' tri-level auto rack car decorated for Trailer Train.

Contact your dealer or visit [micro-trains.com](http://micro-trains.com) for pricing and ordering information.

.....





**Walthers** is selling a Cornerstone® kit for an N scale Metro Power & Light coal-fired power plant. The N scale model has an MSRP of \$59.98. See [walthers.com](http://walthers.com) for more information.

.....

## NEW DECALS, SIGNS AND FINISHING PRODUCTS

**George's Trains** is selling an acrylic paint that is reported to be air brush-ready. The glossy finish provides a smooth decal-ready surface. The initial range of colors is formulated for Canadian equipment, however, they are well suited for use with many American railroads as well. Colors available now are CNR Green, CNR Imitation Gold, CN Red/Orange, CN Lettering Grey, CNR Grey, CNR Red, CN/VIA Blue, CN/VIA Yellow, VIA Grey, CPR Tuscan, CPR Diesel Grey, CPR Diesel Yellow, CPR Steam Grey, CPR Mineral Brown, CP Action Red, CP Action Yellow, CP Action Green, CP Bright Red, TH&B Cream, TH&B Maroon, Primer, Stencil White, and Loco Black. Additional items include Reducer, Flat Finish, and Gloss Finish. The paint is available in 1oz. bottles. Visit [georgestrains.com/proto-paint](http://georgestrains.com/proto-paint) for additional details.

.....

**Great Decals!** has introduced HO scale dulux gold decals for Virginian cranes. Sufficient material is provided to letter one crane and one boom or idler car. In addition to two styles of the Virginian road name, the set includes Virginian and Safety First

# MARCH NEWS | 30

heralds, and weight data specific to these cars. A number-jumble is included to allow modelers to decal multiple sets of this equipment. The decals are available for \$2.99 each, postpaid, from Great Decals!, P. O. Box 994, Herndon, VA 20172.

.....

**Daniel Kohlberg** has introduced HO scale decals for Pennsylvania and Penn Central X58 boxcars. The silk screened lettering sets are suitable for decorating Tangent's new X58 cars as described on page 22. For additional information including pricing and photos of prototype cars go to [home.mindspring.com/~paducah](http://home.mindspring.com/~paducah).

.....

The newest HO scale lettering systems from **Mask Island Decals** are Rock Island twin-bay feed hopper cars (item 87-287); Southern Railway 60' 16,000 and 17,000 series auto parts car (item 87-288); Norfolk & Western 5077 boxcars (item 87-289); and Virginia Central/Peoria Pekin Union 50' car (item 87290). Go to [maskislanddecals.com/home.html](http://maskislanddecals.com/home.html) for additional information.

.....

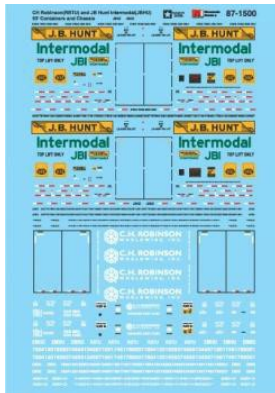
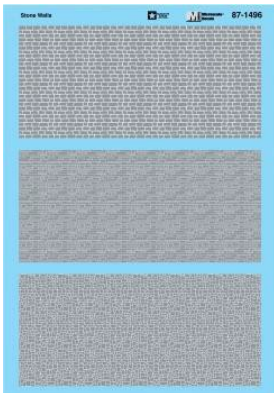

New wet decals from **Microscale Industries** include Stone Wall Graphics that has three different 4.75" x 2.25" patterns (brick, flagstone, and cobblestone) all

# MARCH NEWS | 31

printed in a gray tone. Also new is a lettering set for JB Hunt Intermodal (JBHU) and C H Robinson (RBTU) 53' containers and chassis. Additional decals recently released by Microscale include US Highway Signs, and an upgraded two-sheet set for Wabash diesel locomotives. Go to [microscale.com](http://microscale.com) for additional information.

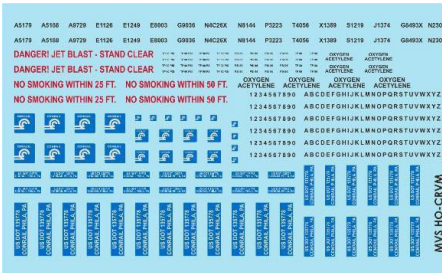

**Mount Vernon Shops** is selling HO scale decal sets for Conrail vehicles and Maintenance of Way logos. Three different sets are available that cover all eras of Conrail from 1976 to the present.

For complete details including ordering information go to [mountvernonshops.com/CRV.html](http://mountvernonshops.com/CRV.html).

## SEND US YOUR PRODUCT ANNOUNCEMENTS

If you are a hobby manufacturer with a product announcement, just [click here](#) and submit your announcement to us. Our web site and free magazine reach continues to grow, so get on board this new media train! ■

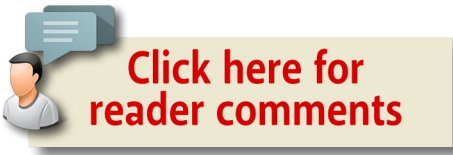



DISCLAIMER .....

The opinions expressed in this column are those of the writer and do not necessarily reflect the opinion of *Model Railroad Hobbyist* or its sponsors. Every effort is made to provide our readers with accurate and responsible news and information, however, neither *Model Railroad Hobbyist* or the writer of this column can be held responsible for any inaccuracies or typographical errors that may inadvertently appear in this column.



## THIS MONTH'S BONUS EXTRAS

MRH SUBSCRIBERS GET ACCESS TO FREE BONUS extras, but you do have to be a subscriber! That's easy because [subscribing is free \(just click this link\)](#).

The bonus extras this month include:

- High quality versions of the issue videos
- Zoomable track plan of Wally Brady's CN Railroad

To access the bonus extras, click the link below:

[\*\*BONUS DOWNLOADS FOR THIS ISSUE\*\*](#)

.....

# What if Model Railroaders had their own TV CHANNEL?

**WE DO!**



Network TV quality programming  
for model railroaders, on the web

***Watch some free samples***

*Over 80 top-quality videos produced for model  
railroaders in the last year+*





## BRIEFLY NOTED AT PRESS TIME ...

### ... Michael Pfulb 1948-2015

Mike Pfulb, owner of Mike's Backshop and a stalwart in the model railroad world of Southern California, passed away quietly February 7. He was 67. Pfulb was a founding member of the San Diego Garden Railroad Society, the California South Coast Modular On30 Group, and the Dead Rail Society.

Pfulb designed and built many layouts both indoors and out, and was responsible for a large number of people becoming enthusiastic model railroad hobbyists. He was instrumental in the introduction of battery-powered, radio-controlled locomotives beginning with large-scale models more than 25 years ago. In recent years he applied his skill in accomplishing the same in On30 and H0 scales.

He leaves his many friends with wonderful memories of him at train shows, and the way in which he reacted to children and strangers. While too many of us are leery of handing over control of our trains to a child, it was not unusual for Mike to spot a youngster, show him how to use the throttle, hand it to him and stand back to watch. In addition to model trains, Pfulb was an active surfer and had a life-long interest in automobiles. He completed his final hot rod just last summer.

Mike Pfulb is survived by his parents, a sister, his wife Ginni, two daughters, and six grandchildren.

... ExactRail has announced new paint schemes for its Platinum series H0 scale model of Bethlehem-built



# MARCH NEWS | 34

.....

3737 cu. ft. open-top hopper cars. The ready-to-run model is available in four Missouri Pacific schemes. As delivered to MP in 1977 with buzz saw logo, as delivered in May 1979 with Screaming Eagle logo, as delivered in June 1979 with Screaming Eagle logo, MP 588663 repaint following the 1976 C&EI and TO merger into MP. An undecorated kit has also been released.

... Westerfield Models has announced the availability of a new series of HO scale kits for Rock Island stock cars. The cast urethane models represent class B-2 boxcars RI began converting into stock cars in 1944. Nine variations of the model are available now with a choice of Hutchins, Murphy, or single-board roofs on either the original single-deck or subsequent double-deck versions of the converted cars. Westerfield kits include appropriate prototype decals. Trucks and couplers are not included. To order visit [westerfield.com](http://westerfield.com). The new models will also be available at the Western Prototype Modelers RPM meet in San Bernardino, CA on Saturday, March 28, 2014. ■

.....

# iwata

by ANEST IWATA

## *Just Rolling By...*

## Make It **REAL** With Iwata *Climb Aboard!*



**Eclipse  
HP - CS**

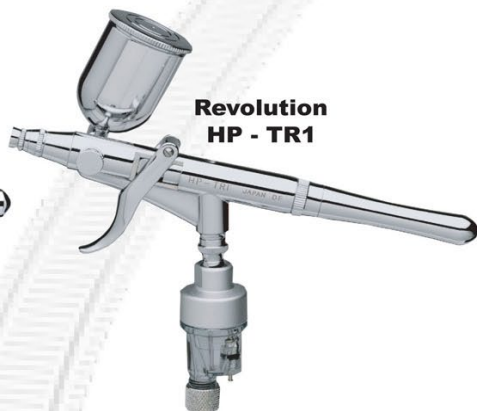

**Revolution  
HP - TR1**

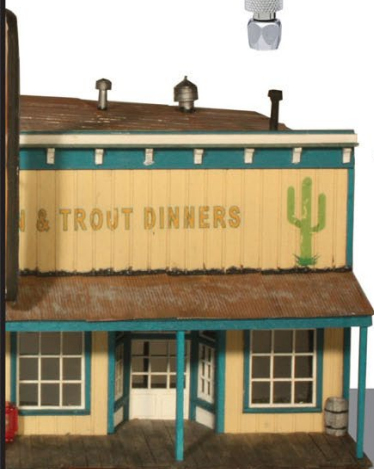

## **Visit...** [www.iwata-medea.com](http://www.iwata-medea.com)

### **To Check Out Our Full Product Line!**

*Models By... Alan Houtz,  
North American Prototype Modelers*



# SELECTED EVENTS

## March 2015

*(Please note that many events charge a fee. Check individual info website for details.)*

**AUSTRALIA, CANBERRA**, March 28-29, 27th Annual Canberra Model Railway Expo, hosted by Canberra Model Railway Club, at University of Canberra High School, 104 Baldwin Drive. Info at [canberra-model-railway-club.webs.com](http://canberra-model-railway-club.webs.com).

**CANADA, ONTARIO, CAMBRIDGE**, March 28, 32nd Annual Double Headers Model Railroad Self-Guided Layout Tour. Tickets and maps available at Hespeler Arena, 640 Ellis Road West. Info at [doubleheaders.org](http://doubleheaders.org).

**CANADA, ONTARIO, KINGSTON**, March 14-15, Rail-O-Rama Model Train Show at Ambassador Hotel, 1550 Princess Street. Hosted by Kingston Division, Canadian Railroad Historical Association. Info at [intercolonialrailway.com/CRHA](http://intercolonialrailway.com/CRHA).

**CANADA, ONTARIO, LINDSAY**, March 28-29, 41st Annual Model Railway Show hosted by the Lindsay & District Model Railroaders, at Lindsay Victoria Park Armory, 210 Kent Street West. Info at [ldmr.org/annual-show.html](http://ldmr.org/annual-show.html).

**CANADA, ONTARIO, TORONTO**, March 14, Toronto Railway Prototype Modellers Meet, featuring prototype clinics. Attendees are encouraged to bring models, whether completed or not. At Humber College, North Campus, Building B, rooms B215 & B216. Info at [torontoprototypemodellers.wordpress.com](http://torontoprototypemodellers.wordpress.com).

## SELECTED EVENTS | 2

**CALIFORNIA, BAKERSFIELD**, March 14-15, The Model Train Show, hosted by Golden Empire Historical & Modeling Society, at Kern County Fairgrounds, 1142 South P Street. Info at [gehams.org/bakersfield-train-show](http://gehams.org/bakersfield-train-show).

**CALIFORNIA, PERRIS**, March 7, Spring Railroadiana Swap Meet, at Orange Empire Railway Museum, 2201 South "A" Street. Info at [orem.org](http://orem.org).

**CALIFORNIA, SAN BERNARDINO**, March 28, 26th Annual Western Prototype Modelers Meet, with model displays, clinics, and raffle at former Santa Fe Depot on BNSF mainline. Info at [railroadprototypemodelers.org/sbdmeet.htm](http://railroadprototypemodelers.org/sbdmeet.htm). Exhibitors contact Joe D'Elia at 760- 721-3393.

**GEORGIA, ATLANTA**, March 14-15, Model Train Show, hosted by NMRA Piedmont Division, at Cobb Galleria Centre, 2 Galleria Parkway. Info at [themodeltrainshow.com](http://themodeltrainshow.com).

**GEORGIA, PORT WENTWORTH (Savannah)**, March 27-28, Savannah RPM Meet featuring clinics and prototype models, at Port Wentworth Recreation Center, 103 Turnberry Street. Info at [savannahrpm.com](http://savannahrpm.com).

**ILLINOIS, ROCKFORD**, March 28- 29, Train Show & Sale, hosted by NMRA Rock River Valley Division, at Jefferson High School, 4145 Samuelson Road. Info at [rrvd-nmra.com/events.php](http://rrvd-nmra.com/events.php).

**MICHIGAN, FARMINGTON HILLS**, March 15, Trainorama Show & Sale, hosted by Redford Model Railroad Club, at Costick Community Center, 28600 Eleven Mile Road. Info [redfordmodel-railroadclub.com](http://redfordmodel-railroadclub.com).



## SELECTED EVENTS | 3

**MISSOURI, SPRINGFIELD**, March 14, 37th Annual Train Show sponsored by Ozarks Model Railroad Association, a fun oriented family event with over 100 vendor tables. At Remington's, 1655 W. Republic Road. Info at [omraspringfield.org](http://omraspringfield.org).

**NEW YORK, ROCHESTER**, March 7-8, Open House at Rochester Model Railroad Club, 150 South Clinton Avenue. Info at [rocrrc.com/annual-open-house.html](http://rocrrc.com/annual-open-house.html).

**NORTH CAROLINA, FLETCHER**, March 6-7, 25th Annual WNC Train Show, at WNC Ag Center Expo Building, 1301 Fanning Bridge Road. Info at [asheville-trainshow.com](http://asheville-trainshow.com).

**OHIO, KIRTLAND**, March 14-15, Railfest Train Show, at Lakeland Community College. Event sponsored by NMRA Western Reserve Division 5. Info at [railfest.org](http://railfest.org).

**OKLAHOMA, TULSA**, March 20-22, 6th Annual Layout Design and Operations Meet, with clinics and noted speakers, plus operating sessions at 13 layouts. At Shriner's Temple, 28th & Sheridan. Special rates at Hampton Inn and Suites, 3418 S. 79th East Avenue. Info at [ldopsigmeet.tulsanmra.org](http://ldopsigmeet.tulsanmra.org).

**PENNSYLVANIA, GREENSBURGH (Pittsburgh)**, March 27-28, RPM-East Seminar with two days of prototype modeling presentations, displays, and vendor tables, plus Op session Thursday evening. Hosted by Division 2, MCR-NMRA at Ramada Greensburg Hotel & Conference Center, Route 30 just east of Greensburg (Formerly Sheraton Four Points). Info at [hansmanns.org/rpm\\_east](http://hansmanns.org/rpm_east).

## SELECTED EVENTS | 4

**PENNSYLVANIA, SCRANTON**, March 26-27, Fine Scale Model Railroad Expo, a specialty event dedicated to the art of craftsman kit structures and scenery building, with clinics, demonstrations, and displays. At Hilton Scranton Hotel & Conference Center, 100 Adams Avenue. Info at [modelrailroadexpo.com](http://modelrailroadexpo.com).

**UTAH, OGDEN**, March 6-8, 26th Annual Hostler Model Train Festival at Ogden's Historic Union Station. Info at [hostlers.info](http://hostlers.info).

**VERMONT, ST. ALBENS**, March 14, Vermont Rails 2015, at Collins Perley Sports Center, I89 at exit 19. Info at [nwvrailroad.org](http://nwvrailroad.org).

**VIRGINIA, ANNANDALE**, March 28, Minicon, one-day event with operating modular layouts, clinics, and contests sponsored by NMRA, Potomac Division, MER. At St. Matthew's United Methodist Church, 8617 Little River Turnpike. Info at [potomac-nmra.org](http://potomac-nmra.org).

**WASHINGTON, AUBURN (Seattle)**, March 21, 16th Annual Mini-Meet for Santa Fe Railway fans and modelers, at the Messiah Lutheran Church, 410 H Street NE. Send inquiries to John Thompson at [jthomp1945@aol.com](mailto:jthomp1945@aol.com).

### April 2015

**AUSTRALIA, NEW SOUTH WALES, BOWRAL**, April 3-5, 12th Australian Narrow Gauge Convention, sponsored by NMRA, with hands-on workshops, contests, tours, and modeling clinics on NG prototypes from Fiji, US, UK, and Australia. Info at [austnarrowgaugeconvention.com](http://austnarrowgaugeconvention.com).

**AUSTRALIA, QUEENSLAND, BRISBANE**, April 9-12, 14th National N Scale Convention, at Hotel Grand Chancellor, 23 Leichardt St, Spring Hill. Info at [facebook.com/NationalNScaleConvention2015](https://facebook.com/NationalNScaleConvention2015).

## SELECTED EVENTS | 5

**CANADA, ALBERTA, CALGARY**, April 18-19, SuperTrain – Canada’s Largest Model Train Show, at Genesis Centre, 7555 Falconridge Blvd, NE. Info at [supertrain.ca](http://supertrain.ca).

**ARIZONA, CLARKDALE**, April 11, Rails Along the River, display and swap meet at Clark Memorial Clubhouse Auditorium, 9 North Ninth Street. Info at [yrvno.info@gmail.com](mailto:yrvno.info@gmail.com).

**ARKANSAS, PINE BLUFF**, April 11, 20th Annual Railroadiana Show, at Arkansas Railroad Museum. Info at [arkansasrailroadmuseum.org](http://arkansasrailroadmuseum.org).

**CALIFORNIA, LOS ANGELES**, April 25-28 and May 2-3, Pasadena Model Railroad Club celebrating 75 years of operation on the Sierra Pacific Lines, one of the largest HO scale operating model railroads in the world. Info at [pmrrc.org/#OPENHOUSE](http://pmrrc.org/#OPENHOUSE).

**CALIFORNIA, SONORA**, April 18, Westside Logging & Mining Reunion, a rare and entirely unique opportunity to eat, drink, and talk about narrow gauge logging with like-minded fellows. Event includes clinics and a limited number of vendor tables. At Sonora Elks Club, 100 Elk Drive. Volunteers needed. Info at [westsidereunion.com](http://westsidereunion.com).

**INDIANA, MARTINSVILLE**, April 11, Spring Train Show and Meet, sponsored by NMRA Central Indiana Division, with operating layouts, clinics, and vendor tables, at National Guard Armory, 1900 Hospital Drive. Info at [cid.rail-fan.net/upcoming.html](http://cid.rail-fan.net/upcoming.html).

**INDIANA, NOBLESVILLE**, April 25, 7th Annual Hoosier On30 Mini-Meet (all scales welcome), with modules, dioramas, clinics, and swap tables, at Noblesville Community Center, 372 South 8th Street. For info contact [michelerobinson14@att.net](mailto:michelerobinson14@att.net).

## SELECTED EVENTS | 6

**MARYLAND, TIMONIUM**, April 11-12, Brass Expo in conjunction with the Great Scale Model Train Show, presented by Howard Zane, at Maryland State Fairgrounds, 2200 York Road. Info at [gsmts.com](http://gsmts.com) and also [brassexpo.com](http://brassexpo.com).

**MASSACHUSETTS, TAUNTON**, April 12, Spring TRAINing - Annual Model Train Show, at Holiday Inn Taunton-Foxboro Hotel, 700 Myles Standish Blvd. Hosted by HUB Division of NMRA. Info at [hubdiv.org](http://hubdiv.org).

**MICHIGAN, MUSKEGON**, April 26, Muskegon Railroad Historical Society Train & Hobby Show, onboard the USS LST 393, at Veterans Museum, 560 Mart Street. Info at [facebook.com/events/381878965303887](https://facebook.com/events/381878965303887),

**MISSISSIPPI, GULFPORT**, April 18, Mississippi Coast Model Railroad Museum, opening day of new museum featuring antique toy trains, operating layouts, refreshments, and door prizes, at 504 Pass Road. Info at [facebook.com/pages/Mississippi-Coast-Model-Railroad-Museum/1494896290722873](https://facebook.com/pages/Mississippi-Coast-Model-Railroad-Museum/1494896290722873).

**MISSOURI, SEDALIA**, April 25-26, Model Train Show, with operating model layouts, vendor booths with all types of train and railroadiana items for sale, at State Fairgrounds, FFA Building, 2503 West 16th Street. Proceeds benefit the American Passenger Rail Heritage Foundation. Info from Bob Cox at 660-287-1714.

**OHIO, MARION**, April 23-25, Central Ohio RPM, at Marion Union Station. Includes rail fanning, fellowship and dinner at The Shovel. Info at [facebook.com/groups/438383252883060](https://facebook.com/groups/438383252883060).



## SELECTED EVENTS | 7

**PENNSYLVANIA, MONACA**, April 12, Beaver County Spring Model Train Show, at Center Stage, 1495 Old Brodhead Road. Info at [bcmrr.railfan.net](http://bcmrr.railfan.net).

**SOUTH DAKOTA, SIOUX FALLS**, April 18-19, Greater Sioux Falls Model Railroad Swap Meet at Expo Building, W. H. Lyon Fairgrounds. Co-sponsored by Sioux Valley Model Engineers Society and NMRA Dakota Southeastern Division. Info at [svmes.net/greater-sioux-falls-model-railroad-swap-meet-and-vendor-show](http://svmes.net/greater-sioux-falls-model-railroad-swap-meet-and-vendor-show).

**WASHINGTON, BELLEVUE**, April 16-18, 30th Annual Sn3 Symposium, at Bellevue Sheraton Hotel, 100 112th Ave NE. Info at [sn3symposium-2015.com](http://sn3symposium-2015.com).

**WISCONSIN, MANITOWOC**, April 17-19, NMRA MidWest Region Convention at Holiday Inn, 4601 Calumet Avenue. Info at [mwr-nmra.org/convention/conventions.html](http://mwr-nmra.org/convention/conventions.html).

### Future 2015 (by location)

**AUSTRALIA, NEW SOUTH WALES, ALBURY,**

**LAVINGTON**, May 23-24, Annual Train Show, hosted by Murray Railway Modellers Inc., featuring model railways from different regions of Australia in N, HO, and O scale, plus a variety of vendor tables, at Mirambeena Community Centre, 19 Martha Mews. Info at [murrayrailwaymodellers.com](http://murrayrailwaymodellers.com) or phone (03) 5728 2023.

**CANADA, ONTARIO, BRAMPTON**, October 3-4, Annual Brampton Model Railway Show with 33,000 square feet of display including N, HO, O and G scale operating equipment. At Brampton Fairgrounds, 12942 Heart Lake Road. Info at [brampton-modelrailwayshow.com](http://brampton-modelrailwayshow.com).

## SELECTED EVENTS | 8

**CANADA, QUEBEC, LAVAL**, Oct 3-4, The North Shore Train Show, Complexe Multi-Sports, 955 ave Bois-de-Boulogne. Info at [salondutrainrivenord.org/english.html](http://salondutrainrivenord.org/english.html).

**ARIZONA, TUCSON**, May 29-30, Summer Train Show & Meet for all popular scales, at Tucson Expo Center, 3750 East Irvington Road. Sponsored by Gadsden Pacific Division Toy Train Operating Museum. Info at [gpdToyTrainMuseum.com](http://gpdToyTrainMuseum.com).

**CALIFORNIA, NEWARK**, May 13-17, NMRA Pacific Coast Region Convention, at Newark-Fremont Double Tree by Hilton Hotel, 39900 Balentine Drive. Info at [pcrnmra.org/conv2015](http://pcrnmra.org/conv2015).

**COLORADO, GREENWOOD VILLAGE (DENVER)**, June 3-7, NMRA Rocky Mountain Region Convention, at Sheraton DTC Hotel, 7007 South Clinton. Info at [sas2015.net](http://sas2015.net).

**CONNECTICUT, COLLINSVILLE**, May 29-30, New England/Northeast Prototype Modelers Meet. Info at [neprototypemeet.com](http://neprototypemeet.com).

**ILLINOIS, NAPERVILLE (Lisle)**, October 22-24, 22nd Annual Naperville RPM Conference, hosted by Joe D'elia, at Sheraton Lisle-Chicago Hotel, 3000 Warrenville Road. Info at [railroadprototypemodelers.org/naper\\_meet.htm](http://railroadprototypemodelers.org/naper_meet.htm).

**MASSACHUSETTS, HYANNIS**, May 16, Dinner Train Excursion aboard Cape Cod Central Railroad, sponsored by NMRA HUB Division. Info at [hubdiv.org](http://hubdiv.org) or contact Manuel Escobar at [president@hubdiv.org](mailto:president@hubdiv.org) or call 781-718-5693.

**MISSOURI, JEFFERSON CITY**, June 5-7, NMRA Mid-Continent Region Convention, at Capital Plaza Hotel, 415 West McCarty Street. Info at [showmecentral.com](http://showmecentral.com).

## SELECTED EVENTS | 9

**NEBRASKA, NORTH PLATTE**, September 18-20, Rail Fest 2015, info at [nprailfest.com](http://nprailfest.com).

**OHIO, HILLIARD**, May 15-17, 7th Ohio N-scale Weekend at Franklin County Fairgrounds, sponsored by Central Ohio N-Tra. Info at [www.centralohiontrak.org](http://www.centralohiontrak.org).

**OREGON, PORTLAND**, August 23-30, NMRA National Convention, at Double Tree by Hilton Hotel Portland. Info at [nmra2015.org](http://nmra2015.org).

**OREGON, PORTLAND**, August 28-30, National Train Show, at Portland Expo Center. Info at [nmra2015.org/trainshow](http://nmra2015.org/trainshow).

**PENNSYLVANIA, PHILADELPHIA**, May 15-17, 22nd National Model Trolley Meet at Pennsylvania Convention Center, Exhibit Hall G, Broad and Race Streets. Event sponsored by East Penn Traction Club. Info at [trolleymeet.com](http://trolleymeet.com).

**SOUTH CAROLINA, GREENVILLE**, June 5-6, Palmetto Excursion, NMRA South East Region Convention, at Greenville Marriott. Info at [palmetto-excursion.org](http://palmetto-excursion.org).

**TEXAS, HOUSTON**, September 2-5, 35th National Narrow Gauge Convention. Info at [nngc-2015.com](http://nngc-2015.com).

**VIRGINIA, FREDERICKSBURG**, September 25-26, 3rd Annual Mid-Atlantic RPM Meet, at Wingate by Wyndham Fredericksburg, 20 Sanford Drive. Info at [marpm.org](http://marpm.org).

## Future 2016 and beyond (by location)

**CANADA, BRITISH COLUMBIA, SALMON ARM**, June 15-19, 2016, Pacific Northwest Region Annual Convention and Train Show.

# SELECTED EVENTS | 10

**COLORADO, DENVER, 2017**, National Narrow Gauge Convention.

**INDIANA, INDIANAPOLIS**, July 3-10, 2016, NMRA National Convention and National Train Show. Info at [nmra2016.org](http://nmra2016.org).

**MAINE, AUGUSTA**, Sept. 7-10, 2016, 36th National Narrow Gauge Convention. Info at [nngc2016.org](http://nngc2016.org).

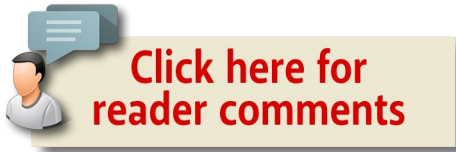

## ADVERTISEMENT

# END OF TRAIN DEVICE

FLASH CIRCUIT  
UNDER TRUCK

TRACK  
POWERED



READY TO RUN!

**Bright Red  
Flashing Light!**

Installs in minutes  
with no freight car  
modification required!

**RE RING**  
ENGINEERING

Patented Technology - US Patent 7,549,609

**Does not affect Load!**

↓ Car without Load ↓

↓ Car with Load ↓



For video  
and more  
click here!

MRHMAG.COM

- TABLE OF CONTENTS
- INDEX



# WOW!

## Premier Scale Trees



Many species of  
Conifer trees available!

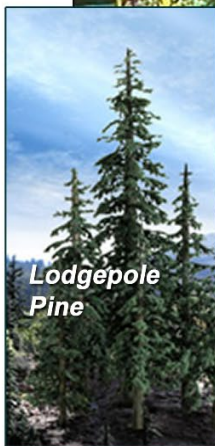

Lodgepole  
Pine



Green  
Spruce

Blue  
Spruce

Also see our other  
conifer offerings ...

Click for  
more -  
lots more!

# Clickable advertiser index – 1

[Accu-Lites](#)

[American Ltd \(San Juan\)](#)

[ANE Models](#)

[Archer Fine Transfers](#)

[Athearn](#)

[Atlas Model Railroad Co.](#)

[Bachmann](#)

[Backdrop Junction](#)

[Berrett Hill Trains](#)

[Blair Line](#)

[BLMA](#)

[Bowser](#)

[Brass Expo \(Howard Zane Asc.\)](#)

[Caboose Hobbies](#)

[Canyon Creek Scenics](#)

[Clever Models](#)

[Coastmans Scenic Products](#)

[Coffman Graphics](#)

[Con-Cor](#)

[Credit Valley Railway](#)

[DCC by Design](#)

[Deepwoods Software](#)

[Digitrax \(2 page spread\)](#)

[East Penn Traction Club](#)

[ESU LokSound](#)

[Fast Tracks](#)

[Fifer Hobby Supply](#)

[Fine Scale MR Expo](#)

[Fox Valley Models](#)

[George's Trains](#)

[GLX Scale Models](#)

[Great Decals](#)

[Hobby-On \(MRS Hobby\)](#)

[Iowa Scaled Engineering](#)

[Iwata-Medea](#)

[Jelsma Graphics](#)

[Ken Patterson.com](#)

[Litghts 4 Models](#)

[Litchfield Station](#)

[Logic Rail Technologies](#)

[Microscale](#)

[Minimalist Model Railroad](#)

[Model Railroad Benchwork \(1\)](#)

[Model Railroad Benchwork \(2\)](#)

[Model Railroad Tunnels](#)

[Model Rectifier Corporation](#)

[Monroe Models](#)

[Motrak Models](#)

[Mountain Subdivision Hobbies](#)

[Mr. Detail Parts](#)

[MRH Store \(Model Trains Video\) \(1\)](#)

[Mt. Albert Scale Models](#)

[M.T.H.](#)

[Nano-Oil](#)

[Nashua Valley Railroad Assoc.](#)

[NCE \(2 page spread\)](#)

[Nick & Nora Design](#)

[North American Railcar](#)

[Ottawa Train Expo](#)

[Portland National Train Show](#)

[Precision Design Co.](#)

[RailMaster Hobbies](#)

[Railroad Explorer](#)

[Rapido \(1\)](#)

# Clickable advertiser index – 2

[Rapido \(2\)](#)

[Ring Engineering \(1\)](#)

[Ring Engineering \(2\)](#)

[Rocky Mountain Train Show](#)

[RR-CirKits](#)

[RSlaserKits, Inc.](#)

[Rulers-of-the-World](#)

[Rusty Stumps](#)

[Streamlined Backshop](#)

[Scenic Express](#)

[Scotty Mason Show](#)

[Signature Press](#)

[Soundtraxx](#)

[Southern Digital](#)

[TAM Valley Depot](#)

[The National Train Show](#)

[Tony's Train Exchange](#)

[TrainMasters TV \(1\)](#)

[TrainMasters TV \(2\)](#)

[TrainMasters TV \(3\)](#)

[Traintek](#)

[TrainWorld](#)

[True Scene Modeling](#)

[Westerfield Models](#)

[Yankee Dabblers](#)

[Yarmouth Model Works](#)

# Clickable "other" index

---

[Other – Bonus Extras](#)

[Other – Cover](#)

[Other – Derailments](#)

[Other – Hobby Marketplace](#)

[Other – MRH Sponsors](#)

[Other – Staff Notes](#)

[Other – Table of Contents](#)



DOWNLOAD PORTRAIT



DOWNLOAD LANDSCAPE



# REVERSE RUNNING

commentary

JOE FUGATE  
.....



[Click here for  
reader comments](#)

## THE END OF YOUTH IN THE HOBBY?

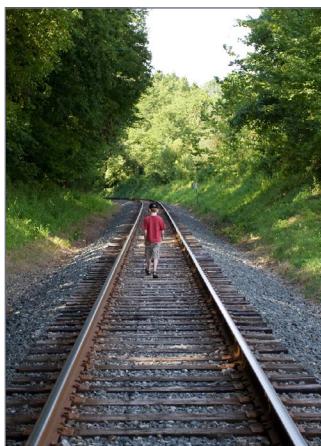

### I'LL JUST GET RIGHT TO IT:

are us older guys in the hobby killing the hobby for the youngsters?

Marketing 101 says you go where the people are if you want to successfully promote something, and for today's youngsters, that's online. Facebook is becoming somewhat passé for teens (but not irrelevant), currently apps like Instagram are the hottest thing.

Just bring up Facebook on the MRH forum and the Facebook detractors come out in droves, insisting that people should not waste their time on any social network, social network founders are evil, and so on. Now wait a minute – that's where the next generation is largely hanging out – on social networks.

So you're actually suggesting we old codgers just ignore hanging out where the kids are?

▶ **STEPPING OUTSIDE THE BOX WITH A CONTRARY VIEW**



Then we'll have a discussion of DCC throttle controller evolution. The younger element on the MRH forum suggest we explore smartphone interfaces, look at how the video game interfaces work ... and it's the same story. The older majority just poo-poo anything but a 1950's style big knob and a toggle reverser.

So you're actually suggesting we old codgers abandon looking at updating the throttle interface for the next generation?

I could go on with many more examples, but my point here is simple: we like to blame lack of hobby shops, how railroads have changed, and so on for the lack of youth being interested in the model train hobby. We seem to be insisting the youth adopt the ways of us old codgers or forget it. We don't seem willing for the hobby to evolve in ways more likely to attract youth.

More often than we're willing to admit, I think we need to go look in the mirror and ask ourselves: how have I helped the hobby evolve to become more attractive to the youngsters? Or am I bellyaching about how the local hobby shops are dying, telling everyone I prefer paper pubs over digital, broadcasting how I'd never own a smartphone, complaining about today's generation just staring at a screen all day, and discouraging other modelers from getting on social media every time the subject comes up?

I could provide rebuttals to each of these points and show how today's youth could be attracted more to our hobby if we'd promote it evolving but here's one: the Maker Movement. The kids (and their parents) are looking to unplug and do creative things with their hands. Acadamia is starting to realize how great model railroading is as a Maker hobby. See this YouTube video for more:

[youtube.com/watch?v=IceL7RkYjV8](https://www.youtube.com/watch?v=IceL7RkYjV8)

Instead of complaining how the hobby has changed, how about promoting ways to evolve? Otherwise we might face this sad epitaph: *It died because **they** would not allow it to adapt.* ☑



# DERAILMENTS

compiled by the  
MRH STAFF  
.....



[Click here for  
reader comments](#)



S. Sackett

What did you expect, kid? That photo was taken  
ages ago!

► BIZARRE FACTS AND HUMOR (SUPPOSEDLY)

# UNBELIEVABLE TRAIN LAWS ...

In Wisconsin, it is illegal to kiss on a train.

In Texas, when two trains meet each other at a railroad crossing, each shall come to a full stop. A given train can only proceed once the other has gone.

In West Virginia, when a railroad passes within 1 mile of a community of 100 or more people in it, they must build a station and stop there regularly to pick up and drop off passengers.

## DID YOU KNOW ...

Total area of contact between train wheels and rail is a little larger than one silver dollar.

The heaviest train ever recorded weighted 95,000 tons! This freight train from Australia was 7.3 kilometers long and had the weight of 27 thousand fully-grown elephants.

## Coming next issue ...

- MRH's new Imagineering column debut
- Kitbash a Conrail GP35
- Pine trees by Bob Grech
- Rick Brodzinsky's N-Scale JACALAR
- Part 3 of SP Passenger train modeling by V.S. Roseman
- SP GE Dash 7 finale
- And lots more ...

