

Micro-layouts • SP GP9 • SoundTraxx car decoder

Model Railroad Hobbyist magazine™

September 2014

Price: Forever Free



Looking for the Portrait version? [Click here ...](#)

HAVING FUN WITH TRAINS

Neil Schofield builds ... **Agway Feed**



Standard edition - Landscape



download



contents



index

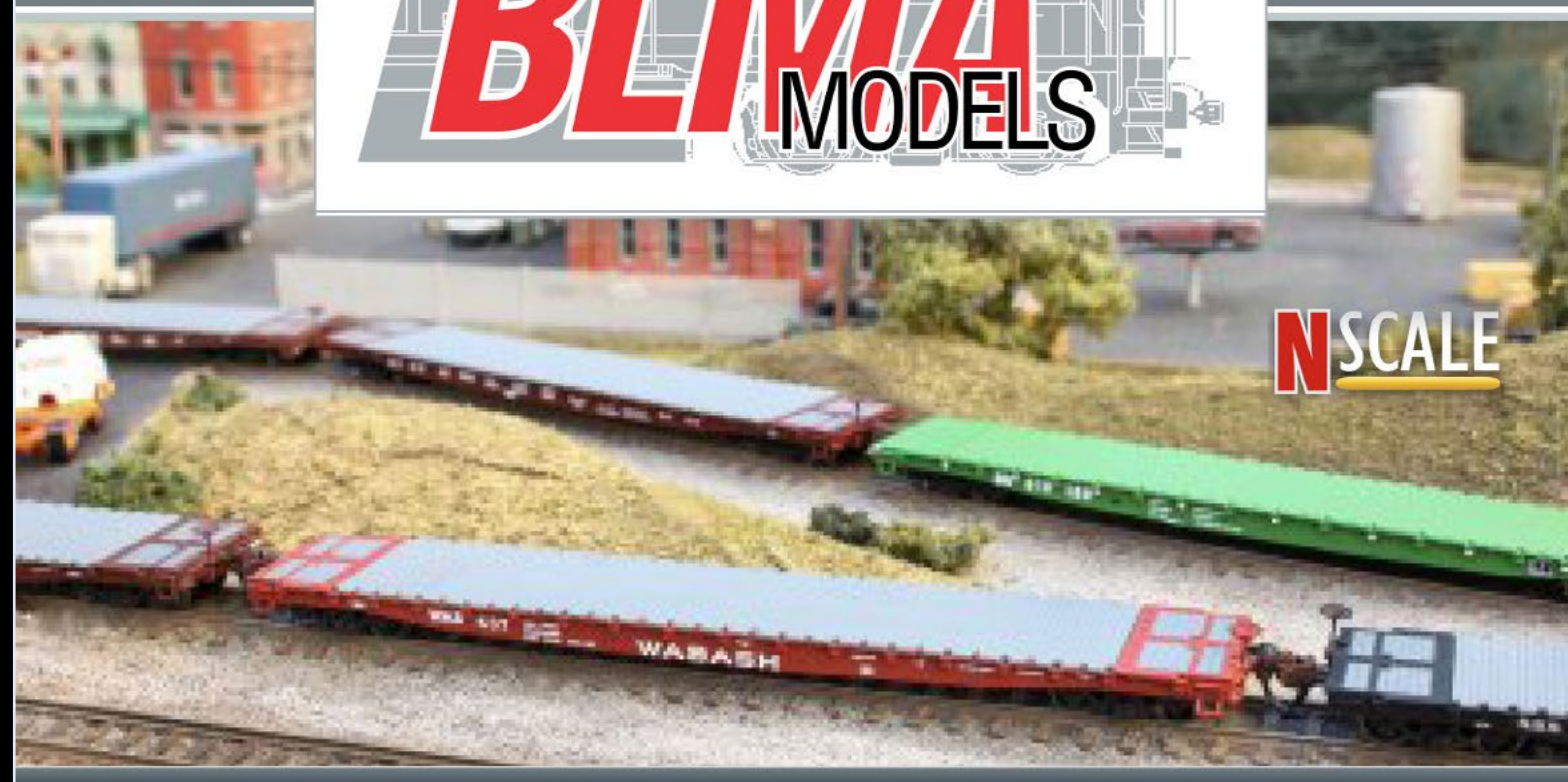
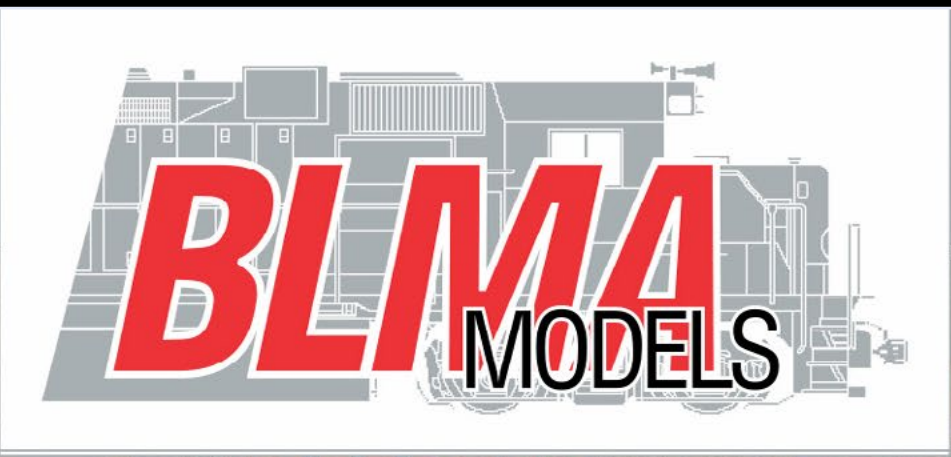

General Steel Castings 60' FLAT CAR

COMING SOON IN SIX PAINT SCHEMES!

▶ ORDER BY: **September 15th** ▶ DELIVERY BY: **Early 2015**

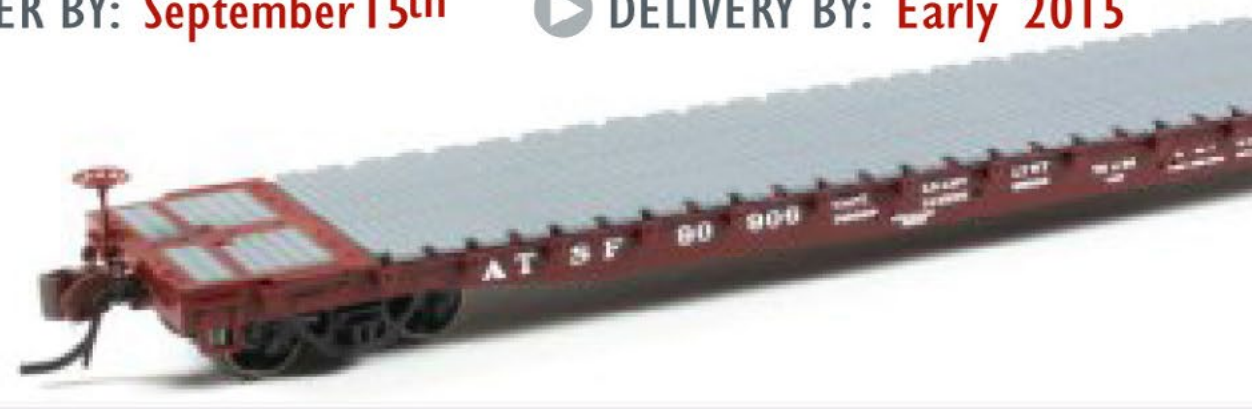

CLICK HERE TO SEE MORE



MRH-Sep 2014



Model Railroad Hobbyist magazine™

Issue 55

Front Cover: Neil Schofield shows how he built and detailed his HO Agway Feed Mill in this issue. You'll pick up lots of tips and tricks you can use on any railroad industry project from Neil in this issue's cover story.

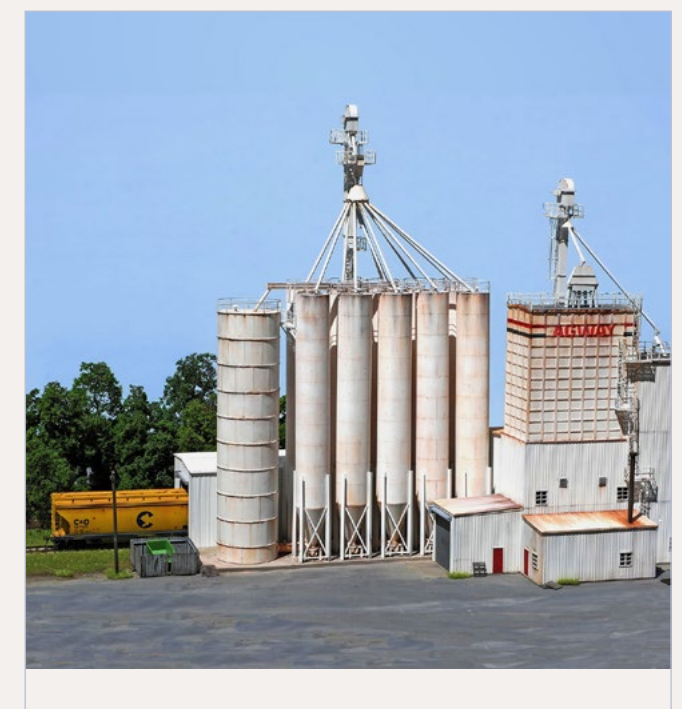

ISSN 2152-7423

Editorial Staff

Joe D. Fugate, Publisher and Editor
Don Hanley, Assistant Editor

Production

Patty Fugate, pasteup and layout
Joe Brugger, copy editing
Mike Dodd, copy editing

Technical Assistants

Jeff Shultz
Jimmy Simmons

Advertising

Les Halmos, Account Manager
Daniel Nava, Advertising Assistant
Jean-François Delisle, Marketing Assistant

Columnists

Richard Bale, News and events
Jeff Shultz, News and events
Les Halmos, Modular railroading
Ken Patterson, Reporter at large
Bruce Petrarca, DCC

Special Correspondents

Joe Brugger, Questions & answers
Charlie Comstock, Contributing editor

Published for the glory of God. [What's this?](#)

Issue password: Sep2014

Cover and MRH masthead

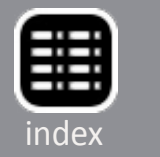



click to learn more about this sponsor



click to learn more about this sponsor



NEW SPONSOR!



NEW SPONSOR!



click to learn more about this sponsor



click to learn more about this sponsor



click to learn more about this sponsor



NEW SPONSOR!



NEW SPONSOR!



click to learn more about this sponsor



click to learn more about this sponsor

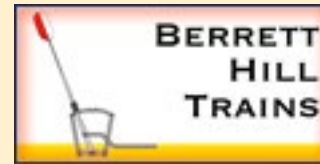

NEW SPONSOR!



click to learn more about this sponsor



click to learn more about this sponsor



NEW SPONSOR!



click to learn more about this sponsor



NEW SPONSOR!



NEW SPONSOR!



click to learn more about this sponsor



click to learn more about this sponsor



NEW SPONSOR!



click to learn more about this sponsor



click to learn more about this sponsor



click to learn more about this sponsor



NEW SPONSOR!



click to learn more about this sponsor



click to learn more about this sponsor



click to learn more about this sponsor



NEW SPONSOR!



click to learn more about this sponsor



click to learn more about this sponsor



NEW SPONSOR!



click to learn more about this sponsor



click to learn more about this sponsor



click to learn more about this sponsor



click to learn more about this sponsor



click to learn more about this sponsor



NEW SPONSOR!



click to learn more about this sponsor



click to learn more about this sponsor



click to learn more about this sponsor



click to learn more about this sponsor



NEW SPONSOR!



click to learn more about this sponsor



click to learn more about this sponsor



click to learn more about this sponsor



click to learn more about this sponsor



NEW SPONSOR!



NEW SPONSOR!



click to learn more about this sponsor



click to learn more about this sponsor



NEW SPONSOR!



click to learn more about this sponsor



click to learn more about this sponsor



NEW SPONSOR!



click to learn more about this sponsor

100,000+ unique device views per month...

Tell me more

Want your logo on this page?

Click to find out how....



Looking for something? Check our Hobby Marketplace!

Take me there

Table of Contents - 1

Main Features

*Click title
to view*



Minimum space layouts

Having more fun in less space

From the website by Carl Arendt and Gert Wierbos



Agway feed mill

Scratchbuilding a modern-day feed mill

by Neil Schofield



SP GP9 commuter locomotive

Build this unique Southern Pacific locomotive

by Koos Fockens



Turntable bridge with an arch

Add this arch to your turntable

By Mike Holly



July 2014 St. Louis RPM meet report

A meet coordinator looks at this year's St. Louis RPM

by John Golden



First Look: USATC S100 steamer

Side-tank steam loco from Rivarossi/Hornby

by the MRH Staff



September Hobby News

Industry news, product announcements, and events

by Richard Bale & Jeff Shultz

Table of Contents - 2

Other Features

*Click title
to view*

Designing for operations

Publisher's musings

by Joe Fugate

MRH Staff Notes

Hobby movie needs your help

by the MRH staff

MRH Q-A-T

Questions, Answers, and Tips

compiled by Joe Brugger

Hobby Marketplace

Vendor ads

Derailments

Bizarre facts / humor (allegedly)

Columns

Benchwork, roadbed, track

Up the creek

by Charlie Comstock

SoundTraxx SoundCar decoder

DCC Impulses

by Bruce Petrarca

Layout building productivity

Getting Real

by Mike Rose

21st column for MRH

What's Neat

by Ken Patterson

Dead frog society

Reverse Running

by Charlie Comstock

Subscriber-only extras (*subscribers click here to access*)



HO
SCALE



ORDER DEADLINE: SEPTEMBER 30TH

VIA & Canadian Pacific FP9A and F9B Locomotives

www.rapidotrains.com

MRH-Sep 2014



Designing for operation

Making sure every track has a well-understood purpose



Publisher's Musings

by Joe Fugate

When you look at a track plan, can you readily identify every track's purpose? Real railroads don't select track arrangements because they "look cool," they put tracks where they do because every track has a purpose.

I remember the very first track plan I ever drew. First, I just *knew* the plan had to fit onto a ping-pong sized table, so obviously it needed to be a loop of track. Next, I thought a crossing would be cool, so I tried to work that in. Then I had an exciting prototype photo of a double-track line with a crossover, so I added a second track and a crossover ...

I ended up with a total mess, crossings and crossovers helter-skelter on the plan. I had no sense of why those track arrangements existed, except that they looked cool.

I now realize that I had no sense of how a railroad really did what it did. I didn't have a clue of how to do a decent track plan that would give me a satisfying layout.

So what's it take to learn how to do track planning right, where every track has a realistic sense of purpose and no track is wasted or excess?



BACHMANN

**WHAT WILL YOU
CREATE WITH OUR
NEW HO FLEX TRACK?**

Made from all new tooling, our nickel silver Code 100 Flex Track features American-style finescale ABS plastic wood-grained ties. Offered in 36" sections, this track conforms to NMRA standards. With the ability to bend to variable curves and to use the ballast and roadbed of your choice, what will you be inspired to create?

Features:

- all-new tooling
- Code 100 nickel silver rail
- American-style finescale black ABS plastic wood-grained ties
- low-profile ties with tie plates and spike heads
- conforms to NMRA track standards

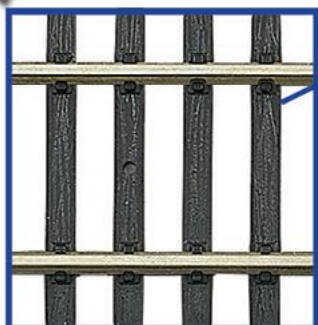

SHIPPING NOW!
Boxes of 25 pieces MSRP \$199.00
(MSRP per individual track \$7.96)
Item No. 44371 HO Flex Track (25 pieces/box)

Click for
more information.



Bachmann Industries, Inc. • 1400 East Erie Avenue • Philadelphia, PA 19124 USA • www.bachmantrains.com

Click to learn more.

There's no better way to understand how railroads use these tracks than to go to a realistic op session and run some trains. To do that, you need to get yourself invited to some more serious operating sessions.

More and more meets around operations are springing up, so one thing you can do is to join the Operations Special Interest Group (OpSIG). Here's their URL: opsig.org ... they serve as a gateway to operation events in many various places.

You can also come post on the MRH forum that you're looking to attend an op session somewhere. If you subscribe to MRH and then pin your location on the MRH members map (mrhmag.com/community/mrh-members-map), you will find out who is close to you and you can link up with them.

Even if you have to drive three or four hours to get to a session, that is a great investment. What you will learn will save you



Announcing our **newest**
HO-Scale Freight Car Loads ...



Intermountain AAR 2-Bay Hopper
Coal



Rapido 53' Mill Gondola
Scrap Metal



Bachmann 40' Mill Gondola
Scrap Metal



Accurail 70 Ton 3-Bay Hopper
Gravel

Order yours today at www.motrakmodels.net



many hours and dollars of wasted resources building a layout that you just get to tear out because it isn't satisfying.

From operation experience, you will learn about facing point and trailing point spurs, runaround tracks, passing tracks, cross-overs, staging tracks ... many kinds of tracks and their purpose. You also may encounter things like a helix, reverse loops, wyes, and how model railroads use them to manage the flow of trains on a layout.

You should also make sure to try different jobs at these op sessions. Try running through trains and compare them to running a local or a turn. Also try a yardmaster switching job. If the position is available, try an industrial area switching job, or an engine hostler job.

From this, you will learn what all these different kinds of tracks are for, and you will have a much better sense of what a good track plan needs.

As for books, check out John Armstrong's *Track Planning for Realistic Operation*. You can get it on Amazon here: amzn.com/0890242275.

John takes you step-by-step through the different kinds of track arrangements on the prototype and what your options are for representing them on a model railroad track plan.

From my own experience of running trains in op sessions like this, and from studying John's *Track Planning for Realistic Operation* book, it dawned on me that you should be able to do some computations on any track plan and be able to somewhat determine its operational potential.

Turns out, someone else came to that same conclusion about being able to apply mathematical formulas to determine a track plan's operating potential. Dr. Roy F. Dohn, way back in the June 1968 issue of *Model Railroader*, published an article "Layout Plans by Formula". I took Dr. Dohn's formulas and updated them to

HO
SCALE

BABY. IT'S COLD OUTSIDE!



**CLICK HERE
TO ORDER!**

ORDER DEADLINE: SEPTEMBER 30TH

**"Oh, So Steamy"
STEAM GENERATOR CARS**

www.rapidotrains.com



work with state-of-the-art layout design techniques. Next month, we'll present my updated layout design analysis formulas (I call them Operational Potential Stats) so you can do this analysis.

In my October editorial, I'll discuss how these Operational Potential Stats can be used to evaluate different layout designs and their operating potential.

In the meantime, go get yourself invited to some operating sessions! Barring that, at least get some of our Ops Live videos, and study what's going on in them. The newest Op Live volume on Mike Confalone's Allagash Railway is just being released, so make sure to and check it out! 

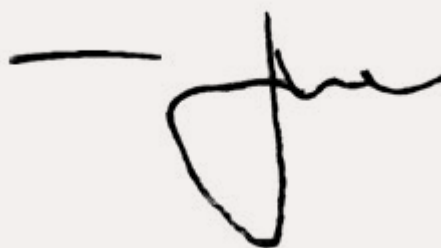

 **Reader Feedback**
(click here) 

DON'T BE FOOLED BY OUR "STIFF" COMPETITION.

There's only one true Super-Flex Track® on the market. Other brands may say their track is flexible, but we feel that a picture is worth a thousand words.

SHOP NOW!

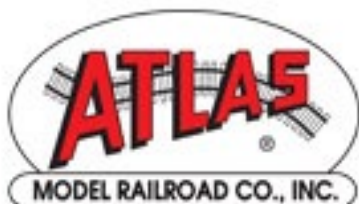

ATLAS SUPER-FLEX TRACK®
the original and still the best.

ACCEPT NO IMITATORS.

NEW! FREIGHT CRATE

Rolling Stock Transport Box
Secure storage and transport for your delicate models



You have invested heavily in your collection of rolling stock, now you can transport and store them confidently with Fast Tracks

FREIGHT CRATE

- Stackable
- Secure, locking lid
- Assembles in 15-30 minutes
- Pre-cut bubble wrap cradles included
- Precision cut from 1/8" hardboard
- Easy to assemble tabbed construction
- Designed to fit equipment precisely - no compromises necessary!



Click here to visit Fast Tracks and order your **FREIGHTCRATE** today!

FAST TRACKS
www.handlaidtrack.com
service@fast-tracks.net
1-888-252-3895



Notes from the MRH STAFF

Hobby project needs your help, Yes It's a Model siesta, would you like a hard copy and more ...

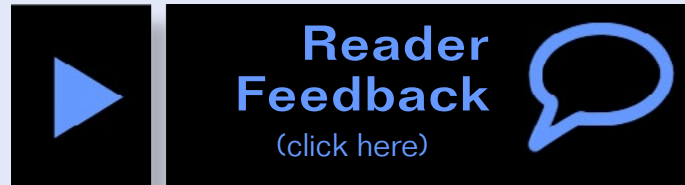

Hobby documentary project needs your help

Sara Kelly, an independent video journalist, embarked on making a video documentary about model railroaders a couple of years ago.

Sara's not a model railroader, but her goal is to tell an accurate story about who model railroaders are, and why they find the hobby of model trains so fascinating. Sara has been on the MRH podcast twice (see mrhmag.com/podcast/episodes).

We believe Sara's doing a superb job conveying what our beloved hobby is all about, and frankly, we're thrilled to see this project happening. There's a good discussion thread about this project on the MRH website, see: mrhmag.com/node/18965.

After getting some initial footage in the can, Sara now needs funding get over the hump on this project. If you've ever wondered how you could help promote the hobby with the public at large, here's your chance to make a difference.

Sara has a Kickstarter project to get the added funding she needs to complete her video documentary. Kickstarter is a new "crowd-sourcing" website that allows all of us donate funds to worthy projects we'd like to see go forward.

Help Indie filmmaker Sara Kelly tell our hobby's story ...

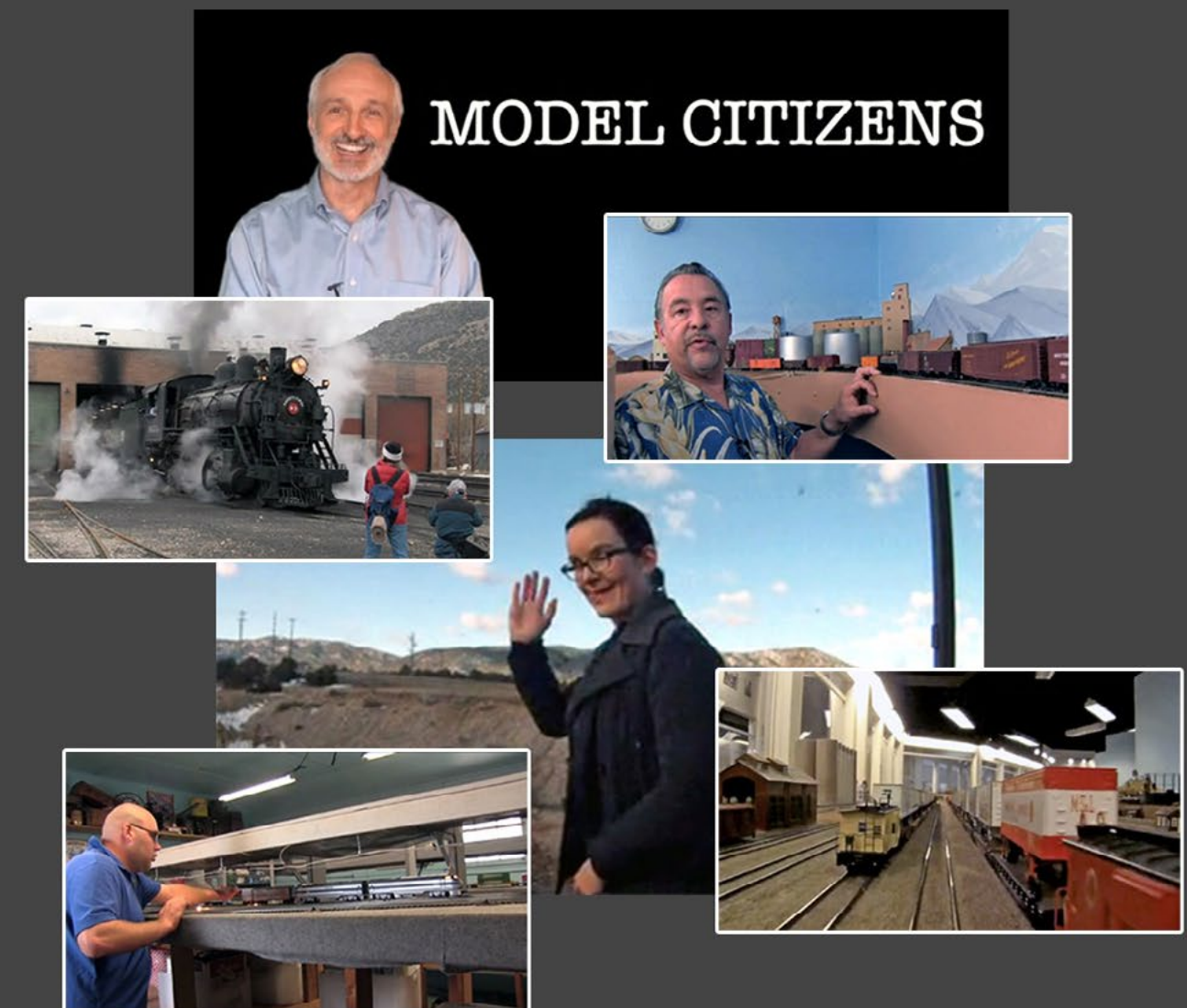

**Yes, tell me how I
can help ...**

Click here



August 2014 MRH Ratings

The five top-rated articles in the [August 2014](#) issue of MRH are:

- 4.8 Rustbucket weathering
- 4.6 DCC Impulses: HO DCC sound installation tips
- 4.6 Getting Real: Layout building productivity, part 1
- 4.6 What's Neat: Signal tower scene design
- 4.6 Building your first resin house car

- Issue overall: 4.8

Please rate the articles!

Click the reader feedback button on each article and select the star rating you think each article deserves. **Thank you!**

MRH feels this project is very worthwhile and we've donated funds to it. We'd like to challenge all of our readers to likewise donate a few dollars to this project.

We have 30,000 subscribers and an estimated 70,000 readers – if just 4% of you will donate \$15 to this project, Sara will have *all* the funds she needs. **But you will need to hurry, since Sara's Kickstarter project ends by September 4th.**

Is it worth \$15 for you to see one of the most important video documentaries on model railroading to date get out to the public? We certainly think so. Thanks to this Kickstarter project, it's possible for all of us to do something to pass on something of the joy of this hobby we all love to everyone else.

To see more, visit modelcitizensmovie.com.

Advertisement



CABOOSE HOBBIES
WORLD FAMOUS
MODEL TRAIN STORE
Since 1938!

The World's Largest Model Train Store!

Model trains G to Z, DCC, brass models, kits, RTR, collectable models, scenery, structures, books, magazines, DVD's, hobby tools & supplies and a full service repair department.

WWW.CABOOSEHOBBIES.COM



Advertisement

Want better looking diesels?

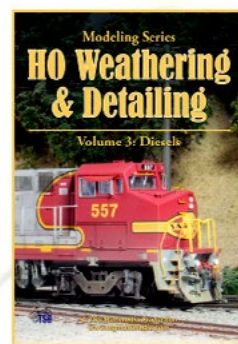

PREVIEW
VOLUME 3

See two new videos about weathering, detailing and lighting, too!

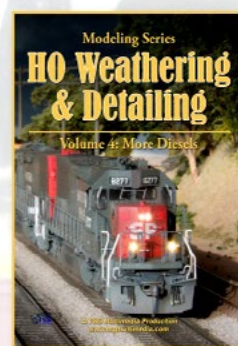

PREVIEW
VOLUME 4

TSG Multimedia

When talking to hobby vendors, please remember to mention MRH.



NEW for SEPTEMBER

87-1478 & 60-1478
Department of Defense (DODX)
Boxcars, Tank Cars, and Flat Cars

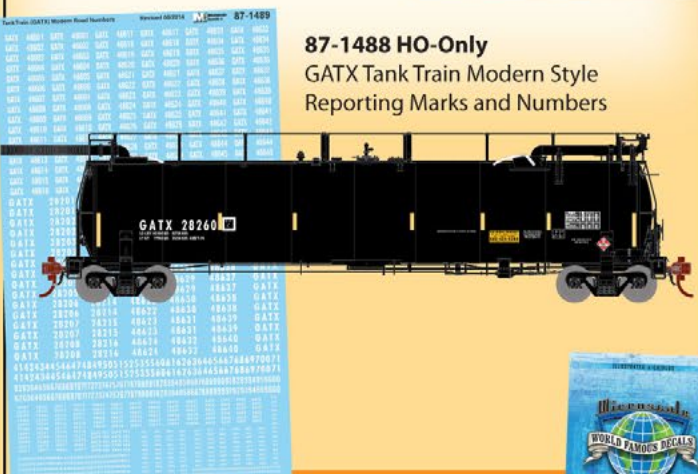
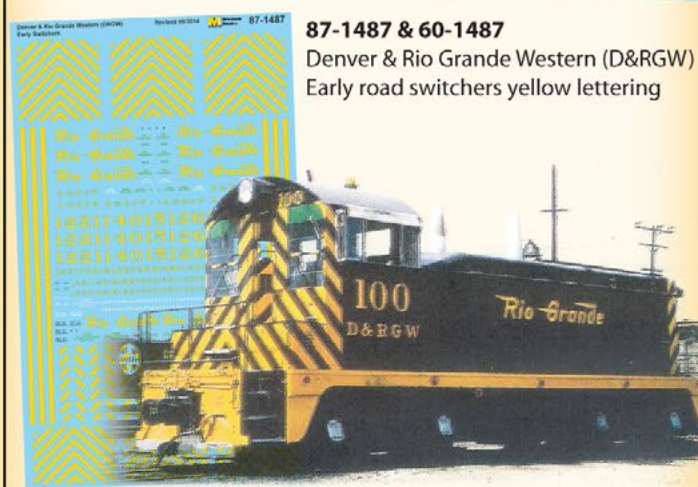
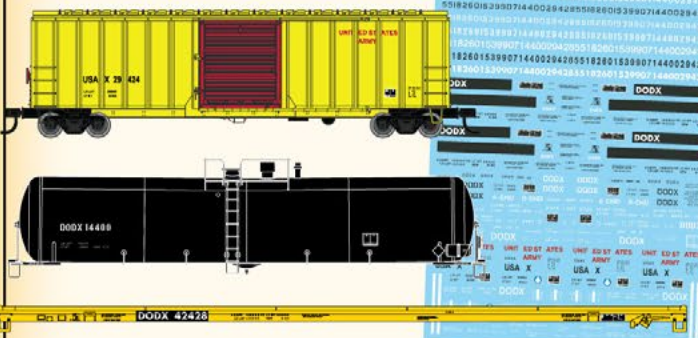

Click to View Online Catalog



Microscale Decals © microscale.com MADE IN THE USA

Yes It's a Model siesta

We're taking a one-month siesta with *Yes, It's a Model* to allow us to fit some other content into this issue. In one sense, we can make an issue as large as we want, that's true. But larger issues take longer to build and proof, so only so many pages will fit into a month.

This issue has more than enough content and there are fewer images for this month than we'd like, so we're going to skip a month. *Yes It's a Model* will be back next month, with a full collection of great modeling and superb photography.

Jeff Johnston's logging cabooses article

Speaking of changes to this issue's lineup, Jeff Johnston's logging cabooses article has been postponed to the October issue. Jeff's article is nice and big, and the magazine

was just getting a bit too fat to still get done in a month, so we pushed this article to next issue.

The monthly issue gauntlet is a balancing act. In the case of MRH, we don't have as many limitations as print, but we still have the same number of hours in a day as the print magazines do!

Would you like a hardcopy?

Model Railroad Hobbyist has traditionally been all-digital, but that's going to change come 2015.

First, we're going to start making our eBook titles available either as eBooks, softcover, or hardbound. That's right, you will have your choice, with each of the versions priced accordingly.

We're also looking into making it possible for you to order a hardcopy version of the magazine. Naturally, a paper copy of an issue of MRH won't be free, and you'll not only have to pay for the cost of the printed edition, you will also be charged shipping.

But if you absolutely feel you need a hard copy, we'll be making it available for a price.

Of course the digital version of MRH will remain free, as always.

What's new on the MRH website

If you're not visiting the MRH website from time to time, you're missing some great content. Many of the MRH website regulars say that's it's like getting an extra free magazine each month. Here's some of what you are missing:

- **Vertical easements and rigid framed steam locos**
mrhmag.com/node/18775



- Lone wolf modelers
mrhmag.com/node/15229
- Decoder Pro and QSI BEMF
mrhmag.com/node/18810
- Roadbed with Chris
mrhmag.com/node/18862
- Bridges on a grade?
mrhmag.com/node/18819
- Help building an HO exterior staircase
mrhmag.com/node/18830
- Drill press for small bits
mrhmag.com/node/18827

- Options for underneath the layout fascia
mrhmag.com/node/18729
- Second deck support on the 8th Sub
mrhmag.com/node/4446
- Turnout control state of the art for 2014?
mrhmag.com/node/18826
- Let's talk mirrors
mrhmag.com/node/10313
- Modern lights
mrhmag.com/node/18471
- Adventures in soldering
mrhmag.com/node/15313

September 2014 Bonus Extras!

Available to subscribers!

DVD and HD quality versions of this issues videos,
plus:

- Zoomable Agway Feed Mill plans
- Prototype plans of USATC S100 side-tank steamer

[Click here to access](#)



Advertisement

New Norfolk Southern Freight Cars Made Exclusive For ECR



HO
Scale

Dealer Inquiries
Are Welcome

East Coast Railroads
ECR
EastCoastRailroads.com

Click...
HERE!



- Best roadbed for quietness
mrhmag.com/node/18525
- Layout engine rosters
mrhmag.com/node/18748
- How to scale photo backdrop correctly?
mrhmag.com/node/18860
- Helpers on helix
mrhmag.com/node/18962

Enjoy the September MRH!

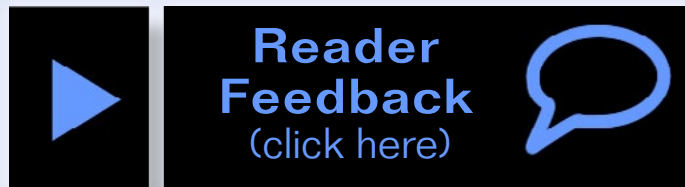

Advertisement

*It's not just a model,
it's a piece of history.*



**Bollinger Ederly
Scale Trains**

www.besttrains.com



Advertisement

TRINITY 3281



CMO - 12 road numbers \$48.95 each



CSX - 12 road numbers \$48.95 each



TILX - 6 road numbers \$48.95 each



WSOX - 6 road numbers \$48.95 each
plus CRDX and MCEX

American Limited

www.americanlimitedmodels.com



Advertisement

**HO GP60s
ARRIVING WINTER 2014**

GP60M ATSF - 4 ROAD NUMBERS

GP60B ATSF - 4 ROAD NUMBERS

**NEW TOOLING
SOUND AVAILABLE**

NORFOLK SOUTHERN - 3 ROAD NUMBERS

NORFOLK SOUTHERN - OPERATION LIFESAVER
RESERVE TODAY!

www.foxvalleymodels.com



**We're not
mind readers.
Please
click reader
feedback
buttons on
articles!**

Advertisement

Archer
FINE TRANSFERS
PROUDLY SERVING MODEL BUILDERS SINCE 1989

**THE ORIGINAL
SURFACE DETAILS™**

**CELEBRATING 25 YEARS
IN BUSINESS!**

SEPTEMBER: FREE SHIPPING!

**FREE SHIPPING ON ALL
DOMESTIC ORDERS, FREE
SHIPPING ON INTERNATIONAL
ORDERS \$25 OR MORE**

NEW RELEASES!

**WE NOW HAVE MORE
THAN 100 ITEMS FOR
RAILROAD MODELERS!**

SATISFACTION GUARANTEED!

**THANK YOU FOR 25
WONDERFUL YEARS!**

**CLICK HERE TO
VISIT OUR WEBSITE!**

*"Archer rivets
are easy to apply
and look great.
To me, they are
now a vital tool
in building
railroad models."*
Tony Thompson, Model
Railroad Author/Historian

MADE IN THE USA

Archer Fine Transfers • PO Box 1277 • Youngsville, NC 27596 • USA
(919) 570-1026 • info@archertransfers.com • archertransfers.com



**Want to
help keep
MRH free?
Then click
on Ads!**





Photo courtesy of Dave Minshall

YEAH, ITS TRUE WE HAVE A SINGLE TRACK MIND.

The ALL NEW HO SCALE SINGLE TRACK ON SNOW PLOW...WITH OPERATIONAL WINGS!

Features include:

- KADEE couplers
- correct trucks
- CODE 88 stainless steel wheels
- real chains
- operational wings
- ESU equipped decoder
- Available in CN and CP
- correct plow contour
- interchangeable cupola
- finely detailed
- Lights
- unique sound and horn

SCAN ME TO GET UPDATES!

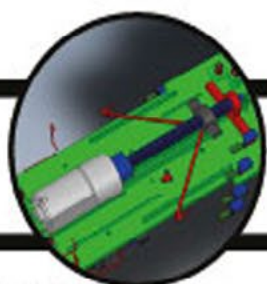
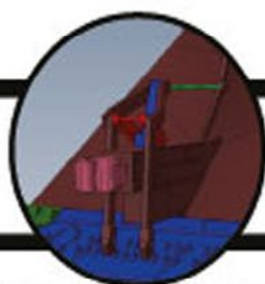

True Line Trains Exclusively distributed in Canada by Canadian Hobbycraft Ltd. 445 - 1 Edgeley Blvd, Concord, Ontario L4K 4G1
For More Info, Please Call (905) 738 - 6556 or find us online at www.truelinetrains.com Dealer Inquiries Welcome



MRRH

Questions, Answers and Tips



Reader Feedback
(click here)



QUESTIONS AND ANSWERS

Stripping a metal locomotive

Q. I have two diecast metal engines I want to strip and paint. What's the better approach, alcohol or a soda blaster? My concern is the alcohol reacting with the zinc, and causing damage to the loco body.

– Retired Alex

A. We're talking about diecast metal [1] here. Think Bowser, Hobbytown, Cary or old Penn-Line models. This answer may not help with brass or plastic models. Some techniques that work perfectly well on cast metal will damage brass or plastic. You have been warned.

Ken Rickman: "I've never heard of alcohol reacting with metal. It's a pretty innocuous paint stripper, so that's what I'd use. A soda blaster is nice for stubborn bits of paint which don't want



to come off any other way, but I'd hate to try to use one to strip a complete model."

Doug M. agrees: "I've always had success with alcohol. It has taken paint off of some GHQ white metal vehicles before. Both of those had thin coats of paint on them to start with. Let it soak overnight and then start scrubbing the paint with an old toothbrush. Once you break into the paint, the alcohol will penetrate better and it will be easier to strip. I use 91% isopropyl from the drug store. It seems to work best as far as all the concentrations go.

Ghost Train: "Of course, it all depends what type of paint (and primer if any) was originally used on the item. When in doubt test your method on a small area not normally seen."

Doug M. and Glen Wasson: "Other household items will also strip paint. Windex, Castrol Super Clean and sometimes Simple Green may also work."



1. Rejuvenate an old engine like this metal Hobbytown Alco by stripping it with household items and repainting it.

Tim Warris of Fast Tracks: "My go-to paint stripper has always been Easy Off oven cleaner. Use the full strength stuff. Soak the body thoroughly and let it sit in the sink for 20 to 30 minutes. Clean the paint off with a toothbrush. Works great and doesn't harm plastic."

Easy Off requires more attention than alcohol. "I didn't suggest Easy Off, since the OP asked about alcohol, but that would be my first choice as well," Ken Rickman said. "It is somewhat more reactive than alcohol, so some testing and care would likely be in order. I find alcohol to be quite safe."

Ralph, who goes by CN6401, added another caution: "There are two types of Easy Off, one that gets sprayed on the oven and the oven turned on – it's very corrosive and the gas is dangerous."

The other works on a cold oven. The fume-free version is currently sold in a blue container. So read the instructions to avoid buying a can of the wrong stuff.

"The second type is the one that works for modeling. This type is sprayed on, let sit and then wiped off. It works the same way with models. It's less corrosive but it still gives off gases, so don't lean directly over the model while you're scrubbing with that toothbrush," Ralph said. "I suggest you wear latex gloves when handling the model. It washes off with water." Open a window and run an exhaust fan to get some ventilation.

With these suggestions, Retired Alex ran his own tests. "I took leftover parts and sprayed one with oven cleaner and soaked the other in a container of alcohol. Both worked without doing any damage to the diecast, which was my main concern."

Oven cleaner – “No-name brand from the local Independent Grocery store, works cold or at a temp of 200 degrees in the oven. I used it cold, sprayed the part and let it sit for two hours. It turned the paint back to a liquid (gummy) state and was easily washed off, some picking required in corners and around fine details. Overall not a bad result; however, it did leave the metal with a very dark gray, dull appearance.”

Alcohol – “I didn’t have any 91% on hand so tried just the 70% strength. Soaked the part in a tub of alcohol for two hours. At first glance it appeared to do nothing, but when handled, the paint came off in sheets. The alcohol seems to have attacked the bond between the paint and the metal. A lot of picking will be required around fine details, but I have a couple of brass brushes in my outdoor workshop and will try them. It also left the metal with a bright shiny appearance, almost like brand new.”

Brake fluid is an option. Some brake fluids remove paint. They don’t damage most metals but can make styrene plastic brittle. Brake fluid can be washed off with water. Keep it away from painted surfaces and furniture. Because so many different plastics are used in models, it has become less popular for stripping paint. Some brands feel greasy and are hard to wash off completely.

Don Andrews reported losing a shell that he stripped, cleaned, washed and repainted. “The brake fluid that had been absorbed into the plastic caused a chemical change in the plastic polymers that ruined the shell. The damage was not apparent until sometime later,” Don said.

Brake fluids have changed since modelers adopted them decades ago for stripping paint.

Rob in Texas reports, “I have used brake fluid in the past, DOT 3 type, and the paint falls right off. I rinse the items in water and in fact soak them in a container filled with water for a few days ... It cleans models very well. After they soak in water for a few days I rinse and let them air dry and repaint.”

Alex, aka Drewrail, adds, “If you go the brake fluid route you need to make sure the label has a warning about not to spill it on the paint. Newer types of brake fluid no longer have the chemical makeup that will harm the paint. I used the store brand from Auto Zone.”

Ken Glover’s paint stripping saga:

mrhmag.com/node/13642

Stripping paint from metal:

mrhmag.com/node/18190

Advice on preparing metal:

mrhmag.com/node/14495

– MRH

Q. What are special instructions?

– Mike B.

A. “Special rules” or “system special instructions” cover situations that are specific to a particular area or situation on a railroad. They are detailed instructions that call for actions over and above those required by the company rulebook. Here’s the usual warning: different railroads have different names for these things, and special rules on one railroad will possibly cover different topics than on another outfit.

Many model railroaders create their own timetables and rule books, but it’s a rare model railroad that also has its own set

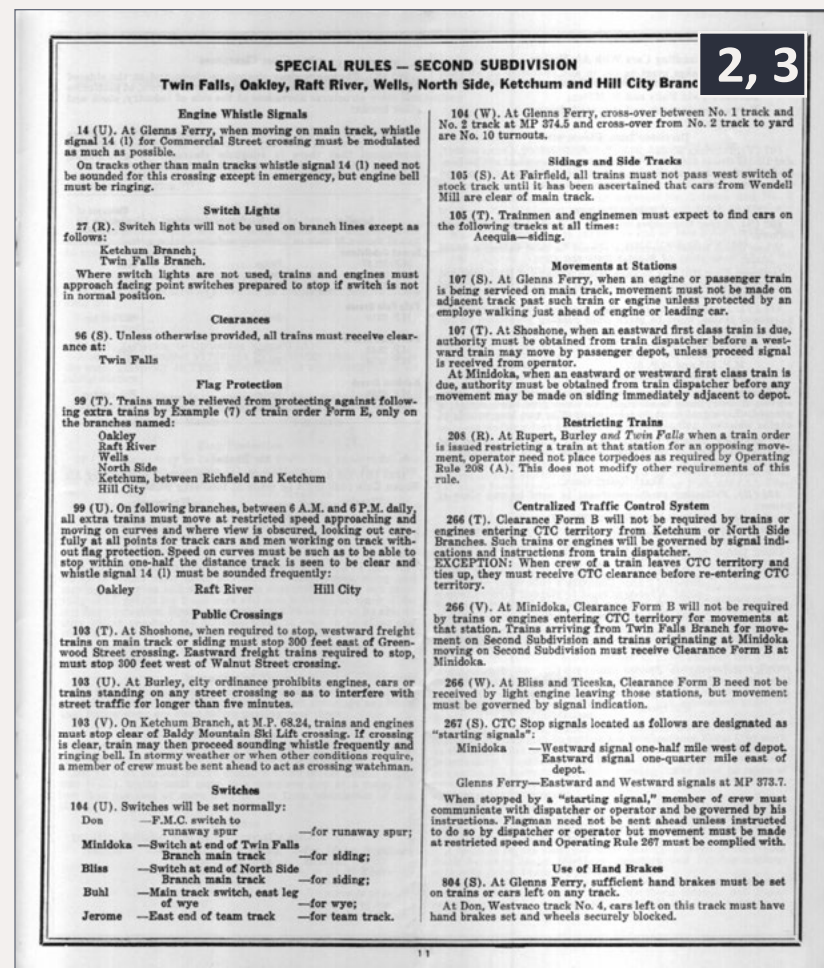
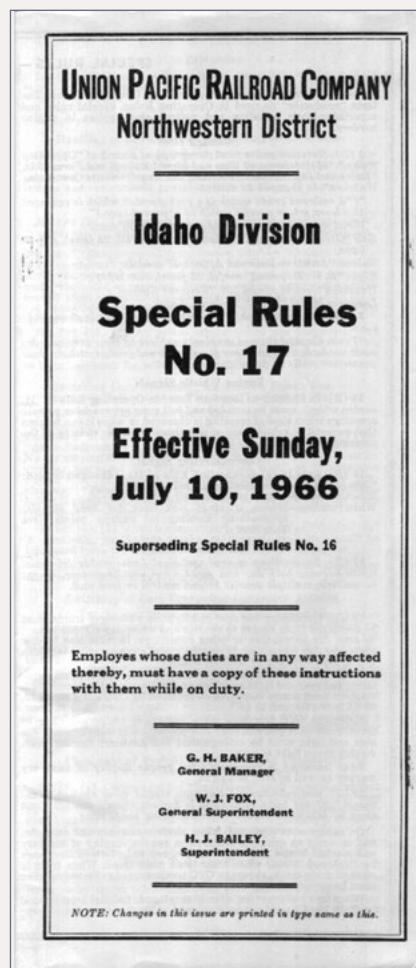

2-3. The Special Rules cover tells what part of the railroad they cover, and when the rules go into effect. Special instructions call for actions in specific situations, like modulating whistles “as much as possible” or using the locomotive warning bell in the Glenns Ferry ID industrial district.

of special instructions. Sometimes they’re just folded into the employee timetable. Special rules can be a very useful tool for modelers because they spell out exactly how to cope with local conditions.

For examples, we’ll look at the Union Pacific’s “Special Rules No. 17” [2, 3] for the Idaho Division of the Northwestern District. They were effective Sunday, July 10, 1966.

Every employee whose duties were in any way affected by the instructions had to have a copy with them while on duty.

The document, the same size as an employee timetable, runs 20 pages. Sections include special rules for all subdivisions, rules for specific terminal areas, rules for each subdivision, and tonnage ratings for diesel locomotives in freight service for specific track segments.

Some subdivision rules tell where trains must receive clearances to proceed – several subs in this district were operated by timetable and train order. Others talk about positioning heavy cars in trains to protect bridges or lightly built branch lines. Other instructions say where extra brakes have to be set to keep cars from rolling away on sidings, or spell out where substandard clearances are a hazard.

It sounds like a lot of information to absorb, on top of a rule book and timetable, but the instructions are for crews working the same areas day after day. For example,

NOTE: At Monida, train crews must know that apron on loading platform Simplot track is clear before moving cars past tipple.

Any guesses how many loading platform aprons were crumpled?

Others relate to specific local conditions:

Flag Protection

99 (T). Trains may be relieved from protecting against following extra trains by Example (7) of train order Form E, only on the branches named:

... and it goes on to list eight branches which only merited one or two daily scheduled trains in normal operation. It also includes:

99 (U). On following branches, between 6 A.M. and 6 P.M. daily, all extra trains must move at restricted speed

approaching and moving on curves and where view is obscured, looking out carefully at all points for track cars and men working on track without flag protection ...

In other words, the section gang will be working somewhere, and if your train is not on the timetable, they have no idea you're out there. The instruction also calls for frequent whistling of the - 0 - grade crossing signal in the same situation.

As a help to crews, new instructions in each edition were set in italic type to make them easy to see.

– MRH



TIPS

Revive a pin vise

After several years of use, my smallest pin vise chuck had worn to the point that it would no longer close on very small bits. Rather than replacing it, I renewed it by grinding away a little of the inside faces of the jaws using a very thin diamond blade in a Dremel tool [4 next page]. This restored the sharp corners of the jaws, allowing them to close down to 0 again.

– Ken Rickman

Soldering track joints

I don't know if this is a new tip but it was shown to me by a member of our Zephyrhills Railroad Museum club. When soldering a rail



4. A thin diamond blade refaces worn pin vise collets. Ken Rickman photo.



5. Clips on either side of a soldered rail joint draw heat away from the work and keep plastic ties from melting. Ronald D. Smith photo.

joint [5] in flex track, use two hemostats, one on either side of the joint to absorb the soldering gun's heat and protect the plastic track ties from melting.

– Ronald D. Smith

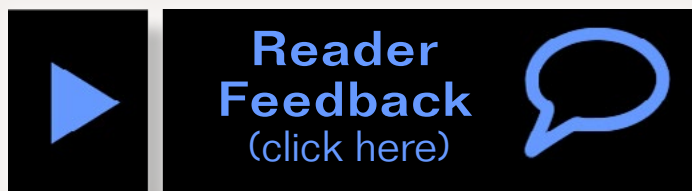

GET \$25 PER TIP

We pay \$25 USD for each tip we publish. Send your modeling tips to Model Railroad Hobbyist and we'll get payment to you upon acceptance.

Just think, for only a few minutes effort, you could fund your next piece of rolling stock – or even pay for an entire train if you send in several tips and we publish them!

If you include any photos with your tip, we pay a bonus of \$10 per photo we use with the tip. ■

98,000 have seen this MRH video - *have you?*

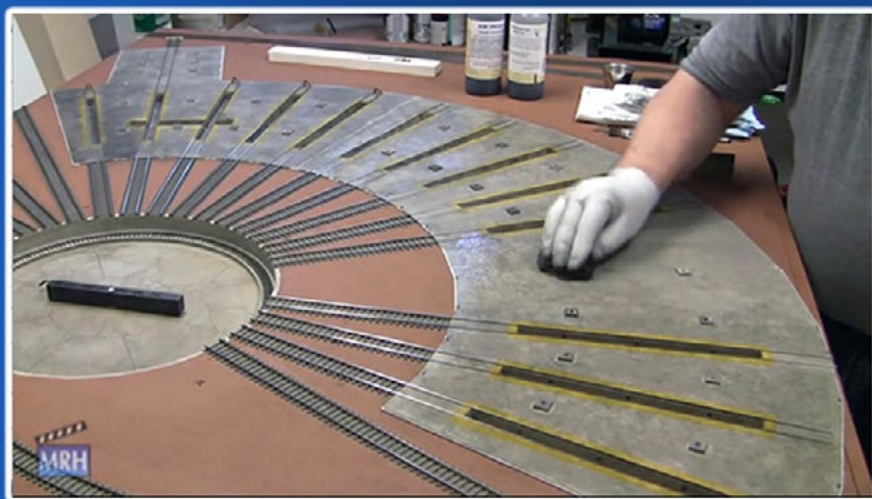

Watch the video now



Many species of Conifer trees available!



Also see our other conifer offerings ...

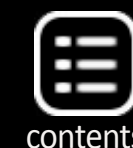

CHECK IT OUT!

September 1st to 14th



CLICK HERE FOR HO Scale

CLICK HERE FOR N Scale

Pacific Western Rail Systems



Click on the NARC logo to the left to visit the realm of the next generation of top quality rolling stock.

Potash & Grain Hoppers • Coal Gondolas

Produced by North American Railcar Corporation in HO Scale and N Scale, these cars are only available through Pacific Western Rail Systems.

Sorry – these are not included in our Back to School Sale.

Pacific Western Rail Systems has commissioned Micro-Trains® to produce exclusive limited run cars and runner packs.



Click on the PWRs Special Run Car logo above to see what is available now, and to reserve an upcoming project.

Sorry – also not included in our Back to School Sale.



Benchmark, roadbed, and track come to Browning

A regular report on the construction of a 1950s-something layout

Up the Creek column

by Charlie Comstock



Or: Micro Engineering flex track 101...

If you read the July 2014 Up the Creek column, you might be wondering how my new backdrops are working out. I'm glad to report they've turned sky blue and are working just fine.

After the June and July op sessions, BC&SJ crews reported a significant increase in their sense of isolation while on the high-iron (or nickel-silver), and the ops sessions are quieter. Crewmen don't shoot the breeze with someone on the far side of a backdrop, and the backdrops block outside sounds.

More benchmark

Plywood sub-roadbed had been propped in place in Browning and along the Toledo branch for some time, letting me see what the aisles would be like. I held off permanently installing it because leaning over two or more feet of benchmark to install and paint a backdrop seemed wrong. However, with the backdrop in those places complete, it was time to get cracking.



There was nothing tricky about cutting plywood for the Browning sub-roadbed. The joists protruding from the helix table had been deliberately made low because Browning's final elevation wasn't known. It turned out an extra 2-3/4" of height was needed – added by piggybacking pieces of plywood on top of the original joists [3].



1. After the July 2014 Up the Creek column was written in late May, my work crew spent quite a bit of time in (as my wife would put it) the train dungeon. As a result, the July op session featured sky blue backdrops instead of the old brown color, and the benchwork around the elevator in Browning was taking its final shape. The new backdrop, visible behind the South Jackson yardmaster, made a huge difference in terms of making ops crews feel more isolated and in reducing the decibel level of an op session.

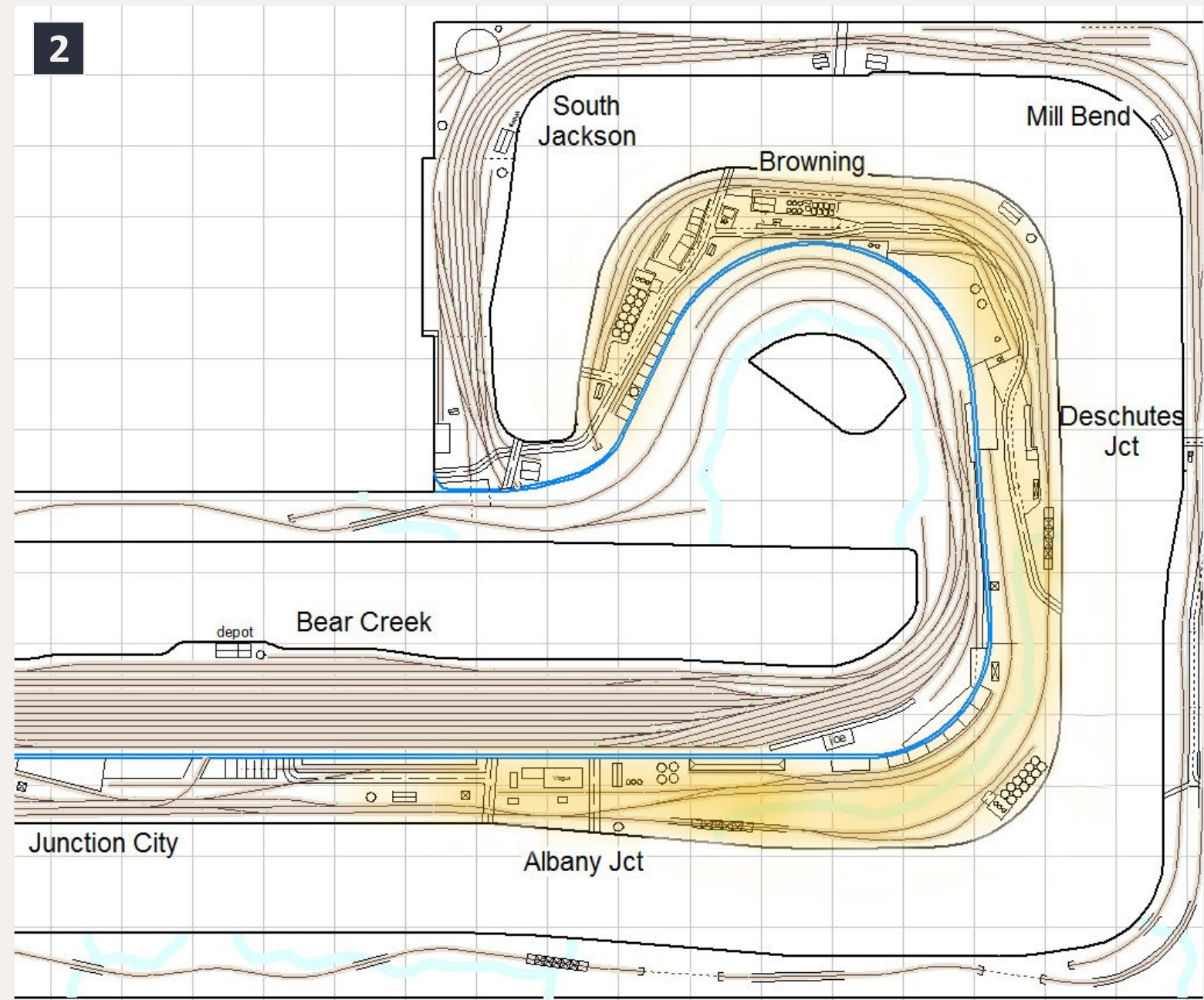

2. The areas with benchwork, sub-roadbed, and track work in progress are highlighted in yellow. Next I'll remove the temporary Salem staging area, and complete the backdrop and benchwork to the end of the peninsula. Once the mainline is installed, it will be golden spike time. Each grid square is 24 inches.

Before gluing 2-3/4" strips to the tops of the joists, I propped the plywood roadbed in place and located the tracks, turnouts, and structures. Somehow, it seems, despite my best efforts with 3rd Planit (my model railroad CAD program of choice), I almost always see a better way to lay out out tracks when I'm doing it full-size. Browning's trackage was no exception.

After a week of doodling tracks and industries on plywood and collecting mostly constructive criticism, the track plan was as complete as it would get until track laying commenced. During a work night we double checked that turnouts weren't located with their points directly above joists – a problem when installing switch machinery under the track. After a clean bill of health, we glued the 3/4" plywood joist risers in place, then screwed down the roadbed.



3. 2-3/4" auxiliary joists riding on top of the Browning supports raise the plywood sub-roadbed to the correct height. They're attached with Liquid Nails. I set the auxiliary joists back from the edge to make room for a creek which will border the fascia in places.



4. I dislike installing cork roadbed and track in a cave. So I installed lower-level elements before installing the main line between Bear Creek and Oakhill. This area looks a lot different with the backdrop in place and painted.

I'd installed a couple of pieces of flex track leading from TOH Junction (Top Of Helix) to Browning back in 2013. A month later, this track was covered by the main line and Siskiyou Branch roadbed and track. Now, in July 2014, it was time to extend it into Browning.

I usually use 1/4" (actually 5mm) cork under the BC&SJ mainline. I started laying it where the lead to TOH Junction poked out of the backdrop [4]. In short order, this will be topped with Micro Engineering track. I use code 83 for the mainline and code 70 for the siding. In the past I would have used code 55 for spur tracks but those turkeys quit making the stuff! I

prefer ME flex track for visible locations because of its superior appearance.

Marking center lines

The MidWest Products cork roadbed I use needs to be split in two along a pre-cut diagonal. Then, the two pieces are glued in place back-to-back with their beveled edges (more or less) simulating a ballast profile.

If care is taken to closely align the cork roadbed when gluing it, the seam between the two pieces can be used to guide track placement. But I always lightly sand the cork to smooth the top surface and this makes it hard to see the center seam.



5

5. With the sub-roadbed in place, I started to glue down cork roadbed. This area of Browning is on a 1% grade, descending toward the backdrop.

For a year or two I've been marking the edge of each cork strip with a Sharpie black marking pen. Now the center line is clearly visible after sanding [6, 8].

I spread yellow glue, then smooch the cork into the glue and hold it in place with map tacks. After the glue dries I remove the map tacks, and use a 16" long block of particle board wrapped with 60 grit sandpaper to smooth the top [7]. Using a long sanding block helps keep the cork's surface flat. I also lightly sand the outside edges of the cork to remove roughness left when I split the cork into two pieces.

Advertisement

Rslaserkits

Coming soon in HO and N scales

Courter Building Supply & Manufacturing

Custom Milling, Furniture and widows

Building was across

the tracks from

Cobleskill Coal

in Cobleskill, NY

Dealers welcome

Salem, OR

503-371-4290



Custom Laser Cutting

and design

Sales@rslaserkits.com



ME flex track 101

Some folks say Micro Engineering flex track is difficult to install. I have found that with a little care and an inexpensive tool it's not tricky, but it does call for some patience.

Most of the issues with ME track involve getting it to form a smooth curve, or once bent, getting it straight again.

ME track is stiff and will hold its shape, while Atlas flex track is floppy and won't hold its shape until it is fastened down. With Atlas track, the rail above the continuously connected end of the ties is held firmly in place, and the other rail is left loose to slip through the spikes. When Atlas track is flexed, the ties don't bind.

With ME track, both rails are loose enough to slip (just a little). The zig-zag pattern [9] lets the ME track's ties move around as the track is curved. When they become diagonal instead of parallel the gauge is decreased by an iota or two. This increases the friction of the rails sliding past the spike heads. If the placement and angles are uneven, so is the friction. The friction makes ME track hold its shape. The uneven friction seems like the reason it's tricky to form ME track into a smooth curve.

I've been using ME flex track for a long time. With patience I can always coax it into shape. Then my local hobby shop owner turned me on to the Track Tool from MLR Mfg [11]. This handy-dandy gadget is placed on top of the rails and makes curving ME flex track a lot easier.

Before I start installing the track, I lay it out upside down and use my sanding block, this time with 200 grit sandpaper to



6. Marking the edge of the cork strips before installation makes the seam where they join obvious to the casual observer. I use a black Sharpie marker.

Advertisement



Your Local **N Scale**
Online **Hobby Shop**

575-523-9743
fiferhobby.com

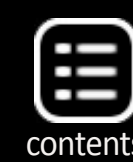



7. Sanding gets rid of high spots and rough edges. Sanding with a long sanding block reduces side-to-side and up-and-down dippy-doodles in the cork roadbed.

remove bumps and flash from the bottom of each piece. These could cause rises in the track when it's installed.

I put a piece of flex track on the roadbed where it will eventually be glued down. Then I slip the Track Tool over the rails [10] and apply a bit of twisting pressure while sliding it back and forth. Easy does it here. I don't try to force the track into final shape all at once! With each pass I add a little more curvature, moving from the end of piece of track toward the middle. When one end is rough-curved to shape, I start at the other end.

**New
Innovation**

Nano-Oil™
Made in U.S.A.

Nano Technology Lubricants

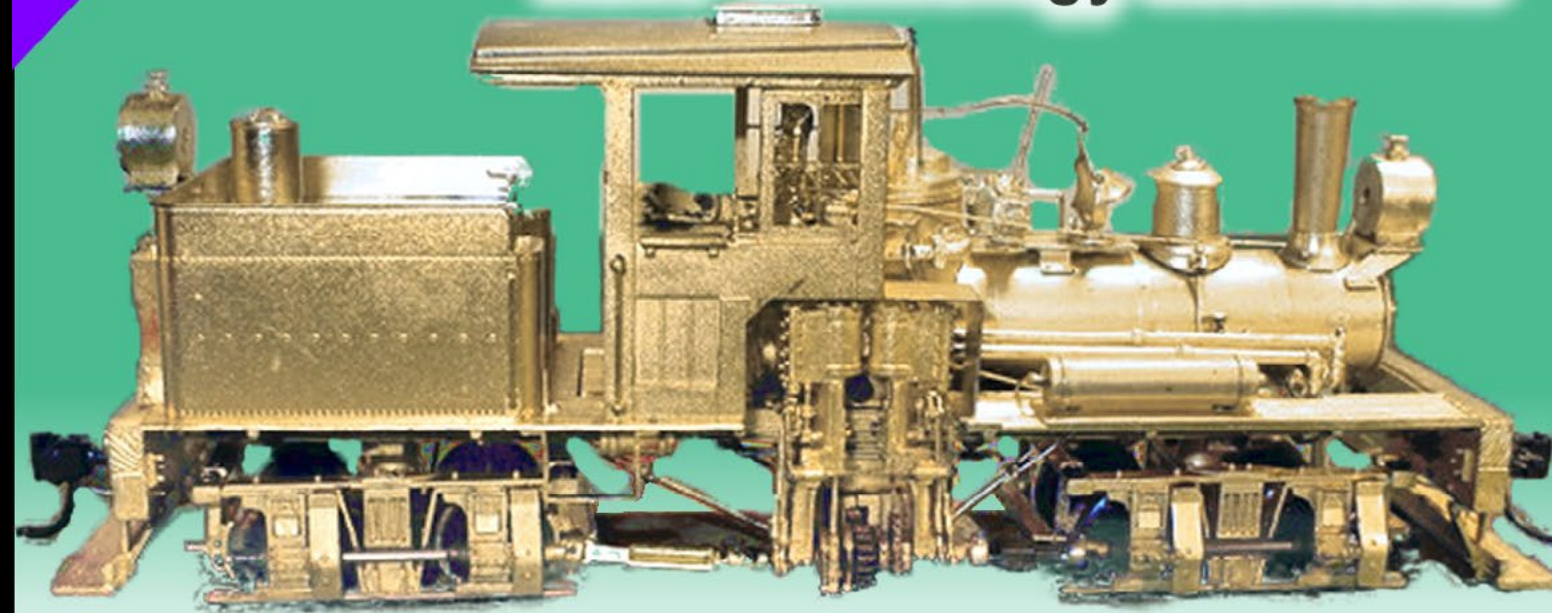

"After eight years of extensive testing, the only lubricants now used in my shop are Nano-Oils and Nano-Grease. The extreme reduction in power draw by mechanically minimizing friction is simply technologically superior."

- Phil Floyd, 'The Shay Fixer'

THE SHAY FIXER 

VISIT US AT... 
SHAYFIXER.COM

Specializing in brass Pacific Fast Mail / United geared locomotives

**For more details
click here ...**





8. The center seam in the cork roadbed is clearly visible even after the cork has been sanded.

I like to solder two pieces of flex track two pieces of flex track together – 6' long double pieces reduce the number of unsoldered rail joints. I work on a 6' piece until I get it curved to approximate shape. Then I put it in position and use the center seam or a track center line as a guide and tweak it into shape.

I line up the new track with any previously laid pieces and work on getting the rail ends to mate smoothly. I almost always need to do some trimming. I use flush cutting nippers to cut the rail. Cutting with nippers always leaves sharp edges behind. I carefully file these smooth. If I don't, the tight-fitting ME rail joiners hang up and refuse to slide over the rail ends. If this process is hard to visualize, check out the video accompanying this article.

Atlas flex track tie pattern

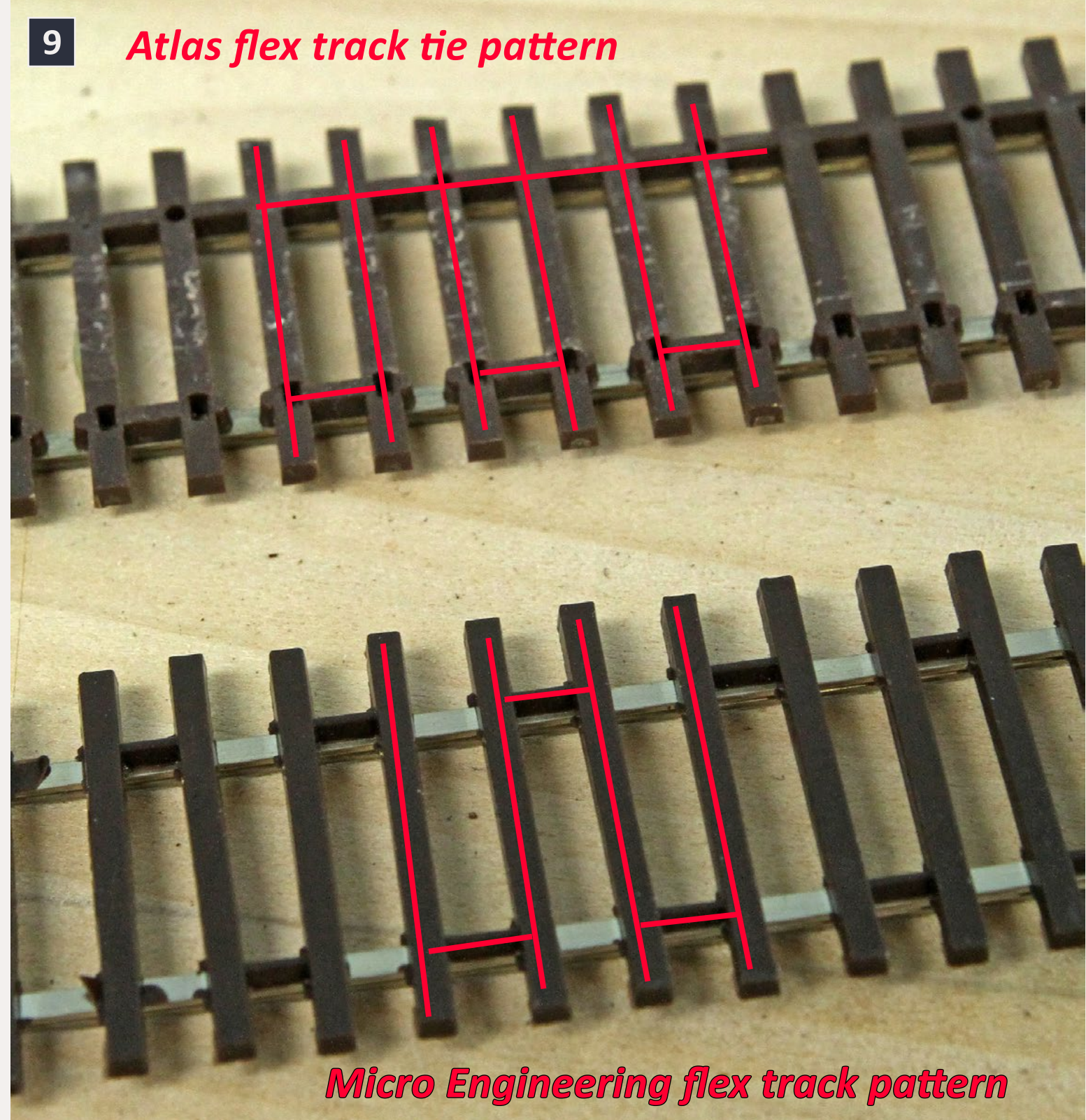

Micro Engineering flex track pattern

9. Note the different tie patterns of Atlas and ME flex track. Atlas track is designed to curve smoothly but won't hold its shape. ME track is trickier to curve smoothly but once curved holds its shape.

ME rail has a thinner cross section than Atlas, one of the reasons I like it. ME track tends to swim around inside Atlas joiners. Micro Engineering sells HO rail joiners sized for code 55,

70, 83, and 100 rail that holds ME rail ends in precise alignment. They're also small – good if you care about the appearance of your track.

I use Atlas joiners if I need to connect Atlas and ME rail. Forcing wider Atlas code 83 rail into a ME joiner usually causes the rail joiner to split. I carefully hold the ends of the rail in horizontal and vertical alignment with tweezers when soldering these joints.

Dealing with out-of-place ties

Curving the flex track most likely left the ties spaced unevenly [10]. I run a blunt instrument such as the non-working end of a set of tweezers along the ties, snapping it over each one. This gradually moves the ties towards the desired alignment. If a tie doesn't cooperate, I nudge it into position. This sounds harder than it is. It doesn't take long to get the hang of it.

With the rails trimmed and rail joiners holding the rails in place, I mark the cork where the ties stop at both ends, and in the middle. These marks let me know how far to spread the caulk I use to hold the track in place until it's ballasted.

Feeder wires

When installing a double piece of track, I mark the location of the central rail joiners. If I'm not installing a 6' double piece of

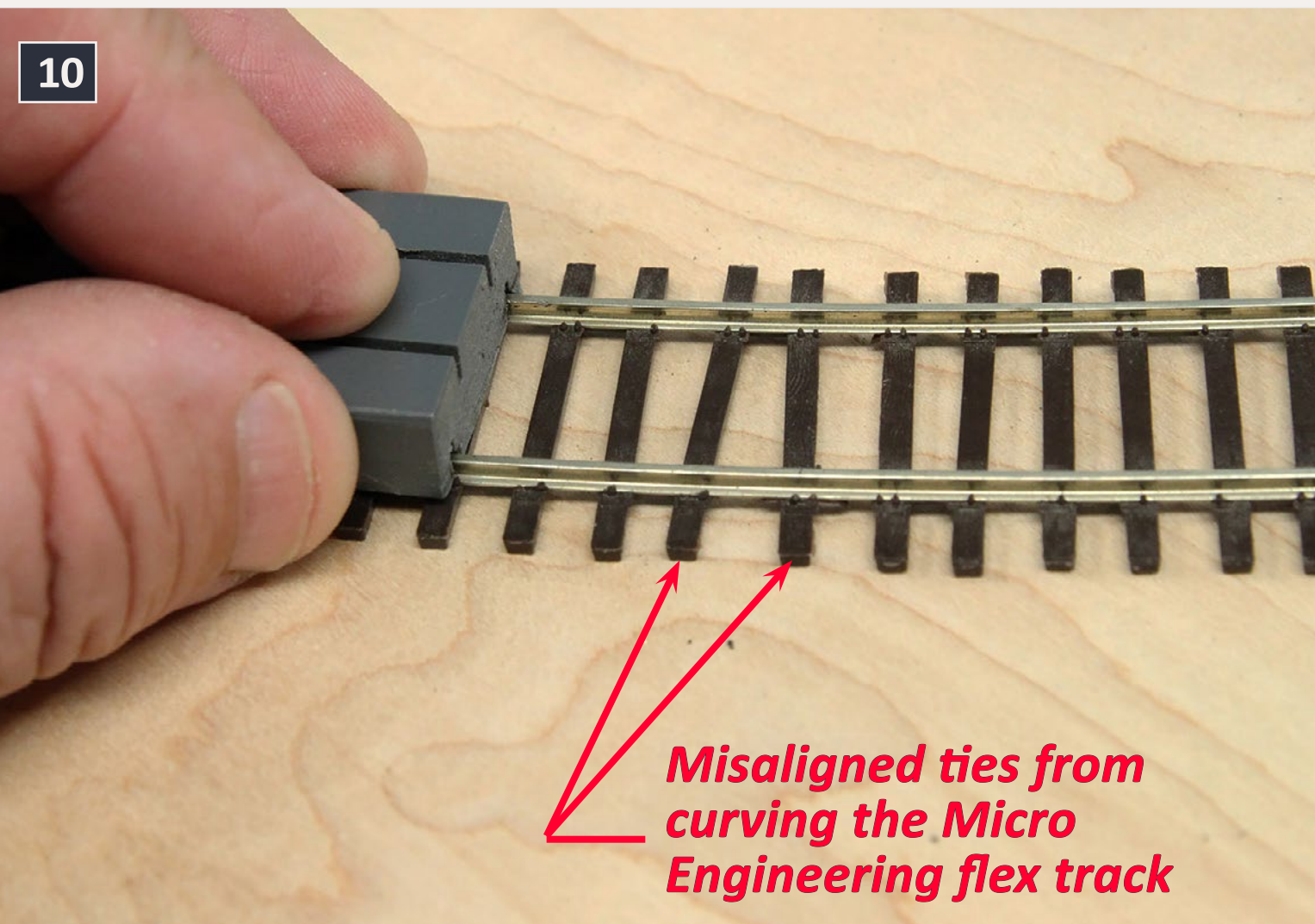

10. Curving ME track often results in the ties losing position and becoming misaligned. I work the ties back into alignment once the track is laid.

Advertisement

THE **O** **RESOURCE**
NEWS, REVIEWS, INFORMATION TO USE
SCALE *New* **On Line Magazine**
www.oscaleresource.com



flex track, I figure out where I want the feeders and mark that location. I solder feeder wires to the bottom of the rail joiners or rails to hide them – these lines show me where to drill feeder wire holes [12].

Next, I set the flex track to the side and drill holes for the feeder wires. I use 22 gauge solid wire for feeders, color-coded red and black. I strip the wire ends, make a 90° bend about 3/8" from the upper end and thread the wires into the holes, being careful to match the color-coding to rail polarities [12].

I keep the holes small, but big enough to have the wires slide through them. Having a little slack here will help prevent the solder joint from failing if track expansion doesn't match the roadbed. I leave the wires poking out well above the roadbed at this time. When I apply the caulk, this helps keep the stuff off the stripped wire ends.



11

11. This simple tool from MLR Mfg. costs only a few bucks and makes shaping ME flex track into curves easy.

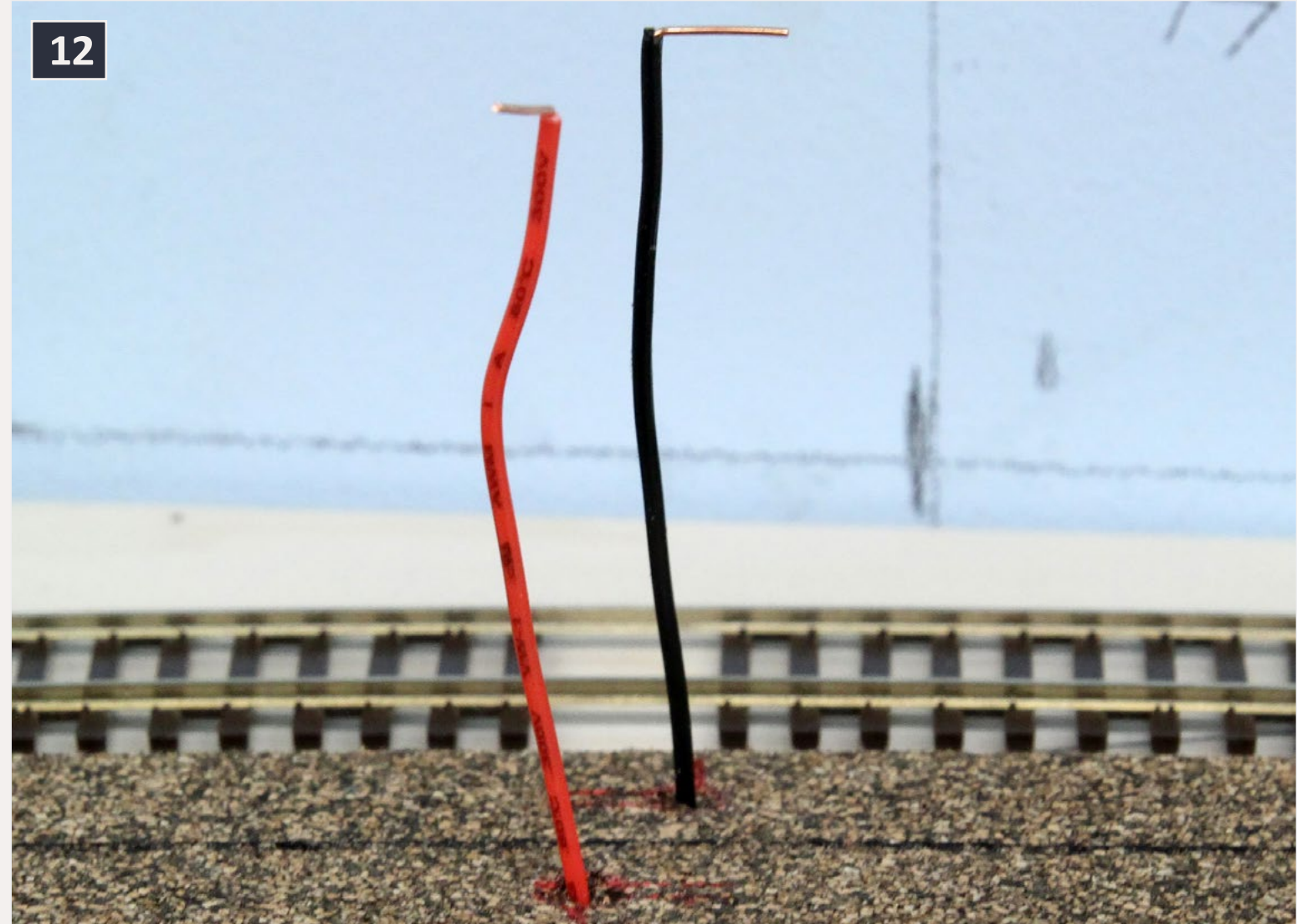

12

12. Putting the feeder wires in place before fastening the track serves two purposes. First, it lets me avoid getting caulk too near the stripped end of the feeder wires. Second, I drill holes for the feeders directly below the rails and solder the feeders to the bottoms of the rails or joiners). In the past I have glued down the track, then realized I'd forgotten to install the feeder wires. Putting the wires in before the caulk helps to prevent that sort of thing. If you look carefully, you can see red lines marking the sides of the rails above the holes.

Gluing down the track

I use gray latex paintable caulk to hold the flex track securely in place until I get around to applying ballast. This interval is sometimes measured in years.

I start by running a bead of caulk down the middle of the road-bed, then spread it with a homemade notched trowel. Using too much caulk is a problem. When the flex track is bedded down, it can rise up over the top of the ties, making a mess. Using too little is also a problem, letting the track pop up out of the caulk's grip.

My little notched trowel lets me spread the caulk very evenly and avoid excess glop syndrome (EGS), but still have enough to hold the track in place. I make sure not to get caulk on the



13

13. I use paintable latex caulk to glue down ME flex track. I prefer gray because it more or less matches the ballast color. I got this tube from a local big-box store. Once the track is bedded in this stuff I have about 10 or 15 minutes of working time.



14

14. I use this homemade itsy-bitsy notched trowel to spread caulk. After almost 15 years of use, it may be getting to be time to make another one. It started as a small scrap of .060" styrene. I sharpened one edge like a chisel, then made notches with a tiny triangular jeweler's file.

feeder wires or go past the ties at the end of this piece of flex track. I clean any excess off the sides of the cork.

Bedding flex track in caulk

Once the caulk is spread, I push the feeder wires down until their 90° bent tops are on top of the cork and slip the end of the new track into the adjacent track's rail joiners. Then push the track into the caulk. Don't wear long sleeves while doing this. You'll likely end up with gray caulk all over 'em.

Then I work the track with the MLR track tool, finalizing its alignment while pressing it into the caulk. This is a place where

A clipping from the

South Jackson Gazette

Space is curved say leading scientists!

Previous research by scientists from South Jackson suggested our universe curves around on itself. Now scientists have uncovered evidence supporting a progressive creationism theory.

When reached at the South Jackson tavern, they explained, "For a long time we believed the universe began in one spot and has been spreading out from there. Now research shows that instead of spreading out omnidirectionally it's been expanding in a single direction. But the direction of expansion has been inconsistent. It's almost as though some entity is using a cosmic crowbar to bend the universe's expansion path back and forth."

At this point local, Horace Fithers took over, "It all seems to be goin' more or less in a full circle and will be comin' back to where it done begun! If these gray heads are correct for a change, the universe should start back-filling and grow counter-clock-like in addition to growing clock-like."

Horace paused for a swig of root beer allowing Dr. Lee to resume. "We're expecting the ends of the universe to meet sometime in the

next few months. Although we're not positive where that will happen, it seems possible it will be railroad west of Bear Creek."

Other locals listening to the discussion sniggered. "Jest ask 'em how big the universe is gonna get? They say it'll have about a five-mile circumference! That's a mighty small universe!"

When reached, Charlie Comstock BC&SJ Superintendent of Nearly Everything, in Oakhill, commented, "Five miles may be small on a galactic scale, but we've been living in much smaller universes for the past 17 years. I expect five miles will seem plenty large, and it will be good having the ends connected. Now we won't have to waste time turning trains at the ends of our railroad. We'll just let 'em keep running." ❖

* Enjoy the Gazette? Read more at bcsjrr.com



Playback problems? [Click to try a different version.](#)

Advertisement



1st choice for model railway supplies and service.

Expedited mail service available across North America.



Click to visit:
WWW.CVR.CO.COM
1 800 464 1730





15. Flooring installers lay linoleum or tiles using notched trowels to apply just the right amount of mastic to the floor. If it's good enough for them, it's good enough for me. My home-made trowel leaves little ridges of caulk behind, enough to hold the track, but not so much that the track floats in the stuff.

ME track's ability to hold its shape really helps. That, coupled with the caulk's tackiness, makes precise final alignment and curve smoothing fairly easy. I easily get more than 10 or 15 minutes of working time, more than ample.

In places where the track is straight, I hold an 18" metal straightedge against one of the rails as a guide, and use a finger on the other side to press the rail against the straightedge. Afterward I sight along the rails looking for wiggles and make adjustments, repeating the process until no wiggles are visible.

Bowser

In Stock Now!!!

New Product Announcements!!

HO Freight Car Kits

Features: One piece plastic molded body, under frame, brake wheel, air tank, brake cylinder, triple valve, free rolling trucks, knuckle couplers, & car weights



GS 40' Gondola

70 Ton 2 Bay Open Side Covered Hopper



100 Ton 45' Triple Hopper

F-30 Flat car



Click here to check out the details for these and other great Bowser products!

HO Cal Scale



Cal & Scale

Lost Wax Brass Plastic Molded Detail Parts & Wire Form Parts

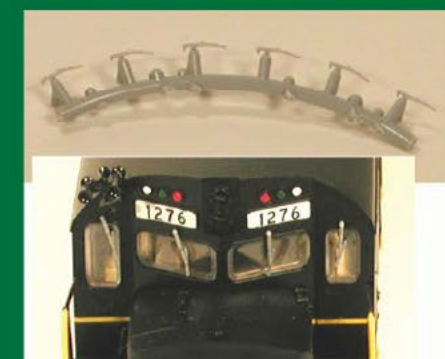

www.bowser-trains.com



To smooth the curves I place the MLR track tool on the rails, apply a tiny twisting force (not enough to bend the track), then slide it along the track. This lets me feel places where the curvature changes. Using minimum twisting or side to side pressure I gently nudge the rails until the track feels smooth when I run the tool along it.

Sighting along the rails is a good idea on curves, too. If you can't get your eyes into position, try putting a small mirror vertically on the track and sight along the reflected rails.

Weighting track in place

Once the track flows smoothly through the curves and the straights are straight I weight it in place using cheap canned corn from the local discount grocery store. Then I move on to



16. The Canned Vegetable Express. I use the cheapest canned vegetables carried by WinCo to weight a length newly laid flex track until the caulk sets up. I generally leave the weights on overnight just to be sure.

the next piece of track. I leave the canned corn on overnight to ensure the caulk is fully set.

Soldering feeders

Once I remove the track weights, I tin the stripped tips of the feeder wires, twist them under the track, and solder them to the bottom of the rail joiners or rail.

If you're smart, pre-tin the bottom of the joiners with solder before installing the track. This makes feeder soldering much easier. Sometimes I'm smart. I find putting a 90° bend about 1/4" from the end of the solder makes it easier to apply it under the rail.

What's next?

As I write this nearly all the trackwork remains to be added in Browning. I'll need to build a bunch of custom turnouts plus a crossing, and the Fast Tracks jigs will also get more use, too.

I don't plan to work on structures or scenery at this time. My focus remains on completing the mainline.

Once I finish the track in Browning, I'll hit the Toledo branch and then the part of Junction City that has benchwork. After that, I'll finish the benchwork and backdrop on the peninsula before completing the mainline.

I remain hopeful that the gold spike may get driven sometime in September. Horace and Gaston are wondering what kind of cake we'll have for the celebration.



NCE Switch8-Mark2

and the Button Board

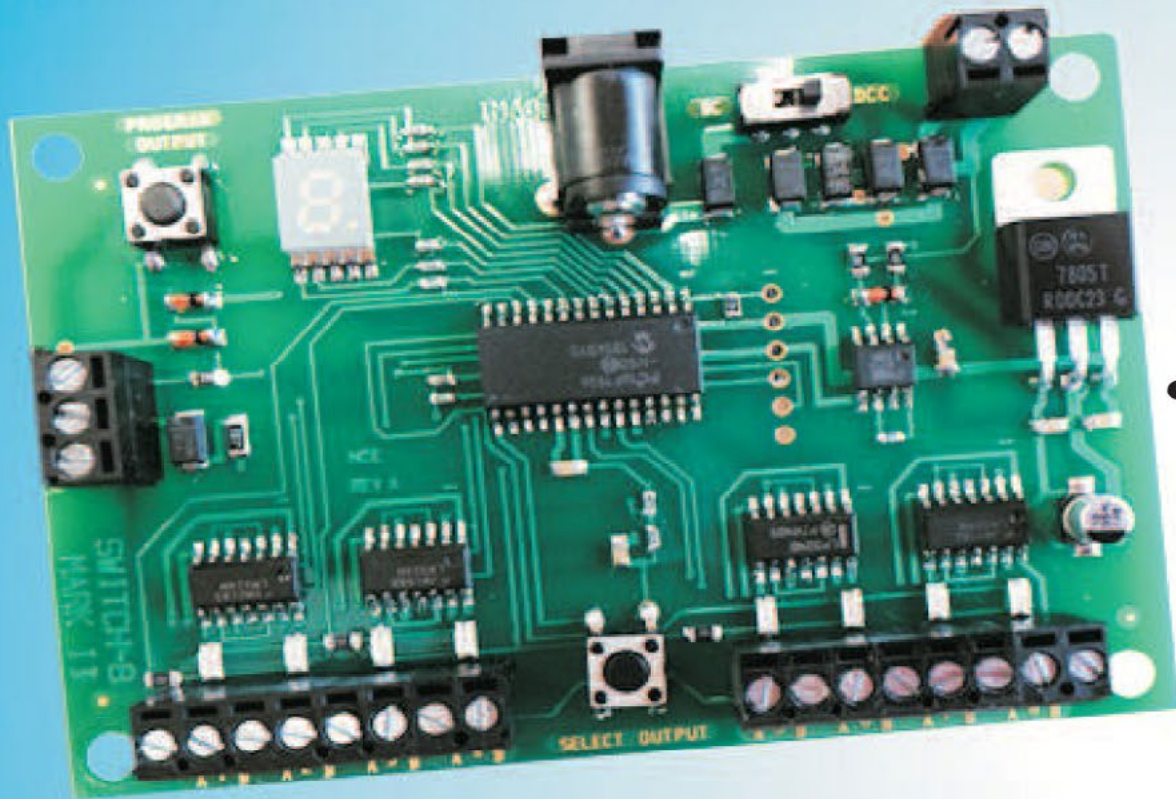

Introducing the brand new
Switch8-Mark2

- Easy to program
 - Improved user feedback
 - Track power or External power
- 5240151 - \$69.95 ea.

Manual is available at
[www.ncecorporation.com/
extras/manuals/decoders](http://www.ncecorporation.com/extras/manuals/decoders)

Now Shipping!

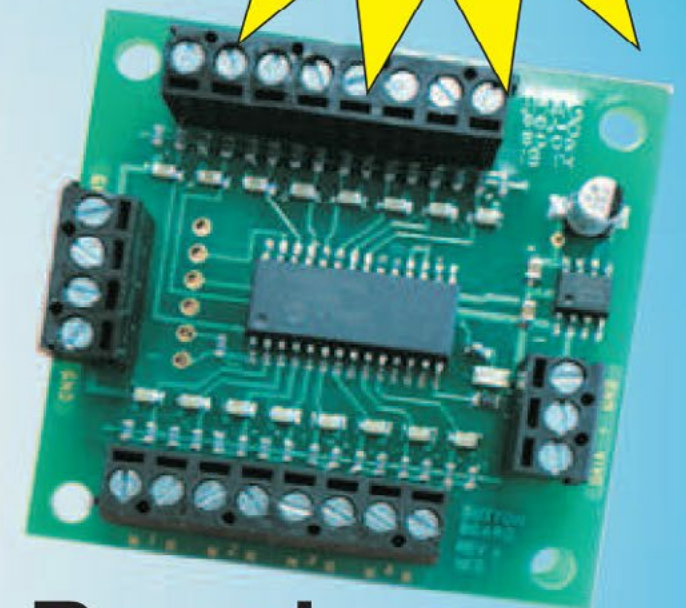

And the new **Button Board**
An Add on accessory device that expands
the operation of the Switch8-Mark2.

5240152 - \$29.95 ea.

Manual is available at www.ncecorporation.com/extras/manuals/decoders

NCE
The Power of DCC

Discover the FUN!

• Made in the U.S.A. •

Call or Email
for FREE Brochure
support@ncecorporation.com

585.265.0230
9am-4pm EST.
www.ncedcc.com

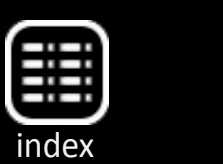

Get Better Sound from your Locomotives

Can't get a good sound from your sound decoder?
Give our speakers a test drive with your ears.



RAILMASTER HOBBIES
9815 WALNUT ST #106
BELLFLOWER, CA 90706

Bass Reflex Speakers



High Bass Speakers



When it comes to speakers we have high quality speakers to fit many different applications. We are also a full line hobby shop. Need anything? We are an authorized dealer for Soundtraxx, Digitrax, Athearn, Walthers and many others. We provide quality speakers for your DCC sound systems and quality service.

Click here for the sound answer ...



SoundTraxx SoundCar Decoder

DCC tips, tricks, and techniques



DCC Impulses column by Bruce Petrarca

A first look at an innovative decoder ...

Freight trains can stretch a mile long. Once the sound of the locomotive has vanished, the ongoing sounds remain: wheel clack, flat spots, onboard generators, flange squeal, etc. Brake sounds abound: cranking the brakes on, air rushing through the lines, the pop of air hoses coming apart, the squeal of brakes slowing the train.

Until now, these sounds have not been addressed in the DCC market. The release of the SoundTraxx SoundCar DCC decoder has changed all that.

I must admit that I was a bit taken aback by the announcement a bit ago. Okay, Why do I want that?

Well, I got a look at one of the first units shipped and I can see a lot of uses. Way more than just going clack-clack as the car goes down the track, as I had first assumed. For example, your DCC throttle can control these neat tricks:

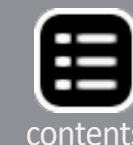

- Caboose - Super-detail your caboose with a lighted interior and exterior marker lights, perhaps even a fire flickering in the stove.
- Mechanical reefer - The sound of the refrigeration unit will add interest to these fellas as they go past. The “generator effect” can be programmed to cycle on and off as might be needed to keep the car cool.
- Modern freight cars - A FRED and operational sound from, for example, a container car.
- Passenger cars - Four sets of lights (salon, two bedrooms and the kitchen, for example) can be controlled, as well as the continuously running generator, or a cycling air conditioning unit. All under DCC control.
- Cab control cars - If you have a Tsunami-equipped locomotive, you can wire the opposite end cab control car with a

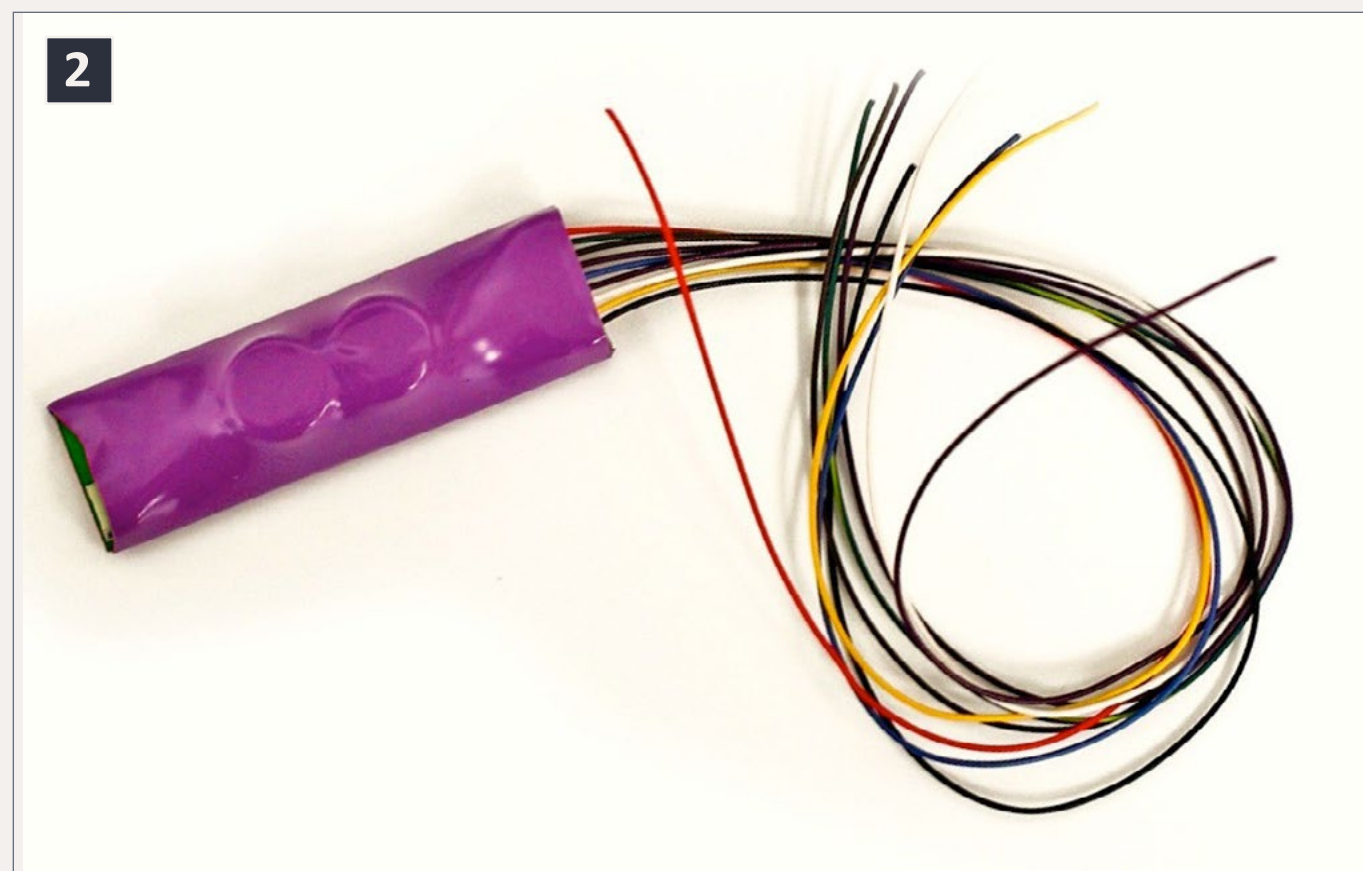

2. SoundTraxx Tsunami SoundCar DCC decoder. SoundTraxx photo.

SoundCar decoder and copy the locomotive program into the sound car to handle the horn, bell and lights exactly as the locomotive does. The braking function in the SoundCar will mimic the response in the loco if they have the same programming. I find that the Nathan K5LA sounds like what I heard in the cab of the Sounder in San Diego headed for Oceanside.

Let your creativity define more uses. There are some ideas in a video done by Ken Patterson, who should be no stranger to MRH readers. The video is on YouTube. [youtube.com/watch?v=yaz2MzmS5Vc](https://www.youtube.com/watch?v=yaz2MzmS5Vc).

Let's get into the details of the product. You may also wish to visit the SoundTraxx site. soundtraxx.com/dsd/soundcar.



1. UP freight at Red Rock AZ, January 8, 2010 - a pair of mile-long freights meet. Bruce Petrarca photo.

Mechanically – The SoundCar’s dimensions are 1.85 x 0.55 x 0.33 inches (47 x 14 x 8.5 mm). They are small enough to fit inside N-scale cars. They have 9 wires coming through a mini JST connector and out of one end, and a 2-pin socket on the other end to connect the SoundTraxx CurrentKeeper. They are shrink wrapped for heat management and electrical protection. There is a magnetic sensor on the board. For reasons we will discuss later, the recommendation is to mount the decoder on the ceiling of the car and as far away from the speaker’s magnet as possible.

Electrically – The SoundCar will withstand G-scale voltages, track as high as 22 volts. They are optimized for an 8-ohm speaker load, but will stand higher. The audio output is one watt.

The unit I received draws about 10-20 mA in a quiescent state – enough to trigger any block detector. Sound and lights add more current. To deliver 1-watt, the sound could consume as much as 100 mA.

The lights draw whatever you design for. The decoder is rated for 100 mA on each of the 4 light outputs. Thus, a single decoder could draw as much as ½ amp (100 mA for the decoder and sound and 4 x 100 mA lights). However, with 10 mA LEDs on all four outputs, I’d expected the nominal maximum draw to be about 0.1 amp (100 mA). Testing confirmed this, with the nominal current consumption with the default volume settings to be about 50 mA without any lights active.

SoundTraxx recommends one decoder for every 3 or 4 cars “for the optimal experience”. This could have a 20-car train drawing close to an amp: 7 SoundCars without lights drawing 100 mA each and a couple of locos drawing 100 mA each. Realistically, I think a through freight will have each car drawing about 50 mA. However, it is something to think about when considering layout design and fleet operations.

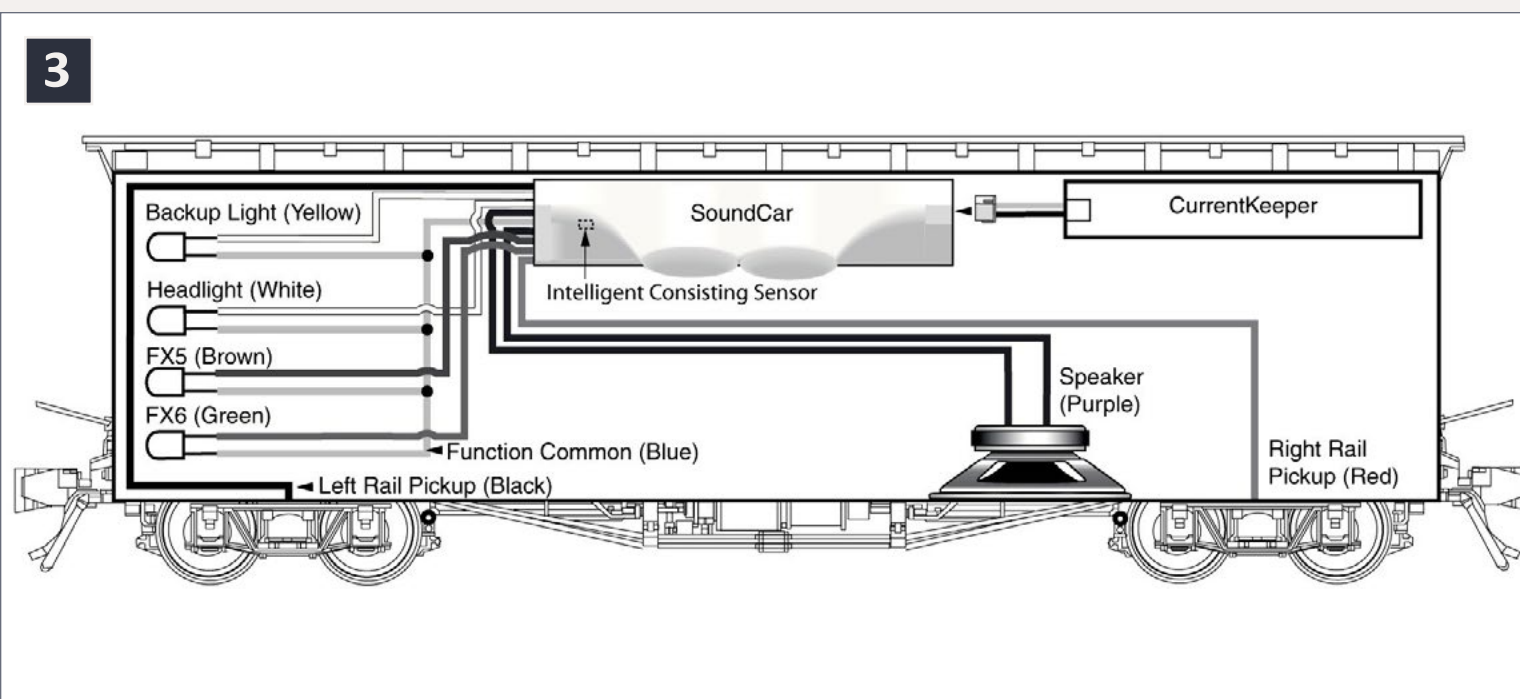

3. SoundTraxx Installation drawing.

Advertisement

Make LocoNet wiring extremely simple!

ACCU-LITES, inc
Your DCC Center!

“... great time saver as well as providing flexibility to change things ...” - Terry Nathan

PM42
breakout board



BDL168
Multi-zone
breakout board



SE8C
breakout board



BDL168
Single-zone
breakout board



<http://www.acculites.com>

CLICK TO LEARN MORE ...



Tsunami technology

This new decoder is based on 10-year-old Tsunami technology. It works and plays well with a loco that has a Tsunami decoder installed. That's fine for backwards compatibility. I must assume that there is a new generation of sound decoders coming some time from SoundTraxx. It would be very short-sighted of them to not design this new product to work with a new loco decoder line.

Installation

For a look at one installation, see Mr. DCC's Workbench after this article.

You will need track power connections inside your cars to connect the SoundCar. In my September 2013 column on passenger car lighting [mrh-2013-09-sep](#) I discussed some methods of adding power pickup to a car. I'm sure you will think of more ways, too.

Once you have the power pickup inside the car, you will need a speaker. My recommendation is to mount it with the sound coming out the floor, and use the car body as an enclosure. The decoder gets mounted on the roof.

Wiring is straightforward and the decoder uses NMRA standard colors. Be aware: the wires on my unit had very tough insulation, Teflon, I believe. Better have a really good pair of small gauge wire strippers on hand. Teflon is very chafe resistant, witness the difficulty stripping.

The SoundTraxx installation diagram is shown [3]. I must admit I'm baffled why someone would want four lights inside a box car. If this were an installation in a cab control car, I can see a headlight and (red) rear light, and even ditch lights.

Advertisement



Stop Missing Out on Half the Fun!

Equipped with over 18 sound effects, the **Tsunami SoundCar** is the only DCC decoder designed for all types of rolling stock, any scale and any gauge.



See it in
Action

Learn More

SOUNDTRAXX®

MRH-Sep 2014



Email



Phone

Advertisement

Touch Toggles™ help *your* Creation

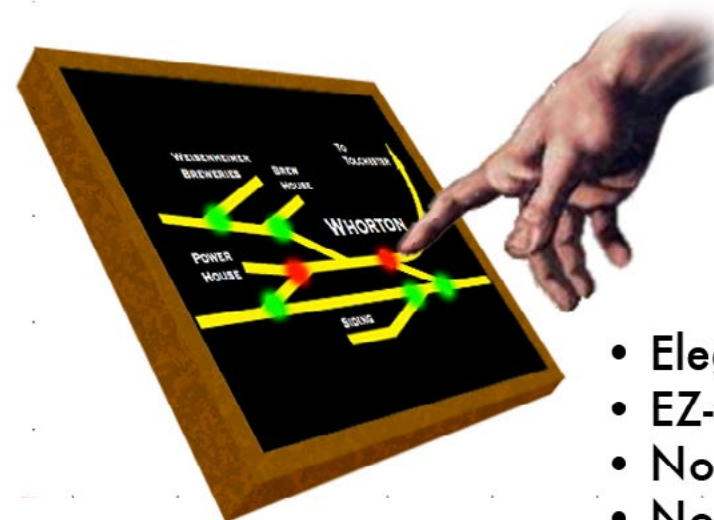

See our website for a
video introduction!

- Elegant controls
- EZ-wire or plug-in systems
- No drilling
- No soldering



Made in the USA

What will they think of next?

www.berrethillshop.com



Email



Phone



contents



index

Intelligent consisting

This is another feature that I didn't get when I saw it on paper. It took some playing to fully comprehend the genius of this. Here is why you want to mount the decoder in the ceiling of the car and in a consistent location throughout your fleet.

Let me walk you through it. You are making up a mainline freight and have several cars that will be in the freight that are SoundCar equipped. You work around in the yard until you have your consist ready, including, perhaps, a caboose. Simulate a brake test go down the line and hold a magnet to the top of the SoundCar-equipped units. They will respond with the sound of the hand brake being untied. Then you press F8 on the loco's throttle four times within one minute of when you waved the magnet over the first SoundCar. You will get a brake bleed-off sound from the consisted cars.

Now every SoundCar will react to whatever DCC commands it is programmed to understand: speed, functions, etc. Yes, you can remap the F8 enable within each SoundCar decoder, if you so desire.

Say you get to the ice house and set out a string of reefers for icing. When you spot the cars, wave the magnet over the decoder-equipped ones. You will get the sound of a hand brake being tied down, and the car will stop responding to the loco's address.

CurrentKeeper support

Most easily achievable power pickup methods will only have 2 or 3 wheel contacts per rail. In the real world, the result will be erratic operation in the real world. So, here comes SoundTraxx' energy storage module, the CurrentKeeper.

Advertisement



RailPro™
NEW TECHNOLOGY
DIRECT™ RADIO

RE RING™
ENGINEERING

NEW Starter Kit
\$399.99 MSRP

- Includes Wireless Color Touch Screen Handheld Controller and 56 Watt Power Supply
- Expandable to Virtually any Size Layout

NEW Locomotive Module
LM-2 & LM-2S

- Direct Radio RF
- Sound and Non-Sound
- New Tiny Size
- 6 Light Outputs

Click Here to Learn More

For more information visit our Internet site: www.RingEngineering.com



4. SoundTraxx CurrentKeeper energy storage module. SoundTraxx photo.

This module is about the same size as the SoundCar and, with a bit of care, both could fit into an N-scale box car.

This energy storage module is similar to several that have been introduced recently and are similarly priced. The CurrentKeeper will plug directly into the SoundCar. The combination will keep making sounds smoothly on the most difficult of track. In good news for garden railroad fans, unlike some similar modules from other manufacturers, the CurrentKeeper is rated for track voltages up to 22 volts.

With the CurrentKeeper connected, the SoundCar continued to generate loud sounds for almost 30 seconds after the track power was removed. Then the sound abruptly died. I tried removing the track power with the wheel clack sound running (loco set for full speed). There was not a hiccup in the sound when the track power was removed, just the abrupt stop after about ½ minute.

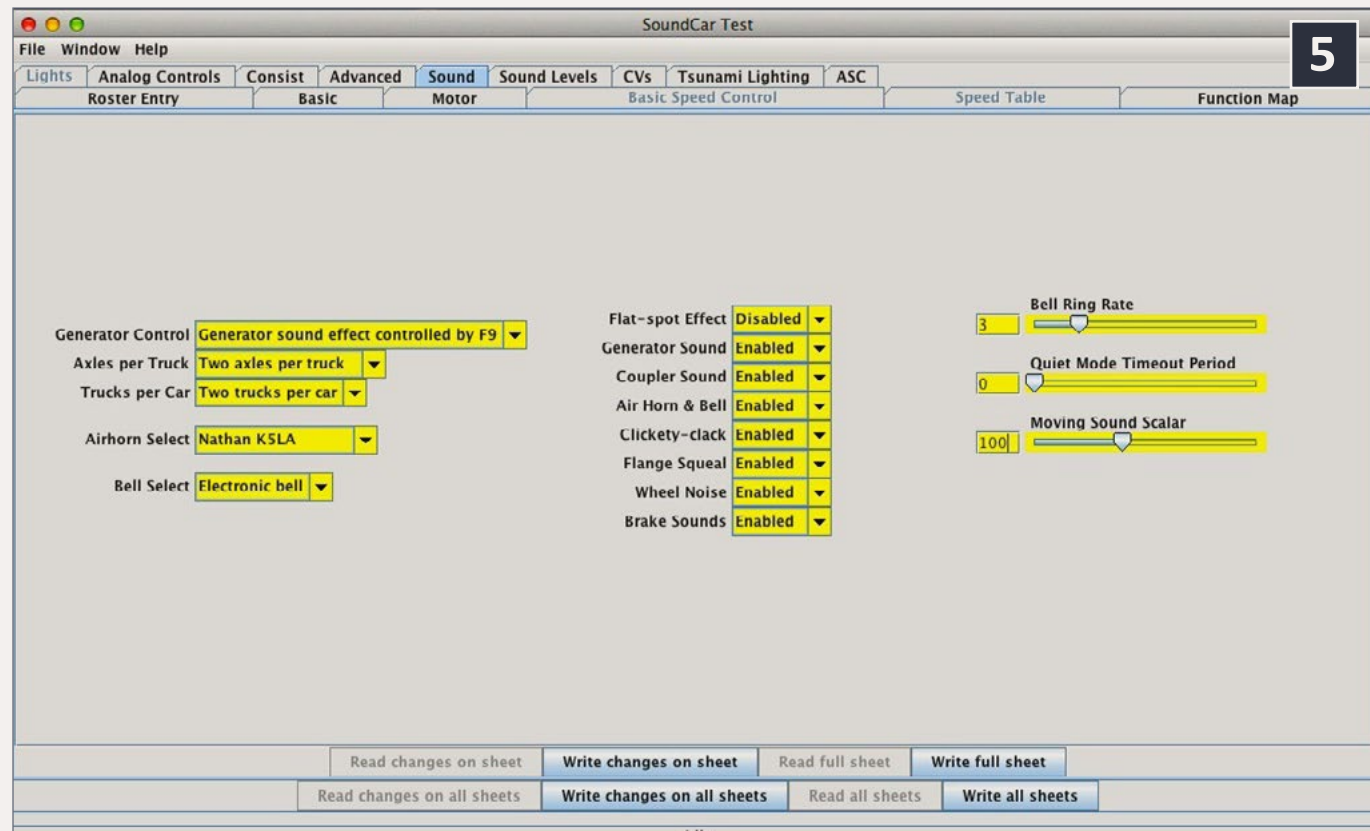

5. DecoderPro sounds screen. Capture by Bruce Petrarca.

TONY'S TRAIN XCHANGE

Committed to your DCC support!

Hare™ Stationary Decoders for Tortoises™

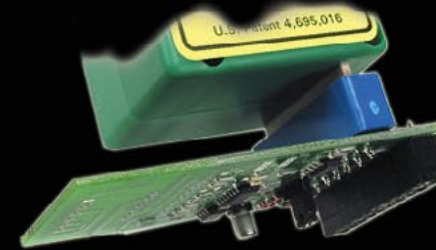

Patented Auto-Throw™ DCC & Manual Control, Makes Wiring Easy! PnP!
Starting at \$24.95

Order Yours

Athearn Genesis HO ES44AC GEVOs Are IN STOCK!



Get Yours Now at a Great TTX Price!
DCC Ready \$149.95 DCC & Sound \$224.95

Order Yours

Broadway Limited HO PRR H10 2-8-0



Exceptional Detail, Die-Cast Body & Chassis, Paragon2 Sound & DCC, Synchronized Puffing Smoke
\$359.95

Order Yours

Do you need a Sound or DCC Installation done?

Get a quote!



Providing unmatched person to person DCC support for more than 20 years, the kind of service that has made us #1 in DCC. **DCC questions? CALL US! 1-800-978-3472**
*Mention this ad for \$5.00 off your next order over \$100!

We'll get you on the right track!

Oct 2014



Sound quality

My first test was with an 8-ohm, 8-inch pager speaker in an angled baffle from the '60s or '70s. The sound volume was enough to run you out of the room and the sounds were crisp and clear. There was a bit of hiss audible, but when the master volume was reduced to a reasonable level, that went away. My take is the sound is just fine for the intended use. The horns and bells are loud and crisp.

DecoderPro support

SoundTraxx supplied an early copy of their technical manuals to the DecoderPro folks and there was a preliminary definition file available even before the first SoundCars shipped. Alain Le Marchand modified the existing Tsunami files. As of this writing (mid-July 2014), the files are available, but a bit tricky to install by themselves. The next production release of DecoderPro will have them included.

Looking at the DecoderPro sounds screen [5], one of the most important sliders is labeled Moving Sound Scalar. This is where you synchronize the wheel clack and flat spot sounds to the speed of the car. I found that 100 was too fast. Setting it in the 30 to 50 range worked well.

So there you have a quick look at what I believe will become a new trend in decoders: sound for your cars, and lights, too. Now that SoundTraxx has thrown down the gauntlet, I'm sure others will follow. I can see them now, packing their recording gear and heading out.

If you enjoyed this column, please join in on the "after the show" fun online. Just click on the Reader Feedback link at the beginning or end of the column to go to the MRH website.

While you are there, vote awesome for my work, if you feel so inclined.

Continue to Mr. DCC's Workbench for details of an installation for this decoder system.

Until next month, I wish you green boards in all your endeavors.



Advertisement

**IOWA SCALED
ENGINEERING**

NEW

Infrared Sensors!

- Small size (0.25" x 2.25")
- No adjustment needed
- Simple, discrete under-track installation
- Variable release time up to 20 seconds

Visit our web site: www.iascaled.com



LEARN MORE >

COMING FALL 2014 – An exciting new sound product you won't want to miss!





Southern Digital

Specializing in DCC Since 1992



**20% Discount
on most items!**



DCC Conversions & Service

Orders Received by 3:00 pm EST ship the same day

WWW.SODIGI.COM

E-mail: sales@sodigi.com

(770) 929-1888

(Photo's are from our N-Scale layout)



From Mr. DCC's workbench Putting the SoundCar on the pike.

I liked the reefer cooler sound (they call it a generator), so I decided to put the test unit into an Athearn 50-foot mechanical reefer for our club's layout pcmrc.org.

Working to replicate the SoundTraxx installation drawing [3], I mounted the SoundCar in the center of the ceiling and the CurrentKeeper directly below it. The speaker was centered in the floor of the car. No lights were connected.

I milled a slot in the center of the metal weight, about ½ inch wide by about 1 inch long. Using that as a template, I cut a matching slot in the plastic car floor. If you don't have access to a mill, a half-dozen ¼ inch holes in the area below the speaker cone will suffice. Holes were also drilled to pass the power leads through the car floor. for the power leads to pass through the floor were drilled, too.

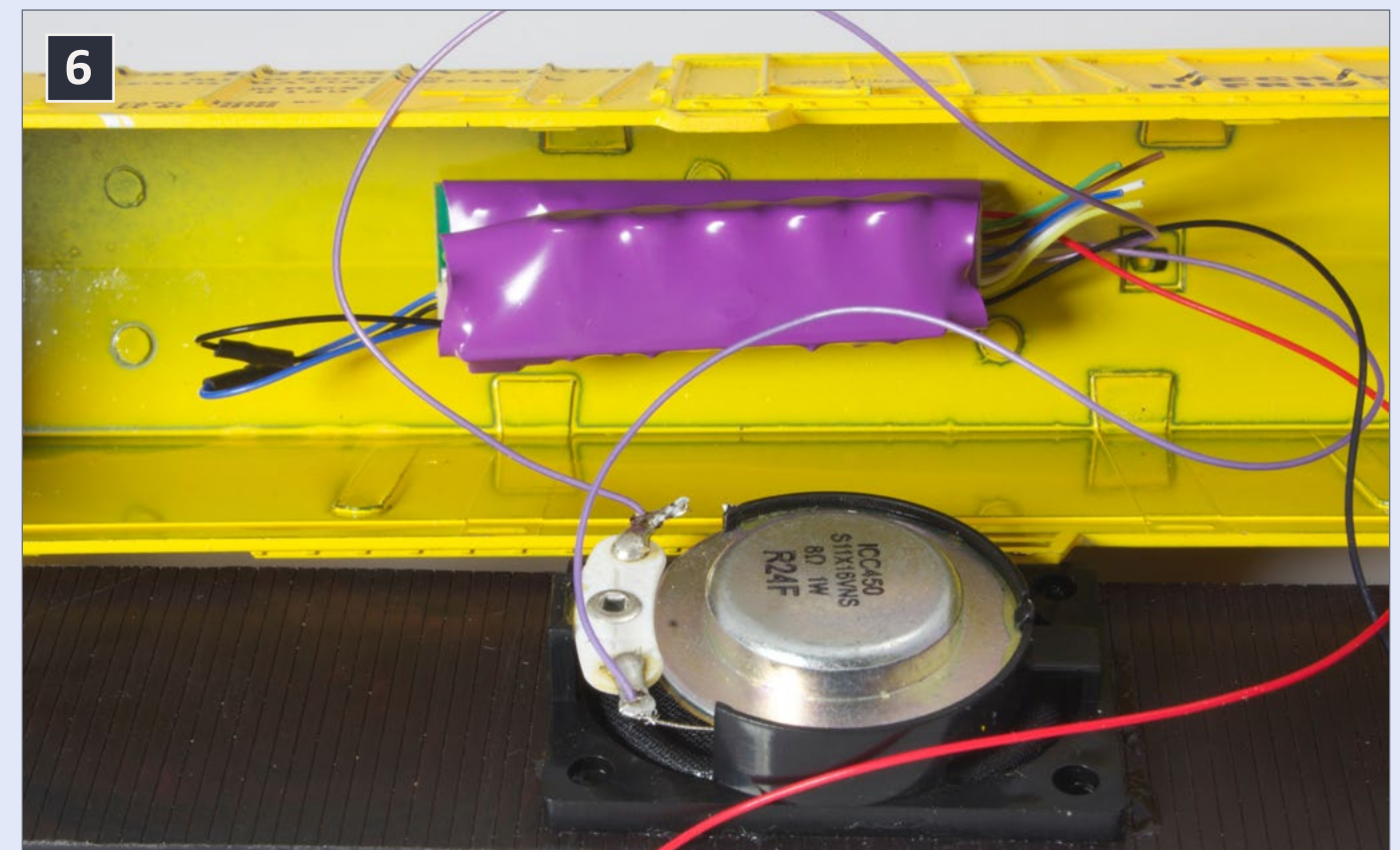

6. Interior view of SoundCar and CurrentKeeper installed in a 50-foot HO box car. Bruce Petrarca photo.



While I was at it, I painted the metal weight flat black and used the A-line "Bulls Eye Drill Jig & Tap Jig" to secure the coupler plates with 2-56 x 1/8 inch machine screws.

Using a bit of caulk daubed on the bottom of the plastic floor, I lightly stretched some black pantyhose material across the opening. After I daubed a bit of caulk around the mating surface of the speaker and positioned it, the metal weight was put in place and a clamp held the sandwich together while it dried overnight.

I plugged the CurrentKeeper into the SoundCar and held them together with a bit of the 3M tape. Then the two modules were stuck to the center of the ceiling of the shell.

Power pickups were built using phosphor bronze wire running through the truck bolster and wrapped as shown [7] to contact the axle of "live axle" wheels. I used Intermountain wheelsets, but any similar metal-axle wheelsets will work. The installation

required replacement of some Atlas wheels with plastic axles that had been used on our layout.

When the caulk was dry, the decoder was wired to the pickups and the speaker.

Bench testing showed that the CurrentKeeper would keep the SoundCar alive for a minute



7. Detail of the power pickup on the trucks, ready to mount and solder feed wires to them. Hint: Make sure the insulated sides of the wheels are on the same side of the truck. Bruce Petrarca photo.

www.Mr-DCC.com

Glad to help those getting started in DCC!

Litchfield

S T A T I O N



YD
Yankee Dabbler.Com



- Kadee
- NCE
- Digitrax
- SoundTraxx
- And more!



**Save On
All Top
Brands!**



HO
DCC
ALL SCALES

without track power. Even with four LEDs active in a different installation, I expect 20+ seconds.

This fella will now take his place on the club layout. I'll report back reactions in a future column.

Parts list

- SoundTraxx SoundCar
- SoundTraxx CurrentKeeper
- Black pantyhose material
- 28 x 40 mm speaker
- 0.01" diameter phosphor bronze wire
- Intermountain wheel sets (4)
- 3M gray outdoor mounting tape ■

Reader Feedback
(click here)

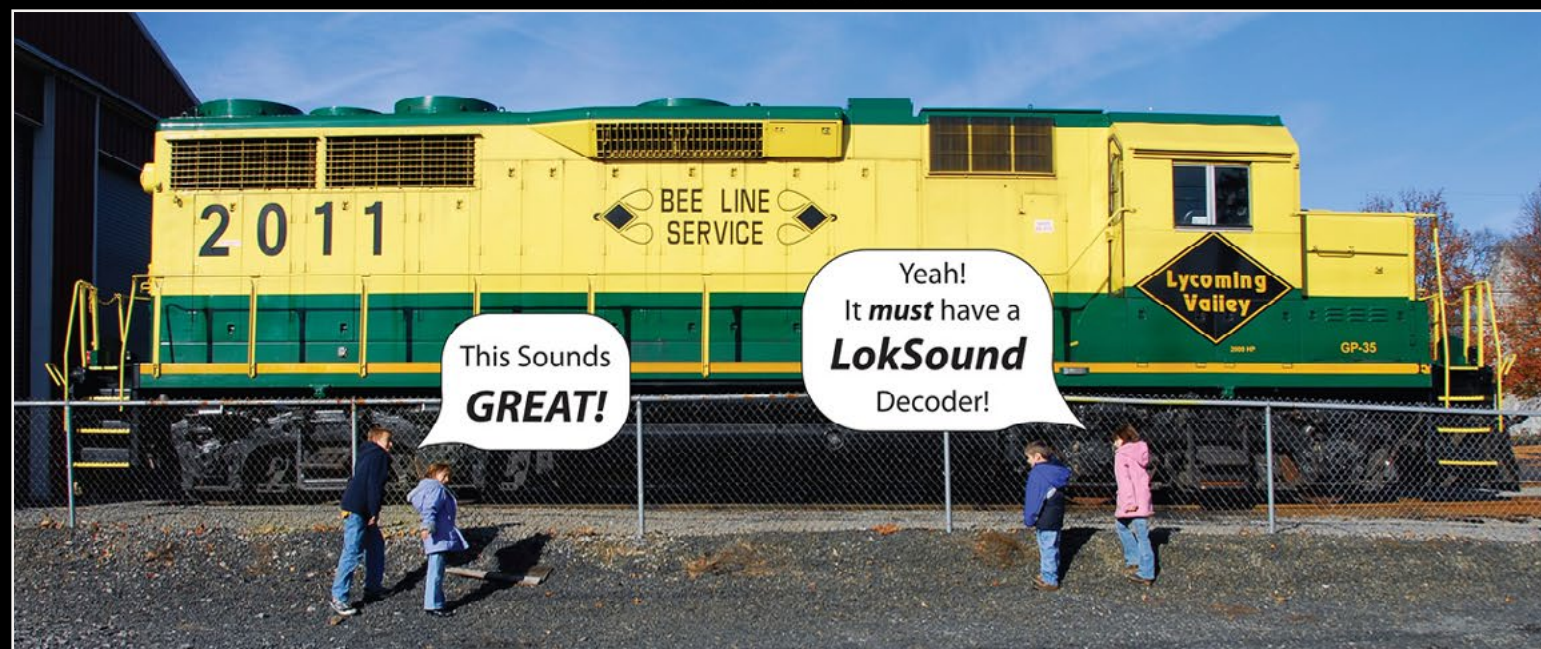

This Sounds **GREAT!**

Yeah!
It **must** have a **LokSound** Decoder!

ESU *SO REAL...You'll Think You're There!*
LokSound Select • 3 SIZES, ENDLESS POSSIBILITIES!

INDUSTRY LEADING MOTOR CONTROL

- Multiple Bell types
- Multiple Brake squeals

4 OR 8 Ohm SPEAKERS!

- 4 or 6 Output functions depending on the style
- Up to 4 Prime Movers or Steam Sounds on EACH decoder
- 16 Very Playable, LOUD Horns or Whistles depending on Profile
- All Changeable by using ONE CV! No Programmers or Boosters needed!*

Small Size
BIG POWER! 1.1Amp!
LokSound Select "4 AUX"

\$99.99
NEW 2011
Only Available From ESU LLC (USA)

ONE SIZE FITS ALL!
LokSound Select "DIRECT"



6 Outputs! LED Resistance Built In!
NEW 2011
LOK SOUND SELECT
Only Available From ESU LLC (USA)

Tiny Size,
HUGE Versatility!
LokSound Select "MICRO"

\$99.99
NEW 2011
Only Available From ESU LLC (USA)

- Great NEW Size 1.16" x 0.61"
- Versatile DCC & DC "Dual Mode" decoder!
- 8 channel sound system!
- FOUR lighting outputs and a 1.1A motor controller
- Available with ALL Current LokSound Select Sound Profiles
- Use 4, 8, or 16 Ohm Speakers

- Easy Drop in Design
- Versatile DCC & DC "Dual Mode" decoder!
- 8 channel sound system!
- SIX lighting outputs ALL with built in resistors for LEDs
- Available with ALL Current Diesel Sound Profiles
- Use 4, 8, or 16 Ohm Speakers

- Great NEW size ONLY 0.98" x .417"
- Versatile DCC & DC "Dual Mode" decoder!
- 8 channel sound system!
- FOUR lighting outputs and a .75A motor controller!
- Standard 8-pin NEM 652 plug included
- Available with ALL Current LokSound Select Sound Profiles
- Use 4, 8, or 16 Ohm Speakers!

*ESU LokProgrammer needed to "Replace" Sound and for Firmware updates, not for normal editing
www.LokSound.com • 477 Knopp Drive Muncy, PA • 570-649-5048

Now on facebook!





Digitrax No Worries Warranty Keeps Your Layout Running!

That's it! A simple, straightforward one year warranty with no tricky language!

You're protected against defects and accidental damage.

Learn more at: www.digitrax.com/noworries

Need tech support?

www.digitrax.com/contact

Need a repair?

www.digitrax.com/repair

Need a throttle conversion?

www.digitrax.com/upgrade



Best. F-Unit. Everrrr.



**HO
SCALE**



**CLICK HERE
TO ORDER!**

ORDER DEADLINE: SEPTEMBER 30TH

AMERICAN FP9A LOCOMOTIVES

www.rapidotrains.com

MRH-Sep 2014

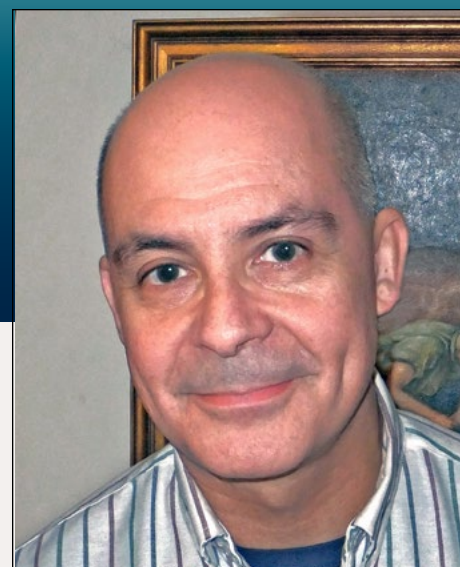

Layout Building Productivity Part 2

Modeling real railroads and what they do



Getting Real column

by Mike Rose

Determination can be a real motivator ...

Last month I documented a scenery effort that took place in September and October 2013, in time for a November op session. That went extremely well and the efforts were well received, but it was not lost on me that the scenery-free area on the opposite side of the peninsula was now even more of an eyesore by comparison.

I was determined to get that entire aisle fully foamed and be done with the giant mess of cleaning up the foam carving entails prior to my next op session, in March of 2014. This was ambitious, because even though it covered an extra month, it also included the holidays and a trip to Florida for *Prototype Rails* in Cocoa Beach.

“I was determined to get that entire aisle fully foamed and be done with the giant mess prior to my next op session ...”





32. When we left Laceyville to concentrate efforts on the other side, the foam had been transitioned to the existing Laceyville backdrop, but what happened here? Yes, I decided to rip all that out as well and start fresh from the benchwork up. In the left rear you can see the pink foundation, and the mountainside above it that had already been installed. The green foam pieces are stacked up and ready to be installed, but first we need some new terrafirma!

iwata

by ANEST IWATA

Just Rolling By...
 Make It **REAL** With Iwata
Climb Aboard!

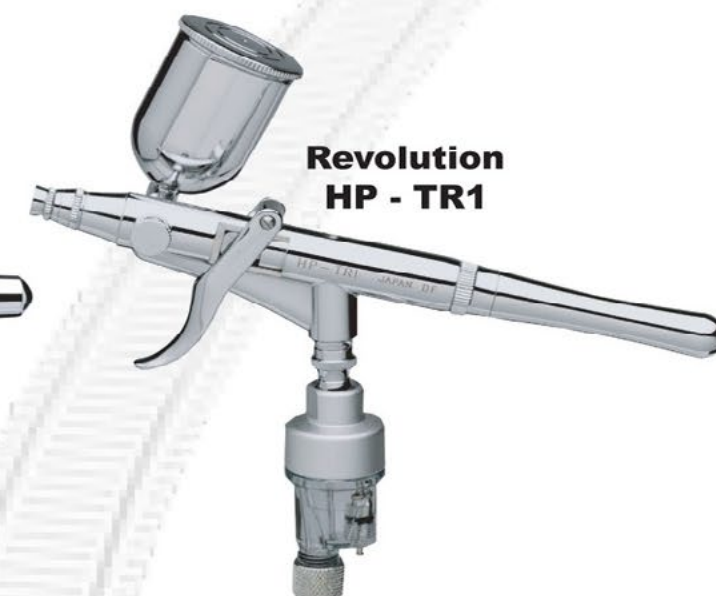

Visit...
www.iwata-medea.com
**To Check Out Our
 Full Product Line!**

*Models By... Alan Houtz,
 North American Prototype Modelers*



33



33. A sheet of 1" pink foam was cut out, to fit perfectly where the old town had been.

34



34. An overlay of $\frac{3}{4}$ " green insulation foam (see Part 1 at mrhpub.com/2014-08-aug/land/#42) brought the foam "sandwich" up to the right thickness to match the sub-roadbed plywood.

35



35. I removed the green foam overlay and carefully marked out the joist locations on the pink foam so that I could screw it down properly.

36



36. The joist marks were extended onto the plywood sub-roadbed so that I could still know where the joists were when the green foam was installed.

Advertisement

NICK & NORA DESIGNS
Uniquely inspired craftsman kits

Gold Medal Flour
LUNCH AND CONFECTIONERY

Annie's Lunch Counter - kit # ST021

Craftsman Structure Kits,
Detail Parts, Shingles & More!
www.nickandnoradesigns.com

Nick & Nora Designs
a division of:
TMB Custom Models

LIKE US ON **facebook**



37



38



37. A receiving notch was cut into the 2" pink foam holding up the previously built hillside, to receive the pink foam board that would support Laceyville.

38. Once the foam board was down, I added a layer of 2" florist's foam and began to position the houses on this street. Note the prototype photos in the foreground. I took those on a visit to Laceyville with an eye towards locating each house in terms of

elevation from the street, and to provide model builder Rich Cobb with what he needed to recreate this residential area. I think he did a great job capturing the essence of the area – instant town! It would have taken me months to build all those houses, assuming I would even get to it, so having Rich build these was well worth it.

Advertisement

CHECK IT OUT!

TCS

Been WOWed?

WOWSound

The world's leading sound decoder

Listen Here

Advertisement

Lasercut structures. Highway, storefront and billboard signs.

Neat ag customer for your railroad:
Farmers Fertilizer Supply

WHAT'S NEW? Established 1993...
Blair Line



39



39. The debris field: I don't want to give the impression that working with the foam isn't messy! But as my friend Mike likes to say, "it cleans up easily," and compared to drippy plaster cloth I fully agree.

40



40. The next step is to do the tricky job of fitting the foam to the remainder of the hillside.

Advertisement

NEW!

**DCC Train Shuttle ...
aka, "Prof Silencer"**

TamValleyDepot.com

Advertisement

RR-CirKits, Inc.
Affordable Electronics for Model Railroads

- Computer Interface
- Signaling
- General I/O
- Block Detection

WatchMan

CHECK IT OUT!

Now Shipping!

[Learn More ...](#)



41



41. All of that foam fitting and carving was done in a pleasant Saturday's effort.

42

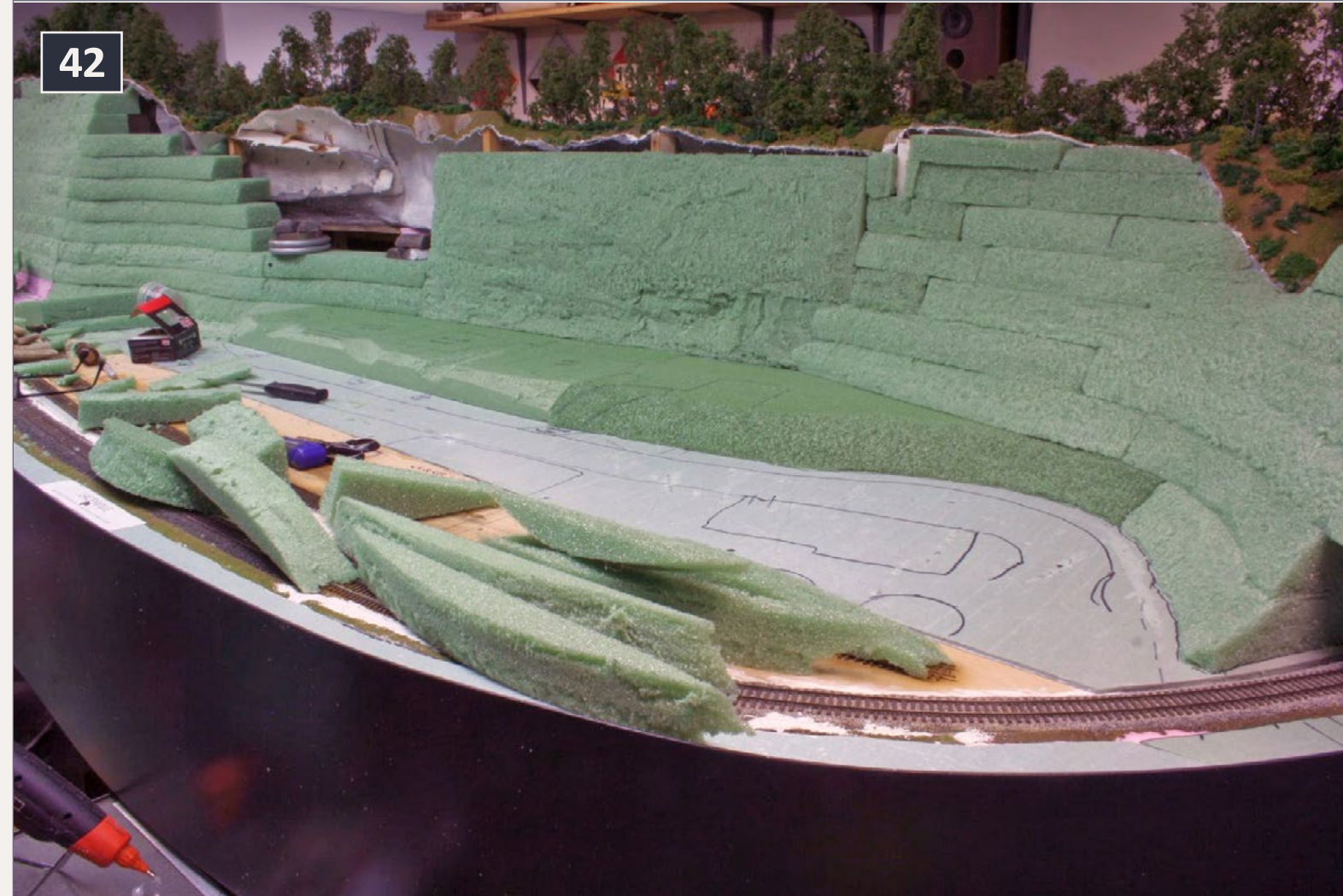

42. Closing the gap: On Sunday I began and completed the task of connecting the new backdrop at Laceyville to the previously done foam heading to the left, towards Wyalusing. Note that even with hot glue, it's beneficial to use weights to hold it down for a couple of minutes if the substrate is not perfectly flush.

43



43. In this view the entire foam backdrop is almost 100% in place and it's making me feel much better about this side of the peninsula. Compare this with the earlier shots and the fact that I'd been living with that mess for too long!

44



44. With the foam in place it was time for dirt. The foam is easily colored with latex paint (I use cheap, \$10/gal. "off-mixed" paint from places like Home Depot and Lowe's), a large brush and a squirt bottle of water to spray furiously as you rapidly paint the surface. I credit my buddy Mike Confalone for that method. It's effective and fast. While the paint is wet I sprinkle real dirt over the entire surface. Here, no blending with Sculptamold was done, although I did sprinkle a little green and got scolded for it by Mike!

45



45. On the next train night I crawled up on the layout. That's what the blue foam board on the left is for, to protect the track from me, and me from the track! I laboriously completed the rest of the hillside behind Wyalusing. It's a tough spot to work in because of the reach-in factor, but once done, there would be no need to ever go up there again, mercifully. I did this on train night, when the work crew came over, so that once I was on the layout, anything I forgot could be handed to me by my friend Dave. I call it ground support.

46



46. With Wyalusing's hillside largely in place, I turned my attention to the first "lump" needed to hide a train disappearing behind it. No more tunnels or hidden trackage for me, but nobody said you can't obscure the sight of the train where needed. The auto rack is on a completely hidden track coming from Mehoopany that is considered to be Vosburg Tunnel. It's hidden by a to-be-treed berm in front of it. The track in front of the berm is actually the main line and it continues out of sight until it re-appears up at Milan, on the way to Athens and finally Sayre. The track in the foreground leaves the main to the right at Presswood, on the way to the big Masonite plant and Towanda.

47



47. Here I'm beginning the second lump, the top portion of which is removable in case I need to access the track behind. The glue gun is in the future riverbed.

48



48. The final carving of the two lumps is largely complete here. Just doing away with the large grooves behind them made a huge visual impact. This view is again taken from just above Laceyville at the end of the peninsula, looking at the portion of the layout that is attached to the wall.

49



49. Continuing to the left, you can see the stream bed and drawn-in stream that the thinned, blackened sub-roadbed crosses. Girders will be glued to the side of this, and a set of custom New England brownstone abutments and center pier will support it as it enters Towanda Yard. The end of the second lump is off to the right. In the distance you can see that green foam has begun to complete the hillside carved out of the old mountain at Milan. It's in this area that the main line needs to reappear from behind some trees.

50

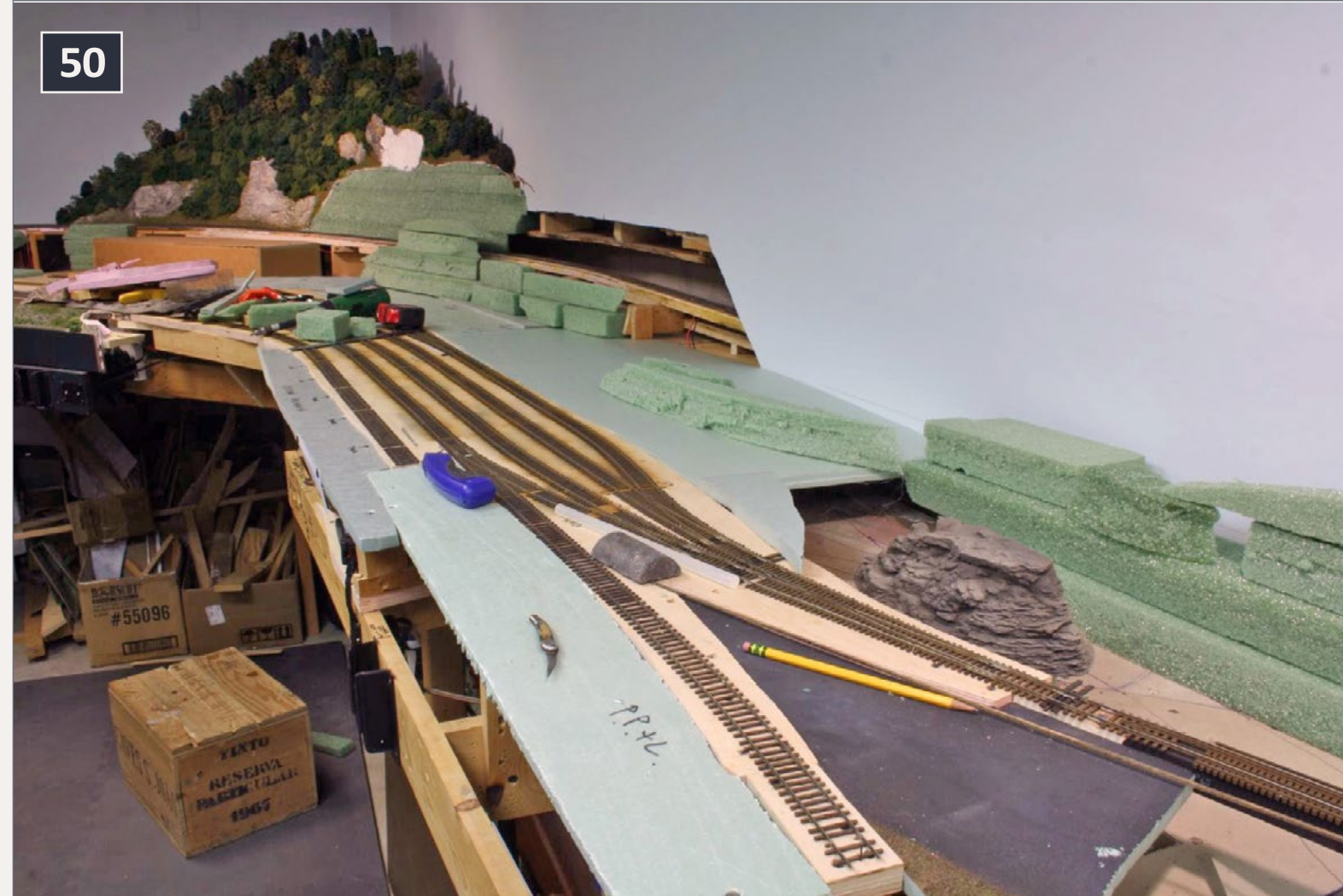

50. Up near the top, you can see that foam is beginning to be stacked to form the next "treed lump" that will disguise where the main returns to the visible scene. Note the white plaster spot on the old mountain where some early plaster rock castings were removed. They were the wrong rock, wrong color, etc.

51

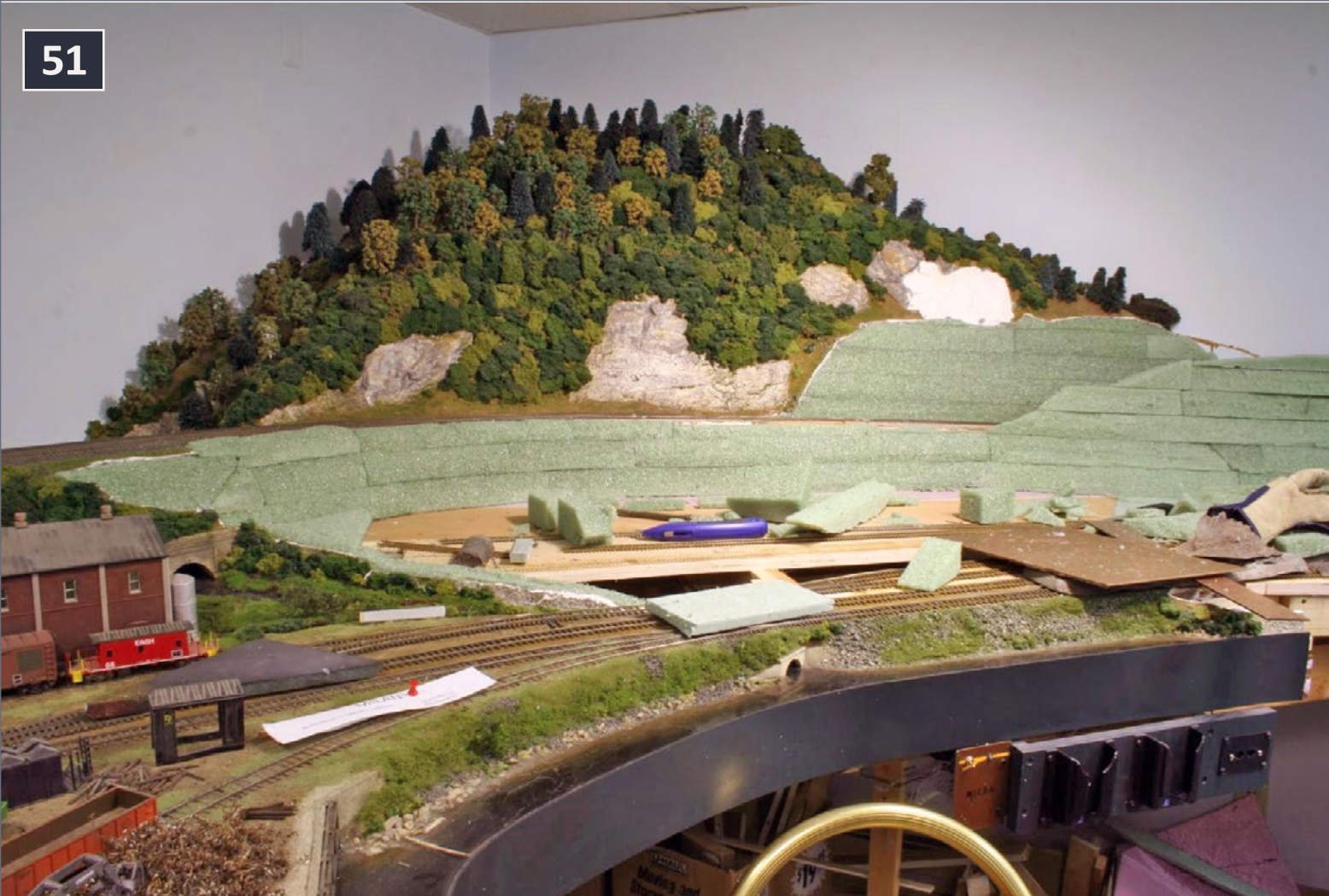

51. I'm glad I had good foam experience under my belt here. It really helped to accurately cut and fit all the new pieces to match what I wanted to save of existing scenery. The blue utility knife is in the exact middle of where the big Masonite complex will be. This was an important industry for the railroad with raw materials brought in by tank cars and covered hoppers, and products shipped via large cuts of Thrall-door boxcars.

52



52. The usual paint and dirt cover the foam, and I immediately moved into tree planting mode. This really helped to reconnect the new and old scenery.

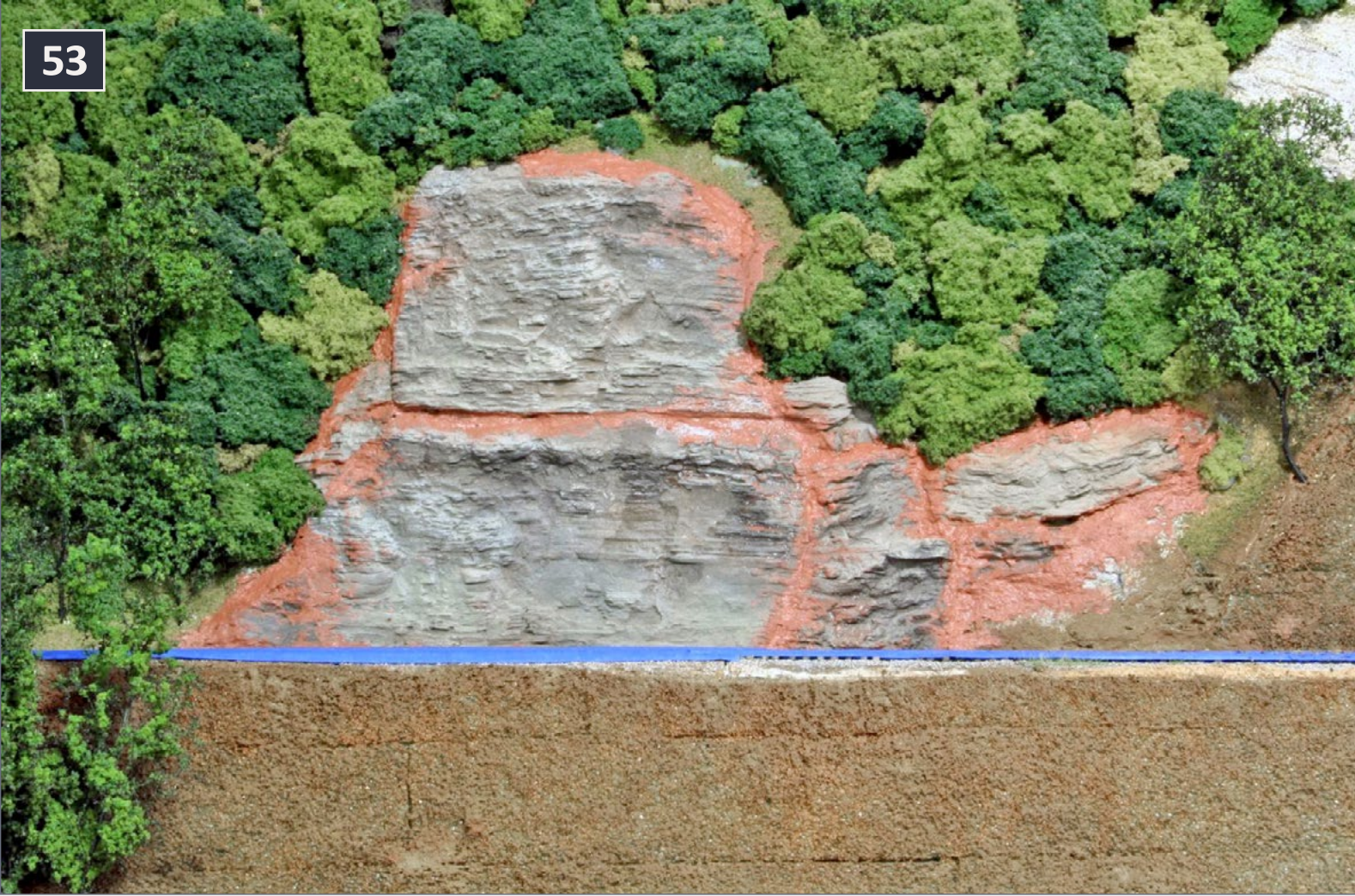

53. Various pieces of Cripplebush shale rock castings were cut up and applied to the old mountain, and blended with colored Sculptamold.

Live Operating Session on ...

Mike Confalone's **ALLAGASH RAILWAY**

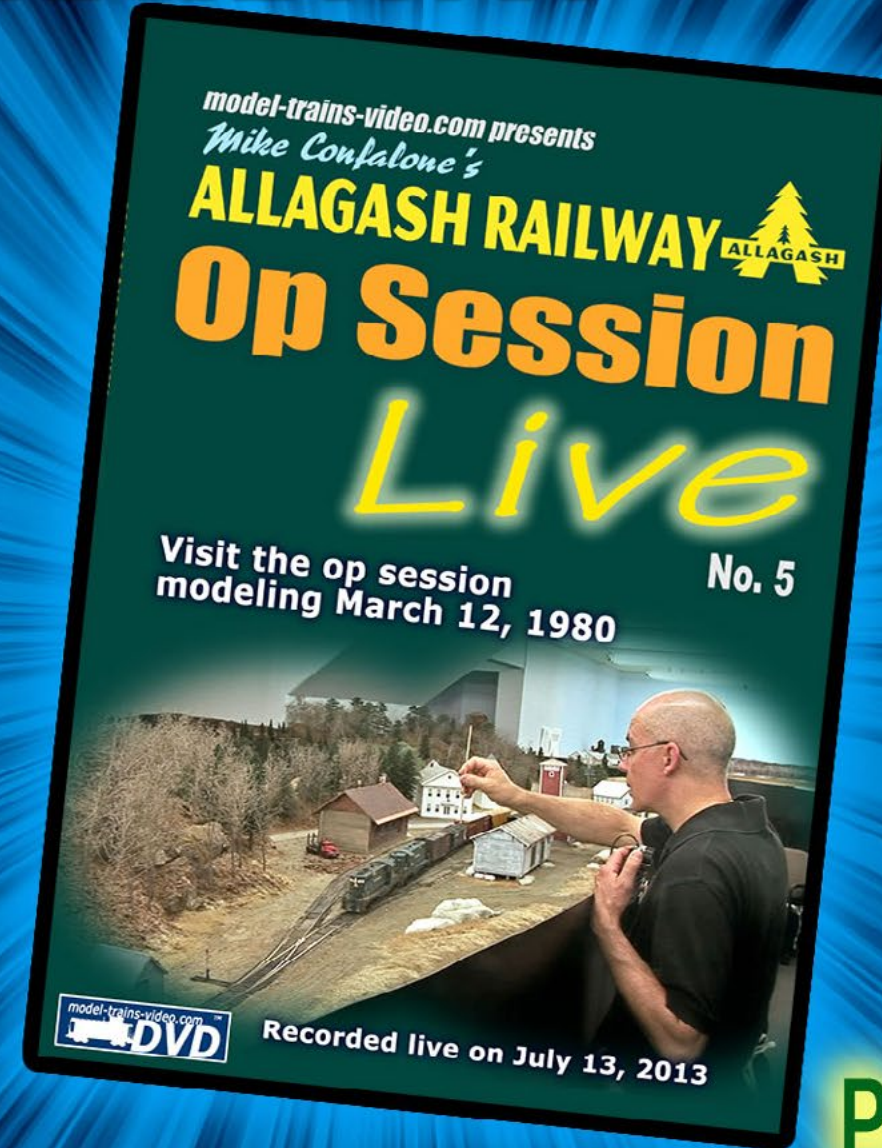

~~\$24.99~~

Preorder price:
\$19.99

Release date: September 22

 **Preorder Allagash Ops Live - 1**

from the
**Model Railroad
Hobbyist Store**



54



54. The mostly finished scene, with a rough cardboard mock-up of the future Masonite plant, shows the treed hillsides, upgraded old mountain, and the properly colored, blended, and weathered shale rock formations that replaced the old castings.

55



55. Directly opposite the previous picture, at the end of the peninsula (Laceyville is at the extreme left), I decided to greatly reduce the foam shrubs that covered that area with something that people could rub up against and not damage, unlike Super Trees! I had these sample Cripplebush castings and thought “why not?” They seemed to fit well there. Bonded with Power Grab, these thick castings – made from a different material – were difficult to attach fully to the convex surface, so I tacked them in several places with drywall screws! If you know where to look you can see one or two, but these were soon to be covered.

56



56. Here are the same castings with some wet colored Sculptamold used to blend them in place. See the difference between the old and new rock types? Everything here needs to be shale. There's a reason that fracking for oil today is a major industry in my modeling area. The castings were continued one to the other with Sculptamold.

57



57. In this shot, note how the castings and Sculptamold are properly colored with flat latex paint that I had color-matched to an actual piece of slate I brought home from Meshoppen on one visit there. Powdered pigments are used for weathering and accents. All that remains to do is one more coat of fresh paint on the fascia.

58



58. The beginning of trees on the Laceyville backdrop. This would be the beginning of a major tree-making effort that dwarfed anything I'd done prior to this. Remember, these hillsides are tall, and the entire length was in excess of 12 feet! This section was destined to soak up more trees than any other area of the layout.

59



59. For prototype perspective, here's a shot I took from the main street in Laceyville. The former Whipple's Lumber is on the right (now Vern's), and Skinner's Eddy is practically a stone's throw away just around the corner. Note the steep, heavily wooded hillside backdrop. In this area, there is a view like this in at least one direction nearly everywhere you go. You can see why this appealed to me from a modeling perspective. The main line is to the right, behind Whipple's.



60. As the installed trees started to creep inexorably towards Wyalusing to the left, I began to realize that somehow I needed to ramp up my tree production and get this hillside done. The New England Meet loomed (as did my promised clinic which did not get done until the day before the meet), then an “away” op session, followed by my own session three weeks after that. Could I get it all done in time?

61. Here’s my tree making production factory. There’s a lot going on in this picture! That’s the door to my furnace room with wires strung across it to hang trees from. Below that is a former clothes drying rack my wife supplied, probably knowing she’d never see it again. On the floor are boxes of non-tree material that I spray, dip by the handfuls in the glue/water solution, then coat with the foam material. This stuff is truly valuable, and I use it as shrubbery to fill in any glaring gaps in the tree scape. It also becomes underbrush along the tracks. I can’t make enough of it! To the left is a cart of my own design that holds A-Line boxes full of rolling stock, and a couple of handy heavy-duty contractor-type trash bags to become cart and floor covers.



Super Tree tips

People have asked how I make so many trees. I do it in stages, and it helps a lot that the weather is perfect for painting the armatures outside. Much more difficult in the winter!

- I take the best armatures from the largest Super Tree case and quickly pick off the little leafy “thingies” that are on them. Too many in some cases! I use tweezers, lots of light, a comfy chair with a sheet covering it and the floor, and a good old movie I’ve seen a bunch of times that I can mostly listen to. A Super Tree case contains about six “plants” that you pick apart, and I usually do an entire plant, or one and a half, in a picking session. My wife is usually long gone to bed when I do this!
- The next day, or at the next opportunity, I take them outside and spray them all flat black. I used to mist the bigger ones here and there with flat gray, but it proved to be totally worthless when modeling dense forests. I’d still do that for stand-alone foreground trees. I use \$1/can WalMart spray paint, which has the perfect spray pattern and is ideal for this use. A good can of Krylon proved not so useful: too heavy a spray and four times the price! One cheap can does about 30 trees, and when I go there I buy a dozen at a time. Each spraying session, or roughly 90 trees, consumes about three cans. I used to let these dry overnight, but then found that I could spray them in the morning, make the trees after or just before dinner, and install the trees by midnight!
- The trees are dipped into a 50/50 white glue/water mixture. Matte medium also is great for this, just a lot more expensive. I then shake off the excess fluid and immediately sprinkle on first darker green, then lighter green fine ground foam while holding the armature at about a 45-degree angle. Doing this minimizes the amount of foam that sticks to the trunk. You’ll find you get good at this very quickly.
- I had always hung the trees upside down using clip clothespins as shown, let them dry, then stuck them in a box with many holes drilled in the top so that I could spray them with Aqua Net Unscented Super Extra Hold #3 hair spray and sprinkle them with Noch light green leaves. The different colors tend to give the trees some depth, and you want the lightest colors to the outside where they’d catch the “sun”. Lately I’ve been immediately putting the trees into the box where I’ll spray them, which saves steps. They’re stiff enough that they don’t droop. After a few hours they’re ready to plant, and this can be hurried by putting a gentle fan breeze on them to dry.
- With this tree making technique I can plant roughly 90 trees in 10 minutes. Once the armature has been painted, the making of the tree is not much more than 30 seconds. My total production of trees in this two and a half month phase was well over 900 trees, basically equivalent to my entire tree-making output of the past few years! ■

General Electric ES44

Arriving This Fall



DCC Sound Equipped With Remote Couplers



80-2318-1 Union Pacific ES44AC Diesel Engine with Proto-Sound 3.0

Featuring:

- Intricately Detailed ABS Body
- Metal Chassis
- Metal Body Side Grilles
- (2) Engineer Cab Figures
- Authentic Paint Scheme
- Metal Wheels and Axles
- RP25 Metal Wheels
- (2) Operating Kadee Compatible Remote Controlled Proto-Couplers
- Prototypical Rule 17 Lighting
- Directionally Controlled Constant voltage LED Headlights
- Lighted Cab Interior
- Illuminated Number Boards
- Flashing Charging Lights
- Powerful 5-Pole Precision Flywheel-Equipped Skew-Wound Balanced Motor
- Locomotive Speed Control In Scale MPH Increments
- Operates On Code 70, 83 and 100 Track
- 1:87 Scale Proportions
- Built-In 28-Function DCC Decoder
- Proto-Sound 3.0 With The Digital Command System Featuring Freight Yard Proto-Effects
- Operates On 22" Radius Curves



HO TRAINS THAT DO MORE

www.mthHOtrains.com



Follow Us Online!



M.T.H. Electric Trains is expanding our modern HO motive power roster with the release of the General Electric ES44 diesel locomotive. Outfitted with a powerful five-pole skew wound flywheel equipped motor, LED lighting, remotely operated Kadee® compatible couplers, user-installed Kadee® replacement couplers, full digital sound and a 28-function DCC decoder with Advance Consisting, Feature Mapping and Speed Mapping make this and all M.T.H. diesel locomotives HO's best motive power value.

©2014 M.T.H. Electric Trains

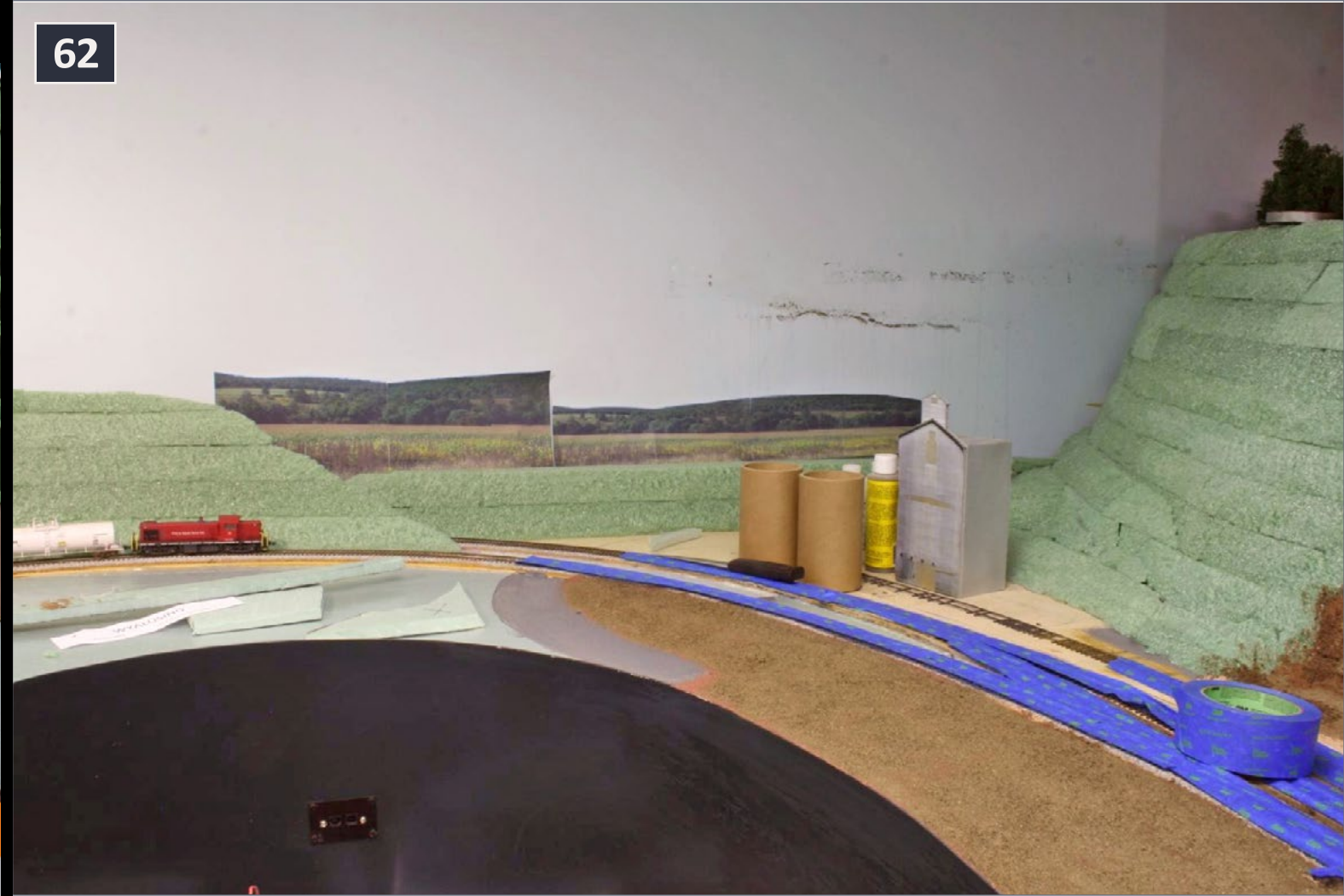

62. In the middle of all this, I went up to Mike Confalone's to help him with a major grade realignment on his layout. He's two hours away, so we try to make these visits count. Not only did we get all that done, but he also took a crack at PhotoShopping some scenic views I'd taken in my modeling area on the last trip there. We printed them in two different sizes so I could try them in place at Wyalusing. His guess was correct – the smaller size was the right one. I then had him finish up the file and took it to a commercial photo printer I use, to print about five feet long.



63



63. In order to prep the area where the photo would go, I needed to paint and dirt the hillsides around Wyalusing. I used pieces of foil tacked in place with painters tape to protect the sky-painted walls.

64



64. It took me longer to put up the foil than to paint and dirt the hillsides, which was barely a 10-minute task.

65



65. Just a few minutes' work had an immediate big impact, having looked at the bare foam for so long.

66



66. For the backdrop, you completely cut out the photographed sky and just keep the land, so all the sky you see in this shot is painted wall. The photo is applied directly to the wall with doubled-up blue painters tape. I started to install trees from the back right-hand corner and worked towards the front, doing the berm at the same time. The wall below the photo was painted black, so that when standing close to the fascia you'd see nothing but shadow below the picture. We were all stunned at how the photo backdrop opened up that entire scene and gave it amazing depth. Very high impact!

67



67. Here's what the tree installing process looks like, with boxes of them brought in and quickly planted.

68



68. Coming from the other direction, Laceyville, the tree scape is past the entire town and beyond the abandoned Van Der Voort's Feed Mill.

69



69. The final gap. Could I make it? This shot was taken on the Tuesday before the Collinsville CT meet on Friday. I stayed up very late picking another batch of 77 trees, the last of that case, and on Wednesday painted them in the morning, made them in the afternoon, put the fan on them, and installed them Wednesday night! I took the final photos on Thursday, did my clinic in its entirety (nearly 200 PowerPoint slides) and headed out Friday morning for the meet. That was cutting it too close, but how could I leave a gap like that? It HAD to be done!

70



70. The gap is closed, and the 77 trees just barely filled it! Compare this view with earlier scenes to see the impact made by a photo backdrop and trees.



71. Looking back from the beginning of Laceyville, you can see now how this town will come together nicely this summer, and the completed treed backdrop makes that possible. More contouring has been done to the foam where the houses sit. The last two are a good half-inch lower than the rest, in keeping with how the actual town is.

Advertisement

ONE STOP SHOP**N, HO, O, ON30, S & G****SHOP ON-LINE 24/7****FOR YOUR FAVORITE PRODUCTS:**

ATHEARN | ATLAS | ARISTO-CRAFT | BACHMANN | BROADWAY LTD.
 DIGITRAX | KADEE | KATO | K-LINE | LIFE-LIKE | LGB
 LIONEL | MANTUA | MICROTRAINS | MODEL POWER | MRC
 MTH | NCE | PECO | PIKO | SOUND TRAXX | TCS
 WALTHERS | WILLIAMS | WOODLAND SCENICS | AND MORE...

SIGN-UP FOR OUR E-MAIL SALES**TRAINWORLD.COM**

1-800-541-7010 e-mail: ORDERS@TRAINWORLD.COM
 TRAINWORLD®/TRAINLAND® - AMERICA'S LARGEST INTERNATIONAL MAIL ORDER DISCOUNT TRAIN STORE



Advertisement

Railroad Explorer Magazine

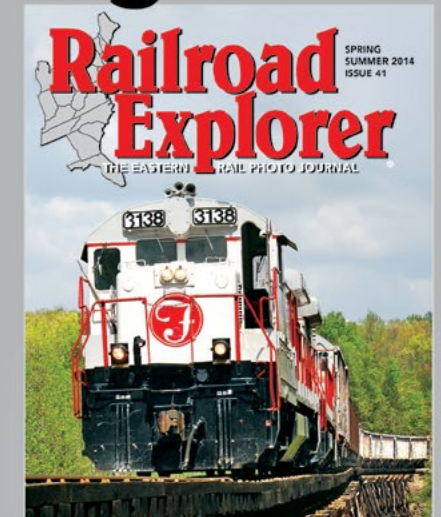
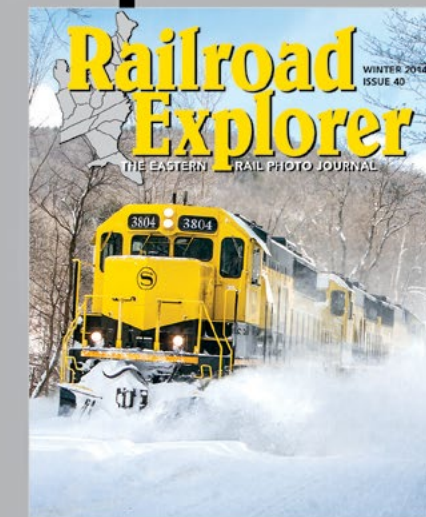
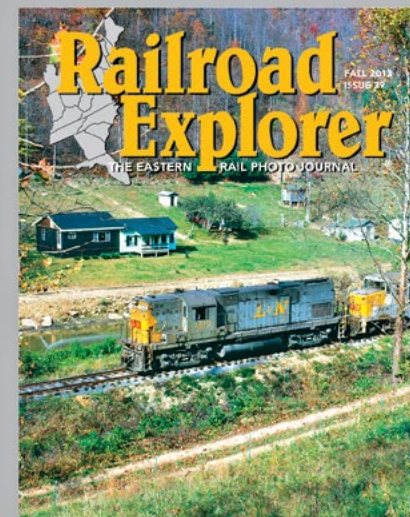
**THE EASTERN RAIL PHOTO JOURNAL**

- Three all-color issues per year. Exciting feature stories and spectacular photos of Eastern Railroading
- Best-in-class photo reproduction. Printed on heavy, glossy paper. Zero advertising.
- Three times per year - Winter, Spring/Summer and Fall editions.

Subscribe today!www.railroadexplorer.com



All this work was done during a time when outside projects were ramping up. I'd started a major bathroom remodeling project, and once my customers got wind of that, they all began contracting me for a variety of new IT consulting work!

I want to emphasize that the main factor in getting all of this modeling done, despite the other demands on my time – like anybody else – was the decision that I'd carve out limited but dedicated chunks of time whenever possible, on a regular basis. The will to do that and stick to it, more than anything else, was responsible for this very satisfying surge of progress. It set up another positive feedback loop where the more I did, the better it looked, and the more I wanted to do. This was nothing like the year I spent some time back putting in feeders!



72. Possibly my favorite “surprise” shot, this was a last-moment grab that somehow captures the feeling that my layout is finally “Getting Real.” For me, this is what my modeling is all about. I can't wait to finish this town during the summer and build the very interesting Purina mill in Wyalusing. Look for it in my next column.

September ...

ON TRAINMASTERS TV



New Free-Mo module building series
THE ROADSHOW

[Visit TrainMasters.TV website](http://TrainMasters.TV)

HOW-TO



DCC decoder and sound in 45-tonner

LAYOUTS



J. Miller's HO Kanawha & Lake Erie

BACK TO THE BASEMENT



All about benchwork

FROM THE DVD ARCHIVES



Gorre & Daphetid look-alike layout



My 21st video column for Model Railroad Hobbyist!

Photos and video of superb models

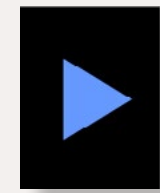

Reader Feedback
(click here)

What's neat this week column
by Ken Patterson



1

1. Union Pacific locomotives glide through Jeff Meyer's innovative snow diorama.

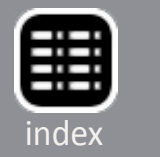

This month, the video came first and the script followed, starting with the Jeff Meyer photo shoot segment. Every month Jeff seems to show us something cool. This month it's a snow scene made using foam. The snow and static grass are permanently glued down, to be used over and over to make snow photos in the coming months. In the video, we will talk about the diorama's construction and its uses. The final segment will show modular construction for home layouts.

[... On to next page of article →](#)



Playback problems? [Click to try a different version.](#)

HO SCALE



Click Here To Order

ORDER DEADLINE: **SEPTEMBER 30TH**

Canada's CONFEDERATION TRAIN

www.rapidotrains.com



2



2. Mike Budde talks to us about a new product that is right up his alley, auto rack loads for the '60s, '70s, and other uses up to the present. Mike is well known for his award-winning auto racks with loads.

3



3. The cars are created on a 3D printer and sold on the Internet through a German company, at Jahn3d.de Google it and get ready to be impressed with the variety of models offered.

Get the Latest Model Railroad News, Tips, Reviews & Opinions

The SCOTTY MASON SHOW

The Original Model Railroad Podcast

- Monthly Interviews
 - Modeler's Spotlight: Top Modeler's Talk
 - Narrow Gauge Modeling w/Chris Lane
 - Contemporary Modeling w/ Mike Rose
- More Product Announcements & Reviews

 **Our feed has changed! To get the latest shows, Please search Scotty Mason and subscribe to the new feed!**

www.TheModelRailroadPodcast.com

Scott Mason Jimmy Simmons Mike Rose Joe Duckworth



4. Mike cuts out the windows of the hollow-bodied vehicles, then fills and smooths the cars' imperfections with body putty. After painting, he applies Bare-Metal Foil and glass, using clear tape as glass. The result is a gem like this in-process photograph of a 1972 Chevrolet Impala.

Visit:
kenpatterson.com

**To download some
great model railroading
how-to videos by Ken**

click here to ...

Visit Ken's website



Ken describes what's available

5



6



5-6. Here's a closer look at the front and back of the finished Chevy Impala. The scrap-box tires came from another car model, but the Jahn3d.de cars come with tires attached.

7



8



7-8. A finished 1970 Chrysler Newport shows the wheels and tires that come with the model. These "everyday" cars and trucks are scarce in the hobby, unlike the Corvettes and Mustangs that seem to be easy to find.

9



9. Two variations of the 1966 Chevrolet C10 pickup are available. Watch the video to hear Mike Budde talk about how he finishes these models.

10



10. Models like this 1970s Lincoln Continental come boxed and sell for around \$15.00 to \$25.00 dollars each, at jahn3d.de. The website is in German and French.



Playback problems? [Click to try a different version.](#)

11



11. The last segment of this month's video discusses layout construction. The sectional design of a modular-type of layout works well with workbench construction, followed by "clean" placement in the layout room. I will show you how the layout can come apart to change out a turnout on the far side, all without bending over any scenery.

12



12. I learned everything about modular layout construction from the Midwest Valley Modelers layout, built by an HO club I started in St. Louis in the fall of 1988. With this layout, our group of guys did 35 train shows and shot hundreds of articles and ad photos up until 2006, when the layout went to a private owner. When I started construction on my home layout in 2004 I knew the modular method was the way for me to go. The ease of workbench construction and repair is shown in detail in this month's video, as well as the ability to shoot great outdoor photos of the same scene.



Reader
Feedback
(click here)



True Scene™ Modeling

NEW FusionFiber™

Scenery Base Material for the 21st Century!

SATISFACTION GUARANTEED!

www.truescene.com or 716-523-7305



Don't settle for lifeless signals!
We've got signaling circuits!

LOGIC RAIL™ TECHNOLOGIES "Sophisticated Model Railroad Electronics"

Please visit our website and online store!

21175 Tomball Pkwy Suite 287 Houston, TX 77070 Phone: (281)251-5813
<http://www.logicrailtech.com>
info@logicrailtech.com

Can't remember which cars you've bought?
Yard Boss
Model Train Inventory Software
 from DCC by Design
 Under \$15
 Download free trial now
www.dccbydesign.com

Jelsma Graphics
 AMERICA'S NUMBER ONE RAILROAD PRINT SOURCE
 Railroad Art-Prints, Caps, Jackets, Shirts and More ...
 Jackets starting at \$79.95
www.jelsma.com
 1-904-221-3513 • Jacksonville, FL.

Yarmouth Model Works
 HO scale resin kits and detail parts

U.S.A. MAILING ADDRESS
 3560 Pine Grove Ave. Unit 617
 Port Huron, MI 48060
 Tel. 519-633-7574
pierre.oliver@start.ca
www.yarmouthmodelworks.com

CANADIAN MAILING ADDRESS
 85 Hiawatha St.
 St. Thomas, ON N5P 2T5



Minimalist Model Railroad Design

Minimalist Model Railroad Design
 Minimalist Model Railroad Design
 All New 2nd Edition! [Click Here](#)

Have you seen these popular blogs on the MRH website?



Ken Glover's Shelf Layout
 52,000 reads
[CLICK TO READ IT NOW](#)



Mike Rose's N scale empire
 64,000 reads
[CLICK TO READ IT NOW](#)

Mr. Detail Parts

New Parts Added Weekly!
[Click Here](#)

www.mrdetailparts.com

WESTERFIELD GOLDEN AGE LINE
 MODELS, LLC
WE MAKE OVER 900 STEAM ERA FREIGHT CAR KITS!
NEW KITS AVAILABLE. RESIN KITS, DECALS, DATA DISKS & DETAIL PARTS AVAILABLE.
westerfieldmodels.com

Great Decals!™
 FEC, Interstate, Virginian Railway, & L&N Titles
 After Hours Graphics Line
 Coupler Gages and More
 In O, S, HO, and N Scales

Premium Trees at Bargain Prices



Click NOW

only \$5.99

only \$7.99

-try- Coastmans Scenic Products



Hobby Marketplace Ads are Economical and Effective.

Click to learn more ...

clever models LLC

Cardstock models & Building materials



www.clevermodels.net

STREAMLINED BACKSHOP
Sales ... Services Solutions

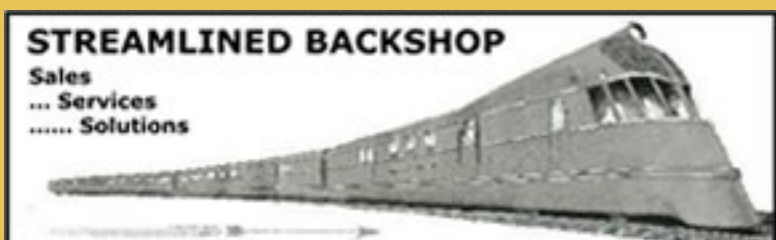

WHEEL AND AXLE WIPERS



www.SBS4DCC.com



Rail Design Services

Need a Track Plan?

[click HERE to learn more](#)

RULERS-of-the-WORLD

Scale Rulers \$4 each
Over **150** scales!
Metric or Imperial

www.rulers-of-the-world.com

Get your large text ad here in this space!

Ordinary text ads are limited to 100 characters, but if you'd like to do a double-text-ad, we'll give you 375 characters. (This ad here had right at 364 characters.)

If you have more you'd like to say, then a double-text-ad is a superb, very affordable way to say it. Place your double-text-ad with us today and start getting the word out to our audience of over 110,000 unique device views per month!

MRH dared to put THIS on video?



Watch the video now



Backdrop Junction

Your stop for Model Railroad Backdrops



click here to visit our website

backdropjunction.com

N, HO, O Scales • Custom Orders

Minimum space layouts

Design your layout to have the most fun in the least space

From the website by Carl Arendt and Gert Wierbos

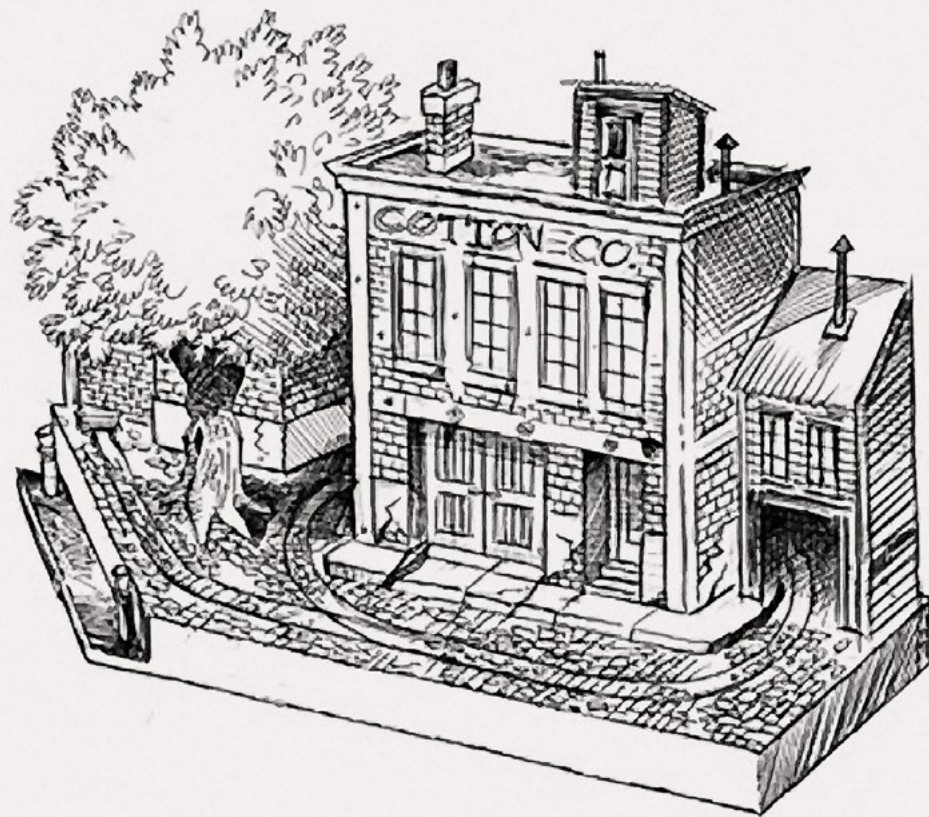

1: Dan Coker's "Savannah Waterfront" plan is G_n15 scale and measures 16" x 36".

Although U.S. model magazines tend to feature huge layouts that fill a basement or attic, many modelers simply don't have that kind of space available. Others lack the desire to make a very large commitment of time or cash.

The answer is to build one or more minimum space layouts. They're very small — typically four to six square feet in area — and use ingenious design tricks to pack a lot of railroading fun into that tiny space. Few materials or rolling stock are required, and the layout can be completed in a matter of weeks, rather than years.

The following notes provide some tips for designing and building this kind of railroad.

LAYOUT SHAPES

Because minimum space layouts are usually small enough to sit on a table or shelf, they generally have one of three shapes: round, rectangular/square, or free-form. ■

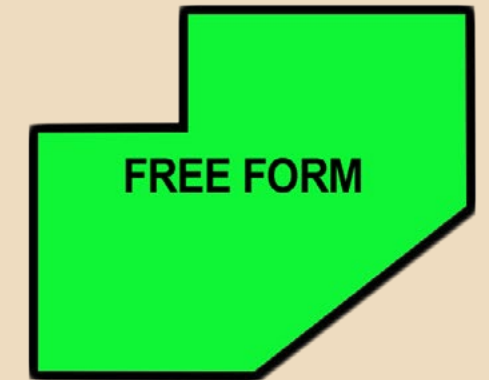

Layout schematics

Basically there are two types of minimum space layout schematics: **Continuous** and **End-to-end** (that is, point-to-point).

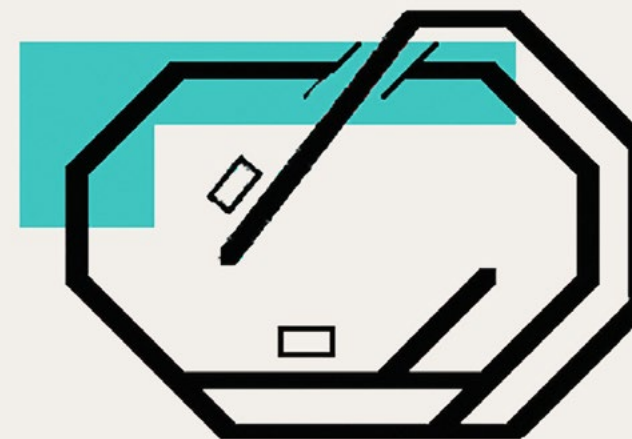

Continuous layouts allow you to sit back and watch the trains run around through your well-made scenery. By adding passing sidings, spurs and branch lines, as in this schematic, you can provide excellent railroad-like operations. For very small

layouts, the curves require quite sharp radii, so rolling stock needs to consist of small locomotives and short cars that can navigate such curves. Branch lines, narrow-gauge trains or trolleys (trams) are especially good choices for this type of layout.

Note that John Allen's original but quite small Gorre & Daphetid layout followed this kind of schematic, as did Frary and Hayden's pioneering Elk River layout in H_On30.

You can find John Allen's plan and the Elk River plan in Small Layout Scrapbook #4:

carendt.com/scrapbook/page4/index.html

A more comprehensive list of schematic arrangements for minimum space layouts are discussed in detail on the micro/small layout website:

carendt.com/scrapbook/page52/index.html



End-to-end layouts are mainly used for switching, rather than for continuous

running. This can be a very satisfying mode of operation, and a good switching problem can easily take nearly an hour to work through, even on a very small layout. These pikes are often placed on bookshelves or in out-of-the-way corners.

A good example of an end-to-end design is Chuck Yungkurth's well-known shelf layout, *Gum Stump & Snowshoe*, see:

carendt.com/small-layout-scrapbook/page-4-august-2002

and

carendt.com/small-layout-scrapbook/page-38a-june-2005-special-edition

In both these sample schematics, the turquoise-colored area represents hidden trackage, sometimes called a "fiddle yard," where trains can be secretly marshalled, stock rearranged, and locos swapped in order to keep traffic moving on the visible part of the layout.

This is the "backstage" area of the layout, and it's one of the tricks we use to achieve railroadlike operation in these small designs. The hidden trackage represents the "rest of the world" in minimum space layouts.

EXAMPLE LAYOUTS

There's something about the challenge of shoehorning a working railroad into an "impossibly" tiny space that brings out extreme creativity in model layout designers. Here are some examples of minimum space layouts in each of the most popular modeling scales currently used in the U.S. They should provide you with information, inspiration, and a lot of fun! ■

N Scale (9mm gauge)



2: Probably the most popular minimum-space plan in the world is the "pizza" layout — a small circle of track amid carefully crafted scenic surroundings, often looking as though it could be delivered in a pizza box. This N-scale example, by John Lucas, is scenicked to represent the clay cliffs along the bayshore near Pensacola, FL. It's 24 inches square.



3: Focusing more on operation is Bob Hughes' San Vince de Rey, an industrial switching yard measuring just 18x6 inches (excluding fiddle yard). The spurs duck under an overbridge at the right and are connected to a movable cassette backstage, allowing the engine to serve all the tracks just as if there were a switch ladder back there. Bob uses the layout to play Inglenook switching games (see the [Shunting Puzzles](http://ShuntingPuzzles.com) website for more information).

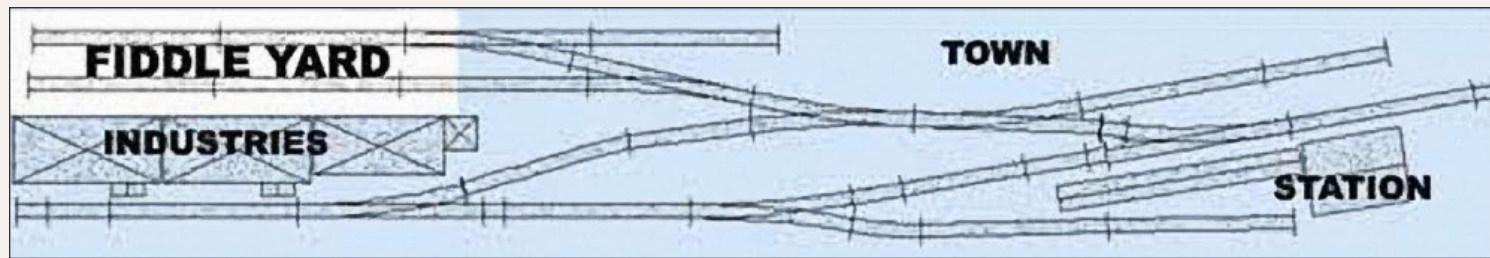

Fiddle yards

Fiddle yards are the most important ingredient of minimum space layouts. They convert our small model scenes into working railways by representing the “rest of the world” beyond the boundaries of the layout. Trains enter the visible part of the model and leave it, bound for distant places — but they actually move to and from the fiddle yard, where cars, locos and even whole trains can be swapped out, rearranged and generally juggled by hand, to get ready for their next entrance.

The most basic fiddle yard is just a couple of hidden tracks where a backstage operator can work on the trains. In this simple example the fiddle yard is hidden behind a row of industrial buildings. Trains make their entrance in the middle of the modeled scene (a good space-saving trick) and proceed to the town and station at the right. They exit by disappearing behind the industrial buildings, into the yard.

There are several ingenious design methods for persuading a fiddle yard to furnish more operation in less space (and often with less handling required). Here are the three most commonly used fiddle yard designs.

A sector plate (or swing table) is a length of track that is piv-

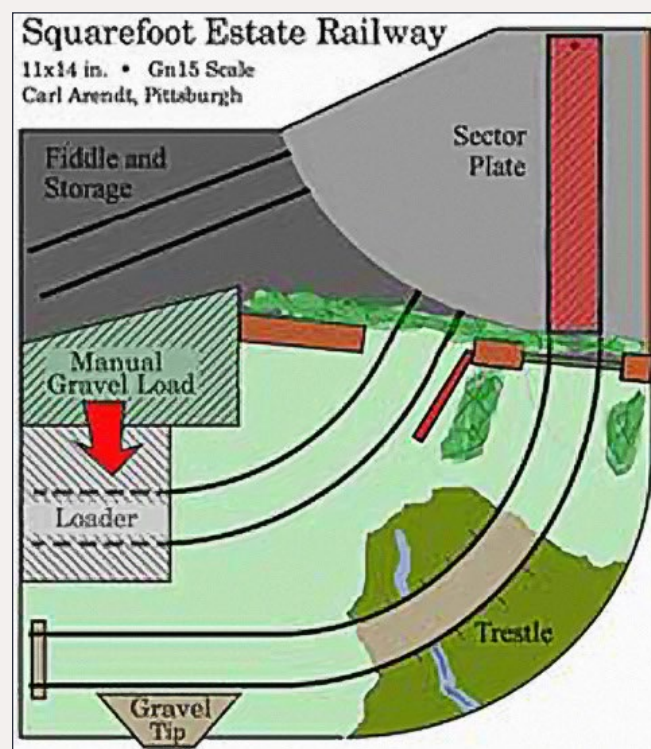

oted near one end, so it can switch from one approach track to another, in a much smaller space than turnouts would need. In this well-known plan, the sector plate is used to make possible a G scale, 15-inch gauge layout in one square foot of area!

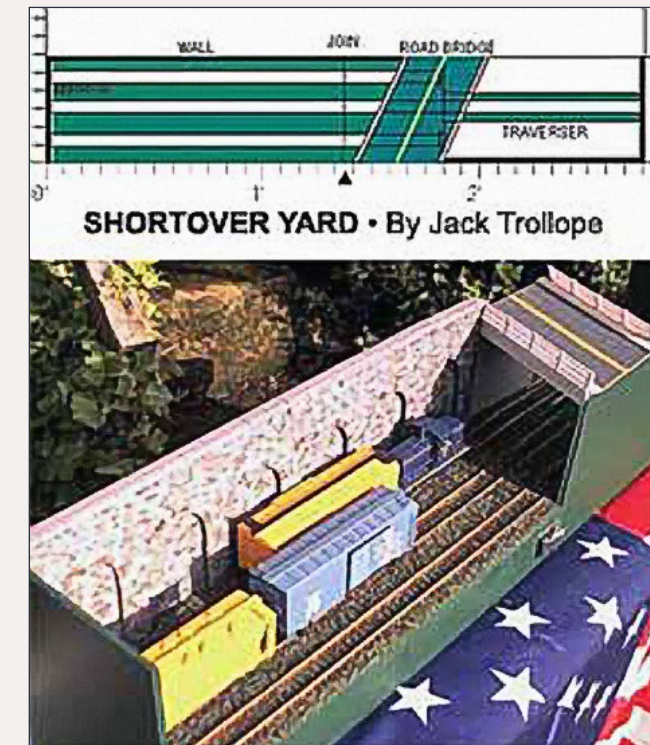

The transfer table (traverser in Britain) is a track or tracks on a bridge that slides from side to side to move between approach tracks.

Shortover Yard uses a transfer table to eliminate a ladder of switches and successfully model a busy HO switching yard in just 33 by 6 inches.

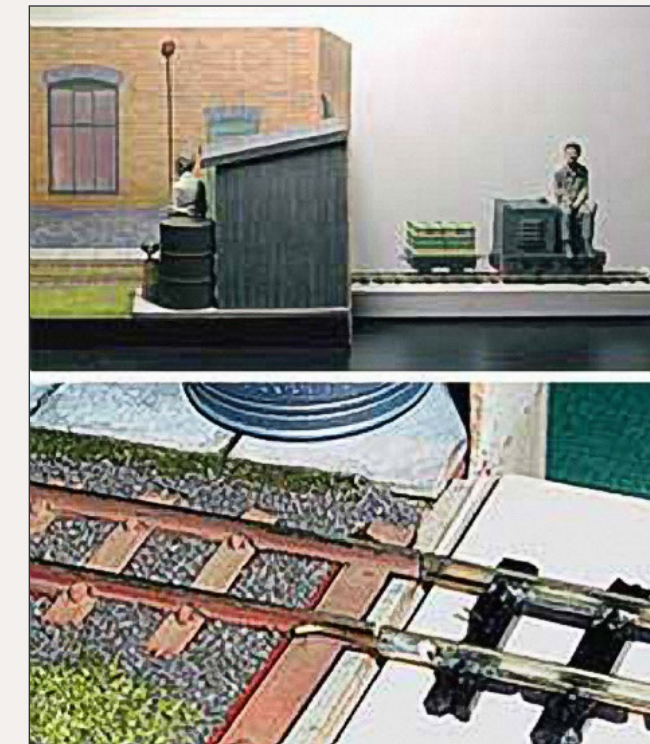

A cassette is a length of track mounted on a movable base with a small spring wire soldered at the end of each rail to transfer electricity. Clip it onto any track at the edge of the visible layout.

Steve Bennett uses several cassettes to swap, reverse, and rearrange stock on his tiny 12 by 4 inches G9 industrial pike.

Lack of space need not stop you from having a layout!

[▶ Reader Feedback \(click here\) !\[\]\(4b360517d997d21382fb5a1f2f13508f_img.jpg\)](#)

MORE EXAMPLE LAYOUTS

HO Scale (16.5mm gauge)

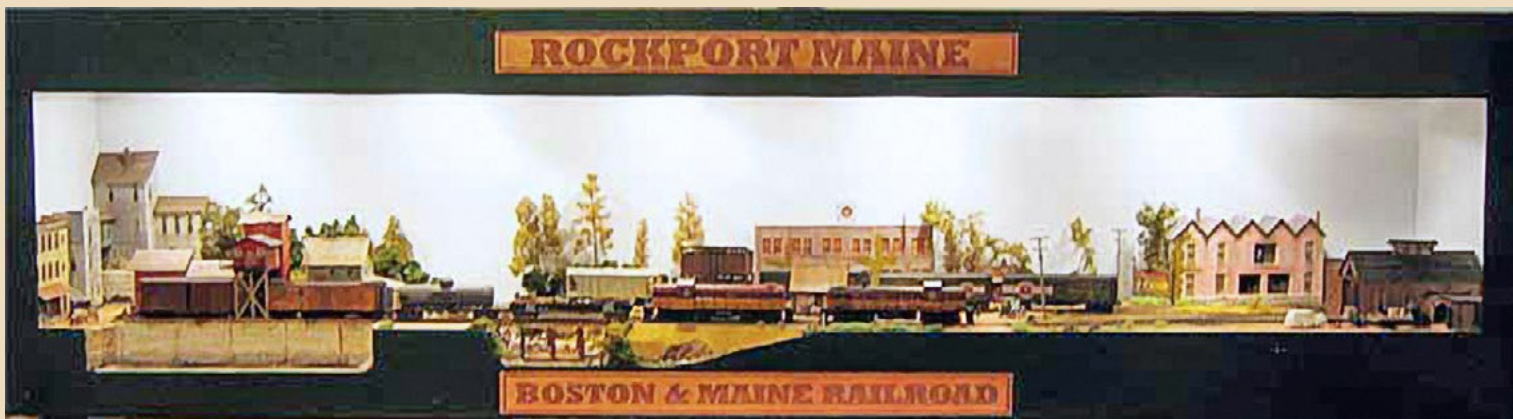

Inspired by an Iain Rice design in *Model Railroad Planning 2003*, John Peckham's 1x6-foot Rockport Maine features a "picture frame" to set off the layout and direct the audience's attention. John operates with a card order car-routing system that makes good use of the hidden dropleaf fiddle yard to the left of the layout. He also uses ambient sound, with ocean and countryside noises coming from four speakers hidden behind the upper valence.

Sn2 Scale (9mm gauge)

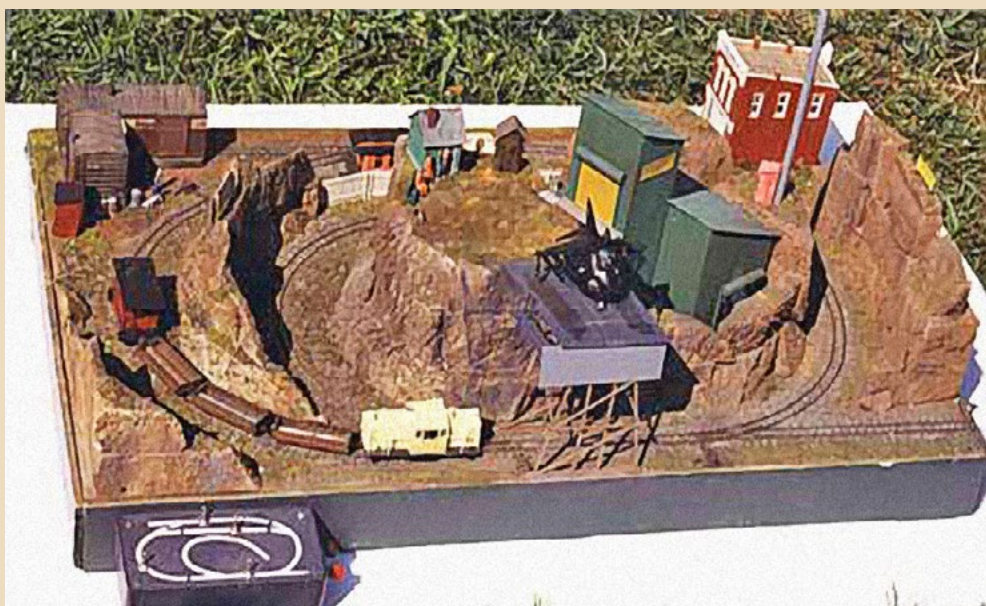

Russ Haigh built The Cavorite Tram, a 20x30" narrow-gauge railway, sometime around 1995. It's built on three layers of Foamcore board glued to a frame of 2" thick pink insulating foam.

The little 1:64 tram serves a mine for cavorite, a mineral invented by H.G. Wells that has the uncanny ability to fall upwards. Wells used it to power a flight to the moon. Russ's pike includes

an appropriate mountaintop airport for cavorite-powered planes, complete with an office and an outhouse that is guyed down to avoid being blown over by departing flights. Cavorite can be shipped out either by rail or by air.

O Scale (1.25" gauge)

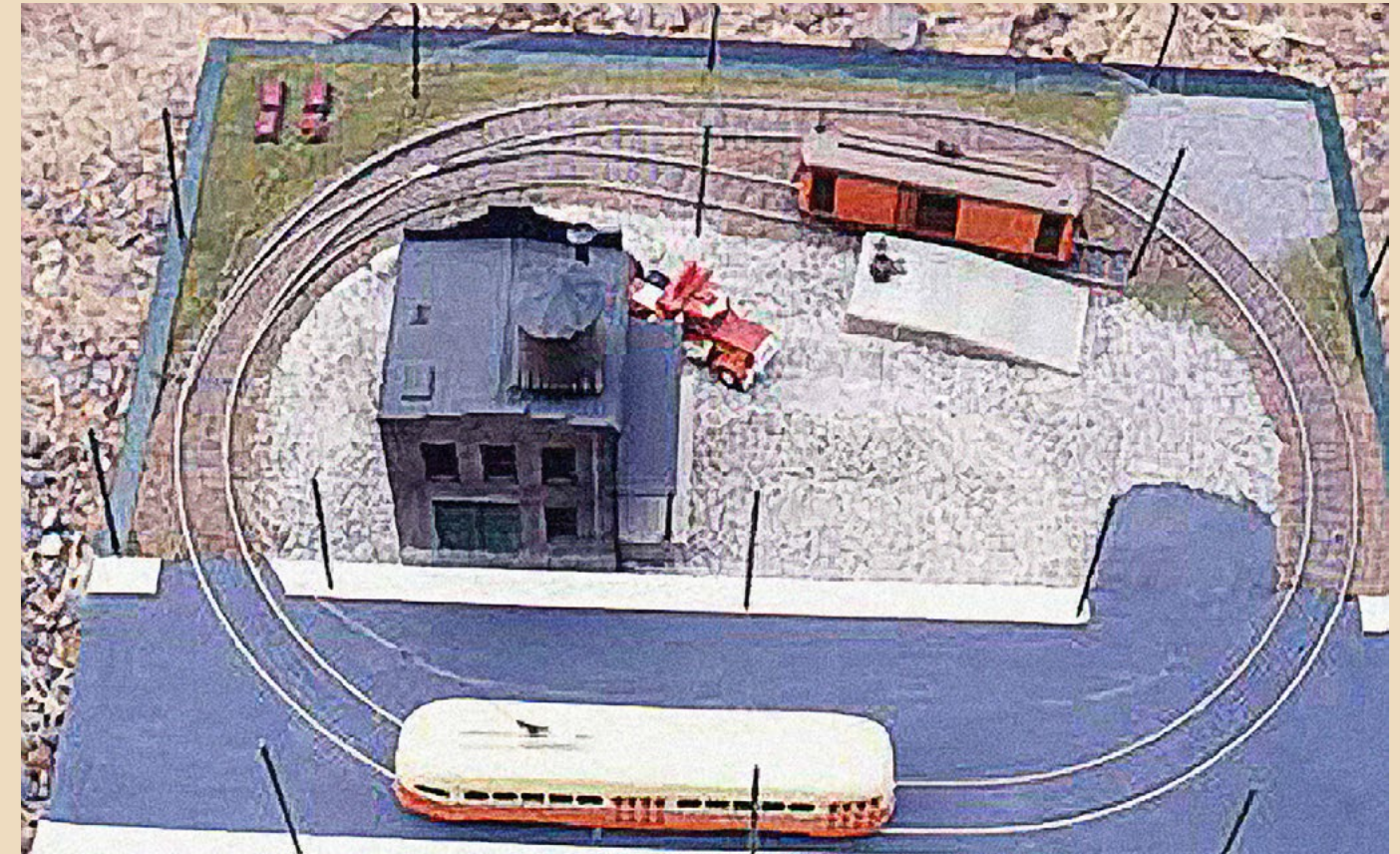

Dick Bell built this tiny 36x28" O scale railroad, the Delaware Valley Traction Company, almost 30 years ago. The small layout features private right-of-way, street trackage, working overhead wire, and a curved turnout leading to a spur that serves as a team track.

"I originally built the layout to learn the various skills needed to build a working trolley layout," Dick comments. "Today, I use the layout as a photo prop (the scenery can be varied by changing out the buildings), as a loop to test run and work out the bugs in new cars, and most of all for fun. It has survived the construction and subsequent destruction of two large trolley layouts. I call it my 'first and lasting' trolley layout."

You can find still more example layouts at carendt.com. ■

Modeling an **AGWAY FEED MILL**

 **Reader
Feedback**
(click here) 



1. The completed
Agway model.

Scratchbuilding a modern day feed mill ...

– by **Neil R. Schofield**

Photos by the author

Mentioning the words “Connecticut River” to most New Englanders will conjure up images of a mighty yet tranquil river surrounded by vast farmlands and gently rolling hills. Mentioning those same two words to a railfan can conjure up something even more inspiring – vast farmlands, gently rolling hills, and beautiful scenery for rail photography along the Connecticut River Line, or Conn River as

it’s affectionately known. From its confluence with the Long Island Sound to the Green Mountains of Vermont, the Conn River remains one of the most photogenic stretches of

2. South side of Bernardston Mill showing car unloading shed with two covered hoppers. Photo circa 1991, courtesy of Bill Feindel.



3. East side of Bernardston mill. Photo circa 1991, courtesy of Bill Feindel.

railroad in New England. For over 150 years paper mills used the Connecticut River and its tributaries to provide an abundant water source for the paper making process, while feed mills sprung up along the line providing feed and fertilizer for the fertile farmlands up and down the Connecticut River Valley. Up until the 1980s, both the Central Vermont and the Boston and Maine railroads enjoyed a healthy source of traffic, primarily from paper and agriculture industries. Unfortunately, the last quarter century has not been kind to the paper industry. Many mills located in northern New England that once generated solid strings of boxcar traffic have shipped their last rolls of paper, leaving the agricultural industry to provide a meager amount of traffic to the remaining regional railroads in the

area. Fortunately, numerous feed mills still exist, and one such mill that still sees frequent service is the former Agway Mill in Bernardston, MA, along the ex- Boston & Maine Conn River Line.

The Bernardston mill [1-4] was originally built in 1980 by Agway, a name synonymous with agricultural products. Like many of the once-common agricultural names in this region, the mill has changed hands and now goes by the name Feed Commodities, but one look at the mill's faded white paint and rusted feed bin, and the Agway ancestry is clearly evident. Today as it did back in 1980, the facility receives inbound loads of feed and fertilizer by rail that are unloaded in the

car unloading shed and stored in the silos before being blended and distributed by trucks to local farms in northern Massachusetts and southern Vermont.

Main structure

Modeling this mill was more challenging than I initially anticipated, but ultimately the effort resulted in a unique model that certainly captures the look of the

4. South Side of Bernardston Mill Photo circa 1991, courtesy of Bill Feindel.

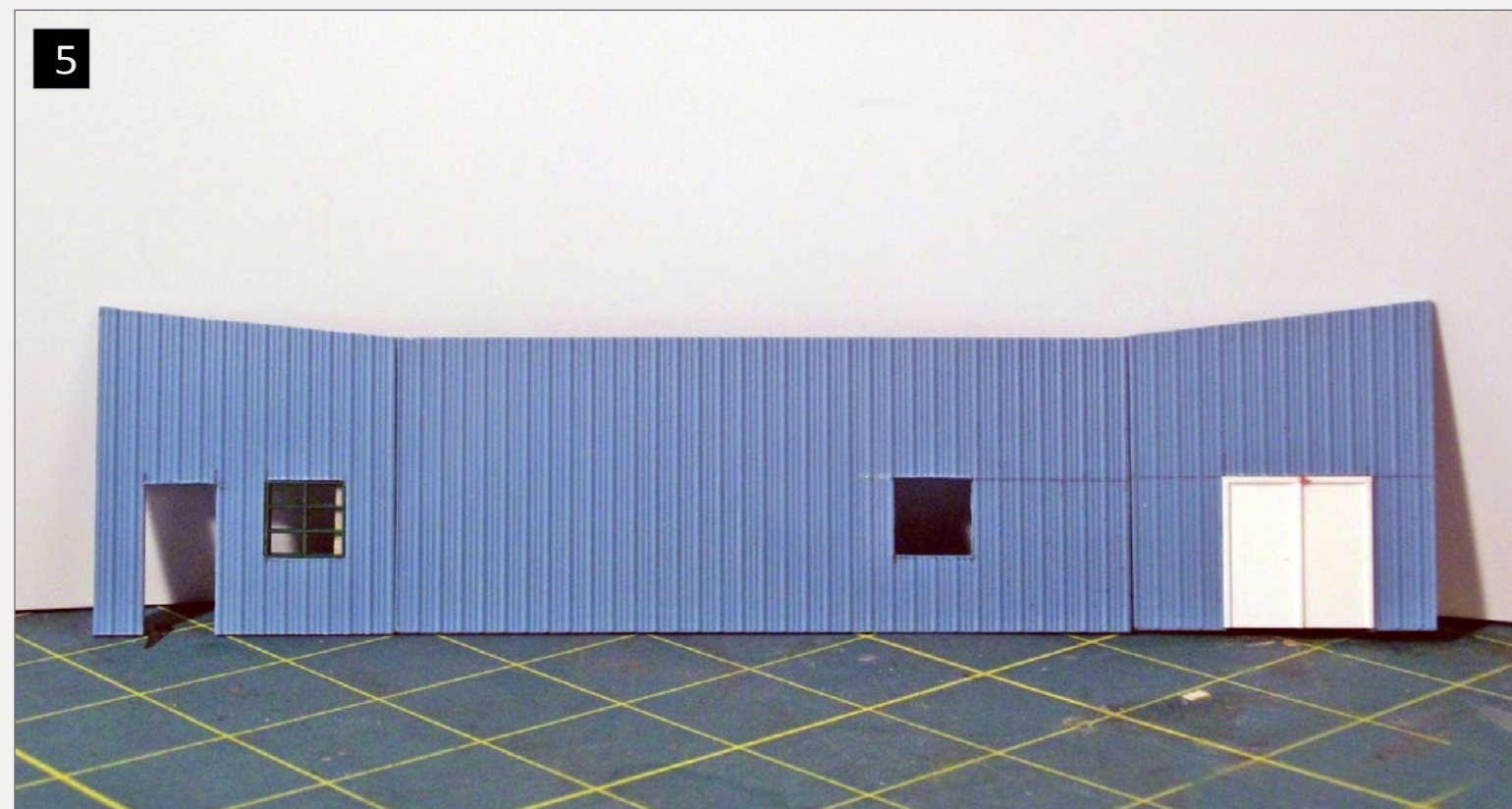

5. Office addition located on east wall showing three sides taped together.

prototype. Capturing this look meant doing a convincing job with the main structure, the feed storage bin, and truck loading building. Also, the Agway logo and red/black striping set against the white building was common to the Agway Mills. Achieving this however, did require a significant amount of scratchbuilding.

The basic components of the structure were built using Pikestuff roofing material assembled with Testors Model Master Cement. Model dimensions were scaled using measurements I took of the prototype in August 2012. To simplify construction, each wall of the structure was built individually using the base dimensions I took in August. The overall building height was estimated by comparing door heights to the structure height. While not 100% accurate, my ultimate goal was more about capturing the look of the prototype than building a completely accurate model. Doing so would have

taken considerable more effort and quite a bit more real estate than I had available.

Once the walls were assembled, I used masking tape to temporarily fit the building together. This is useful for determining how the proportions of the model compared to the prototype (based on my measurements). This proved useful, since I needed to make few changes to the height and walls based on the partially assembled model. Once the changes were made, I assembled each wall and measured window and door locations. Alternately, I could have taken the time to draw scale mockups of the walls

6

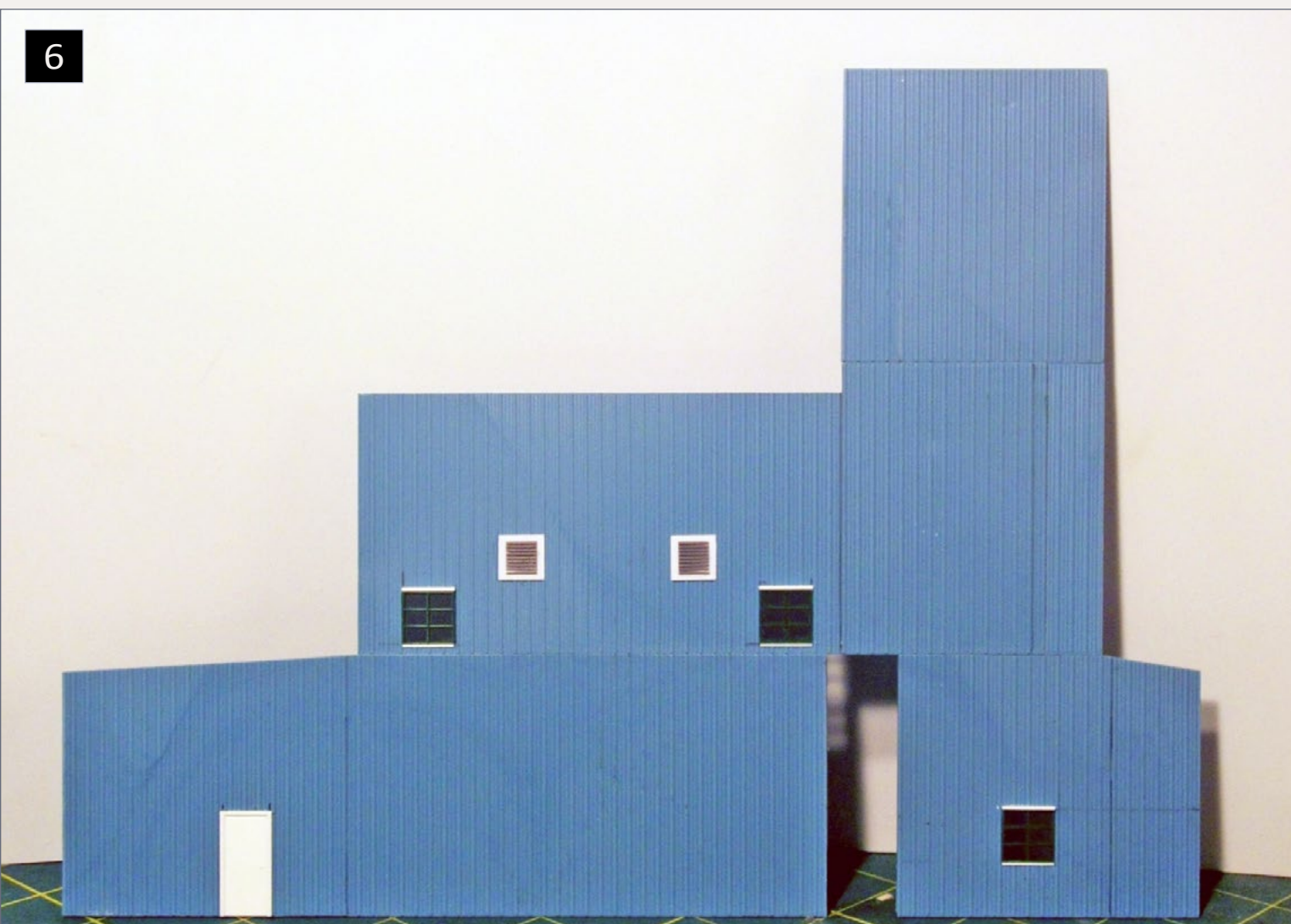

6. East wall of main structure showing windows, vents, and door installed. Missing wall section will be filled in later.

7



7. Completed office addition ready to install on the east wall.

in plan illustrations 1-4 (see spread 8 of this article). This would remove some of the guesswork during construction.

Unfortunately, as with most of my buildings, I'm somewhat impatient, so I jumped right into construction of the model, but these illustrations should certainly help those wishing to build their own Agway mill, removing some of the guesswork. However, I should mention, these illustrations represent the dimensions of the model, not the actual prototype

The doors of the main structure were readily available from Pikestuff. The windows were a bit of a challenge because there were no commercially available windows that met the rough dimensions and mullion size of the prototype. The solution involved scouring one of my many scrap boxes from past structure kits. Buried in one of the boxes I came across the Pikestuff

8

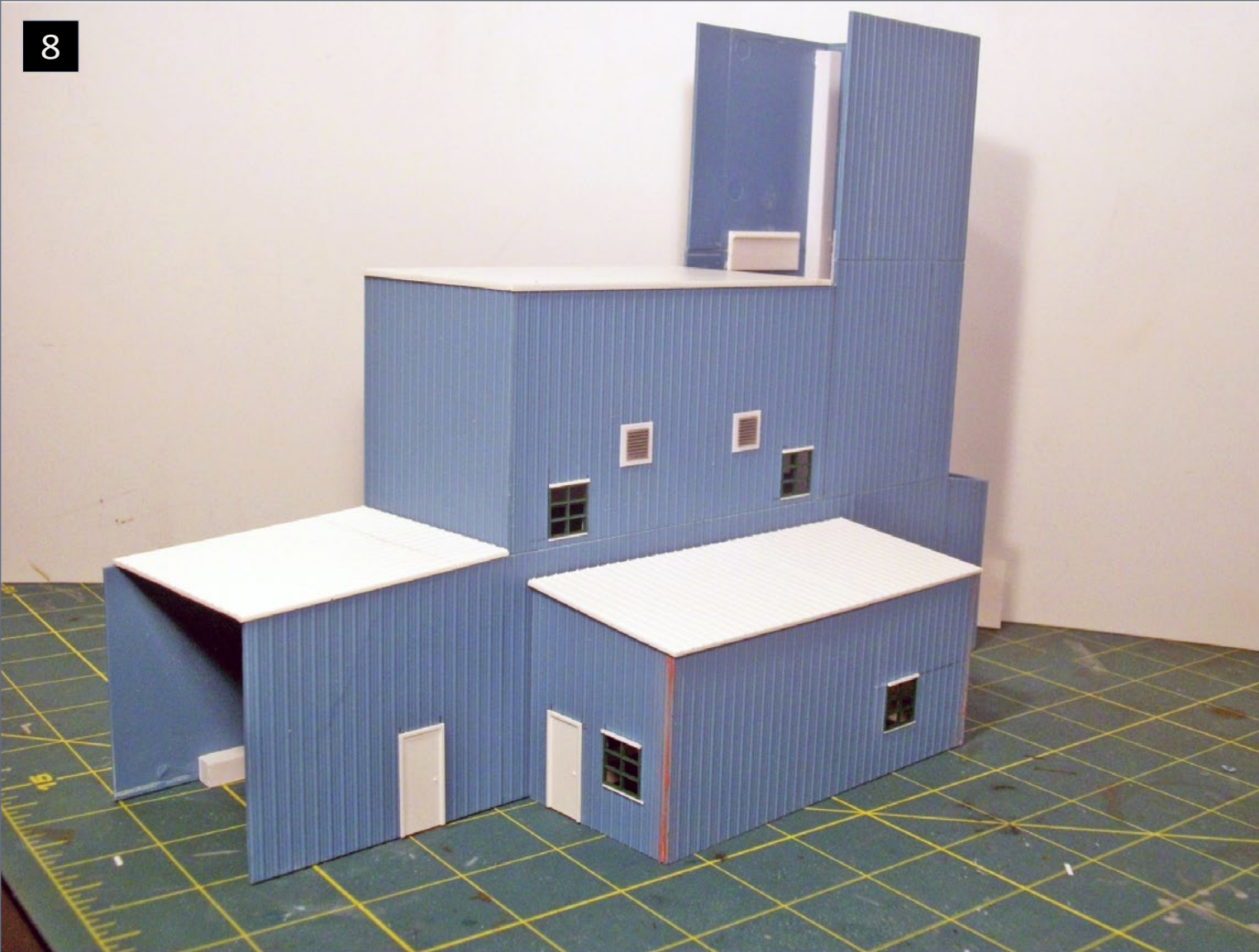

8. Assembled main structure including office addition, viewed from the south.

Machine Shop/Service Garage. The windows included in the kit seemed to have the same general shape and with a little bit of trimming I was able to create the correct mullion arrangement [11-12].

After completing the door and windows, I made vents located on the main structure walls from some Cannon & Company Radiator Screens (part 141-1401). The vents were modified by sanding them down to an approximate thickness of .030" and gluing two of them to the east side wall and one to the north side wall. Completing the main structure included personnel railings along the roof and ladders with platforms on the outside of the building, but due to their fragile nature and added

9

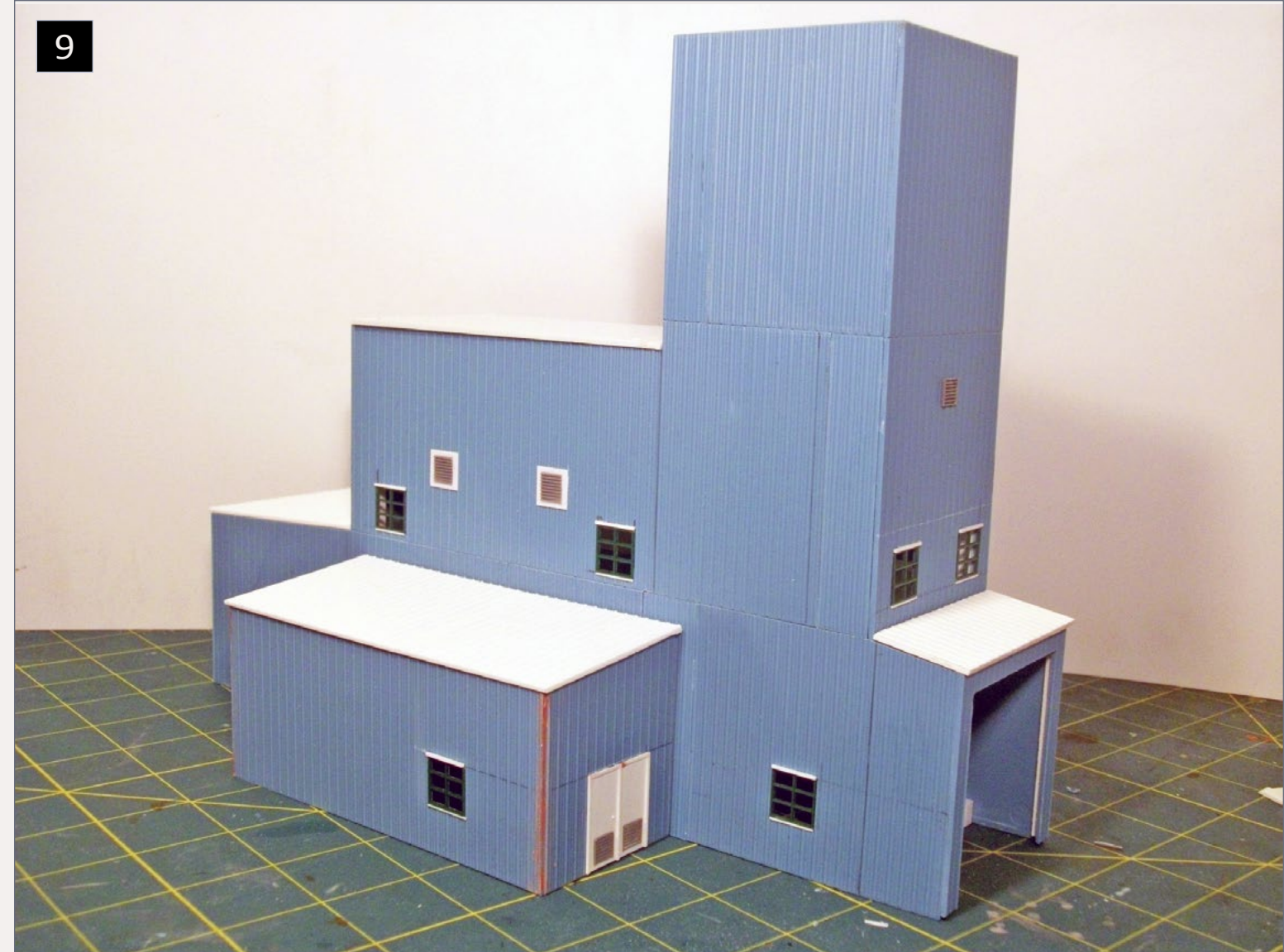

9. Assembled main structure including office addition, viewed from the north.

handling required, I held off adding the Tichy railings and ladders until the elevator and silos were completed. Once the walls were built and window openings cut, I assembled each wall with Evergreen .250" x .250" styrene at each corner for bracing.

Feed bin

The Feed Bin was the most difficult part of the structure construction, my delaying tactics before construction involved thoroughly researching photographs for suitable scratchbuilding supplies to achieve the desired look. As the prototype photos illustrate Bernardston Mill [4], the bin is constructed of

10

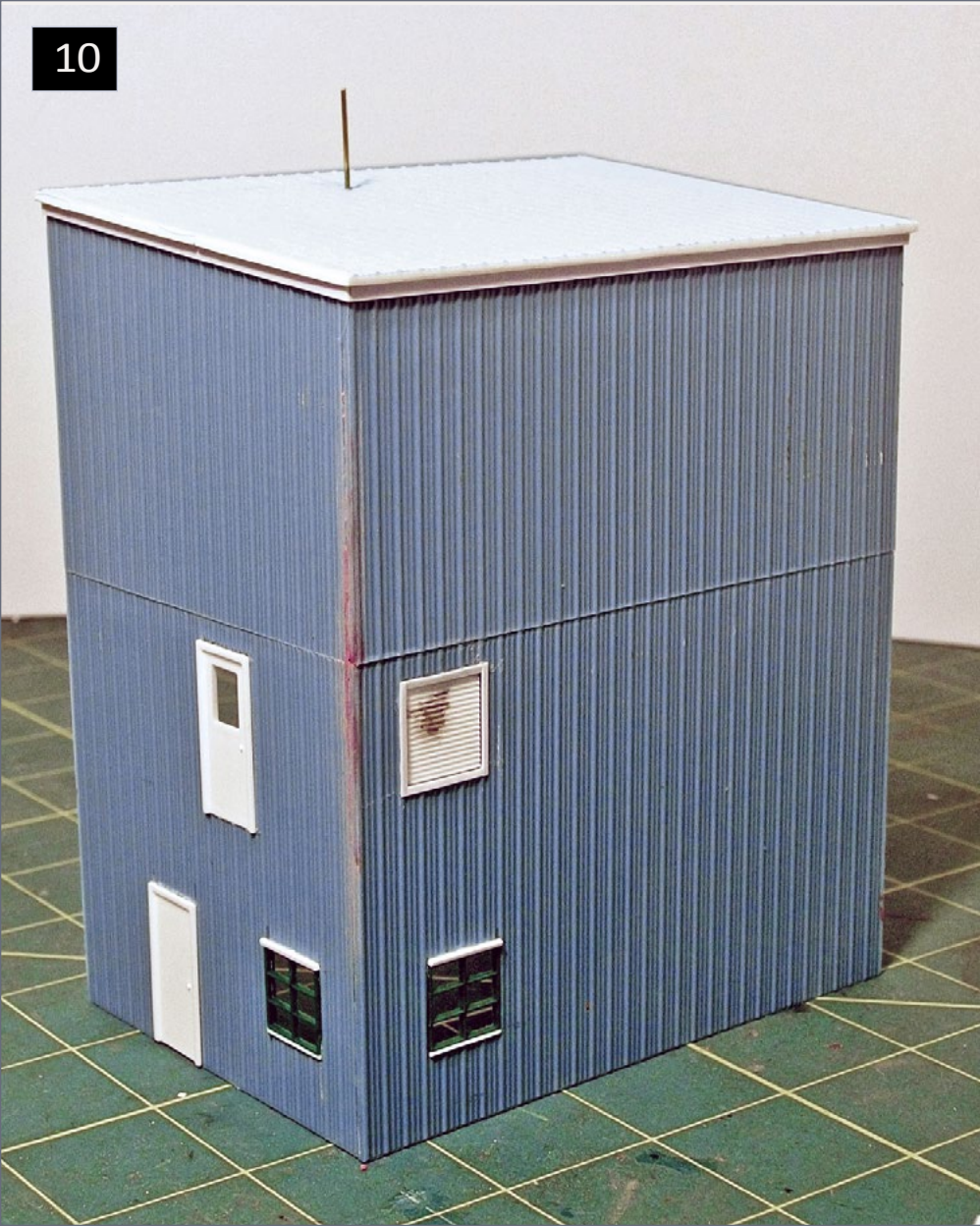

10. Assembled rear portion of main structure.

11. This photo shows the stock Pikestuff window included with the Machine Shop/ Garage and where to modify the window.

12. This photo shows the modified Pikestuff window created by cutting out the outside mullions to match those of the prototype.

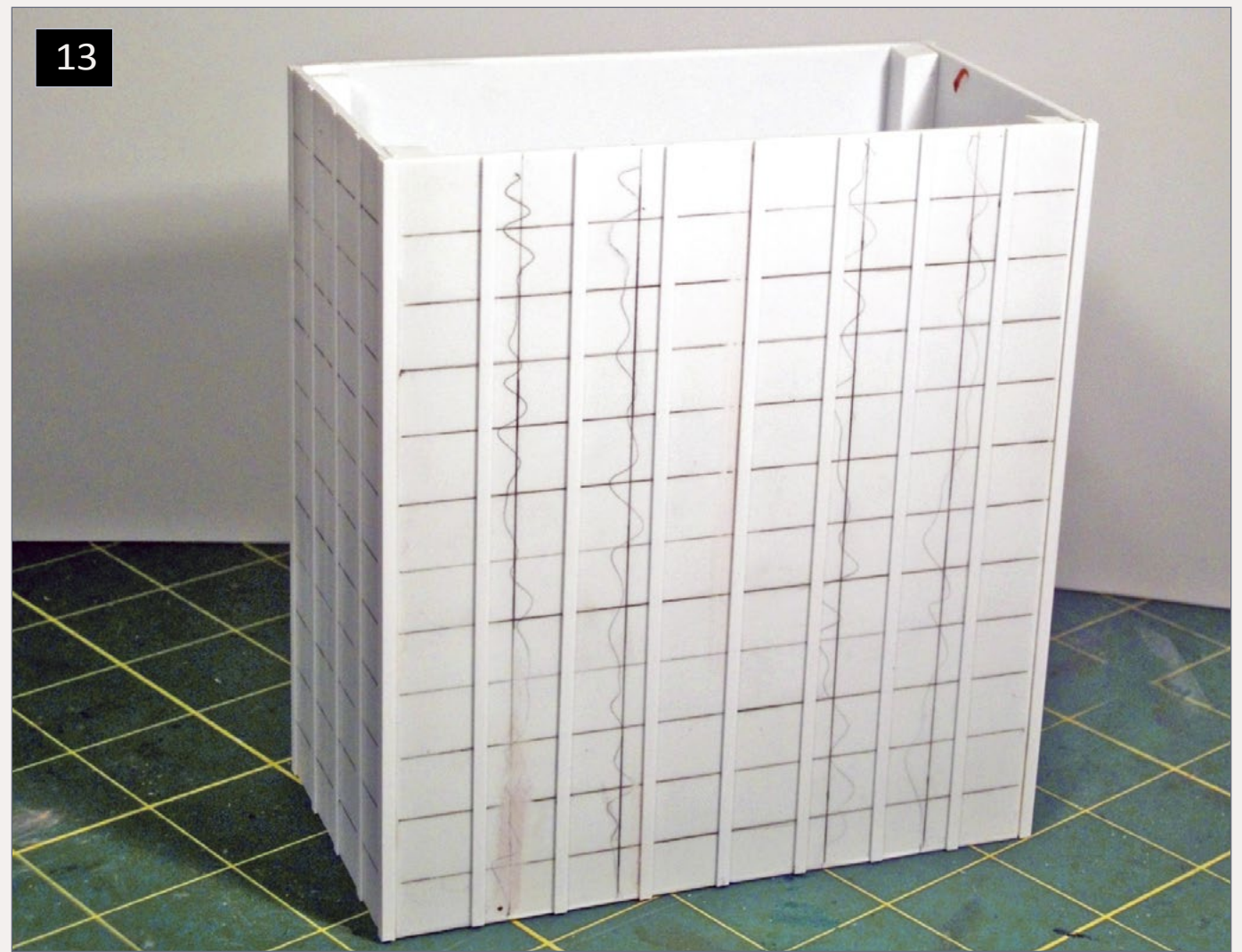

13. Partially assembled feed bin with vertical bracing.

steel siding with cross bracing between each vertical brace. To complicate things further, the vertical braces were riveted, and the top portion of each cross brace was sloped, presumably to prevent rain from accumulating on the outside framing of the structure.

While this may have made sense on the prototype, modeling the slope of each cross brace was a bit overwhelming at first, since the idea of cutting and filing each piece seemed more effort than it was worth. Ultimately, a relatively simple solution presented itself. First, the vertical bracing (.060" x .020" strip) was measured so that each vertical piece was uniformly spaced as in Illustrations 2-4. Next, using .020" thick sheets with .060" V-Groove siding cut to the correct width, I cut cross bracing

11

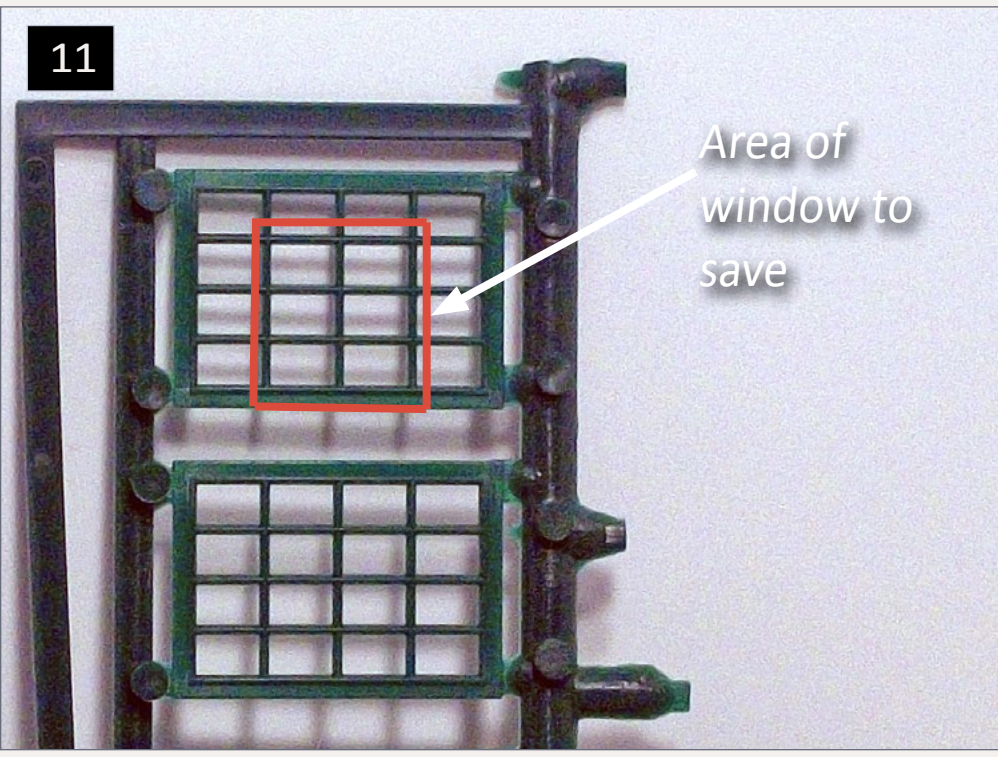

12



using a single-edge razor blade, cutting each cross brace at an angle to represent the slope [14-15].

While tedious, I found the exercise of cutting the pieces slightly more entertaining than my wife's latest TV vampire series which gave me the benefit of quality family time and modeling time. After about two weeks spending about an hour a night in front of the TV, I finished all four sides of the bin construction. For those wishing to simplify the bin construction, the horizontal bracing could be installed without the angled surface. This wouldn't affect the look of the building too much, but it was important to me to capture this feature.

The final detail was the rivets extending the height of the vertical braces. Recreating this was critical since I intended to duplicate the prototype's rust weathering on the completed model, which would surely highlight this detail. The strips were

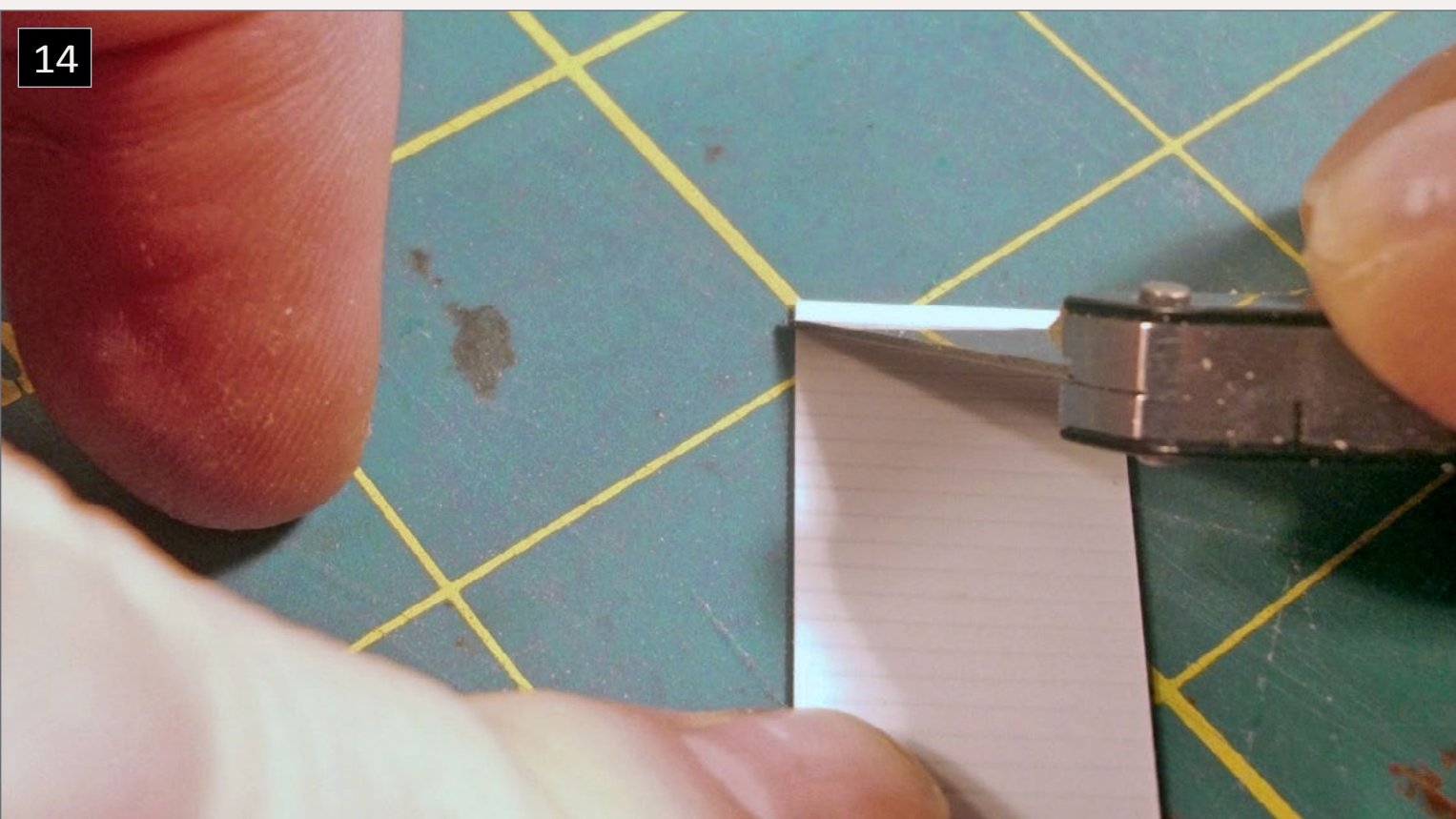

14. Photo showing how to cut the strip styrene for the horizontal bracing on the feed bin.



15. In-progress photo showing the partially assembled feed bin and horizontal bracing being applied.

created using a pounce wheel along the edge of a .005" sheet of styrene. Once the rivets were embossed into the styrene, a straightedge was used to cut the styrene into strips .060" wide. Each strip was then laid onto the vertical bracing using Model Master Liquid Cement. This cement works well with styrene, giving plenty of time to adjust and straighten the strips once applied, but providing a secure welded seam between the styrene pieces. Once the rivet strips were applied, I added Tichy safety cages and walkway platforms per the photos, and completed the roof installation with Tichy railings. [16 and 17].

Silo base

The next portion of the building to tackle was the silo base. I studied the prototype photos for several days to engineer

ILLUSTRATION 1 SOUTH ELEVATION

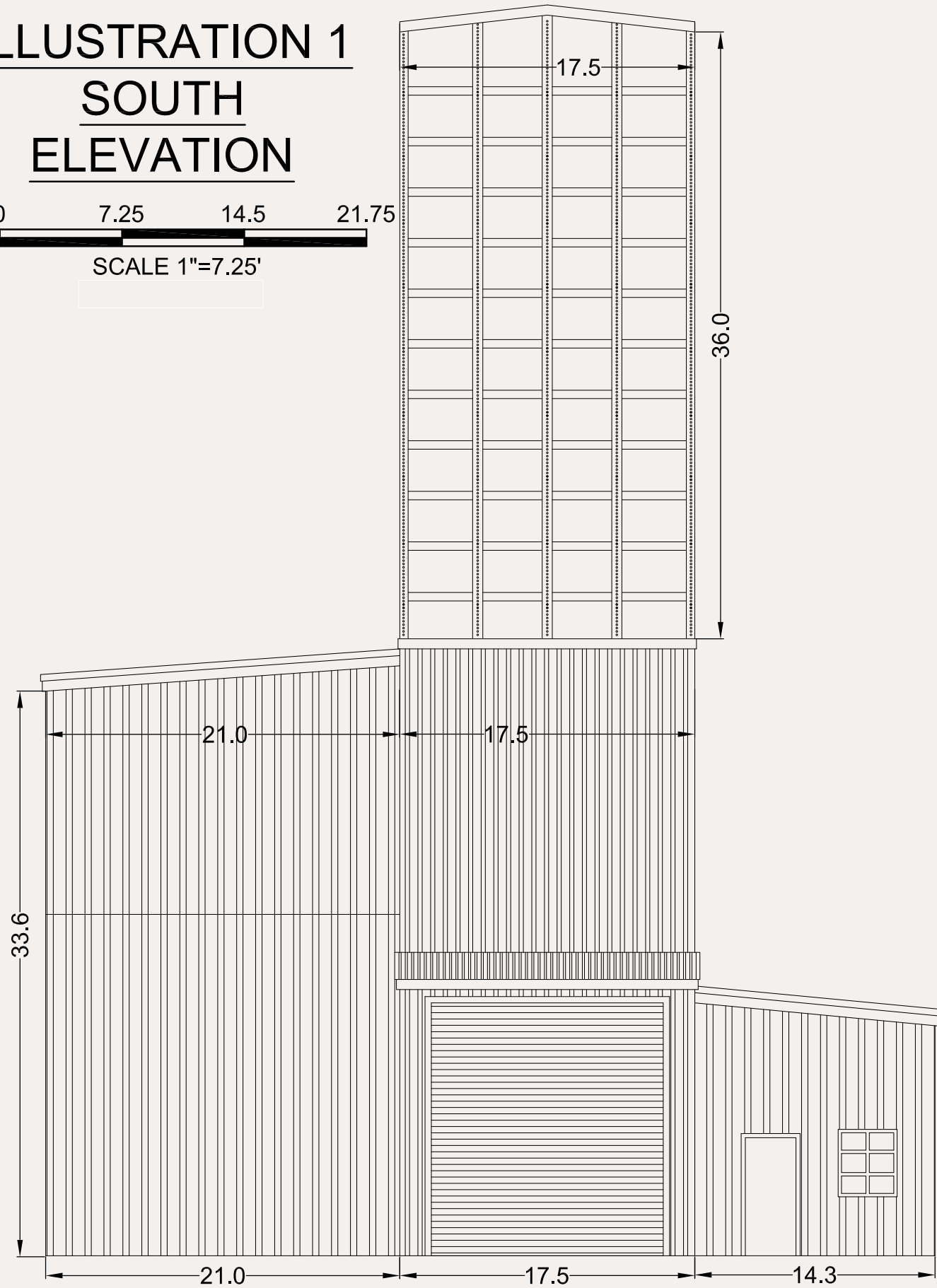
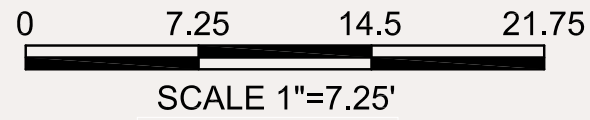
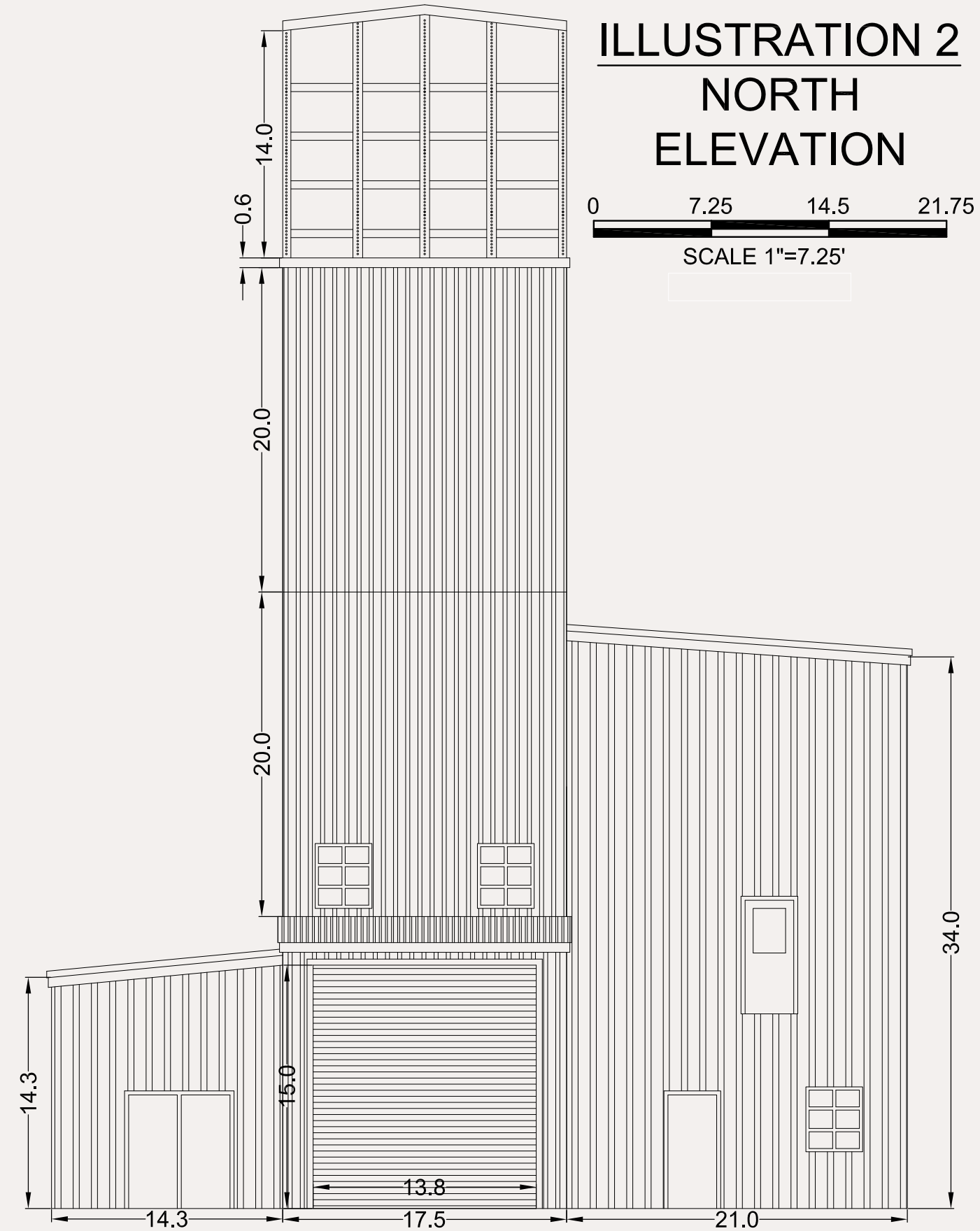
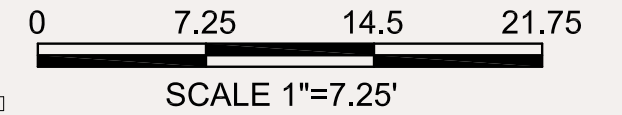
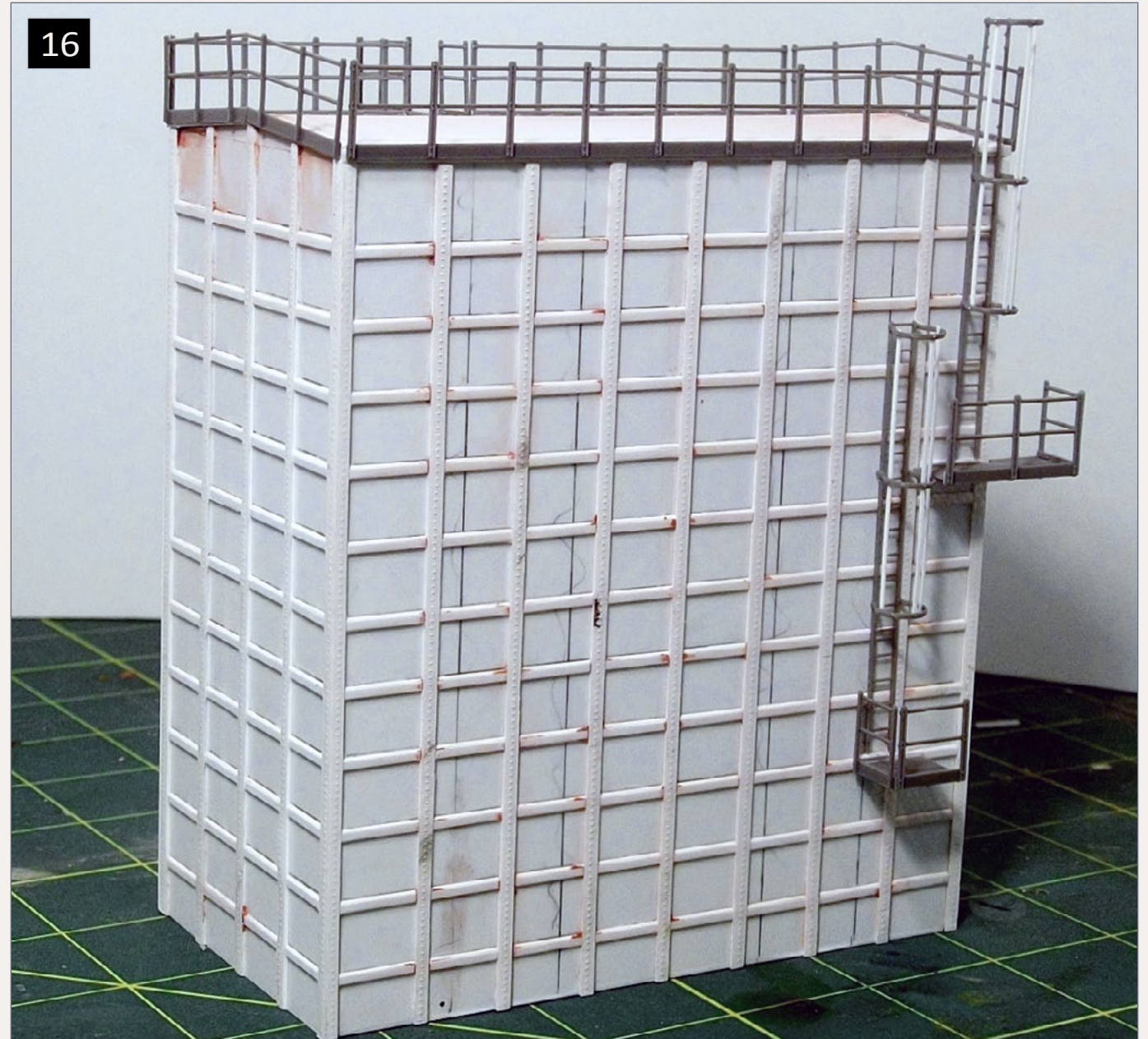
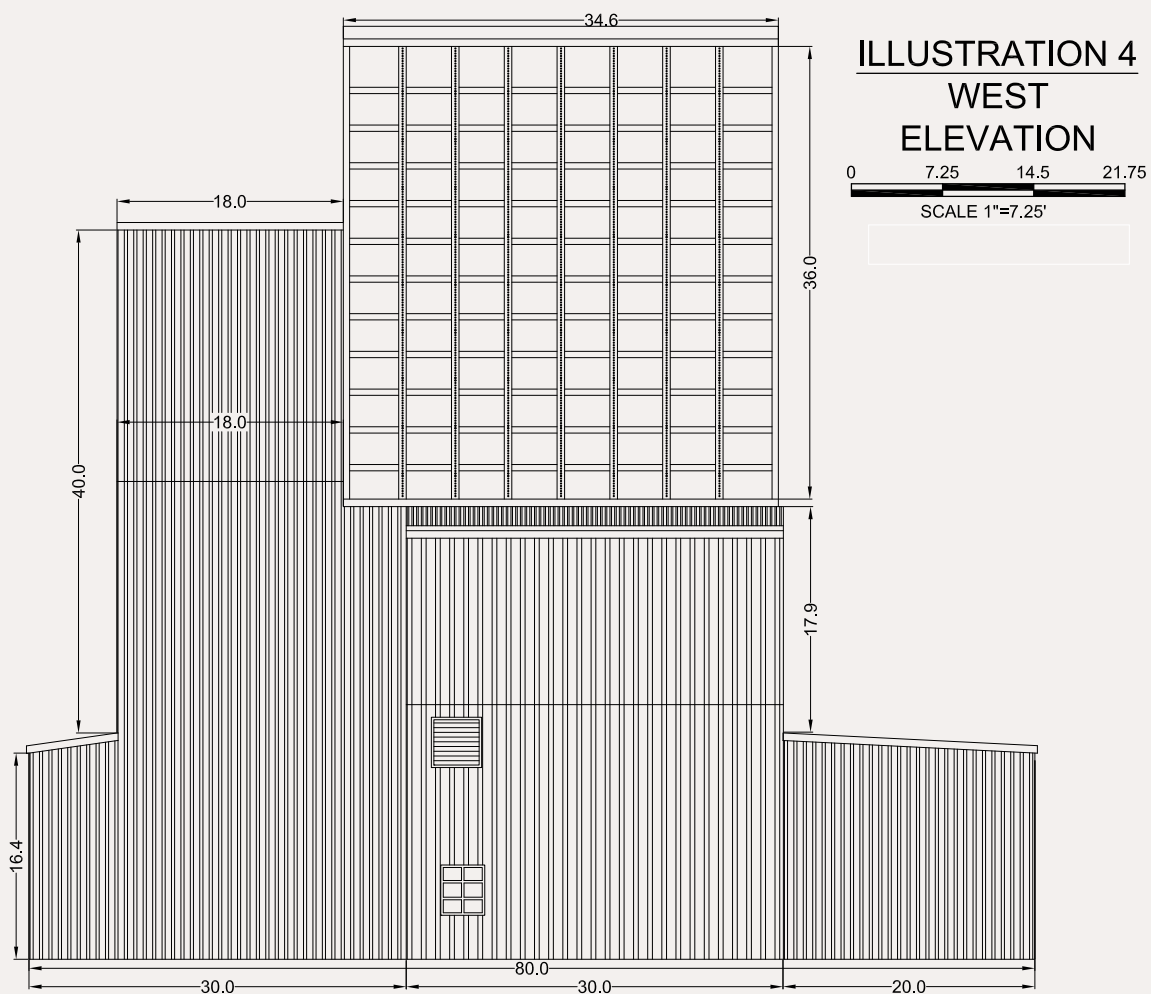
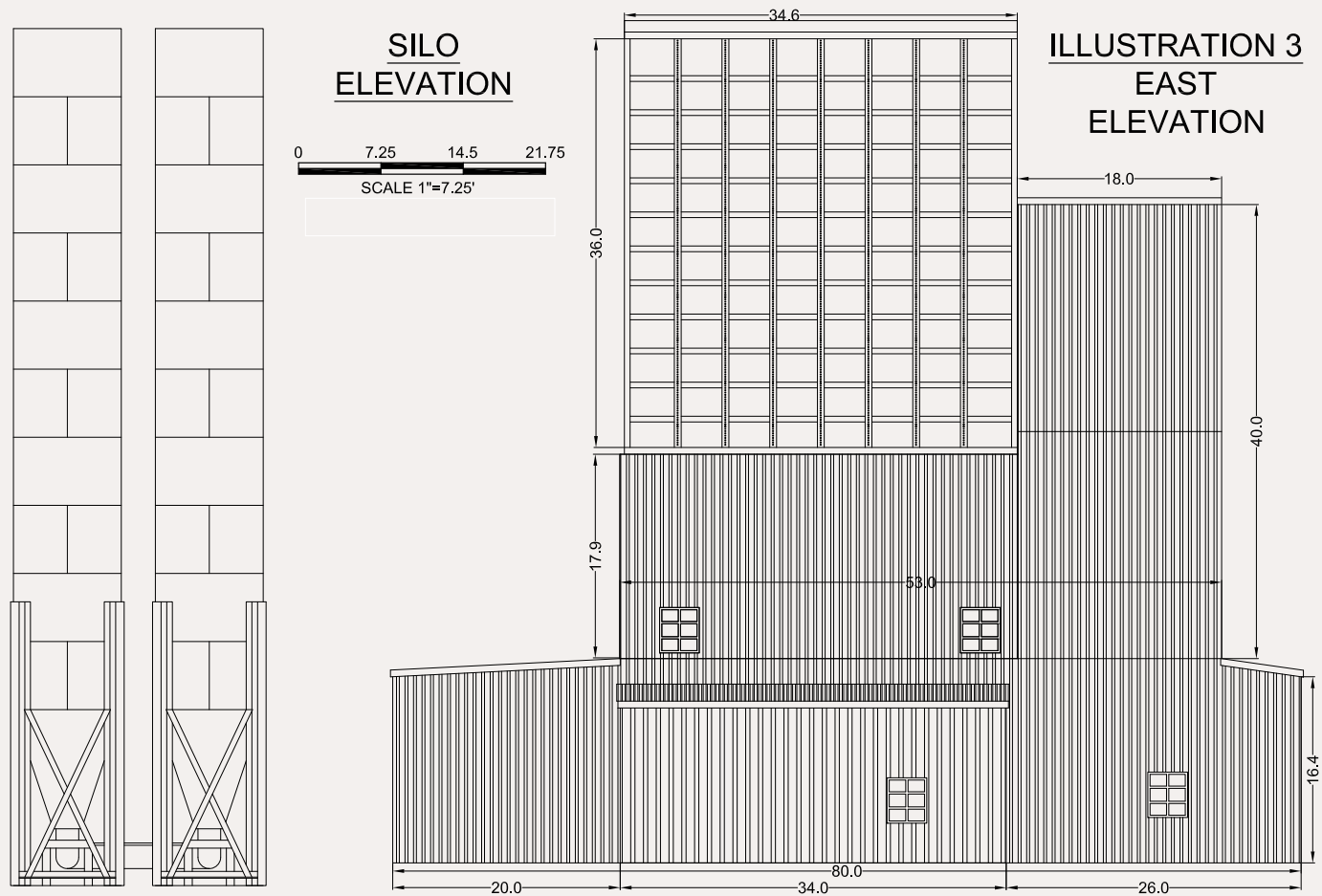

ILLUSTRATION 2 NORTH ELEVATION





16. Completed feed bin with ladders, walkways, and railings ready to add to the main structure.

the easiest way to get the silos correctly laid out and sturdy enough to survive a few bumps from operator's hands. The prototype Bernardston mill had several variations of feed silos, but to make this project a little less challenging I settled on 10 silos all of the same size along with one large bulk silo at the end. This made building the base easier, since the ten silos were supported by four evenly spaced Evergreen .156" H-columns. Once I determined the silo diameters (one-inch PVC pipe), I laid out a grid with the silo centers on a piece of



17. View of the completed main structure with feed bin attached and elevator installed.

.060" styrene and measured the corners of each silo base for the column supports [18, 19, and 20].

Silos

Each of the ten silos was constructed of one-inch PVC pipe wrapped with .010" scribed styrene. PVC pipe was chosen since it's relatively inexpensive, and styrene wrapping makes weld seams easy to replicate [21, 22, and 23]. I started by gently scribing a .010" styrene sheet with the horizontal weld

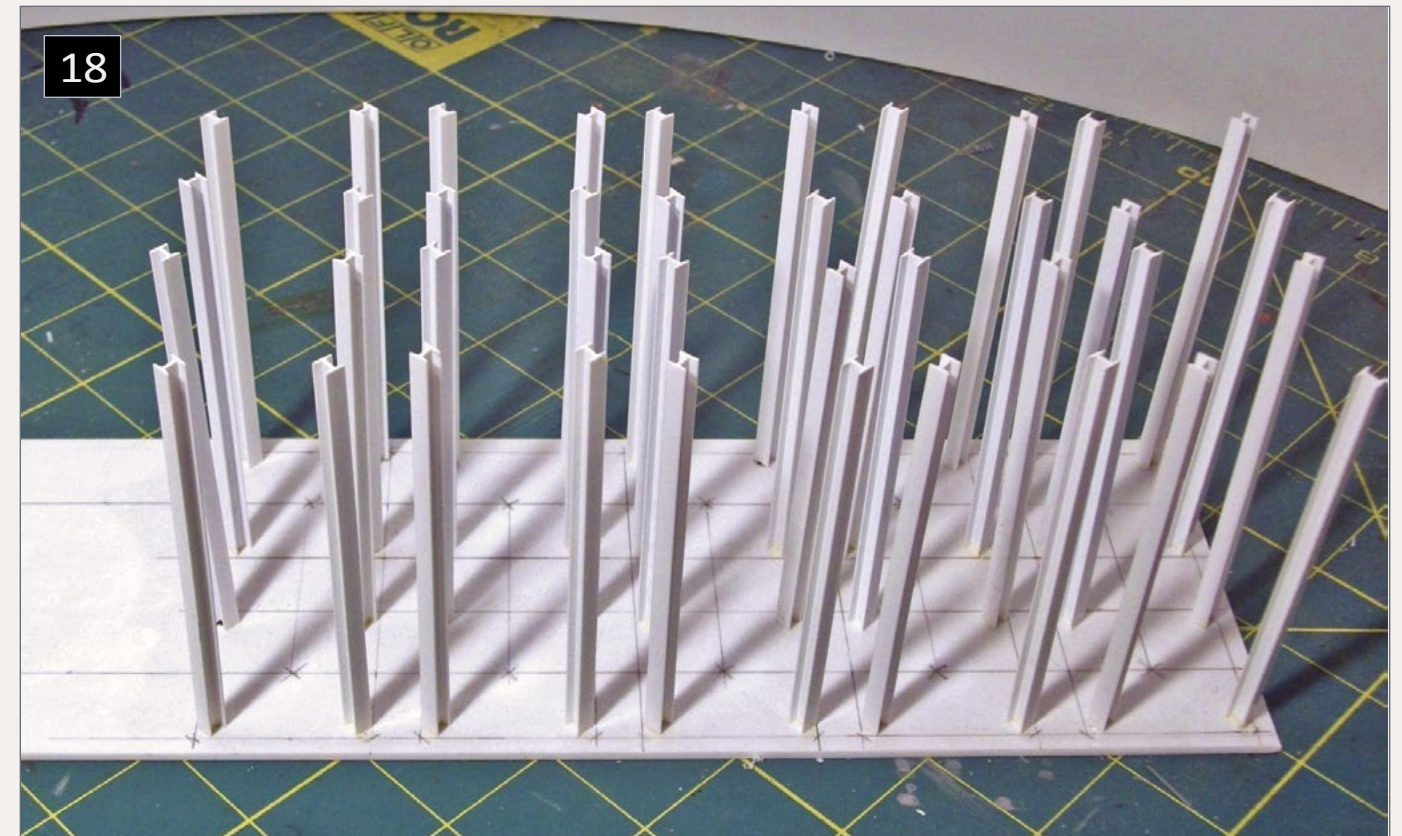

18. Silo base showing the silo supports glued to the base.

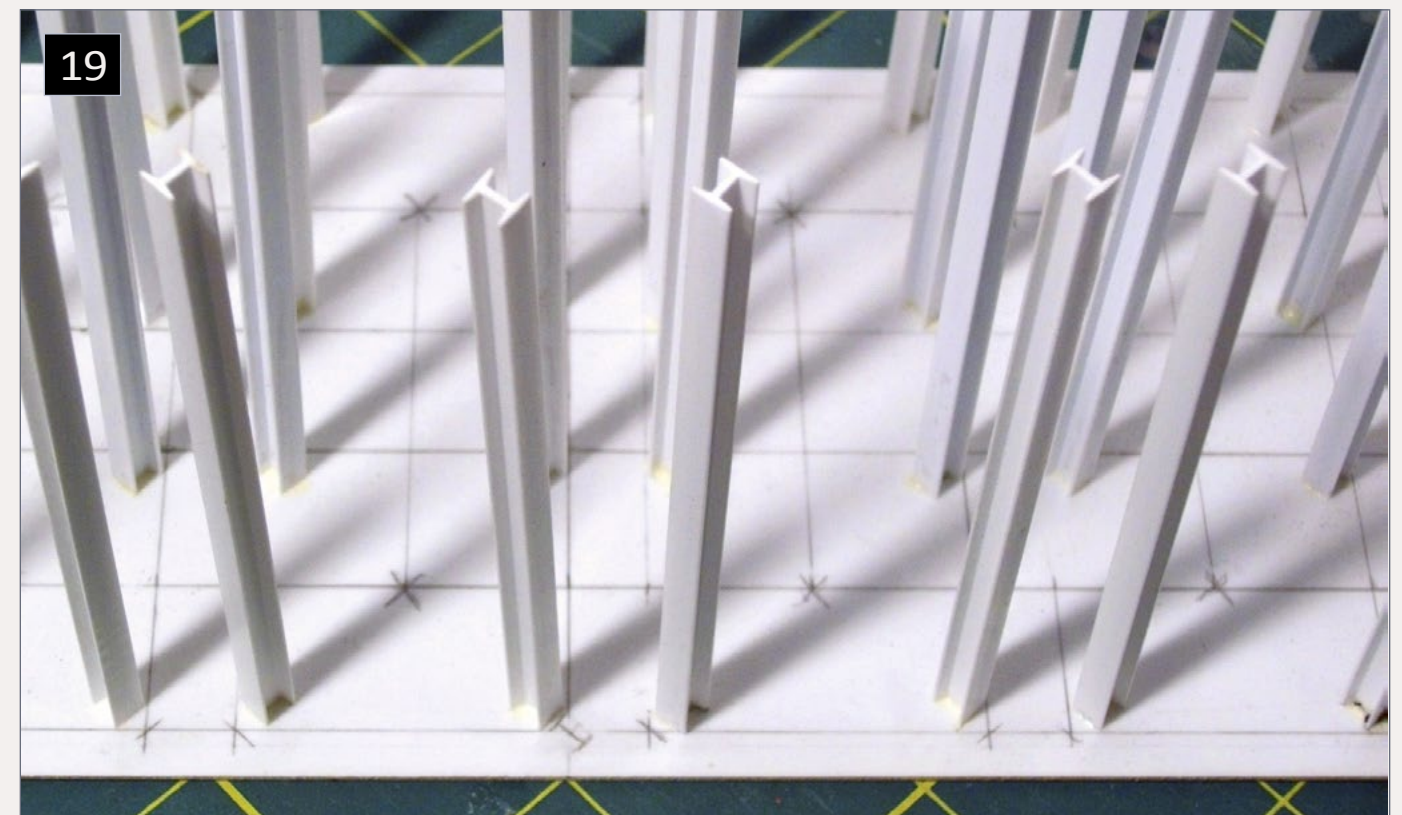

19. Close-up of the silo base showing grid markings for silo centers. The silos are space 1.5" on-center.

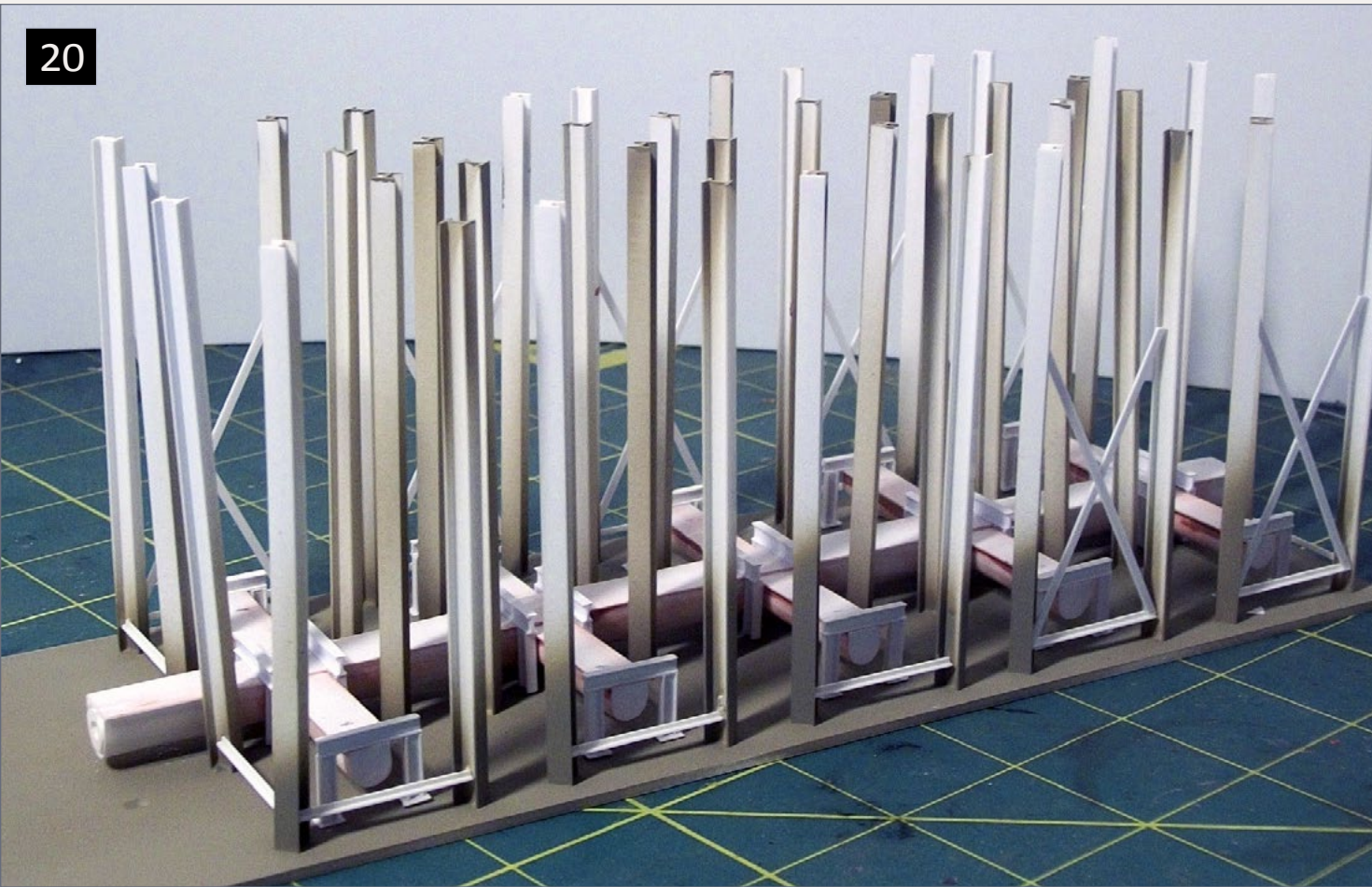

20. Partially completed silo base with auger installed and some of the .020" by .060" diagonal bracing and horizontal .060" angle glued in place between each column support.

seams every six scale feet across the overall height of 60 scale feet. Then I measured the vertical seams half the width of the sheet, every 15.1 scale feet, skipping every other weld seam so the joints wouldn't overlap. The final step was to cut the width of the sheet at 22.78 scale feet, which is the correct circumference for the 1" PVC pipe.

Wrapping the styrene is a bit of a challenge, but as shown in the photos it's not as difficult as it looks, particularly if the seam isn't visible on the completed model (thereby not requiring any sanding or filling). Finding suitable conical shapes for the silo bottoms was accomplished by perusing the local Michael's Craft store cooking and cake decorating section. A company named "Wilton" makes frosting application cones which were about the

right size and shape. Each of the cones required cutting the top and bottom out to get the right 1" diameter at the top and correct 3/8" diameter at the tank bottom.

Once I had cut the cones to shape, I used ACC to glue the cones to the PVC silos. The resulting seams weren't perfect, so I applied several coats of Bondo body putty to fill the seams. Were I to do the silos over, I would have approached the construction slightly differently by wrapping the styrene first, with a slight overlap at the bottom of the PVC pipe, and glued the

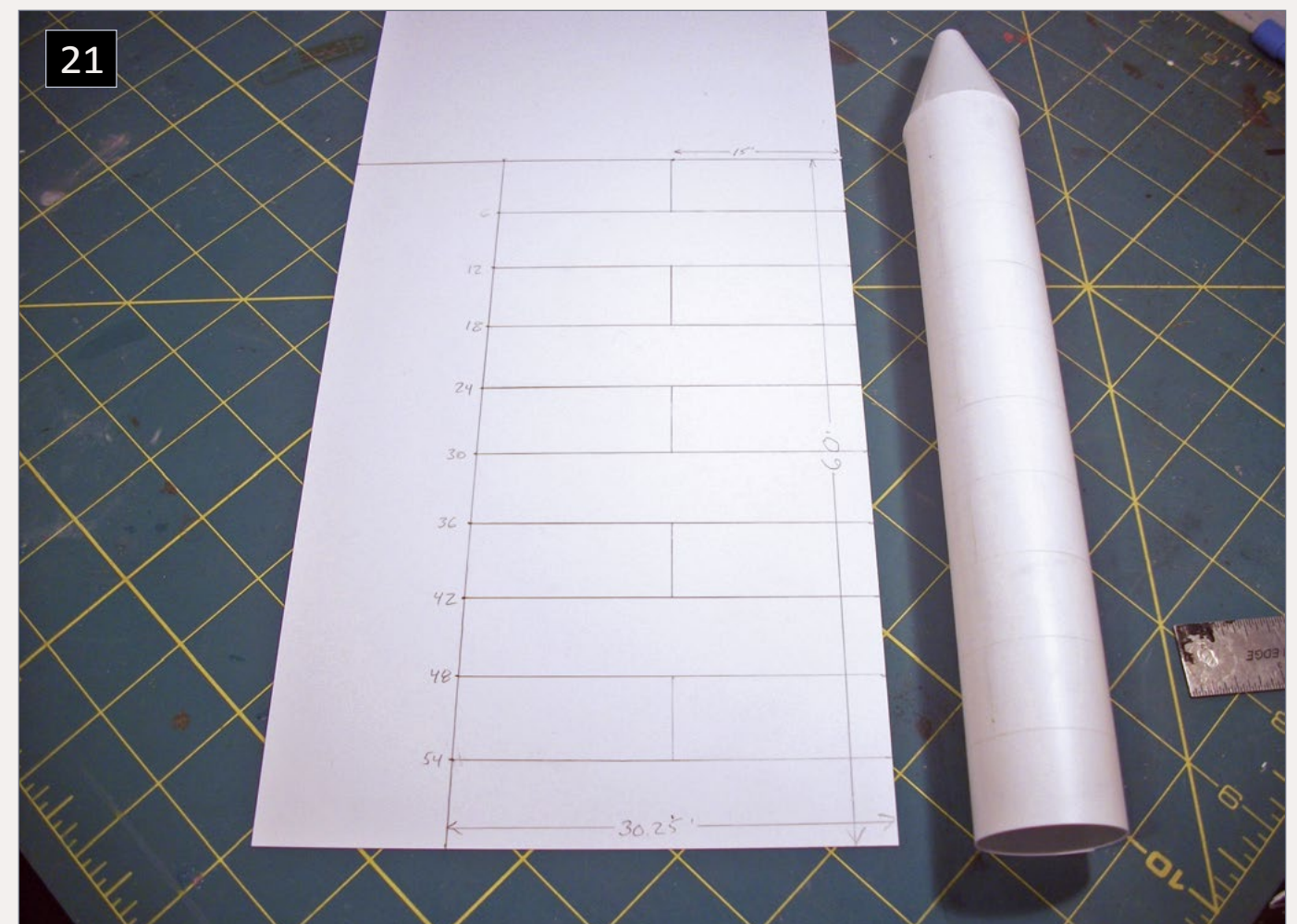

21. This photos shows preparation of the .010" styrene sheet to be wrapped around the PVC silo. The overall size of the sheet is 60 scale feet tall by 30.25 scale feet wide. Gently scribed lines every 6 scale feet represent the weld seams of the silo.

cone to the bottom of the PVC, allowing the slight overlap to cover the seam. In reviewing the prototype construction, this is also more accurate.

Once the silos were completed, I used two-pipe brass railings from Mike Rose Hobbies mrhobby.com for the walkway around the top. These railings were the perfect solution, since the brass easily forms to the radius of the silos. The trick to installation is laying the railings flat on a piece of masking tape and pre-marking the holes with the correct spacing to accept the pins of the railings. Then apply the masking tape around the silos, and drill the holes. Once all the holes are drilled, remove the masking tape and gently bend the railings around the silo



22. This photos shows the styrene temporarily tacked with CA cement to the PVC silo. The next step is slowly wrap the styrene around the PVC spreading CA cement every half inch and firmly pressing the styrene against the PVC to prevent bubbles from getting between the PVC and styrene.

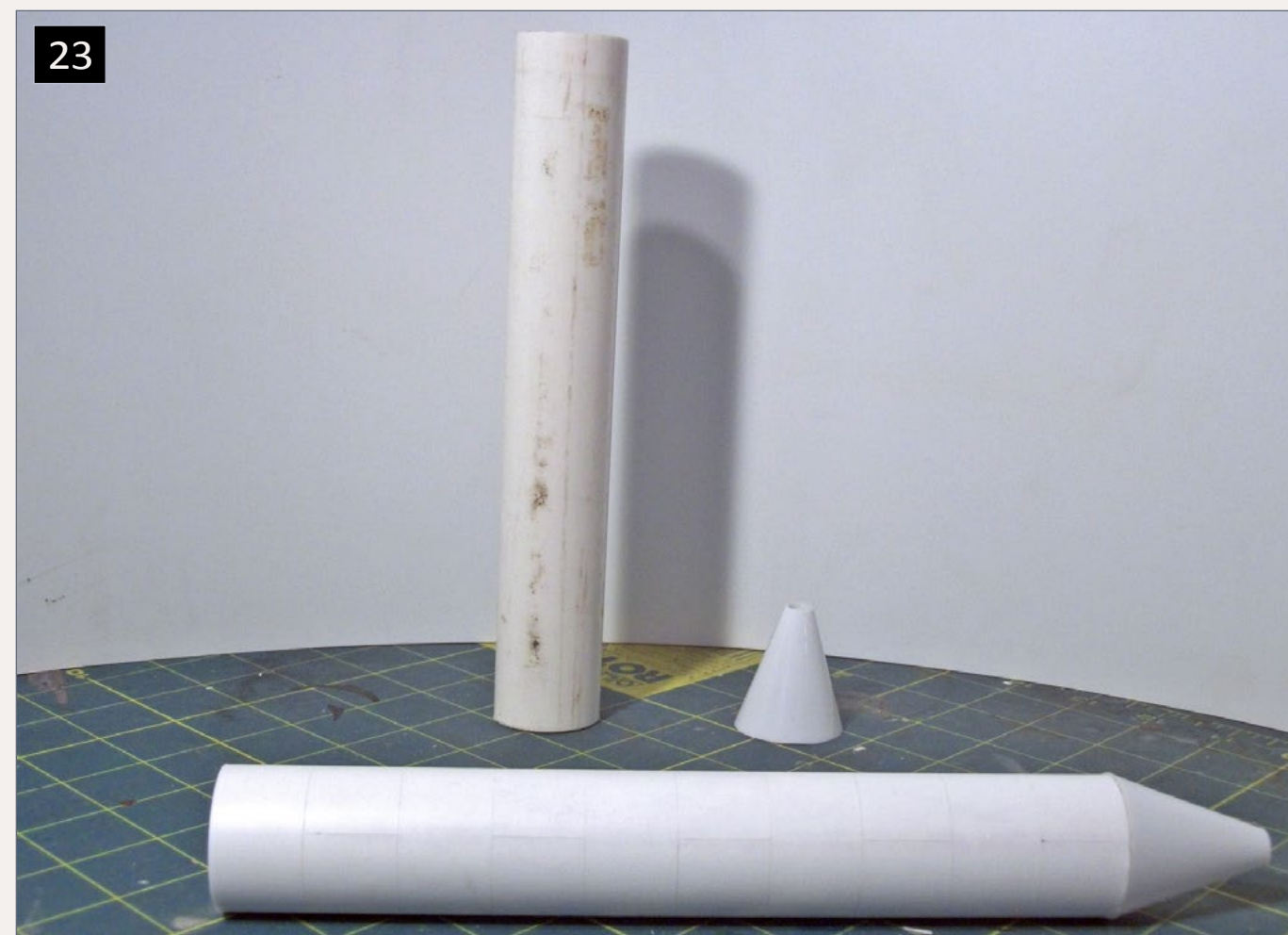

23. This photo shows the completed details of the silos and base.

and install the pins into the holes. If you are careful, the tape can be reused on several silos.

The last silo to be constructed at the end was done using 2" PVC laminated with .010" styrene [24-25]. To replicate the prototype, I cut the styrene into panels seven scale feet in height and used the same pounce wheel to create vertical rivet lines every 5' on the panels. A .030" by .030" strip of styrene was wrapped around the silo between each panel to represent the segmented construction of the prototype. After the panels were completed, I added a .040" roof and more of the brass two-pipe railings in the same manner as the other 10 silos. [24 and 25].

With the silos completed, I temporarily placed each one in place so that I could lay out the main auger trunk line running the length of the silo base, and the locations of the chutes that connected each silo to the main auger. The augers themselves were assembled from $\frac{1}{4}$ " styrene tubing with a piece of .020" thick by .40" wide piece of strip styrene attached to the tubing lengthwise. Two pieces of .030" by .040" styrene were placed on either side of the tube, and a strip of .010" styrene was wrapped around the tubing in a U-shape [20 and 21]. The wrapped styrene required several applications of body putty and sanding to get a smooth seam, but ultimately I wasn't worried about being perfect, since the detail was hidden beneath the silos and bracing.

Once the main auger was complete, I followed the same process, with slightly smaller .219" tubing for the chutes that run perpendicular to the main auger



24. In this view, the styrene panels are being applied to the end silo. The end silo construction differed than the other silos as each panel was separately wrapped with styrene. The panels were seven scale feet in height with rivets punched every five feet with overall circumference of 54.2 scale feet. Between each panel was a piece of .030" by .030" piece of styrene to match the prototype.



25. This view shows the completed silo with the vertical rivets visible on each silo and the brass handrails from Mike Rose Hobbies. Note the panels were offset so that the vertical rivet lines alternated between each panel.

beneath each silo, and cut each chute into lengths 1.15" long. The assembled auger and chutes were then placed on the silo base so I could construct the supports using .100" I-beams. Three pieces of .100" I-beams were used to support each chute assembly while .125" I-beams were used for the main auger assembly, one on either side of the chutes [20].

Once the entire assembly was completed, I went ahead with painting and weathering, since doing this after the silos were in place wouldn't be possible.

After the auger assembly was complete and permanently glued in place, the last step was adding .020" by .060" diagonal bracing between each silo support, and horizontal .060" angle at the base of each column.

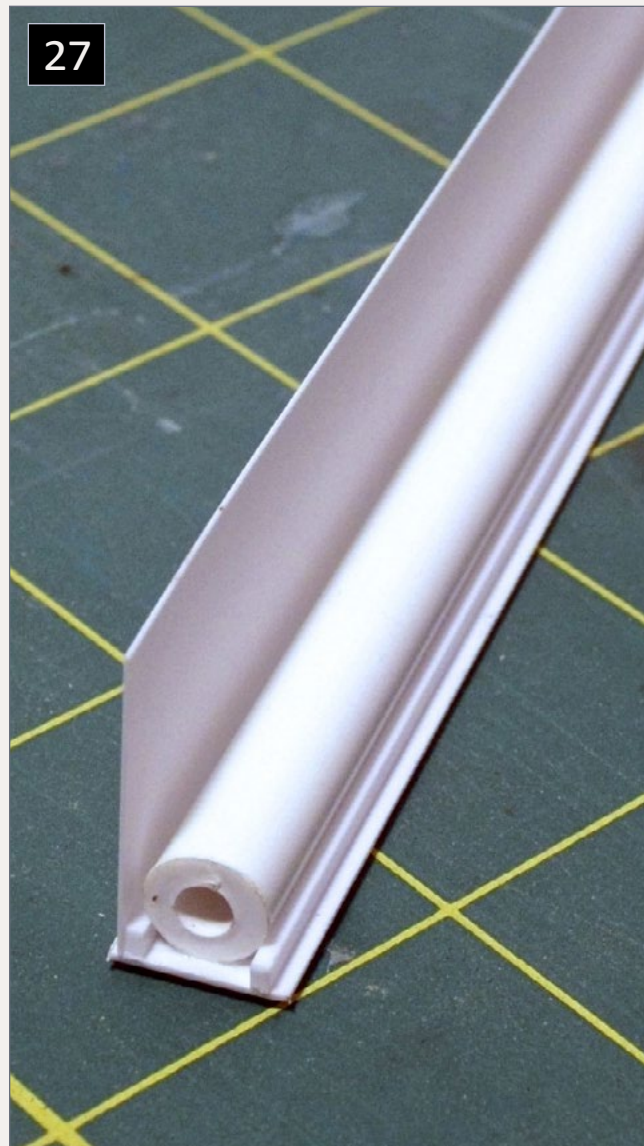
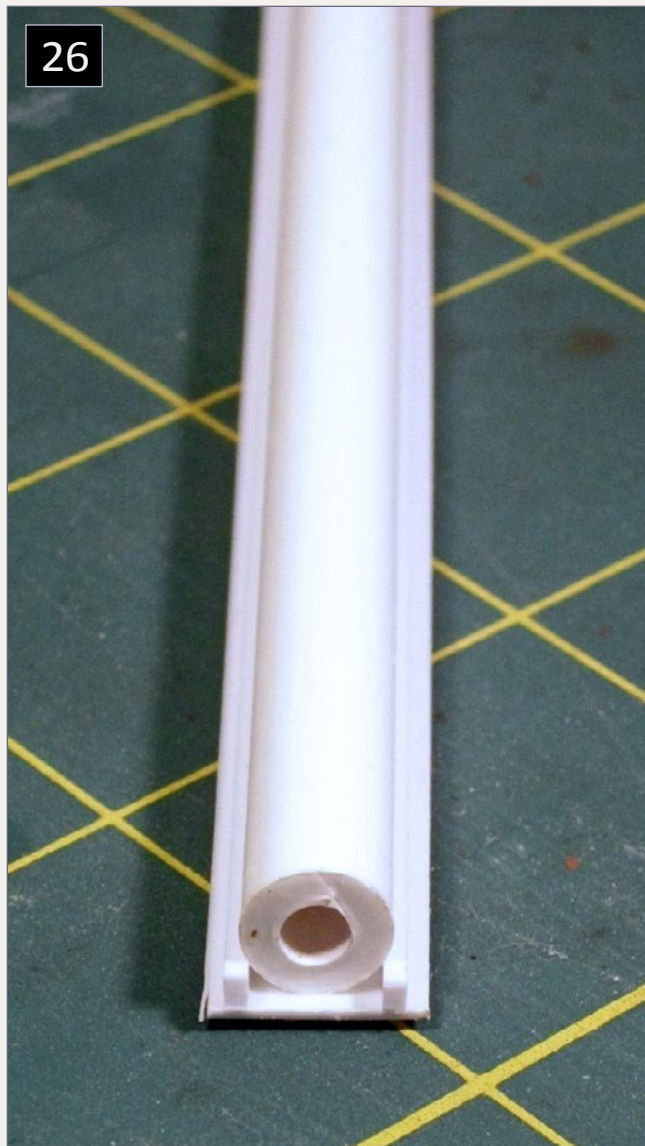

26. Step 1 of the auger construction showing the partially assembled auger. Note .030" by .040" styrene strips laid against either side of the 1/4" tubing and flat top to support the .010" styrene wrapped around the tubing to form the U-shaped auger profile.

27. Step 2 of the auger construction showing the partially assembled auger with the .010" styrene ready to wrap around the tubing to form the U-shaped auger.

Elevators and silo distribution piping

Each of the silo elevators is constructed of two pieces of Evergreen .250" by .250" strip (silo elevator) or Plastruct 5/16" by 1/4" rectangular shape (feed bin elevator) laid side-by-side [28 and 29]. Cross braces made of .020" x .060" strip styrene supports were glued every 10' on each of the silos. The elevator head assemblies were scavenged from Pikestuff components, while the pulley belt guard was constructed of .040" styrene filed to a rounded shape.

Once the elevators and head components were assembled, I began constructing the walkway and railings. Since I was already taking some liberty with the size and shape of the silos, I did not intend to replicate the walkways exactly, but rather capture the overall feel of the structure and make the silos connect to the elevators per the prototype. Each walkway was

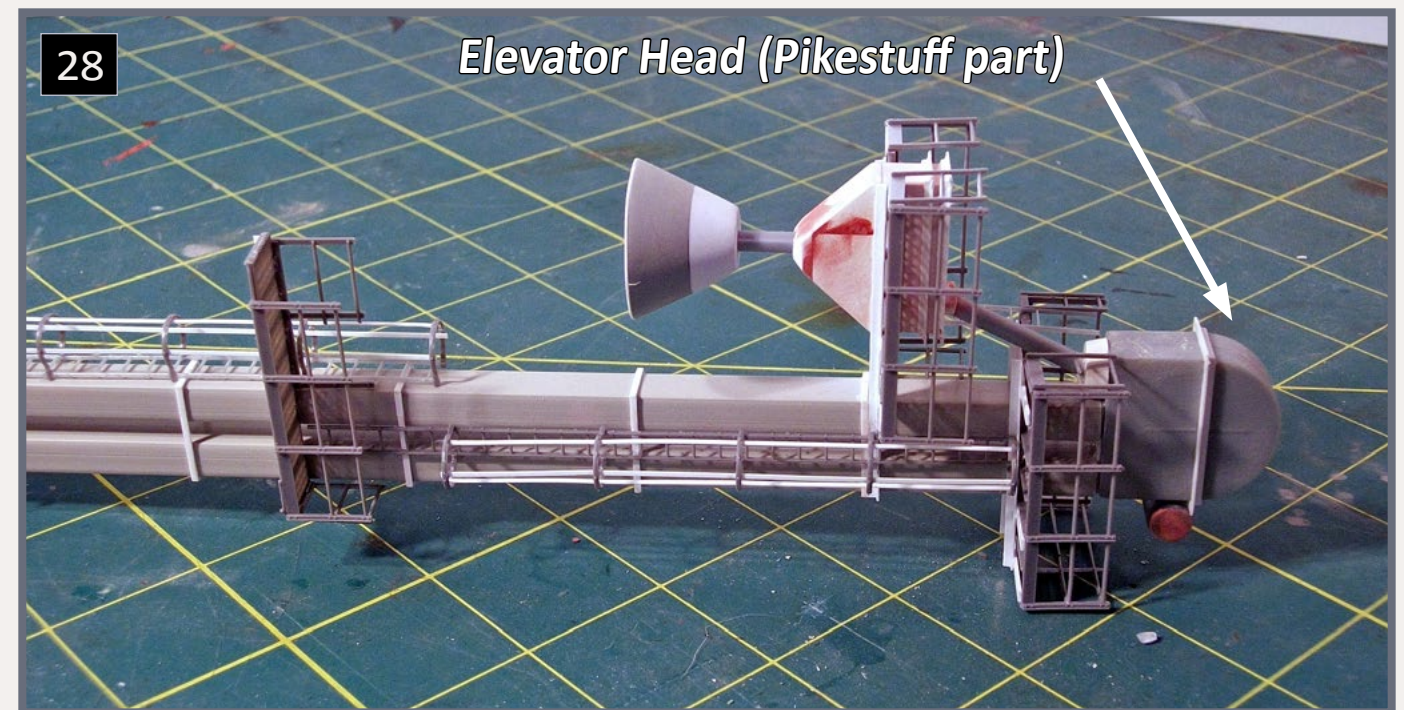

28. This photo shows the partially completed silo elevator and distribution piping. The unpainted photo illustrates the general construction of the elevator including handrails, distributor, and Rix Products piping.

assembled separately by cutting the Tichy railings to the appropriate length and then cutting the walkways to match. The walkway assembly was then braced with .020" x .080" styrene on the underside. The walkways were attached to the elevator using Evergreen .060" styrene angle. Once the walkways were assembled, I assembled the Tichy ladder and cage assembly based on the dimensions from the bottom of the walkway to the base of the elevator.

The silo distribution piping was constructed with the piping supplied with the Rix Products Grain Elevator silo piping cut to length. The distributor heads themselves were made from Lego parts and the general construction is shown in [30 through

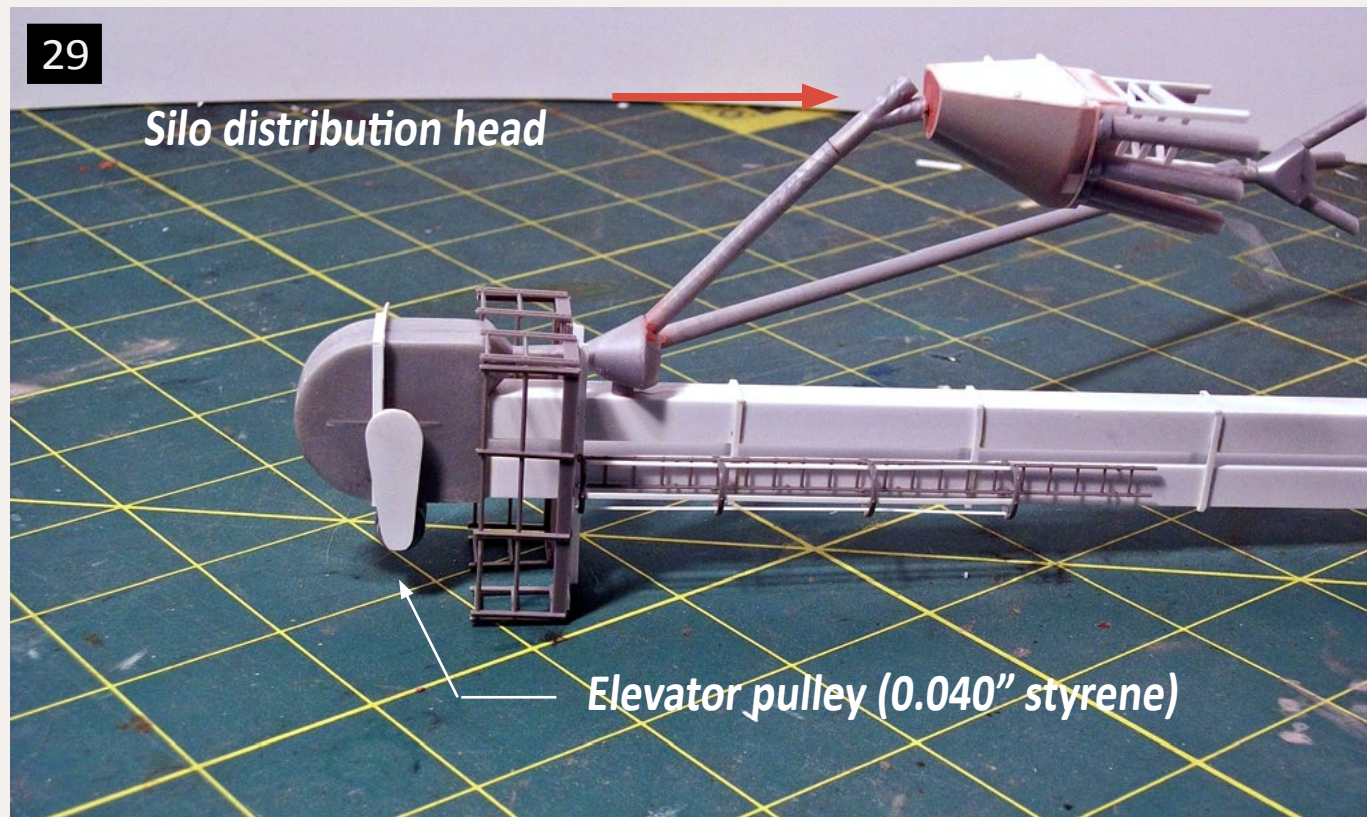

29. Partially completed feed bin elevator and distribution head. The unpainted photo illustrates the general construction of the elevator, head assembly and pulley guard along with handrails, distributor, and Rix Products piping.

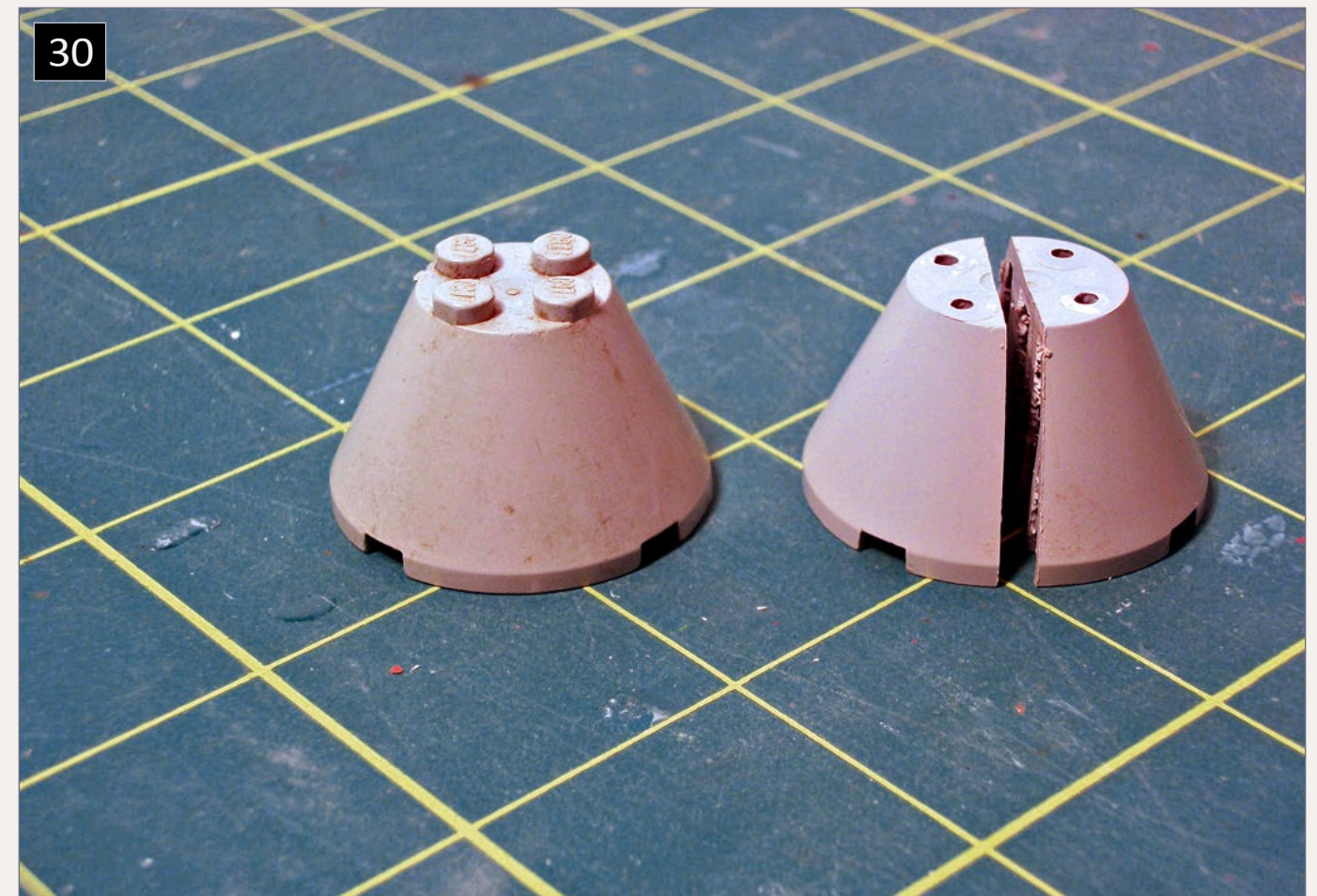

30. The next several photos illustrate how the elevator distributor head was constructed using a Lego part cut in half.

33]. Luckily, the parts were scavenged from a very large box of Lego parts I had when I was a kid, and none of my children's assembled Lego models were harmed. Otherwise I would have certainly heard from the complaint department about Dad stealing Legos.

Car unloading shed

The simplest part of the project is the car-unloading shed. This is as straightforward as assembling a Pikestuff Modern Small Engine House kit per the instructions to match the general construction of the prototype shown in [2]. The only detail I added was the overhead door assembly using styrene shapes [34].



31. After cutting the Lego part in half, a flat piece of 0.010" styrene was glued on the cut face with ACC. Two 0.020" by 0.040" horizontal strips were glued per photos of the prototype. A second piece of 0.010" styrene was glued to the bottom and sanded to the same contour.



32. This side view of the elevator distributor head shows the legs that were installed, and the Rix Products circular piping inserts glued to the base. Rix Products distributor piping would later be glued in each insert.



33. This bottom view of the elevator distributor head shows the legs constructed of two pieces of 0.060" angle and one 0.080" H-column. The legs rest against a piece of 0.040" thick by 0.188" high styrene piece wrapped around the base, and offset just enough to

fit the Rix Products circular pipe inserts.

However, even with simple projects, lack of planning can complicate things. Such was the case with the car unloading shed. Because one of the elevators is located on top of the car unloading shed, and the discharge piping to the silos was pre-cut on the workbench, it wasn't until I installed the car unloading shed on the foundation built over the track and ties that I realized I would have a 1/8" gap between the silos and the discharge piping. Ultimately, my solution was to build up the silo foundation base to make up the difference. Since the only side that would show on the completed model was the asphalt parking lot, it was easily fixed by building up joint compound to elevate the base.

Diorama base

In my years of assembling large or even medium-size structures, I've found that building structures on a base is much easier than trying to assemble structures directly on a layout, and offers the ability to create a diorama for photographs. It also helps avoid the challenge of trying to detail a structure foundation or area on a layout that's not directly in the foreground.

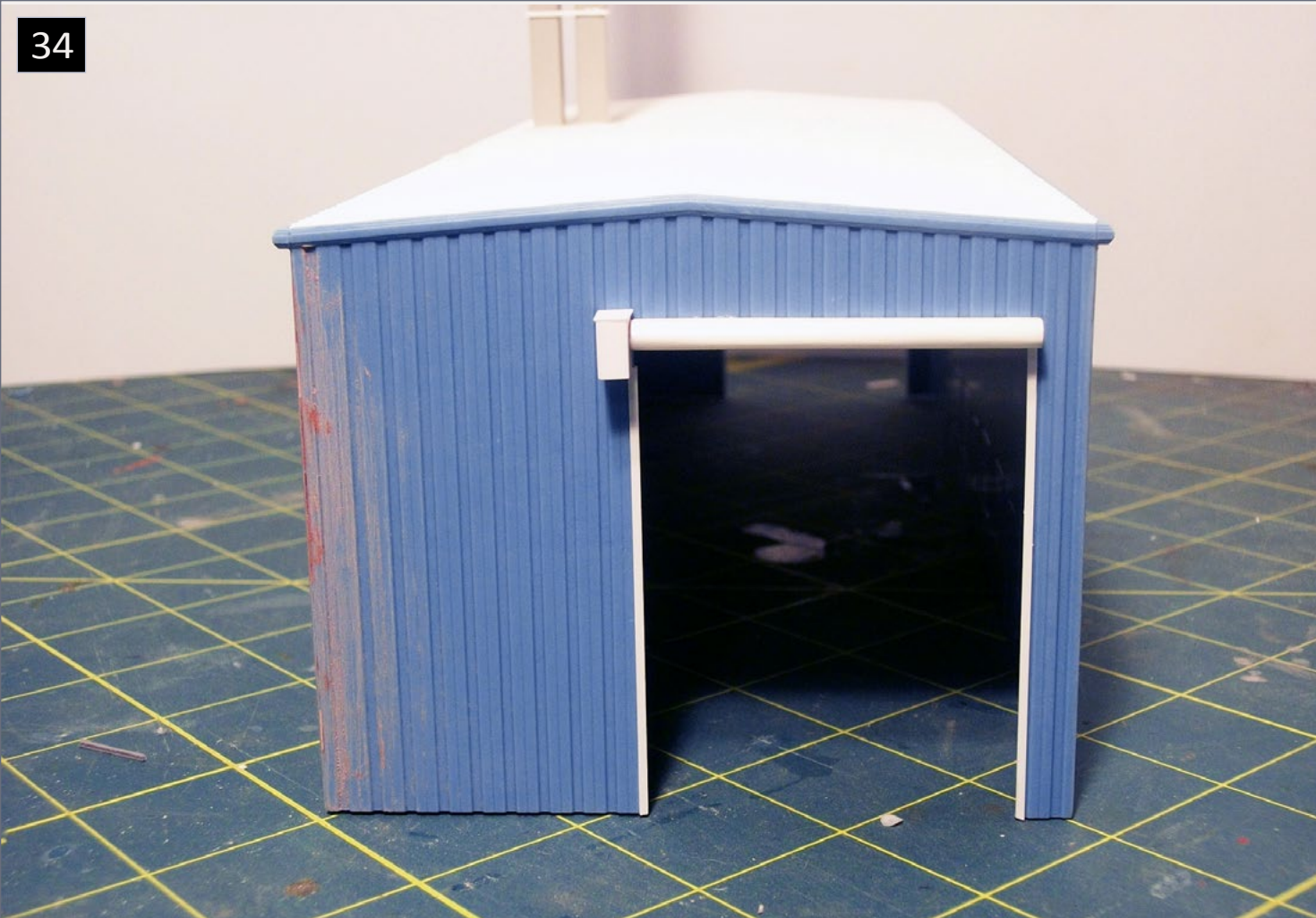

34. The car unloading shed was a straight forward assembly of the Pikestuff Small Modern Engine House with pieces of styrene used for the overhead door assembly.

At the time of this article preparation, I'm still in the process of finishing the layout room, so having a solid base gives me a secure way to store the mill until it's ready to be placed on the layout.

The base itself is constructed of $\frac{3}{4}$ " plywood with a piece of $\frac{1}{4}$ " luan glued to the plywood with carpenter's glue and several drywall screws. The luan acts much like a piece of Homasote, since it's a softer wood and accepts track spikes much easier than plywood. The majority of the base was covered with asphalt. One method I've learned to easily recreate asphalt is using a readily available brand of drywall spackling



35. I've always used drywall spackling for creating asphalt roads and parking lots, but the drawback was always chipped or cracked surfaces that allowed the white spackle to show through. One trick I discovered a few years ago was commercial grade cement coloring available at home improvement stores. The pigment content is strong enough to darken the white spackle very quickly and saves a step by not having to paint the completed asphalt.

paste and adding cement coloring [35]. Once thoroughly mixed, the spackling paste can be applied directly to the base using a trowel.

As the spackle dries, I periodically use the trowel to smooth the surface to remove the majority of the trowel marks. After it dries, I use a wet cloth to smooth out the area. The benefit of adding the coloring is if the spackle chips, the white color doesn't show through. If the coloring isn't perfect, I paint on a coat of 50/50 mix of Woodland Scenics concrete and asphalt

paints. I finish the parking lot with a light dusting of actual cement to represent sand and weathering spread out across the parking lot, which also helps blend the colors.

Painting and decaling

Painting the model is relatively straightforward since each of the building components are separate, allowing each side to be sprayed individually. For a project this large, several bottles of white paint are required. I'm a holdout of Floquil lacquer-based paints, so I used up my last few bottles of Reefer White, which



36. This photo shows the almost-completed mill with a few coats of Floquil Reefer white paint applied. At this point in the construction, I was over the hump and just waiting for the silo railings to finish things up. I was also eager to get the decals applied and start the weathering.



37. Finally, the completed model showing the various weathering applied. The majority of the weathering was done with dry-brushed artist oil paints. As shown, the roofs received the heaviest weathering, with several combinations of raw umber, burnt umber, burnt sienna, and raw sienna.

has been discontinued. Alternate paints can be used, though I'm hesitant to use paint directly from a spray can – I was afraid paint buildup would obscure some of the details, so I would still recommend an airbrush [36].

Working in environmental consulting, I'm well aware of the inhalation hazards of lacquer-based paints and stress that whatever paint or method of application is chosen, do it in a well-ventilated area.

The only building sections that require masking are the silo base and silo support columns. Fortunately, I was able to touch up the base with a brush after applying the white to the silo support columns. After getting a full coat of white on each building,



38. The completed main structure with several light coats of raw umber, burnt umber, burnt sienna, and raw sienna dry-brushed over the feed bin to capture the look of the prototype as it should have appeared in the early 1980s.

I sprayed the entire model with Testors Dullcote directly from a can, since the Dullcote won't hide details like paint. This is also the simplest way to get full coverage and provide a base coat for weathering the structure with the artist oil paints.

Once the main structure is painted, I gave the feed bin a coat of Floquil High Gloss in preparation for the Agway Decals. The decals themselves are available from Highball Graphics highballgraphics.com/homepage.htm as a special-order option. While not listed on his website, owner Jim Abbott was kind enough to provide me a few full-size sets that

39. The completed silos with a few coats of artist oils lamp black dry-brushed from the top of the silos and lighter applications of burnt umber down the sides. I used #6 charcoal pencils to gently outline the weld seams and rivet lines.



included multiple lettering sizes and striping to complete more than one mill.

Weathering

The last step of this project involved weathering the mill as it would have looked shortly after construction. The earliest photo I could find of the prototype was taken in 1983, a few years after construction. Even at that early stage, the mill was already

showing signs of rust on the storage bin, but to accurately weather the structure, I needed to get access to some better photos. Thanks to Mike Confalone, I was able to get access to Bill Feindel's photos taken in 1991. For the purposes of weathering the structure, Bill's photos were much more useful than those I took in August 2012, or the single photo I found in 1983.

For the model, I wanted to recreate at least a modest amount of weathering to highlight all the details I had incorporated, despite the fact that the era I'm modeling is the same year the building was constructed. Overall, I kept the weathering to basic dry-brushing using Winton Artist oil paints including Raw Umber, Burnt Umber, Raw Sienna, Burnt Sienna, and Lamp Black. In some areas the dry-brushing was exaggerated by using mineral spirit washes to represent streaking that's common from the effects of rainfall.

The other weathering technique which was used only on the silos was charcoal pencils. These are useful when trying to highlight details such as weld seams. The pencils are available in several hardness grades, with the softest (#6) most useful and forgiving. If a mistake is made, a simple pencil eraser can be used to remove the marking. [37, 38, and 38].

Overall this was a very satisfying project and I am pleased with the results. Now it's on to getting a home built for the feed mill.



Neil Schofield lives in Charlton, MA with his wife, three children, and the family dog. He works in Holyoke, MA as a Senior Project Manager for an environmental consulting firm.

Thanks to his father, Neil has been interested in trains since he was 6 or 7. His childhood memories include many railfan trips throughout the Northeast along with fond memories of operating modern piggyback

cars on his father's steam era layout.

Growing up, he was a self proclaimed rivet counter when it came to rolling stock and locomotives. He began building structures when he started his first layout in 2002. Since building his layout, the rivet counting has diminished in favor of getting trains running, building scenery, and structures. He's now starting on his third layout that is based on CP Rail operations in Vermont and hopes to have plenty of room for the Agway Feeds along with many other structures built over the last 10 years.

When he's not working, commuting, or modeling, he enjoys exercising and jumping on the bandwagon during playoff time for one of Boston's sports teams.

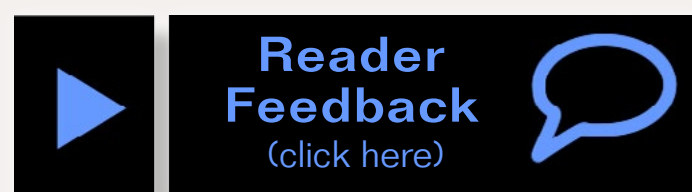

Bill of Materials

Cannon & Company 141-1401 - Radiator Screens (for main structure vents)

Evergreen Styrene 269-9008 – Assorted Sheet Styrene (.010", .020", .040", and .060")
269-227 – .219" Round tubing
269-227 – .250" Round tubing
269-122 – .020" by .040" styrene strip
269-123 – .020" by .060" styrene strip
269-131 – .030" by .030" styrene strip
269-132 – .030" by .040" styrene strip
269-415 – .250" by .250" styrene strip
269-348 – .040" by .188" styrene strip
269-282 – .080" H-Columns
269-285 – .156" H-Columns
269-273 – .100" I-Beams
269-291 – .060" Angle

Floquil 270-110015 – Flat Finish
270-110011 – Reefer White
270-110003 – Hi Gloss

Mike Rose Hobbies www.mrhobby.com - Two-pipe Railings

Pikestuff 541-5000 – Modern Small Engine House
541-1011 – Prefab Steel Warehouse walls
541-4 - Pre-Fab Warehouse
541-3000 – Doors & Windows (Main Structure)
541-1102 – Solid Doors

Plastruct 5/16 x 1/4" Rectangular Channel

Rix Products 628-407 Grain Elevator

Tichy Train Group 293-8002 – Safety cage Ladder Staircase
293-8001 – Open Grate w/Handrails

Testors 704-1160 – Dullcoat
704-3507 - Model Master Liquid Cement

Wilton Call Lily Former Set – For Silo Bases
(Available at Michael's Craft Store)

Windsor & Newton Winton Oil Colors – Raw Sienna
Winton Oil Colors – Burnt Sienna
Winton Oil Colors – Raw Umber
Winton Oil Colors – Raw Sienna
Winton Oil Colors – Lamp Black ■

SOUTHERN PACIFIC GP9 COMMUTER LOCOMOTIVE

Build this unique Southern Pacific locomotive ...

The Southern Pacific has always been a railroad that appealed to me, whether it was its history, the color schemes on its engines, or its variety of motive power. Some pioneering work and designs unique to the SP are among those -- think about the Cab Forwards, or in more Krauss-Maffei diesel hydraulics, and the SD45T-2 powerhouses.

As a model railroader, I also like details that set SP engines apart from other roads such as the full light packages on the diesels. They are just fun to look at on a model and would be in 1:1 scale too, I imagine. Living in the UK, I've not been fortunate enough to see them in action).

For my own railroad empire, and for club use, I wanted to add some passenger



– by **Koos Fockens**
Photos by the author

operations. I have no space for long passenger trains, so a commuter service would fit better. What better to model than an Espee commute train, consisting of a lone GP9 and two to three bi-level passenger cars? With the recent re-release of the Walthers model of these cars, I decided to buy two of them. All I needed then was motive power.

I had two older Life-Like GP9 models in Pennsy colors in boxes, and I toyed with the idea of turning these into SP locomotives. Both were Phase III GP9's, with the three large radiator and dynamic brake fans on the roof. Most dedicated commute GP9's were Phase II, which had the one large brake fan, and four small fans. Luckily a friend at the local club had a Phase II he wanted to swap for a Phase III. I gave him my Pennsy, and I got a UP in return.

Preparing for modifications

First, I stripped the shell of all separately applied detail parts, and then stripped the paint off using a product called Model Strip. After soaking the shell for about 10 minutes, I could see the paint starting to let go, so I started scrubbing it with a medium toothbrush. This got most of it off. I then washed the shell using soapy water, and dried it. I found a few stubborn patches of paint left, so I repeated the Model Strip treatment on those isolated areas. This got the last of it removed.

I compared the bare shell to photos of my chosen subject SP 3191, a GP9 commute locomotive, one of the few that had a five-chime Nathan P5 horn on the cab roof.

The Internet is a great resource for modelers like me who model something they never saw in real life, either because it's of an era that has gone by, or it is of a country or distance that is not exactly on your doorstep. Both apply to me.

Using various photo websites I found a selection of images of my chosen commute Geep.

There were some obvious differences in details between my shell and the photos. The most important were an additional filler cap on the sill above the fuel tank, different louvre arrangements on the battery box doors, and some louvres on the short hood that were not on the model at all.

Aside from that, there were some details I wanted to improve. I wanted finer grabs on the hoods, and also wanted to replace the roof fans with the great models made by Cannon & Co. At the time I started this build, these had only just become available on the market. The handrails and m.u. hoses present on the model were fine for my liking, also keeping in mind that this loco would be handled from time to time at the club. It could not, and therefore shouldn't be a fragile display model; this one was going to work for a living!



2. The shell before cutting out the sill.

Of course, the full SP light package had to be modeled on both ends of the hood, and the short hood needed steam generator details that needed adding to the short hood, as these were missing from the freight shell I had.

Modifications

I started with the steam generator details on the short hood. I used several pictures of the prototype to find the approximate correct locations, and compared these with the drawing that came with the detail parts. With this information, I guessed the correct locations using my ever trusted Mark I eyeball.

Next was the side sill. The pictures show the before and after.

I modeled the second filler using a few pieces of scrap styrene. I didn't even take dimensions. I had a good long look at the prototype photos, and guesstimated its size.

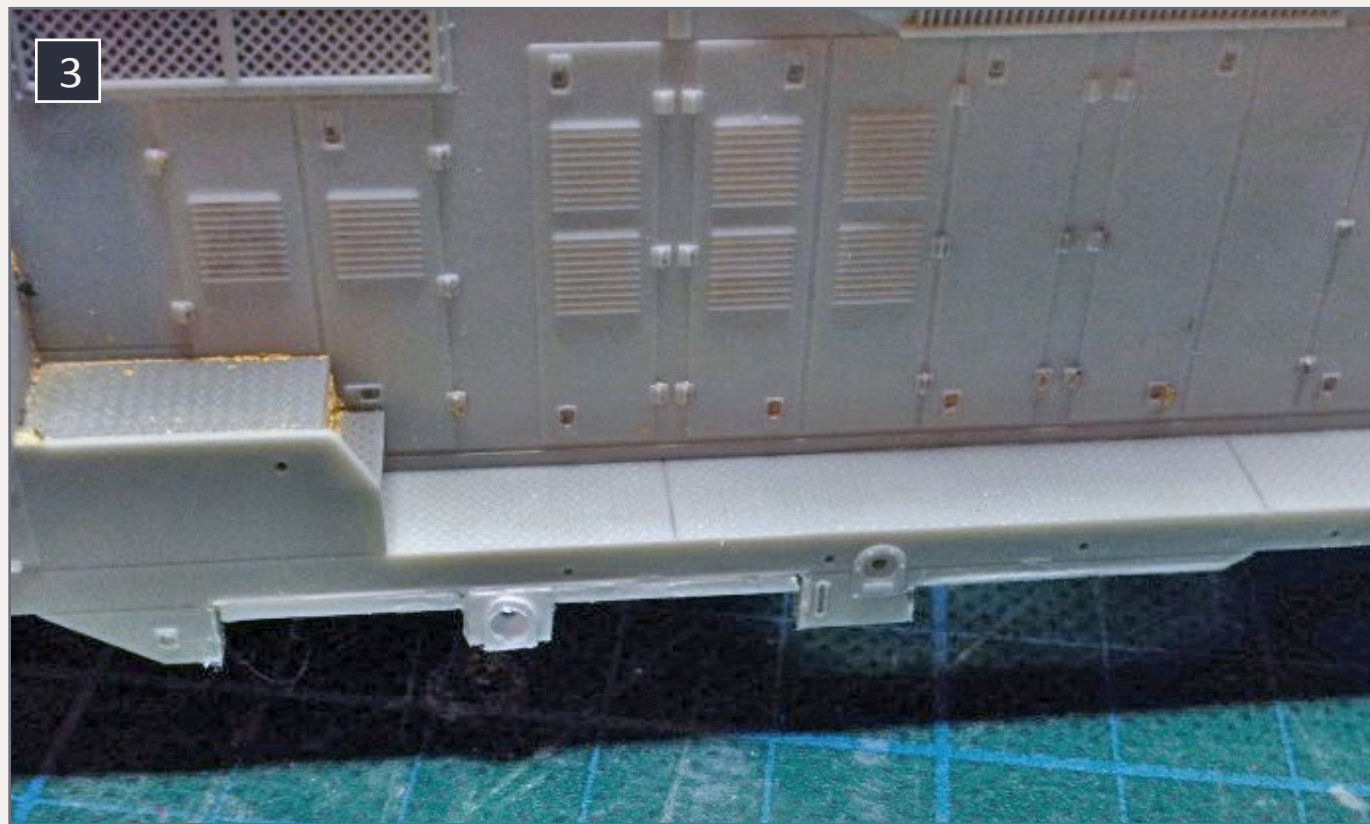

3. Sill cut out, and new filler scratchbuilt from scrap styrene.

A thin sheet of styrene gave it some depth and I drilled a hole in the middle for the filler opening. The result looks convincing enough to me.

Headlights

Next were the headlights. I used a chisel blade in my X-acto knife to cut the old light castings off. The holes in the shell were now in the wrong place for the new casting, so they need filling up.

TIP: Here's a quick and easy technique to do this: Take a suitable piece of plastic sprue, found in many plastic kits, and gently heat this up (a lighter or candle works great) until it goes soft. Then gently pull both ends so it stretches and starts to taper. Remove the heat and let it harden. Cut the sprue at its thinnest part and insert it in the hole. Use CA to fix it in place, and then cut off the sprue flush with the shell using the same chisel knife. You'll get a smooth exactly fitting patch without the need for any plastic filler.

4. Headlights cut off, and holes being plugged with a bit of sprue. Steam generator details in place. I decided against the use of the wagon wheel antenna in the end, as it would date the model too early for my use.

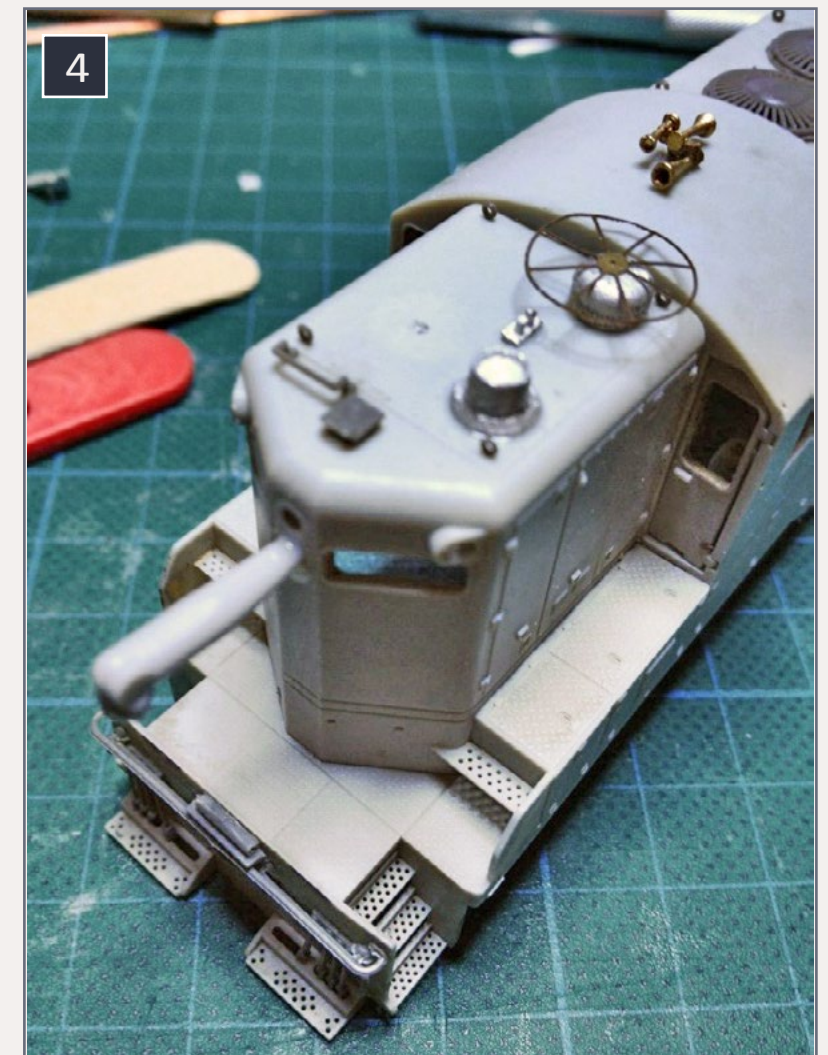
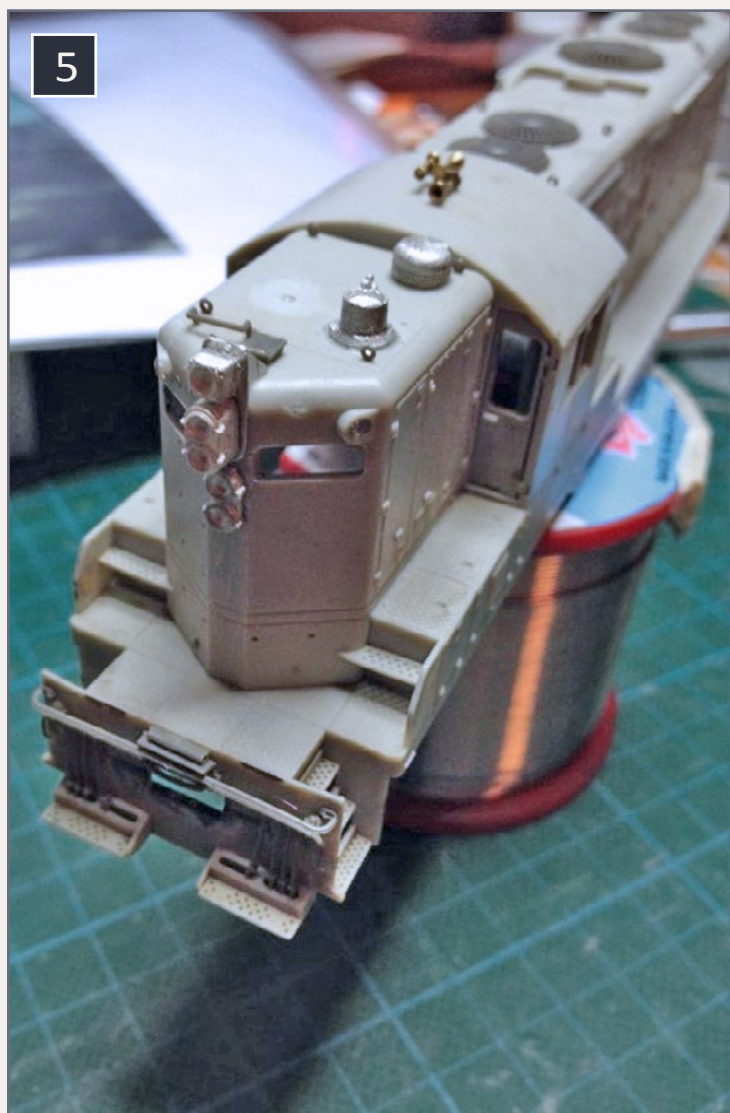

Photo [4] shows this technique, before cutting it flush on the shell.

I fitted Details West light housings to both hoods. I then proceeded to drill them out with a pin vise and the appropriate size drill. It is a very labour intensive undertaking. The castings came loose a few times while doing so, but I reapplied glue after I was done. Next time I might try the plastic castings made by Detail Associates.



5. Light package fitted. Note the square emergency light, which was replaced later with the correct oval version. I used the Details West castings, but Detail Associates also makes suitable castings in plastic.

size drill. It is a very labour intensive undertaking. The castings came loose a few times while doing so, but I reapplied glue after I was done. Next time I might try the plastic castings made by Detail Associates.

Fans

After removing the original main fan, I discovered that the hole in the shell was slightly too large to fit the Cannon fan frame [7]. I solved this by gluing a thin strip of styrene inside the edges of the hole. This means that the fan base of the new fan now sits flush with the top of the shell. The small fans did fit pretty much without any further modifications to the shell.

Louvers

Using my chisel knife, I proceeded to remove the bat-



6. Ready to fit the fans.

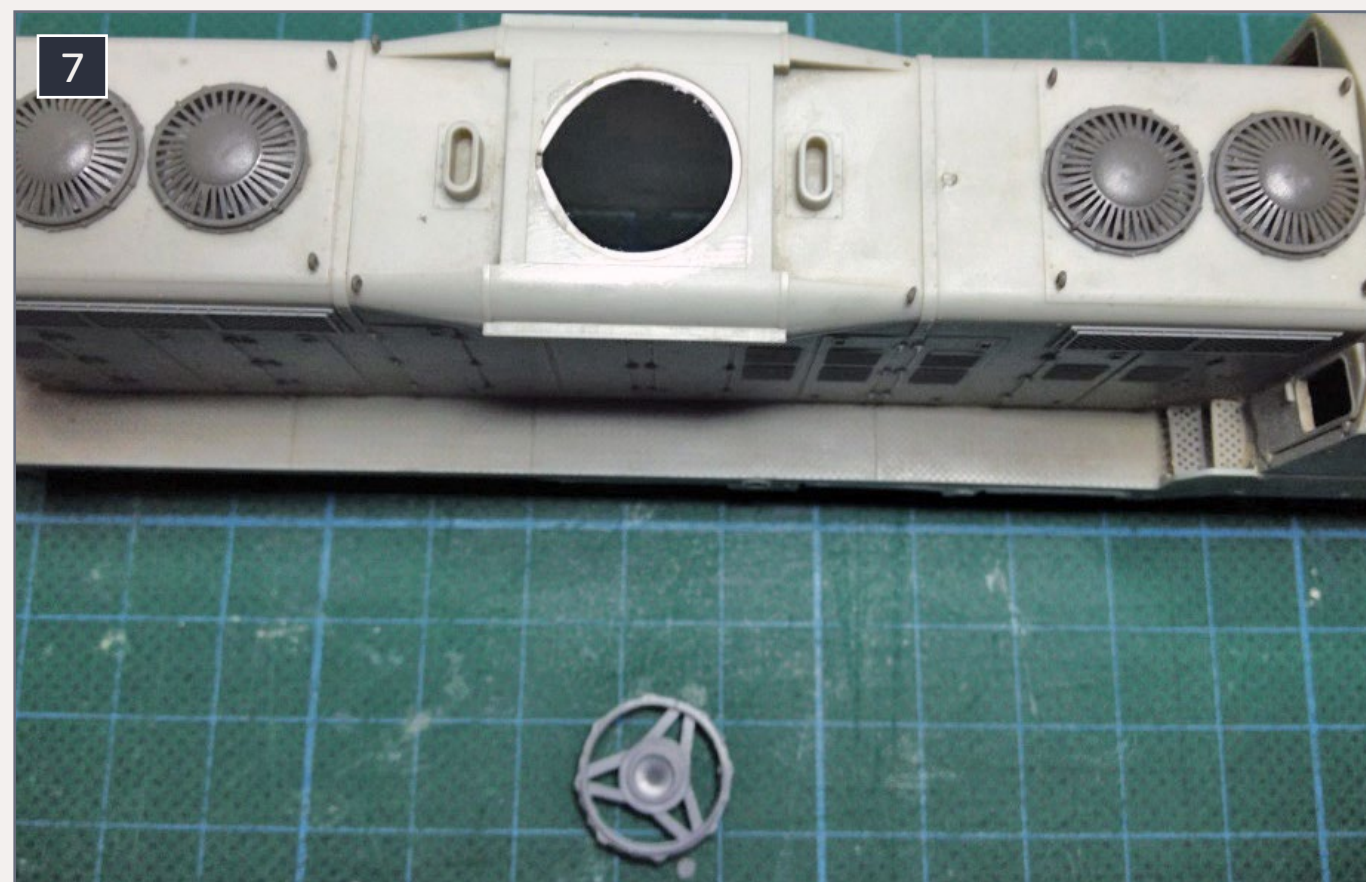

7. Main fan base.

tery louver castings, and the rain gutter above the window to make room for sunshades.

I used some Archer transfers to simulate the new louvers needed. Picture [8] shows the new louvers on the battery box and the short hood.

Lastly I added new 18-inch grab irons on both hoods, m.u. cable receptacle stands, modified the pilot a little bit by cutting away the footboards, step plates and installed a brass sunshade above the windows.

The observant reader will note that I omitted armrests and wind deflectors. That is true, and I will add these in the future as soon as I have received them in the mail.



Painting & decaling

I had purchased several bottles of PollyScale acrylic paints before Testors announced they would discontinue them.

I airbrushed all my paint, using a mix of approximately

8. The Archer transfers have been added to simulate the new louvers. A prototype photo was used to determine the locations.



9. Painting in progress, I began with SP scarlet red.

80% paint and 20% thinner. Distilled water works, but a proper acrylic thinner is best.

First I sprayed the loco with primer gray. This was followed with a few coats of SP scarlet red on both hood ends. After the scarlet red dried, I masked off the areas that had to remain red, before I sprayed the SP gray.

Next the shell received a coat of gloss acrylic lacquer to form a smooth base for decaling. I used Microscale decals for the lettering and the wings. I was very pleased to find that the color match of these and the paint I had chosen was very accurate to my eyes. They blend even better after another top coat of clear matte finish was applied.

The clear matte finish dull coat is a little coarser and gives a very good base to use with weathering powders etc.

After installing the lights and decoders (see the “under the hood” section), the loco was assembled and test run. After this I weathered it using Tamiya weathering sets, as well as powders of a variety of shades and makes. I didn’t weather the unit too heavily, but I certainly wanted it to look as if it is earning its keep.

Below are a few pictures on my home layout, as well as a shot at the club.

Under the hood

Under the hood, things needed changing too. This being an older LifeLike release, it had suffered from the well-known disease of split axle gears, and I wanted to build in DCC plus sound.

I cut out part of the weights to facilitate space for the speaker and give it some room to breathe. The axle problem is easily solved. Walthers sells replacement axles, but you can also use the axles of the Athearn blue-box or RTR ranges. All you need is



10. SP Lark gray painted on.

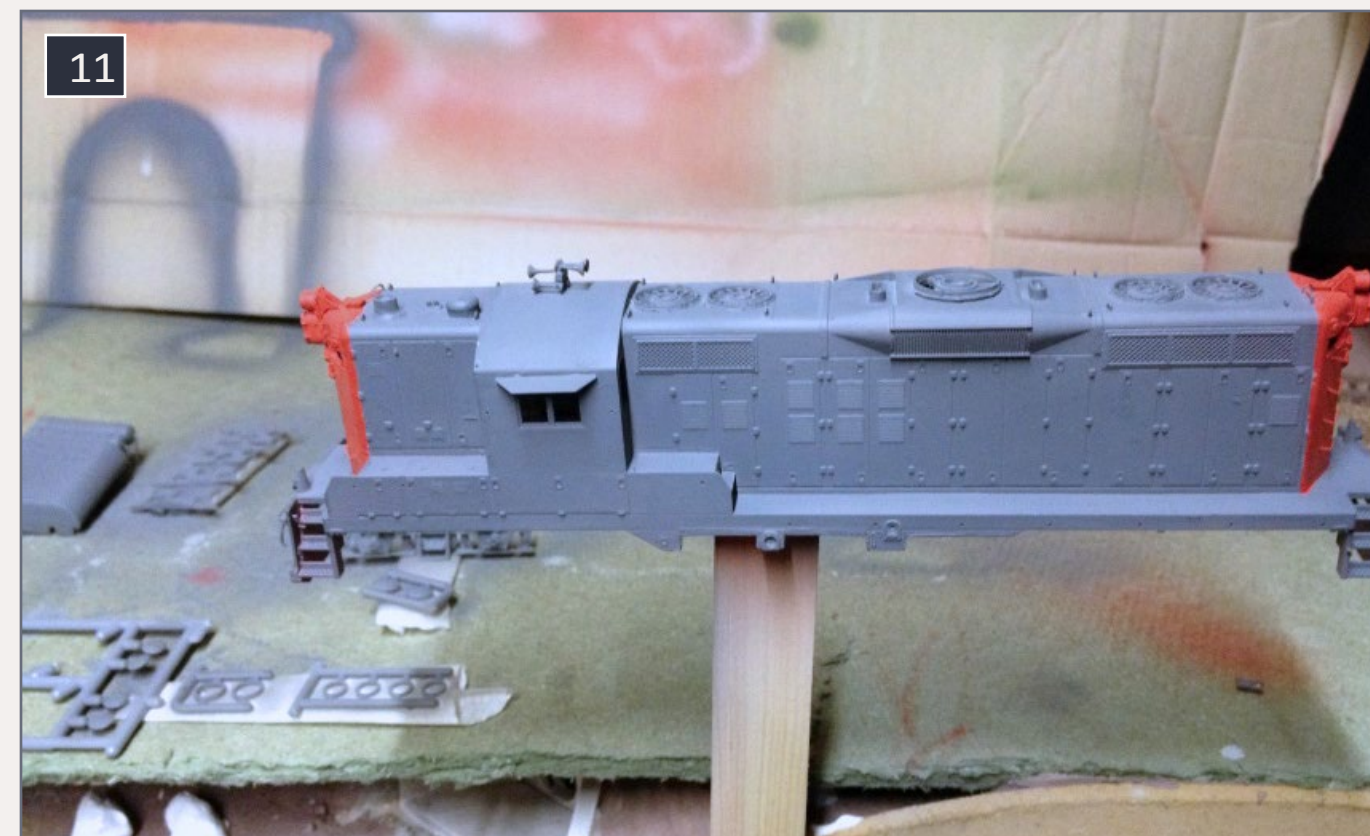

11. Masking tape removed.

the plastic center part. The original wheels will pull off the defective shafts and fit straight onto the Athearn gears.

I soldered wires to both sides of the truck power pick-up, and guided these to the DCC decoder. The LifeLike drive is an updated clone of the old Athearn blue-box, and for all its strengths, it does rely on the chassis for power pick-up. This is fine when everything is new, but over time dirt and grime will get into these places, and then problems start. The wires bypass this all together and give a much more reliable pick-up.

For a decoder, I used a ESU Loksound Select Direct, with their recently released GP9 sound files which sound fantastic. Also, the Loksound decoders have some of the best motor control on the market, so to have both in one decoder was an added bonus.

For me, motor control is most important. I love very slow crawls and being able to pull away smoothly or stop without a noticeable “yerk.” With this motor control, I can run this loco so

slowly that it takes upwards of 20 seconds to move the distance between two ties on the track, and that's just using the build in "auto tune" function of these decoders. While I know that such speeds will rarely be used in the real world, it is very important for the transition from standstill to moving, or vice versa, and to have a very smooth running loco with no sudden speed changes.

With the exception of the red emergency lights, I used individual 0.8 mm micro LEDs in warm white color to light the headlights and the gyalights. Eight are used. I parallel wired two of them to each decoder light/function output. These already have build in 2200 ohm resistors so no external resistors are needed. As you can see from the pictures, the lights are more than bright

enough, but can be further dimmed by using the corresponding CVs if you so wish.

As these are very small LEDs, the best way of fitting them was to add a drop of Micro Krystal Klear to each lens opening with a toothpick. I guided the wires through from the outside very gently, until the LED is just recessed inside the lens opening. Once this dried, I add more to seal it up and form a clear lens. Doing this



12. The Cannon fans installed.



13. The shell is being decaled. Note the difference and improvement in the gray color after the gloss is applied. The wings were still being maneuvered into place in this picture.

any other way will just end in frustration as the slightest movement will ensure the LED drops out into the shell, and you can start again.

Using Krystal Klear makes the installation more or less permanent. As these LEDs last a lifetime, that shouldn't be a problem. I see absolutely no reason to use grain of wheat bulbs or those that you find in the current Athearn models. (For these there is no excuse, I feel. Athearn, please consider changing these). The quality of these LEDs and their natural light color is great and worth the extra expense. The emergency lights were modelled using MV Products lenses.

Sound

The speaker was mounted in the cab, as this is where the shell is the widest, and I can get a larger speaker built in. Placing one in the long hood is also possible, but might require you to cut away

more of the weight. That makes the engine less heavy, and less able to pull well.

As the cab windows are shut, and it's all quite dark inside, I don't miss the interior. It's only obvious if put next to a new Athearn Genesis GP9.

SP 3191 is now in service, its engine rumbling and the five-chime horn echoing ahead on the line, warning everyone of its imminent arrival, while the gyalights and headlights light up the track ahead.



15. Ready for departure at 11th Avenue passenger station, while another SP commute train has just arrived on the adjacent track, at the April 2014 monthly "Western Union."



14. At home on the layout.

Advertisement

GLX
TOP QUALITY PRODUCTS
FOR THE MODEL RAILROAD CRAFTSMAN

Cameron Block

Click to Order

WWW.GLXSCALEMODELS.COM



Parts list

- MU stands, Details Associates Part No LT1026
- LifeLike Proto2000 GP9 Phase II locomotive
- ESU Loksound select direct DCC decoder and 8 ohm speaker
- 8 micro LED's on leads, 0.8 mm warm white, by Express Models UK.
- 4 replacement wheel axles, Athearn 60024
- Steam generator detail set Details West PART no SG-118
- Cannon & Co. large fan, early EMD PART no 1854
- Cannon & Co. small fans, early EMD PART no 1707
- Bent grab irons 18" BMLA part No 4511
- Straight grab irons Details Associates Part No 6423 (1 used behind engineer cab on long hood)
- Details West SP GP9 light package PART no HS 103
- CAL SCALE five-chime Nathan P5 horn PART No 564
- MV products red lenses Part No L160
- Archer transfers, louver assorted pack Part No AR 88075
- Microscale SP loco lettering and wings decals I used 3 sets, because I used left-overs from a few sheets: Part No 87-617 , 87-177 and 87-447
- PollyScale primer grey
- PollyScale SP Lark dark grey
- PollyScale SP scarlet
- Micro Scale Micro Krystal Klear



Koos (pronounced as "coast" but without the "T") Fockens is a Dutch model railroader who lives in the southwest of the United Kingdom. He's married to Vicki, and has two children. Sadly, neither of them share his enthusiasm for U.S. model railroads.

He got the bug at the age of 3. After starting out in Dutch HO scale, he switched to N scale, modelling German railways. He switched to North American HO in his late teens when he was introduced to the NMRA by a friend. His main interests in modelling are the SP and the California Northern in 1993-94.

Advertisement



Rusty Stumps
Scale Models

WE ONLY SELL WHAT WE MANUFACTURE

DETAILS IN HO, O, S & N SCALES
LASER CUT SHINGLES, DOORS & WINDOWS,
FENCES, SIDING, CRATES. Also RESIN and
WHITE METAL DETAILING CASTINGS.

CRAFTSMAN KITS
IN HO, O & S SCALES

CHECK IT ALL OUT AT
WWW.RUSTYSTUMPS.COM

Send \$3.50 for Catalog - Specify Scale

RUSTY STUMPS SCALE MODELS
6785 Cherry Blossom W. Dr., Fishers IN 46038
Phone (317) 595-9489



Turntable bridge

with a arch



– by **Mike Holly**
Photos by the author

Build this N scale arch for your turntable ...

During construction changes at the engine shop on my Elizabeth Oaks Layout, I installed a scratchbuilt 80' turntable. When it came to designing the turntable bridge, I didn't want a plain bridge. I had in mind some sort of centered arch to provide a power connection to the bridge drive motors, like the prototype. Research showed me that bent H-beams were common on prototype small turntables. Because I am modeling in N scale, the arch needed to be sturdy, easy-to-build, and uncomplicated. So I had another reason for choosing the H-beam for my turntable bridge.

Read on to learn how I did it.



STEP 1: Creating a bending template



1. I used this total view printed on normal paper to determine the dimensions of the H-beam. Photo courtesy of Robert Farkas, found on rrpicturearchives.net.

As a prototype for my H-beam, I chose the turntable at the former Akron, Canton & Youngstown Railroad (AC&Y) Brittain Yard in Akron OH. I found photographs on the Internet showing the H-beam as a total view. I used a side view to measure the H-beam, and then calculated the proper scale dimensions.

My values were:

Full length of motive power on photo: 10.9"

Width of H-Beam on photo: 0.2"

Prototype length of motive power:

H-20-44: 51' or 612"

Calculated H-Beam width: $612'' / 10.9'' \times 0.2'' = 11.22''$ or 0.070" in N scale

I used Evergreen Scale Models #281 for the H-beam, as it was 0.060" width (flange-to-flange).

Advertisement

END OF TRAIN DEVICE

FLASH CIRCUIT
UNDER TRUCK



TRACK
POWERED

READY TO RUN!

**Bright Red
Flashing Light!**

Installs in minutes
with no freight car
modification required!

RE RING
ENGINEERING

Patented Technology - US Patent 7,549,609

Does not affect Load!

↓ Car without Load ↓

↓ Car with Load ↓



For video
and more
click here!



STEP 1: Creating a bending template *Continued ...*

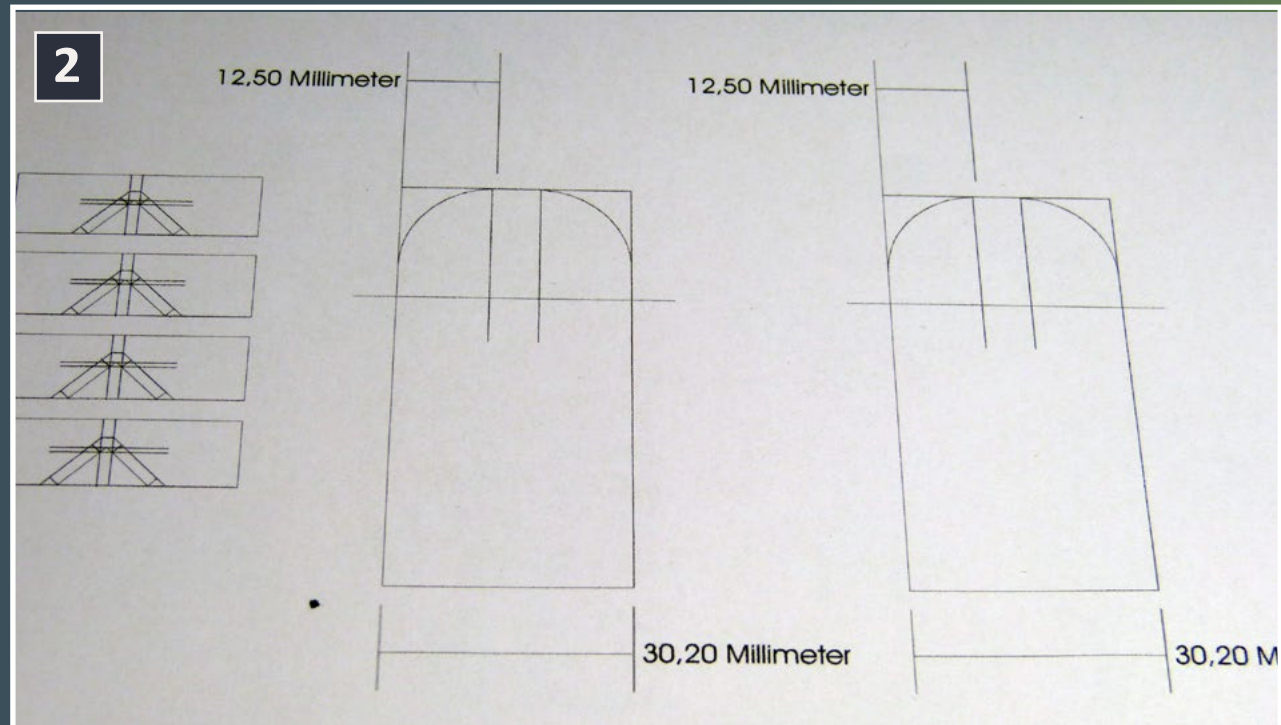

2. Arch drawing, printed on self-adhesive paper.

Knowing the final width of the turntable bridge, I fired-up my computer to create a drawing of the arch. I drew only the inner width of the arch to use as a bending template.

STEP 1: Creating a bending template *Continued ...*

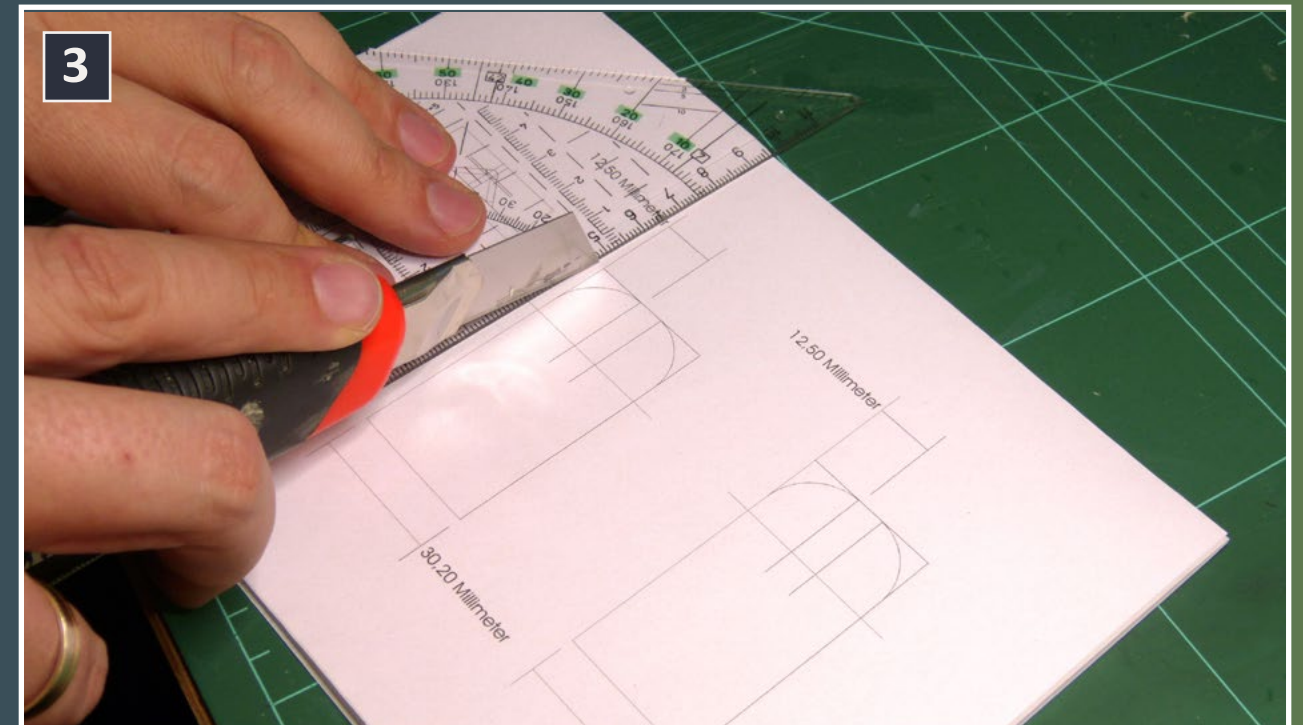

3. I used a sharp knife and a ruler to cut out the arch template. Then I removed the backing paper and affixed the paper to a piece of styrene.

After printing, I roughly cut out the template and glued it to a piece of 0.040" styrene. Then I used scissors to cut the styrene piece to the final shape.



4. The final arch template. I used scissors to cut the styrene exactly along the printed line.

STEP 1: Creating a bending template *Continued ...*



5. The arch template in comparison with a standard N scale track gauge. The top radius fits inside the profile – so motive power will fit beneath the arch.

STEP 2: Pumping iron – bending styrene

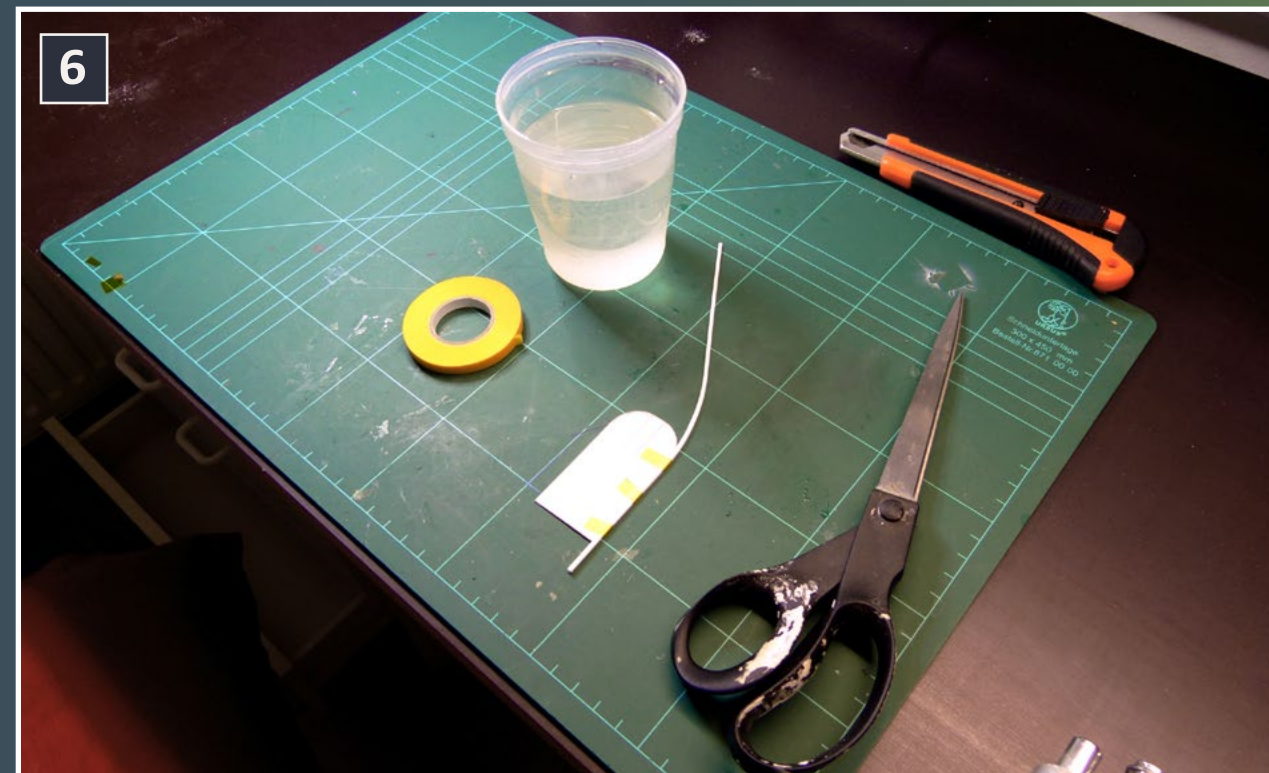

6. I attached the styrene H-beam to the template using masking tape on one side. Bending the beam around the template several times before dipping it into boiling water helped shape it.

With the template done, I began to bend the H-beam. The prototype H-beam is bent over its flanges. This is much easier than bending over the web. The tricky part is to convince the styrene beam to stay in its rounded shape, as it tends to flip back to its original shape. To succeed with this task, it is good to know that styrene has a weakening point at approximately 176 °F (80°C), depending on its composition and material strength.

STEP 2: Pumping iron – bending styrene *Continued ...*

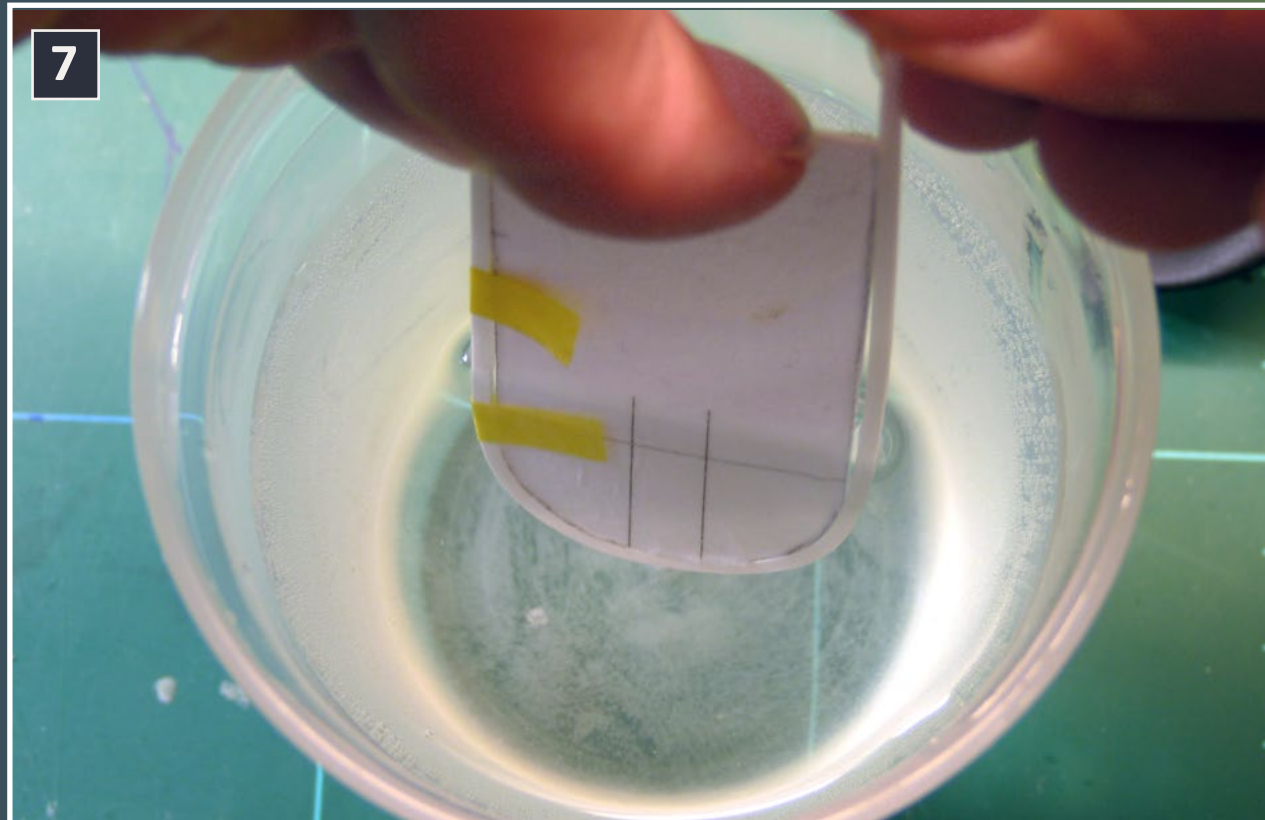

7. I dipped the beam into the boiling water for about a minute, then pulled the loose side around the template to bring the beam into shape until it cooled.

After several disappointing attempts with my wife's hair dryer – the hair dryer finally quit its function and the styrene arch flipped back to almost a straight – I was on the lookout for something reliable. I tried water – simple boiling water – and it worked. So I put aside the test strip and grabbed the real beam.

STEP 2: Pumping iron – bending styrene *Continued ...*

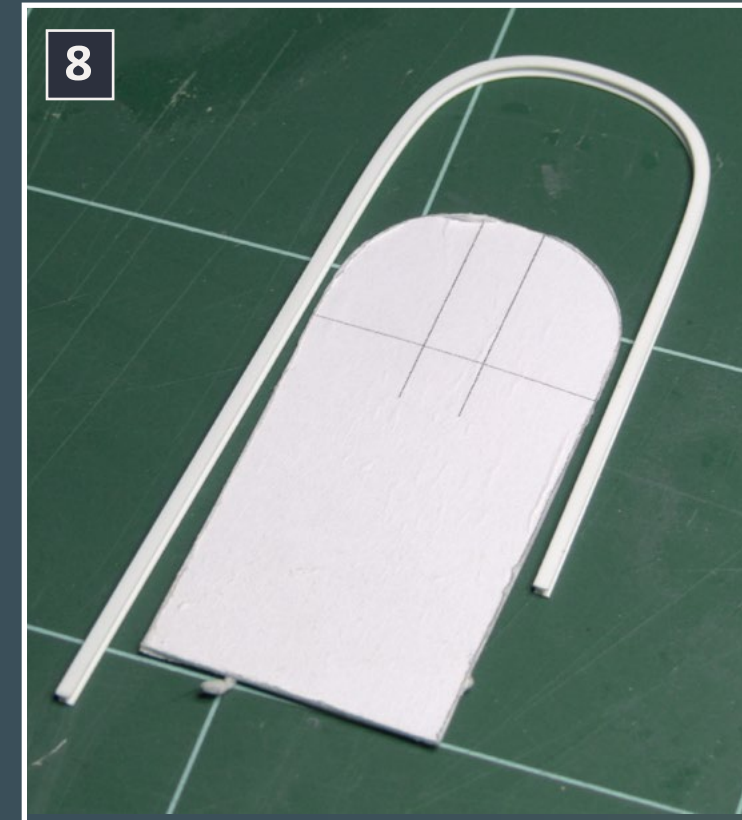

8. After the styrene beam cools, it will stay in its designated shape, and can be easily attached to the turntable bridge without any tension.

First I cut the H-beam roughly to length, and securely attached it to one side of the template with masking tape.

Next I used my fingers to bend the beam around the curve of the template, and pulled it up on the opposing side of the template. With the beam stretched around the template, I dipped it into the hot water for one or two minutes. While in water, I kept on pulling the free end of the beam. When the beam fit snugly around the template, I knew the styrene had softened, so I removed the beam and template from the water, and stretched the beam around the template again with my fingers.

If the loose side of the beam didn't stay close to the template, I repeated the process until the beam kept the desired shape.

STEP 3: Cutting to the right length

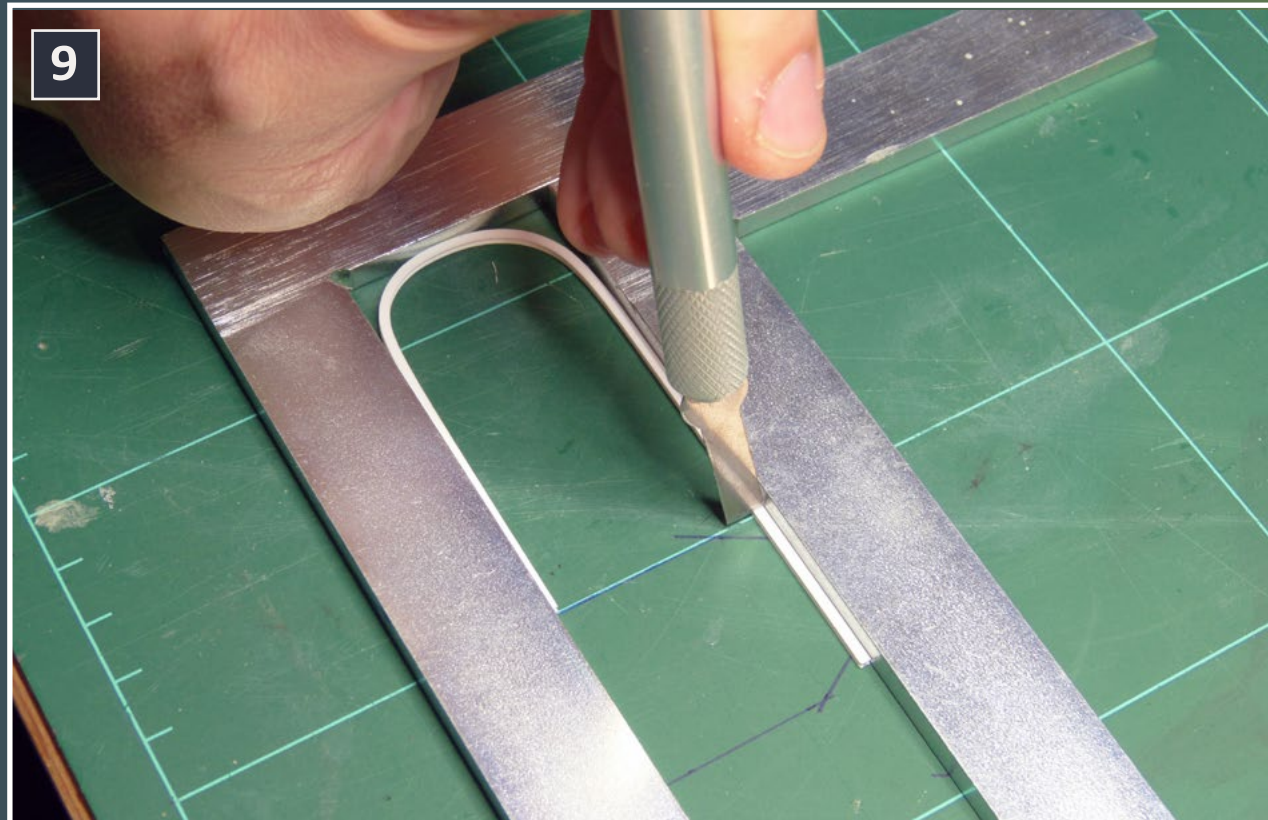

9. I cut the arch to length with a sharp blade.

After the H-beam was bent to its round curved shape, I used a sharp blade to cut off excess length. I used two steel squares to hold the beam in place.

STEP 4: First look



8. Bridge with attached arch, details still to come.

Next I attached the arch to the middle of the turntable bridge using plastic cement and clamps. I glued only one side at a time so I could adjust the position.

STEP 5: Final touches

11. The finished turntable bridge with details. Handrails are made of AWG 28 copper wire using a template and a small soldering iron. The walkway is made from basswood strips.

To finish the arch, I placed an electrical connection box on top of it. I made this box from squares of styrene of various thickness.

The steps are made from AWG 28 copper wire glued to the bridge with cyanoacrylate glue.

I also used a AWG 28 copper wire for the power wire running inside the bridge.

With all details in place, I spray painted the bridge flat black using my airbrush. ☑

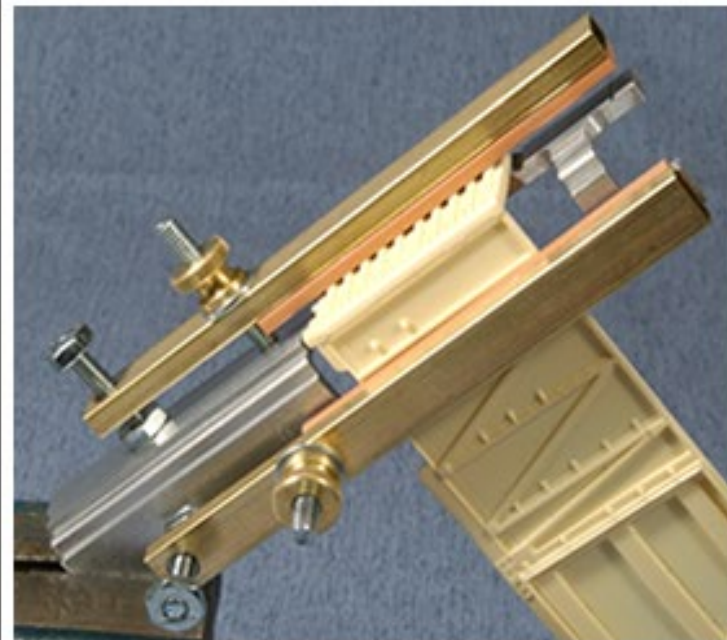
**Combo Right Clamp™**

Combo Right Clamp™
with cast resin boxcar

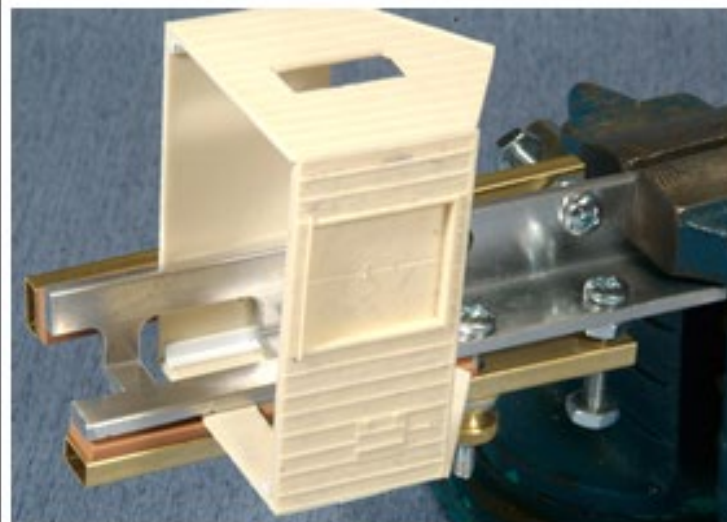

Combo Right Clamp™
with Wolf Design Pump House

**Click here for
all our products ...**

Tools for Modelers

Coffman Graphic Solutions Co.
1500 River Circle, Richmond,
KY 40475-7907



Mike Holly lives in Germany, near Wiesbaden. He got his first trainset at the age of

10, and started two German-themed layouts. After visiting a local model railroad convention a couple of years ago, he got infected by the U.S. model railroad virus.

After moving to a new house, he started the planning process for his first U.S.-themed, proto-freelanced layout, the "Elizabeth Oaks Branch Line." Construction of the layout started in 2011, and today he is planning to extend the layout to add more operation.

Mike has a Bachelor of Engineering degree in Road Design & Construction.

He is married to Nicole, and has a 3-year-old daughter who loves railfanning.





Report: St. Louis 2014 RPM meet

– by John Golden
Photos by the author



The 2014 St. Louis Railroad Prototype Modeler's (RPM) Meet was held on Friday, August 8th and Saturday, August 9th at the Gateway Convention Center in Collinsville, Illinois. The popular two-day event was co-sponsored by the Gateway Division, National Model Railroad Association, and featured clinics, modular layouts, vendors, historical societies, attendee model displays, hands-on weathering seminars, and home layout tours.

1. Overview of the St. Louis RPM Meet, held on August 8-9 at the Gateway Convention Center in Collinsville, Ill.



2. Dave Roeder, left, talks with another attendee. Meeting and learning from fellow modelers is a key part of an RPM event.

“Some 295 modelers from the U.S. and Canada attended the event and brought over 1,300 models for display.”

Some 295 modelers from the U.S. and Canada attended the event and brought over 1,300 models for display. Attendees brought models of all scales, sizes and gauges, including rolling stock, structures, non-revenue equipment, modules, vehicles, and other equipment related to prototype railroad modeling for display and discussion.

There are no contests at St. Louis RPM; instead, attendees bring models to share their best work, demonstrate their techniques and new ideas, show work in progress, and discuss the prototype with friends and fellow modelers.

The St. Louis RPM featured a broad selection of clinics provided by nationally-known figures and local talent. Modeling clinics were provided by Barry Karlberg, Pierre Oliver, Rob Adams, Dave Schroedle, Dave Roeder, Nelson Moyer, Bruce Smith, and Mike Cougill.

In addition, David Lehlbach of Tangent Scale Models provided a clinic on Tangent’s new Dry-Flo covered hoppers, and Ed Hawkins covered ACF Type 27 ICC-103A/103B acid tank cars and prepped the audience for a forthcoming series of HO scale models.

Also, Tim VanMersbergen presented “Forty-foot Box Cars of the 1970s” and Brian Banna – the well-known diesel modeler – presented a 90-minute clinic on modeling Missouri Pacific SD40-2 number 3320. Brian showed the model in the clinic



3. Bruce Smith, left, from Auburn, Alabama, reviews photos with another researcher. Bruce was one of the meet’s key speakers and discussed “Modeling Maintenance of Way Rolling Stock”.

4. Charlie Duckworth of Omaha, Nebraska brought MP 1112, a drover’s caboose built from an American Model Builder’s kit. Charlie detailed the construction process online at: mopac.org/index.php/modeling/60-caboose.



5. Some of Brian Banna's exquisitely detailed locomotives.

room along with a number of other exquisitely-finished locomotives [5].

The 2014 event also included a number of hands-on workstations. Attendees were able to try their hand with the latest airbrushes, acrylic paint and products from Badger Airbrush with the Badger company representatives on site. Two hands-on weathering stations were also featured so modelers could try weathering their own models with both paint and powders.

Dave Schroedle of Protoweathering.com demonstrated weathering using chalks and powders and provided hands-on learning both days. For more information, check out Dave's website at protomodeler.com/index.php?/page/index.html.

Also in attendance was Jeremy St. Peter with The Weathering Shop. The Weathering Shop crew uses St. Louis RPM as their annual gathering, and a dozen Weathering Shop guys from around the country descended on the event to demonstrate and teach weathering [6], and also to display and sell their



6. The Weathering Shop Guys in Action. TWS guys bring models, teach weathering, and perform weathering at St. Louis using a lot of different techniques.



7. The Weathering Shop guys can take any model and make it a work of art. Check out their amazing online resource at: theweatheringshop.com.



8. Clark Propst's Allied Mills layout in action. The lightweight layout is designed to be placed on a standard 8 x 2-1/2-foot table for easy viewing and operating. It was the hit of the meet.

artwork. These guys bring a lot of energy and excitement to the every meet.

A new feature this year was provided by Clark Propst of Mason City, Iowa. Clark brought an eight-foot table-top layout specifically designed to be displayed and operated at RPM meets. Clark built the lightweight layout in just eight months and designed it to fit on just one eight-foot folding table with an eight-foot "tail track" for staging and switching.

It's not free-lanced either – the layout depicts the actual Allied Mills/Wayne's Feed mill on the Milwaukee Road in Mason City, circa 1958. Clark designed short, 30-minute op sessions and about a dozen attendees took the challenge on Friday and Saturday.

There were 85 tables of hand-picked vendors who attended the meet, including Tangent Scale Models, Cannon, Moloco,



9. Pierre Oliver, left, of Yarmouth Scale Models, attended from Canada, selling steam-era freight car kits and parts.



10. Gary Roe, right, and Allen Reuter, left, of the Wabash Historical Society. The Wabash HS was one of 12 historical societies present, and provided books, magazines, drawings, track charts, records, and other information of benefit to the prototype modeler.



11. David Ward brought his new company, ProtoLoads, to St. Louis. David constructs and sells prototypical loads for freight cars and did a booming business at the meet. He builds open loads in numerous scales, and had HO, S and O scale examples available.

Plano, Yarmouth Model Works, Rails Unlimited, Funaro & Camerlengo, Railshop Ltd., ICG Custom Decals, Badger Airbrush, Protocraft, Stan Rydarowicz Models, Moon Dog Railcars, Fox Valley Models, Lake Junction Models, Norris Hobbies, Q Connection, Spring Creek Model Trains, ProtoLoads, Mask Island Decals, OST Publications, Weathering Solutions, Motrak Models, Iowa Scaled Engineering, and others.

Photo dealers – a specialty at RPM meets providing views of specific engines, rolling stock and scenes – included Big Four Graphics, Bob's Photos, Mike Gruber Photos, and Ed Stoll Photographs. Joe Collias was also on hand selling his original photographs taken in St. Louis and around the Midwest from the 1940s and 50s.



12. Ben Bartlett attended from Brevard, NC, and brought a large display of Erie Lackawanna buildings and rolling stock for display.



13. An overview of the fully-filled model display tables. At last count on Friday, over 1,300 models were on display, all brought by attendees. There are no modeling contests at St. Louis RPM; instead, modelers are encouraged to bring their best work for display and discussion. Many in-progress models were also on display so other modelers can see how they are being built.

St. Louis RPM is also fortunate to host the largest annual gathering of railroad historical societies in the nation. Railroad historical societies provided photos, drawings, company records, books, magazines, models and more to help modelers and writers research specific prototypes.

This year's meet included historical societies representing the New York Central, Wabash, Milwaukee Road, Missouri Pacific, Chicago & Eastern Illinois, Gulf, Mobile & Ohio, Nickel Plate, Pennsylvania, Chicago & Northwestern, Illinois Terminal, and Terminal RR Association railroads.

The Barriger National Railroad Library was also on hand this year, advertising the Barriger Library's famous photo and artifact collection available to the public at the University of Missouri, St. Louis (UMSL) downtown. The Barriger Library website is umsl.edu/mercantile/barriger/index.html, and



14. These steam-to-transition era freight cars are the work of Brian Flynn of O'Fallon, MO.



15. Mike Budde is the man who brought "the gremlins" to the meet – Gremlin models, that is. Mike is well known in St. Louis for his masterfully-detailed auto racks and more.

16. This red Ford truck is the work of Ted Richardson of Libertyville, IL.

photos from John Barriger's personal collection are now online at: flickr.com/photos/barrigerlibrary/sets.

You can find more information on the 2014 St. Louis RPM Meet at: home.mindspring.com/~icg/rpm/stlrpm.htm. The official St. Louis RPM photo site can be found at: pbase.com/golden1014, and David Hussey has photos posted at: pbase.com/dh30973/stlouis14&page=all.

For more information on the NMRA's Gateway Division, please visit gatewaynmra.org/default.htm.

Planning for the 2015 St. Louis RPM Meet, the ninth annual gathering, is already underway. Exact dates that best fit the modeling community and the Gateway Division are still to be determined but make plans to attend in late July or early August, 2015.

If you'd like to be a vendor or bring your historical society or modular layout, or if you want more information, please don't hesitate to contact the hosts, John Golden at Golden1014@yahoo.com or Lonnie Bathurst at bathurst@litchfieldil.com.

This report was written by John Golden. The St. Louis RPM is hosted by Dan Kohlberg, Lonnie Bathurst, and John Golden. ☑



17. These IC models are the work of John Kohlberg of Minneapolis, MN. The postcard in front is one of the crazy St. Louis RPM ads sent to modelers around the country by John's brother Dan Kohlberg, one of the hosts of the meet.

18. The St. Louis RPM is all about meeting old friends and making new ones. Here, from left to right, is Dave Lehlbach, Nick Molo, Tom Mann and John Kohlberg.



Get the first 50 issues of
**Model Railroad
Hobbyist magazine™**

On a data DVD for \$10!

Save
yourself
endless
hours of
downloading

Send me one!

(Sold by Model Trains Video)

Includes a coupon
good for \$20 off on
TrainMasters TV

Over 5000
pages of
how-to
information
on model
railroading



USATC S100 side-tank steamer

HO loco by Hornby/Rivarossi

– by the MRH staff
Photos and video by
Ken Patterson



1. Rivarossi's new 0-6-0 side tank engine closely replicates locomotives built for WW II service.

This 0-6-0 side-tank HO scale steam locomotive by Rivarossi represents a United States Army Transportation Corps (USATC) S100 class designed for switching duties in Europe and North Africa during World War II. In later years, the S100 class locos also were used in Austria, Great Britain, France, Greece, Italy, Yugoslavia, Palestine, Iraq, Iran, Israel, and China.

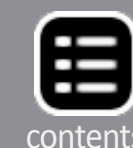

This new release incorporates all-new tooling with a diecast boiler, a five-pole can motor with flywheels, NMRA RP-25 profile wheels, knuckle couplers, and is DCC-ready. The model is available lettered for U.S. Army Transportation Corps, Granite Rock Co., E.J. Lavino, and Albemarle Paper Manufacturing. MSRP is \$219.99.

In 1942, the USATC ordered 382 S100s from Davenport Locomotive Works of Iowa, H. K. Porter Inc. of Pittsburgh, PA and Vulcan Iron Works of Wilkes-Barre, PA. The U.S. Army shipped these locos to Great Britain in 1943. They were stored in the UK until being shipped to continental Europe after D-Day.

With the end of the war, the engines were spread around the world. The French National Railway Company bought 77 S100s and designated them class O30TU. The Yugoslav State Railways bought many S100s and designated them class 62. In the 1950s, copies were built locally, bringing the number of class 62 locos to 129. The Hellenic State Railways in Greece acquired 20 S100s and designated them class delta-alpha. The Austrian state railway acquired 10 as their class 989, and Italy acquired four and designated them class 831.

The Oranje-Nassau Mijnen, a coal mining company in The Netherlands acquired two S100s (USATC 4389 and 1948) and numbered them ON-26 (Davenport 2533) and ON-27 (Davenport 2513) respectively. The ON-26 survived the scrapyards and was sold to the museum railway Stoomtrein Goes-Borsele.

The Southern Railway in Great Britain bought 15 S100s (14 for operational use and one for spare parts) and designated them as the USA Class. Other S100s entered British industrial use with the National Coal Board, Longmoor Military Railway, Austin Motor Company and others.

China acquired about 20 S100s, designating them class XK2. In 1946, Egyptian State Railways bought eight and numbered them

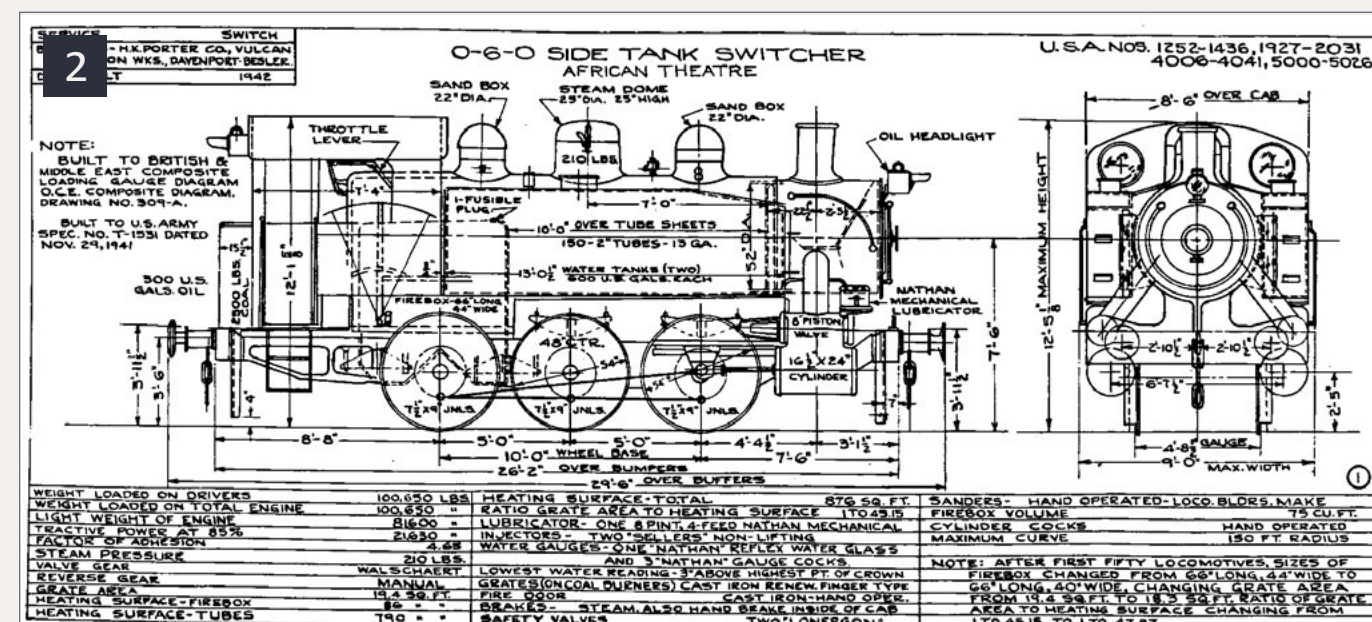

2. Technical plans for the locomotive (available on Wikipedia).

1151–1158. The UK War Department loaned six to Palestine Railways. In 1946 PR bought two of these, both of which subsequently entered the stock of Israel Railways in 1948.

Iraq State Railways bought five, designated them Class SA, and gave them fleet numbers 1211-1215. All were Davenport-built.

More than 100 S100s survive, either preserved, stored, or derelict. Most are in Europe or North America but there are two in China and one in Egypt. Project 62 has an online database at project62.supanet.com/locolocation.htm.

Hornby USA: hornbyamerica.com/products/s-100-0-6-0-us-army-dcc-ready.

Rivarossi: hornbyinternational.com/en/rivarossi/2823-usatc-steam-locomotive-road-number-1948-model-prepared-for-the-use-of-a-sound-decoder.html.

Original design drawing: upload.wikimedia.org/wikipedia/commons/5/53/S100Design.png.

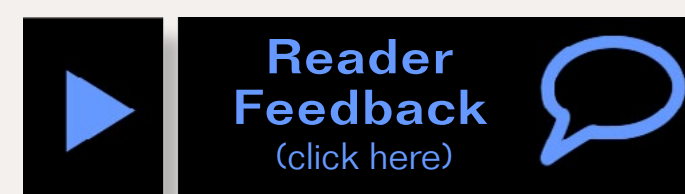

Video on the next page ...



click to play video

Playback problems? [Click to try a different version.](#)



The Amherst Railway Society Railroad Hobby Show

Our 2015 Show will be

January 24 & 25, 2015

Save the dates!

About The Show

Every year late in January or early in February, the Amherst Railway Society holds its Railroad Hobby Show at the Eastern States Exposition Fairgrounds (The home of The Big E) in West Springfield, Massachusetts. More than 25,000 railfans and public attended the Show each of the past three years.

The event features real life railroads and scale model railroads, historical societies, travel agencies, art shows, flea market dealers, importers, manufacturers and photographers. You have to see it to believe it!



**Click
to learn
more ...**





New Clinics are being added daily!!
Check the website for all the latest news!!

34th National Narrow Gauge Convention September 3rd-6th, 2014

Goin' to Kansas City

Come and enjoy the sites and sounds of Kansas City and our fantastic Narrow Gauge community. See what we have to offer and get the creative juices flowing - all while enjoying great food, great people and a great city.

We will have:

- Over 400 Vendor and Manufacturer Tables
- Exciting new Clinics and Clinicians
- 60,000 square foot state-of-the-art convention hall
- Hotel and Convention Center in one location
- Dozens of layouts on the Layout Tour
- Free Wi-fi for all Convention Attendees

CLICK HERE
www.34thnngc.com

GREAT AREA ATTRACTIONS

Union Station, Truman Library, Steam Ship Museum, Power and Light District, the Country Club Plaza and GREAT BBQ are just a few of the things that KC is known for.

REGISTRATION

Attendees can REGISTER ONLINE at www.34thnngc.com
Registration: \$99 (\$114 after June 1, 2014)
Email: registrar@34thnngc.com
Address: 34th NNGC
14633 S. Chalet Dr.
Olathe, KS 66062

EXCITING NEW CONTEST CATEGORY

In addition to all the contest categories that you are used to, there will be a special contest category:
- THE SQUARE FOOTER -
Build anything you want as long as it fits on a 12" x 12" display

CONVENTION HOTEL

Rooms are filling fast...
Check the website for current hotel availability.

We want to see you in KC!!

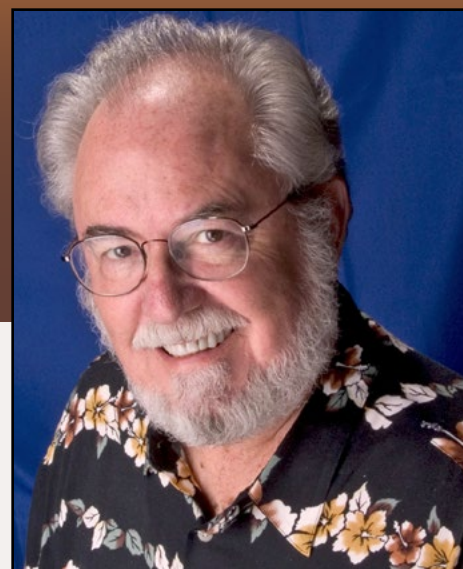
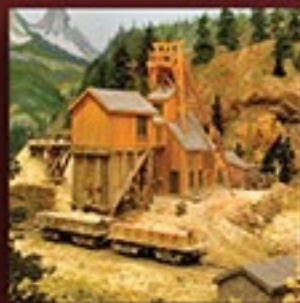
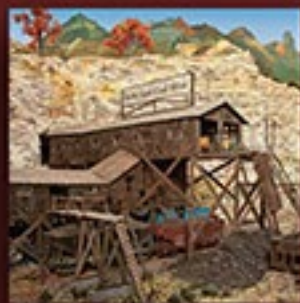
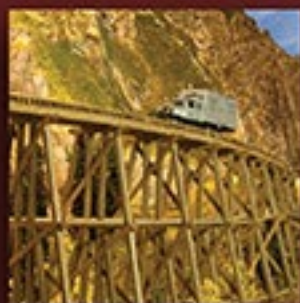

The Old
Yardmaster



September 2014: The latest model railroad products, news & events

by Richard Bale and Jeff Shultz

WGH executives recognized



During the 2014 NMRA National Convention in Cleveland, OH, the board of directors of the World's Greatest Hobby (WGH) presented awards to Bud Reece (far left) and Terry Thompson (blue shirt) in recognition of their numerous contributions to the model railroad industry. The awards were presented by Doug Blaine, president of WGH and vice president of Bachmann Trains.

Bud Reece was a founding officer of WGH and from 2008 to 2013 was USA vice president of the organization. As a senior executive at Bachmann, Reece recognized the benefit of investing in the WGH program for the indirect benefit to sponsors and the long-term growth of model railroading. Reece is currently western sales manager for Bachmann Trains.

Terry Thompson, also a founding officer of WGH, served as its president from 2008 to 2013 and was recognized for reorganizing WGH as a non-profit corporation. He was also instrumental in launching WGH on Tour, a popular public event that has drawn over 1.1 million attendees. Thompson is currently vice president of proprietary products for Walthers ...

C&BT Shops for sale

C&BT Shops, a long-time producer of plastic injection-molded HO scale freight car kits is for sale. The company was established in 1986 by Dick Schweiger who, for health reasons, is interested in selling his business. Seriously interested parties may send inquiries to Schweiger at cbtshops@aol.com or PO Box 647, Igomar, PA 15127 ...

CUSTOM CARS



of Warwick, RI, is celebrating its 20th anniversary with the sale of a custom decorated kit for a

Providence Northern Model Railroad Club
(providencenorthern.org)

of Warwick, RI, is celebrating its

40' AAR steel boxcar. Provided by Accurail, the HO scale model has Dreadnaught ends and Youngstown corrugated doors. Two road numbers are available, at \$18 each. For additional information visit the above website.

NEW PRODUCTS FOR ALL SCALES

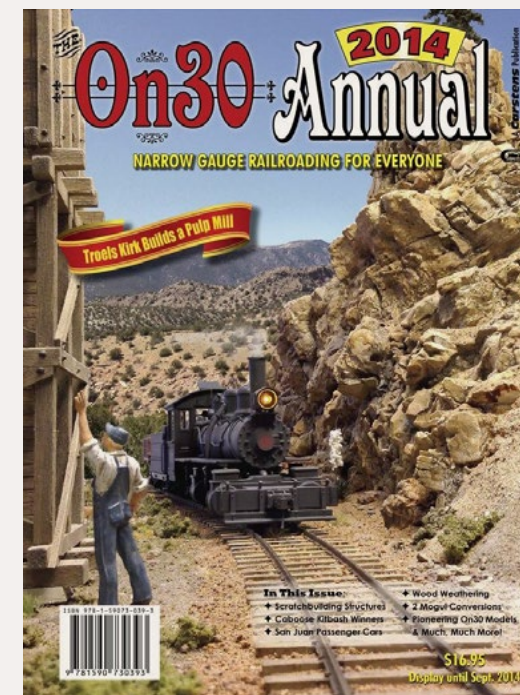

Carstens Publishing (carstensbookstore.com) has released the 2014 edition of its "On30 Annual". The softcover book is available direct from the above website and from selected hobby retailers. The MSRP is \$16.95.

BHI Publications (quickpicbooks.com) has released "Scratchbuilding," a new book that covers the fundamentals of modeling real structures in any scale. The book begins with how and where to research and how to draw plans from a photograph for any scale. Techniques and methods are presented in a non-technical way, including ideas for including features in the final structure that help set it apart from typical models. The book has a list price of \$19.99.

Also new from BHI is a restoration of an original "Pennsylvania Railroad Dining Department Cookbook" that includes employee instructions for dining car service. The 110 page book is full

of recipes, serving instructions, and seasonal modifications. Dining cars on the PRR were known for their high level of quality food ranging from American pancakes to French haute cuisine. The MSRP is \$34.99 plus shipping and handling.

New titles from **Morning Sun Books** (morningsunbooks.com) include *“Rock Island Power”* by Robert Yanosey, *“Milwaukee Through Passenger Service 1966-1977”* co-authored by Greg Stout and John Schulz, and *“West Florida Rails - SCL and SBD 1970-1987”* by Jerry Pinkepank.

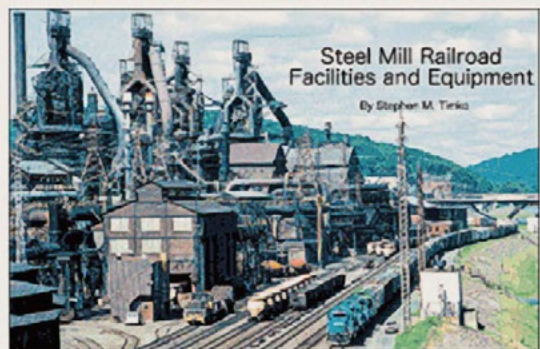
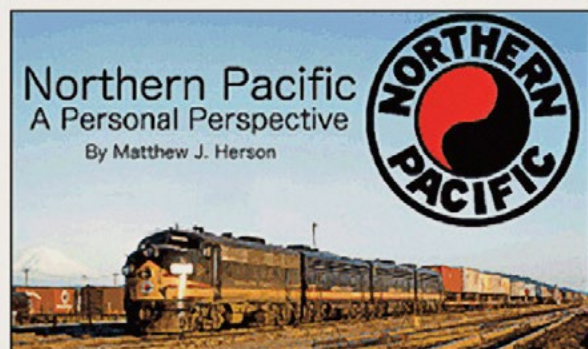
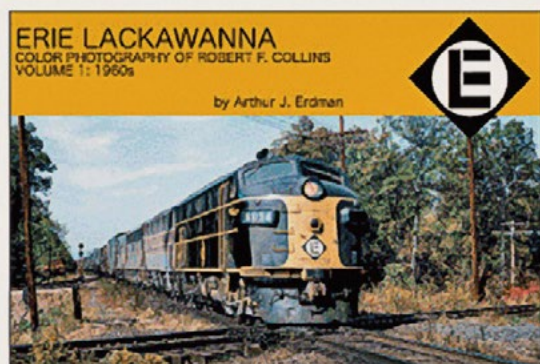
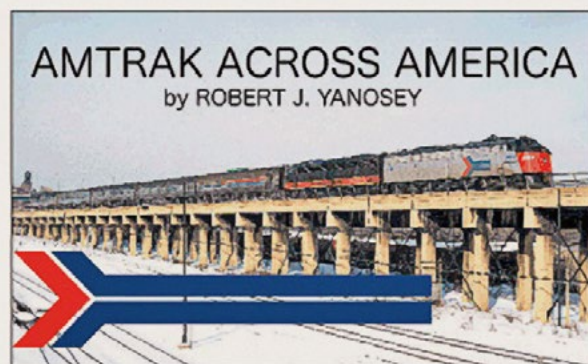

In addition to their traditional print titles, Morning Sun Books has introduced a selection of digital eBooks on Apple iPad. Each eBook will have 250 to 300 high-definition color photographs in landscape format. Historical black and white photos will occasionally be included. The initial release includes the four titles illustrated above. They are available now in the Apple iBooks Store at \$19.99 each. To purchase or for additional information go to morningsunbooks.com/ebooks.html.

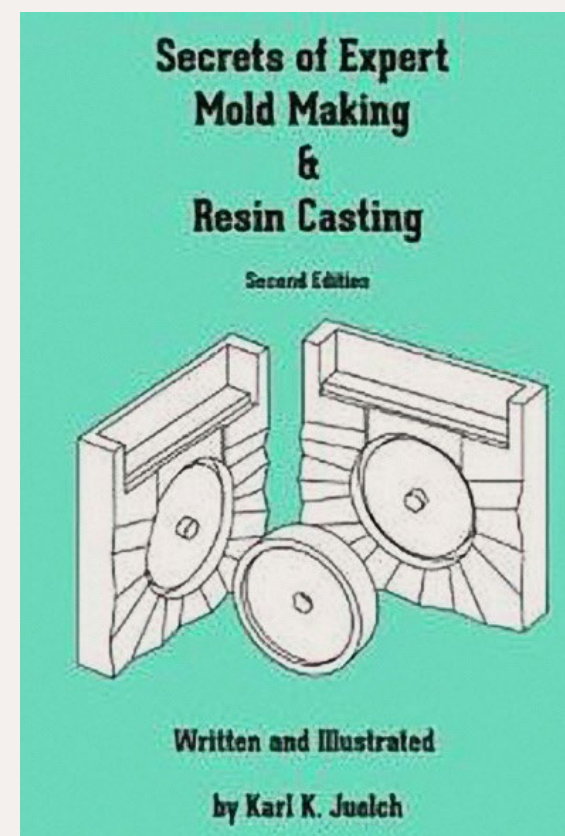

“Secrets of Expert Mold Making and Resin Casting” by Karl Juelch and Jessica Minzner is available in paperback from Amazon for \$17.96. The 120 page, 8.9 x 6 inch book covers how to make professional quality molds using RTV silicone rubber and create precise castings using polyurethane casting material. Over 100 detailed line drawings guide the reader from the basics to advanced procedures. Emphasis is on inexpensive materials and equipment.

Into at: amazon.com/Secrets-Expert-Making-Resin-Casting/dp/1492294942.

O SCALE PRODUCT NEWS



Atlas O (atlaso.com) has scheduled the next release of its 40' GATX Airslide covered

hopper cars for the second quarter of 2015. The ready-to-run model is based on a prototype built by General American Transportation Corporation beginning in 1953 and continuing largely unchanged through 1969. Atlas will offer the car decorated for Bay City Milling, National Starch, Red Wing Milling, Burlington Northern, and Chicago North Western. Three-rail versions of the O scale model will have an MSRP of \$62.95. Two-rail models will list at \$67.95.



Mullet River Works (mulletriverworks.com) is selling a kit for a Great Northern wood boxcar with a steel frame and

truss rods. GN was one of the last major railroads to build truss-rod boxcars. Mullet River's O scale model replicates cars built between 1915 and 1917. Many of the prototypes were rebuilt in 1943 and continued in service during World War II. Some GN cars remained active into the late 1950s. The frame of the model is made from a brass etching and requires some assembly as does the laser-cut wood body. Decals are included. Kit #403221 is priced at \$135.00. The kit includes parts for an AB brake system. Components for a K brake system can be purchased separately from Mullet River.

San Juan Decal (sanjuandecal.com) reports that its 6200 series On3 flat car kit was shipped to customers with a part missing. The striker plates were made without the nut-bolt-washer castings. Also, the wire for the stake pockets was incorrectly stated to be 0.25" wire when the correct dimension is .020". To obtain the correct parts contact Dan Peterson at sanjuandecals@frontier.com or by phone at 952-891-4162.

Uintah Railway Models (facebook.com/pages/Uintah-Railway-Models/1380270688904885) is a new company established to develop On3 and On30 scale models of equipment unique to the namesake railroad including the Uintah's famous 2-6-6-2 number 51, one of the largest narrow gauge locomotives ever built. Current plans call for the production version to be DCC-ready

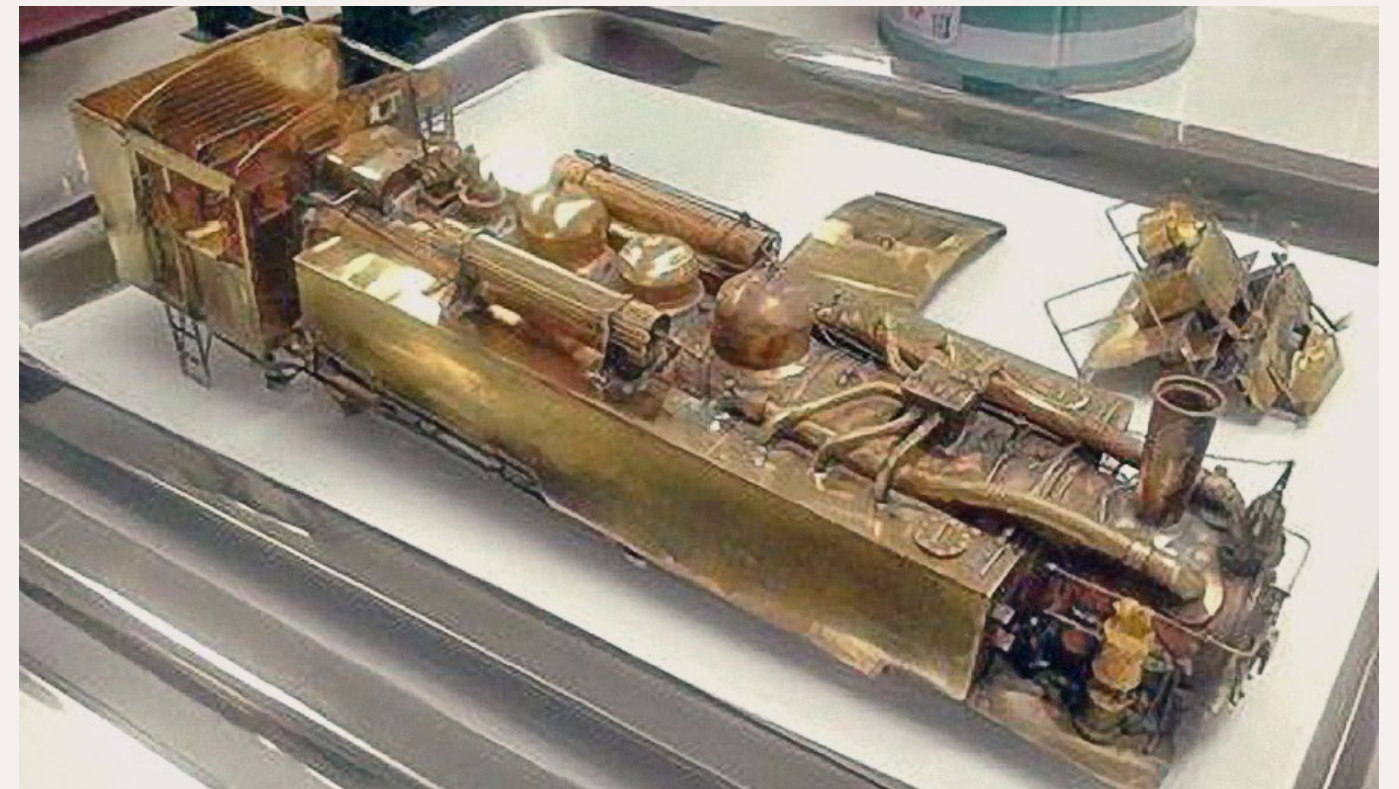

(with compliant pin adapter), lettered, and weathered. A pilot model of the articulated locomotive will be displayed at the National Narrow Gauge Convention to be held in Kansas City, Missouri, early this month. (For convention info visit kansascity2014.com).



Also under development is Uintah Railway caboose #3. Missing from the pilot model shown here are the two windows at each end of the car. Establishment of a permanent website for Uintah Railway Models is pending.

Next month **Woodland Scenics** (woodlandscenics.com) is scheduled to release two new O scale buildings for its Built & Ready Landmark Structure series. Sully's Tavern features a



weathered exterior, LED interior lighting, and printed signs and window treatment. The MSRP is \$139.99.

Also coming from Woodland Scenics is J. Frank's IGA Grocery Store. The fully assembled and weathered O scale structure features large display windows with awnings, a gum ball machine and kiddie

ride, lighted interior, and a loading dock at the rear with a hand dolly. The MSRP is \$149.99.

HO SCALE PRODUCT NEWS



70-ton offset-side triple-bay hopper car shown here. It is available in a special two-pack at an MSRP of \$32.98.

Accurail (accu-rail.com) has released several HO scale kits with new road names including the Lackawanna



Additional kits for open hoppers include USRA 55-ton twin-bay cars decorated for Lehigh Valley and Santa Fe.



Accurail has released a kit for a Bessemer & Lake Erie 40' AAR steel boxcar with Dreadnaught ends and Youngstown sliding doors. The HO scale model is based on a car built in 1946 and repainted in 1958.



Also available now is a three-pack of kits for Great Northern 40' wood refrigerator cars.



Accurail is offering a kit for a modern 50' welded steel boxcar with exterior posts at an MSRP of \$16.98. All Accurail kits

include trucks and couplers. Visit the above website for more pricing information.

Athearn (athearn.com) has scheduled the next production run of its Genesis series GP40-2 for release in March, 2015. In addition to the CSX/YN2 version shown here, road names for the



HO scale locomotives in this run will be Vermont Railway, Boston & Maine, Chessie/WM, and Frisco.

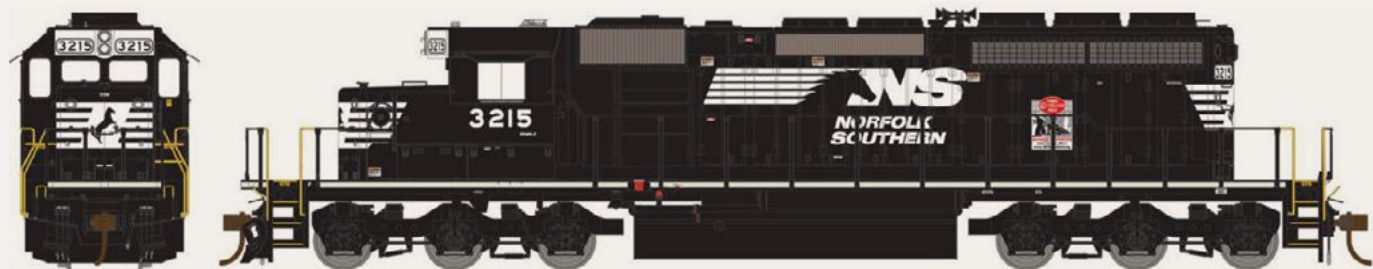

Also due from Athearn in March is a special Norfolk Southern SD40-2 displaying the logo of the National Model Railroad Association. The prototype locomotive #3215 was parked near the 2014 National Convention in Cleveland, Ohio earlier this summer. The Ready-to-Roll DC model will be DCC-ready using Athearn's Quick Plug™ technology. The MSRP will be \$139.98.



Additional SD40-2 locomotives in the March release will be decorated for Santa Fe, Illinois Central Gulf, CSX/YN3, and Kansas City Southern. The MSRP will be \$134.98.

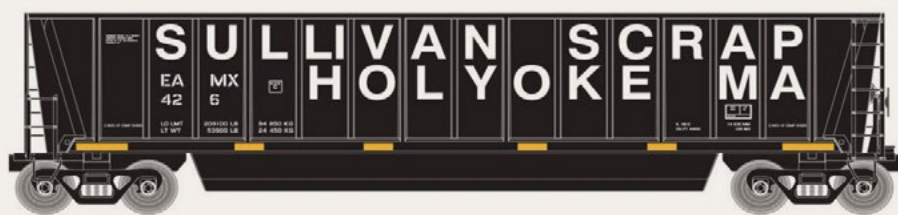

Athearn is scheduling another release of

Berwick bathtub gondolas in March. Road names will include UFIX, SRPX, Union Pacific, CPR, UNPX, and EAMX-Sullivan Scrap. The HO scale Ready-to-Roll models will be available in singles as well as in two 3-packs for a total of 10 numbers for each road name. An undecorated model is also in the release.



Athearn has scheduled another production run of its ACF 2970 cu. ft. covered hopper for release in

March. The HO scale Ready-to-Roll model will feature a photo-etched roofwalk, round or trough hatches as appropriate to the prototype road, separately applied grab irons and steps, and screw mounted trucks with machined metal wheelsets. In addition to the MP-TP scheme shown here, road names will be Union Pacific (RI repaint), Great Northern, BNSF, BSMX, and ACFX. The MSRP will be \$39.98.

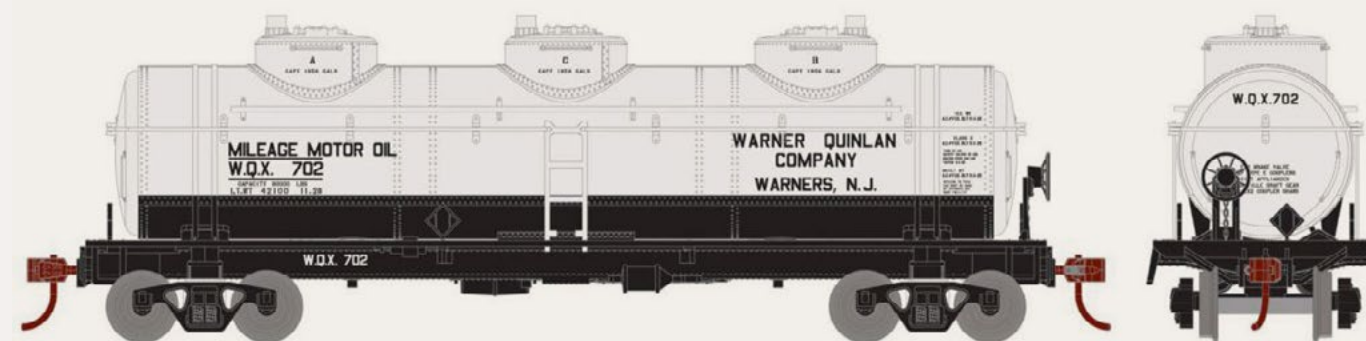

The March release includes Athearn's venerable triple-dome tank car decorated for Rohm & Haas, National Distributing, East Jersey Railroad, GATX-DuPont, NATX-De Soto Chemical, and Warner Quinlan as shown here. The HO scale Ready-to-Roll model will have an MSRP of \$26.98.



Several new versions of an HO scale yard tractor will be included in the March release. Features include photo-etched steps and rear deck, adjustable 5th wheel, rubber tires, and clear window glazing. In addition to the safety-yellow with white striped bumper shown here, decorating schemes will include UPS, white or yellow with striped bumper, and white or yellow with black bumper. The MSRP will be \$19.98 each.

decorated for Bethlehem Steel, US Steel, US Steel Geneva Works, AK Steel, Armco Steel, Nucor, Union Railroad, CSIX-California Steel Industries, and Republic Steel as shown here. The model will have an MSRP of \$36.95. An undecorated version will list at \$29.95.

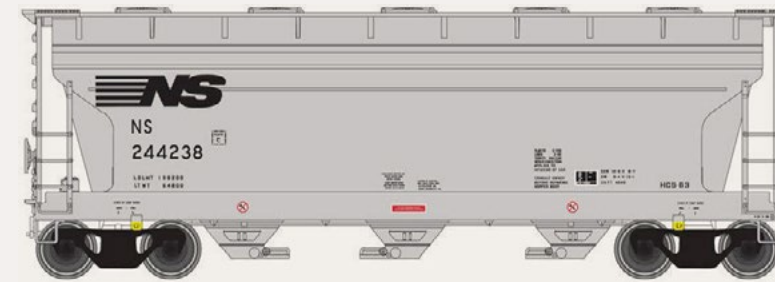

Atlas has scheduled a first quarter release for a Trainman series ACF 3560 cu. ft. Center-Flow covered hopper. New road numbers will be available

for ACFX and Norchem cars. New paint schemes will include Gardiner Inc., Niagara/Wisconsin, Southern Railway, and Norfolk Southern.



Atlas (atlasrr.com) will release its HO scale GP39-2 during the first quarter

of 2015. The Trainman series model will have separately applied hand rails and end railings. Location dimples are provided for modelers wishing to install grab irons. Road names will be Union Pacific, BNSF (bold heritage scheme), Copper Basin Railway, Santa Fe (Kodachrome scheme) and Twin Cities & Western.



Atlas has scheduled another release of its popular Trainman series steel caboose for the first quarter of 2015. The HO scale model is based on an all-steel car Magor built

for the Chesapeake & Ohio in 1937. The ready-to-run model features clear window inserts and separately applied side railings. In addition to Chesapeake & Ohio, road names will include Santa Fe, Union Pacific, Algoma Central, Conrail (MoW gray), Family Lines-SCL, Lehigh & New England, Monon, Norfolk Southern, and Union Railroad. The MSRP will be \$27.95 with an undecorated version having a list price of \$22.95.



Also scheduled for release early next year is an Atlas Master series 42' steel

coil car with fishbelly side sills. Based on a prototype launched in the 1960s, the HO scale ready-to-run model will be available

Bachmann Trains (bachmanntrains.com) is selling an HO scale GP35 diesel locomotive with factory installed DCC. The ready-to-run model is available decorated for Erie Lackawanna and Frisco.



Bachmann's latest HO scale vehicles include a 1950-60s era truck with two piggyback trailers decorated with railroad road

names. They include Southern Pacific, Santa Fe, Canadian Pacific, and Boston & Maine.

Also new from Bachmann is code 100 HO scale nickel-silver flex track. The track comes in 36" sections and features black ABS molded low-profile wood-grain ties with tie plates and spike heads. The track is available in boxes of 25 sections (total 75 feet) at an MSRP of \$199.00.

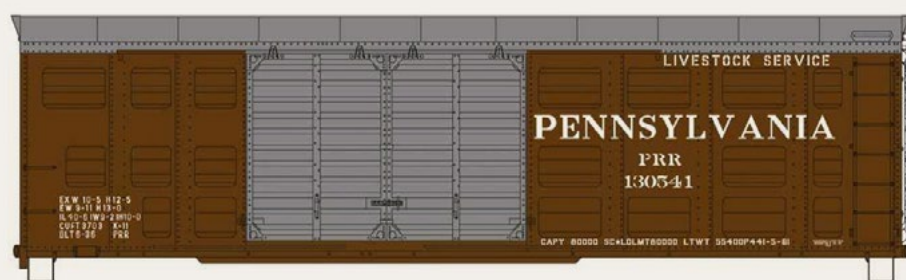

Bowser (bowser-trains.com) is scheduled to release three new body types in its ready-to-run

Executive series in January. They include a Pennsylvania Railroad class K11 stock car with either a brown roof, or as shown here with a silver roof.

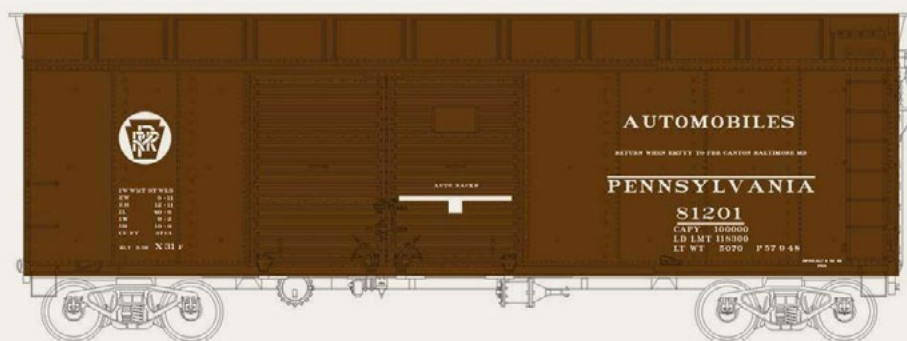

Also in the production run are PRR class X31F steel boxcars with turtle-back roofs. Lettering schemes will

include circle keystone logos as shown here as well as plain and shadow keystones.



Buy War Bonds slogan.

PRR class X31a double-door boxcars will be offered with circle keystone, shadow keystone, and circle keystone with



The X31a will also be available decorated for Duluth, South Shore & Atlantic; Spokane, Portland & Seattle; Norfolk &

Western; and Seaboard. All of the Bowser models mentioned will have an MSRP of \$24.95.

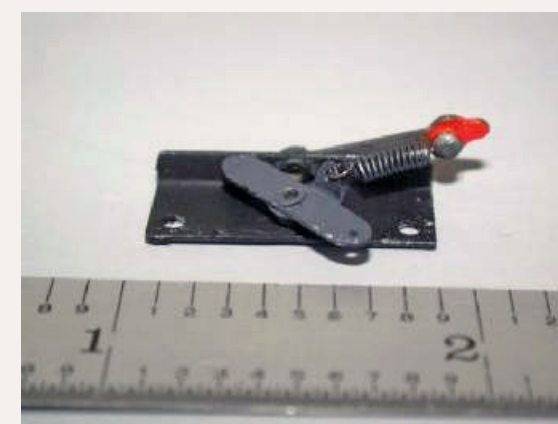

Bitter Creek Models (bitter-creekmodels.com) is selling an all-metal manual ground throw. It is designed for HO scale but is suitable for any application that will operate with a 3/8-inch point throw. The over-center spring action locks the switch point

firmly in each direction. Throw rods and mounting screws are included. The MSRP is \$9.95 each.

Brass Car Sides (brasscarsides.com) has introduced two new etched brass passenger car sides for HO scale Great Northern cars. They include a GN 82' rebuilt baggage-express-mail

storage cars (GN 308-313 and 200-207) with four doors (item #173-80), and GN Mid-Century Empire Builder Pullman-Standard 48-seat coaches with original full skirting (GN1215-1218, 1221-1232, CB&Q 1219-1220, SP&S 350) (item #173-81). For complete details contact Dennis Henry at dennis@dennishenry.com.



ExactRail (exactrail.com) has introduced an HO scale model of a 42' Union Pacific flat car. The new model replicates class F-50-15 cars the UP built in 1951 using one-piece under-frames supplied by General Steel Casting Corporation. The HO scale Platinum series model comes with a Royal F brake regulator appliance and brake wheel mechanism, Kadee #158 couplers, and a laser-etched wood deck to be installed by the modeler. A video showing the installation can be viewed at youtube.com/watch?v=pkDoUNFU2ik. The model comes in three Union Pacific paint schemes including 1951 as-delivered with yellow lettering (above, in 12 road numbers), 1974 repaint with white lettering (nine road numbers), and MOW green (three road numbers in individual paint schemes). The model comes with 50-ton Barber plain bearing trucks or 70-ton Barber roller bearing trucks as appropriate to the era and paint scheme. This 42' car is in addition to the two 53' 6" flats ExactRail announced last month. For information on the longer cars visit mrhpub.com/2014-08-aug/land/#151.



Con-Cor International (con-cor.com) will soon release several new HO scale

containers. The run will include five variations of the Dole Bobby Banana scheme applied to 40' refrigerated containers.



An ISO HI-Cube 45' container will be available decorated for P&O Ferrymasters,

Hyundai, Evergreen, and Maersk Sealand as shown here.



Also due soon is a 53' riveted-side container decorated for Sears, Ferromex, Fedex

MultiModal, Hub Group (red), and Hub group (green). All of the HO scale containers mentioned here will also be available undecorated. Pricing and other details are available at the above website.



Fos Scale Models (foslimited.com) has introduced a new HO scale craftsman structure model named Bernard Tractor Supply. The kit includes laser-cut clapboard siding, board-by-board construction, laser-cut doors, and color

graphics including a special roof sign. Additional detail parts include Tichy windows and corrugated and rolled roofing material. When assembled the structure has a footprint of approximately 6 x 6.5 inches. Scenery items, figures, tractor and other vehicles in the illustration are not included in the kit.



Funaro & Camerelengo (fandckits.com)

is selling a resin kit for an HO scale model of a Rutland 36' dou-

ble-sheathed wood boxcar. The kit consists of a one-piece body casting, detail parts, and appropriate decals with the Route of the Whippet slogan. MSRP is \$44.99.



InterMountain Railway (intermountain-railway.com)

has scheduled

the next release of its HO scale U18B diesel locomotive for March or April, 2015. The ready-to-run model will have etched metal details, road-specific body and cab configurations, and Blomberg or General Electric trucks as appropriate to the prototype road being modeled. Road names will be Maine Central-Guilford, Providence & Worcester, Ferrocarriles Nacionales de Mexico, SCL-Seaboard System, CSX-MoW, and Niagara & Western New York.



Additional models coming from InterMountain next spring are Maxi IV 3-unit articulated cars with 53' wells. Road names for the HO scale ready-to-run models will be BRAN-Pacer Stacktrain, BNSF, DTTX (ex Bran-Pacer), MCER-Massachusetts Central, and WRWX-Providence & Worcester. Also DTTX-TTX paint, Northwest Container, DTTX (ex WRWK), AOK (ex Northwest Container), and AOK- Arkansas-Oklahoma. Visit the above website for additional information including pricing.



Here is an early look at the 2014 Christmas Car coming later this year from **Kadee** (kadee.com). The HO scale ready-to-

run model will be based on Kadee's PS-2 twin-bay covered hopper. The MSRP will be \$41.95.



Also under development at Kadee is a 40' Chesapeake & Ohio steel boxcar with 8' Youngstown doors and Pullman-Standard dart-naught ends. The prototype shown was built in 1951 and repainted in 1967. Kadee

has scheduled a release date in October for the HO scale ready-to-run model.



Kadee has scheduled a November release for this 40' PS-1 boxcar decorated for the Texas Mexican Railway. The car has Pullman-Standard 8' six-panel doors and P-S

dartnaught ends.



Also coming in November is a 40' Baltimore & Ohio boxcar with 6' Youngstown corrugated doors. Pricing information is available at the above website.

tion is available at the above website.



Micro-Mark (micromark.com) is selling a Velleman model K8200 3D printer at \$724.95. It is intended for use by intermediate to experienced craftsmen. The printer creates objects up to 7.87 x 7.87 x 7.87 inches by laying down (printing) multiple micro-thin layers of melted plastic less than .010 inch thick. The system uses FFF (fused filament

fabrication) technology for 3 mm PLA and ABS filament. It has a heated build-platform to minimize warp. The extrusion nozzle measures 0.5 mm. The K8200 incorporates electronic components, an aluminum frame, linear ball bearings, precision step

motors, and some molded plastic parts. Visit the above website for complete specifications. A video of the K8200 in operation can be viewed at k8200.eu/home.



Monster Model Works (monstermodelworks.com) has an HO scale kit for a Mining Fan House. This and similar structures housed a large fan that forced air down into the mine to help clear the air for miners working underground. The design of the kit is based on

drawings Ron Pearson created of the Robertsdale Fan House Rockhill #5.

The concrete block walls are composed of 3D engraved basswood sheets using photos of real concrete block. Other components include peel 'n stick screen frames, door, and asphalt shingles, and special screen material. The doors and windows are laser-cut from Lazerboard. The assembled structure has a footprint of 2.89 x 3.5 inches.



Red Caboose is currently selling an X-29 boxcar decorated for three roads: Pennsylvania

Railroad with a circle keystone herald, Chicago Great Western with Corn Belt Route slogan, and Baltimore & Ohio with a capitol dome herald. The HO scale ready-to-run model is fitted with Creco three-panel doors and Dreadnaught ends.



Also available from Red Caboose is an Evans 100-ton steel coil car decorated

for Chesapeake & Ohio, Norfolk & Western, New York Central, Pittsburgh & Lake Erie, and Milwaukee Road. InterMountain Railway is responsible for marketing Red Caboose products. For additional information visit intermountain-railway.com.



Resin Car Works is a new company being launched by Frank Hodina, an accomplished prototype modeler who is perhaps best known for

the dozens of highly-accurate masters he produced for the late Martin Lofton of Sunshine Models. The initial release will be an HO scale resin kit for a Consolidated Chemical Industries Inc., 7,000 gallon acid tank car. Among the road names will be TCWX, SHPX-Du Pont, and Hooker. Hodina's stated goal is to produce accurate HO scale resin car kits that are easy to build and that will actually be built and operated. Additional details on the new line including pricing and a release date are pending.



Walthers (walthers.com) will release a new run of its 50' Airslide twin-bay covered hopper next month. In addition

to the GACX Italgrani scheme shown here, the Mainline series HO scale model will be available decorated for GACX Brooks Candy, GVSR Golden West Services, and CACX Wonder Bread. Each scheme will be available in two road numbers at an MSRP of \$27.98.



New decorating schemes for a 40' 50-ton composite drop-bottom gon-

dola are also scheduled for release next month. The HO scale Mainline series model features a ratchet handbrake and interior detail. The ready-to-run gondola will be available decorated for Great Northern; Chicago, Burlington & Quincy; Missouri Pacific; Pennsylvania Railroad; Union Pacific; and Santa Fe as shown here.



Walthers plans to release a 37' 2890 cu. ft. twin-bay covered hopper with new road names next month. Paint

schemes will be Dakota, Minnesota & Eastern; Conrail; Burlington Northern; and Wisconsin Central. The Mainline series model will have an MSRP of \$24.98.



Walthers has an HO scale drive-in movie complex with the main screen designed to serve as a holder for most 7" tablets including Apple iPad mini, Amazon Kindle Fire, Samsung Galaxy Tab 2.0 and others (sold

separately). In addition to the main screen, other structures in the set include a projection booth/concession stand, drive-through box office, main entrance sign, 24 double speaker stands, and a wooden fence. Visit the above website for pricing and dimensional information on specific tablets. A set of six movie-goer figures is sold separately.



Walthers has announced a new landscaping material named Tear & Plant Grass Mats. The material features two colors of foliage on a flexible base that is said to blend easily with flat or uneven terrain. Each mat can be glued in place as-is or it can be cut or torn into smaller pieces. The material is available in three designs: Summer Meadow, Fall Meadow, and Spring Meadow (above). Each 11 x 17 inch (approximate) sheet has an MSRP of \$21.98.

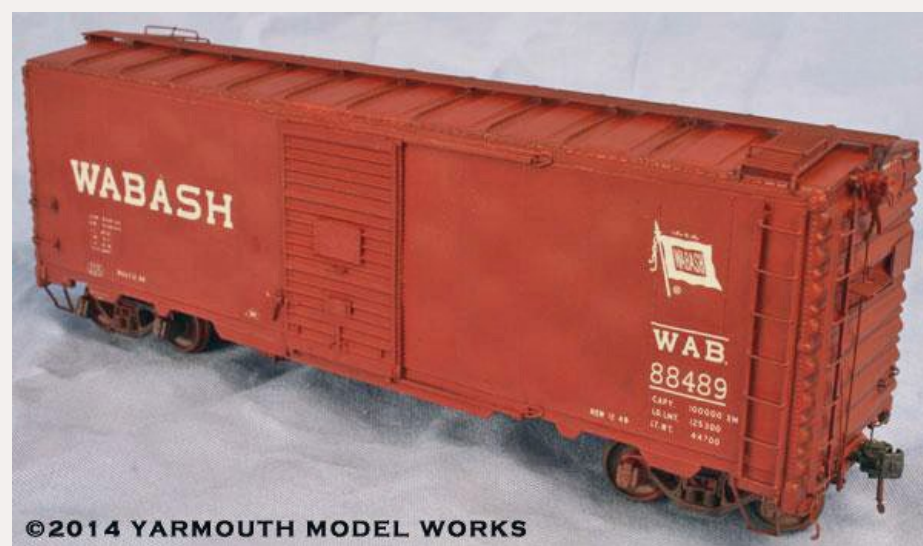

The newest HO scale resin kit from Yarmouth Model Works (yarmouth-modelworks.com) is a 40' Wabash 12-panel welded boxcar. The prototype, which was

built by AC&F in December 1948, was the first welded-side boxcar purchased by the Wabash. The side panels of the one-piece resin body show the subtle ripples that occur when sheet steel is welded. Additional features of the kit include etched-metal detail parts including a new etched running board, custom decals created by Black Cat Publishing, and Kato ASF A-3 trucks.

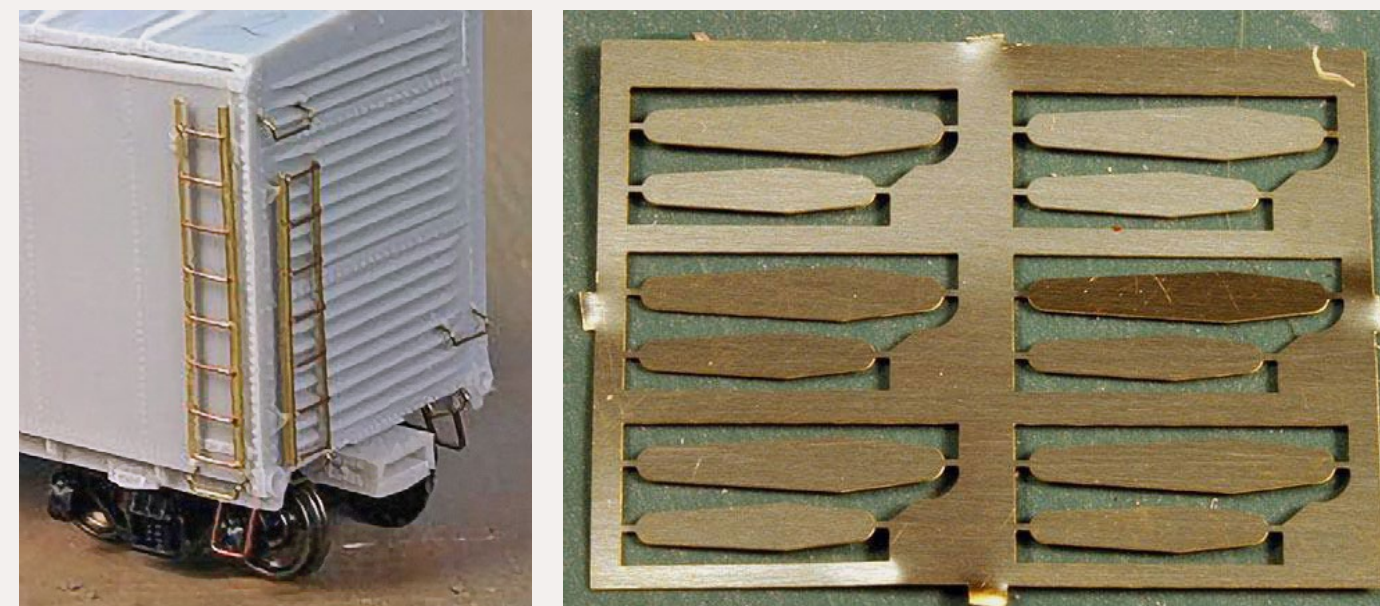

Yarmouth continues to expand its selection of HO scale detail parts aimed at prototype modelers. Recently introduced is an assortment of seven and eight rung ladders with 14", 16" and 18" spacing. Other etched-metal detail parts include brake levers (above), eye-bolts, and several types of stirrup steps. Visit the above website for pricing and ordering information.

N SCALE PRODUCT NEWS

Arnold (hornbyamerica.com) plans to release an all-new version of an N scale U25C diesel locomotive within the next 45 days. The ready-to-run model will feature road-specific details and a new electrical pickup system. Road names will be Burlington Northern; Chicago, Burlington & Quincy; Conrail;



Louisville & Nashville; and Northern Pacific. The ready-to-run DCC-ready model will have an MSRP of \$159.99.

run scheduled for release during the second quarter of 2015. GP7s without dynamic brakes will be available for Toledo, Peoria & Western; Amtrak; Peabody; and Boston & Maine.

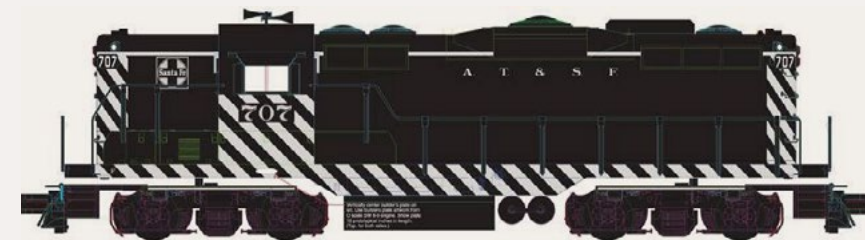

GP9s, both with and without dynamic brakes, will be available for Santa Fe, Amtrak, Canadian

Pacific, New Hampshire Northcoast, and Guilford-B&M (heritage scheme in both maroon/gold and green/gold).

Atlas is quoting a first quarter release for a Trainman series ACF 3560 cu. ft. Center-Flow triple-bay covered hopper. Road names for the N scale ready-to-run model will be Norchem, ACFX, Gardiner Inc., Niagara/Wisconsin, Southern Railway, and Norfolk Southern. Check the above website for additional details and pricing.

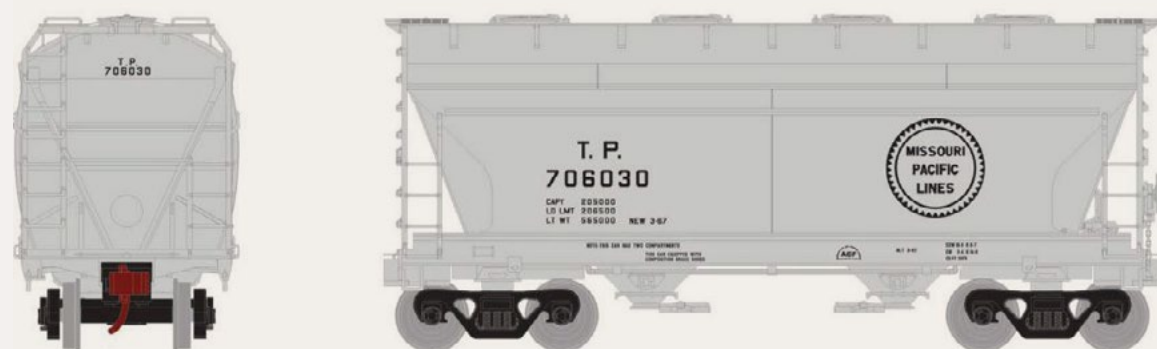

Athearn (athearn.com) has scheduled another production run of its ACF 2970 cu. ft. covered hopper for release in March. The N scale Ready-to-Roll model will feature a photo-etched roofwalk, round or trough hatches as appropriate to the prototype road, separately applied steps and grab irons, and screw mounted trucks with machined metal wheelsets. In addition to the MP-TP scheme shown here, road names will be Union Pacific (RI repaint), Great Northern, BNSF, BSMX, and ACFX. The MSRP will be \$22.98.

Bachmann Trains (bachmann-trains.com) is selling N scale ready-to-run 40' AAR steel boxcars decorated for New York,



Susquehanna & Western (Suzy Q scheme); Baltimore & Ohio (Timesaver scheme); and Great Northern.

Also available now are 52' 6" steel flat cars with removable 35' ribbed-side trailers. Flat car and trailer combinations include Santa



Fe with a Navajo Freight Line trailer, Baltimore & Ohio with a



Atlas (atlasrr.com) has included N scale GP7/9 diesel locomotives in its production

Railway Express Agency trailer, and Atlantic Coast Line with a Yale Transport trailer. Flat cars and trailers with matching road names include New York Central, Reading, and Western Maryland.



for Sears, Ferromex, Fedex MultiModal, Hub Group (red), and Hub group (green). Pricing and other details are available at the above website.

Con-Cor International (con-cor.com) will soon release an N scale 53' riveted side container decorated

for Sears, Ferromex, Fedex MultiModal, Hub Group (red), and Hub group (green). Pricing and other details are available at the above website.

Here is a look at preliminary test shots of an N scale transfer caboose coming from **Fox Valley** (foxvalleymodels.com). The model represents one of several home-

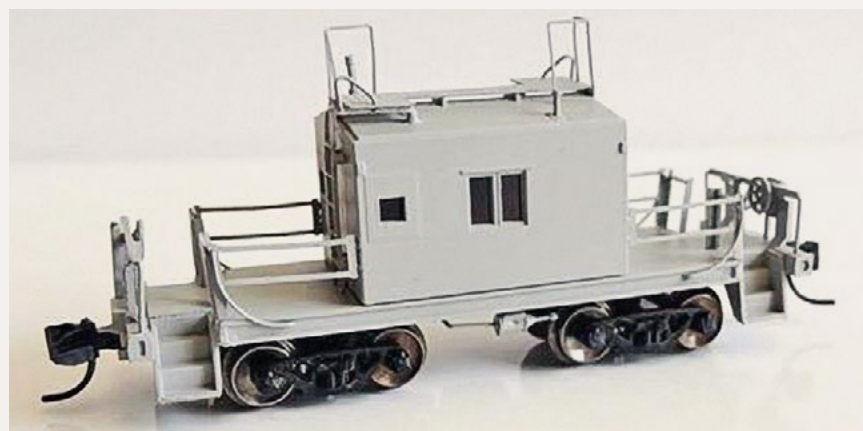

grown cars the Milwaukee Road built in their own shops. No word yet on a release date but an MSRP has been tentatively set at \$38.98.

InterMountain Railway (intermountain-railway.com) will release its next production run of N scale

SD40-2 diesel locomotives in March or April, 2015. Road names on the ready-to-run model will be Canadian Pacific (Expo 86



Vancouver), Chicago & North Western, Milwaukee Road, SOO Line, Ontario Northern, Santa Fe (snoot nose), and Union Pacific (snoot nose).



A Southern Railway locomotive with a high hood (left) will also be in the mix.



KatoUSA (katousa.com) plans to deliver an N scale Union Pacific excursion train complete with an FEF-3 steam locomotive late this year. The 4-8-4 locomotive will have a coreless motor with dual brass flywheels. Additional features include operating headlight and number boards, and a detailed cab interior. An optional pilot (sold separately) will be available to accommodate a front coupler for double heading. The ready-to-run locomotive will be available for standard DC operation and with factory installed DCC.

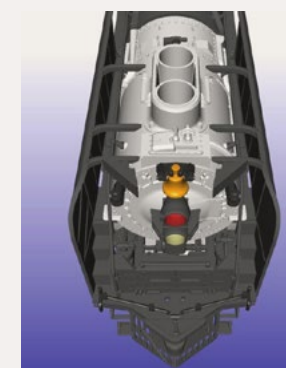
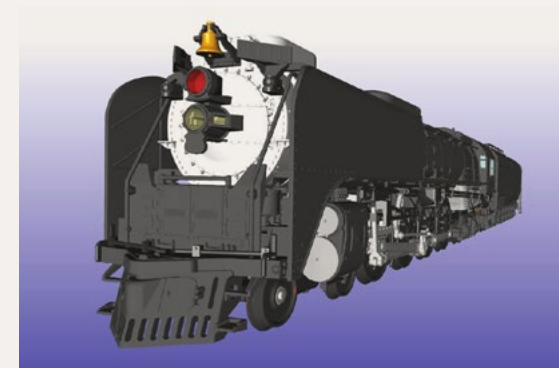

The 14-wheel N scale Centipede tender will have a unique articulated mechanism to permit operation on 11" radius curves.

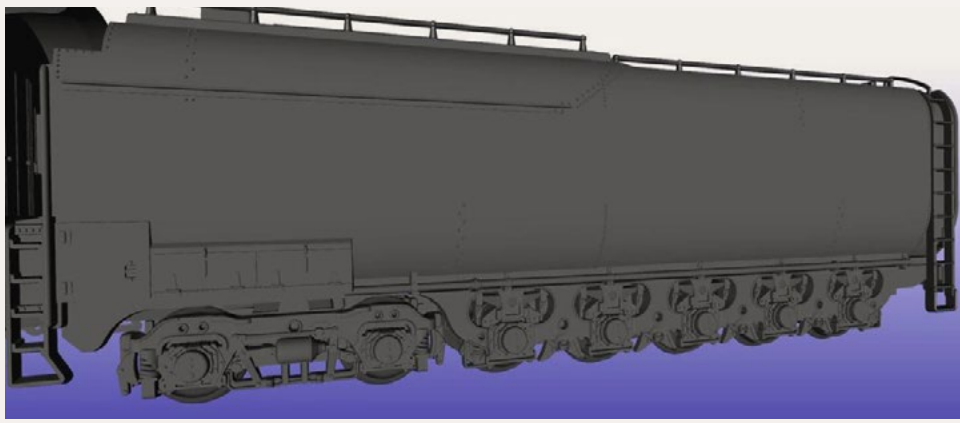

It should be noted that while the two water tenders used on UP steam excursions are similar, they are not identical. Kato is

incorporating the differences into the models and plans to sell them as a pair.



Kato's version of the seven-car Union Pacific excursion train will consist of power car #207 (a modified baggage/dormitory to supply power to trailing cars), Budd 10-6 sleeper #202 "Willie James," Promontory museum car #5779, dome coach #7001 "Columbine", coach #5473 "Portland Rose," dome diner #8008 "City of Portland" (shown here), and business car #119 "Kenefick." Additional information including tentative pricing is available at the above website.



Kato is offering Kobo custom decorating on several popular commuter locomotives, including a New Haven

GE P42 Genesis, a Go Transit MP40PH, and a Caltrain MP36PH.



able at the above website.

Additional Kobo custom decorated items include Milwaukee Road SD40-2 Bicentennial locomotive #156, and a five-car set of Caltrain bi-level commuter cars. Information on pricing and ordering details is available



diesel switcher. The ready-to-run locomotive features new AAR Type-A truck side frames and a light-tube for the front headlight.

Micro-Trains Line (micro-trains.com) has released several new N scale models including this UP SW1500



is used to carry diesel fuel.

Also new is a 56' Santa Fe general service tank car painted black with a gray band indicating the car



trucks indicates the cars were used in express service.



based on a prototype built by National Steel in 1964.



The prototype was in service until the caboose era ended in the mid-1980s.

Additional N scale cars released by Micro-Trains include a 10,153 gallon 39' single-dome tank car decorated for Shell; a four-pack of unique Chessie Safety Caboose painted white, dark blue, orange, and light green with each scheme featuring the Chessie Cat logo and a "Green Cross for Safety" slogan; a 50' Baltimore & Ohio 14-panel, steel gondola with fishbelly sides and fixed ends; a 50' olive drab flat car loaded with a 40' container decorated with WWII-era B-29 Superfortress nose

Micro-Trains is selling Union Pacific 40' box cars with double doors equipped with Allied Full-Cushion trucks. The paint scheme and

This N scale Canadian National 50' boxcar with plug doors and no running board is

Micro-Trains based this 34' wood-sheathed caboose on a car built for the New York Central in 1921.

art; and a 57' Chicago & North Western flat car converted to TOFC service. Additional information including pricing is available at the above website.



Roundhouse Division of Athearn (athearn.com) will release an N scale three-window wood caboose in March, 2015. Road names will be Chicago & North Western, Frisco, Northern Pacific, and Union Pacific. In addition, cabooses decorated for New York Central (above) and Southern Pacific will be equipped with metal truss rods. The ready-to-run model will have an MSRP of \$25.98 each.



Walthers (walthers.com) is scheduled to release an N scale GP38-2

diesel locomotive in December. Features of the ready-to-run model include a die cast split frame, directional LED headlights, and Blomberg M trucks. Road names will be Conrail, BNSF, Canadian National, CSX, SOO Line, and Union Pacific. The DCC-ready locomotive will have an MSRP of \$99.98.

NEW DECALS, SIGNS AND FINISHING PRODUCTS

Daniel Kohlberg (paducah.home.mindspring.com) has released four new HO scale decal sets for General American Dry Flo covered hoppers. They are Illinois Central, as delivered gray, 1960+; Illinois Central Gulf, gray repaint, 1974+; GACX Lease cars, gray, 1958+; and Quaker Oats, gray, 1962+. Visit the above website for pricing and ordering information.

Mask Island (maskislanddecals.com) has HO scale decals for Western Maryland twin-bay U- channel hopper cars in the speed-style lettering including the Medusa Service donut herald. These cars wore this scheme from repaint in 1955 until retirement in 1975. The set has sufficient material to letter two cars.

New HO and N scale water-slide decals from **Microscale Industries** (microscale.com) include lettering sets for Conrail open hopper cars; reporting marks for NAHX, TLCX, PTLX and PLCX for PS3000, PS4740, and 4750 covered hopper cars; Delaware & Hudson lightweight passenger equipment including yellow stripes and car names; and both black and white sets of common well-car data.

Mount Vernon Shops (mountvernonshops.com/NWH3.html) has new HO scale lettering sets for class H2 and class H3 Norfolk & Western hopper cars. The H2 set has pre-1952 17" tall N&W lettering. The H3 set has post-1952 24" tall N&W lettering. Eastern Car Works made a plastic kit for these cars and they can also be kitbashed from Broadway Limited's H2a hopper.

The C-D-S line of dry and water slide decals and Larry Larson Graphics are now available from **Ozark Miniatures** (ozark-miniatures.com). Since buying the lines a few years ago, the

Utah-based company has reorganized the lettering systems from both companies and is now able to supply product in most popular scales.

DISCLAIMER ..

The opinions expressed in this column are those of the writer and do not necessarily reflect the opinion of Model Railroad Hobbyist or its sponsors. Every effort is made to provide our readers with accurate and responsible news and information, however, neither Model Railroad Hobbyist or the writer of this column can be held responsible for any inaccuracies or typographical errors that may inadvertently appear in this column.



Send us your product announcements

If you are a hobby manufacturer with a product announcement, just [click here](#) and submit your announcement to us. Our web site and free magazine reach continues to grow, so get on board with this new media train that's hard to stop!

Briefly noted at press time...

Continued on the next page ...

... Carstens Ceases Operations

Railroad Model Craftsman, the model railroad hobby's oldest magazine, suspended publication. An announcement released by Henry R. Carstens, president of Carstens Publications, Inc., stated that all operations of the company would cease August 22, 2014. The closure affects *Railroad Model Craftsman*, *Railfan & Railroad*, and *Flying Models* magazines. Carstens said negotiations were underway with two companies regarding the future publishing of the magazines.

In a related statement, Chris Lane, who has served as Editor of both the On30 Annual and HOn3 Annual, believes there is a strong chance that he will be able to continue the two Annuals regardless of the outcome of the negotiations.



The rapid expansion and acceptance of on-line publications in recent years has impacted traditional print magazines and newspapers in all categories and subject matter.

The departure of RMC was preceded by *Mainline Modeler* and *Model Railroading* in 2006 and *Rail Model Journal* in 2008.

To some industry observers, the future of RMC was determined with the passing of Hal Carstens in 2009. Hal loved all things in the world of trains. He was a publisher who understood his readers because he too, was a modeler. Hal Carstens was the spirit behind *Railroad Model Craftsman*, a spirit that passed five years ago.

... *Railroad Model Craftsman* acquired by WRP

In a statement released August 30, Kevin EuDaly, president of White River Productions, announced that his firm has acquired *Railroad Model Craftsman* and *Railfan & Railroad* magazines from Carstens Publications. The agreement includes the Books Division of Carstens but does not include *Flying Models* magazine. EuDaly noted that White River will fulfill existing subscriptions.

RMC was founded in 1933 as The Model Craftsman. It was purchased a year later by Charles A. Penn, who refocused the magazine and in 1949 changed the name to Railroad Model Craftsman. Harold "Hal" Carstens joined the firm as an associate editor in 1952 and acquired the company when Penn retired in 1962. As the owner and principal executive, Hal Carstens allowed considerable freedom to his editors Tony Koester and later William Schaumburg, who with their editorial team developed a style RMC readers found comfortable and perhaps less formalized than their competition. Readers will be watching closely to see if that style is continued by the new ownership.

... Jerry Glow ends decal business

Jerry Glow has closed his Florida-based business of supplying custom decals. Glow, a retired custom model painter from California, has recently experienced difficulty in completing orders in a timely manner. MRH understands that any paid outstanding orders will be fulfilled but no new orders will be accepted. Inquiries may be sent to jerryglow@comcast.net. ■

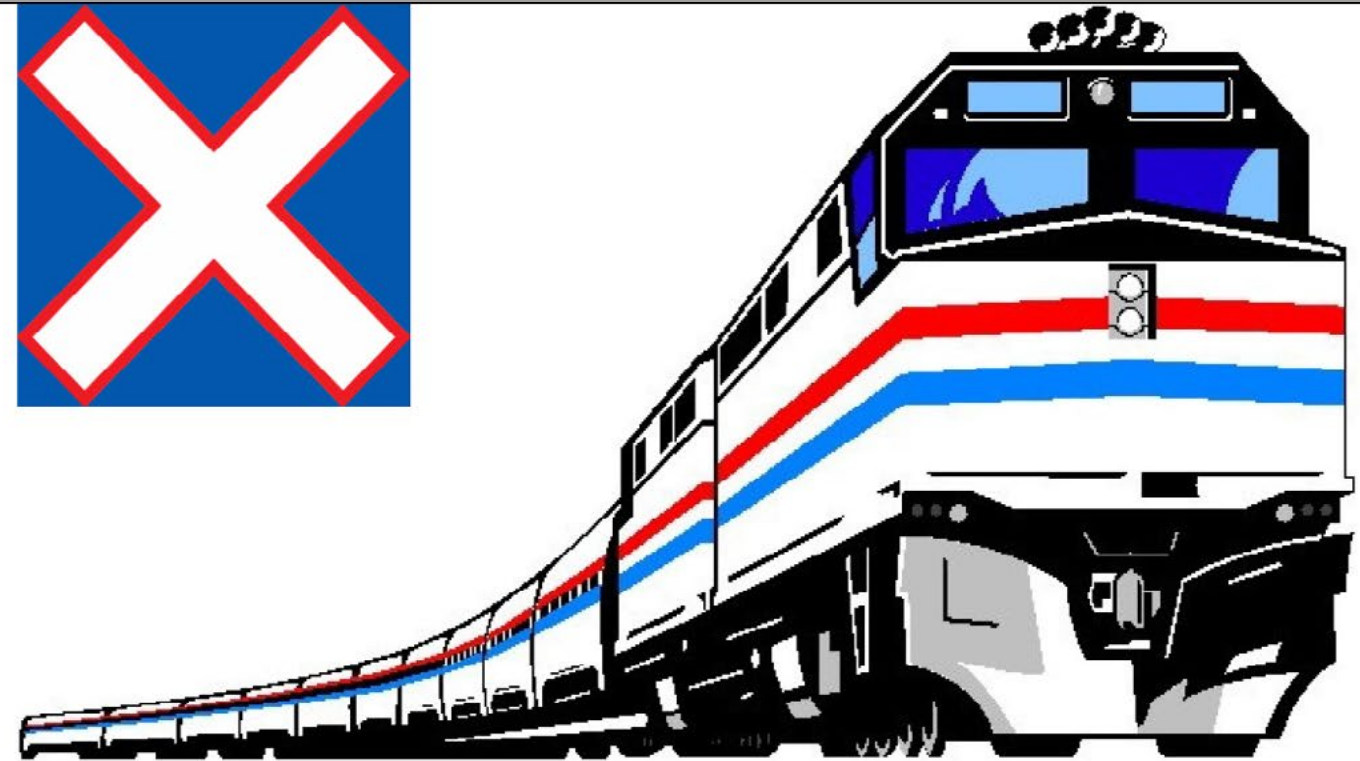
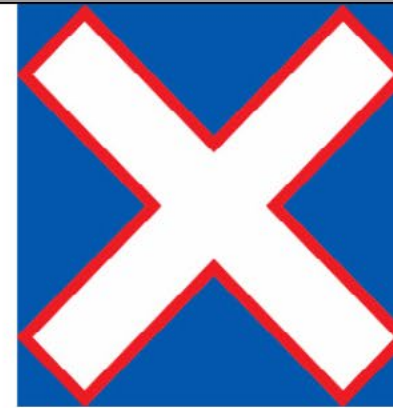

THE NORTH SHORE TRAIN SHOW

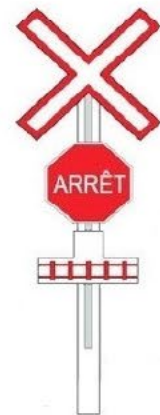

First Edition

**OCTOBER 4 & 5 OCTOBRE
2014**

SATURDAY

10AM TO 5PM

SUNDAY

9:30AM TO 4:00PM

Complexe Multi-Sports

**995 ave Bois-de-Boulogne
Laval ,Québec
Canada**



Selected Events



September 2014

CANADA, QUEBEC, MONTREAL, September 27-28, Montreal Model Train Exposition, at Sun Youth Centre, 4251 Urbain Street. Info at montrealmodeltrainexposition.com.

ARIZONA, PHOENIX, September 18-20, National Convention of Timetable Collectors, at Crowne Plaza Phoenix North. Info at naotc.com.

CALIFORNIA, SAN DIEGO, September 3-7, 2014 NMRA Pacific Southwest Region Convention, at Marriott Courtyard Hotel, 595 Hotel Circle South. Info at psrnmra.org.

CALIFORNIA, SANTA ROSA, September 19-21, 6th Annual Redwood Empire Train Show (in conjunction with Fall Home show), at Sonoma County Fair Grounds, 1350 Bennett Valley Road. Info at sonomacountyfair.com/events.php.

COLORADO, COLORADO SPRINGS, September 12-14, TECO Train Expo Colorado, at Freedom Financial Services Expo Center, 3660 North Nevada Avenue. Info at tecoshow.org.

GEORGIA, KENNESAW, September 19-20, Atlanta Railroad Prototype Modelers Meet, sponsored jointly by the Southern Railway Historical Association, Atlantic Coast Line & Seaboard Airline Railroads Historical Society, Central of Georgia Railway Historical Society, and Nashville Chattanooga & St Louis Preservation Society. At the Southern Museum of Civil War and Locomotive History, 2829 Cherokee Street. Info at srha.net.

INDIANA, MIDDLEBURY, September 12-13, NMRA Michiana Division 2014 Education & Training Conference, at Das Dutchman Essenhaus Conference Center. For info send email to danbrewer.nmra@yahoo.com.

KANSAS, OVERLAND PARK (Metro Kansas City, Missouri), September 3-6, 34th National Narrow Gauge Convention. Info at kansascity2014.com.

MASSACHUSETTS, CHARLTON, September 21, Annual Train Show sponsored by Providence & Worcester Railfan Club & Museum, at Overlook Hotel, 88 Masonic Home Road. Info at wrfc.net.

MASSACHUSETTS, PALMER, September 11-14, NMRA NER Convention, co-hosted by HUB and Nutmeg Divisions. Info at nediamonds2014.org.

NEBRASKA, NORTH PLATTE, September 19-21, North Platte 2014 Rail Fest Model Train Expo, at National Guard Armory, 1700 N. Jeffers St. Info at nprailfest.com.

VERMONT, RUTLAND, September 27, Rutland Train Show, featuring model trains, railroad history, and vendors, at Holiday Inn, State Route 7. Co-sponsored by the Rutland Railway Association and Rutland Railroad Museum. Info at therutlandrailwayassociation.org.

VIRGINIA, FREDERICKSBURG, September 12-13, Mid-Atlantic Railroad Prototype Modelers Meet, with model displays, clinics, and RPM camaraderie. At Wingate by Wyndham Hotel, 20 Sanford Drive. Info at marpm.org.

October 2014

CANADA, QUEBEC, LAVAL, October 4-5, The North Shore Train Show, at Complexe Multi-Sports, 995 rue Bois-de-Boulogne. Info at salondutrainrivenord.org.

CALIFORNIA, BANNING, October 11-12, Second Annual Banning Train Fest, with modular layouts, vendors, displays and children's rides, plus NMRA-PSR Cajon Division meet with model and prototype clinics, model contest, and time-saver switching layout. At Banning Community Center and Banning Schools Gymnasium at George Street and San Gorgonio Avenue. Info from Ed Ball at 951-237-9818.

CONNECTICUT, ORANGE, October 12, 22 Annual Model Train Show, at High Plains Community Center, 525 Orange Center Road (Route 152). Sponsored by New Haven & Derby Model Railroad Club. Info at newhaven-derbymodelrailroadclub.org.

FLORIDA, MELBOURNE, October 25, Brevard Train Expo, at Melbourne Auditorium, 625 E Hibiscus Blvd. Details from Rail Rody at 321-914-3888.

ILLINOIS, NAPERVILLE, October 9-11, 21st Annual Naperville RPM Conference, hosted by Joe D'elia at Sheraton Lisle-Chicago Hotel, 3000 Warrenville Road, Lisle. Info at railroadprototype-modelers.org/naper_meet.htm.

MICHIGAN, MUSKEGON, October 26, Fall Model Train Show, sponsored by Muskegon Railroad Historical Society, at Golden Token Hall, 1300 E. Laketon Ave. Info at mrhs-online.org.

MINNESOTA, ST. JAMES, October 4, NMRA-Thousand Lakes Region Prairie Lakes Division Fall Meet and 25th Anniversary Celebration of The Roundhouse Train Club, featuring operating layouts, modeling contest, vendors, door prizes, swap meet, and clinic presentations. At National Guard Armory, 521 Armstrong Blvd. North. Info from Bill Nelson at walleyjnelson@hotmail.com.

NEW JERSEY, NEW BRUNSWICK, October 11, 14th Annual Mass Transit and Trolley Modelers Convention, sponsored by NYC Model transit Association and the Shore Line Trolley Museum. At Rutgers Gymnasium annex, 130 College Ave. Info at nycmodeltransit.org/meetdetails.htm.

OHIO, WEST CHESTER, October 11-12, NMRA Mid-Central Region, Cincinnati Division 7, 47th Annual Model Railroad Show. At Lakota West High School, 8940 Union Centre Blvd. Info at cincy-div7.org.

TEXAS, FOREST HILL, October 11-12, Texas Western Train Show, featuring model train modular layouts, vendor displays, clinics, nearly 100 sales tables, contests, door prizes, and free parking. At Forest Hill Civic and Convention Center, 6901 Wichita Street. Info at twtrainshow.com.

WASHINGTON, CHEHALIS, October 11-12, All Scales Annual Fall Model Railroad Swap Meet and Train Show, sponsored by Lewis County Model Railroad Club. Event at Southwest Washington Fair Grounds, Blue Pavilion Building, 2555 North National Avenue. Info at lewiscountymuseum.org/model-train-show-swap-meet.

Future 2014 (by location)

AUSTRALIA, NEW SOUTH WALES, ARMIDALE, November 15-16, Bi-Annual Convention of the New England Model Railway Club Inc, at Armidale Bowling Club, Dumeresq Street. Preregistration required. Phone 61 02 6732 5711 for information.

CANADA, BRITISH COLUMBIA, BURNABY, November 8-9, Trains 2014 32nd Annual Model Train Show featuring operating trains, dioramas, kids activities, and vendors. For registrants there are operating sessions (November 7), clinics, model contests, layout tours, a prototype modelers meet, and banquet. At Cameron Center, 9523 Cameron Street. info at bctrains.sbcrailway.ca.

CANADA, ONTARIO, HAMILTON, November 1, Hamilton and District Layout Tour. Home and club layouts in Burlington, Beamsville, Fenwick, Caledonia, and Hamilton. Guide books will be available in October at local model railway shops. Info from Brandon Bayer at brandon1@cogeco.com.

FLORIDA, PALM BAY, December 21, HO Scale Module Display, at Franklin T. Degroodt Memorial Library, 6475 Minton Road. Sponsored by Palm Bay Model Railroad Club.

INDIANA, DANVILLE, November 22, NMRA Central Indiana Division Train Show, at Hendricks County Fair Grounds. Info at cid.railfan.net.

MAINE, BREWER, November 22, Eastern Maine Model Railroad Club Show with operating layouts and dealer tables, at Jeff's Catering, 15 Littlefield Way East, West Industrial Park. Info from Geoff Anthony, at dahak@roadrunner.com.

MICHIGAN, EAST LANSING, November 9, Lansing Model Railroad Club Show and Sale, at Michigan State University Pavilion, 4301 Farm Lane.

PENNSYLVANIA, MONACA, November 13, Beaver County Fall Model Train Show, at Center Stage, 1495 Old Brodhead Road. Info at bcmrr.railfan.net.

WISCONSIN, WEST ALLIS, November 8-9, Trainfest Model Railroad Show, featuring manufacturers exhibits, numerous clinics, and operating layouts. At Wisconsin Exposition Center, State Fair Park, 8200 West Greenfield Avenue. Info at Trainfest.com.

Future 2015 (by location)

AUSTRALIA, CANBERRA, March 28-29, 2015, 27th Annual Canberra Model Railway Expo, hosted by Canberra Model Railway Club, at University of Canberra High School, 104 Baldwin Drive. Info at canberra-model-railway-club.webs.com.

CALIFORNIA, NEWARK, May 13-17, 2015, NMRA Pacific Coast Region Convention, at Newark-Fremont DoubleTree by Hilton Hotel, 39900 Balentine Drive. Info at pcrnmra.org/conv2015.

FLORIDA, COCOA BEACH, January 8-10, 2015, Prototype Rails RPM meet hosted by Mike Brock, at Cocoa Beach Hilton Hotel, 1550 North Atlantic Avenue. Info at prototypetrains.com.

OREGON, PORTLAND, August 23-30, 2015, NMRA National Convention, at DoubleTree by Hilton Hotel Portland. info at nmra2015.org.

OREGON, PORTLAND, August 28-30, 2015, National Train Show, at Portland Expo Center. Info at nmra2015.org/trainshow.

PENNSYLVANIA, PHILADELPHIA, May 15-17, 2015, Biennial Meet of the East Penn Traction Club, at Pennsylvania Convention Center. Info at eastpenn.org/2015_meet_announcement.htm.

TEXAS, HOUSTON, September 2-5, 2015, 35th National Narrow Gauge Convention. Info at nngc-2015.com.

WASHINGTON, BELLEVUE, April 16-18, 2015, 30th Annual Sn3 Symposium, at Bellevue Sheraton Hotel, 100 112th Ave NE sn3symposium-2015.com.

Future 2016 and beyond (by location)

INDIANA, INDIANAPOLIS, July 3-10, 2016, NMRA National Convention and National Train Show. Info at nmra2016.org.

MAINE, AUGUSTA, Sept. 7-10, 2016, 36th National Narrow Gauge Convention. Info at nngc2016.org. ■



Clickable advertiser index – 1

[Accu-Lites](#)
[American Limited](#)
[Amherst Show](#)
[An Affair With Trains](#)
[Archer Fine Transfers](#)
[Atlas Model Railroad Co.](#)
[Bachmann](#)
[Backdrop Junction](#)
[Berrett Hill Trains](#)
[Blair Line](#)
[BLMA](#)
[Bollinger Edgerly Scale Trains](#)
[Bowser](#)
[Caboose Hobbies](#)
[Canyon Creek Scenics](#)
[Clever Models](#)
[Coffman Graphics](#)
[Coastmans Scenic Products](#)
[Credit Valley Railway](#)
[DCC by Design](#)
[Digitrax \(2 page spread\)](#)
[D's Model Trees](#)
[East Coast Railroads](#)
[ESU LokSound](#)
[Fast Tracks](#)
[Fifer Hobby Supply](#)
[Fox Valley Models](#)
[GLX Scale Models](#)
[Great Decals](#)
[Iowa Scaled Engineering](#)
[Iwata-Medea](#)
[Jelsma Graphics](#)
[Ken Patterson.com](#)
[Litchfield Station](#)
[Logic Rail Technologies](#)

[Microscale](#)
[Minimalist Model Railroad](#)
[Model Citizens Project](#)
[Motrak Models](#)
[Mr. Detail Parts](#)
[MRH Store \(Model Trains Video\) \(1\)](#)
[MRH Store \(Model Trains Video\) \(2\)](#)
[M.T.H.](#)
[Mullet River \(O scale\)](#)
[Nano-Oil](#)
[National Narrow Gauge](#)
[NCE \(2 page spread\)](#)
[Nick & Nora Designs](#)
[North American Railcar](#)
[Rail Design Services](#)
[RailMaster Hobbies](#)
[Railroad Explorer](#)
[Rapido \(1\)](#)
[Rapido \(2\)](#)
[Rapido \(3\)](#)
[Rapido \(4\)](#)
[Ring Engineering \(1\)](#)
[Ring Engineering \(2\)](#)
[RR-CirKits](#)
[RSlaserKits, Inc.](#)
[Rulers-of-the-World](#)
[Rusty Stumps](#)
[Streamlined Backshop](#)
[Scenic Express](#)
[Scotty Mason Show](#)
[Signature Press](#)
[Soundtraxx](#)
[Southern Digital](#)
[TAM Valley Depot](#)
[TCS](#)

Clickable advertiser index – 2

[The North Shore Train Show](#)
[Tony's Train Exchange](#)
[TrainMaster Models](#)
[TrainMasters \(1\)](#)
[TrainMasters \(2\)](#)
[TrainWorld](#)
[True Line Trains](#)
[True Scene Modeling](#)
[TSG Multimedia](#)
[Westerfield Models](#)
[Yankee Dabber](#)
[Yarmouth Model Works](#)

Clickable topic index

[DCC Impulses – SoundTraxx SoundCar decoder](#)
[Editorial – Publisher's musings](#)
[Editorial – Reverse running](#)
[First Look – USATC S100 side-tank steamer](#)
[Getting Real – Layout Building Productivity Part 2](#)
[Layout – Minimum space layouts](#)
[News – September Newsletter](#)
[News – September Events](#)
[Q and A – MRH Questions, Answers, and Tips](#)
[Bridges – Turntable bridge with an arch](#)
[Locomotive – SP GP9 communter locomotive](#)
[Structures – Modeling an Agway feed mill](#)
[Up the Creek – Benchwork, roadbed, and track come to Browning](#)
[What's Neat – My 21st video column for MRH](#)

[Other – Bonus Extras](#)
[Other – Cover](#)
[Other – Derailments](#)
[Other – Hobby Marketplace](#)
[Other – MRH Sponsors](#)
[Other – Staff Notes](#)
[Other – Table of Contents](#)



Dead frog society

Reverse Running: Stepping outside the box with a contrary view

by Charlie Comstock

A confession – I run with dead frogs on the BC&SJ...

Some say this is bad, bad, bad. However, I've used dead (unpowered) turnout frogs for the last 14 years and there are a *lot* of them on the current BC&SJ – 34 in main staging alone.

No, I don't run Docksidiers (0-4-0 steam) or critters. Their ultra-short wheelbases would guarantee stalls over my #6 and #8 dead frogs.

Yes, locos should have a significant number of (or all) wheel sets picking up power from the rails, and they should pick it up from both rails. That means some brass steamers which don't pick up from both rails on all wheels won't work well on the Bear Creek. I've solved that problem. I don't own and operate many brass steamers. Besides, any old brass should probably be re-motored and re-gearred and re-pickuped to make them run more smoothly and to get the max current rating down from the 1-1/2 amps their open frame motors draw when stalled.

Typical locos on the BC&SJ are '50s era diesels and plastic steam. The shortest wheelbase is a Proto 2000 0-8-0 (which had problems because it's a first gen unit with no power pickup in the tender – for now it's a piece of scenery until I get the



time to add power pickup to the tender). Kato NW2 switchers (and thus presumably SW-1 to SW-? switchers) work fine. Kato RS-2 and RSC-2 units work fine. Proto 1000 RS-2 units work fine. BLI USRA lite 2-8-2, E7A, and AC-4 locos operate fine (with no sound hiccups on my dead frogs). Stewart F7s run fine, but the 1st gen SoundTraxx sound in them hiccups a lot – but it hiccups on track without turnouts, too. My Proto 2000 SD7s (about 12 years old) run fine as does an Atlas GP7.

So! If you like extra wiring, complexity, and expense, by all means go ahead and add micro-switches to all your turnouts. If you're rolling in dollars, use frog juicers. Or if in your wildest dreams you think there is the slimmest chance of running 0-4-0T engines or critters, then power in your frogs isn't optional – it's mandatory. Or you could convert to cell-phone-battery powered, radio-control locos and not bother with powering frogs (or any other rails).

Or maybe we should go back to running power routing (pre-DCC friendly era) turnouts. They had powered frogs to begin with. We moved away from them because running a loco into the non-selected route creates short circuits which crowbar boosters, stopping everything in that power district (and other problems). But if you power your frogs through a micro-switch you'll have that same crowbar-an-entire-power-district issue. If that's a big problem for you, then dead frogs may be an answer (or pay the \$\$\$ for Frog Juicers from Tam Valley).

Plastic diesels (and steamers) from Atlas, BLI, Kato, Athearn, etc. aren't going to have problems with unpowered frogs unless you have a ladder built with dead frogs spaced a loco wheelbase from each other (and you can always power those frogs that really need it).

There's enough to do on a model railroad without doing more than is really needed!

Derailments

humor and bizarre facts (allegedly)



Mr. Bean takes the train. It helps to appreciate British over-the-top slapstick humor when you watch this video. Note: The focus on this video is a little soft, but it's worth a laugh or two to watch it through. Enjoy!

If you're the first to [submit a bit of good humor or bizarre facts](#) and we use it, it's worth \$25!



For the love of model trains

Coming in October

- Andrew Castle kitbashes a Pan-Am Railways SD45
- Jeff Johnston on modeling logging cabooses
- Box car ends from A-Z
- Painting and finishing a resin box car
- \$500 layout contest third place winner
- ...and lots more!

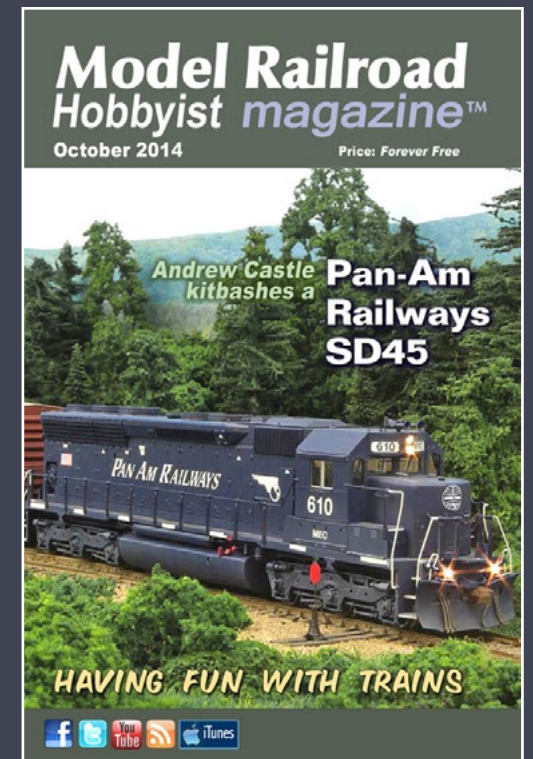

More Derailments humor ...

A woman boarded the train carrying her newborn. The conductor said to her, "That's the ugliest baby I've ever seen!"

The woman trudged to the rear of the coach and said to a man next to her, "The conductor just insulted me!"

"You go right up there and tell him off," the man said. "Go ahead, I'll hold your monkey for you."

