

Weathering freight cars • PICAXE circuits • Easy trees

Model Railroad Hobbyist magazine™

June 2014

Price: Forever Free



Looking for the Portrait version? [Click here ...](#)

HAVING FUN WITH TRAINS



John Golden covers ...

Modeling Seaboard B-8 and B-9 Boxcars



Standard edition - Landscape



download



contents



index

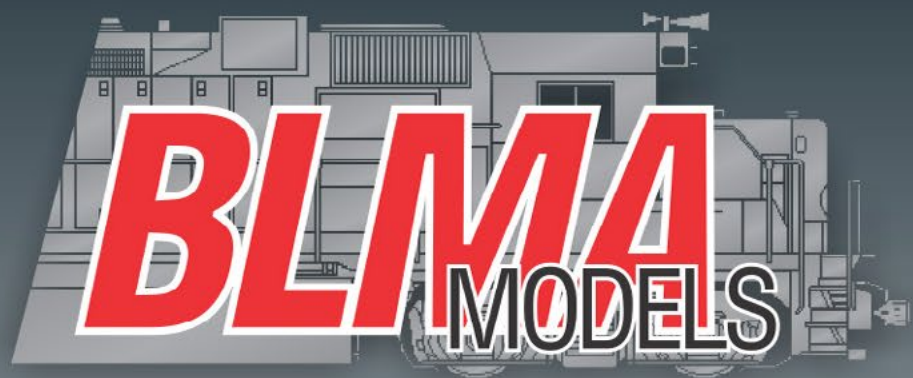

RETURN of the
Searchlight
SIGNALS
COMING MID 2014
HO SCALE

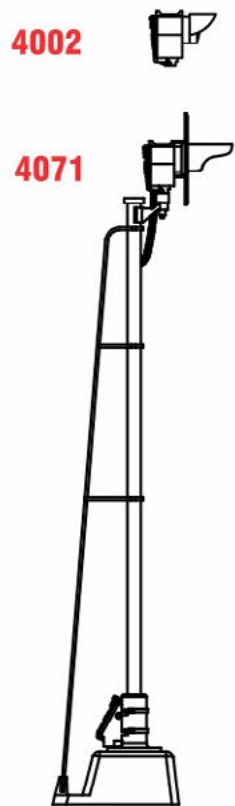

Finally - new Searchlight signals! Santa Fe/Southern Pacific design - featuring a straight ladder and no lower electrical cabinet.

- HO/4002** Dwarf Heads(2) \$24.95
- HO/4070** Dual Head \$44.95
- HO/4071** Single Head \$34.95

Our signals can be wired into DC or DCC signal circuitry, or a simple toggle switch - all sold separately. Please visit our website for a list of recommended circuit control units.

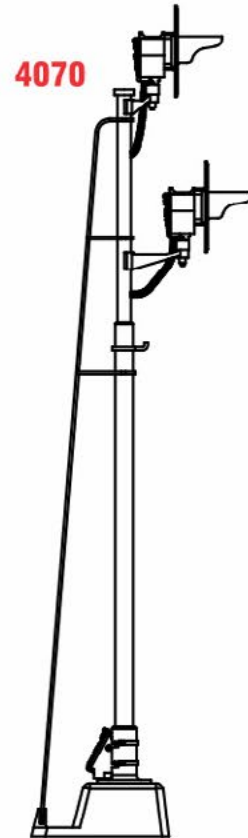

CLICK HERE TO SEE MORE



Model Railroad Hobbyist magazine™

Issue 52

Front Cover: John Golden provides some history and techniques for modeling Seaboard B8 and B9 box cars. Even if you don't need these specific cars, you may want to check out John's techniques for your other rolling stock projects.



ISSN 2152-7423

Editorial Staff

Joe D. Fugate, Publisher and Editor
Don Hanley, Assistant Editor

Production

Patty Fugate, pasteup and layout
Joe Brugger, copy editing
Mike Dodd, copy editing

Technical Assistants

Jeff Shultz
Jimmy Simmons

Advertising

Les Halmos, Account Manager
Daniel Nava, Advertising Assistant
Jean-François Delisle, Marketing Assistant

Columnists

Richard Bale, News and events
Jeff Shultz, News and events
Les Halmos, Modular railroading
Ken Patterson, Reporter at large
Bruce Petrarca, DCC

Special Correspondents

Joe Brugger, Questions & answers
Charlie Comstock, Contributing editor

Published for the glory of God. [What's this?](#)

Issue password: Jun2014





click to learn more about this sponsor



click to learn more about this sponsor



click to learn more about this sponsor



NEW SPONSOR!



click to learn more about this sponsor



click to learn more about this sponsor



click to learn more about this sponsor



click to learn more about this sponsor



NEW SPONSOR!

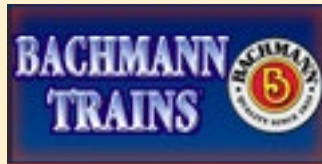

NEW SPONSOR!



click to learn more about this sponsor

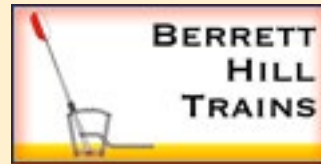

NEW SPONSOR!



NEW SPONSOR!



click to learn more about this sponsor



click to learn more about this sponsor



NEW SPONSOR!



NEW SPONSOR!



NEW SPONSOR!



click to learn more about this sponsor



click to learn more about this sponsor



click to learn more about this sponsor



NEW SPONSOR!



click to learn more about this sponsor



click to learn more about this sponsor



click to learn more about this sponsor



click to learn more about this sponsor



click to learn more about this sponsor



click to learn more about this sponsor



NEW SPONSOR!

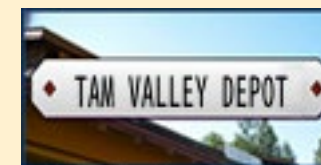

click to learn more about this sponsor



NEW SPONSOR!



click to learn more about this sponsor



click to learn more about this sponsor



click to learn more about this sponsor



click to learn more about this sponsor



click to learn more about this sponsor



click to learn more about this sponsor



click to learn more about this sponsor



click to learn more about this sponsor

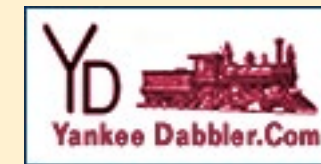

click to learn more about this sponsor



click to learn more about this sponsor



click to learn more about this sponsor



click to learn more about this sponsor



NEW SPONSOR!

100,000+ unique device views per month...

Tell me more

Want your logo on this page?

Click to find out how....



click to learn more about this sponsor



click to learn more about this sponsor



click to learn more about this sponsor



click to learn more about this sponsor



NEW SPONSOR!



NEW SPONSOR!



click to learn more about this sponsor



click to learn more about this sponsor



Looking for something? Check our Hobby Marketplace!

Take me there

Table of Contents - 1

Main Features

*Click title
to view*

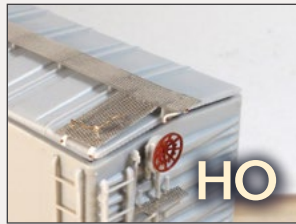

Modeling Seaboard B-8/B-9 box cars

Great steam-era rolling stock kitbashing tips

John Golden



Weathering steam-era freight cars

Learn to weather equipment like a pro

Charlie Duckworth



Fast and easy trees

Build lots of deciduous trees the easy way

Randy McKenzie

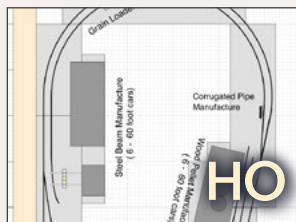

\$500 layout 1st place winner

Build this layout for under \$500

Eugene Griffin



Using Vallejo earth texture for roofing

A quick but effective technique

Rob Bennett

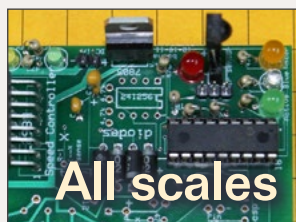

PICAXE circuits for model railroaders

Discover the remote-control possibilities

Dave Bodnar

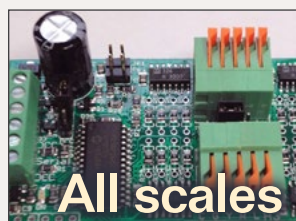

RR-CirKits

MRH First Look

MRH Staff



June News

Richard Bale

& Jeff Shultz

Table of Contents - 2

Other Features

*Click title
to view*

A more flexible layout era

Publisher's musings

Joe Fugate

MRH Staff Notes

MRH #2, passing up RMC

The MRH staff

MRH Q - A - T

Questions, Answers, and Tips

Compiled by Joe Brugger

Yes, it's a model

Great modeling photo feature

Compiled by the MRH Staff

Hobby Marketplace

Vendor ads

Derailments

Humor, fun and bizarre facts

Columns

Willams Creek bridge

Getting Real

Marty McGuirk

NG coal tipple, part 1

Lite and Narrow

Larry Smith

Weathering decals

What's neat this week

Ken Patterson

Really railroading!

Reverse Running

Joe Fugate

Subscriber-only extras *(subscribers click here to access)*



The Confederation Train is here



NEW F-UNITS





ON SPECIAL THIS MONTH AT EXACTRAIL.COM

HO DECK PLATE GIRDER BRIDGES & P-S 5344 BOX CAR



Available in 32', 50', & 72'

N P-S 4000 COVERED HOPPER & TRINITY 64' TRINCOOL REEFER

LOW STOCK! 4 Paint Schemes



UP/ARMN



HO NOW AVAILABLE!

ALL NEW
THRALL 54' "PROTECTOR" COIL CAR
Norfolk Southern



A more flexible layout era

How to be both a purist and a generalist using a "sliding era"

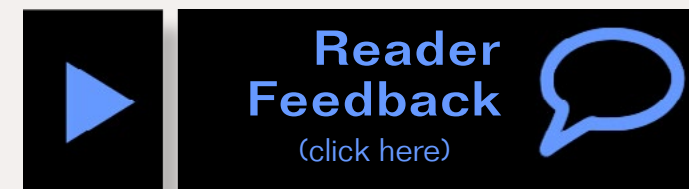

Publisher's Musings

by Joe Fugate

With all the interest among many model railroaders today to model a prototype railroad, or at least to proto-freelance a model railroad from a prototype that "could have been", a key step in the process becomes to picking an general era, and setting a specific date.

Many modelers pick a year and then try to stick to that. Some, like Jack Burgess, pick a month, *day, and year* – like August 31, 1939 in his case.

Others prefer to be more general, and say: "I'm modeling the 1950s" or "I'm modeling the early Amtrak era."

If you take the more generalist route, like modeling the 1950s, then that means anything in the '50s should work, up to something built and deployed as late as December 31, 1959. You may also have locomotives on your railroad that were retired January 2, 1950, but since the locos were still in revenue service on January 1, 1950, you call that "the 1950s" and declare you're good to go.

If you're one of these era generalists, the era purists will tell you you're just kidding yourself. In reality, you're modeling 1959, you're just not doing a very good job of it!





CANADIAN NATIONAL #4008
(DCC-EQUIPPED)
Item No. 60307

EMD GP40 IN NEW ROADNAMES FROM NORTH AMERICA'S GREAT RAILROADS TO YOUR LAYOUT

Traveling from 10 great railroads of the United States and Canada, these GP40s are offered in a choice of DCC-ready and DCC-equipped models. The DCC-equipped model features a dual-mode NMRA-compliant decoder that lets you digitally control speed, lighting, and direction. The DCC-ready model has a factory-installed 8-pin socket for the optional DCC decoder installation of your choice. All models also have eight-wheel drive and E-Z Mate® Mark II couplers. Visit your favorite hobby dealer to find the GP40 that is right for your HO railroad.

EMD GP40 (DCC-EQUIPPED) MSRP \$109.00 each

SHIPPING NOW!



SANTA FE #3508
Item No. 60304



BNSF #3002
Item No. 60305



MILWAUKEE ROAD #2001
Item No. 60308

Click for more information.



DETROIT, TOLEDO & IRONTON #405
Item No. 60310



SEABOARD #626
Item No. 60311



EMD GP40 (DCC-READY) \$75.00 each

SHIPPING NOW!



SANTA FE #3509
Item No. 63515



CONRAIL #3078
Item No. 63516

Click for more information.



CHESSIE® #4135
Item No. 63517



AMTRAK #651
Item No. 63518



MISSOURI-KANSAS-TEXAS #245
Item No. 63519



Bachmann Industries, Inc. • 1400 East Erie Avenue • Philadelphia, PA 19124 USA • www.bachmanntrains.com

Click to learn more.



Actually, there is a way to be a generalist and a purist as well – getting the best of both worlds. That’s what I do with my HO Siskiyou Line. How am I able to accomplish that?

I like modeling the 1980s Southern Pacific in Oregon. I do it in a generalist way, but manage to keep it purist as well!

As I write this, it’s May 2014, so I declare it’s currently May 1984 on my layout, making it exactly 30 years in the past. In 2010, I declared it to be 1980 on my Siskiyou Line. As this decade unfolds, I will march through the years on my Siskiyou Line until we get to 2019 (1989). Once it’s 2020, I will roll the date back 40 years, and the layout will be back to 1980 again.

On my Southern Oregon prototype, the decade began with a lot of UP pool power, so I can run mixed SP - UP power consists. By the mid-decade, the UP pool power was largely gone

CHECK IT OUT!

A terrific prototype for a switching layout!

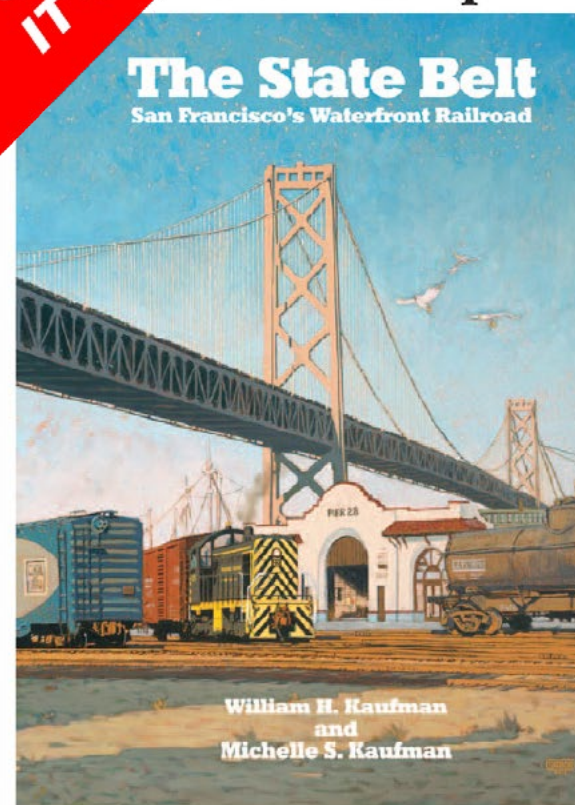

Bill Kaufman has researched the history of San Francisco’s waterfront railroad, the State Belt, and presents a rich collection of industrial information and photos. How can I learn more about this book? How can I buy it?

Click here for the answer ...

SIGNATURE PRESS

and the GP40R - TEBU's (tractive effort booster units - slugs with GP40R mothers, in other words) began running on the coast branch.

By 1986, the first yellow, red, and black Kodachrome SPSF units began to appear in fresh paint, and by 1988, black and orange DRGW units began running across the entire SP system. Also in the late 1980s, some BN pool power started showing up on the SP in Oregon.

As the decade wears on, I can phase out and phase in the different mix of units according to the approximate date. This allows me to remain purist in approach, and still enjoy the variety of the entire decade of the 1980s.

On my layout, I suggest certain dates by using other little details. For example, I have a couple billboards circa 1984 for the 1984 presidential election. I have some 1984 and 1988/89 automobiles, so I can put them on the layout when the proper time arrives.

At the front of the decade of the 1980s, we might get a very dirty Bicentennial caboose or loco on the layout, leftover from 1976. Circa 1984, maybe a caboose celebrating the 1984 Olympics in LA will appear.

There are also differences in rolling stock through the decade, based on what is seen in the official equipment registers for the various years. For example, there were green Evergreen lumber cars still running circa 1980, but as we push on into the middle of the decade, those Evergreen cars disappeared.

So the next time you're grappling with trying to stick to a certain era, consider what I'm doing. I call it a "sliding era", where you change out some of your equipment for newer equipment over time. If you like a certain year really well, but you are also

Triplex Triples The Fun



Erie - 2-8-8-2 Triplex Steam Engine, Cab No. 5015 Erie - 2-8-8-2 Triplex Steam Engine, Cab No. 5016 Erie - 2-8-8-2 Triplex Steam Engine, Cab No. 5014
 80-3194-1 Proto-Sound 3.0 M.S.R.P. \$649.95 80-3195-1 Proto-Sound 3.0 M.S.R.P. \$649.95 80-3196-1 Proto-Sound 3.0 M.S.R.P. \$649.95
 80-3194-5 Proto-Sound 3E+ (3-Rail) M.S.R.P. \$679.95 80-3195-5 Proto-Sound 3E+ (3-Rail) M.S.R.P. \$679.95 80-3196-5 Proto-Sound 3E+ (3-Rail) M.S.R.P. \$679.95

Featuring:

- Die-Cast Boiler and Chassis
- Die-Cast Tender Body
- Engineer and Fireman Figures
- Metal Handrails
- RP25 Metal Wheels
- Sprung Drivers
- (2) #158 Scale Kadee Whisker Couplers
- Prototypical Rule 17 Lighting
- Constant Voltage Headlight
- Operating Marker Lights
- Operating Numberboard Lights
- Lighted Cab Interior
- Operating Tender Back-up Light
- Powerful 5-Pole Precision Flywheel-Equipped Skew-Wound Motor
- Wireless Drawbar
- Synchronized Puffing ProtoSmoke™ System
- Locomotive Speed Control In Scale MPH Increments
- Operates On Code 70, 83 and 100 Track
- Built-in 28-Function DCC Decoder
- Proto-Sound 3.0 Digital Sound
- Proto-Sound 3.0 models operate on 22" Radius Curves
- Proto-Sound 3E+ models operate on R3 (515mm) Radius Curves

M.T.H. Electric Trains HO articulated steam locomotives return in 2014 with the Triplex, perhaps the most interesting locomotive to ever ride the rails. Outfitted with sprung drivers, a powerful five-pole skew wound flywheel equipped motor, LED lighting, synchronized puffing smoke, full digital sound and a 28-function DCC decoder make this and

all M.T.H. die-cast metal steam locomotives HO's best steam power value.

The Triplex is in-stock at your local M.T.H. Authorized Retailer in three different paint schemes in multiple cab numbers. Choose from 2-rail versions or our all-new 3-rail stud rail version for use on Marklin stud track.



M.T.H.
ELECTRIC TRAINS™

HO TRAINS THAT DO MORE

www.mthHOtrains.com

Follow Us
 Online!





©2014 M.T.H. Electric Trains



intrigued by equipment that showed up a few years earlier or later, why not do a sliding era?

At the end of the day, there are lots of ways to do your layout era. You can do it as a precise day, month, year, or generalize on just a decade. Or you can do a sliding era like I am.

As far as I'm concerned, they're all valid if you're having fun!

 **Reader Feedback**
(click here) 

DID YOU ORDER YOURS?

AVAILABLE AT YOUR LOCAL WALTHERS DEALER

NEWLY TOOLED SIDEFAMES!
NEW POWER TRAIN CONTROLLED BY ESUI
NEW BODY DETAILS!
NEW SOUNDS!
NEW REAR LIGHT!



We kept the old LEDs.



THEY ONLY LOOK SMALL. THEY ARE REALLY HO SCALE

TRUE LINE TRAINS

QUALITY BEYOND COMPARE

- 100% new tooling*!
- KADEE #158 Couplers
- Designed in the USA
- Super detail
- Era specific details

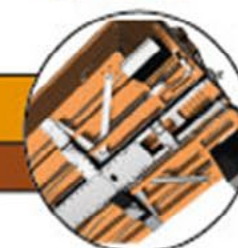
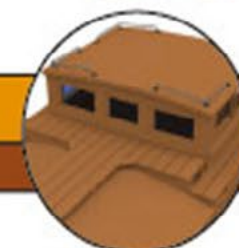

call us at 905 738 6556 or visit us at www.truelinetrains.com

True Line Trains Exclusively distributed in Canada by Canadian Hobbycraft Limited 445 Edgely Blvd, Unit #1, Concord, Ontario L4G 4K1

LIMITED RUN HO SCALE MODELS

Bachrus Inc

RUNNING ON QUALITY

Click me!



YOU DON'T HAVE TO BUILD IT...

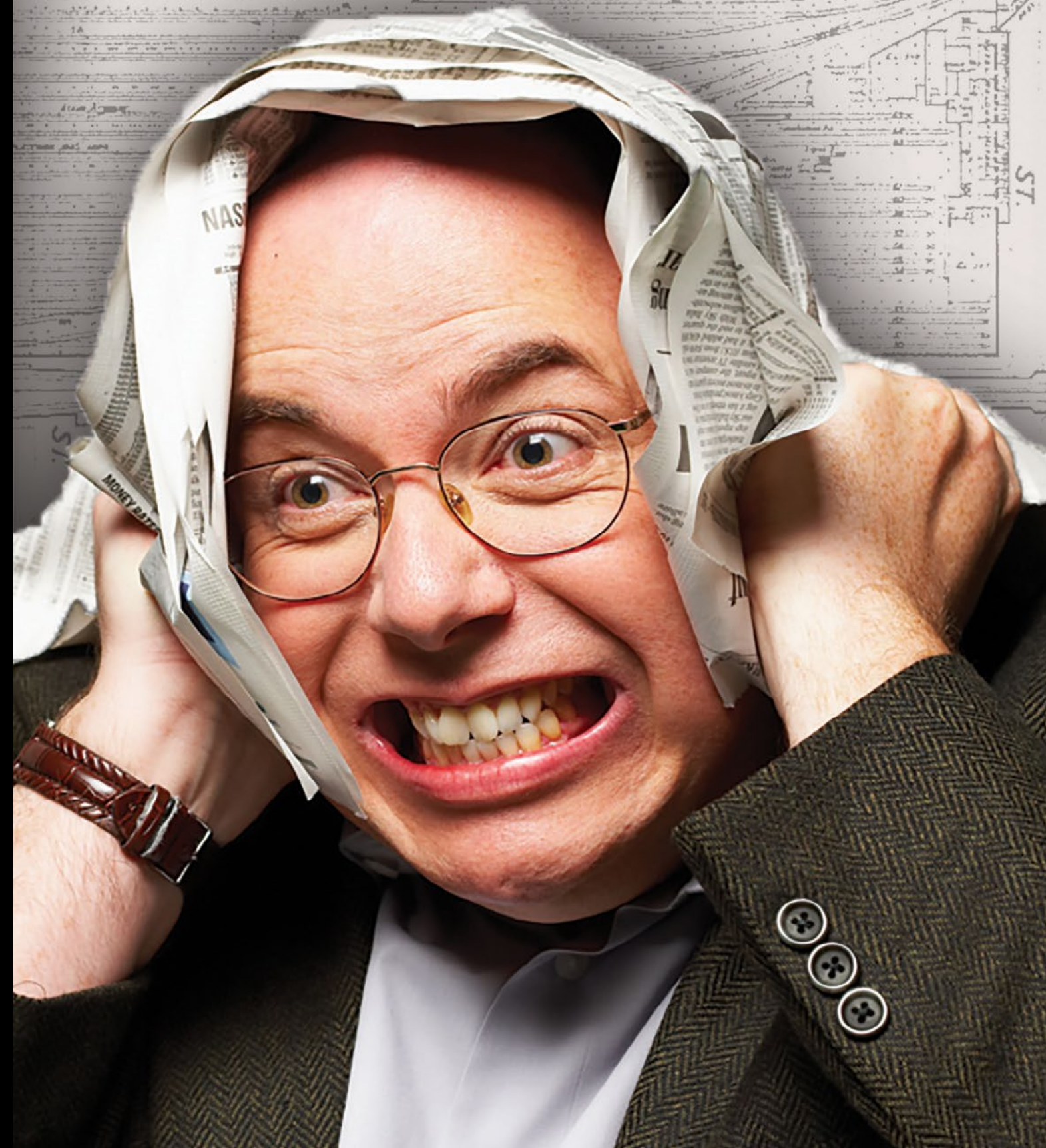

YOU GET TO BUILD IT!

With track building tools and supplies from...

FAST TRACKS!

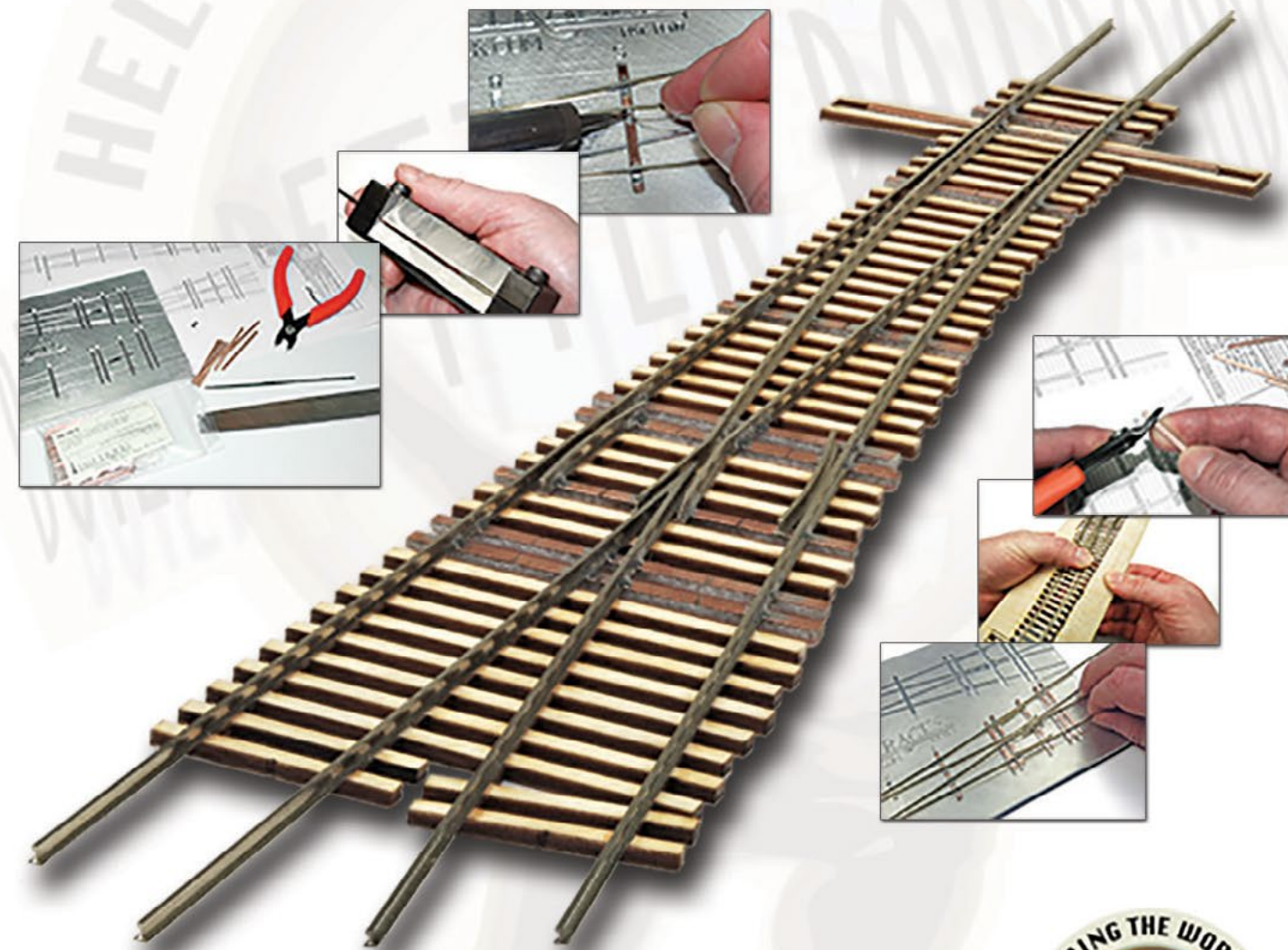

Visit handlaidtrack.com and start today. **FAST TRACKS**

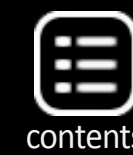

Notes from the MRH STAFF

MRH now #2 – passing up RMC, \$139 tablet for reading MRH, TMTV: New module-building series, and more ...

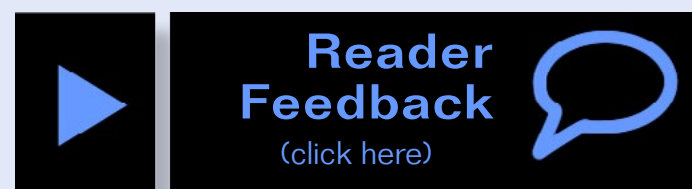

MRH now #2 – passing up RMC

This little magazine venture of ours, that we started back in 2009, has grown so it now appears we've overtaken *Railroad Model Craftsman* in circulation. Per the measures we list here, it's safe to say MRH has become the number two general model railroading publication in the hobby as to audience reach.

Let's take a closer look at the numbers. Many of these stats you can check for yourself. To make it easier for you to see where we get the numbers for MRH, our annual audience statement is on the following page.

CIRCULATION AND SUBSCRIBER NUMBERS

Here are the numbers each magazine reported as of January 2014:

Model Railroader:

131,981 total paid circulation;
97,940 total paid subscriptions

Railroad Model Craftsman:

41,177 total paid circulation;
21,973 total paid subscriptions

MODEL RAILROAD HOBBYIST MAGAZINE

STATEMENT OF OWNERSHIP, MANAGEMENT, AND AUDIENCE¹

Title of publication: Model Railroad Hobbyist Magazine

- ISSN: 2152-7423

Date of statement: 1 February 2014

Frequency of issue: monthly

- Number of issues published annually: 12
- Lifetime subscription: No charge (just supply email)

Location of office of publication:

Woodburn, Oregon 97071

County, Marion

Names of publisher, editor:

Publisher: Joe Fugate

Editor: Joe Fugate

Owner: Joe Fugate

Known bondholders, mortgagees, and other security holders owning or holding one percent or more: none

Extent and Nature of Audience² as of Feb 1, 2014

Total monthly unique device views: 111,111 (based on unique IPs)

Total monthly unique users: 73,333 (determined per [IAB guidelines](#))

Total monthly website visits: 232,208

Average duration of website visit: 7:25

Percentage of OS/devices used to visit:

Windows: 64.4%

iOS: 15.8%

Macintosh: 10.4%

Android: 7.5%

Linux: 1.3%

All others: 0.6%

Percentage of browsers used to visit:

Internet Explorer: 26.9%

Chrome: 24.4%

Safari: 22.1%

Firefox: 20.1%

All others: 6.5%

Total mailing list subscribers: 28,605

I certify that the statements made above are correct and complete.

Joe D Fugate Sr., CEO and Publisher

Model Railroad Hobbyist Magazine

¹ Per the Alliance for Audited Media and the Interactive Advertising Bureau (IAB), a totally digital publication such as Model Railroad Hobbyist must measure "circulation" by tracking *Audience* per publishing cycle (monthly in the case of MRH) since there is no direct physical publication to count. The Audience statistics reported here follow the strict guidelines set forth in this document published by the IAB and endorsed by the AAMI: <http://www.iab.net/media/file/IABAudienceReachMeasurementGuidelines.pdf>

² Computed and provided by Google Analytics (and can be independently verified by Google as correct and complete).



May 2014 MRH Ratings

The five top-rated articles in the [May 2014](#) issue of MRH are:

- 4.7 DCC Impulses: Programming track tricks
- 4.7 Tom Johnson's Logansport & Indiana Northern
- 4.5 Build a detector for \$10
- 4.4 Tool shed: Nibblers
- 4.4 Yes, it's a model

- Issue overall: 4.6

Please rate the articles!

Click the reader feedback button on each article and select the star rating you think each article deserves. *Thank you!*

Model Railroad Hobbyist:

73,333 total monthly unique users (circulation);
28,605 subscribers

By these counts, MRH has 30% more subscribers than RMC and 78% more readers.

The subscriber number is a hard number – we count subscriber emails to get the number of subscribers. However, the unique users number (our “circulation”) is a computed number derived using the IAB guidelines. The Interactive Advertising Bureau (IAB) is an official organization that defines the standards for how eZines measure their audience reach.

This all gets rather technical because we use Google Analytics to get help derive these visitor numbers. Google Analytics for the January issue of MRH shows that we had 111,111 unique device

Advertisement



1st choice for model railway supplies and service.

Expedited mail service available across North America.

Click to visit
WWW.CVRCO.COM
1 800 464 1730



MRH-Jun 2014



Advertisement

New detail items now available

- Always made in the USA
- 7 unique lasercut Billboard Frames
- 12 sets lasercut Graffiti Decals
- 16 styles lasercut Grade Crossings
- 21 different Rooftop Billboard Signs
- 35 sets Traffic & Advertising Signs
- 37 lasercut Structures & Bridges
- 1000's of satisfied customers

WHAT'S NEW?



HO & N since 1993

Blair Line



When talking to hobby vendors, please remember to mention MRH.



contents



index

visits, but this number does not equate to unique viewers. People may use more than one device to view the MRH website or to view our magazine. So we need to “de-dupe” Google’s visitors number.

(If you’re interested, here’s a discussion of [how unique Google’s unique visitors number really is.](#))

Per the analysis at the link above, they find the true unique users number is typically somewhere between 61% and 75% of Google’s unique visitors number. In our case, based on our 2013 reader survey and how many said they read MRH with more than one device, we use 66% as the factor we apply against Google’s monthly unique visits for the MRH website.

Doing the math gives us:

$$111,111 \times 66\% = 73,333$$

Per the analysis at the link above, our unique monthly visitors number could vary between 67,000 and 83,000. We feel pretty safe going with 73,000 since it’s on the lower end of the middle and it comes from our recent reader survey. It’s worth noting that any of these numbers are larger than RMC’s reported 41,000 circulation, which is the whole point of this discussion.

There is more ...

There are a number of other measures we can use to demonstrate MRH’s web audience reach versus that of RMC. All of these measures show MRH has the greater reach, lending credence to our claim that MRH has now become the number two general model railroading publication in the hobby, surpassing RMC.

Using stats from the web traffic tracker site, [similarweb.com](#), we find the following monthly website visits:

Model Railroad Hobbyist (model-railroad-hobbyist.com)
110,000 visits

Railroad Model Craftsman (rrmodelcraftsman.com)
20,000 visits

If we look on the number one website in the world, Facebook, we see as of this writing:

Model Railroad Hobbyist on Facebook
6748 likes

Railroad Model Craftsman on Facebook
5959 likes

If we check the number three website in the world, YouTube, (Google is the number two website after Facebook), we find only MRH and *Model Railroader* have official pages there, while *Railroad Model Craftsman* has no official YouTube page.

June 2014 Bonus Extras!

Available to subscribers!

DVD and HD quality versions of videos, plus:

- **Coupon code good for 20% off on TrainMasters TV 1-year or 2-year subscription**

Click here to access





SURE TO FIT YOUR BUDGET!



Click NOW!
(while supplies last)



- Kadee - NCE - SoundTraxx
- Digitrax - And more!



If you look at which of the major model railroading publishers have an official web video channel, only MRH (TrainMasters TV) and MR (MR Video Plus) have such channels. RMC has none.

By every measure listed here, MRH has passed up RMC and is clearly now the number two general model railroading publication in the hobby.

Reading MRH on a \$139 tablet

One of the least expensive tablets you can buy is the 7" [Amazon Kindle Fire HD](#) for \$139. The display on this little guy is 215 dpi, and the size is 1280x800.

We wanted to see how well this inexpensive Kindle would work for reading MRH, so we got one and put it through its paces. The conclusion? This is one sweet way to read MRH.

Just think, with this guy you can read MRH in your easy chair, read it in bed, read it in

the "throne room," take it into the layout room or take it to your workbench, and you can also bring MRH with you on the go.

The \$139 version has 8 GB of memory and includes wi-fi, so if you are near a wi-fi hotspot, you can click the comment or ad links on an issue and go to the page on the web. That 8 GB will hold over 100 issues of the MRH Standard Edition, so you can take your entire MRH collection with you!

We've found the best app to use for reading MRH

on an Android tablet like the Kindle Fire is ezPDF Reader PRO (see the icon at the right). This app costs \$4 to download, and it does a very nice job displaying the MRH Standard Edition PDF. All the links are clickable, and the Portrait format of MRH is very readable.

You can pinch-zoom on the images and you can watch the linked videos and click-n-spins on the Kindle Fire HD tablet.

We find downloading the Portrait version to be as easy as opening up a browser session on the MRH website, clicking the green *Other copy options* button for the portrait version, and clicking the link for the Standard Edition. It will tell you it's

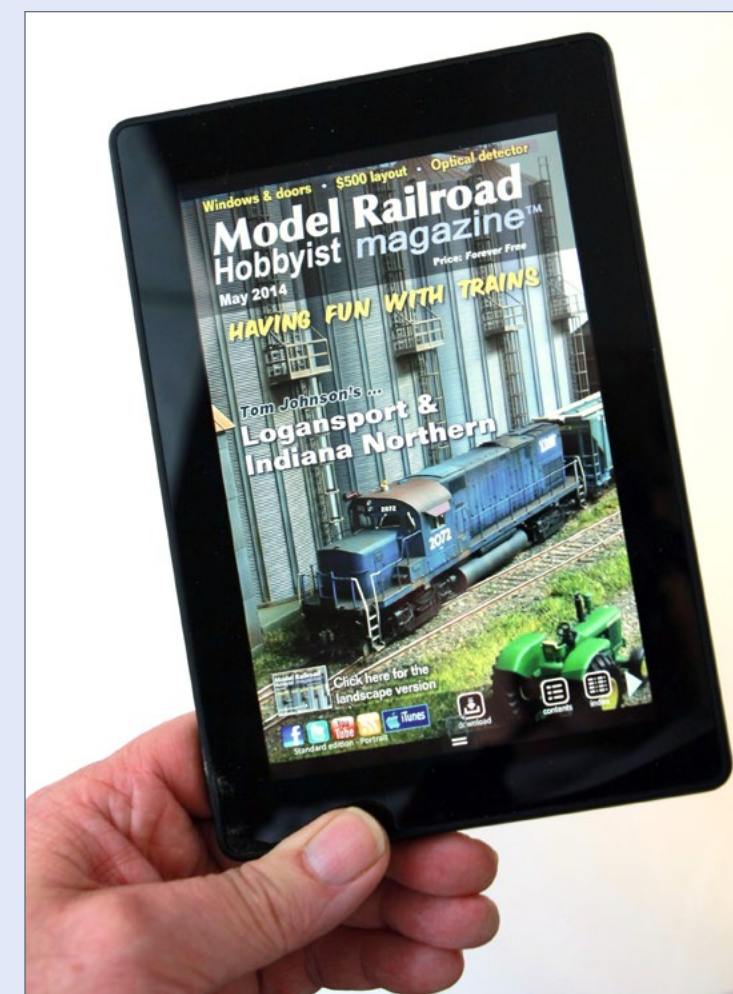

MRH on Amazon's new 7" Kindle Fire HD, price: \$139.

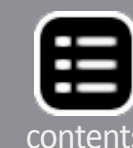
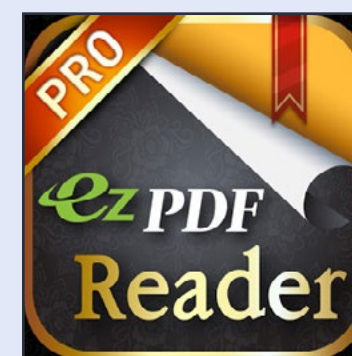

downloading the issue and in a few moments (depending on the speed of your wi-fi connection) the issue will be on your device. Look in the All PDFs area of ezPDF Reader to find it.

We feel reading MRH on a tablet takes it to a whole new level as compared to reading MRH on a computer. It's way more convenient than using a laptop – and at \$139, it's a whole lot cheaper.

Did we mention that TrainMasters TV videos (using the alternate player) also play nicely on the Kindle Fire HD?

TMTV: New module-building series coming

Speaking of TrainMasters TV, a new how-to series is coming to TMTV. Trevor Marshall of Model Rail Radio is working with us to do a series on building Free-Mo modules in S scale.

We like S scale because it's large to show up well on your video screen, and the techniques will apply to other scales as well. (Plus, S scale is just a darn nice size to build in, regardless).

If you'd like to know more, or if you'd like to talk with Trevor about the series, see this thread on the MRH website: mrh-mag.com/node/18021 ...

We are running a TrainMasters TV survey with MRH readers. We're looking to see what extra-value video we could bring to TMTV for you. This survey is your chance to tell us what would be of the greatest value to you.

TrainMasters TV's motto is "helping you become a better modeler, one video at a time." As we do the hobby, we all hit roadblocks and things we'd like some good solutions too. If you have some things you'd really like to see demonstrated for you on video, let us know and we'll see if we can pull something together.

Remember to take the TMTV survey!

Advertisement

CON-COR
con-cor.com

New! HO & N 53' Containers
2-Packs: HO \$27.98, N \$18.98

New! HO MUmp54 Cars with aluminum windows

"N" Amtrak Tri-Levels 3 Paint Schemes
Multiple Car #'s; 6 More Roads

Who is Bobby Banana?

Check our website for full details on all items.
www.con-cor.com

CHECK IT OUT!

Advertisement

Railroad Explorer Magazine

ISSUE 39 FALL 2013
THE EASTERN RAIL PHOTO JOURNAL

- Three, all-color issues per year.
- Exciting feature stories, spectacular photos.
- Best-in-class photo reproduction.
- Printed on heavy, glossy paper.
- Zero advertising. All content.
- Winter, Spring/Summer and Fall editions.

Issue 39 - Fall 2013
On sale now
Subscribe Today!
www.railroadexplorer.com

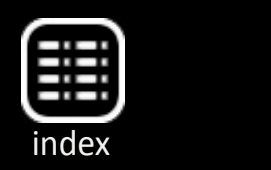

Submitting an article? Remember the bio!

We get a lot of article submissions that fail to include an author bio, so we're reminding you budding authors here to remember to tell us about yourself!

We like to get a "mug shot" of you, ideally in a model railroad setting, but even standing in front of a blank white wall will do.

Also give us a few paragraphs about yourself: first, tell us how you got into the hobby, then tell us about your current hobby pursuits and passion. Finish up with a little about your family, what you do for a living, and what other interests you may also have.

We cover all this in our author submission guidelines (model-railroad-hobbyist.com/submission-guidelines).

Please read and follow these guidelines – it makes your submission feel a lot more professional, and by following these guidelines, you make our job of converting your article into its final published form a lot easier.

Ops Live 5 & 6 videos coming this summer

This summer, we're coming out with Ops Live volumes 5 and 6, this time on Mike Confalone's Allagash. We've completed the 4-volume eBooks series on Mike's layout, and now we're completing our 2014 "Allagash Bash" by coming out with two Ops Live videos on Mike's railroad. Volume 5 covers general operations on the Allagash, and volume 6 focuses on operations in New Sharon yard. You don't want to miss these new additions to the Ops Live series!

This issue

John Golden has done a fabulous job in this issue's cover story describing how to build some nice models of the Seaboard B-8 and B-9 boxcars. Even if you aren't building these specific models,

YOU can help change the future of model railroading video ...

Tell us what you think*

Take the
Model Railroading
video survey

click here



*Participants get entered into a free drawing for a Kindle Fire HD tablet!

you'll want to peruse John's article for some great techniques you can use on any rolling stock model project.

We also present some nice how-to tips on steam-era freight car weathering from Charlie Duckworth, and if you ever wanted a fast and easy way to make a lot of dandy-looking deciduous trees quickly, you'll want to see Randy McKenzie's Fast and Easy Trees article. Rob Bennett shares how to use Vallejo earth texture to get a very believable textured industry roof in short order.

We're publishing the first place winner of our \$500 Layout Design Contest this month: Eugene Griffin's present-day era HO layout design, getting you off to a great start for just \$500!

Because Bruce Petrarca is taking a vacation this month (he's travelling abroad for fun), we're running a couple of electronic circuit articles for you.

First we have Dave Bodnar helping you discover the possibilities of remote control using the simple PICAXE kits aimed at helping high-schoolers learn modern electronics. Then the MRH staff takes a look at RR-CirKits great new highly affordable signaling circuit boards.

This leaves our regular columns in this issue. First is Getting Real, where Marty McGuirk gets brave and completely destroys and rebuilds the Williams Creek bridge scene on his HO SNE layout.

Larry Smith, our branchline and narrow gauge guy, starts a build of a coal tipple, and Ken Patterson looks at some awesome weathering decals by Joe Steimann.

Finally, Publisher Joe Fugate provides both the editorial on setting your layout era, and some contrary thoughts about a model railroad that feels like the real thing, in Reverse Running.

NEW for JUNE

87-1475 & 60-1475
Susquehanna (NYS&W)
SD60, SD70M, SD40T-2 Diesel Locomotives

87-1476 & 60-1476
Santa Fe (ATSF)
50' and 60' Plug Door Boxcars

87-1477 & 60-1477
Reading (RDG)
Heavyweight Passenger Cars

87-1479 & 60-1479
Landmark (TLCX and PTLX)
4740 and 4750 PS Covered Hoppers

87-1480 & 60-1481
CSX Intermodal (CSXT)
Assorted Well cars

87-1481 & 60-1481
Maersk/Sealand 40' and 45'
International Containers

Click to View Online Catalog

Microscale Decals® microscale.com MADE IN THE USA

Remember
You can click
on the Email
or Phone
buttons (with
a smartphone)
to contact a
sponsoring
advertiser!

Also tell them
“Thanks for
sponsoring
MRH!”



Combo Right Clamp™

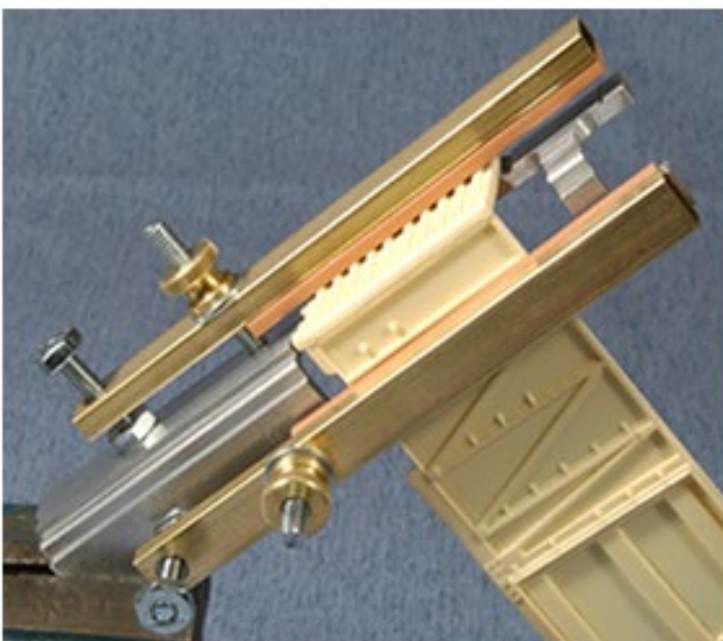

Combo Right Clamp™
with cast resin boxcar

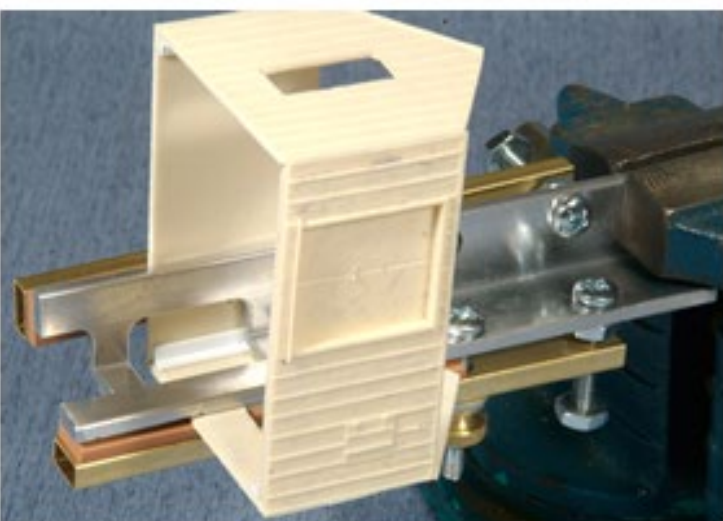

Combo Right Clamp™
with Wolf Design Pump House

**Click here for
all our products ...**

Tools for Modelers

Coffman Graphic Solutions Co.
1500 River Circle, Richmond,
KY 40475-7907



[← back to previous page of text ...](#)

Bringing up the rear is Derailments, this time featuring a railroad-themed music video that's a little tongue-in-cheek, but has a good message.

Enjoy June's MRH! If any of you are going to the PNR convention in Tacoma in June, make sure and say hello!

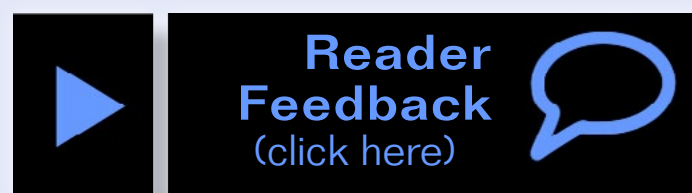

**Making
DCC
FUN!**

Check Out Our Website for New Products!



HO TSU-IM1000 Digital Sound Decoder



www.Mr-DCC.com

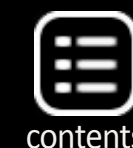

June ...



Visit TrainMasters.TV website

Tom Wilson: Modeling Steel Making



LAYOUTS

KEN'S ROUNDHOUSE



Michel Boucher's Delaware & Hudson



New York ALCOs

DCC DECODED



Programming Decoders

LARGE SCALE RAILROADING



Ops party on Barry's Backyard

MRH Subscribers save 20% ...
[click here to find out how](#)



Mike Confalone's ALLAGASH STORY

4 volume eBook series



Order Allagash Story

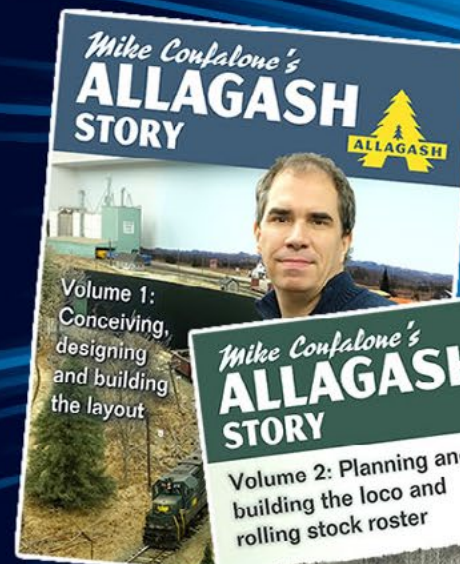

Volume 1:
Conceiving,
designing
and building
the layout

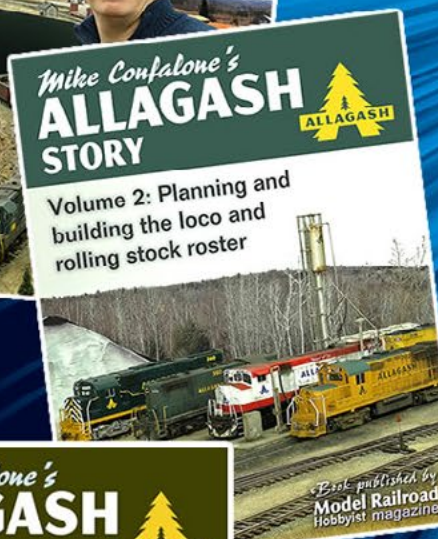

Volume 2: Planning and
building the loco and
rolling stock roster



Volume 3: Planning
prototype operations

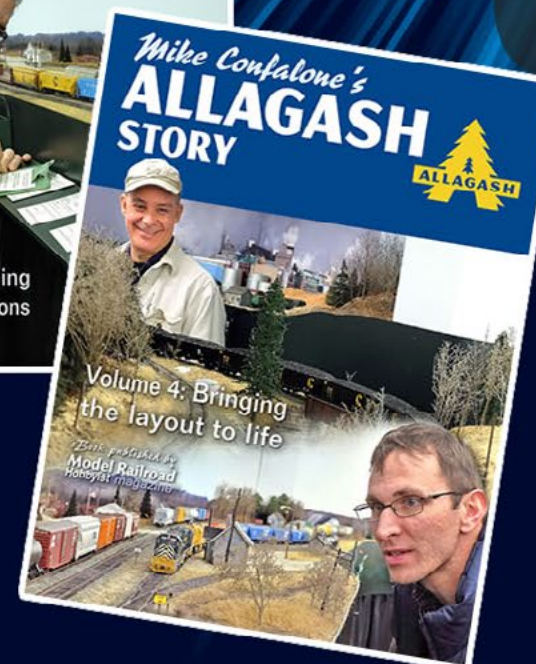

Volume 4: Bringing
the layout to life

Vol 1: Building the layout
100+ pages - \$8.99

Vol 2: Building the roster
100+ pages - \$8.99

Vol 3: Planning prototype ops
90 pg + forms - \$8.99

Vol 4: Bringing the layout to life
100+ pages - \$8.99

4 volume set: ~~\$35.96~~

Special: \$29.99

from the
**Model Railroad
Hobbyist Store**

Formats: PDF - ePub - Kindle



MRH

Questions, Answers and Tips

 **Reader
Feedback**
(click here)



QUESTIONS AND ANSWERS

Tune up a Bachmann Alco

Q. I just purchased a Bachmann RS-3 [1] Sound Value last week and it is a very smooth runner and the sound is really nice. After a brief test, I repainted it for my road, then programmed it and put it into service.

I am having a problem with the trucks. They seem to “hunt” for the rails and eventually derail, especially at turnouts. I took the truck side frames off to clean out the gears and remove the excess goo/lubricant that was in there, and that seemed to help quite a bit. I also cleaned the wheels with alcohol. However, I still have a random derailment here and there, usually on the leading truck on the long hood end. I don’t have any problems when going in reverse.

Has anyone else had a similar problem with their Bachmann RS-3? I am wondering if this problem stems from the fact that the Bachmann wheelsets essentially snap into place and don’t have much room to move around.

– Eric M.

A. Jeff Shultz recommended checking the wheelsets with an NMRA gauge, and inspecting the wheels to see if one of them is loose or tight, or the wheel isn’t on the axle quite square.

Prof Klyzlr added another possibility. Are both wheelsets gauged such that they are equal on centerline? It is possible that the wheels can be correctly gauged in terms of how far apart the wheels are, but one wheel can be closer to or farther from the track center line.

His quick extreme example [2] shows a freight car truck with off-set wheels. The red line is the track center line. Due to the offset gauging, both wheelsets are spaced the correct distance apart



1. Eric M’s Bachmann RS-3 Sound Value looked great but had a derailment problem.

but the rails (blue lines) are not parallel to the center as they should be and the red line is not perfectly centered between the blue lines representing the rails.

The result is the truck crabs down the track at an angle, and will pick the smallest imperfection on the inside face of the rail, climb over the rail, and derail.

Another check: place the loco on a known dead-flat surface, like a sheet of glass. Get your eyes right down to wheel level, and

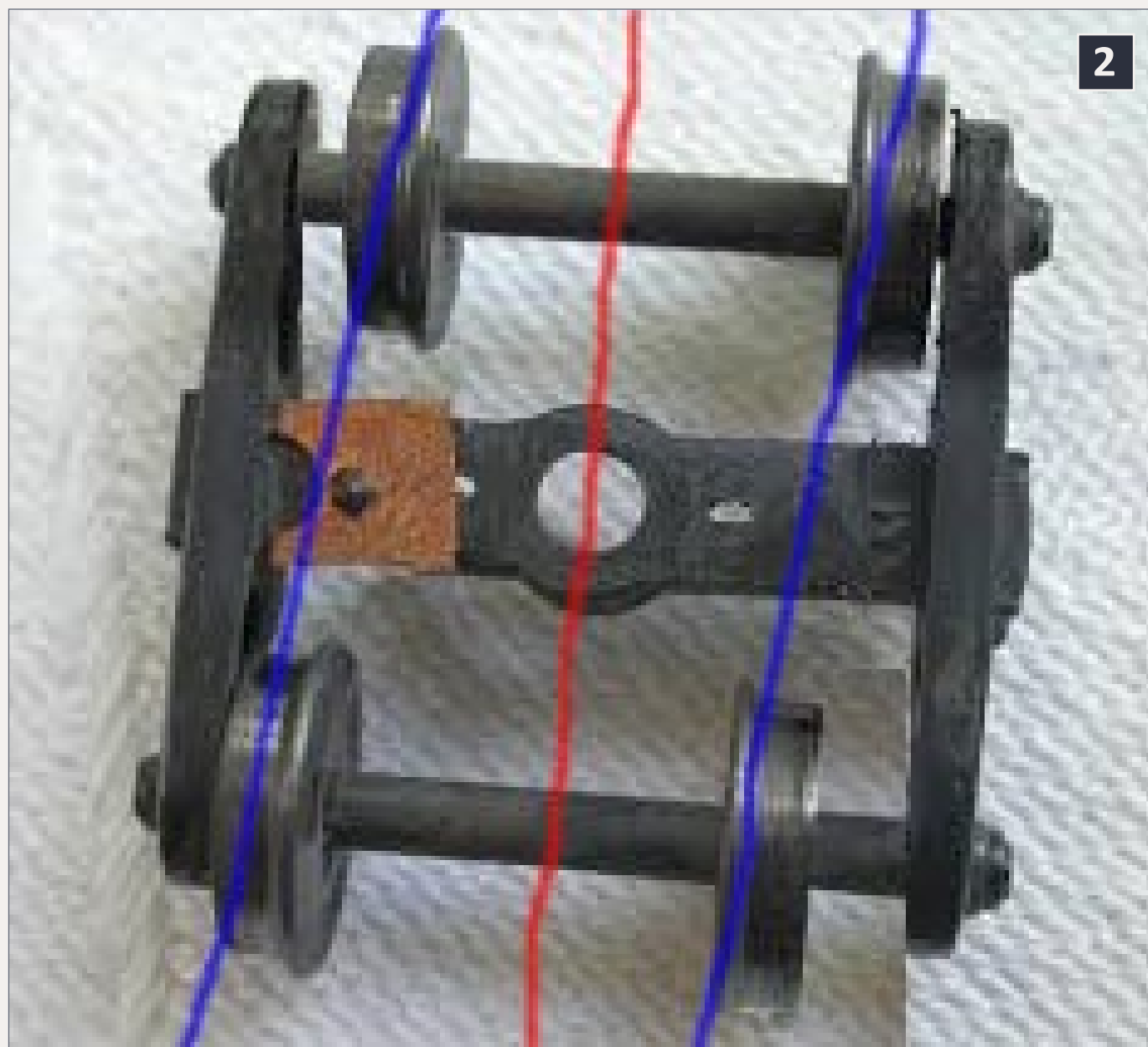

2. Prof Klyzlr's illustration shows how off-center wheelsets can lead to operational headaches.

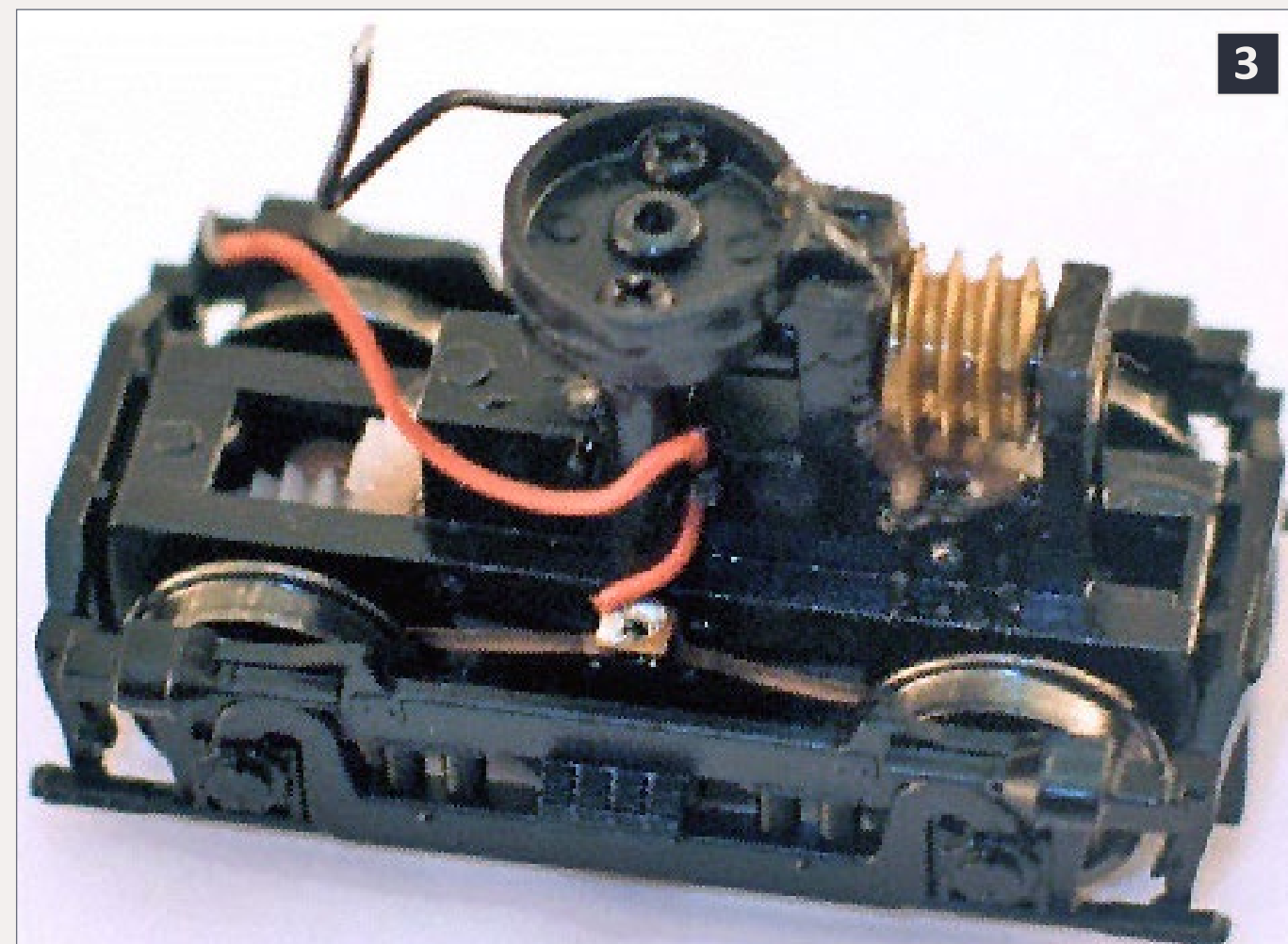

3: Bachmann's power trucks are attached to the frame with a screw. Check to be sure it isn't too tight.

see if all four wheels are flat on the glass. If any one wheel is floating, then either the axle mounting is incorrect or the truck assembly may be bent. Remove the truck, take it apart, and check for ridges of flash or warping.

Fuzzy adds a third possibility: A screw on top of the Bachmann truck holds it to the frame. Just as a freight car's kingpin screw can cause derailments if it's too tight, these screws can also affect the locomotive trucks' performance. Rock the truck in all directions to see if it feels a little snug; if not, then you don't have to worry about taking the body shell off to get at that screw.

John said: I have used the Bachmann FTs and have encountered problems with the wires from the truck binding and causing

derailments. The newer FT models have a truck [3] similar to the RS truck. The trucks, due to the mounting tower, can be fragile. It is a good idea to inspect for damage or misalignment of the tower assembly and truck.

In addition to doing the above tune-ups, said Nelson Beaudry, “what I did to allow the wheels to follow the track contours better and provide for more consistent electrical power pick up is to very carefully file the openings the axles snap into. All you want to do is remove the small bump that holds the axles in. This will allow the axles to move up and down independent of the truck assembly.”

While this conversation was unwinding on the forum, Eric was doing his own checking. “Moving the trucks, they seemed to both be pretty free,” he said, “but the lead truck did seem slightly tighter than the other one. And watching it on the curves, it did seem a little stubborn to move with the curves, so that may definitely help. Since this is my first Bachmann, I am unfamiliar with this truck assembly, so this really helps.”

“And the winner is ... the lead truck is too tight,” Eric said. He measured the wheels and they were in gauge. “With the shell off, I inspected the trucks better to see how they are connected to the frame. The lead truck was definitely tighter than the other truck. I completely unscrewed the truck assembly from the frame to see how it works and how it fits in, then screwed the truck back in until it just barely kept it from falling out. I tested it around the layout and no derailments! I could see the lead truck bouncing up and down a little through curves and turnouts but it kept inside the track every time. Thanks again for everyone’s help.” (Bachmann RS3: mrhmag.com/node/17710.)

– MRH

Work-between track warrant

Q. On simplified Track Warrant Control papers I use on my layout, box 4 says:

Work between _____ and _____ on _____ track.

Say I am the dispatcher and I have a train crew who needs to work a couple of spurs connected to the mainline through a siding. The crew needs to get out of town A with a turn and asks for a track warrant to work the spurs at A and B. The crew needs to work both sidings’ turnouts as they have to perform some runarounds to actually spot cars. Should I (the dispatcher) issue the following track warrant?

Work between A and C on main track.

Or should I issue this?

Work between A and B on main track.

A. The warrant’s purpose is to grant authority for occupancy and protect the safety of that train and other trains. The second choice, “X box 4: work between A and B on main track” is the better one. The train has been given authority between A and B, so it can make forward and reverse moves between those limits in safety, including runarounds, and no other authority can be given within those limits until the warrant is released. Extending the warrant to C ties up track the local doesn’t really need.

There are some big “buts” for the dispatcher to consider. The track covered by the A and B limits has to be long enough to let the train crew carry out its work. The occupancy granted should not be so vast that it interferes unnecessarily with other traffic.

Byron Henderson offers some help: “What can help in the model where you need to give the ability to do a runaround, without tying up track all the way to the next town, is to name an intermediate point. On Rick Fortin’s fabulous 4th District

Santa Fe Coast Lines layout (fortinweb.com/swsf/), we have named intermediate points between each town. That way, you can give enough authority to allow work to occur in one or more adjacent towns. Some people use milepost markers; we name specific points on the layout (marked with a small card on the physical layout so there is no ambiguity).”

“Because our layouts are always so compressed for space compared to the real thing,” Byron says, “these extra landmarks help us keep things moving smoothly without creating overlapping authority.”

Charlie Comstock prepared a track warrant refresher for his crews that is of interest to anyone starting out with track warrants.

Go to s145079212.onlinehome.us/rr/operations/session.html and a link to the PDF is near the bottom of the page, on the left.

Work-between warrants: mrhmag.com/node/704.

More ops discussion: mrhmag.com/node/731.

– MRH

Wheels won't roll

Q. I've been getting some of the Walthers 50' bulkhead flats lately. These aren't bad cars, especially for the prices I've been getting them, but the wheelsets leave a lot to be desired. I can actually place them on a 3% grade and they stay! Has anyone fixed this problem without replacing them? I got some of their woodchip gons and they come with the same wheelsets, so I'll have even more to do.

– Steve

A. The axle tip/truck reamers [4] from Micro-Mark (micromark.com/ho-truck-tuner,8241.html), Reboxx (reboxx.com/wheelsets.htm) and other sellers make it a lot easier to get free



4. “The Tool” truck bearing reamer cleans paint and excess plastic out of the bearing points on plastic trucks.

rolling wheels in your trucks. There's no guarantee replacement metal wheels will roll any better if they're a tight fit in the truck side frames or the bearing surfaces aren't clean.

After hearing this, Steve said, “Thanks guys for all of the replies. I got a product called ‘The Tool’ ... I gave each axle a spin ... I found that the axle would free spin about 1 to 3 seconds and come to an abrupt stop. I was surprised how much plastic I would remove. The sooner the axle stopped during the free spin, the more plastic I took off. I gave each a spin after using The Tool on both axles and found that they would free spin about 5 to 10 seconds and slowly wind down to a stop. There was also a noticeable torque feel to the truck that wasn't there before, kind of like what a top or gyro would give off. This has to translate to some improvement in performance.”

The two reamers mentioned aren't identical. The Micro-Mark item measures 25.86 mm tip to tip, and the Reboxx Exxact Tool 23.51 mm.

In the packaging for the Exxact Tool is a paper stating "The current design of Exxact Tool was made a little shorter to make it easier to insert them into the side frame and remove them from the same. The trick in using them is to make sure that when you squeeze the side frames together, you align the side frame which is being cut so that it is perpendicular to the axis of the cutting tool. A little more pressure needs to be applied than was necessary with previous longer tool."

Once the truck is tuned, dab a little fine powdered dry graphite like Kadee Grease-Em into the bearing point with a Microbrush.

Walthers wheels: mrhmag.com/node/517.

Truck tuning tool: mrhmag.com/node/17080.

– MRH



TIPS

Tenax advantage

In the article about building a boom gondola car, the author stated he used a paint remover before bonding styrene parts to the gondola. There's no need to do that if you just use Tenax-7R. It will bond styrene to styrene even through a painted surface. Apply the Tenax, press the pieces together, and the paint will bubble up. Just leave it alone and after the Tenax-7R evaporates, the paint will settle back down.

– Richard Napper

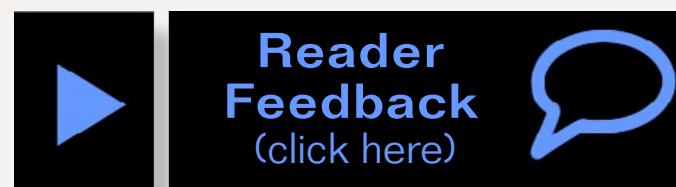

GET \$25 PER TIP

We pay \$25 USD for each tip we publish.

[Send your modeling tips to Model Railroad Hobbyist](#) and we'll get payment to you upon acceptance.

Just think, for only a few minutes effort, you could fund your next piece of rolling stock – or even pay for an entire train if you send in several tips and we publish them!

If you include any photos with your tip, we pay a bonus of \$10 per photo we use with the tip. ■

Advertisement

The Atlas Master® H0 S2 Locomotive

Featuring ESU Loksound and all new tooling, the Atlas Master® H0 S2 Loco is a highly detailed, versatile model that can be run on your shortline or industrial railroad.



BUY YOURS NOW!



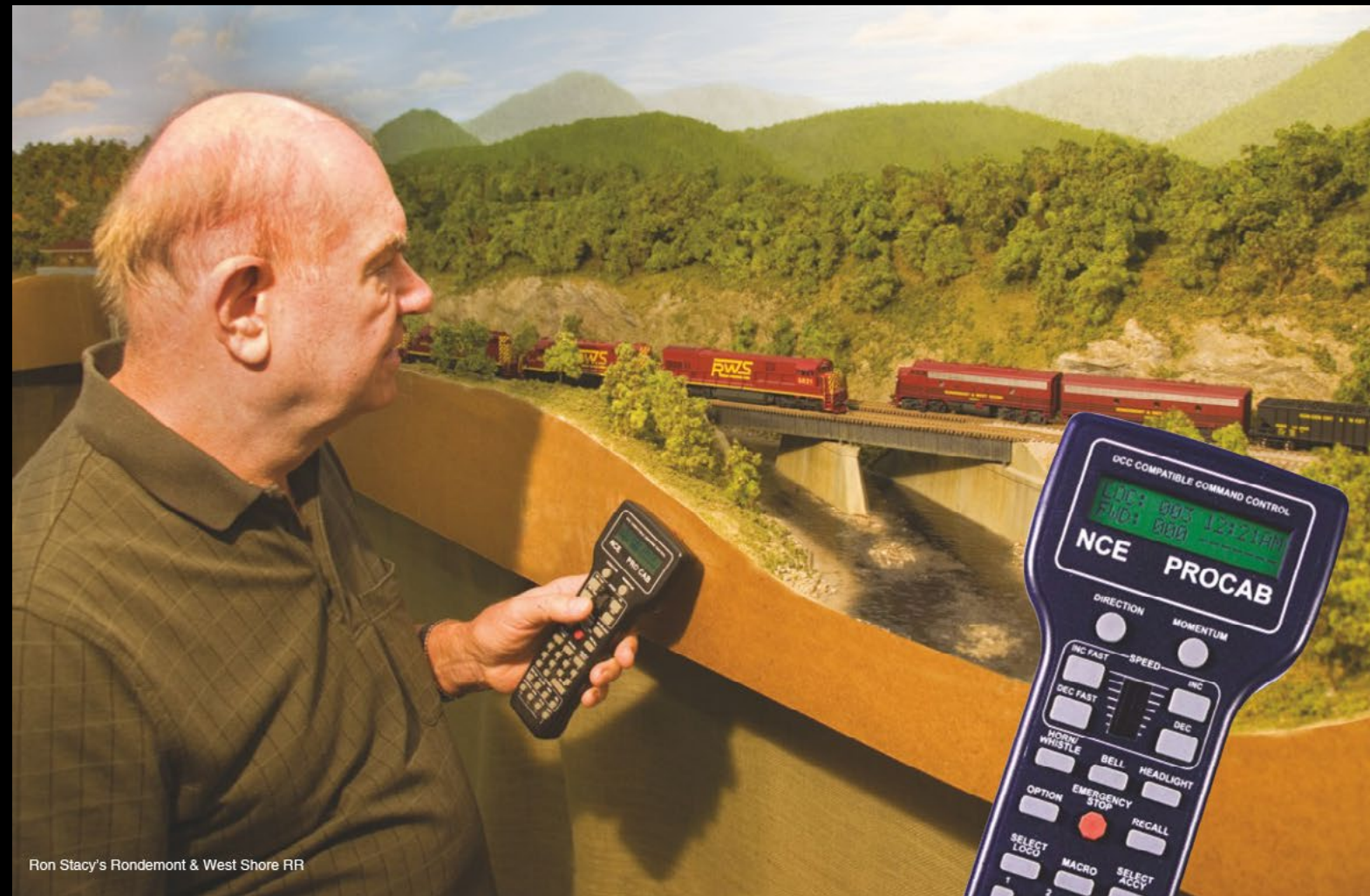

Ron Stacy's Rondemont & West Shore RR

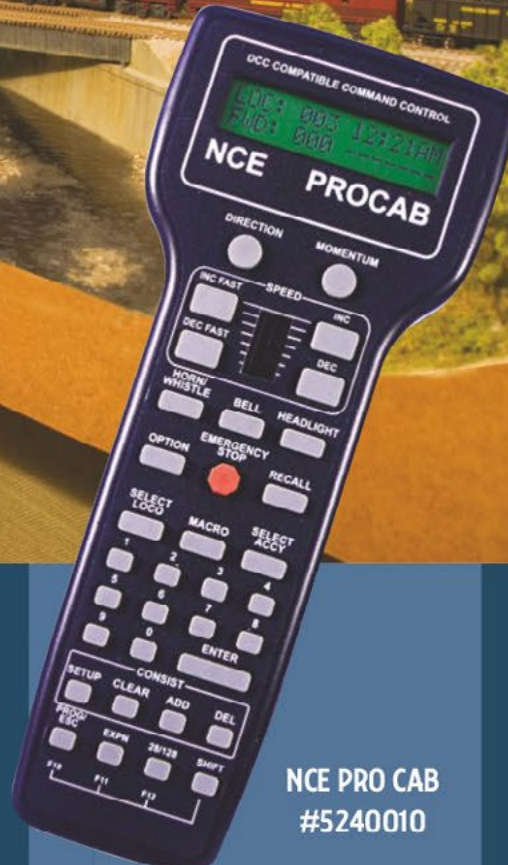

NCE PRO CAB #5240010

From first train set to railroad empire...
 Our complete line of DCC products Grows with you. Rediscover the fun!

- Designed and manufactured in the U.S.A.
- Preferred for ease of use and ergonomic design
- Unlimited scalability for any size model railroad
- Plug-and-play means more time running trains
- Great customer service and excellent support

Our deluxe Pro Cab™ provides the most user-friendly access to all DCC system features. You'll spend less time pushing buttons and more time running trains! Simple menus on the easy-to-read backlit LCD display will guide you through the most advanced operations with no fuss. Carefully placed controls make controlling speed and functions feel like second nature. Rediscover the fun with a Pro Cab from NCE!



See your dealer or visit ncedcc.com

NCE CORPORATION • 82 EAST MAIN ST. • WEBSTER, NY 14580 • 585.265.0230

NCE Provides the FULL Spectrum of DCC

You don't have to learn it Every time you use it!

- Extraordinary Performance
- Radio or Tethered
- Highest Rated DCC Systems
- Made in the U.S.A.

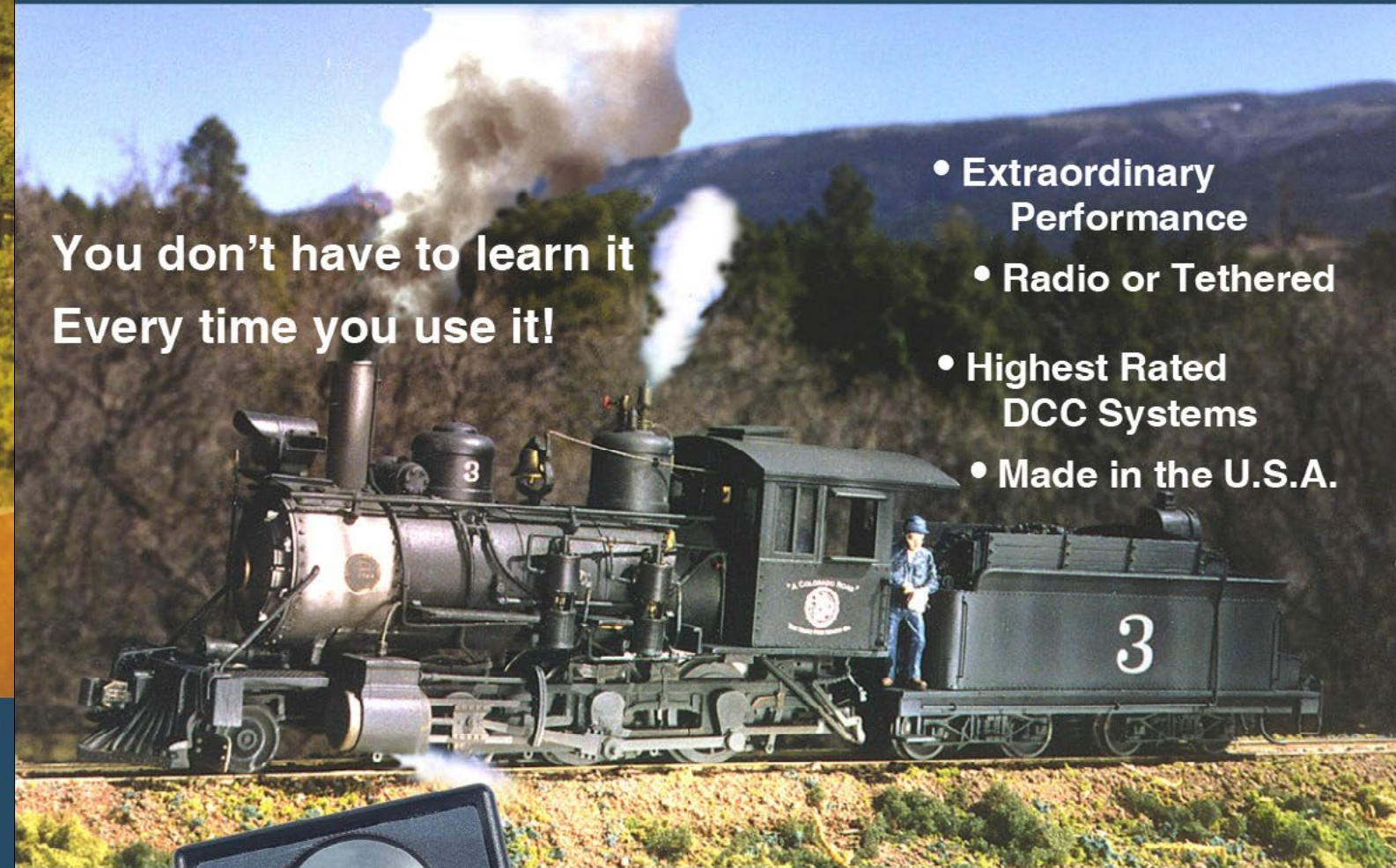

Cab06pr #5240044

The Cab06pr is representative of TEN hand-sized "road cabs" that we offer. Grab this throttle and head out to far away places on your layout. The road throttles come in potentiometer, encoder, radio or tethered models starting at only \$89.95 MSRP.



Discover the FUN With NCE!



Call or Email for FREE Brochure

Support@ncecorporation.com • 585.265.0230 • 9am-4pm EST www.ncedcc.com





Many species of Conifer trees available!



Lodgepole Pine



Green Spruce



Blue Spruce

Also see our other conifer offerings ...



Relocating Williams Creek bridge

Modeling real railroads and what they do



Getting Real column

by Marty McGuirk

Saving a favorite scene from the scrap heap ...

I swear it's not the case, but to regular readers of this column, it must seem that my fellow Getting Real columnist Mike Rose and I are in some sort of bizarre race to see which of us can completely rebuild his layout one section at a time.

I won't speak for Mike, but in my case there's something of a domino effect going on with all these changes to my HO Central Vermont. I change one thing, and before I know it another potential change (or two, or three, or six...) suggests itself. You may have experienced what's commonly called the "might as well..." syndrome in everything from home remodeling to model railroading. You know, the one that ends with the line, "If you're going to change that...you might as well change this while you're at it."

So when some of my regular layout helpers showed up for a Monday work session in January, they were surprised – actually shocked – to learn the first item on the to-do list was to

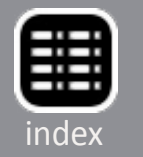

remove the freelanced paper mill scene in favor of a prototype-inspired scene based on Randolph, VT. Extending the Randolph passing siding quickly became one of those “might as well” projects. Only problem was, the Williams Creek bridge (ironically one of the few finished parts of the layout) was firmly in the way [1].

Rather than destroy the bridge scene, I wanted to see if it could be salvaged and reused. Although we managed to remove the bridge intact, I didn’t know exactly where it would



1. The Williams Creek bridge scene, which has been featured in *Model Railroad Hobbyist* is currently the most recognizable scene on my HO scale Central Vermont – if for no other reason than it’s the first scene that was “done.”



2. The Williams Creek section was too bulky and heavy to slide around on top of the layout – and doing so would play havoc with the track and trees – so I made a full-sized cutout of the section to determine a good spot to locate the section.

end up, meaning from January until late March the Williams Creek scene sat unceremoniously on a shelf in our utility room “awaiting disposition.”

I know, from prior experience moving and rearranging layout pieces, oftentimes it’s a difficult, if not impossible, task to reuse an existing chunk of layout. Based on the width of the bridge section, the shape and width of the layout, and the location of various towns and other elements I couldn’t locate a new home for the bridge scene anywhere on the layout. Or so I thought.

I traced the section full-size on a piece of paper, being careful to accurately mark the outline of the section and the track centerlines at each edge, as well as the position of the river. The

most obvious potential area site was the long section of tangent track on the Essex Junction side of the peninsula.

It quickly became obvious the best place for the Williams Creek bridge was where I had started building a second river crossing with a through truss bridge, a deep gorge, and lots



3. Here's how this area of the layout appeared before the background hills and trees were removed. The Williams Creek section will end up just beyond the truss bridge.



4. After stripping the trees from the hills and removing the hills themselves, I placed the Williams Creek template in what will be its final position. Placing the bridge fit well with the existing layout benchwork, and more importantly, didn't intrude on valuable aisle space.

of trees. But this scene wasn't looking quite right, and in fact had sat "almost finished" for more than a year. I just couldn't seem to get the various elements to work. In other words, I'd hit a creative roadblock ("Modeler's Block" as opposed to "Writer's Block?")

No matter what it's called, a lack of progress due to such a block is a sure sign something is amiss. In the end, it seemed silly to have a complete scene sitting in the storage room with a less-than-satisfying segment of the layout staring me in the face.

The template showed the spot was just about the correct width, and the scene could be dropped into place with only some minor track rework. The installation of the bridge section wasn't quite that simple. After a long afternoon, I

managed to get the tear-out finished, and modified the 1x4 grid benchwork to fit the underpinnings of the bridge and river in place. Another couple of evenings were needed to reroute the mainline to align with the bridge tracks. I ended up replacing the Styrofoam subroadbed and deep chasm with new birch plywood subroadbed, and relaying about 12 feet of mainline.

Composing the new scene

After installing the plywood subroadbed, I played around with various arrangements for the remainder of the scene. This



5. After a long afternoon (and most of the morning) the Williams Creek section was securely fastened in its new home. Obviously the mainline needs some realignment!



6. Initial plans called for adding a road (represented by the gray cardstock), a country store, and a stub-ended siding with a small freight house and station. Not only would this scene have drawn undue attention to the end of the backdrop, it was still just a little too “busy.”

section of the layout is about 17 feet of single-track mainline running through the countryside. I played around a lot with this section, considering all kinds of possibilities ranging from a large water-powered mill complex to a small town, to a large “destination industry” like a paper mill or plywood plant. I arranged, and rearranged structures and track so many different ways I lost track.

In the end, the answer became clear – simpler is better – “Less is more,” as some of my friends are fond of saying. But

even “less is more” is a moving target. At first I planned a simple stub-end siding, and a country lane coming down a hill past a Greek Revival country store. I played around with several arrangements of these elements, but one issue I kept running into was any sort of eye-catching element – like a structure – would immediately draw the viewer’s eye toward the end of the peninsula backdrop. As neat as the country lane with the store might be, I really needed a scene that wouldn’t draw attention to the end of that backdrop.

At this point I remembered a Pete McLachlan photo of the Whiting Creamery in Waterbury, VT [7]. I used a Sanborn Map of Waterbury to determine the basic footprint of the building and placed it on the layout to confirm the building would fit the area. Then I created a three-dimensional mockup. I did run into one problem – the photos I have of the creamery all show these same two sides – so I had to use some modeler’s

license to determine the window/door arrangements on the other two walls. Since there’s a road crossing the tracks on the far side of the creamery, I added a road running from the fascia toward the backdrop. On the layout, this road will curve slightly and disappear over a slight rise and behind some trees.

I dedicated a few more evenings to completely reworking the landform scenery on both sides of the bridge [8].



7. Whiting Creamery, Waterbury, VT. Pete McLachlan photo, circa 1956.

Advertisement

THE ORIGINAL SURFACE DETAILS

PRECISE SCALE RESIN RIVETS,
LOUVERS, TREADPLATE, WELD BEADS
AND MORE ON CLEAR DECAL FILM

CLICK HERE TO WATCH VIDEO TUTORIAL

CLICK HERE TO SEE THE RESULTS

CLICK HERE TO BROWSE AND BUY

Archer Fine Transfers • PO Box 1277 • Youngsville, NC 27596 • USA
(919) 570-1026 • info@archertransfers.com • archertransfers.com

Advertisement

County Line Liquors - kit # ST013
\$39.50

**Craftsman Structure Kits,
Detail Parts, Shingles & More!**
www.nickandnoradesigns.com

Nick & Nora Designs
a division of:
TMB Custom Models

LIKE US ON facebook

The entire process of moving the bridge scene was a lot of work, but it’s worth the effort. Even though the area is still very much “under construction,” I’m happy with how the section of the layout is looking more like rural Vermont than some stylized model railroad vision of sheer rock cliffs and waterfalls. What of that area around the end of the backdrop that was going to have



8



a country store and road? It has become additional forest and pasture land.

But “less is more” doesn’t mean less effort is required to complete a scene. While the bridge and creamery will certainly draw the eye, there’s going to be a lot of other texture for me to model and visitors to dwell on and enjoy. Telegraph poles, fence posts, track details like joint bars and switch stands, vehicles, the variations in ground textures, grasses, and specific trees are among the elements I’ll be focusing on in this scene.

Taken by themselves, they aren’t that noticeable. When combined, they should produce something special. And it should be fun [10].

Finished scene on the following pages ... both in color, and in period-correct black-and-white.



9



8. The stub-ended siding was replaced by a short double-ended siding serving a creamery. Once the track was installed and tested, I added the ground terrain with green florist’s foam.

9. I decided to try my hand at painting a backdrop behind the scene. I picked up a lot of tips from watching expert backdrop painters Bernie Kempinski and Mike Danneman, used a number of tips from Mike’s excellent Kalmbach book on backdrop painting, and got some great tips from Chris Lyon’s series on TrainMastersTV!







Digitrax No Worries Warranty Keeps Your Layout Running!

That's it! A simple, straightforward one year warranty with no tricky language!

You're protected against defects and accidental damage.

Learn more at: www.digitrax.com/noworries

Need tech support?

www.digitrax.com/contact

Need a repair?

www.digitrax.com/repair

Need a throttle conversion?

www.digitrax.com/upgrade



New Innovation



Nano Technology Lubricants

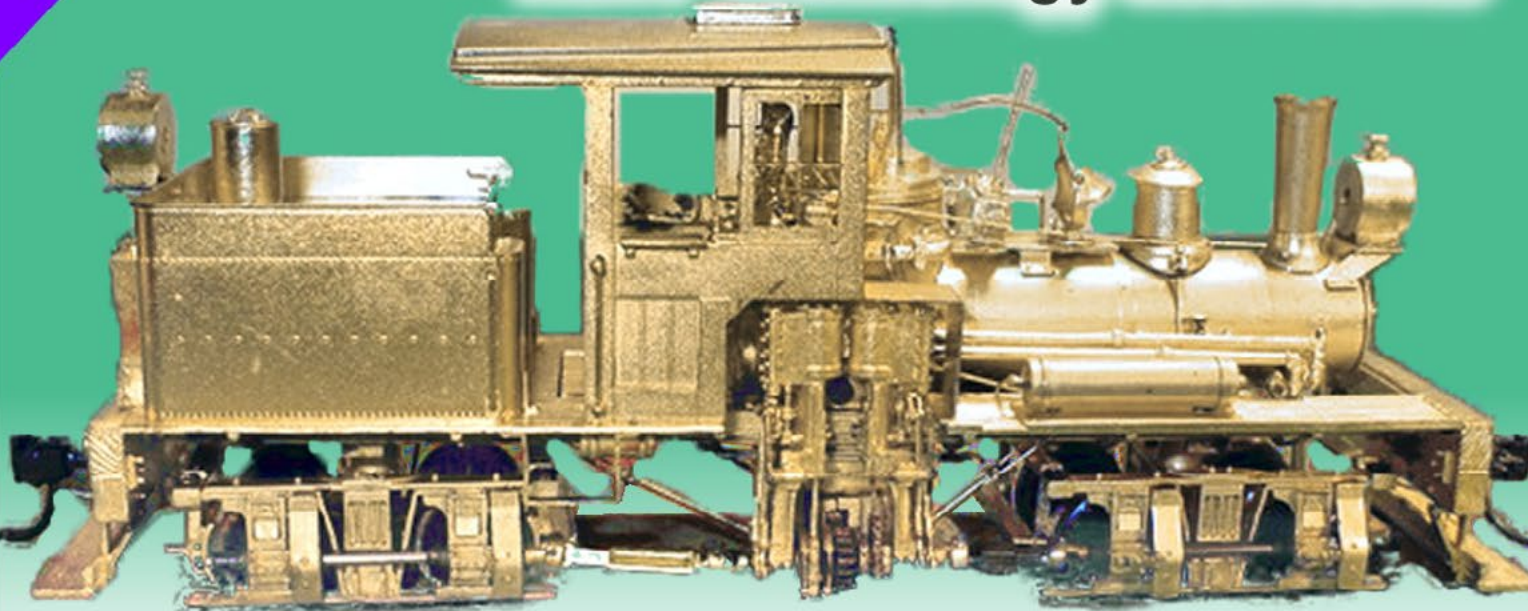

"After eight years of extensive testing, the only lubricants now used in my shop are Nano-Oils and Nano-Grease. The extreme reduction in power draw by mechanically minimizing friction is simply technologically superior."

- Phil Floyd, 'The Shay Fixer'

THE SHAY FIXER 

VISIT US AT... **SHAYFIXER.COM** 

Specializing in brass Pacific Fast Mail / United geared locomotives

For more details click here ...

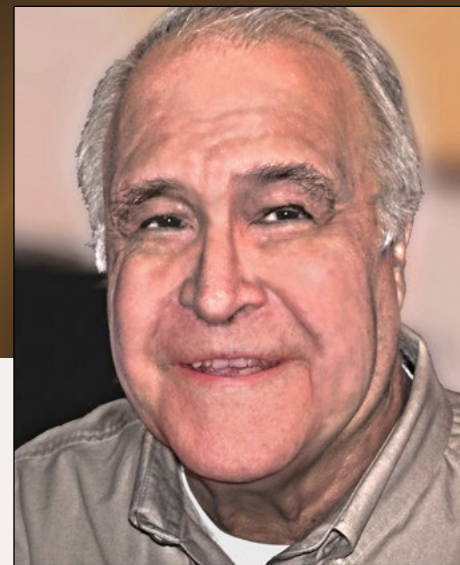

A narrow gauge coal tippie, Part 1

Ramblings on Narrow Gauge and Branchline Modeling



The Lite and Narrow column by Larry Smith

Modeling a real coal tippie from the East Broad Top that can be used on any railroad ...

Pearson Coal Company

Ron Pearson, from Cincinnati, OH, is a modeler whose work I greatly admire. Ron is an East Broad Top modeler who, in addition to building accurate models, has done field research to back up what he builds. In the process has become an expert on the coal fields and mining processes of the Broad Top coal fields of Pennsylvania. All his modeling articles have appeared in *The Timber Transfer*, the publication of the Friends of East Broad Top. Ron has been very generous sharing information with me, including some that has never been published. We owe a debt of gratitude to individuals like Ron, who have done the field work and become industrial archaeologists, documenting what we have lost.

The following is to illustrate how information can change over the years, especially in light of newly emerging photographs.



In the fall 1996 issue of *Timber Transfer*, Ron began the first of three articles on the Miller mine at Jollar, PA. The drawings included in the first article were made from the remaining walls and footings of the actual tipple. Still surviving at the site was



1. The tipple of the G.E. Miller Coal Company located at Jollar, PA. The photo was taken in 1940. Miller family photo, Carolyn Lundball collection.

an 11'-square concrete pit filled with water. There were metal rungs on one wall leading down into the pit. I assumed that the pit was another entrance to the coal seam, and mentioned this in "Evolution of my Railroad", *Lite and Narrow*, November, 2013. Ron also made this assumption in his articles on the tipple. In recent discussions on the tipple, Ron stated that the pit was only ten feet deep and that its purpose was unknown. Further evidence that the pit was used for other purposes came from photographs showing a lean-to covering more than half the pit, without a tower. Speculation is that the pit held coal cleaning equipment similar to the Chance equipment in Mt. Union, PA.

A brief history

Most narrow gauge and shortline railroads were constructed and operated for one purpose – the movement of one or two commodities to an interchange with a mainline railroad or other transportation. In most instances, the commodity was coal and/or lumber. In addition, the railroads were owned by the companies, as were the towns and the mines/sawmills, plus all of the land in the area. At times, in areas where the companies didn't own the towns, they would pay the miners with two-dollar bills just to let the local politicians know how much impact they had on their towns. For the towns they did own, Tennessee Ernie Ford's song, "Sixteen Tons" says it all.

There were two tipples in close proximity, the Broad Top Coal and Mineral Company Jacobs tipple, which was reached by the Rocky Ridge branch, and the Miller and Knepp Mid Valley tipple. The Miller and Knepp Mid Valley tipple was located on the winding two-mile long Coles Valley branch of the East Broad Top, which was more like a very long spur. Clinging to the side of Wray's hill, the line climbed a 2.6% grade to reach the tipple.

There were no turning facilities at either end of the line, so the locomotive pushed the cars to the tipple.

The term tipple might be generous, as both of them were nothing more than a trestle that crossed the lower tracks, with a hole to dump the coal into the hopper cars. At least the Miller and Knepp tipple had a shelter on it. These two tipples were examples of the crude construction that took place in early part of the last century. The open-deck tipple did become pretty much standard for the mines on the East Broad Top, being used until their closings in the 1950s.

“The Mid Valley mine was relocated to the town of Joller, and a new tipple was built, very much like the one at Mid Valley.”

As an aside, research for this project uncovered a name for a coal company that seems to be one only a model railroader could conceive – the Possum Hollow Coal and Coke Company. I’m going to have to find a place for that company on my layout. The Miller and Knepp mine opened in 1916 as the Mid Valley Mine. The drift mine tapped into the Barnett coal seam, but also had a tunnel to the Fulton seam. The Mid Valley mine was relocated to the town of Joller, and a new tipple was built, very much like the one at Mid Valley. The owners changed to the J.H. Miller Coal Company. In 1937, a fire destroyed the wooden tipple, and it was replaced by one of steel and concrete. This is the tipple being modeled. It was designed to serve trucks as well as and rail.

In 1938, mine ownership changed to the George E. Miller Coal Company, still remaining under the Miller family’s control until

1950, when it became the Wray’s Hill Coal Company. Wray’s Hill operated the coal tipple until 1966, when it reverted to the Miller family. During its lifetime, the mine produced over 1.2 million tons of coal.

The East Broad Top began serving the mine in 1916, taking over for the short-lived Juanita and Southern Railroad, a standard gauge line. It was built as an extension from a logging line to serve the mine at Jacobs after a dispute with the EBT developed over the transfer fees at Mt. Union. However, the production of the Jacobs mine was not sufficient to provide enough revenue for the short 15-mile railroad, and the railroad was abandoned in 1917 and sold for scrap. Because of the need for steel during World War I, the scrap sale brought in more money than it had cost to build the railroad.

There were several mines on the East Broad Top that weren’t owned by the Rockhill Iron and Coal Company, EBT’s parent company, but none of them were as large as the Jollar tipple. Because of this, the Miller mine and the Vernon Coal Company, a small wagon mine located near Rocky Ridge, continued to operate during the miners’ strike and depression following World War I. The Miller mine was non-union. This led to some car availability problems. EBT hoppers were diverted to their own mines, leaving Miller to get standard gauge Pennsylvania hopper cars with narrow gauge trucks sent for loading to the tipple at Jollar. Although the EBT could handle standard gauge cars easily, these cars were probably only the 50-ton GLC hopper cars due to the rail loading. For my railroad, I have converted two Bowser cars to narrow gauge to run to the tipples.

As early as 1928, the tipple at Jollar began shipping a portion of their coal by trucks. This greatly concerned the EBT, and they began to work out an agreement with the truckers to

allow them to bring the coal from the mine to a loading dock in Orbisonia. Their theory was that truckers would benefit by avoiding the mountain roads in the area. This was successful until after World War II, when the truckers quit using it. The trend toward trucks was reflected in the design of the new tippie constructed after the 1937 fire, with chutes for loading both hoppers and trucks. The tippie also had coal cleaning equipment that treated the coal shipped by truck. The end for the railroad serving the mine came in 1948, when only ten hopper loads were shipped from the mine. Trucks continued to serve the mine until 1971, when the mine closed.

The village of Jollar no longer exists, because in 1978 the owner of the land told all remaining families to vacate the town, as the land was going to be strip-mined. They did so, and today nothing is there. Fortunately, the strip mining never happened, leaving



2. Rear of tippie showing the blacksmith/car shop and mine prop storage. Most of these mine props were cut on the property and moved to the tippie by horse and wagon. Miller family photo, Carolyn Lundball collection.

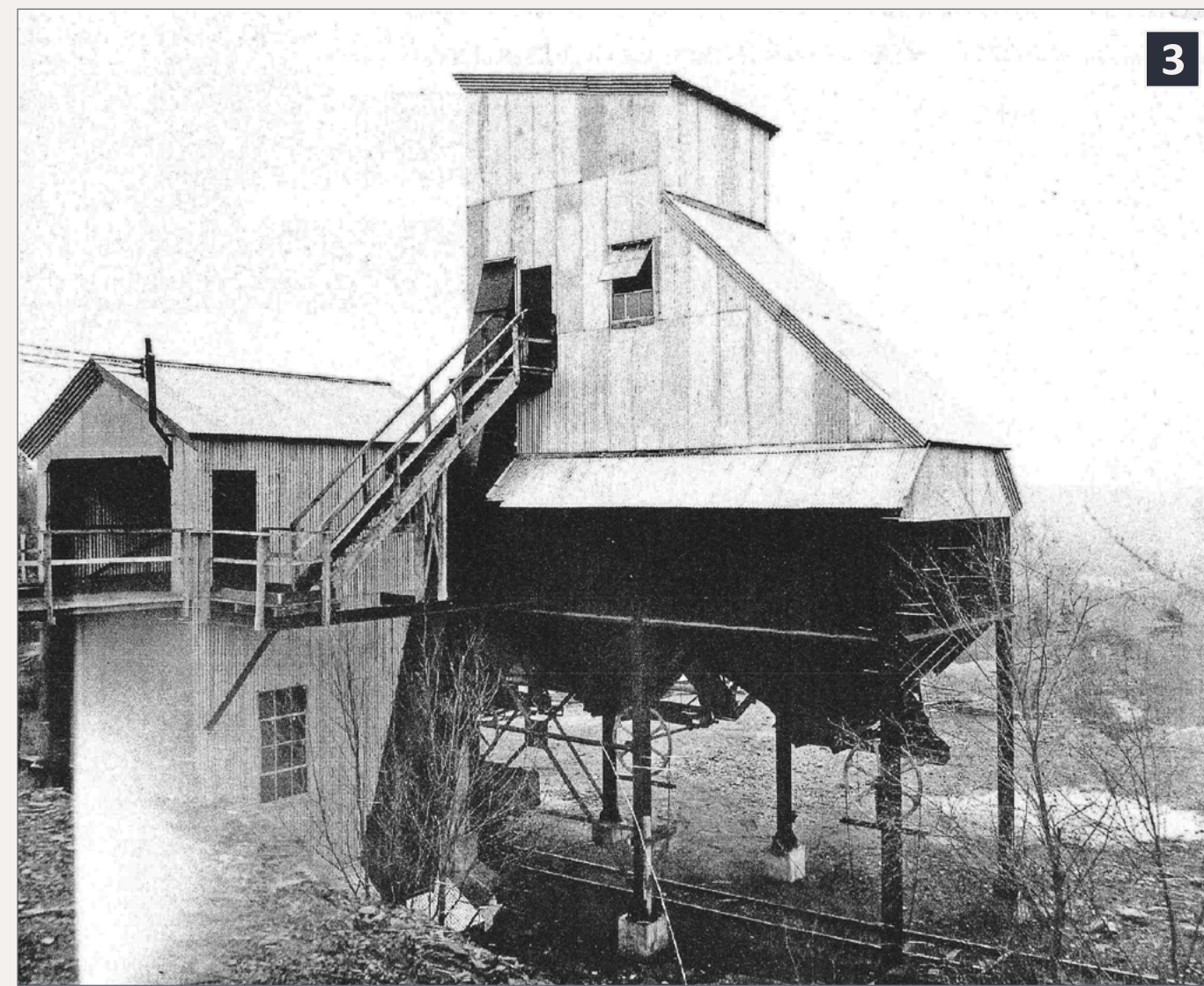

3. Rear of the tippie, showing the waste discharge chute and previously unseen operating mechanisms of the hoppers. Miller family photograph Carolyn Lundball collection.

only the footprints of the structures for industrial archeologists to study. It was from these footprints that Ron Pearson developed his plans that appeared in the *Timber Transfer* beginning in the Fall 1996 issue. You may obtain copies of the issues containing this and other mines that Ron built from the Friends of East Broad Top Company store at febt.org/Costore.

Lay of the land

Coal tipples come in various shapes and sizes depending on their output. For example, there are only two tipples in HO, that I'm

aware of that offer an adit (mine entrance). They are the BTS Mill Creek Coal and Coke, and the AMB Martinsburg No. 2 tipple. The adit in the BTS kit is more obvious, with the portal in plain sight, than the AMB kit, which is a small shaft mine. Both of these structure kits have auxiliary buildings. The only tipple structure that has a power house is the BTS Cabin Creek mine. Extra structures need to be added to make the scene complete.

You can include support structures if you model the Miller tipple, because Ron included drawings for them in his articles.



4. G.W. Miller tipple at Jollar, PA taken from the company store side of the tipple. This photograph may have been taken on a fan trip ran up the branch to the mine in 1940. Miller family photograph. Carolyn Lundball collection.



5. Large retaining wall and the coal dump end of the building that was constructed before photos arrived showing a different wall configuration.

Since this is a mule mine, animal powered, there is no need for a power house; all electricity is supplied by the local power company. However, you will need a mule barn. There are two scale houses for trucks and mine cars, and a blacksmith and mine car repair building. Up the hill is a fan house for ventilation of the mine, and over to the side is a powder house and a company store. The company store and powder house will be covered in a future column.

Building the mine

I began construction of the tipple by making throwaway molds. By throwaway, I really mean a one-time-use mold. There are three large molds and two small molds that will be cut into pieces. The largest mold is for the retaining wall at the rear of the tipple. This wall is 2' thick by 47' long and 12' high. The front concrete wall is 2' thick by 17' long and 4' high. Four 2' square

pillars sit on top of both concrete walls at the ends of the lower wall. They are positioned 3' in from the right end of the tall wall, and line up with the two pillars on the front wall. For these three molds, I constructed boxes from scale 12" x 12" lumber stacked two-high, to get the proper thickness. Making sure they were square and dry, I glued them onto scrap styrene sheet with airplane canopy glue. When dry, I glued scale 1" x 12" boards into the bottom of the boxes to simulate the concrete forms.

The four pillars were made by building a box using the 12" x 12" scale lumber 13' long and 2' wide. I also glued this to the scrap styrene. The last pillars to be cast were 18" square and 2' and 3' long. I needed two 2' pillars and four 3' pillars. Using the same techniques as with the large pillars, I tried to cast them individually. It didn't work. I built a long box, 18" wide, of scale 6" x 18" lumber, and glued it to the styrene. The most difficult mold to build was for the sand pit. This is a box 11' square with a center opening.

The outside walls were constructed of 12" x 24" scale lumber, 24" tall, and with an inside dimension of 11". Make sure the angles are square, and glue the box to the scrap styrene. Take a 6" x 16" piece of scale lumber and lay the 16" flat, butting up



6. Retaining walls and support piers glued in place on the Styrofoam base according to the plan.



7. Hillside built up to mine level using various sizes of Styrofoam sheets. Track is laid temporarily to check clearances.

against outside wall. Then build the inner wall from the 12" x 24" scale lumber using the 16" board as a spacer. Glue the inner wall into place and remove the spacer board. Using Hydrocal,

I poured all of the castings and let them dry. For the small columns, I removed them from the mold and used a very fine-tooth saw to cut them to length. I painted all the columns and walls weathered concrete.

Diorama base

I began construction of the diorama base with $\frac{3}{4}$ " foam board cut to 24 $\frac{1}{2}$ " x 16". This can be expanded later, as needed. I cut and temporarily attached two lengths of Code 55 flex track to the foam board to get the proper spacing.

I glued the walls and columns in place with white scenery glue, according to the footprint plan. Finally, I adjusted and marked the track spacing.

We are now ready to get some elevation. Model building has changed dramatically, especially with materials, since Ron built his diorama. On that, Ron used ½” plywood for the base but, as you can see, I used foam board. To get his elevation for the auxiliary structures and mine tracks, Ron used ceiling tiles. I stacked the foam board, and glued it with Liquid Nails for Projects® until it reached 3 ¾” high. I used a marker pen to show the location of the large retaining wall on the now-large block of foam board.

Since there was sloping ground on both sides of the retaining wall, I measured a line from the edge to get some ground past the wall. I cut this section from the block and slid the foam board forward, surrounding the wall. There is a wooden ramp that carries the mine track from the tippie to the mine opening. This extends over sloping ground, so I measured this distance and drew another line. Using this line and the bottom



8. Waste, called boney, and coal ground cover spread around the retaining walls. The coal is actual EBT coal that Elliot Eggleston gave to me many years back.

front edge, I used a hacksaw blade to cut away the foam, leaving a nice slope. I also cut a slope on one side down to the location of the truck road and scale house. At this point, I applied plaster cloth with a paint brush dipped in water, for a smooth surface.

After drying, I painted the plaster with earth-colored latex paint. Those of you who are frugal might consider painting a sample of your favorite earth color on a piece of cardboard. When dry, take that sample to your local paint store and have them mix their cheapest latex paint to that color. I used Floquil Earth for my sample, and now have a gallon of latex in that color, which I purchased for around \$13. You can strain it and airbrush if you wish, or brush it as I did.

Once this was dry, I marked the location of the railroad tracks and the mine trackage, along with the mine car scale house and the blacksmith/car shop. The railroad track is code 55 flex track that was weathered prior to installation. The mine track is handlaid Code 40 glued in place with CA.

Because of space limitations when the tippie is put into place, I buried the flex track into the scenery. To do this, I put upside-down rail next to the flex track rails and filled between the rails with Sulptamold®. I let it dry before removing the rails. I painted the entire area flat black, and liberally spread Highball Products coal dust over the area.

Next time: Building the tippie and the mine car scale house.

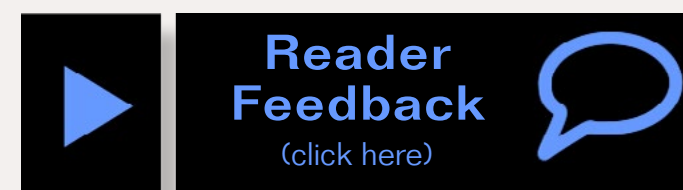

NORTH AMERICAN RAILCAR CORPORATION

— NARCorp —

High Performance Low Friction Trucks with Wheelsets



(Narrow Tread, Semi-Scale)

HO SCALE

New Special Run – 6-car Micro-Trains Runner Pack!!!

CSX Transportation (CSXT)

ACF 39' 2-Bay Center-Flow Covered Hopper w/Round Hatches / Weathering



photo - courtesy of Robert Pisani



photo - courtesy of Tom Zarnock



photo - courtesy of Robert Pisani

Weathering applied to simulate a prototypical appearance as follows:

- 3 very light
- 3 heavy

Plus... 2 of the lightly weathered cars will have graffiti on side A, reproduced from actual photographs



Pacific Western Rail Systems



Joe Steimann's weathering decals

Photos and video of superb models

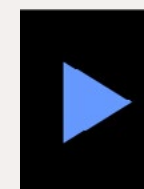

Reader
Feedback
(click here)



What's neat this week column

by Ken Patterson

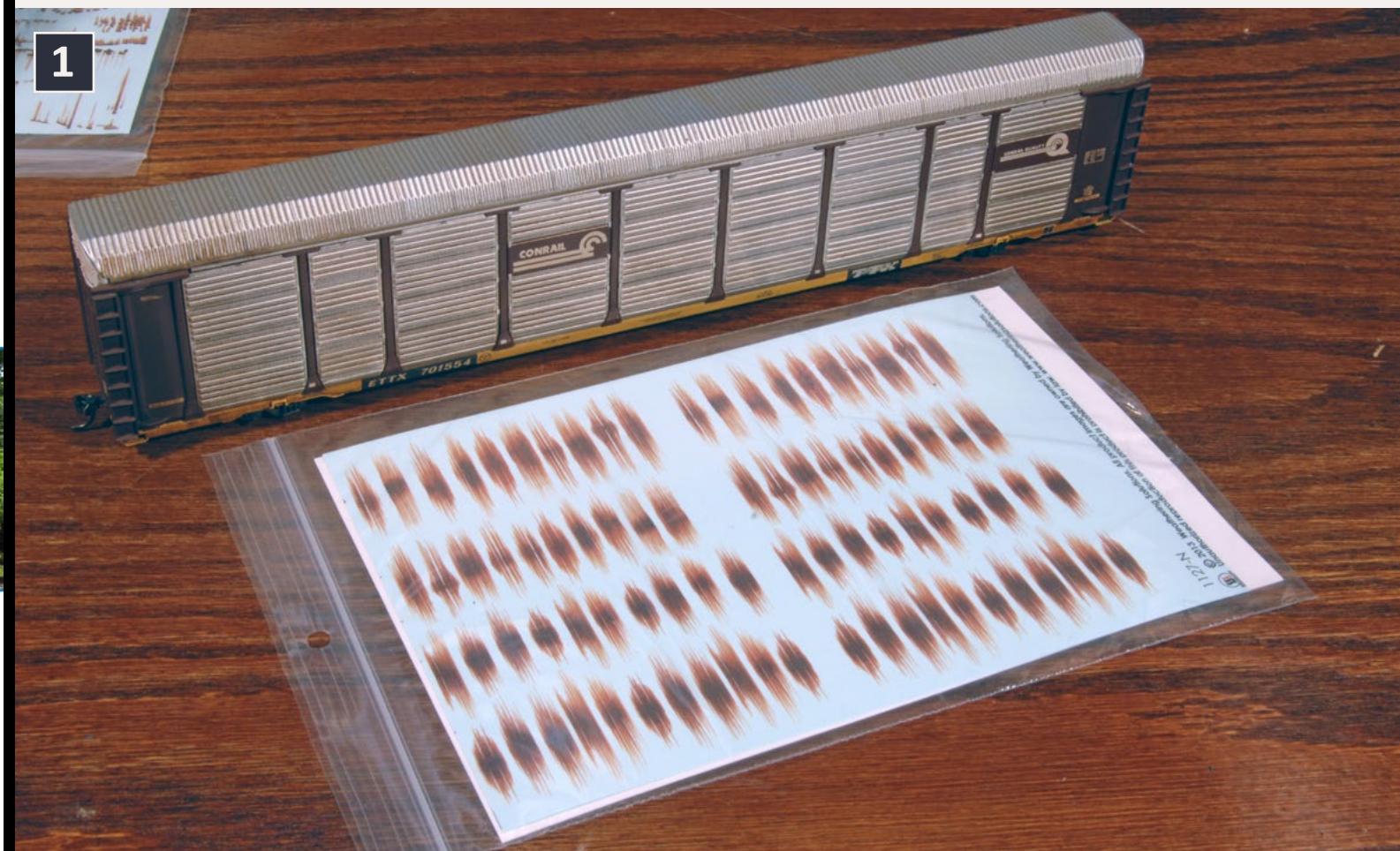

1. I tried applying roof rust patches to this auto rack. Watch the video to see how I apply them. After wetting the decals I simply apply them to the top of this rack and smooth them over the corrugated roof panels.



contents



index

June starts us off with Joe Steimann's weathering decal idea that he has turned into a business. Be careful, you may get what you wished for. He has been busy. Being a skeptic, as I already know how to oil paint streaks and rust, it took Ron Rands at Micro Engineering to point out what I was missing: now a weathering beginner can have oil paint results without the oil paint learning curve. Watch and listen as Joe explains how to use his rust and weathering decal products, sold under the name Weathering Solutions.

Later in this month's What's Neat video I talk about tripod heads and their uses in model photography. At the end we find Jeff Meyer photographing another of his weathering creations.

[... On to next page of article →](#)



Playback problems? [Click to try a different version.](#)

Bowser

New Product Announcements

EXECUTIVE LINE

HO ALCo C-430 Locomotives



Click here to check out the details for these and other great Bowser products!

HO SD40-2 Locomotives

Designed as GMD not US version with changes



www.bowser-trains.com

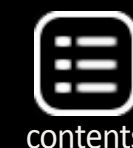

3

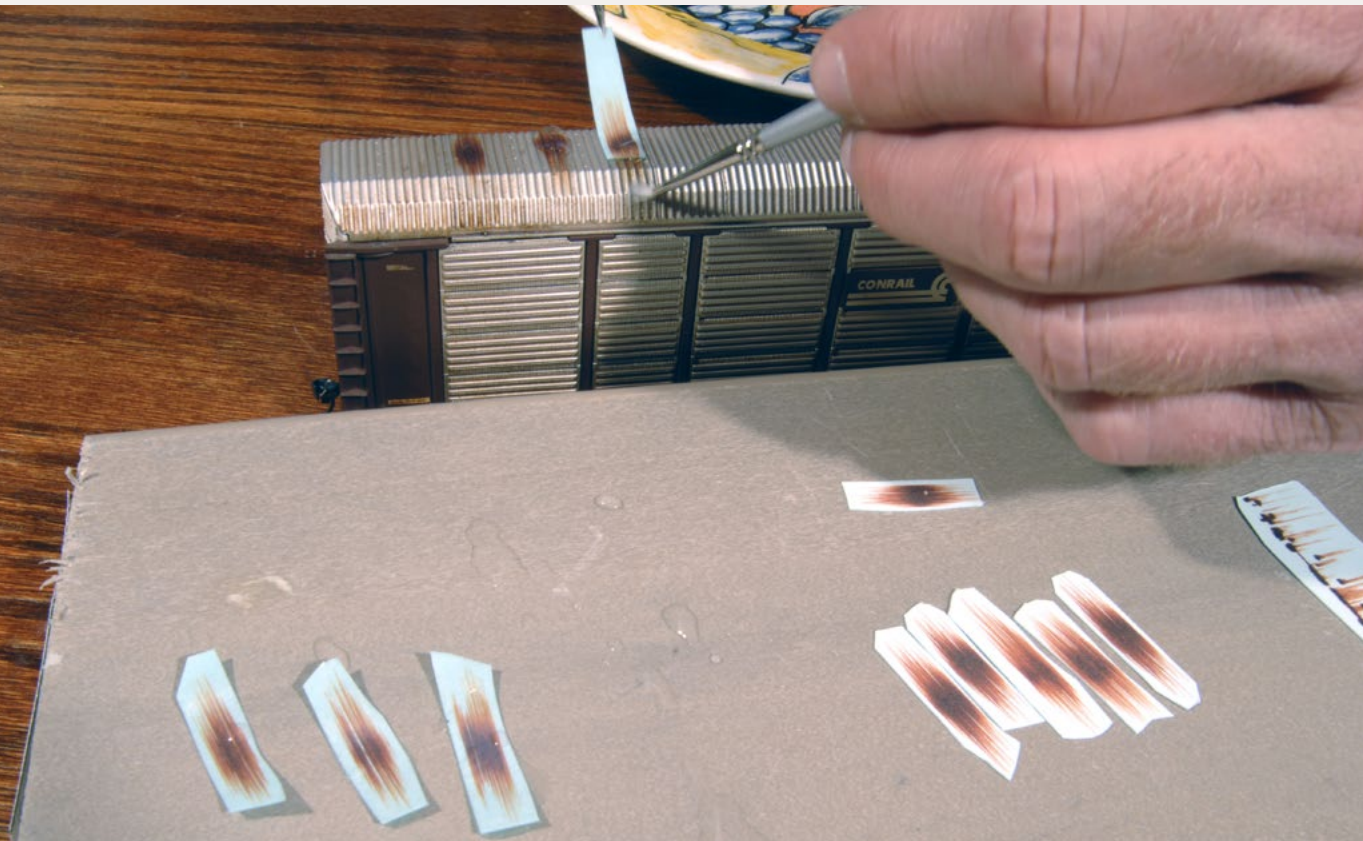

3. The decals went on smoothly. The silver roof shows through the translucent rust decal and makes for a good effect.

4

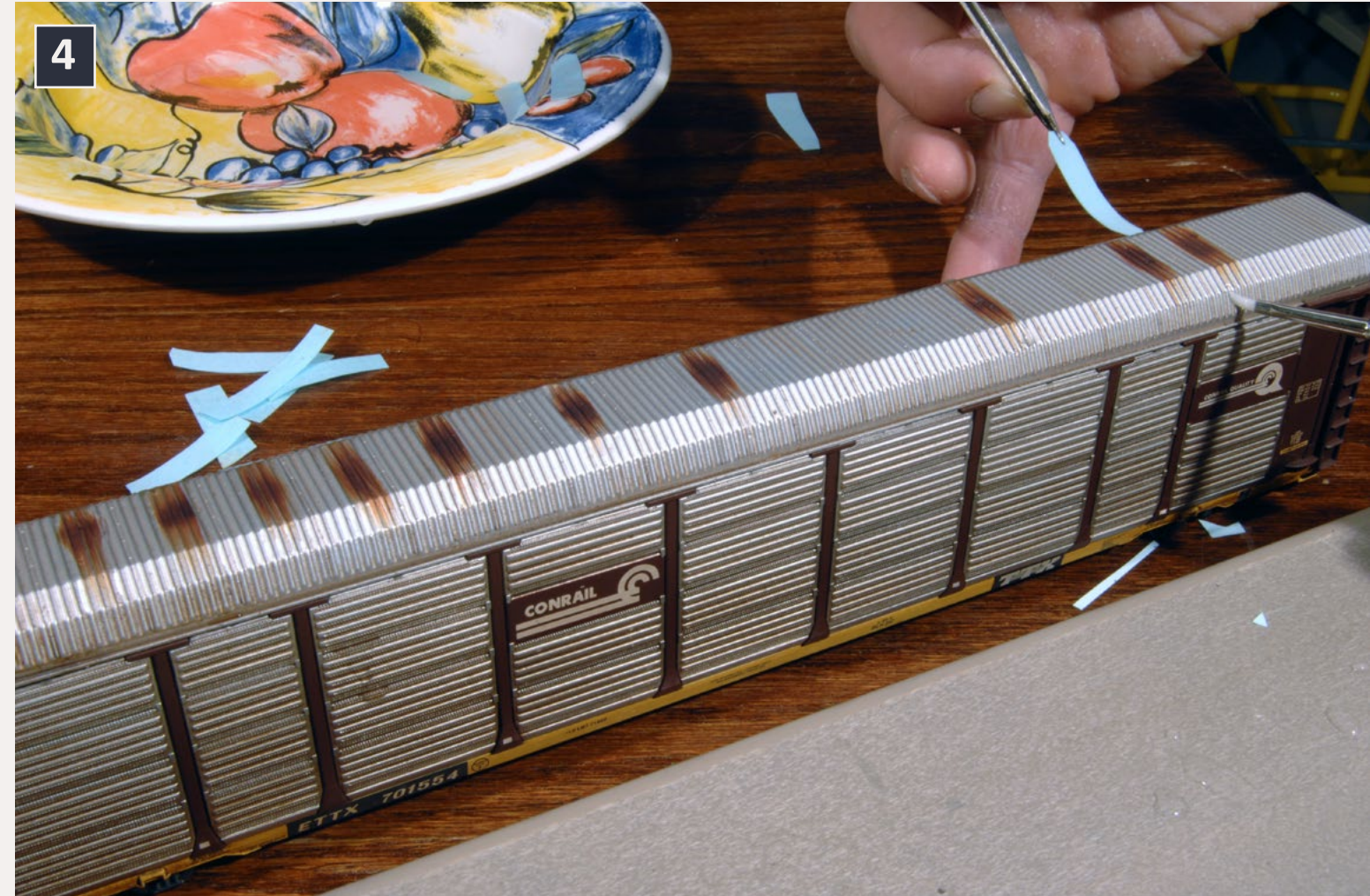

4. I have to keep the decals centered and parallel to the roof lines. Progress was pretty fast because it took no time at all for the decal paper to release the transfers when wet.

Get the Latest Model Railroading News, Tips, Reviews & Opinions

The SCOTTY MASON SHOW

S H O W
The Original Model Railroad Podcast

-Monthly Interviews

- Modeler's Spotlight: Top Modeler's Talk
- Narrow Gauge Modeling w/Chris Lane
- Contemporary Modeling w/ Mike Rose

-More Product Announcements & Reviews

 Our feed has changed! To get the latest shows, Please search Scotty Mason and subscribe to the new feed!

www.TheModelRailroadPodcast.com

Scott Mason Jimmy Simmons Mike Rose Joe Duckworth

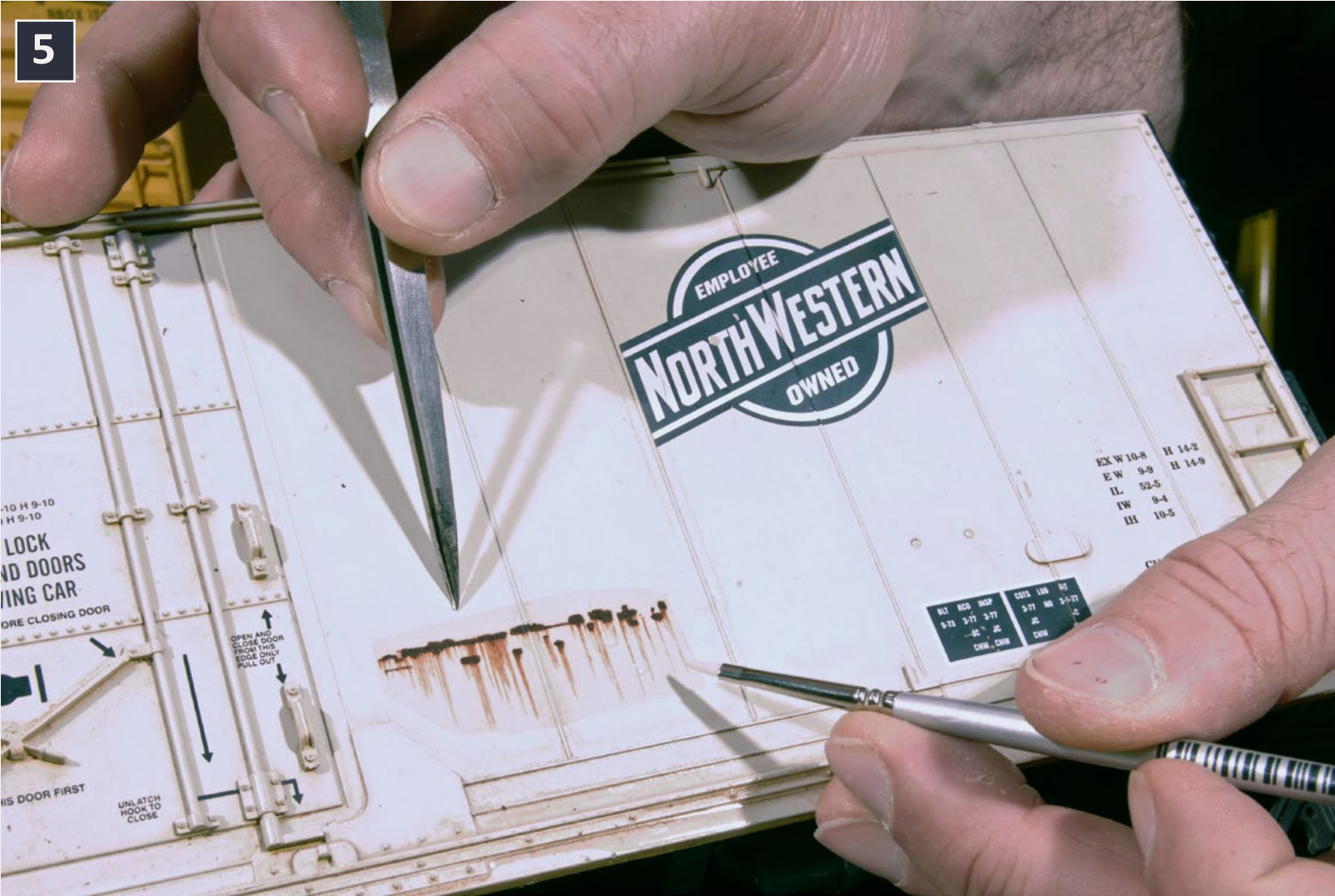

5. This large scale C&NW box car shows off the rusted scrape decal. I slid it smoothly onto the side, followed up with Solvaset, and the decal looked like it was really rusting away the side of the car. Nice effect.

Get Better Sound from your Locomotives

Can't get a good sound from your sound decoder?
Give our speakers a test drive with your ears.



RAILMASTER HOBBIES
9815 WALNUT ST #106
BELFLOWER, CA 90706

Bass Reflex Speakers



High Bass Speakers



When it comes to speakers we have high quality speakers to fit many different applications. We are also a full line hobby shop. Need anything? We are an authorized dealer for Soundtraxx, Digitrax, Athearn, Walthers and many others. We provide quality speakers for your DCC sound systems and quality service.

Click here for the *sound* answer ...



6

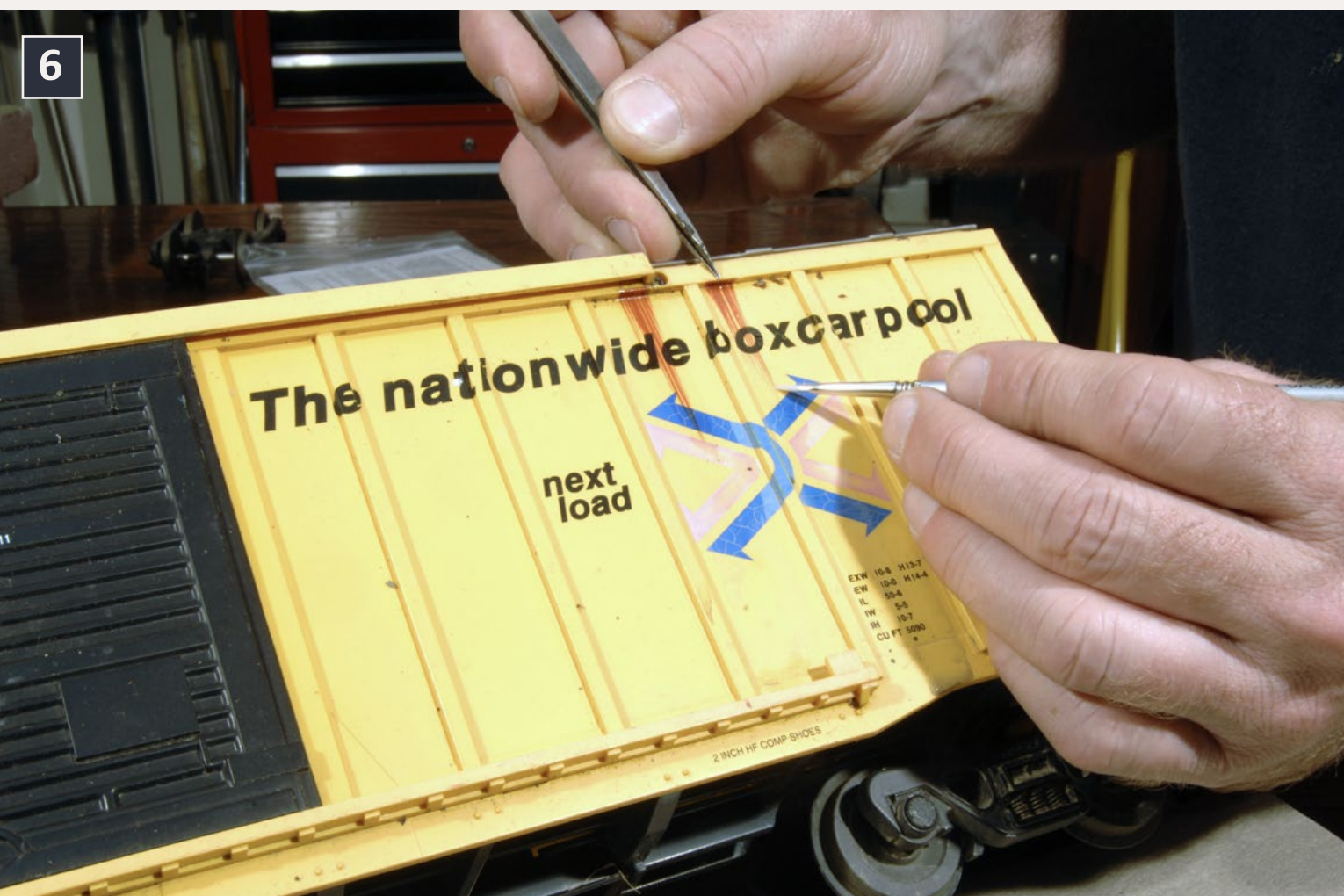

6. On this G scale Railbox car, I applied some rust streaks from the upper sill down. It is important to get the decals straight up and down for that rain rust effect. In this month's video you can watch in real time as these decals are applied.

7



7. I find ballhead tripods miles easier to work with than the three-handle head (in the background) that I used to use. Now, with one grip of the handle the shot is framed in the camera. The last head in this photo is a fluid video head which eliminates jerking while panning up and sideways. It has been a savior for smooth moving shots. The street price of the ballhead is \$189.00, the fluid mount, \$350.00; and the three-handle tripod head is also about \$189.00.

8



8. Jeff Meyer ends this month's video with one of his recent Montana Rail Link creations. This Rail Link car's paint is simply washing off the Burlington Northern green freight car. Lots of careful wet sanding produced the effect.

9



9. The 89-foot auto parts car is finished with oil paint washes before various decals are applied to create the rust effects.



10b



10a, 10b. Joe Steimann set up his models on location in the downtown rail yards. The sun's position tells us it is after noon, looking north towards the city of St. Louis. The towers give it away. Or was it? Wait, this is a model! It fooled me on Facebook. So rust decals do work ... yes.

11



11. Some super-looking maintenance of way equipment frames this shot of Joe's rust decals on the back track's hopper cars. Natural-looking setups make the models and the weathering look like the prototype.

12



12. This photo shows a Missouri Pacific scene that looks real. The sunlight, the trackwork, and the weathered freight cars all work together to pull off this prototype-looking modeled photograph. Good job, Joe.

 **Reader Feedback**
(click here) 



Southern Digital

Specializing in DCC Since 1992



20% Discount on most items!



DCC Conversions & Service

Orders Received by 3:00 pm EST ship the same day

WWW.SODIGI.COM

E-mail: sales@sodigi.com

(770) 929-1888

(Photo's are from our N-Scale layout)

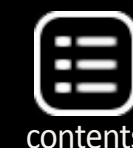

MRH HOBBY MARKETPLACE - 1

MRH HOBBY MARKETPLACE - 2

Fast clocks need hands!

Click Now

fastclock.mdodd.com



Railroad Art-Prints,
Caps, Jackets,
Shirts and More ...
Jackets starting
at \$79.95

www.jelsma.com

1-904-221-3513 • Jacksonville, FL.

True Scene™ Modeling



Scenery Base Material for the 21st Century!

SATISFACTION GUARANTEED!

www.truescene.com or 716-523-7305

Have you seen these popular blogs on the MRH website?



Ken Glover's Shelf Layout

44,000 reads

CLICK TO READ IT NOW



Mike Rose's N scale empire

46,000 reads

CLICK TO READ IT NOW



Minimalist Model Railroad Design

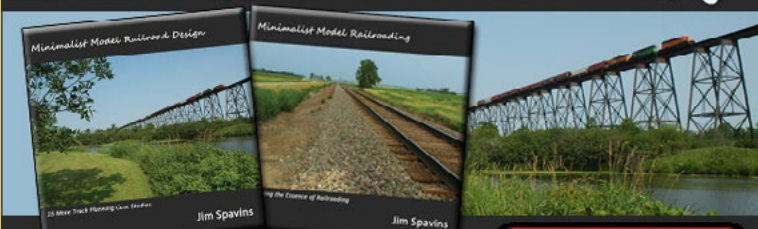

All New 2nd Edition!

Click Here

Mr. Detail Parts



New Parts Added Weekly!

Click Here

www.mrdetailparts.com

clever models LLC
Cardstock models & Building materials



CLICK HERE

www.clevermodels.net

Yarmouth Model Works

HO scale resin kits and detail parts

U.S.A. MAILING ADDRESS
3560 Pine Grove Ave. Unit 617
Port Huron, MI 48060

Tel. 519-633-7574
pierre.oliver@start.ca

www.yarmouthmodelworks.com

CANADIAN MAILING ADDRESS
85 Hiawatha St.
St. Thomas, ON N5P 2T5



WE MAKE OVER 900 STEAM ERA FREIGHT CAR KITS!

NEW KITS AVAILABLE. RESIN KITS, DECALS, DATA DISKS & DETAIL PARTS AVAILABLE.

www.westerfieldmodels.com



Don't settle for lifeless signals! We've got signaling circuits!



Please visit our website and online store!

21175 Tomball Pkwy
Suite 287
Houston, TX 77070

Phone: (281)251-5813
http://www.logicrailtech.com
info@logicrailtech.com

Can't remember which cars you've bought?

Yard Boss

Model Train Inventory Software

from DCC by Design

Under \$15

Download free trial now

www.dccbydesign.com



contents



index

RULERS-of-the-WORLD

Scale Rulers \$4 each

Over **150** scales!

Metric or Imperial

www.rulers-of-the-world.com

Rail Design Services

Railroads Done Right!

[click HERE to learn more](#)

Get your large text ad here in this space!

Ordinary text ads are limited to 100 characters, but if you'd like to do a double-text-ad, we'll give you 375 characters. (This ad here had right at 364 characters.)

If you have more you'd like to say, then a double-text-ad is a superb, very affordable way to say it. Place your double-text-ad with us today and start getting the word out to our audience of over 110,000 unique device views per month!



Great Decals!™

Picture Art Decals, St. Charles, MO. Photo by: Bill Kistner

FEC & Interstate RR-5 titles
 Virginian Railway-26 titles
 L&N-11 titles
 After Hours Graphics line
 Coupler gages, and more
 In O-, S-, HO-, and N-scales
 William Mostellar
 PO Box 994, Hernadon, VA 20172
 SASE for list, or www.greatdeals.com

Your ad could be in
 this space for just
\$55 a month.

[Click to learn more ...](#)

Premium Trees at Bargain Prices



[Click NOW](#)

Backdrop Junction

Your stop for
 Model Railroad Backdrops



[click here to visit our website](#)
backdropjunction.com
 N, HO, O Scales • Custom Orders

MRH dared to put THIS on video?



Watch the
 video now

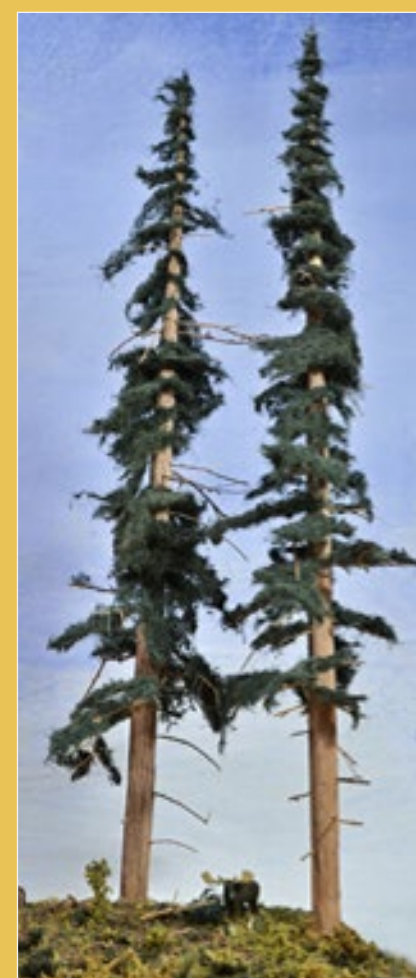

NEW
13"
 CEDAR
 TRUNKS
 ~~~~~  
 TREES  
 ~~~~~  
 TREE
 KITS
 ~~~~~  
 TRUNKS

Coastmans  
 Scenic Products  
[CLICK HERE](#)

## STREAMLINED BACKSHOP

Sales  
 ... Services  
 ..... Solutions

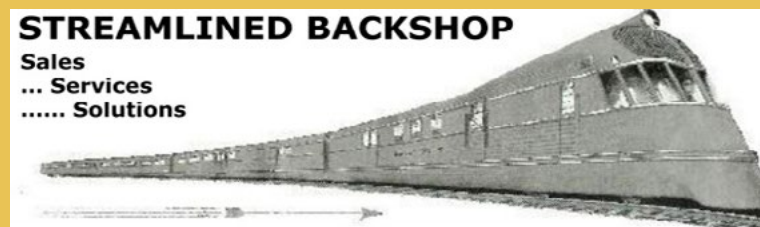

THE LIGHT AT  
 THE END OF THE...



HEY! GET OUT OF  
 THAT TUNNEL!!!

PRE-WIRED SMD LEDs  
 1206 - 0805 - 0603



38ga MAGNET WIRE  
 1000 Ohm RESISTOR



WARM WHITE  
 BRIGHT WHITE  
 ALL COLORS



[www.SBS4DCC.com](http://www.SBS4DCC.com)

# MODELING SEABOARD B-8 AND B-9 BOX CARS

– By John Golden  
Photos by the  
author

1



A fun and easy HO  
scale prototype  
modeling project ...

## The prototype

**D**uring the Great Depression, when many railroads were scaling back operations and trying to make ends meet on shoestring budgets, Seaboard's savvy receivers expertly used bankruptcy protection to extensively modernize the railroad's physical plant, passenger train fleet, main lines, and train control systems.

The carrier emerged from receivership in 1946 as a powerful regional railroad, able to compete with and beat Atlantic Coast Line and Southern in a number of key markets and become one of the nation's fastest and most efficient mid-size railroad companies.

Included among these improvements were a number of all-steel box cars of various types that modernized Seaboard's car fleet earlier than its competitors.

These cars included 2,000 all steel 1932 ARA cars (SAL B-6, 17000-17999 and 18000-18999), 200 automobile cars (SAL AF, 10000-10199), 500 turtleback box cars (SAL B-7, 18000-18499), 1,200 turtleback automobile cars (SAL AF-1, 11000-11699 and SAL AF-2, 11700-11999 and 22000-22199), and various other types of cars



1. The completed Seaboard  
B-9 19794 in HO.

including covered hoppers, phosphate cars, and hopper cars. Modernization continued during World War II, when Seaboard received 500 1937 AAR-design all-steel box cars in three lots from Pullman Car & Manufacturing Co. in Bessemer AL.

## The B-8 cars

The 1937 American Association of Railroads (AAR) box car was an evolutionary improvement over the American Railroad Association (ARA) 1932 car. The 1937 design featured improved height (generally 10' 0" inches interior height), ten-panel riveted sides (five panels on each side of the door, stamped 4-5 two-panel dreadnaught ends, AB-schedule brakes, 6' door opening, and a Murphy roof.

The cars were built by many of the major builders, such as Pullman Standard, Mt. Vernon, American Car & Foundry, and many others, and many railroads built the cars at their own shops. Many variations were constructed with different roofs, trucks, doors, brake wheels, and other hardware to suit the individual railroad companies. An excellent primer by Ed Hawkins on the 1937 AAR box car appeared in RailModel Journal, July 1991, Vol. 3, No. 2. That magazine is available for online viewing at [trainlife.com](http://trainlife.com).

The first of Seaboard's AAR 1937-design cars were delivered in September 1944 from Pullman Lot 5768, numbered SAL 19500-19699. The cars were about as standard as they came from Pullman at that time, with 4-5 dreadnaught ends, Murphy roof, W-section corners, Youngstown corrugated doors, AB-schedule brakes, Apex running board and brake step, and an Ajax brake wheel. Trucks were of the AAR standard type with one-wrought 33-inch diameter wheels.

The cars were painted DuPont SAL Standard Color (freight car brown) with white stencils, "The Route of Courteous Service" slogan, and the 56" monogram featuring the word "Railway"



**2. SAL B-9 19962 is nearly new in this Al Armitage photograph. New B-8 cars were similar but had different doors, This car has its original paint with the "Railway" monogram and a "New 10-45" date. This car is from the last lot of 50 cars, Pullman Lot 5806, and had a Superior door and US Gypsum running board and brake step. Al Armitage photo, Ron Morse collection. Courtesy Richard Hendrickson.**

and with a Fire Plug Red heart background. Roofs were coated with black car cement. The cars were classed as B-8, following the B-7 single-door turtleback cars in series 19000-19499.

Pullman nomenclature regarded SAL 19500-19699 as "Victory" cars. The Victory designs were created by the AAR in 1944 in response to the War Production Board's permission to resume all-steel freight car construction during World War II. The War Production Board originally ordered that Seaboard 19500-19699 were to be delivered as "war emergency" cars with steel roofs, ends, underframes and doors and composite sides similar to other cars delivered to Central of Georgia, Western

Railway of Alabama, Georgia Railroad, and the Atlanta and West Point. The Seaboard cars, however, were specified as 10' 0" interior height cars, whereas other War Emergency box cars were specified as a 10' 6" IH cars.

The B-8s were the first modern SAL cars to be delivered with car cement (black) roofs. During the late WWII and post-WWII era, Seaboard took delivery of several car series with car cement (black) roofs. Photo evidence clearly shows that many cars repainted in the post-war era also received black roofs, and some even got black roofs and ends.

The application of car cement or black paint was not consistent, so in this era cars from the same class may have appeared with freight car brown roofs and ends, or black car cement roofs, in any combination. The B-8s and B-9s were delivered with car cement roofs, and cars repainted through the early 1950s may have had their roofs re-sealed with car cement. Repaints after the early 1950s got a complete freight car brown body, including roof, underframe and trucks.

The car cement used in the post-war era did not adhere well to galvanized metal, and it tended to deteriorate quickly when exposed to extreme weather. Caustic coal smoke and ash from steam engines may have contributed to deterioration. The result was that the car cement tended to flake or peel off the roof structure, exposing untreated galvanized metal roof sheets. In many cases, the car cement would remain on the roof seam caps but partially or completely flaked off the galvanized metal surface, leaving a silver-gray roof with black seam caps until the roof could be repainted or sealed again.

Other SAL cars delivered in the post-WWII era, such as the B-10 and AF-3, were also delivered with car cement roofs.



**3. SAL B-8 19629 was photographed at Raleigh NC in 1963. This car has been in bulk paint or clay service and is the victim of a large amount of spillage. Note the paint patches with new data. These could be in freight car brown or black. Warren Calloway photo.**

Interestingly, the AF-4 and A-2 automobile cars delivered in 1948 were received with car cement roofs and ends. Conversely, the AF-5 automobile cars, delivered in 1948, were received with freight car brown roofs and ends. This practice ended with delivery of the B-10 PS-1 cars in series 25000-25499, delivered in March 1952.

### **The B-9 cars**

A further 300 1937 AAR cars were delivered to Seaboard in two lots in 1945. Both lots followed the 1937 design with 10' 0" interior height, 4-5 dreadnaught ends, and Murphy roofs. Both lots were classified B-9 by the railroad. Unlike the B-8s, the new cars featured a few differences that are worthy of note

The first 250 B-9s, Pullman Lot 5804, arrived from Bessemer in September 1945. The cars were numbered 19700-19949. They

were identical to the B-8s with the exception of running board, brake step, and door types used. SAL 19700-19749 used Apex Tri-Lok running boards. SAL 19750-19949 used U.S. Gypsum running boards. SAL 19700-19799 used Superior doors, while SAL 19800-19949 used Youngstown.

All cars had AB brakes and an Ajax handbrake, and rode on AAR trucks with one-wrought steel wheels. The cars were painted DuPont SAL Standard Freight Car Color (freight car brown) with white stencils, "The Route of Courteous Service" slogan, and the 56" monogram featuring the word "Railway" and with a Fire Plug Red heart background. Roofs were coated with black car cement.



**4. Seaboard 19744 is a B-9 from the first B-9 order. Photographed in 1953, the car is eight years old and has already been repainted. Note the "Railroad" monogram and the absence of the builder's tag. The car was last shopped in Jacksonville in May, 1950 and was already repainted by that date. The car is covered in spillage, probably from bulk cement or dry rock phosphate ladings. Graham NC, April 9, 1953. Lloyd Moore photo, Larry Goolsby collection.**



**5. SAL 19623 is seen at Claxton GA in the short-lived billboard Gothic scheme. SAL used the large billboard Gothic scheme in 1964 but quickly transitioned to a large, billboard Railroad Roman scheme in 1965. Note the replacement door, added sill reinforcement below the door, and the lowered tack board. The car has also lost its class designation on the lower right side of the car. August 12, 1964. Location unknown. Larry Goolsby photo.**

The second 50 cars, Pullman Lot 5806, arrived from Bessemer in October 1945. These cars were numbered 19950-19999 and were dimensionally similar to the first lot of B-9s. The entire lot featured U.S. Gypsum running boards and brake steps, along with Superior doors. They were also equipped with AB brakes, an Ajax handbrake, and AAR trucks with one-wrought steel wheels. The cars were painted DuPont SAL Standard Freight Car Color #374-822 (freight car brown) with white stencils, "The Route of Courteous Service" slogan, and the 56" monogram featuring the word Railway and with a Fire Plug Red heart background. Roofs were coated with black car cement.

All Seaboard B-8 and B-9 cars were originally delivered with the slogan "The Route of Courteous Service." This was the only



authorized slogan used on the cars until 1963, when Seaboard switched to a large Gothic billboard lettering scheme. Several B-8 and B-9 cars were repainted in the new scheme, which included the large Gothic lettering and the 56" Seaboard Railroad monogram on an all-freight car brown body.

These cars did not wear any other of the famous Seaboard slogans, such as "Route of the Robert E. Lee," "Route of the Silver Meteor," "Route of the Silver Star," or "Route of the Silver Comet." Only "The Route of Courteous Service" was authorized.



6. This rare photo shows a Seaboard B-8 car in the billboard Railroad Roman scheme. Note that the monogram and dimensional data have been moved one panel closer to the door, and that the B-8 classification is omitted. Seaboard stopped using their car classification system around 1955. Note also that the area around both sides of the door has been damaged, probably by the use of forklifts to open the car doors. Hopewell VA, October 26, 1965. Lloyd Moore photo, Larry Goolsby collection.



7. SAL 13009 is one of the 100 1937 cars rebuilt for dry rock phosphate service. Note the Improved Youngstown door, the strengthened bottom side sill, and roof hatches. The car was painted in an attractive gray scheme with black lettering, but the heart in the monogram remained red. Warren Calloway photo. Raleigh NC, March 11, 1965.

In 1965, 100 former B-8 and B-9 cars were modified for bulk dry-rock phosphate service. The cars were removed from the B-8 19500-19699 series and modified at SAL's Portsmouth VA car shops.

Portsmouth added two round 30-inch hatches (on diagonally opposite ends of the car), lower side sill bracing, and improved door locks and fixtures, and repainted the cars gray with black lettering and a black and red monogram. The cars were reclassified AAR type LC and were placed in domestic phosphate service.

The cars were assigned numbers 13000-13099 from the vacated B-4 car class. These cars should not be confused with Seaboard's silver "beer cars," which were 47 PS-1 cars from the SAL B-10 class that were painted silver and modified with improved insulation.

## Modeling the SAL B-9 box car

I used Intermountain's HO scale 1937 AAR Box Car model as the starting point for this easy project. You may also use the excellent Red Caboose RC-8002 model ("W"-corner post version car) although undecorated models are somewhat hard to come by. I chose to model the B-9 car for this project because they were slightly more numerous, and because I had built a number of B-8s previously and wanted a slightly different car.

## Assembly

I began this project by building the car per the instructions included in the kit. Assembly was straightforward although I departed from the instructions to add details to the model. First I removed all the parts from the sprues and cleaned them up, and then determined which detail parts I needed to complete construction. Here are the parts I used:

I began by building up the underframe and brake gear, then transitioning to the B end, then to the A end, then the sides, and the roof. The B end is the car end that includes the brake



8. The completed model of SAL B-9 19794.

## Parts List

1. Intermountain Railway No. 40799, 1937 AAR Box Car, Undecorated
2. A-Line #13002 Lead Weights ½" x ¾"W x ¼" thick
3. Builders-in-Scale Chain, No. 252
4. Detail Associates No. 2206 Eye Bolts
5. Cal Scale No. 294 AB Brake Gear set
6. Evergreen No. 101, .010" x .030" strip
7. Hi-Tech Details No. 6040 Air Hoses with Brass Mounting
8. Kadee #564 50-ton Bettendorf Self-Centering Trucks with two-piece HGC parts
9. Kadee #178 couplers
10. Kadee No. 2020 Ajax Brake Wheel
11. Reboxx No. 1-1.030 33" Semi-scale Wheelsets
12. Plano No. 11920 40-foot Gypsum Boxcar Running Board, Diamond Pattern
13. Scalecoat 2 Box Car Red #1
14. Tichy No. 1101 .010" phosphor-bronze wire
15. Tichy No. 8017 Rivets
16. Westerfield 18" Straight Grabs (can substitute Detail Associates 18" grabs) ■

wheel and brake gear. The left and right sides of the car are identified as the left and right sides of the car when the viewer is facing the B end. No matter which way you look at the car, there is always a clearly defined A end, B end, left side and right side of the car.

I assembled the underframe per the car's instructions but discarded the brake gear sprue and used a Cal Scale No. 294 brake gear and set and Tichy .010" wire. I consulted prototype photos to ensure I mounted the reservoir, AB valve and cylinder in the correct places. I omitted the train line. I used a short section of Builders-In-Scale No. 252 chain to attach the cylinder and the brake rod.

I took great care to ensure that no gear was hanging in a manner that would interfere with the model's operation on my layout. I filed down the injection molding post in the center of the car to make the underframe fit. I discarded the plastic coupler

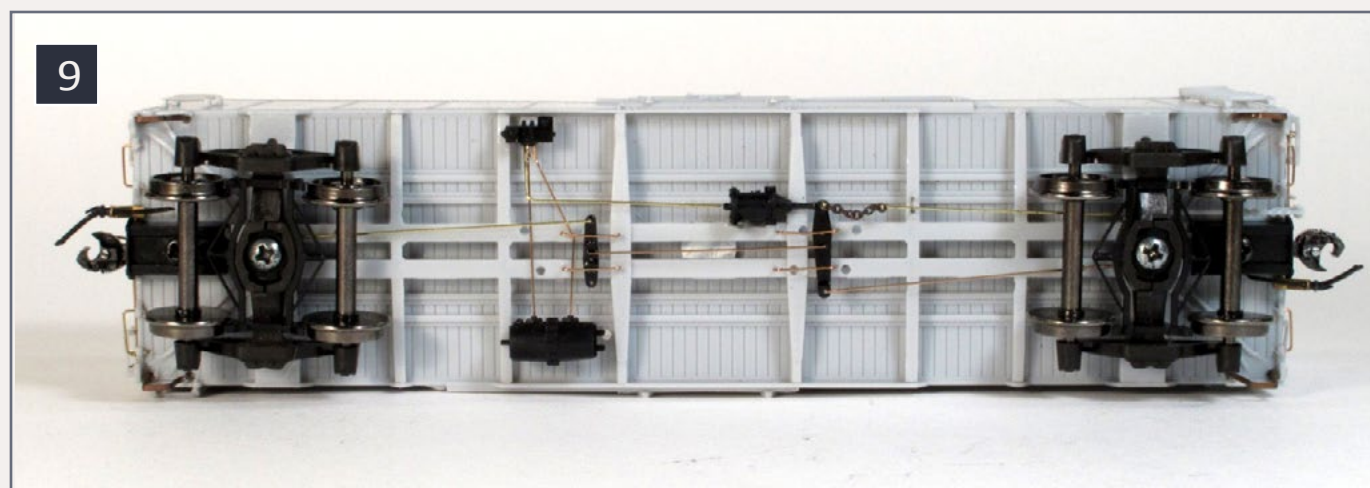

**9. The underframe of the built-up model. I used the Cal Scale AB valve, reservoir and cylinder but replaced all the plastic linkage with brass rod. I did not include the train line or connections from the train line to the valve. I constructed the underframe on rest of the cars in this article to the same standard. John Golden photo.**

boxes included with the kit and substituted Kadee No. 178 scale couplers, which I glued in place and then screwed in to provide a solid connection to the carbody.

Photo [9] shows the trucks installed. I used the new Kadee No. 564 50-ton Bettendorf Self-Centering Trucks with two-piece HGC parts for this model. I'm not satisfied with the appearance of the Accurail Bettendorf truck and have not found a suitable alternative, but this new Kadee truck sideframe looks great and operates well, and it is now my new standard. I ordered the truck sideframes direct from Kadee [kadee.com](http://kadee.com) without the wheelsets and used Reboxx No. 01-1.030 wheelsets.

Next I constructed the B end of the car. I used many of the kit-supplied parts, but cut off the retainer pipe and applied it as a separate piece. I used a Kadee brake wheel and made my own uncoupling levers from Tichy .010" wire and a few Detail Associates No. 2206 eye bolts. I also cut the trip pin off the Kadee coupler and added a Hi-Tech Details No. 6040 air hose with brass mounting bracket. Since I am modeling an as-delivered car, I mounted the tack board in the high position. I finished the A end in the same manner but without the brake gear, of course!

Next, I moved on to the car sides. Again, this was a simple and straightforward process. I attached the kit-supplied grab irons, ladder and car door, and then added the placard and route car holder to the door. I followed the same procedure for both sides. I cemented the doors in place.

Last, I constructed the car's roof. For this model I used Plano No. 11920 40-foot Gypsum Boxcar Running Board, Diamond Pattern, which is a photo-etched stainless steel detail part. I made latitudinal running board supports with Evergreen .010"

x .030" strip and then fixed the running board to the roof using CA. Before gluing I roughed up the running board supports on the roof and the bottom of the running board with some fine-grit sandpaper. I made my own end supports with the Evergreen .010" x .030" strip.

Note that the roof is not fitted to the model in [10]. I did not attach it because it will be painted black separately from the rest of the model. Interestingly, I was not able to photograph the model with the roof attached because the two 400-watt bulbs I used for light heated up the running board so quickly that it bowed the roof to the point that it would not fit securely.



10. A view of the unpainted B end of the model. A few aftermarket items can be seen, including the A-Line sill steps, Plano brake step, Kadee Apex brake wheel, and Hi-Tech air line and bracket. The narrow (0.088") width wheels from Reboxx greatly improve the appearance of the car. John Golden photo.

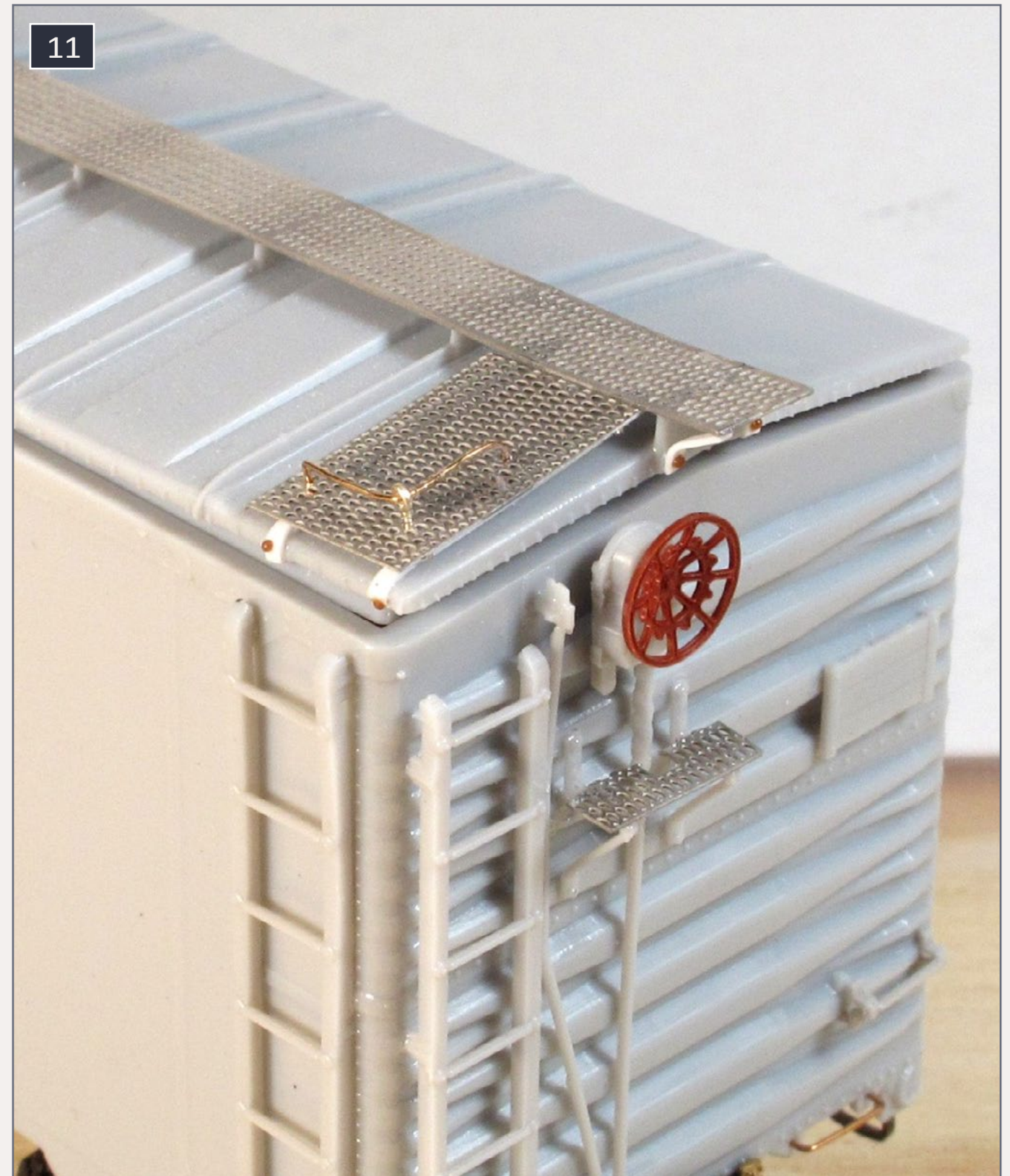

11. A close-up view of the B end of the model, with emphasis on the roof. Note that the roof is not securely fitted to the body. While photographing the model, the two 400-watt bulbs I used for lighting heated up the stainless steel running board, causing it to temporarily bow the roof out of alignment.

## Finishing

When construction is complete, I clean up the model for painting by giving it a thorough sandblasting in my North Coast blasting booth. Blasting removes the factory paint and etches the plastic, wire and any slippery engineering plastics to allow better paint adhesion. The sandblaster is an indispensable tool for the experienced modeler, and can be used to weather models as well.

After blasting I clean the model thoroughly with soap and water and set it aside to dry. If you don't have a sandblasting booth, you can buy an inexpensive one from Badger. A thorough soapy water cleaning is usually sufficient to



**12. The completed model ready for paint and finishing. I have always enjoyed the way completed, unpainted models look. I have to admit, sometimes I find it hard to paint them!**

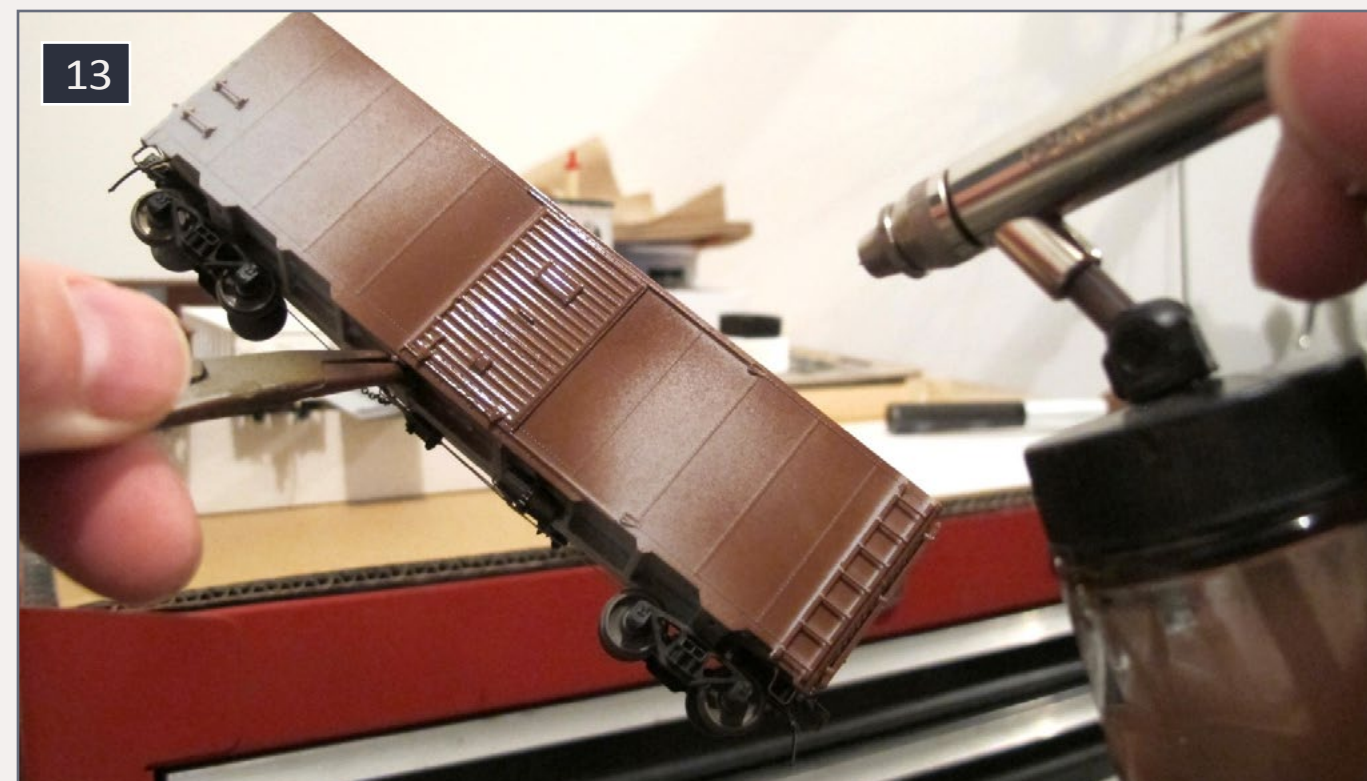

**13. Painting the car body.**

remove oil and plastic residue prior to painting. Let it dry thoroughly before moving on to paint.

When the model is dry, I paint the entire car -- sides, ends, underframe, and trucks -- with Scalecoat 2 Box Car Red No. 1. I mix the paint with about 20% thinner. As you can see in [13], I was lazy and didn't remove the trucks and couplers before painting. I don't recommend you do this, unless you're rushed for a magazine deadline. The roof is Floquil Black.

Once the paint is completely dry, I decal the model using the Speedwitch No. D-103 SAL Box Cars decal set. This is an outstanding product with everything the modeler needs to decal a B-8 or a B-9 correctly. The Speedwitch set is printed by Microscale and each decal is printed on its own individual decal pad which eliminates almost all the detailed cutting normally necessary with other sets. It is truly a 21st-Century decal set.

I cut out the decals for both sides and both ends on a piece of glass using a sharp No. 11 X-Acto blade, and organized the decals into piles, one for each side and one for the door decals and end decals. I apply the decals and carefully move them into position with a dull No. 11 knife.

Normally I apply Microscale Micro-Sol to the model's surface before laying on the decal to prevent "silvering" — micro-bubbles that get trapped under the decal -- but Micro-Sol tends to distort Speedwitch decals because they are so thin. Instead, I place them directly on the car side. I decal each car side separately after the opposite side was completely dry.

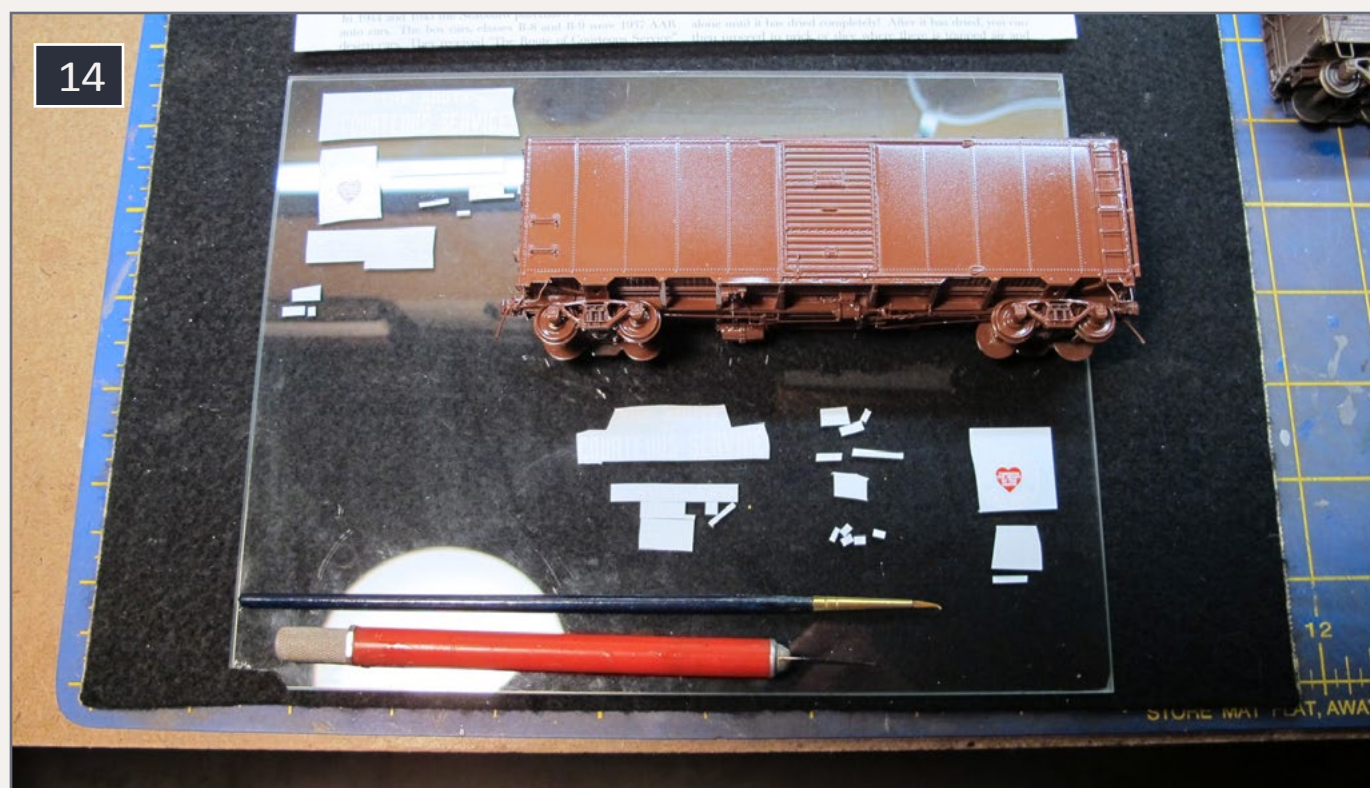

**14.** This photo shows my typical decal process underway. I cut out the decals for the entire model on a thick glass sheet, then organize them into groups depending on which part of the car they will be used on. I then “paint” the decals with water and drag them off the paper with the paintbrush and apply them directly to the car. I do not use the popular “float-off” method.



**15.** I use a flat artist's brush to slightly change the color of the side panels, providing a contrast between the panels, doors, rivet lines, and other parts of the car. In this case, I'm using water-based Special Oxide Red to give the side a slightly orange hue. This brings out the brown rivet lines and brown door, and will provide a nice weathering affect when the black roof is applied.

After the decals dried completely, I went back with Champ Decal Setting solution to soften them so they could settle into around details. When the decal set was dry, I went back and popped any bubbles with a sharp X-Acto blade and re-applied the decal set.

After decaling was complete, I washed the car thoroughly to clean any decal adhesive off the model and prepare it for finishing. Then I airbrushed the entire car with a solution of 40% Testors Glosscote, 40% Testors Dullcote, and 20% thinner. This secures the decals, hides the decal film, and provides a uniform

satin finish. Then I began the basic weathering process, lightly weathering the sides and ends with a variety of colors using a No. 8 flat synthetic artist's brush. My goal was to simulate a car in service for about five years (I model September, 1950) that has not been repainted. I used Floquil Box Car Red, Mineral Red, and Special Oxide Red to provide subtle contrasts to the model without obscuring the decals too much. I purposefully painted over the decals in a few spots to simulate fading.

After this initial weathering I spray the underframe and lower sides and ends with Dust to provide a dust coating over the initial weathering. Then I streak the sides again to obscure some of the dust coat, and keep going over certain areas until I think the effect looks right. I paint the trucks with the dust mixture and then highlight them with Special Oxide Red, then weathered the journal box covers with Black.

Next, I use Model Masters Russian Earth Brown to bring out the details. I use a highlighting technique made popular by master model maker Francois Verlinden. I dip the flat brush slightly into the paint, wipe off about 98% of it, then lightly stroke the car from top to bottom. With light, even strokes, the rivets, corners, and other stand-out details will pick up the color but not the flat surfaces, providing a "highlight."

Generally I use lighter colors to highlight dark-colored models and darker colors to highlight light-colored models. Highlighting makes the details really stand out without discoloring the rest of the model. I often overdid the highlighting, so I simply went back over the area with flat black paint and highlighted it again. I highlight the entire car, including the interior, trucks, couplers, and all the underframe components.

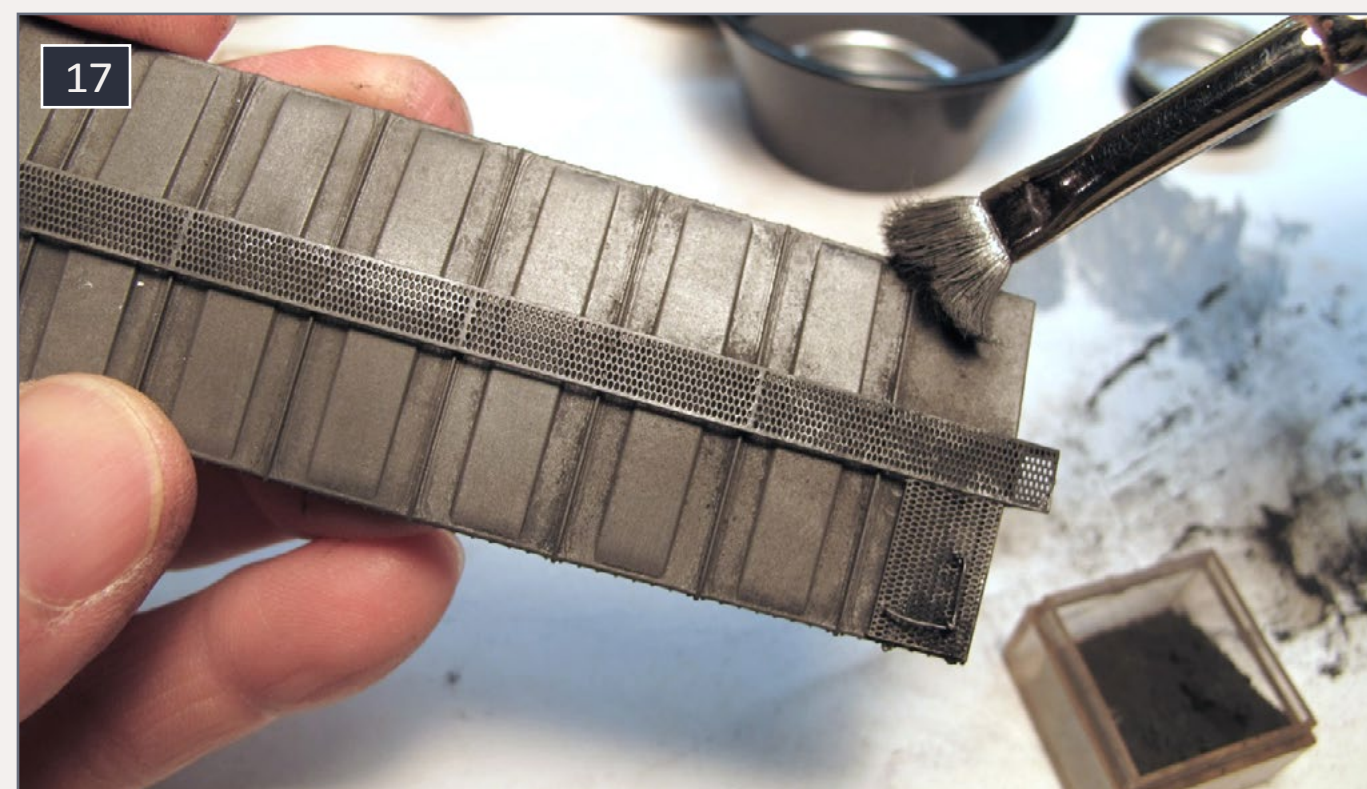
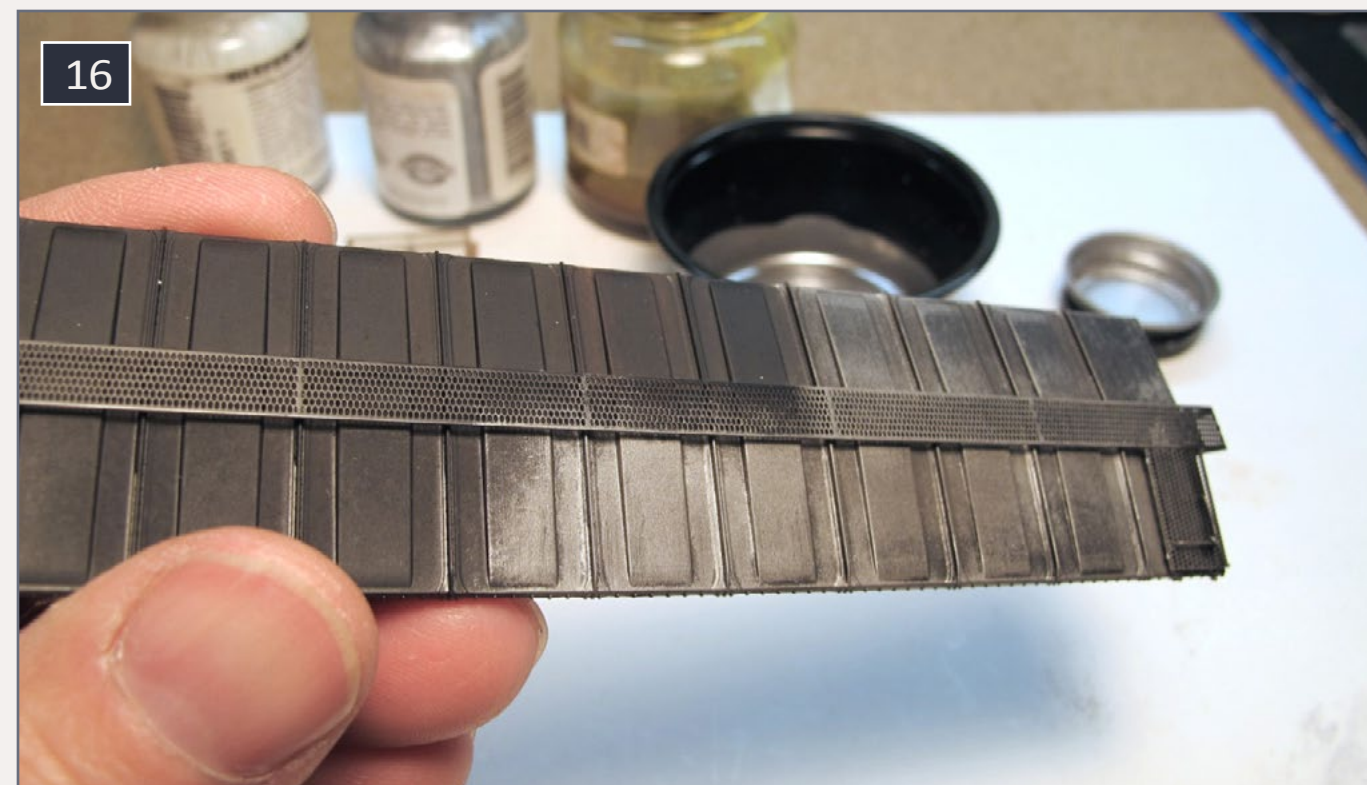

**16. Initial weathering of the roof. I brush on a mixture of Floquil Old Silver to give the roof a galvanized appearance.**

**17. While the paint is still wet, I apply black pigment from Bragdon's Powders to distress the silver color.**



18. The Bragdon pigments can be “scrubbed” into the roof surface. Work over a hard surface so the powders can be picked up.

19. I use an old soft toothbrush to blend the colors slightly. The technique leaves a rough, mottled appearance that looks like corroded metal.



To finish the roof, I first apply a coat of Floquil Old Silver, and mix in Bragdon’s Powders Black. The black paint pigment tones down the silver to a more gray color, better representing galvanized metal. I rough up the surface using an old toothbrush. I apply this mixture several times until I get the appearance I want, then seal everything with a sprayed coat of about 75% Dullcote and 25% Floquil Black.

After the roof is weathered to my satisfaction, I secure it to the car with a few small dabs of CA and reinstall the coupler draft gear and couplers. Polish the wheel treads with a Dremel tool, spinning the wheelsets in the trucks using a Dremel No. 531 brush at about 5,000 rpm. I then secure and test the trucks and wheels for interference, and then test the coupler height. I lubricate the couplers with Kadee graphite and weather the couplers with Bragdon’s Powders Brown.

To finish the model, I add a modified placard decal from the Microscale 1940s Placard Decal set and place it on the car’s routing board (the small board near the bottom of the door). I apply a few hand-drawn chalk marks using an artist’s white pencil and seal them on the car with one light spray of Testor’s Dullcote. I use a nice pencil from the “Stampin’ Up” company; you can find one or one like it at a well-stocked scrapbooking store.

Finally, I declare the car complete and ready for service, sit back and admire my creation, and have a cold beer to celebrate.

## Conclusion

This is a fun and easy project, and I hope you enjoy making your own cars. If you have any questions about this project, please don’t hesitate to contact me at [Golden1014@yahoo.com](mailto:Golden1014@yahoo.com).



20



22



21



23



20. Almost done! The car is weathered and reassembled, the trucks added and wheels polished, and couplers reinstalled and coupler faces polished. Next come fine finishing details.

21. The completed model of SAL 19794 with placards and chalk marks.

22. A second view of the completed model.

23. SAL 19797 is a model finished by the author previously. I rebuilt the car with a similar detail package to that used for the B-9 in this article, but used a Kadee running board and Accurail trucks with Reboxx Code 88 wheelsets. The trucks should be painted Freight Car Brown to match the body.



24. SAL 19591 is another Intermountain model finished by the author, representing a B-8 in its as-delivered configuration. Like SAL 19797 above, the trucks were incorrectly painted black.

25. Denis Blake showed this model of an SAL 13000-series LC car at the 2008 St. Louis Railroad Prototype Modelers meet at Collinsville IL. This is an Intermountain factory-painted model. Denis added roof hatches and a new lower side sill.



**SO REAL...You'll Think You're There!**

**LokSound Select • 3 SIZES, ENDLESS POSSIBILITIES!**

**INDUSTRY LEADING  
MOTOR CONTROL**

- Multiple Bell types  
- Multiple Brake squeals

**4 OR 8 Ohm  
SPEAKERS!**

- 4 or 6 Output functions depending on the style

- Up to 4 Prime Movers or Steam Sounds on EACH decoder

- 16 Very Playable, LOUD Horns or Whistles depending on Profile

- All Changeable by using ONE CV! No Programmers or Boosters needed!\*

**Small Size  
BIG POWER! 1.1Amp!  
LokSound Select  
"4 AUX"**



**LOKSOUND  
SELECT**  
NEW 2011  
Only Available From  
ESU LLC (USA)

- Great NEW Size 1.18" x 0.61"  
- Versatile DCC & DC "Dual Mode" decoder!  
- 8 channel sound system!  
- FOUR lighting outputs and a 1.1A motor controller  
- Available with ALL Current LokSound Select Sound Profiles  
- Use 4, 8, or 16 Ohm Speakers

**ONE SIZE FITS ALL!  
LokSound Select "DIRECT"**



**6 Outputs!  
LED Resistance  
Built In!**

**LOKSOUND  
SELECT**

NEW 2011  
Only Available From  
ESU LLC (USA)

- Easy Drop in Design  
- Versatile DCC & DC "Dual Mode" decoder!  
- 8 channel sound system!  
- SIX lighting outputs ALL with built in resistors for LEDs  
- Available with ALL Current Diesel Sound Profiles  
- Use 4, 8, or 16 Ohm Speakers

**Tiny Size,  
HUGE Versatility!  
LokSound Select  
"MICRO"**



**LOKSOUND  
SELECT**  
NEW 2011  
Only Available From  
ESU LLC (USA)

- Great NEW size ONLY 0.98" x .417"  
- Versatile DCC & DC "Dual Mode" decoder!  
- 8 channel sound system!  
- FOUR lighting outputs and a .75A motor controller!  
- Standard 8-pin NEM 652 plug included  
- Available with ALL Current LokSound Select Sound Profiles  
- Use 4, 8, or 16 Ohm Speakers!

\* ESU LokProgrammer needed to "Replace" Sound and for Firmware updates, not for normal editing

[www.LokSound.com](http://www.LokSound.com) • 477 Knopp Drive Muncy, PA • 570-649-5048

Now on facebook!



## Thanks

Writing articles is not a one-man job. I sincerely thank my friends and fellow historians Bob Liljestrang, Warren Calloway, Larry Goolsby, Ed Hawkins, Paul Faulk and Jan Kohl for providing prototype photos and reference material. ☑



John Golden began modeling in 1970 on his 7th birthday and has been a modeler and railfan ever since. He's a "freight car guy", and is a well-known Seaboard Air Line historian and modeler. John has written 35 articles for a variety of model and railfan magazines. He's created The Seaboard-Coast Line Modeler online magazine and served as the magazine's first editor from 2007-2010.

John is currently building a prototype layout depicting the Minneapolis & St. Louis Railroad in Ackley, Iowa circa 1950. John is also the longtime host of the annual St. Louis Railroad Prototype Modelers (RPM) Meet.

John is a retired Air Force Lieutenant Colonel and still works at Air Mobility Command Headquarters at Scott AFB, Illinois as an Air Force civilian employee. He and his wife Kristina have three children, Jacob (12), Kay (10) and Kirsten (8).

# iwata

by ANEST IWATA

*Just Rolling By...*  
Make It **REAL** With Iwata  
*Climb Aboard!*

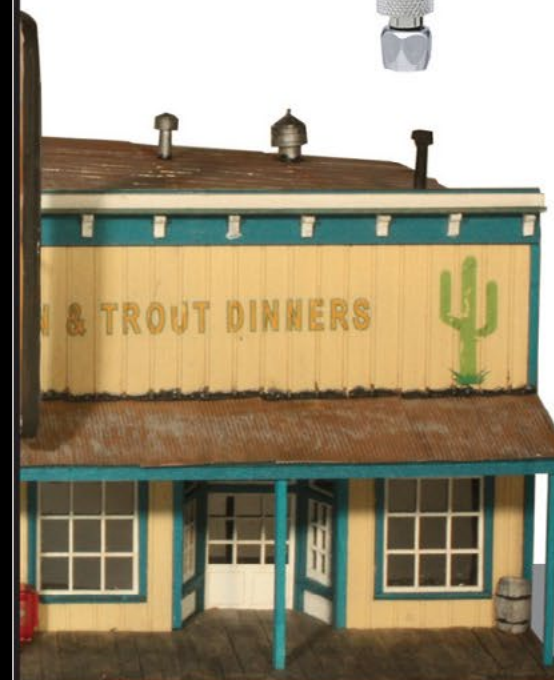

**Visit...**  
**[www.iwata-medea.com](http://www.iwata-medea.com)**  
**To Check Out Our  
Full Product Line!**

*Models By... Alan Houtz,  
North American Prototype Modelers*

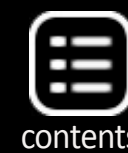

# Yes, it's a model

Model Railroad Hobbyist's monthly photo album



1. Derrell Poole says of this photo: "This is one of the photos from my Uncle Bender's collection. Uncle Bender traveled to Colorado as a young man around 1909 and '10. This view is of C&S 69, a Baldwin built 2-8-0 purchased by the Denver Leadville & Gunnison in 1890. Number 69 is on its way up the east side of Trout Creek Pass on the 170-degree loop over Longs Creek." Darrell continues, "To me, models are a means of experiencing and telling a story, primarily the narrative of history. Every model railroad, including mine, tells a story."

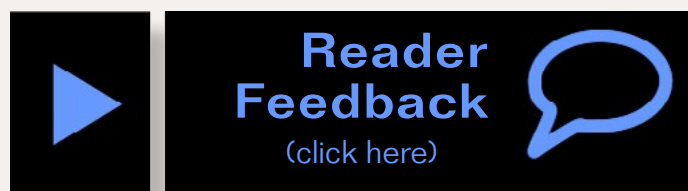

2. Colorado and Southern narrow gauge consolidation number 71 idles after being topped off at the Dickey water tank. The coal bunker was filled the night before at the coal dock a few hundred feet farther down the line. This morning, she will head a trio of locomotives on an assault up Boreas Pass. Awaiting light weathering, number 71 is a custom painted brass import from Overland Models. The scene is photographed on Darel Leedy's "under-construction" Sn3 layout, depicting Dickey, Colorado in the 1920s.





3b



4

3a, 3b. The UP is switching at Industry Avenue with a cut of cars just now blocking the crossing. The boxcar (perfectly weathered by Elmar Manfroid) will be spotted to H&H Tires nearby. And don't forget to go grab a pizza!

We like this photo by Andreas Rittershofer quite a bit. It represents some great modeling of a more modern railroading scene, complete with a nicely weathered and detailed road and crossing. The pizza restaurant in the background just add that extra special touch to round out the setting. All-in-all, a very believable model scene!

4. The California Northern Railroad (CFNR) Maxwell turn arrives at the siding in Cortina, California, where it will perform a runaround move on its train and swap cars with the "Corning Flyer". The grade crossing is Lurline Avenue, a rural county road in Colusa County. The elevator in the background is the DePue rice elevator, Cortina facility.

Dan Kerber's layout depicts the California Northern's West Valley Sub in the fall of 2006-2009. The CFNR GP15-1 is an Athearn Genesis model which Dan re-numbered and weathered. The HS PS 5344 boxcar started out as an Athearn model decorated for Vermont Railway. Dan patched it out and weathered it using an airbrush, acrylic craft paints, oil paints, and weathering powders. He hand-painted the graffiti using thinned craft acrylics and very fine brushes. Dan made the road by gluing down sifted sand, then covering that with tile grout, painted with acrylics and weathered with pastels.

We love the road, it looks fabulous, Dan!

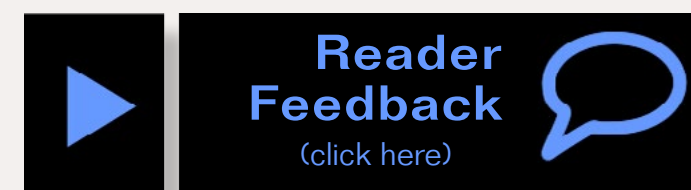



5. While there aren't any trains in this not-quite-finished-scene on Rick Wade's new layout, we love the superb way Rick blended the foreground scenery with the photo backdrop.

Rick says, "This scene is one of many rolling hills scenes on my new Richlawn Railroad HO layout. I started by cutting out the sky on the self-adhesive backdrop that I purchased from Backdrop Junction. Once the backdrop was installed I used my airbrush to lightly mist the hills with white to create the low hanging clouds and continued those clouds onto the painted blue walls.

"For the foreground hill, I applied tinted gray plaster and carved it as it dried to create the rock outcroppings. I covered the hills with fine medium green ground foam before adding 4mm static grass on the hills and 6mm grass at the base of the hill. Finally, I dry-brushed the static grass with tan, brown, and orange paint."

**Modeling Modern?  
We have vehicles for you.**

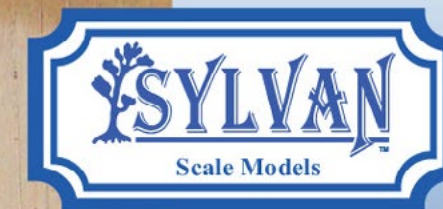

**20<sup>th</sup>**  
1992-2012

OVER 20 YEARS

Not every vehicle on your railroad needs to be shiny & new

32229 Sylvan Rd, RR#2 Parkhill, ON N0M 2K0 Canada - [www.sylvanscalemodels.com](http://www.sylvanscalemodels.com) - [info@sylvanscalemodels.com](mailto:info@sylvanscalemodels.com)



## Get your photo in YIAM!

Our *Yes, it's a model* (YIAM) monthly photo feature presents some of the most inspiring modeling and photos from the MRH website and other locations. If you'd like to get *your modeling* in our photo feature, just start posting your photos on the MRH website, especially in the Weekend Photo Fun thread created each weekend.

Many of the photos posted show HO modeling, but we encourage modelers in other scales to post on the MRH website as well. We don't want this to just be an HO photo feature!

For info on how to post photos to our website, [see this help how-to](#). You need to be an MRH subscriber to post photos to our website, and becoming a subscriber is free, [just fill out this form here](#).



# A short introduction to Weathering steam-era freight cars



– By **Charlie Duckworth**  
Photos by the author

Easy weathering techniques that make you look like a pro ...

1. A string of weathered freight cars rolls past a stock yard. Charlie Duckworth describes the techniques he used to weather them in this article.

One of my favorite aspects of the model railroad hobby is weathering rolling stock, locomotives, and buildings. Whether it's a plastic model in the out-of-the-box factory paint, or a resin model I've just painted and decaled, it just doesn't look right until I've taken a few steps to make it look like it's been in service. Here's how I weather my freight cars.

I always work from a photograph of a car to help me stay within a weathering boundary. It's easy to get carried away and





find you've over-weathered a car. My favorite source is the many period freight car photos in railroad historical society magazines, websites ([lariverrailroads.com/freight\\_car.html](http://lariverrailroads.com/freight_car.html)), or books such as "Railway Prototype Cyclopedia," "Refrigerator Car Color Guide" by Gene Green, or "The Postwar Freight Car Fleet" by Larry Kline and Ted Culotta.

## ExactRail's B&O wagon top boxcar

2. This began with an Exact Rail B&O M53 boxcar. This model has its original factory paint scheme. To age the car, I sprayed it lightly with Dullcote mixed with a few drops of boxcar red and black. This does a couple of things to the model: 1) it blends the starkness of the white lettering in with the car, and 2) the flat finish gives the surface some "tooth" for using dry pigments and pencils. After the Dullcote dried, I used brown and black MIG pigments along the car's vertical ribs where

industrial dust and coal smoke naturally collect. MIG pigments have an adhesive ground-in with the colored pigments, and they won't come off during normal handling. I then used an old paint brush to apply some black pigment underneath the running board, where coal dust would collect. Finally, I used a white pencil to add the switch foreman's or conductor's switching instructions.

2



CHECK IT OUT!



Advertisement

Announcing our newest HO-Scale Craftsman Structure Kit . . .

## The Tiffany Clockworks



Order yours today at [www.motrakmodels.net](http://www.motrakmodels.net)



3



### Westerfield rebuilt Texas & Pacific boxcar

3. As with the B&O wagon top car, this T&P model was finished using MIG pigments. I dipped a small brush in the brown pigment, and ran it vertically over the seams. In addition to the brown, a “mid-east dust” pigment was used to weather the trucks and lower body ends. The final step is to use some of the black to weather around the running boards where soot and grime collects. Go lightly on using the MIG pigments – they don’t come off easily as chalk pigments do.

4



### Funaro & Camerlengo Pennsylvania X26c rebuild boxcar

4. I wanted to show this car in heavy use from a Northeast industrial area, so I painted it an oxide red, and decaled it using Jerry Glow’s [jerryglow/decals/full.html](http://jerryglow.com/decals/full.html) decal set. After the decals were dry, I weathered the vertical seams and the lower panels with black oil paint. The area below the car sides was given more black oils to increase the shadows and add dirt and grime where they naturally collect.



quick-drying paint. It will be necessary only to re-new all light-weight numerals, station symbol, date (month, year), and load limit numerals.....The capacity numerals and letters 'CAPY,' 'LD LMT,' and 'LT WT' when indistinct, must be renewed.....”

To show this car was recently weighed, I added a patch of freight car-red paint over the original load-limit and light-weight stenciling and re-decaled newer information. “P283” is the code for weigh station on the Pennsylvania Railroad ,and “1-50” was the month and year the car was weighed.

## Reweighs

5. Due to wear on the freight cars and changes made during shoppings, AAR Car Service Rule 11 mandated that new composite wood and steel underframe and all steel boxcars were to be reweighed after the first 15 months in service, with subsequent reweighing every 48 months. New open-top cars and covered hoppers were reweighed after the first 30 months in service, and every 30 months for subsequent light weighing. New refrigerator cars, all-steel flatcars, all-steel house and steel stock cars were to be light-weighed 30 months after the initial weighing, and 48 months for all subsequent weighing. (from the January 1956 “ORER.”)

The rule also reads, in section F, paragraph 30, “When cars are re-stenciled after re-weighing, all old stenciling to be renewed must be obliterated with

Advertisement

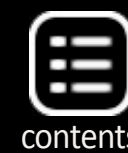

6



## Accurail's CN boxcar

6. This “out-of-the-box” Accurail Canadian National boxcar illustrates where I used a small amount of white oil paint around the lower part of the doors to denote where flour bags broke and spilled during transit, or while loading or unloading. You see this on a few freight cars in a consist, and it adds a little variety to a cut of cars. I upgraded the model to match my resin cars by replacing the cast-on grab irons and ladders with wire and plastic ones.

7



## Intermountain Union Pacific 1937 boxcar

7. Here's another example of a Union Pacific car that's been loaded around a flour mill. As with the PRR boxcar, a small red patch was added, and a new light weight, weighing station and date were added. The car was weathered using white oil paint to show heavy loading around a flour mill. After the paint was dry, I gave the car a light coat of Dullcote.

8



### Rocket Express 50' automobile boxcar

8. This RI car was finished using Dullcote with a couple of drops of boxcar red added as a tint. The car was then given a light dusting of brown pigments, and sprayed again with a light coat of Dullcote. At some point in its career the car was removed from automobile service, so the horizontal boxcar red patch on the right side of the car that denotes the original 'AUTOMOBILE' lettering was painted-out by the Rock Island RIP track workers.

### Accurail's Rock Island USRA boxcar

9-10. Accurail did a great job of capturing the lettering on this car. In addition to weathering the car, I removed all the cast-on grab irons and replaced them with wire ones. I then airbrushed the handhold areas with a BCR that matched the factory paint. Next was to over-spray the car with a light Dullcote mixed with a few drops

of black and dust to tone-down the lettering. I then used black and light brown colored pencils to lightly highlight some of the vertical boards on the sides and doors for additional weathering. The prototype roof was painted with black roof cement, so I used a mix of black and white oil paints to denote a weathered roof with some of the roof cement flaking off.

9



10





## Accurail wood reefer

11. This model was repainted and decaled with the Microscale decal set for BFEX reefers. The molded-on grab irons and ladders were replaced with wire and plastic ones. The car was finished by over-spraying it with a Dullcote mixed with a couple of drops of black and brown to tone down the sides. After the Dullcote was dry a new #11 X-Acto blade was used to remove some of the Dullcote mixture around the grab irons and ladders, where trainmen would have climbed on the car. A few individual boards were also picked out with the X-Acto blade to age the car sides more.

## White and yellow pencils

The best white pencil for adding chalk marks is made by Prismacolor; the number on the pencil is PC938. To be honest, the yellow pencils don't do a great job, and you could skip them all together. The important thing is to weather some of the white pencil marks to age them, and have some contrast to new marks. I use white and yellow pencils where a conductor, engine foreman, carman made chalk marks on a steam-era car. Look at vintage freight car photos to see the variety of numbers and letters used by different railroads. Put one on, and gently rub it off, then add another next to it, to show the aging process.

## Oil paints

I use mostly black and brown to denote oil and grease. Mix a little with mineral spirits and dab around the journal boxes to show there the carman added oil. I also put some on the door latches

and along the lower door guide where a carman would have greased these areas.

## Conclusion

I hope this short introduction into weathering inspires you to get started on your fleet. The techniques I use are very easy, they just take a bit of practice. In no time at all you can weather your cars like a pro. So jump in and get started.

Advertisement

"O" Scale Standard Gauge

\$89.95 each

San Juan Car Co. 190 Turner Drive Unit C, Durango, CO 81303  
(970) 385-5256 Fax: (970) 385-1030  
sanjuancar@durango.net • www.sanjuancarco.com

[Reader Feedback](#)  
(click here)

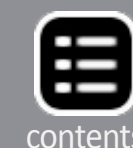



Charlie Duckworth retired from Union Pacific after 38 years. He started with the Missouri Pacific in 1974. Charlie has written articles for Mainline Modeler, Model



Railroader and Model Railroad Hobbyist. He has a Yahoo Group (Mopac-Bagnell-Branch) where you can subscribe and see photos of his layout and read about his latest resin freight car or building additions.

Advertisement



## MRH's streaming internet TV channel for Model Railroaders

Advertisement

# Rslaserkits



Coming soon in HO and N scales  
 Courter Building Supply & Manufacturing  
 Custom Milling, Furniture and widows  
 Building was across the tracks from  
 Cobleskill Coal in Cobleskill, NY

Dealers welcome  
 Salem, OR  
 503-371-4290



Custom Laser Cutting  
 and design  
 Sales@rslaserkits.com

## TMTV Subscription

**\$5.99 / month**

MRH subscribers  
 (save 20%)

|         |                     |      |                         |
|---------|---------------------|------|-------------------------|
| 1 year: | <del>\$71.88</del>  | \$55 | \$44.00                 |
| 2 year: | <del>\$143.76</del> | \$99 | \$79.20<br>(best value) |

MRH subscribers: get TMTV discount code on June bonus downloads page ([click here](#))

Visit [TrainMasters.TV](http://TrainMasters.TV) website



# Fast and Easy TREES

Making lots of trees  
the easy way ...



– **By Randy McKenzie**  
Photos by the author

Covering a layout with thousands of trees normally comes down to very few choices: Puff balls, kits, or Super Trees. I needed a better option for my HO triple-deck Virginia Southern. My solution is easy, fast, and cheap. I call them “Secondary trees,” meaning they are not as detailed as Super Trees, but give a transition between front-row trees and puff balls in the distance.

Let’s get started:

1. **Virginia Southern caboose VS 50 tags along at the end of an empty coal train as it heads through the lush green forests of Virginia.**





## STEP 1: Collecting the materials

Materials needed:

- Queen Anne's Lace or any other dried weed stem
- Side cutters
- Bailing twine or small sisal twine.
- Foam blocks
- Fine ground foam, various colors
- Spray paint, Kelly green
- Rubber cement or Aleene's Tacky Glue



2. Queen Anne's lace forms the base of the trees. The great thing is, it's free. Just go out and collect it. Allow it to dry about two weeks. Begin by clipping off the head of the weed.

## STEP 2: Preparing the materials



3. Start clipping the weed stem into trunks of various lengths. I use a container to hold the trunks until I am ready to use them.

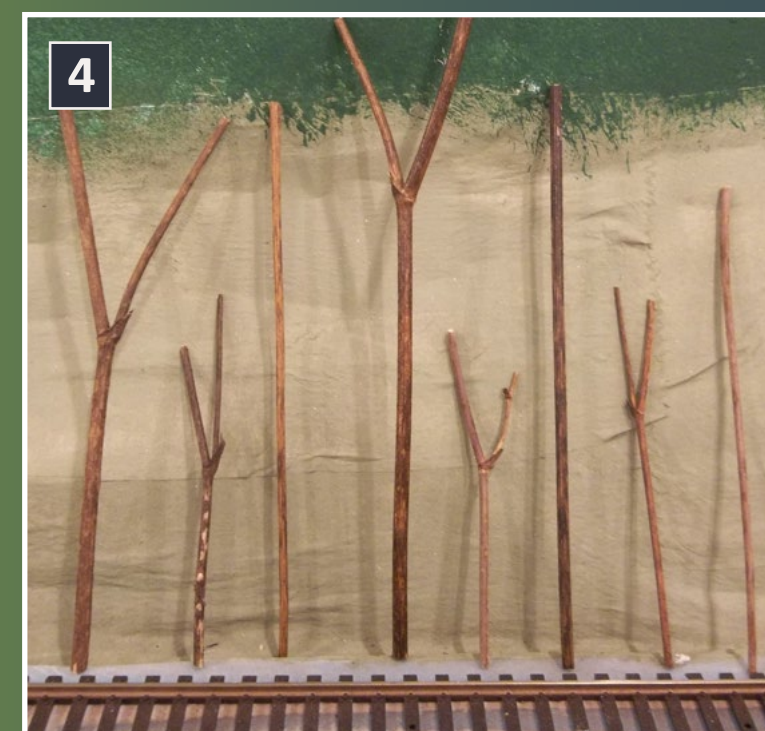

4. Here are a selection of trunks I cut to various lengths.

The entire weed stem can be used, the forked branch as well as the straight trunk.

## STEP 2: Preparing the materials *Continued ...*



5. Prepare the twine by cutting it into lengths between  $\frac{1}{4}$ " to  $\frac{3}{4}$ " long for N and HO scale. I cut and mix the random lengths in a plastic container. The twine will normally unwind when it is cut; if not, roll it between your fingers to get the individual strands.

The key is to have a random mix of twine lengths. This creates the uneven branch structure of the tree.

## STEP 3: Gluing the twine to the trunks



6. Give the top section of trunk a coat of rubber cement. I coat about two-thirds of the stem. Tacky Glue can also be used.



7. This is what the trees should look like with the twine applied to the trunks. Sprinkle the cut twine over the wet glue. I work in batches of six to 15 trees. I use a foam block as a palette to hold the trunks between steps. This also makes an easy way to carry the trees to the layout for planting. At this point they don't look great, but the next step is the **MAGIC**.

### STEP 3: Gluing the twine to the trunks Continued ...

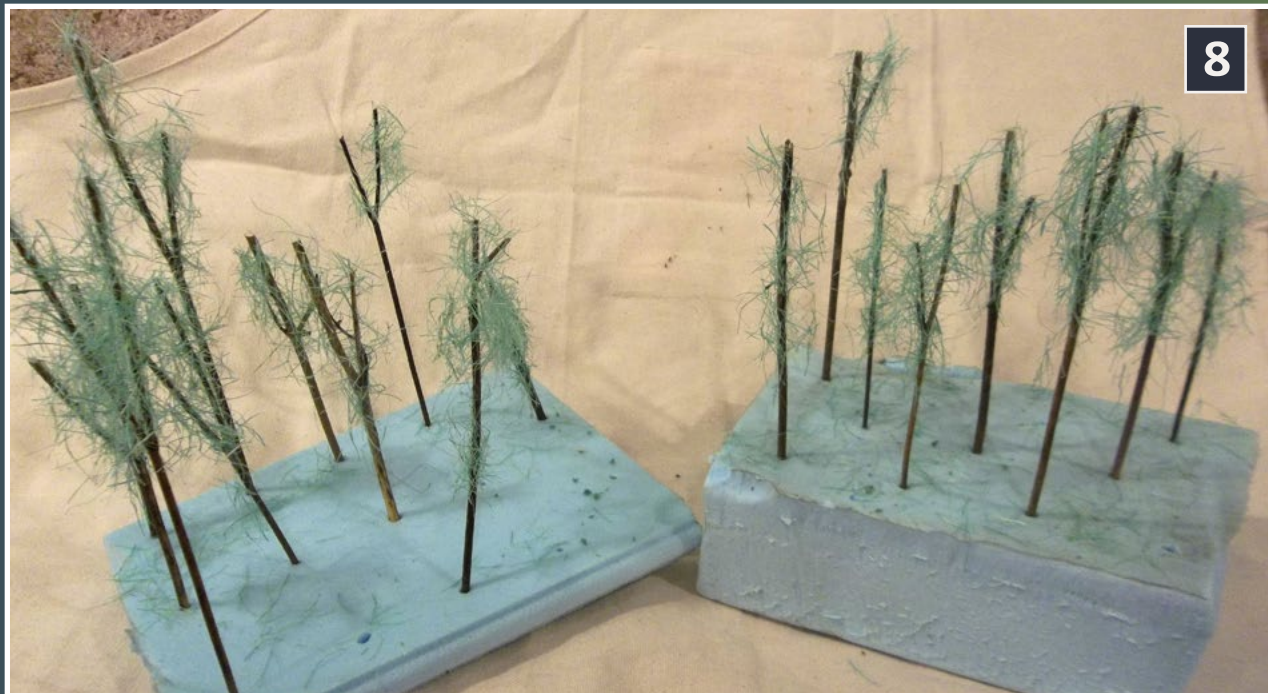

8. Here are a group of trees ready for foam.

### STEP 4: Adding the foam



9. These are the adhesives I use: Spray adhesive, 3M General Purpose 45, Rubber cement or Tacky Glue.

Advertisement

*It's not just a model,  
it's a piece of history.*



## WHAT'S ON YOUR LAYOUT?

80+ HO Prototype Craftsman Kits  
400+ HO Pewter Castings  
200+ Styles of Shingles in N, HO, and O



**Bollinger Ederly  
Scale Trains**

[www.besttrains.com](http://www.besttrains.com)



Email



Phone

Advertisement

**CHECK  
IT OUT!**



**Been WOWed?**

**WOWSound**

*The world's leading sound decoder*



Email



Phone

Advertisement

**THE O RESOURCE**

NEWS, REVIEWS, INFORMATION TO USE

**SCALE @ New** **On Line Magazine**

[www.oscaleresource.com](http://www.oscaleresource.com)



Email



contents



index

## STEP 4: Adding the foam Continued ...



10. Give the trunk and twine a light coat of green paint. Next spray adhesive, until the twine is covered. With practice, you know how much adhesive is required. Not enough, and the foliage will be too thin; too much, and it will look more like a green corn dog.

Sprinkle green ground foam onto the glue. Tap the tree to knock off the loose material. If the twine is still exposed, sprinkle on more.

## STEP 4: Adding the foam Continued ...



11. Rotate the trunk, and sprinkle foam on the other side. Repeat the steps in [10].

## STEP 4: Adding the foam *Continued ...*



12

12. You now have a tree ... With materials ready, you should be able to turn out a tree in about 30 to 45 seconds. I use several colors of foam, and plant the trees in random mixes of colors and sizes.

## STEP 5: Planting the trees



13

13. Start in the back and work your way forward. Random spacing along with varying heights will create a very natural-looking mountain of trees. Secure the trunk of the tree in place with white glue.

## STEP 5: Planting the trees *Continued ...*



14. A group of trees waiting to be planted near Crabtree Tipple on my layout.



15. A finished section of my layout filled with the fast and easy trees. ✓



Randy McKenzie cannot remember a time he didn't love trains. After building his home in 2003, he started his Virginia Southern in June 2004 and filled his 32x38 area with a triple-deck HO layout. The VS is a proto-freelance merger of the Clinchfield and Interstate Railroads, modeling Elkhorn City KY to Kingsport TN.

Randy works as an electronic communications technician for the Virginia State Police, serves as a Cub Master and Assistant Scout Master in the Boy Scout program, enjoys fishing, camping, and amateur radio. He is married with two children who also share in building the layout.

You can see more of the Virginia Southern Model Railroad on Facebook ([facebook.com/groups/485922974770191/](https://facebook.com/groups/485922974770191/)).



# MRH \$500 layout contest 1st place



Modeling a  
shortline for  
under \$500 ...

– By Eugene Griffin  
Photos by the author



A BNSF crew is switching local industries in my home town. It inspired my present-era design, due to the variety of equipment still in service.

**M**odel Railroad Hobbyist articles have inspired you, the photos in MRH blogs have awed you, and you want to give it a try.

## Modeling a real railroad in a specific era

The budget and space certainly does not allow an entire class I railroad, or even an entire short line to be modeled (It would take at least 6,069 feet of track in HO scale to model a 100-mile short line, without sidings – well over the \$500 budget).

Focusing on an era helps eliminate distractions when visiting the hobby shop. So now, no matter how great that 40' boxcar looks, if it isn't in service on the railroad during the era that has been chosen, it won't be purchased.

I won't mention the specific railroad I chose to model, because I may change my mind. I will say I chose a modern-era North American short line with 100 miles of track and a good variety of industries to model. It interchanges with two class I railroads and terminates in a small city.

## Research

The decision to focus on the modern era and an operating railroad greatly reduces the amount of research time. Using the Internet and tools such as Google Maps or the Maps app on an iPad to gather railroad specific information can greatly help in researching the railroad.

## My research focused the following questions:

- What route does the railroad follow?
- Does the geography change along the route?
- What is the track arrangement in general over the route?  
Location of passing tracks, interchanges?
- What towns does the track pass through?
- What industries are being served in what towns, based on satellite images?

- What are the track arrangements for those industries (if satellite resolution permits)?
- What motive power is being used?
- What equipment is being used?

After spending a couple of evenings “flying” over the short line using Google Maps and the iPad Maps app, I found the satellite images from Google Maps lagged the iPad Maps satellite images. A wood pellet manufacturer had added a siding alongside an existing siding, and an animal feed industry was built with a runaround track for that industry. The Google Street View image was newer, and confirmed the additional siding



**2. The feed industry with covered hopper (left) sitting on a recently built runaround track. Selecting to model between the building and the track, with the implied building in the aisle, will reduce cost.**



and industry (the runaround siding wasn't visible from the street view).

After a week of on-and-off Internet searching, I had gathered enough information to start choosing what to model. I know the shortline primarily serves the lumber industry. It also serves a wood pellet manufacturer, steel beam fabricator, juice-based beverage manufacturer, animal feed and seeds



**3. The budget will limit the structures used to model industries for now. However, this covered hopper unloading location does not require any buildings. To the left of this photo the track ends in front of the steel beam fabricator; 11 60' car-lengths to the right is the dirt ramp for a corrugated pipe manufacturer, and the beginning of the siding.**

distributors, flour mill, chemical distributor, scrap metal yards, cement distributor, oil distributor, propane distributor, and a transloading terminal.

The railroad primarily uses leased GP38-2 diesels. It once had a leased SW1500 (Conrail logo still visible).

Satellite images may capture freight cars in the siding, and provide a clue about the length of the siding and type of freight cars used. As a bonus, Google Street View may capture freight cars at an industry or siding, and if you are fortunate, as I was, an engine crew switching an industry.

To help with modeling the railroad and designing the track plan, take as many screen shots and notes as possible.

## Design

Let's start the initial design phase by defining requirements of the model railroad, keeping in mind the reality of the budget and space.

### The design goals are:

- Point-to-point operation
- Modular design
- Easily expandable
- Easily transportable
- Industrial switching
- Freight yard
- One engine (GP38-2, hopefully)
- Modern freight cars
- Avoid compression
- Operational challenge

One design criterion I needed to allow for is modern-era freight cars. So, for now, I decided on a 30" radius curves for the main, 28" radius for sidings, and #8 turnouts.

My current residence has a den measuring 9' 2"x11' 7" with a large opening to a hallway on one of the narrow walls, leaving a 2' wall on either side of the opening.

I did a few iterations of possible designs, and the one that meets the above criteria with respect to benchwork is modules that are 1' wide, and a maximum 4' long. The length was chosen to fit easily into my car. Additional connecting modules will be designed to accommodate the curves. Legs will be used to support the modules.

I know that a point-to-point railroad with one engine needs a runaround track at both ends. I have learned from articles that multiple industries on one track can make an enjoyable switching challenge. I know I am attempting to model a real railroad, and that I have limited space and budget.

## Industries

A runaround track to service an animal feed industry on the shortline provided the location to model. Just to the north, a separate siding serves a steel beam fabricator, a covered hopper unloading facility and a corrugated-pipe manufacturer.

Since I am trying not to compress, that will be it for the industrial modeling, for now. The freight yard will exist on the opposite wall and will serve as the interchange with the class I railroads.

## Construction

The benchwork can be constructed using a handsaw, utility knife, pencil, screwdrivers and optionally a hand drill (to drill

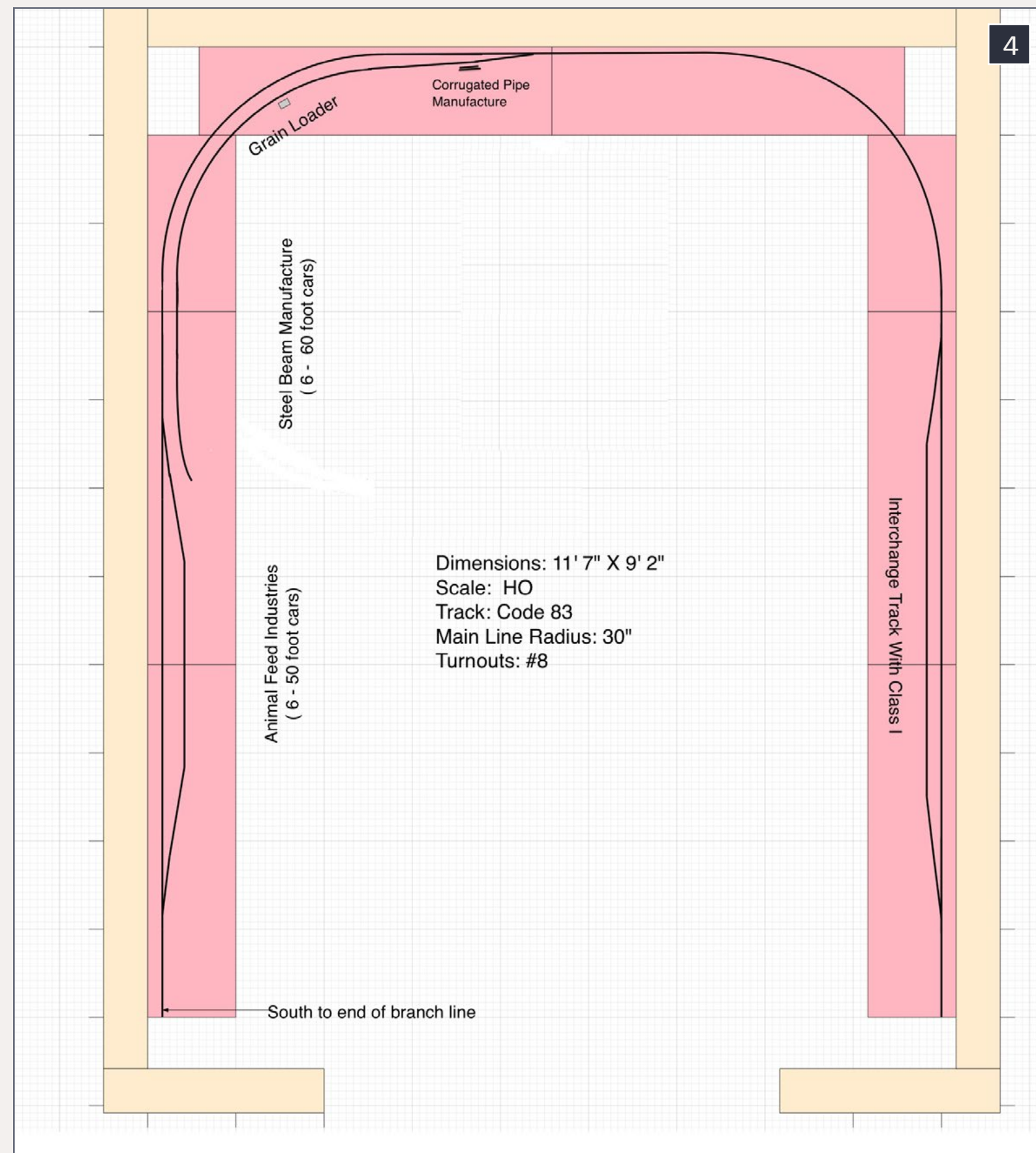

4. The final design which represents four industries in a town, and the interchange with a Class 1 railroad.

holes for the wood screws). The one tool I have is a cordless rechargeable screwdriver and some hex-shank drill bits. This tool or a cordless drill will make construction easier. I selected 1/2" rigid foam insulation for the surface of the module, for ease of transportation.

Cut the 11 pieces of 8' 2x2 in half, for the 11 sets of 48" legs. Next cut six pieces of the 8' 1x3 in half, for the sides of the 4' modules. One piece of the 1x3 is cut into four equal pieces for the sides of the 2' modules. The remaining four pieces of 8' 1x3 are cut into 10-1/2" lengths, yielding 36 pieces for the cross bracing, five boards for each of the 4' modules and three

boards for the two 2' modules. Optionally, another couple of lengths of 1x3 can be purchased to add bracing on the legs.

To prevent damage to floors, cut some scrap cardboard boxes into 2" squares and wrap them in plastic wrap. Place these under the legs to catch any wood sap.

For the surface of the modules, cut one 1/2"x48"x96" rigid foam insulation into eight lengths of 1'x4'. The second sheet of rigid insulation provides the next four lengths of 1'x4', four lengths of 1'x2' and three lengths of 8"x4'. The remaining board will provide the remaining three lengths of 8"x4' and two lengths of 8"x2'.

Cut 4" off of each 8"x4' length, and off of each 8"x2' length, saving the leftover for splines. You should now have the following 1/2" rigid foam insulation pieces:

| Quantity | Description |
|----------|-------------|
| 12       | 1'x4'       |
| 6        | 8"x44"      |
| 4        | 1'x2'       |
| 2        | 8"x20"      |

Laminate the sheets together by applying white glue to a surface of the 8"x44" section and centering on a 1'x4' section. Apply white glue to the exposed surface of the 8"x44" piece and

place the second sheet of 1'x4' sheet on top. Use six wood screws to secure the sheets together until the glue dries. Repeat for the 2' sections.

Place each section (screws down) on the wood frames, and secure with wood screws. Trim the spline to 3"x8" and place in

5

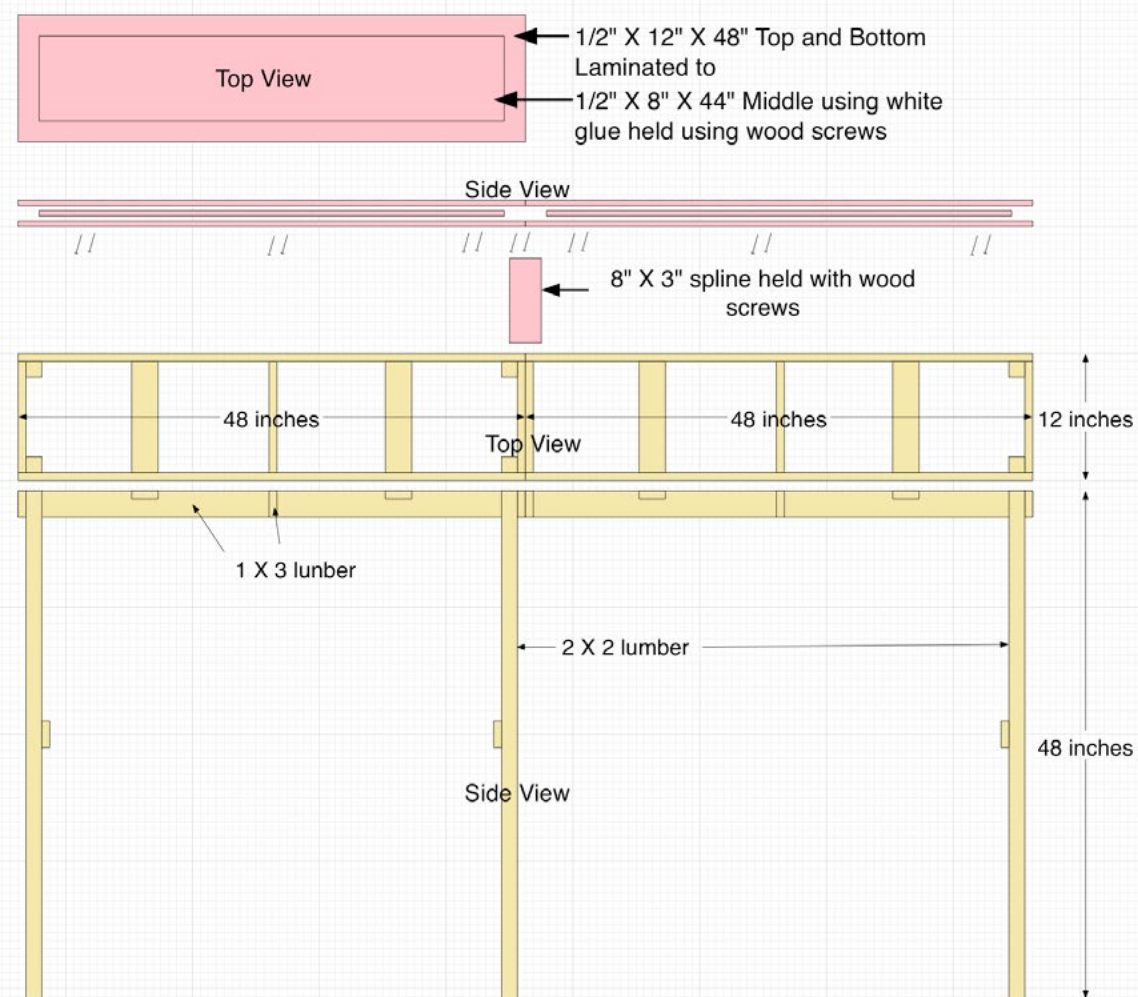

## 5. Construction details for the 1' x 4' modules

the groove between each section, securing with wood screws from the bottom.

## Electrical

I chose a DC power pack to begin the layout. DCC is more expensive, not only for the power supply, but also for DCC-equipped locomotives. However, I do plan to switch over to DCC, and upgrade the locomotive to DCC. After the conversion to DCC, I plan to use the DC power pack for accessories.

The power pack (throttle) will be placed on top of the module on the shortest wall. This will locate it roughly in the center of this point-to-point layout. At first, I thought the location of the power pack would be an issue, but this will enforce operational practices by increasing time between the engine stop and turnout throws or uncoupling (I am not modeling a race track).

The wires will be soldered to the tracks on each module. A scrap piece of rail can be used to fish the wire through the insulation to the groove on the sides. The wires can then be run in this groove to the power pack. The groove can be covered with scrap rigid insulation, hiding the wires, but still making them accessible. For wire connections, twist the wire together and space-out connections to prevent shorts.

## Equipment

I found an Athearn GP38-2 and three freight cars that would fit the remaining budget. Certainly used equipment is cheaper, but I like the new-equipment smell.

## Expenditures

I was a skeptic about cost when I started. I thought there was no way I could model the short line I wanted on a \$500 budget with the space I have. But I came in just under the target budget.

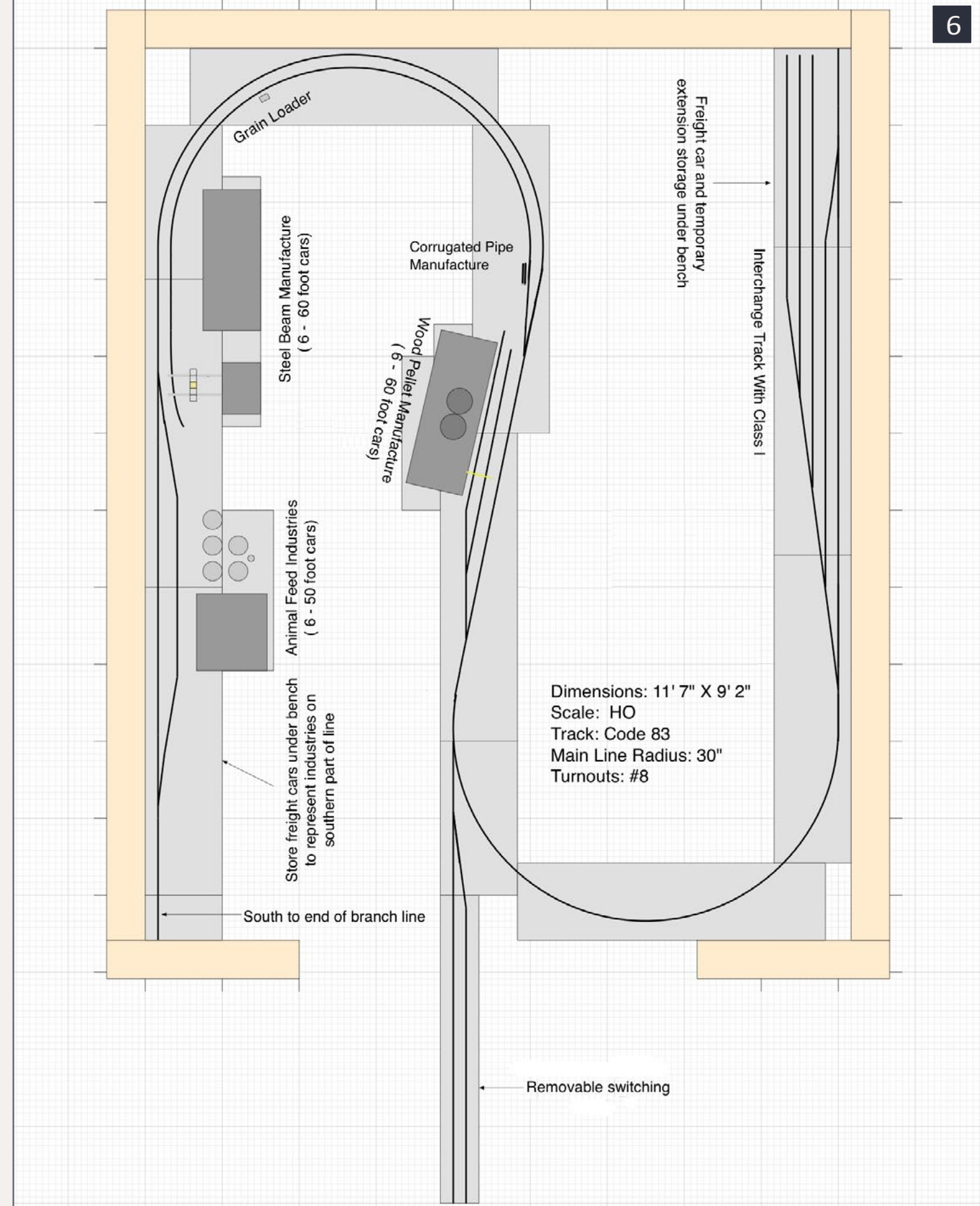

**6. When the budget permits, the layout can be expanded to represent all industries in the town and elsewhere on the shortline.**

## Future

For scenery, paint and playground sand can be used initially, and then ground foam, static grass, and trees can be added. Some material can be gathered outdoors and used (with the appropriate preparation). Purchasing scenic material will go over the budget, but my goal was to get started with track, equipment, and benchwork, so a pink top is OK for now.

I am already considering expansion. A wood pellet manufacturer is the last industry in the town before the short line curves to the north, and then to the west. At that curve, on the east end of town, there are two tracks heading east that can be used for switching (these are remnants of a former interchange with another shortline).

The Atlas track and turnouts will slowly be replaced with hand-laid track. I will use the Atlas track in the interchange area, or in the new storage area under the bench.

The industries can be modeled with parts from kits, or with photo-mural techniques that have been written about in many articles.



7

7. A wood pellet manufacturer close to the center of town has added another siding, shown here occupied with covered hoppers. The original siding is next to the building.

Advertisement



**N SCALE  
GEVO LOCOS**  
ARRIVING  
WINTER 2014



CITIRAIL LEASING - 3 ROAD NUMBERS

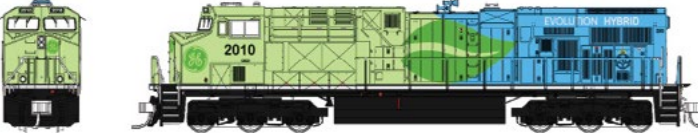

GE EVOLUTION HYBRID - 1 ROAD NUMBER



UNION PACIFIC WITH PTC ANTENNA - 3 Nos.

Reserve yours today!  
[www.foxvalleymodels.com](http://www.foxvalleymodels.com)

Advertisement



**NEW!**

**DCC Train Shuttle ...  
aka, "Prof Silencer"**

**TamValleyDepot.com**



| Source                               | Item                                      | Unit Cost | Qty | Total           |
|--------------------------------------|-------------------------------------------|-----------|-----|-----------------|
| <b>Framing</b>                       |                                           |           |     |                 |
| Home Depot                           | 2x2x8 wood for legs                       | \$2.07    | 11  | \$22.77         |
| Home Depot                           | 1x3x8 wood                                | \$2.12    | 11  | \$23.32         |
| Home Depot                           | Wood Screws #8 1 1/2"                     | \$3.80    | 2   | \$ 7.60         |
| Home Depot                           | FOAM 1/2"x48"x96"                         | \$12.98   | 3   | \$38.94         |
| Home Depot                           | White Glue allowance                      | \$3.00    | 1   | <u>\$ 3.00</u>  |
| <b>Framing Sub-total</b>             |                                           |           |     | <b>\$95.63</b>  |
| <b>Electrical</b>                    |                                           |           |     |                 |
| RadioShack                           | 24 AWG 25 FT Red                          | \$3.65    | 1   | \$3.65          |
| RadioShack                           | 24 AWG 25 FT Black                        | \$3.65    | 1   | \$3.65          |
| RadioShack                           | Solder                                    | \$4.49    | 1   | \$4.49          |
| Hobby shop                           | MRC Railpower 1370                        | \$59.98   | 1   | <u>\$59.98</u>  |
| <b>Electrical Sub-total</b>          |                                           |           |     | <b>\$71.77</b>  |
| <b>Track</b>                         |                                           |           |     |                 |
| Micro-Mark                           | Xuron track cutter                        | \$16.20   | 1   | \$16.20         |
| TRACK                                | Atlas 36" Flex Track                      | \$5.99    | 15  | \$89.85         |
| TRACK                                | Rail Joiners (24)                         | \$1.89    | 2   | \$3.78          |
| TRACK                                | Atlas Turnout #8                          | \$16.99   | 5   | \$84.95         |
| <b>Track sub-total</b>               |                                           |           |     | <b>\$194.78</b> |
| <b>Equipment</b>                     |                                           |           |     |                 |
| Athearn                              | GP-38-2                                   | \$84.99   | 1   | \$84.99         |
| Atlas                                | Thrall 4750 Covered Hopper, First Union R | \$17.99   | 2   | \$35.98         |
| Atlas                                | 62' Flat Car, BNSF #592515                | \$15.49   | 1   | <u>\$15.49</u>  |
| <b>Equipment total</b>               |                                           |           |     | <b>\$136.46</b> |
| Taxes and shipping are not included. |                                           |           |     | <b>Total</b>    |
|                                      |                                           |           |     | <b>\$498.64</b> |



Eugene returned to the hobby after a thirty-year hiatus. He reignited his love of the hobby and unpacked the Athearn blue box kits that have followed him from childhood.

He built a switching layout, but constant relocations for work resulted in its dismantling. Not letting the frequent moves deter him from his new-old hobby, he switched to inexpensive lightweight modular designs that can be disposed of without huge financial loss.

He models a modern era shortline, and looks forward to many years of enjoyable learning, experimenting and mastering the many aspects of this great hobby.

Advertisement

**CHECK IT OUT!**



**Rusty Stumps**  
Scale Models

**WE ONLY SELL WHAT WE MANUFACTURE**

**DETAILS** IN HO, O, S & N SCALES  
LASER CUT SHINGLES, DOORS & WINDOWS, FENCES, SIDING, CRATES. Also RESIN and WHITE METAL DETAILING CASTINGS.

**CRAFTSMAN KITS**  
IN HO, O & S SCALES

**CHECK IT ALL OUT AT**  
**WWW.RUSTYSTUMPS.COM**

Send \$3.50 for Catalog - Specify Scale  
**RUSTY STUMPS SCALE MODELS**  
6785 Cherry Blossom W. Dr., Fishers IN 46038  
Phone (317) 595-9489

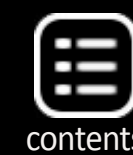

# Using Vallejo Earth Texture for roofing



– By Rob Bennett  
Photos by the author

1. New roof,  
Black Lava  
applied, with  
new vents and  
AC unit.

## An easy technique for getting a realistic-looking textured roof ...

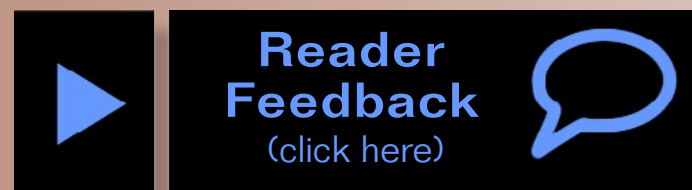

I recently was in need of a small office for my engine facility. Not wanting to scratchbuild, I found the Walthers Conerstone Industry Office, kit #4020. The overall look and size were perfect. I made a few modifications, including repainting into more of a redish brick color, adding mortar

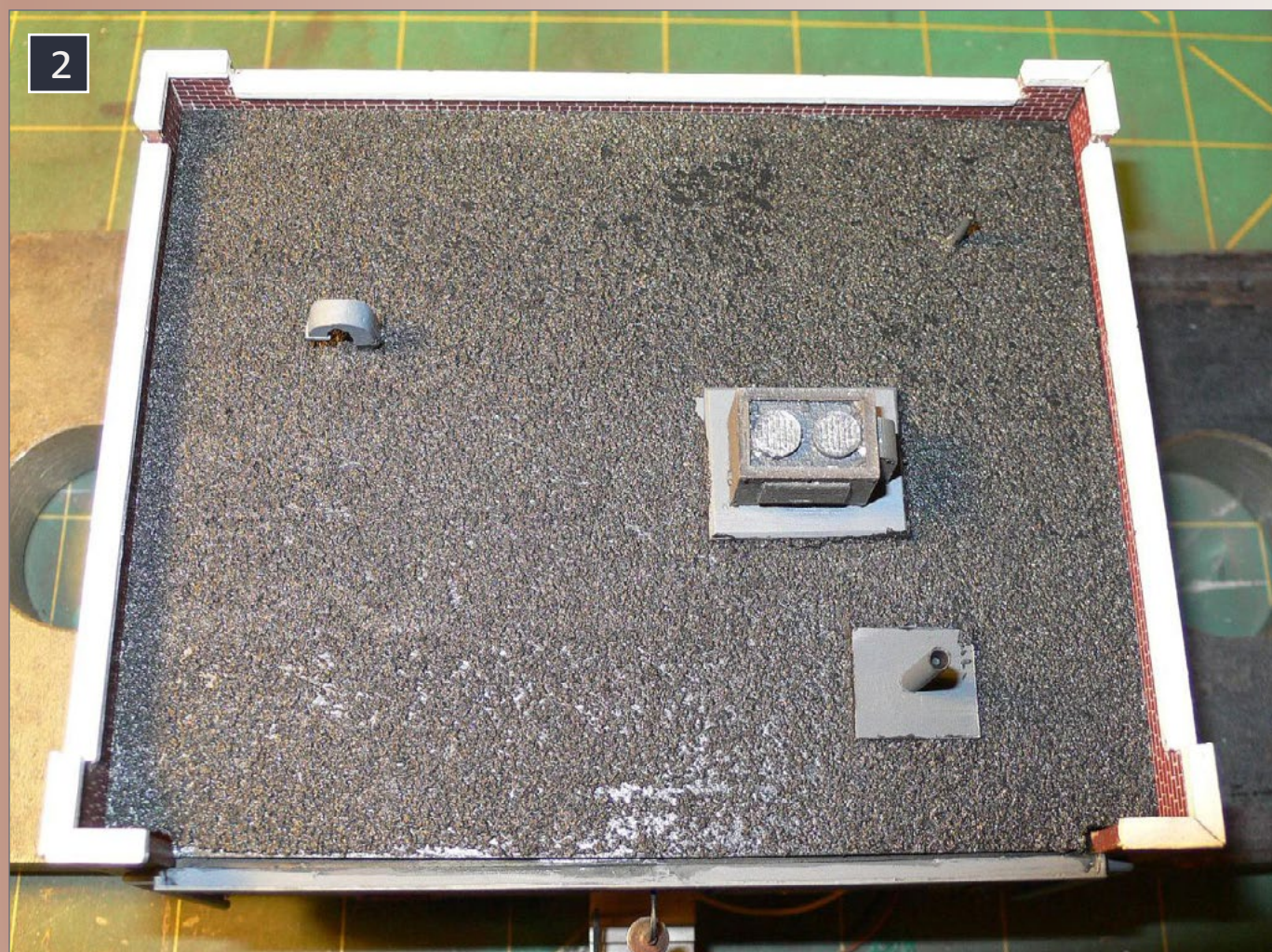

**2. Close up, ready for weathering.**



**3. Finished-weathered and detailed.**

lines, and removing the rear loading area and replacing it with a cinderblock wall. Also, the roof just didn't look right to me. It seemed to have too many vents for such a small building, and I wanted more of a "gritty", sand-like roof appearance.

I decided to fabricate a new roof out of .060 styrene. Using the original roof as a template, cutting the new roof was simple. I added a few vents and an air conditioner. Now, how to finish it? I have been reading a lot of military armor modeling sites, and these guys are way more advanced than I was in terms of painting, weathering, and special weathering effects. I decided to purchase several of the items I had seen used. For this project, I decided to try some of the Vallejo Earth Texture, as it has a nice, fine, gritty texture. It is a dark black color, and



I weathered it with some of the Vallejo and Secret Weapon washes.

I tried some on a scrap piece of styrene, to get a feel for how it applies. After painting the white styrene with some dark grayish automotive primer, I used a small trowel and spread a thin layer on the roof. It applies nicely- it can be worked easily and spread as desired over the roof. It dries relatively quickly to a very hard surface. I experimented with weathering the roof with several different items/techniques. I settled on the rust colored washes from Vallejo and the Concrete wash from Secret Weapon. Final touches were added with some Bragdon powders and a bit of AK Interactives Wet Effects Fluid. A discarded ladder, a hose, some boards, and a piece of "junk" finished the roof details.



4. Slightly different angle of finished roof.



5. Top down look at finished roof.

.Vallejo makes several other Earth Textures that may also be applicable – I have not tried others yet but suggest visiting the Vallejo website for more information and ideas. The Textures can be mixed with other Vallejo paints, washes, gels, etc. for a nearly endless variety of colors, textures, and effects.

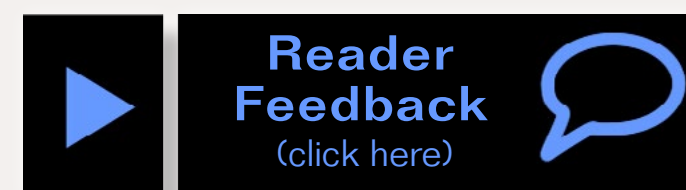

## Materials used:

- Automotive Primer
- Vallejo Black Lava Earth Texture, item 26.214
- Vallejo Model Wash- Rust, item 76.506
- Vallejo Model Wash, Dark Rust, Item 76.507
- Secret Weapon Wash, Concrete
- AK Interactive Wet Effects Fluid, item AK 079
- Various Bragdon weathering powders ■



Rob was a model railroader in his teens and got back into model railroading about 4 years ago with the start of his first “real” layout. Rob recently was modeling the Reading, which was his father’s favorite, but now he and his son Stephen are starting a new layout with a modern freelance theme, based loosely on the CSX and NS.

Rob especially enjoys structure building and scenery. Rob’s also looking at using C/MRI for the signals, lighting, sounds, on his new layout.

Rob works for GE Energy in the power transformer repair business. In addition to working for GE, Rob is a Lieutenant Colonel in the Pennsylvania Air National Guard, and has been deployed twice, once to Iraq and once to Afghanistan. Rob is 48, married, and has 3 children. Rob’s middle son, Stephen (15), is his partner in all things railroading.



# TONY'S TRAIN XCHANGE

Committed to your DCC support!

## CMX Cleaner Cars



Superior, All-Brass Build Quality, Super Easy To Use & Cleans Exceptionally Well!

N, HO, S, O, & G Scales

\$144.95 - \$259.95

[More Info](#)

## Athearn Genesis HO ES44AC GEVO & SD70M Flareside



GEVO - June Delivery  
SD70M - Fall Delivery

DCC Ready    DCC & Sound  
\$149.95    \$224.95

[Order Yours](#)

## Power Shield X Series Circuit Breakers



PSX1 through PSX4: Protects up to 4 DCC Power Districts!  
PSX-AR: integrated DCC circuit breaker and auto-reverser!

\$37.95 - \$134.95

[More Info](#)

### Do you need a Sound or DCC Installation done?

[Get a quote!](#)



Providing unmatched person to person DCC support for more than 20 years, the kind of service that has made us #1 in DCC.

DCC questions? CALL US! 1-800-978-3472

*We'll get you on the right track!*

June 2014



MRH-Jun 2014



# PICAXE CIRCUITS FOR MODEL RAILROADERS

## Part 1

– By Dave Bodnar  
Photos by the author



### Build a remote-controlled DC speed controller. Control animations or run DC trains, hands-off, through a pre-programmed route ...

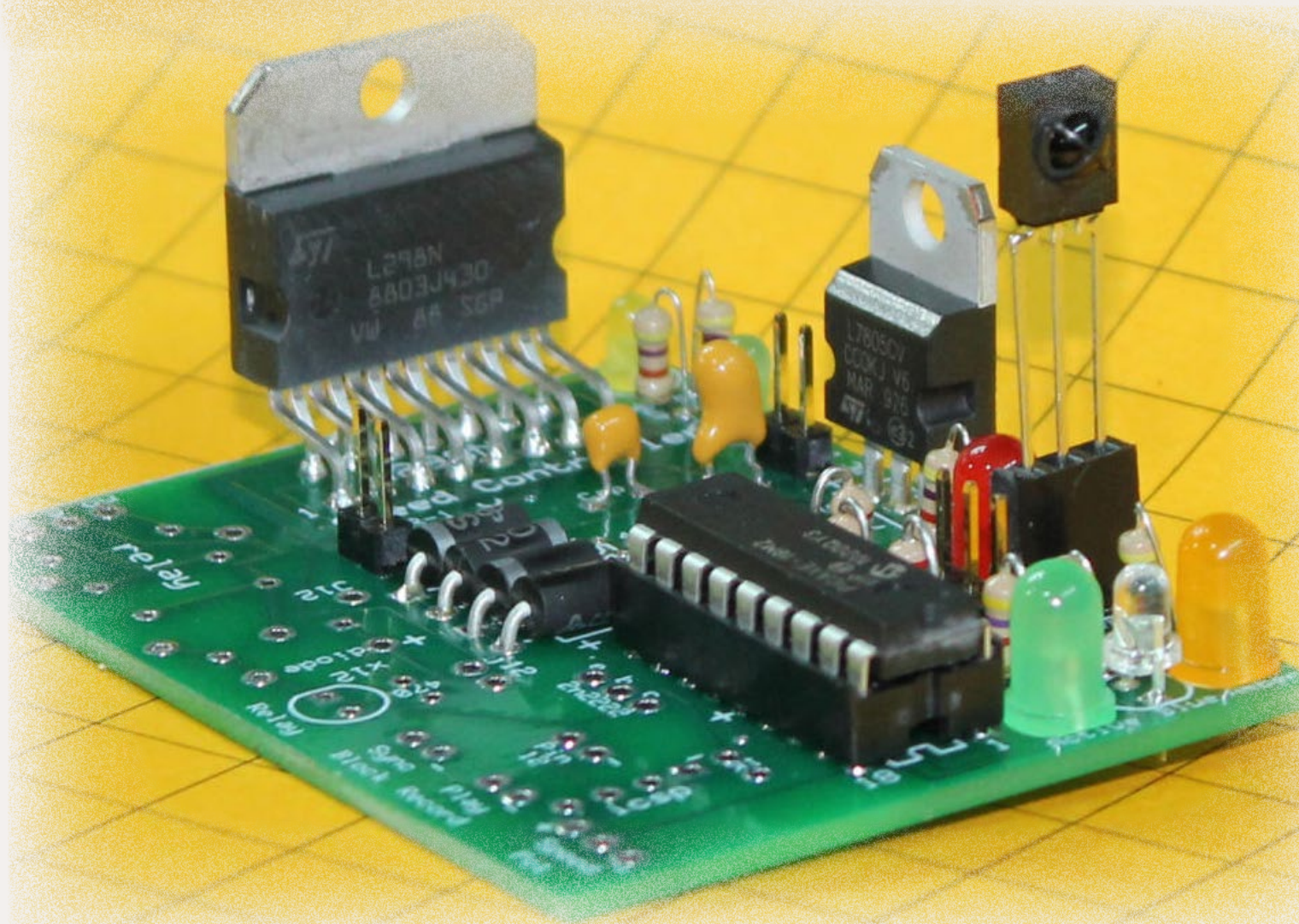

PICAXE circuit - 1

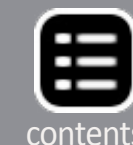

## PICAXE?

A PICAXE microcontroller chip was originally designed for students building simple electronic projects. The PICAXE system has now also been widely adopted by hundreds of thousands of hobbyists due to its ease of use. Each year thousands of high school students are introduced to electronics and microcontrollers by building a PICAXE project.

PICAXE chips are popular because they are very low-cost and simple to program using free, easy-to-learn software.

For model railroaders, PICAXE can be used to control and operate an endless array of things on the layout from simple animations to complex automated train display operation.

- See more at: [picaxe.com/What-is-PICAXE](http://picaxe.com/What-is-PICAXE). ■

Since 2004 I have been singing the praises of the PICAXE family of microcontrollers to fellow model railroaders through articles on my website ([trainelectronics.com](http://trainelectronics.com)) and through presentations at national and regional model railroad conventions.

I have long wanted to put together a complete kit that would allow beginners to start working with the PICAXE while building a useful model railroad accessory. The new PICAXE 18M2 chip inspired me to write this article and assemble the parts for the kit that accompanies it. The completed kit is a full-featured

model railroad speed controller with many innovations and interesting features and capabilities. The controller can be used for other projects as well, because it will work with any 3-volt to 35-volt DC motor.

## Controller

The unit is a trackside power controller that can operate any model train that runs on direct current (DC) and draws 3 amps or less (this includes most of our trains and trolleys). It is operated by means of a simple TV infrared remote control unit. In its most basic mode, the controller allows you to increase or decrease train speed and reverse the train's direction with the handheld TV remote. This is an ideal way to operate the train under the Christmas tree! In point-to-point mode, the controller can be programmed to automatically run the train in one direction for some time, decelerate it, come to a complete stop, reverse, and continue in the other direction. This makes it a perfect controller for a small work train or a trolley. I also have plans to use one for my incline railway and a cable car ([davebodnar.com/railway/incline/index.htm](http://davebodnar.com/railway/incline/index.htm)).

Additional modes and functionality can be added by modifying the PICAXE BASIC program to allow the controller to operate aboard a train or as a controller for animations.

Since it is able to control the speed and direction of any DC motor, it also can be used with any number of other projects including robotics, animation, and holiday exhibits.

## Endless possibilities

A second article will show how a few components can be added to this circuit to not only control the speed and direction of a train, but also to record a series of movements over many minutes and

play back the same sequence of moves over and over. This is a great way to add variety to demonstration or self-running train layouts. I plan on using this controller to operate the layout we maintain at the Children's Hospital of Pittsburgh. Rather than just having the trains run in a simple loop, the controller's recording will have the trains running, stopping, and reversing.

## Control options

One of the most difficult tasks one faces when designing a microcontroller-based device is creating a user interface that allows the operator to operate the unit with ease. Because the PICAXE 18M2 has the ability to interpret and act on codes sent from a TV remote control, the user interface can be both full-featured and easy to use. The remote shown in figure 2 is a Westinghouse unit that sends the Sony codes the PICAXE is programmed to interpret. Most Sony and multi-brand programmable remote controls will work. It is possible that some of the buttons will not match those shown here, but is it a simple matter to modify the program code to work with another remote control [2].

This TV remote control's buttons are used as follows:

- Channel Up – increase speed
- Channel Down – decrease speed
- Volume > or < – change direction
- Menu – stop, remembering speed, or start at the stored speed after a stop
- Return – enter configuration mode
- Number Keys 1-0 – enter configuration data while in configuration mode

## Using the Controller

The video below shows many of capabilities of the controller.



**2. Example Westinghouse brand remote that can send the Sony codes the PICAXE is programmed to interpret.**



**Playback problems? [Click to try a different version.](#)**

4

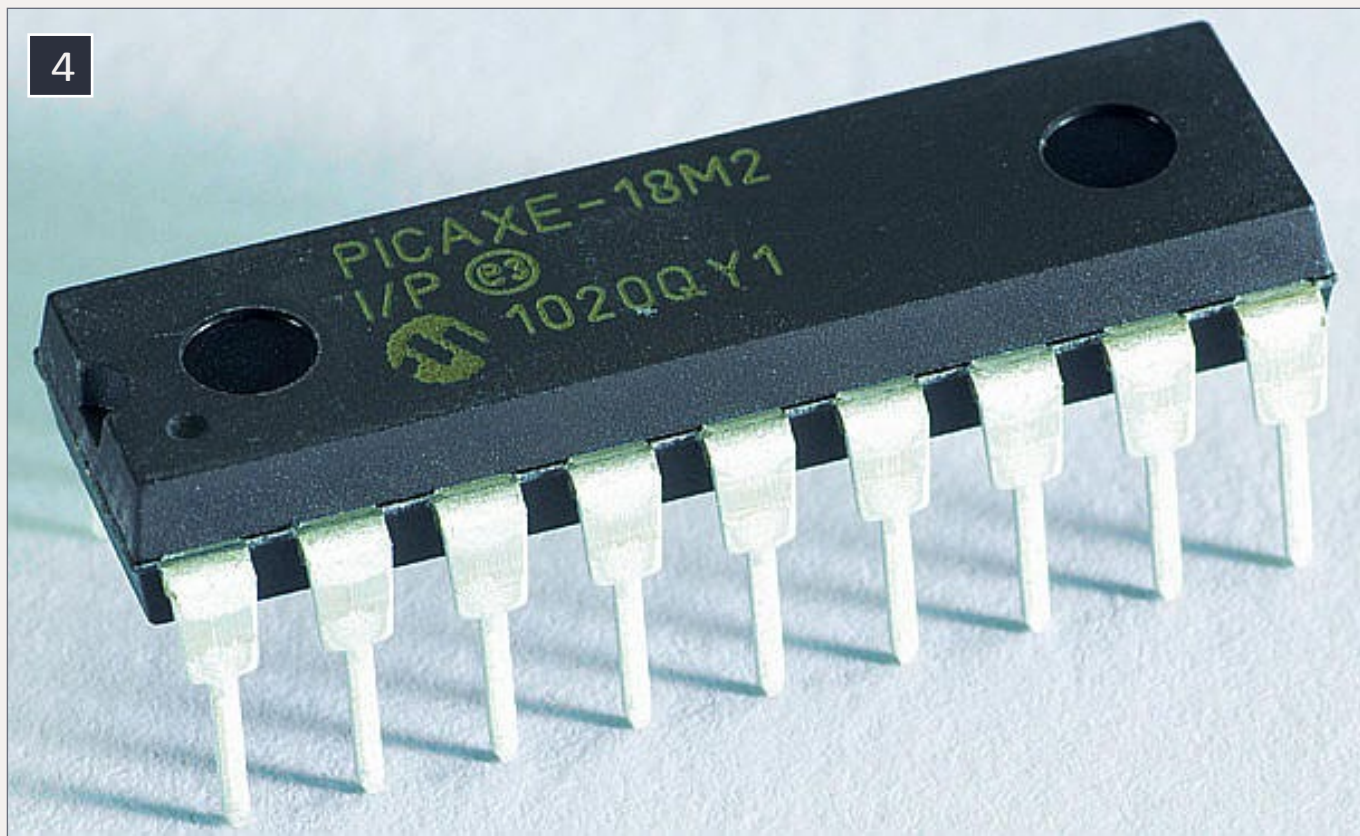

#### 4. The 18-pin PICAXE 18M2, the brains behind the controller.

### Hardware

A new member of the PICAXE family, the 18-pin 18M2 ([picaxe.com/docs/picaxe18m2.pdf](http://picaxe.com/docs/picaxe18m2.pdf)) controller, is an extremely capable chip that is well-suited to the demands of this project.

The 15-pin L298N H-bridge device is responsible for controlling the direction of travel and the speed of the train. It is called an “H-bridge” because such devices are frequently drawn on a schematic with four transistors in an “H” pattern [5].

I like to think of an H-bridge as a solid state double-pole double-throw switch. As you may know, a DPDT switch can be wired so that it delivers power to a train with one polarity in one position and with the opposite polarity in its other position. Reversing polarity reverses the motor’s rotation.

The infrared commands from the handheld remote control are received by a small chip, the Vishay TSOP4838 ([vishay.com/docs/82459/tsop48.pdf](http://vishay.com/docs/82459/tsop48.pdf)). Its small, boxy case and three leads belie its complexity. Inside is a sophisticated circuit that detects the 38 KHz infrared data stream from the TV remote control and filters it into a series of pulses that are interpreted by the PICAXE [6].

Other components include indicator LEDs, a voltage regulator, and assorted resistors, capacitors, and diodes. It is a straightforward circuit that works well with loads of up to 3 amps.

DC power is supplied by any filtered DC power supply providing 12-24 volts. I have had great success using old laptop computer power supplies for this and other projects. Be sure to use an appropriate heat sink on the L298N if current is likely to exceed 1 amp.

5



#### 5. The L298N H-bridge, the “brawn” of the PICAXE controller.

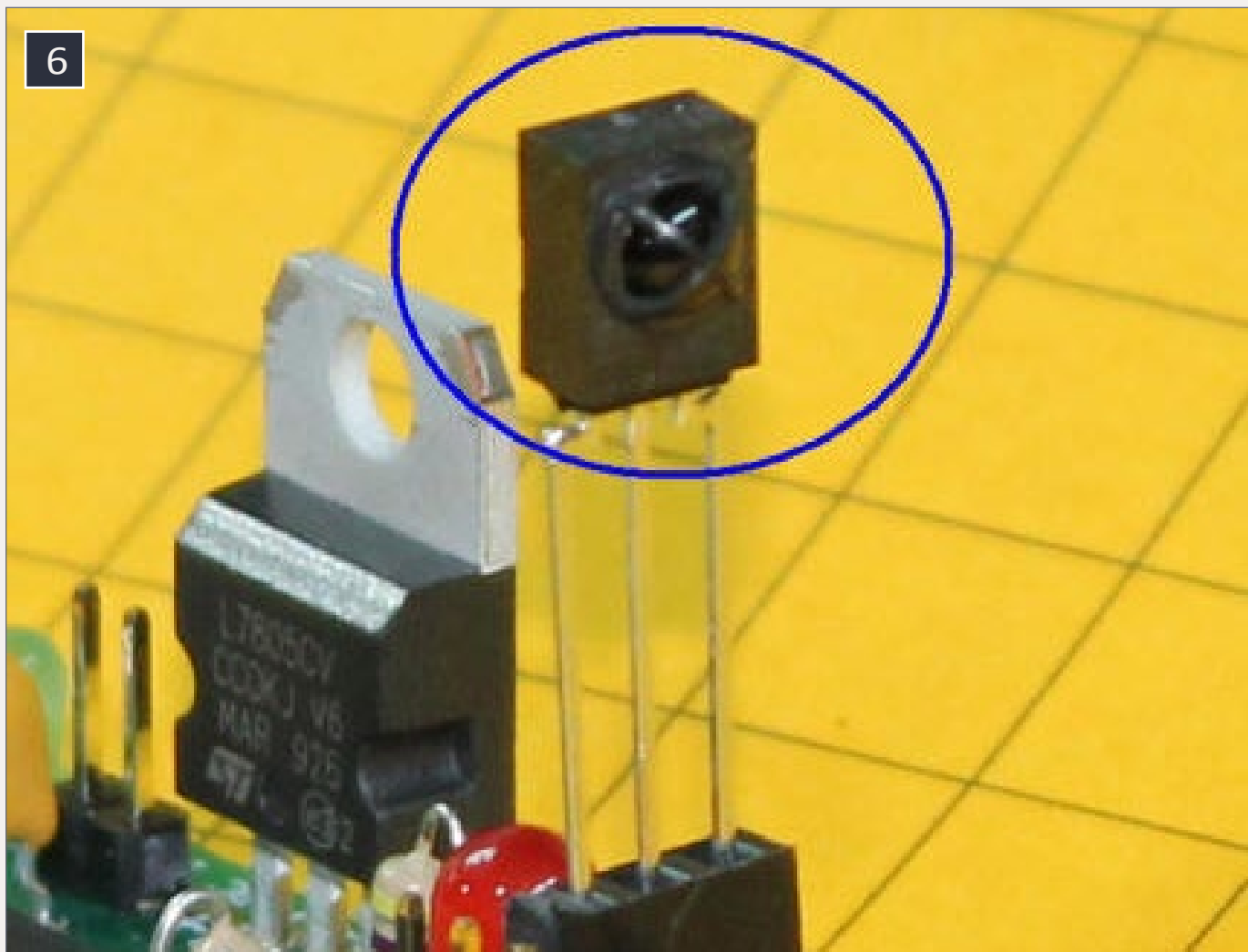

6

6. The small Vishay TSOP4838 chip receives the infrared codes.

### How it works

The PICAXE is programmed through pins 2 and 3, which are connected to the computer's serial port (or to a USB-to-serial adapter). Resistors R1 and R2 and a DB9 connector are all that are needed to connect your computer to the PICAXE for programming.

Infrared pulses are generated by pressing a key on the TV remote control. These are received by the IR receiver IC and sent to the PICAXE through pin 8.

... On to next page of text →

## So Many to Choose From . . . We Can Help You Select the Perfect Digital Sound Decoder!

Use our online Decoder Selector to find the right Tsunami for your models. We also include links to our application notes, such as one for installing a **TSU-GN1000 into an Atlas® HO RS-3.**



[Visit Our Decoder Selector Here](#)

SOUNDTRAXX®



**RailPro™**

**NEW TECHNOLOGY**

DIRECT™ RADIO

**RE RING™**  
ENGINEERING

**NEW Starter Kit**  
**\$399.99 MSRP**

- Includes Wireless Color Touch Screen Handheld Controller and 56 Watt Power Supply
- Expandable to Virtually any Size Layout

**NEW Locomotive Module**  
LM-2 & LM-2S

- Direct Radio RF
- Sound and Non-Sound
- New Tiny Size
- 6 Light Outputs

[Click Here to Learn More](#)

For more information visit our Internet site: [www.RingEngineering.com](http://www.RingEngineering.com)







[← back to previous page of text ...](#)

All power control is performed by pins 6, 11, and 9 on the PICAXE. These pins control the output of the L298N H-bridge. The L298N is designed to operate two separate motors, each drawing up to 2 amps. In this application we are controlling only one motor, so its control and output pins have been wired in parallel, to supply up to 3 amps of current to the motor.

When the PICAXE's pin 6 is at +5V (known as "high") and pin 11 is at 0V (known as "low"), the motor will rotate in one direction. When pin 6 is low and pin 11 is high, it rotates in the opposite direction. LEDs D2 and D4 light to show you which direction the L298N is set to.

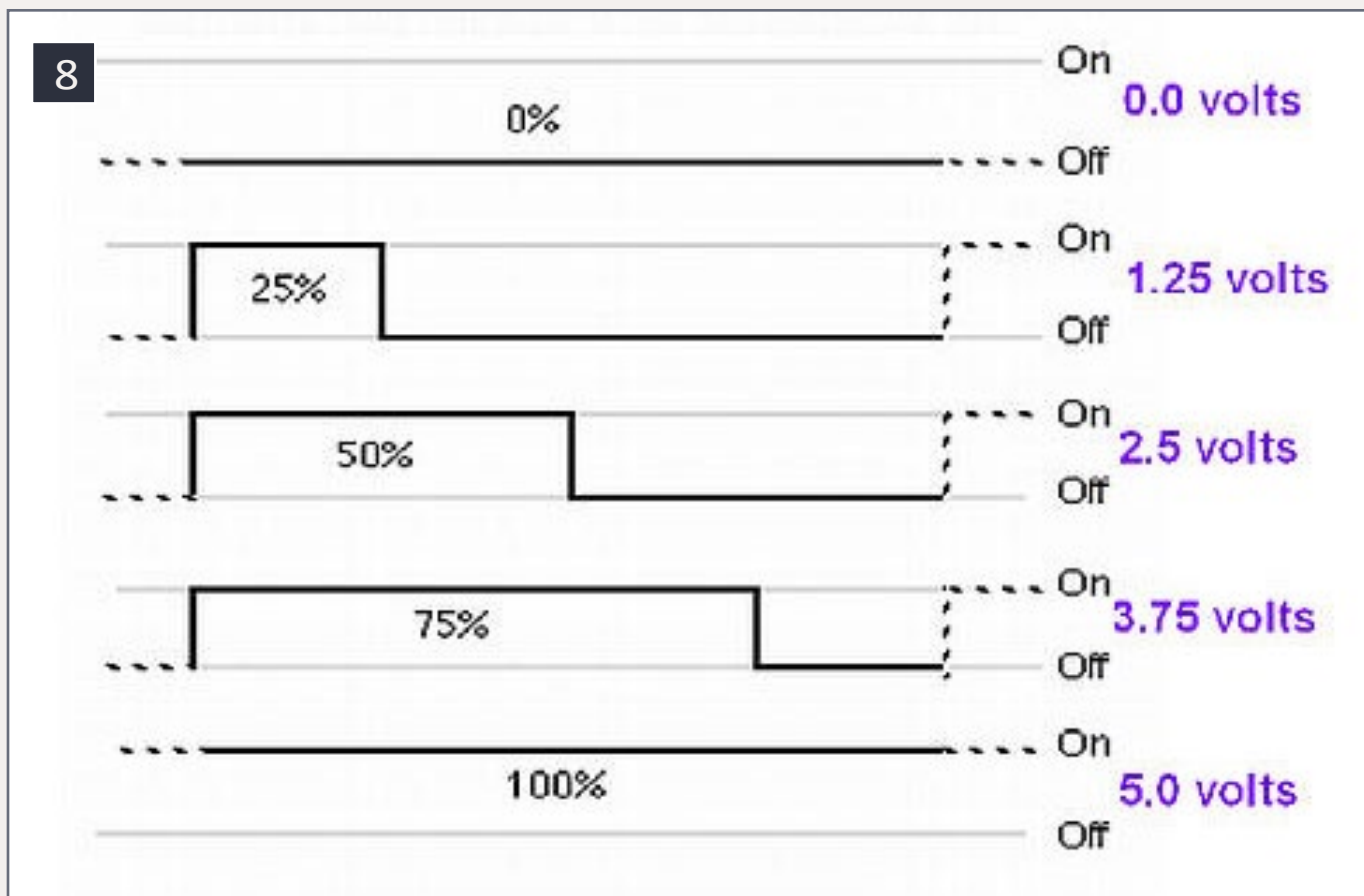

**8. How the PICAXE pulse width modulation (PWM) pulses simulate variable voltage.**

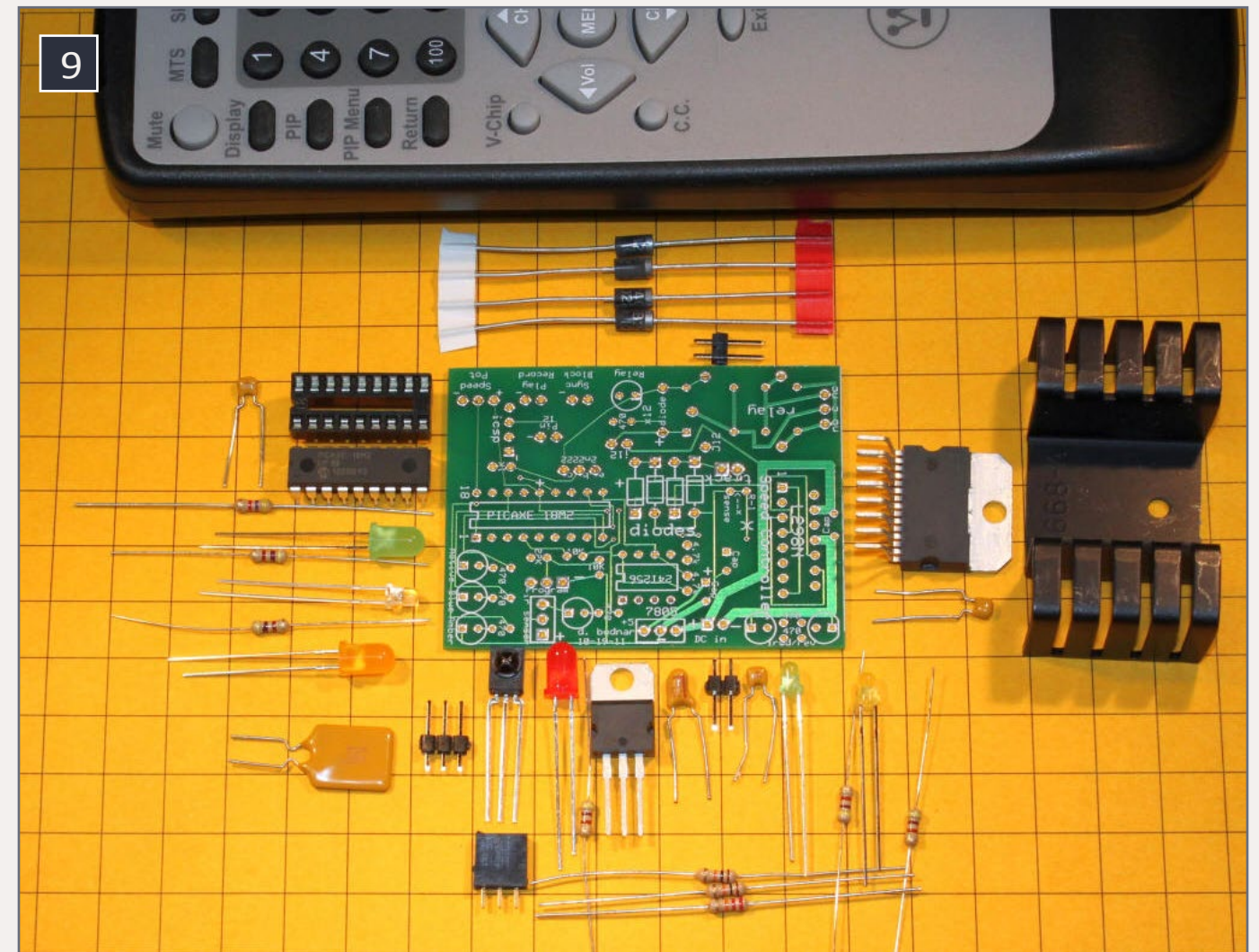

**9. The parts arranged near their locations on the circuit board.**

The H-bridge spins the motor at full speed when it receives +5V ("high"), and stops it when it received 0V ("low").

But what about intermediate speeds? We don't want our locos running at full speed all the time! Microprocessors generally can't produce variable (analog) voltages, so they use "pulse width modulation" or "PWM" to achieve variable speeds. PWM sends a series of 5V pulses to simulate a variable voltage. For example, if the pulses are on half the time and off half the time, the pin appears to have half of the supply voltage, or 2.5V on it. Pulses that are on 25% of the time and off 75% of the time look like 1.25V, and so on. See [8]. (This is exactly how DCC decoders vary motor speed.)

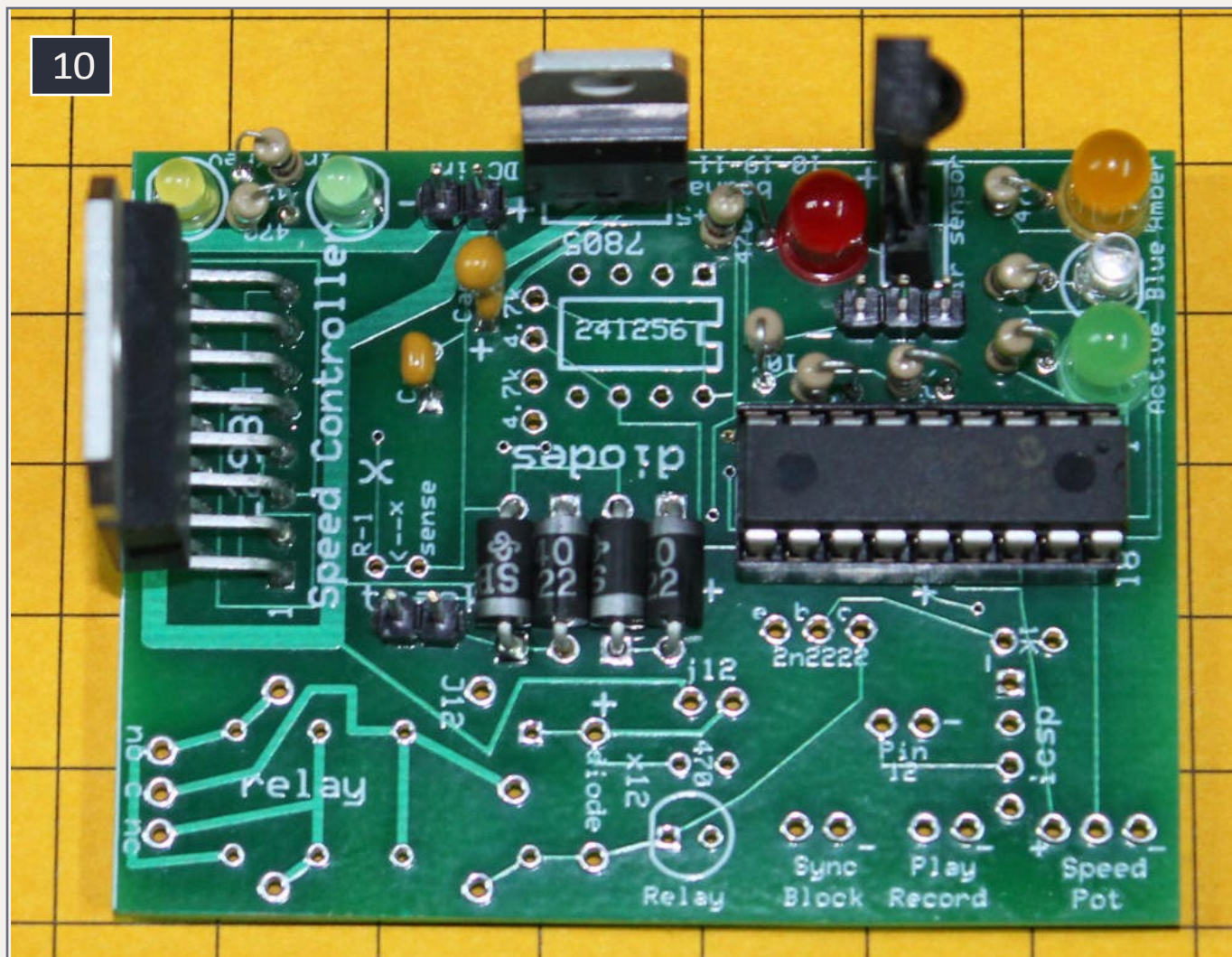

10

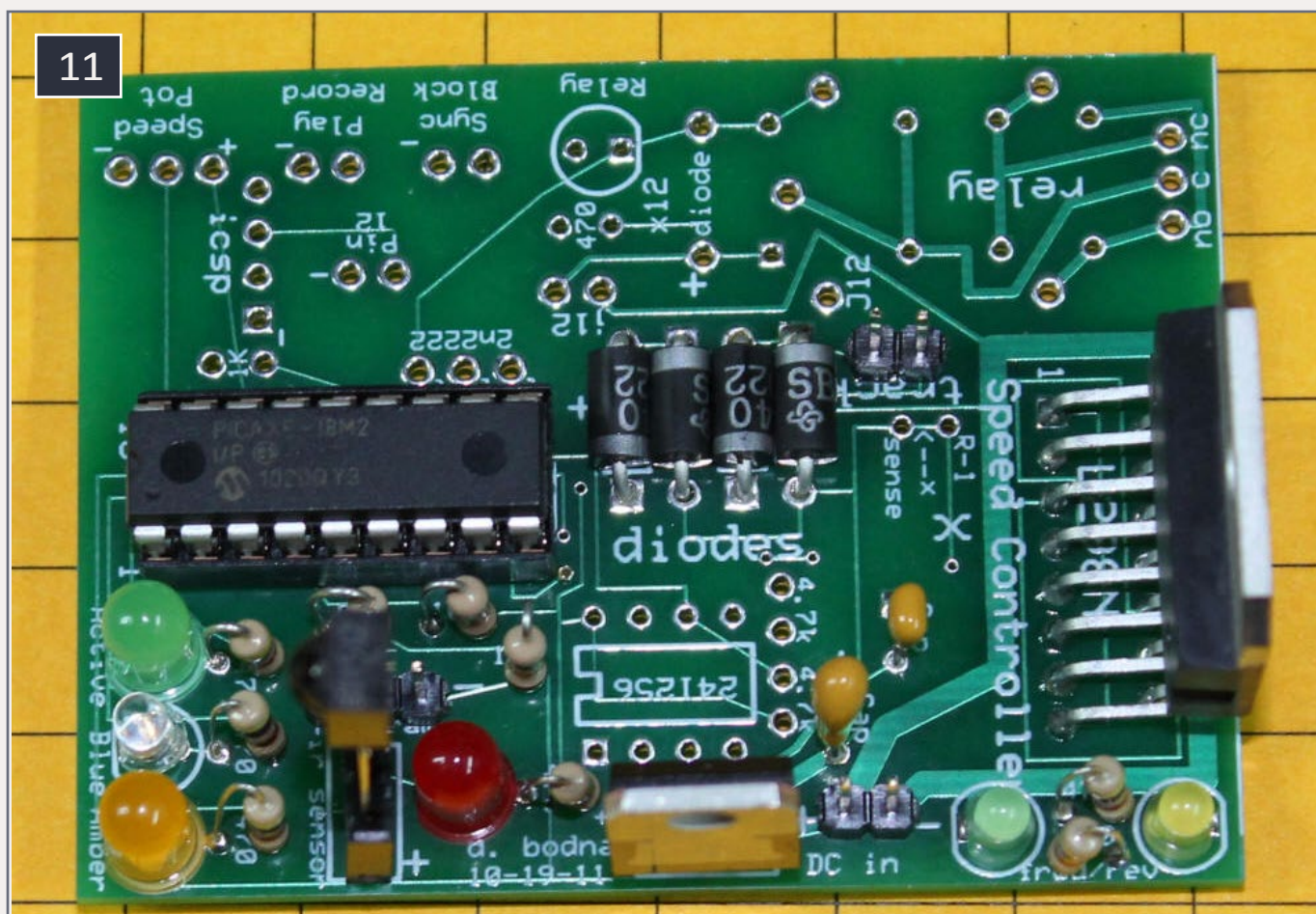

11

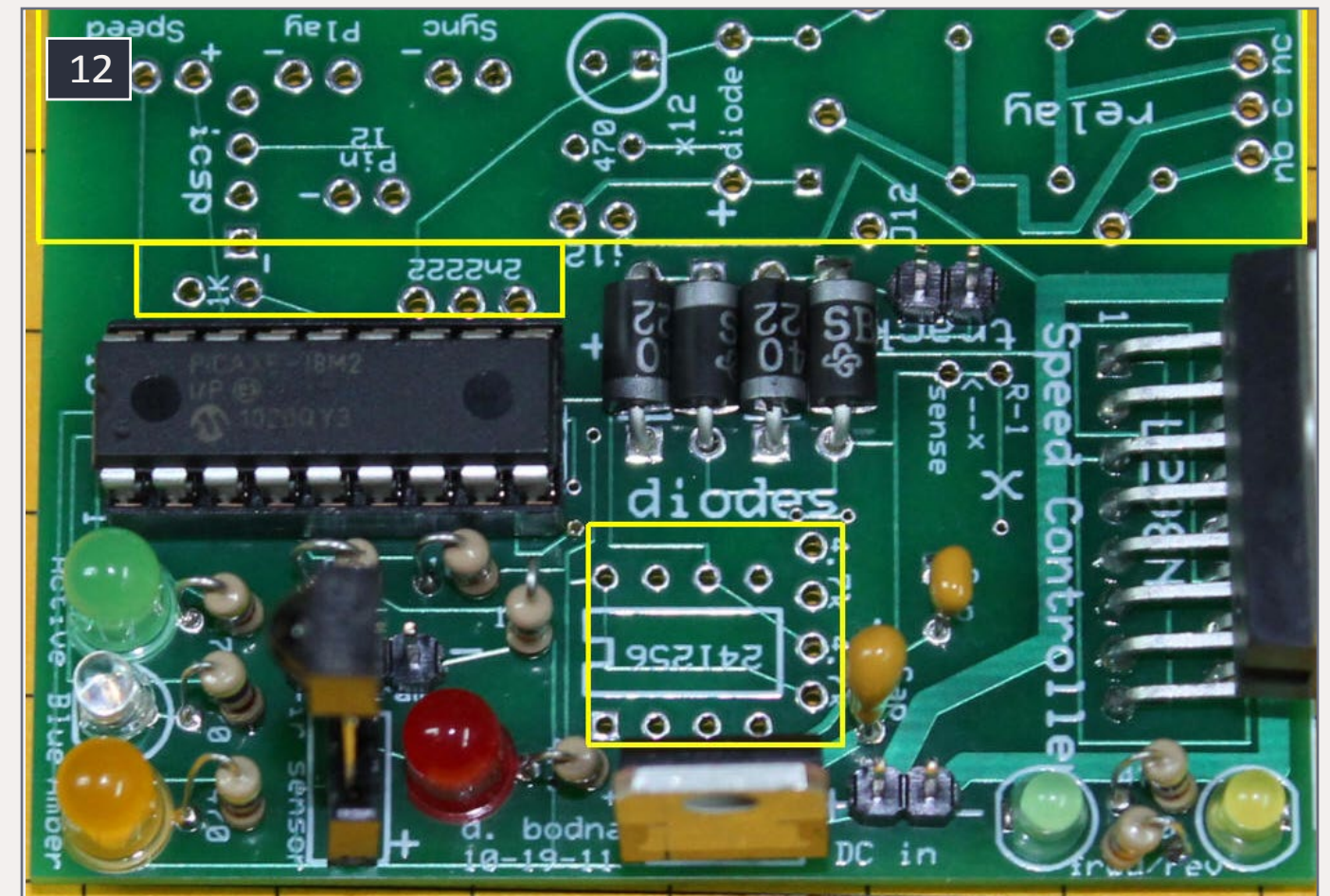

12

## Vacant areas on the board

You may be wondering about the unused areas on the board, those shown boxed in yellow above. These areas are for additional components used in the next phase of this project, where the controller is used to record and play back a train's movements. They will be installed and fully described in part 2. Stay tuned!

For detailed instructions on building, testing, and programming this circuit for the kit I sell, see my website at: [trainelectronics.com/PicaxeSpeedController/article.htm](http://trainelectronics.com/PicaxeSpeedController/article.htm).

In part 2, I look at how to do still more with PICAXE circuits for model railroaders.

10-11. The completed board.

12. Unused areas of the PICAXE controller board are marked in yellow.

## Parts list and kit availability

The parts used to build the controller include:

- PICAXE 18M2
- 18 pin socket
- circuit board
- L298N H-bridge
- 7805 voltage regulator
- 4 @ 2 amp Schottky diodes or 1N4001 silicon diodes
- 3 @ 0.1 mfd bypass capacitors
- 4.7 mf tantalum capacitor
- 3 @ 5mm LEDs, red, green, amber
- 3 @ 3mm LEDs, blue, green, amber
- 6 @ 470 ohm resistors
- 10K resistor
- 22K resistor
- Vishay TSOP4838 infrared receiver
- 3 pin header for programming
- 2 @ 2 pin headers for power to track and DC power in
- heat sink for L298N
- fuse or poly fuse - 3 amps - either in the power supply or added between the power supply and circuit board
- TV remote control that can generate Sony codes ■



## Kit available from the author

I sell a kit that contains all the parts shown in the article. Just email [dave@davebodnar.com](mailto:dave@davebodnar.com). All you need is a power supply and a motor to control. The cost of the kit is \$65 + shipping. I can also supply a wired and tested unit, but I hope most readers will enjoy the experience of building the kit themselves. ✓



Dave Bodnar's interest in microcontrollers, electronics and computers fits beautifully into model railroading and allows him to solve his and clients' model railroad challenges.

Dave has three railroads. The first is in the back yard, traversing more than 200 feet of track over two bridges, through tunnels and past a garden pond. The second railroad is an HO module he sets up at various train

and community events with other members of the South Hills Model Railroad Club. His third railroad is one built by Dave and other members of the Pittsburgh Garden Railway Society at Pittsburgh's Children's Hospital.

His website, [trainelectronics.com](http://trainelectronics.com), contains scores of articles on his various projects. Many of his presentations are also on YouTube.

When he is not in his workshop, you will usually find him on his road bike traversing the back roads in Western Pennsylvania.

# END OF TRAIN DEVICE

FLASH CIRCUIT UNDER TRUCK

TRACK POWERED



READY TO RUN!

**Bright Red Flashing Light!**

Installs in minutes with no freight car modification required!

**RE RING ENGINEERING**

Patented Technology - US Patent 7,549,609

**Does not affect Load!**

↓ Car without Load ↓

↓ Car with Load ↓



For video and more click here!



**IOWA SCALED ENGINEERING**

## MR Servo Slow Motion Turnout Controller

- Features **PowerFrog** technology
- Low profile
- Short-proof power routing
- No calibration required

[LEARN MORE >](#)



## RR-CirKits

SignalMan, TowerMan, WatchMan and simple serial bus for signaling

by the MRH Staff

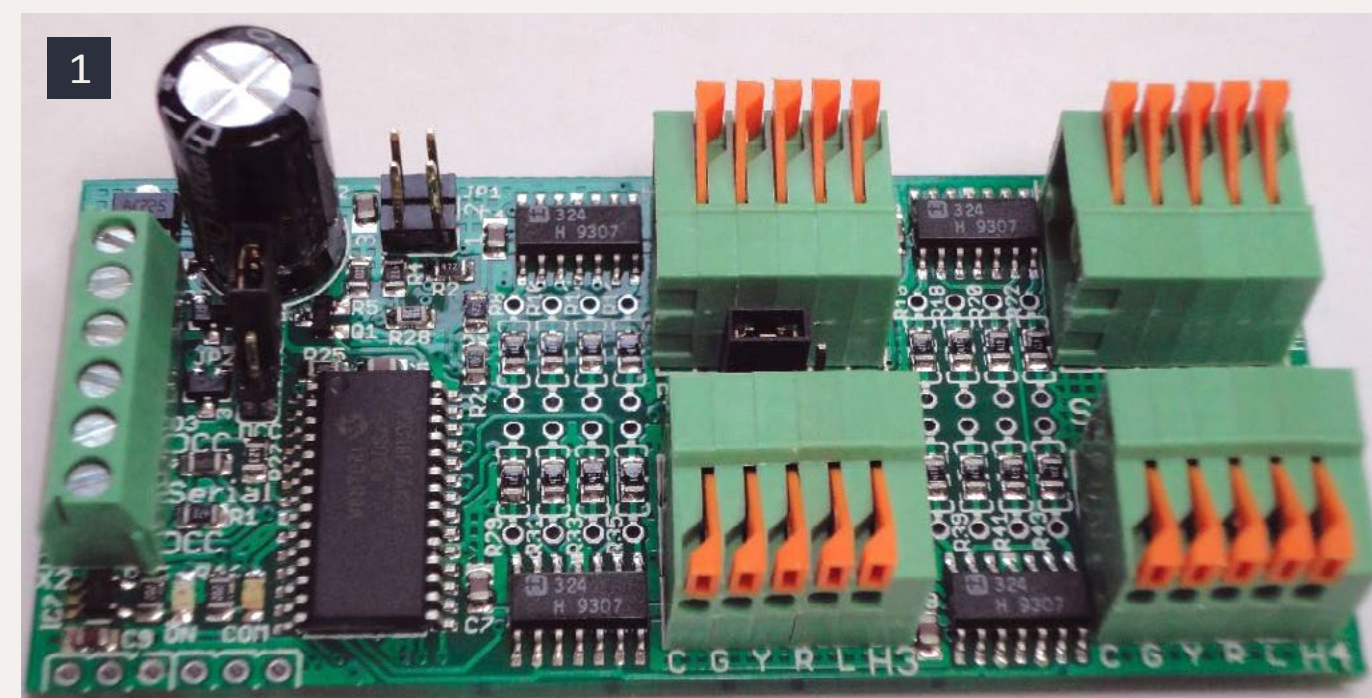
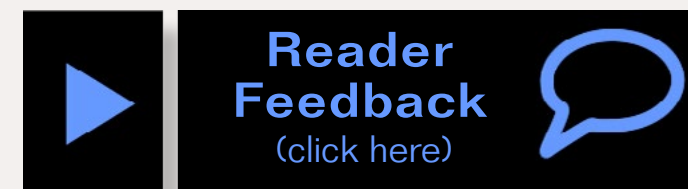

1: SignalMan C (compression connectors version).

In 2011, RR-CirKits ([rr-cirkits.com](http://rr-cirkits.com)) introduced a line of electronic circuit boards that bring prototypical signaling within the reach of even those on a tight budget. The boards can connect to trackside signals, occupancy detectors, and slow-motion switch motors on your model railroad. They communicate with each other using RR-CirKit's three-wire "Simple Serial Bus" (SSB).

Like DCC decoders, the three main boards contain CVs (configuration variable registers) to set many operating characteristics. The boards can connect to a computer through a couple of

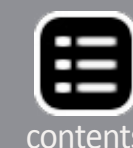

interface boards, or use the Digitrax LocoNet<sup>®</sup> serial interface. With this connection, they can be programmed with the free JMRI Decoder Pro software ([jmri.org](http://jmri.org)).

The product line includes these main boards:

**SignalMan** lets you control trackside signals. The board contains programmable “logic blocks” that perform operations based on current operational conditions (e.g., IF this occurs OR that occurs, THEN DO something). Without this internal logic, you would need to program PC software like JMRI Decoder Pro to perform the same operations.

You can setup and configure SignalMan for special lighting effects such as lamp fade, flashing lamps, searchlight red flicker, or intermediate colors between aspects (see sidebar at the end of this article for more). This board can drive up to 16 LEDs.

**TowerMan** provides a simple and easy way to connect between a LocoNet<sup>®</sup> bus and the layout. The TowerMan may be connected at any convenient point on the Simple Serial Bus, and can be used as a hub to connect to occupancy detectors, switch

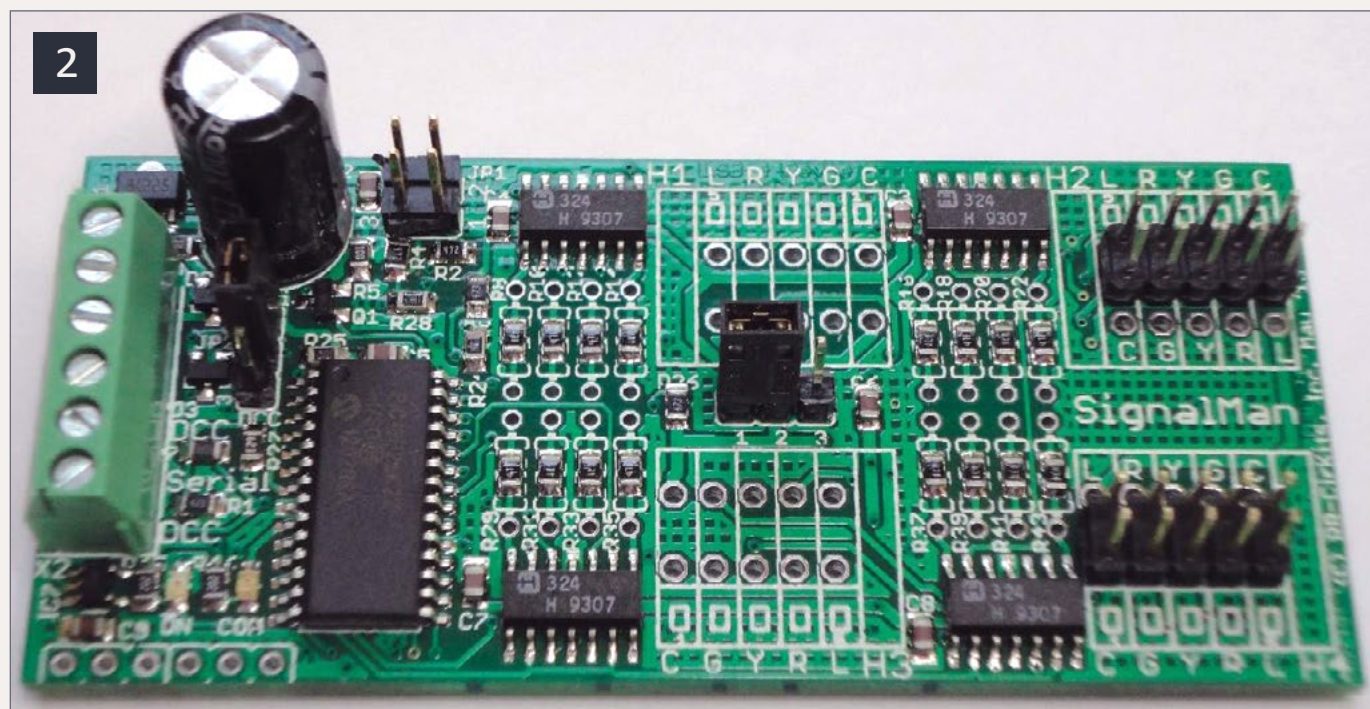

2: SignalMan P (10-pin connectors).

motor driver boards, and signal driver boards. The TowerMan can also drive signals directly with dropping resistors.

This board has 16 input/output lines that can be configured as either inputs or outputs depending on the device. Like the

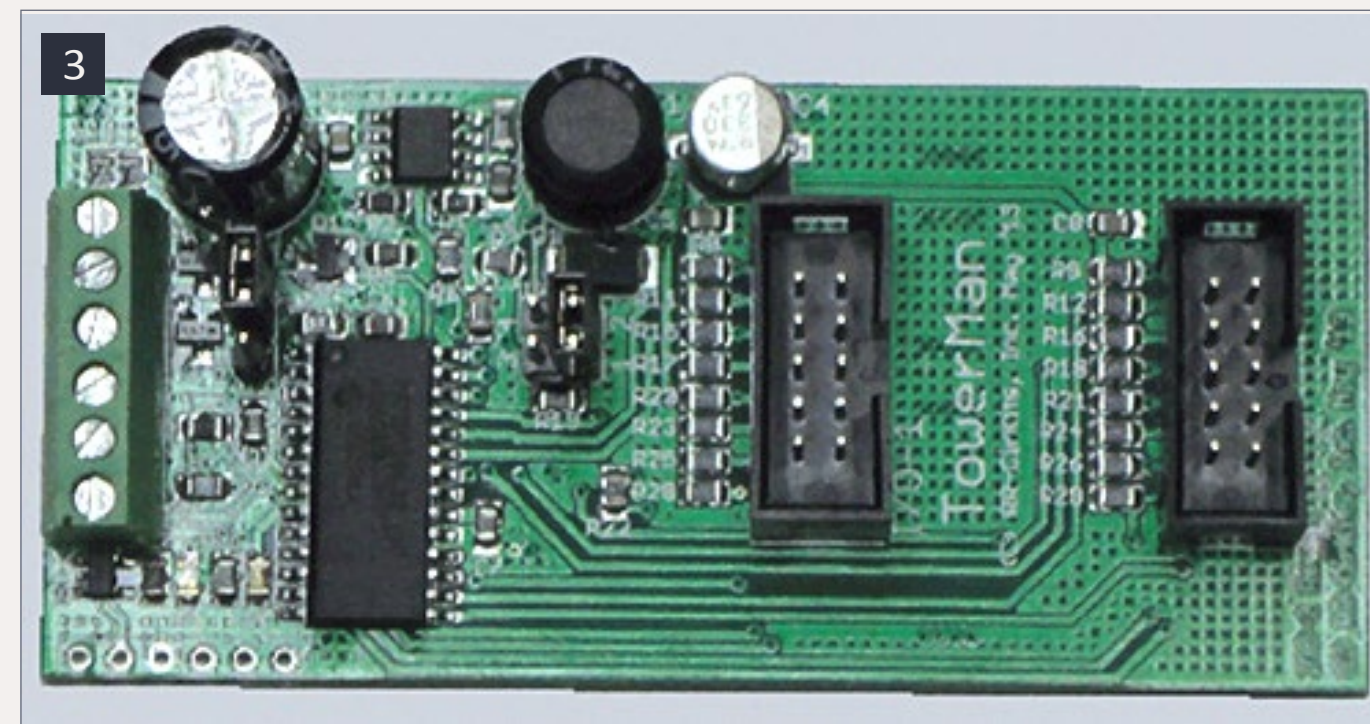

3: TowerMan (16-input or output lines).



4: Simple Serial Bus Gateway.

SignalMan, it contains programmable logic blocks to perform complex operations.

**WatchMan** contains eight DCC current-sense occupancy detectors (you supply the coils). This board also has eight auxiliary input/output lines that can be used for signals or switch motors. It contains programmable logic blocks to permit performing complex operations. The optional Fan-out board (FOB) can expand this board's input/output capability.

## Experience using these boards

Using only a basic package, Jim Duncan (MRH staff) got a system up and running with working signals in just a few hours. The biggest problem Jim encountered was learning how to set up the NMRA signal aspects in the boards' internal logic.

Once that was mastered, Jim found creating new "decoder files" (for the CVs) was quick and easy.

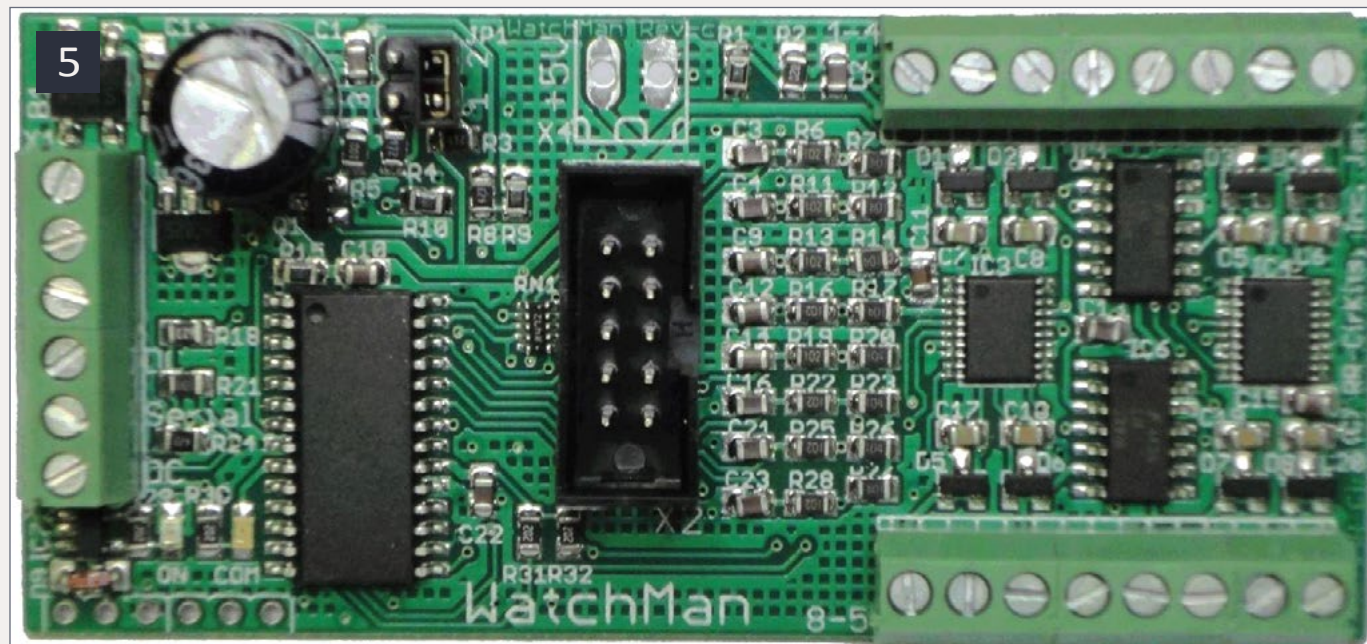

5: WatchMan.

Following this initial work, Jim rolled out a new CTC system on a live steam railroad in Missouri in short order.

Jim did find setting up a signaling system can be intimidating at first. RR-CirKits has downloadable user manuals for its products at [rr-cirkits.com/manuals](http://rr-cirkits.com/manuals) that help immensely.

These manuals include examples of setting up signal aspects, and one manual has an extensive section on setting up an Absolute Permissive Block (APB) system which requires *no* human intervention. In short, once the boards are programmed, they no longer need to be connected to a computer to handle the logic and communications.

The manuals include wiring diagrams and highly-detailed information, but it is not necessary to know or understand the technical aspects in order to successfully program and use these products.

Jim Duncan found RR-CirKits support to be exceptional. You can pick up the phone and talk directly with Dick Bronson or Doug Goff for help or troubleshooting.

Advertisement

**RR-CirKits, Inc.**  
Affordable Electronics for Model Railroads

- Computer Interface
- Signaling
- General I/O
- Block Detection



**TowerMan**



16 I/Os! [Learn More ...](#)

### Prices:

- SignalMan C (compression connector) – \$29.95
- SignalMan P (10-pin headers) – \$26.95
- Tower Man – \$33.95
- Fan-Out Board A – \$12.95
- Simple Serial Bus – \$34.00
- LocoBuffer USB – \$65.00

*Also see the sidebar on the next page ...*



## SIGNALMAN LIGHTING FEATURES

One of the unique features of the SignalMan and its near relative, the LocoNet Control Point (LNCP), is the ability to set up special lighting effects using LEDs. Four options are available: Fade, H2 Flicker, Tumble Down, and Strobe. A fifth special effect (off) simply gives LEDs a basic on/off mode. Default for all effects is off.

**Fade:** Allows LEDs to mimic the appearance of a prototypical signal lamp with both a fade-up during turn on and a gradual decrease in brightness while transitioning from on to off.

**H2 Flicker:** Emulates a searchlight signal's unique red flash during transition. US&S H-series searchlight signals include a color vane which rocks back and forth in front of the lamp mechanism. The red lens is located in the center position between the green and yellow lenses. When observing a searchlight changing between green and yellow, there is a brief flicker of red as the lens vane rocks between those two colors. This effect is especially noticeable at night.

Configuration of multiple heads on the same mast using the H2 Flicker is also possible.

**Tumble Down:** This mimics the motion of a semaphore arm moving from a permissive indication to stop, a unique feature found in B&O color position light and Pennsy position light signals. Combined with the fade effect, this can be particularly effective in establishing a prototypic signal appearance.

**Strobe:** Not only can the ports on these boards be used to drive lineside signals, they can be used for special lighting effects of scenic items such as lights on a radio tower, emergency vehicle, or simply as an attention-getting device on the fascia of your railroad. The strobe speed and length can be set in the decoder programming.

Jim Duncan used the strobe lighting feature on the live steam railroad project to bring attention to the employee call lamp on the side of a building at a control point. ■

## Servo control with just a touch

Touch controls for Tam Valley gear too!

- Elegant Touch Toggle™ controls
- All plug-in system
- No drilling
- Flexible installation
- Tailored operation

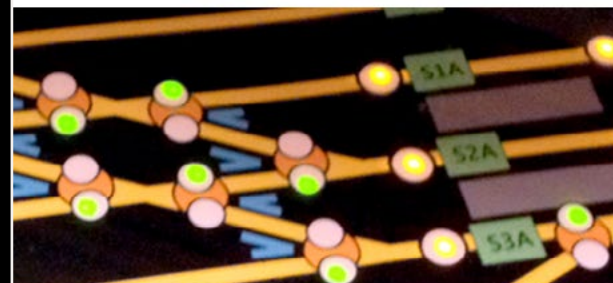

What will they think of next?

[www.berrethillshop.com](http://www.berrethillshop.com)



Make LocoNet wiring extremely simple!



"... great time saver as well as providing flexibility to change things ..." - Terry Nathan



PM42  
breakout  
board



BDL168  
Multi-zone  
breakout board



SE8C  
breakout  
board



BDL168  
Single-zone  
breakout board



<http://www.acculites.com>

CLICK TO LEARN MORE ...





New Clinics are being added daily!!  
Check the website for all the latest news!!

## 34th National Narrow Gauge Convention September 3rd-6th, 2014

### Goin' to Kansas City

Come and enjoy the sites and sounds of Kansas City and our fantastic Narrow Gauge community. See what we have to offer and get the creative juices flowing - all while enjoying great food, great people and a great city.

We will have:

- Over 400 Vendor and Manufacturer Tables
- Exciting new Clinics and Clinicians
- 60,000 square foot state-of-the-art convention hall
- Hotel and Convention Center in one location
- Dozens of layouts on the Layout Tour
- Free Wi-fi for all Convention Attendees

**CLICK HERE**  
[www.34thnngc.com](http://www.34thnngc.com)

### GREAT AREA ATTRACTIONS

Union Station, Truman Library, Steam Ship Museum, Power and Light District, the Country Club Plaza and GREAT BBQ are just a few of the things that KC is known for.

### REGISTRATION

Attendees can REGISTER ONLINE at [www.34thnngc.com](http://www.34thnngc.com)  
Registration: \$99 (\$114 after June 1, 2014)  
Email: [registrar@34thnngc.com](mailto:registrar@34thnngc.com)  
Address: 34th NNGC  
14633 S. Chalet Dr.  
Olathe, KS 66062

### EXCITING NEW CONTEST CATEGORY

In addition to all the contest categories that you are used to, there will be a special contest category:  
**- THE SQUARE FOOTER -**  
Build anything you want as long as it fits on a 12" x 12" display

### CONVENTION HOTEL

Rooms are filling fast...  
Check the website for current hotel availability.

**We want to see you in KC!!**

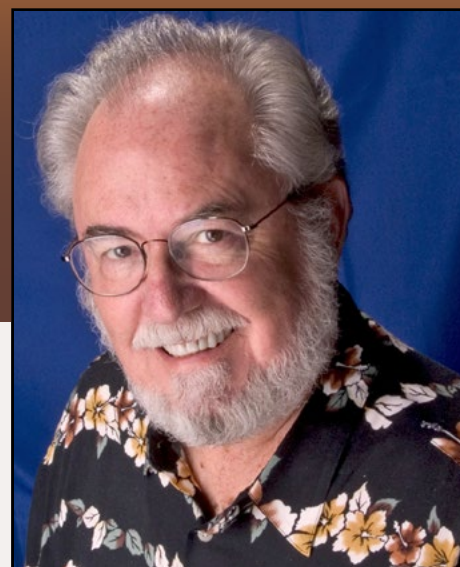
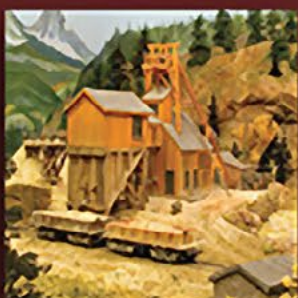
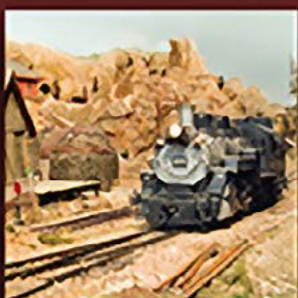
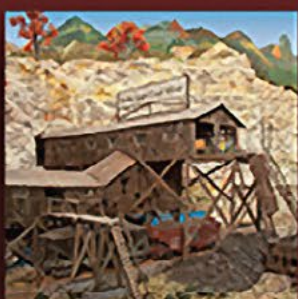
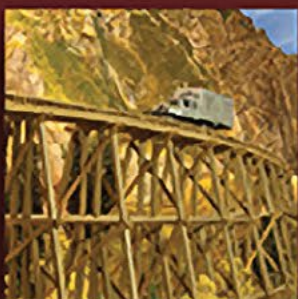

*The Old  
Yardmaster*



## June 2014: The latest model railroad products, news & events

by Richard Bale and Jeff Shultz

### Paul B. Scoles III, MMR 1943-2014

Paul Scoles passed away May 9 from complications following surgery. Paul was widely recognized in the model railroad community as one of the most creative scenery modelers in the hobby. He pursued model railroading as an art form and shared his philosophy and creative skills in numerous clinics, videos, books, and in more than 70 published articles.



Paul was generous with his time and welcomed visitors to view and operate his incomparable Sn3 Pelican Bay Railway & Navigation Company layout in the basement of his home near Seattle WA. Paul's wife Cynthia, plans to keep her husband's layout available to his local operating group.



A native of Lima OH, Paul earned his bachelors degree at Arizona State and a masters degree in philosophy at Northern Arizona University. He operated Ironwood Studio, a full-service recording studio with a list of clients that ranged from the Seattle Symphony to emerging garage bands.

Paul served his country as a combat infantryman with two tours of duty in Vietnam. In addition to several unit decorations, Paul returned from the war with personal awards including two Silver Stars, a Bronze Star with "V" device, two Purple Heart Medals, Republic of Vietnam Gallantry Cross Medal with Palm device, and Republic of Vietnam Campaign Medal with "60-" device. Paul suffered from painful shrapnel wounds in his legs throughout his life.

In addition to his wife Cynthia, Paul is survived by a son Eric, and two grandchildren. ...

## TSI acquires The Great Train Expo

The Great Train Expo has been acquired by Train Show Inc (TSI). TSI is the parent company of The Great Midwest Train Show, World's Greatest Hobby on Tour, and Greenberg's Train and Toy Show. The announcement was made by TSI president Randy Bachmann who also owns Hobby Show Promotions which took over management of the annual iHobby Expo in 2013. Bachmann said they plan to sponsor shows in many of the venues formerly used by Great Train Expo, adding, "The purchase allows us to produce events from coast to coast and provides the opportunity to improve all our shows." A revised show schedule is expected to be posted at [www.trainshow.com](http://www.trainshow.com) in the coming weeks. ...

## Horizon Hobby/Athearn

Horizon Hobby/Athearn has posted career opportunities for experienced model railroaders with specialized professional skills interested in turning their avocation into their vocation.

The company is interested in hobbyists with experience in marketing, product development, creative design, and customer service. The positions currently open for consideration are Athearn brand manager, customer service representative, product developer, product development manager, and a graphic artist. For a detailed list of career opportunities visit [horizonhobbycorp.com/careers](http://horizonhobbycorp.com/careers). ...

## CAR CLUB OFFERINGS



The NMRA's Northern Utah Division ([northernutahnmra.org/club-car](http://northernutahnmra.org/club-car)) is raising money through the sale of two unique HO scale car kits. The first is a 40' double-sheathed wood boxcar decorated for Salt Lake, Garfield & Western with a bold Saltair slogan. The color scheme of the car is based on SLG&W passenger equipment in use in the 1940s and '50s.



The second kit is for a USRA twin-bay hopper decorated for the Tooele Valley Railway. Both kits are manufactured by Accurail and include trucks and couplers. Visit the above website for pricing and ordering information.



Three custom cars are available now from the **Torrington Area Model Railroaders** ([ct-tmrr.org/clubcars.htm](http://ct-tmrr.org/clubcars.htm)) of Torrington CT. The HO scale ready-

to-run cars include a 50' Conrail X71 boxcar with one door painted green. The door on the opposite side of the unique car is the same color as the car body. The model is available at \$30.00 each.



The second and third cars are Guilford/D&H Trainman PS-2 covered hoppers. One has a Guilford G

(above) and the other a D&H shield. The covered hoppers are priced at \$25.00 each. The PS-2 cars were produced for the club by Atlas. Visit the above website for ordering information.

## NEW PRODUCTS FOR ALL SCALES

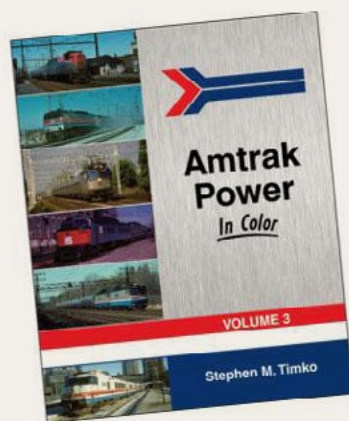

“Amtrak Power, Volume 3” has been released by **Morning Sun Books** ([morningsunbooks.com](http://morningsunbooks.com)). Authored by Stephen M. Timko, this volume completes the Amtrak Power series by covering the electric fleet from the historic GG-1s to the lesser-known Amtrak E44s. Metroliners, AEM-7s, HHP8s, RDCs, Turbos, and the Acela trains are all reviewed.

Additional new books available from Morning Sun include “Appalachian Coal Mines and Railroads In Color Volume 2: Virginia,” featuring the work of noted Appalachian-area photographer Everett Young.

Also “Railroad Critters In Color Volume 5,” with over 330 new photos of minority builders including Atlas, Davenport, Plymouth, Porter, Vulcan. Small industrial locomotives built by Baldwin, EMD, and GE are included.

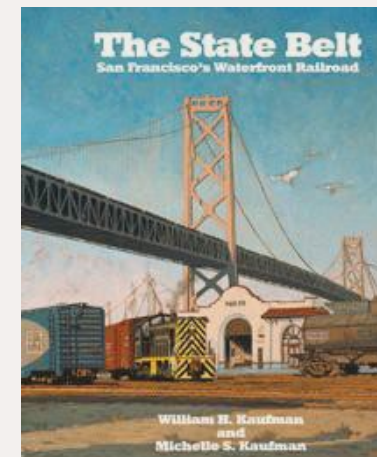

**Signature Press** ([signaturepress.com](http://signaturepress.com)) has released “The State Belt – San Francisco’s Waterfront Railroad.” The book tells the story of the state-owned railroad that served the piers and industries of the San Francisco waterfront area, interchanging with Southern Pacific at King Street, and with Santa Fe, Northwestern Pacific, and

Western Pacific by car float. Additional details including pricing are available at the above website.

## O SCALE PRODUCT NEWS



**Atlas O** ([atlaso.com](http://atlaso.com)) has released information about the next production run of Trainman

series 60' heavyweight passenger cars. A coach has been scheduled for release during the 3rd quarter of 2014. It will be decorated for Burlington, Chesapeake & Ohio, Milwaukee Road, New York Central, and CNJ/NJDOT as illustrated here. Three-rail

versions of the O scale car will have an MSRP of \$99.95. Cars equipped for two-rail operation will list at \$104.95.



A baggage car (left), a combine, and a railroad post office car decorated for Milwaukee Road, New York Central, and Chesapeake & Ohio will also be available in the 3rd quarter. Details are available at the above website.

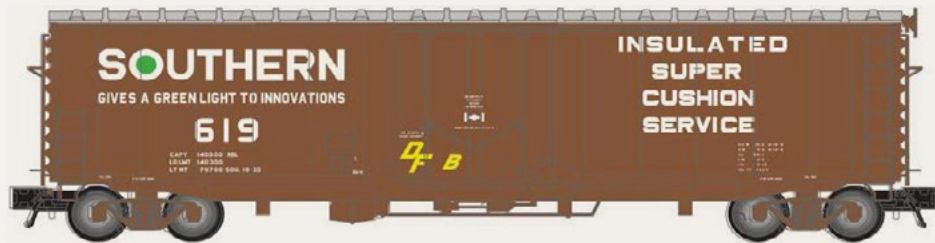

New models due from Atlas O during the 4th quarter of 2014 include a modernized 50' PS-1 plug-door boxcar. The thoroughly insulated car was designed to carry canned food stuffs that did not require refrigeration but did need protection from temperature extremes. The plug-style doors provided a tight seal to protect the load from dust and extreme shifts in temperature. Road names will include Missouri Pacific, CGW-Chicago & North Western, Chessie System, Union Pacific, and Southern Railway as illustrated here.



Also scheduled for release by Atlas O in the 4th quarter of 2014 is a group of Trainman 50' single-sheathed wood boxcars with double doors for auto service. Road names will be Northern Pacific, Santa Fe, and Western Pacific – all with Youngstown corrugated steel doors. A car decorated for Rock Island will be available with wood doors.



Atlas O has scheduled the delivery of a new run of its SW series diesel locomotives for the 1st quarter of 2015. The ready-to-run model replicates prototypes built by EMD in the late 1930s. Road names for the SW-8 will be Boston & Maine, Canadian National, and Rock Island. SW9 engines will be decorated for Indiana Harbor Belt and Missouri Pacific. SW900 versions of the ready-to-run O scale locomotive will include Reading and Raritan River as illustrated here. Both two-rail and three-rail versions will be available with optional Lionel Trainmaster Command and RailSounds 4.0. See the above website for details and pricing.

Atlas O has scheduled the delivery of a new run of its SW series diesel locomotives for the 1st quarter of 2015. The ready-to-run model replicates prototypes built by EMD in the late 1930s. Road names for the SW-8 will be Boston & Maine, Canadian National, and Rock Island. SW9 engines will be decorated for Indiana Harbor Belt and Missouri Pacific. SW900 versions of the ready-to-run O scale locomotive will include Reading and Raritan River as illustrated here. Both two-rail and three-rail versions will be available with optional Lionel Trainmaster Command and RailSounds 4.0. See the above website for details and pricing.



Morgan Hill Models ([morganhillmodels.com](http://morganhillmodels.com)) is selling a kit for an On30 28' low-side wood gondola. Included in the kit are cast resin frame and side stakes, Mt. Albert basswood for the sides and deck, and Grandt Line detail parts. The kit is available for \$29.95 less trucks and couplers.

Morgan Hill Models ([morganhillmodels.com](http://morganhillmodels.com)) is selling a kit for an On30 28' low-side wood gondola. Included in the kit are cast resin frame and side stakes, Mt. Albert basswood for the sides and deck, and Grandt Line detail parts. The kit is available for \$29.95 less trucks and couplers.



## HO SCALE PRODUCT NEWS

The latest HO scale kits

released by **Accurail** ([accurail.com](http://accurail.com)) include a Great Northern 40' USRA double-sheathed wood box car. The kit has an MSRP of \$16.98.



Also new from Accurail is a three-car set of ACF triple-bay covered hopper cars. As seen here, the cars are decorated for Chessie System in three different variations: B&O, WM, and C&O. The three-pack set has a list price of \$52.98.



Accurail's Bessemer & Lake Erie USRA 55-ton twin-bay hopper represents a prototype built in 1918. The kit, which has an MSRP of \$15.98, includes a decal renumbering set to allow the modeler to apply different numbers to a string of hoppers.



This 50' double plug-door steel boxcar is available from Accurail in kit form at an MSRP of \$16.98.

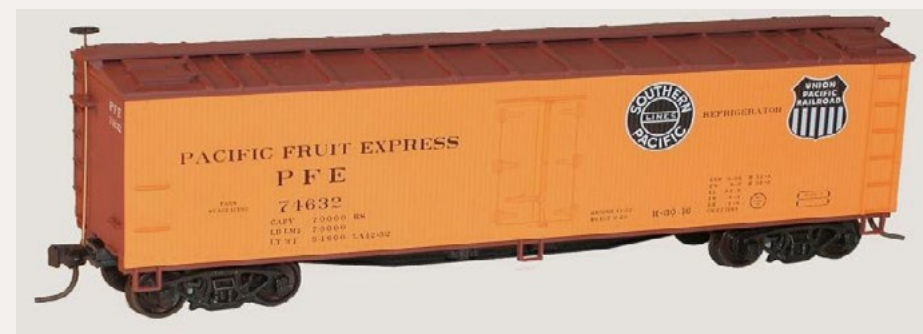

A double herald SP-UP Pacific Fruit Express wood reefer is available from Accurail in a two-car set at \$34.98. The HO scale model is based on a prototype built in 1923 and rebuilt in 1952. Trucks and couplers are included in all Accurail kits.



American Model Builders ([laser-kit.com](http://laser-kit.com)) has a new kit for a New York Central 19000 series wood caboose. The kit features numerous precision laser-cut components with laser-scribed sides. Details include cast resin platform steps and brake gear, cast white-metal smokejack, and injection molded turnbuckles. Several fixtures are shown to aid the modeler in replicating the handholds, ladders, and truss rods found on the prototype. Options for the model builder include square or rounded body corner posts, side windows that can be modeled open or closed, two different styles of end ladders and running boards, and variations on the end windows of NYCs distinctive low profile cupola. A set of screen doors and windows are provided along with custom decals and illustrated instructions that include information on painting and finishing the assembled model. The craftsman kit has an MSRP of \$59.95. Trucks and couplers are not included.



**Athearn's** ([athearn.com](http://athearn.com)) next production run of Genesis SD60 locomotives will include three different BNSF paint schemes. The mix shown above (from the top) will include Heritage I,

Heritage II, and a new BNSF experimental scheme. Additional road names in this release will be Norfolk Southern (Horsehead scheme), Conrail, and Union Pacific (SD60M). All are due to arrive in late December.



Also scheduled for release in late December are SW1500 locomotives decorated for Amtrak,

Conrail, D&RGW (SW1000), BNSF (heritage), BNSF (wedge scheme), NS (Horsehead scheme), and NS (River Street Rambler scheme) as seen above.



Athearn will include a Ready-to-Roll® PS-2 2893 covered hopper in the December

release. In addition to the SP car shown here with red lettering, other road names will be Reading, Grand Trunk (blue), Central of Georgia, and C&O (progress scheme).

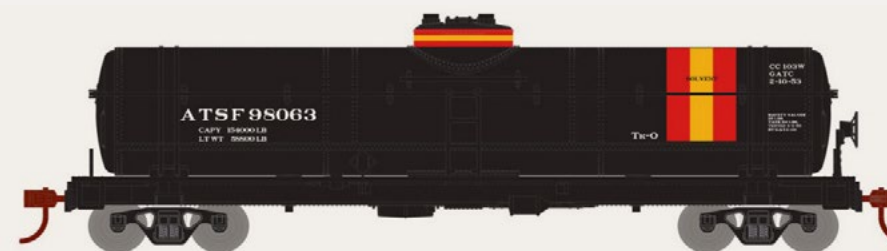

An HO scale single dome tank car is also scheduled for release in late 2014. Road names will be UTLX,

Indian Refining, GATX, Crystal/Red, and ATSF (above). The MSRP will be \$26.98 each.



A group of 53' CIMC containers will be available in a three-pack at an MSRP of \$29.98. Owner names will be Marten, HUB Group, EMP, CSX/Boxcar, COFC Logistics, and Schneider as illustrated here. The HO scale stackable containers feature separate door closure rods.



Athearn's list of releases for late December concludes with a caboose; a steel bay window

type with an MSRP of \$19.98. Road names will be Chicago North Western (illustrated here), Western Pacific, Southern Pacific, Norfolk Southern, Erie Lackawanna, and FNM – Ferrocarriles Nacionales de Mexico. Some roads will have plugged windows depending on the practice of the prototype.

**Atlas** ([atlasrr.com](http://atlasrr.com)) is scheduled to release a new run of its Master series pulpwood flat cars during the 4th quarter of this year. The HO scale models come with a pulpwood load for the V-deck cars.



They will have an open or closed bulkhead depending on the practice of the prototype road

which includes Delaware & Hudson, Louisville & Nashville, Frisco Line, Maine Central, Santa Fe, and Seaboard Coast Line. The ready-to-run models will have an MSRP of \$34.95 each. An undecorated car will list at \$24.95.



Also coming in the 4th quarter of this year is an Atlas Trainman® kit for a 1937 AAR 40' boxcar.

Three numbers each will be available for Canadian Pacific (Spans the World slogan), Detroit & Mackinac, NC&StL (Dixieland slogan), New York Central (jade scheme), Union Pacific (Road of the Streamliners slogan), and Genesee & Wyoming. The kits will have an MSRP of \$18.95. An undecorated kit will list at \$13.95.



Bachmann ([bachmanntrains.com](http://bachmanntrains.com)) has released its Heritage series GE ES44AC and SD70ACe diesel

locomotives. Decorating schemes available on the ES44AC are Central of Georgia, Lehigh Valley, Pennsylvania, Nickel Plate Road, and Southern Railway.

Decorating schemes for Bachmann's Heritage Edition SD70ACe include Wabash, Erie, Jersey Central Lines, Virginian, and New York



Central. Visit the above website for additional information including details on the sound systems available and pricing.



Additional new items from Bachmann include a Silver Series 50' 6" drop-end gondola. The HO scale ready-to-run model comes with different loads for each road name: Western Maryland (scrap load), Nickel Plate Road (tire load), Denver & Rio Grande Western (steel coil load), and Reading (crushed rock load). Visit the above website for pricing and availability on specific road names.



Over the next several months, **Broadway Limited Imports** ([broadway-limited.com](http://broadway-limited.com)) will release individual cars for both the 1941 and 1953 versions of

Southern Pacific's beautiful Daylight train. The skirted prewar cars (above) were lettered "Southern Pacific Lines". The postwar cars were not skirted and "Lines" was deleted from the letter board (next page).



The cars include a passenger-baggage combine, chair car, two-car articulated chair car, tavern car, three-car articulated café-

kitchen-diner, and the parlor-observation illustrated here. Visit the above website for pricing and detailed specifications. BLI has created a video about the models viewable at [broadway-limited.com/spdaylighttrainsho.aspx](http://broadway-limited.com/spdaylighttrainsho.aspx).



**Bowser ([bowser-trains.com](http://bowser-trains.com))** has scheduled a December delivery date for the

next production run of Alco C-430 diesel locomotives. The HO scale Executive Line models will be available for Western New York & Pennsylvania (both black and red versions), New York Central, Susquehanna, Penn Central, Conrail (both blue and black versions), GBW, Lehigh Valley, Rock Island, and Alco Century demo scheme.



Bowser is accepting reservations for its GMD SD40-2 diesel locomotives until July 18. Delivery is planned for spring 2015. Road

names for the HO scale version of the Canadian-built prototype will be Dakota, Minnesota & Eastern; Ontario Northland (as

delivered in green with yellow and red stripes); ON (yellow scheme with chevrons); British Columbia Railway (two-tone green); BC Rail (red, white and blue hockey stick scheme); and CP Rail (six different schemes). Visit the above website for pricing and reservation details.



Bowser has a selection of original Stewart F unit diesels equipped with LokSound Select Dual-Mode

decoders and lighted number boards. Decorating schemes available for F3 units include New York Central, MKT, Maine Central, CGW, CB&Q, Milwaukee Road, and Soo Line. F7 diesel road names include Canadian National, Amtrak, Baltimore & Ohio, Lehigh Valley, Reading, Western Pacific, Rock Island, Missouri Pacific, L&N, Western Maryland, and Cotton Belt. F9 road names currently available include Santa Fe (blue and yellow freight scheme), Burlington Northern, D&RGW, and Milwaukee Road. A units are available for the F3, F7, and F9 locomotives mentioned above. For availability of matching B units as well as pricing for the Stewart F series locomotives visit their website.



**Con-Cor ([con-cor.com](http://con-cor.com))** is selling Pennsylvania Railroad class mP54 MU elec-

tric cars as refurbished in the 1950s. Upgrading the cars was accomplished at PRR's Wilmington Shops. The overhaul included replacing the old wooden window sashes with new, highly visible aluminum frames.

The PRR cars are available in the pre-war keystone scheme (above) and the post-war Pennsylvania scheme (below).



repainted as shown below.



Most of the refurbished cars continued to operate into the Penn Central era and were

Visit the above website for pricing and ordering information.

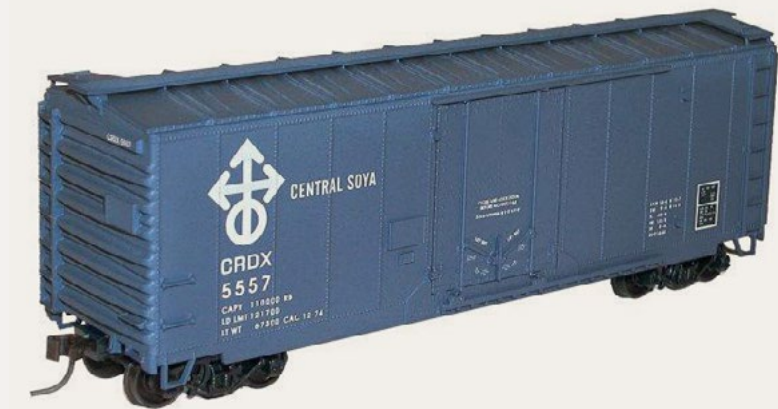

**Digital Fox ([digitalfox.com](http://digitalfox.com))** sells custom decorated kits of various HO scale Accurail kits. Items currently available include a CRDX-Central Soya 40' insulated plug-door boxcar with

Dreadnaught ends at an MSRP of \$16.99.

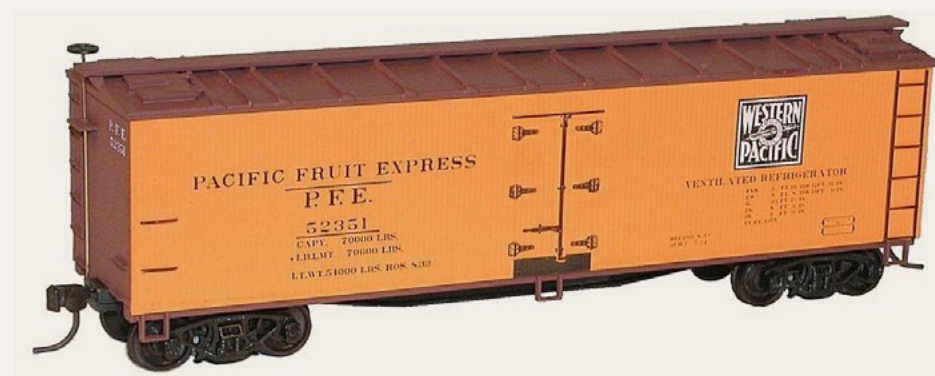

Also available now is a PFE/WP 40' wood reefer based on a prototype originally built in 1924 and rebuilt in 1948. The reefer

kit is available in six numbers at an MSRP of \$17.99 each.

Scheduled for release later this month is an HO scale kit for a Nickel Plate Road 40' wood stock car. It will be available in three road numbers at an MSRP of \$16.99 each.



Metal wheelsets can be substituted at \$2.69 per kit. Visit the above website for ordering information including details about reduced pricing

for multiple purchases of the same kit.



**Division Point ([divisionpoint.com](http://divisionpoint.com))** has imported brass models of New York Central 2-8-2 Mikado steam locomotives.



Handcrafted in South Korea by Boo Rim, the HO scale models accurately replicate the class H-10a and H-10b prototypes built at

Schenectady in 1924. Visit the above website for additional details including a list of authorized dealers.

**InterMountain Railway ([intermountain-railway.com](http://intermountain-railway.com))** has added four painted but unlettered models to the run of HO scale ES44DC Evolution series locomotives due for release late this



year. The unlettered versions will be available in black, white, silver, and gray. Fully decorated road names will be BNSF (Heritage II scheme), BNSF (new image scheme with black logo), CSX, Canadian National, and Norfolk Southern. The ready-to-run models will have an MSRP of \$199.95 or \$289.95 with sound.



Kadee is scheduled to release an HO scale ready-to-run model of a Northern Pacific twin-bay covered hopper car in August. The HO scale model replicates a PS-2 prototype built in 1957 with eight round hatches and decorated with light gray alkali resistant paint.



Also coming from Kadee in August is a 40' steel boxcar with a 6' five-panel Superior steel door. The prototype was built in 1954. Kadee's HO scale ready-to-run kit will have an MSRP of \$34.95.



This Nashville, Chattanooga & St Louis 50-ton Standard AAR twin-bay hopper is scheduled for release by Kadee in August. It will have an MSRP of \$41.95 including the coal load.

Kadee ([kadee.com](http://kadee.com)) is scheduled to release an HO scale ready-to-run model of a Northern Pacific twin-bay covered

hopper car in August. The HO scale model replicates a PS-2 prototype built in 1957 with eight round hatches and decorated with light gray alkali resistant paint.

Also coming from Kadee in August is a 40' steel boxcar with a 6' five-panel Superior steel door. The prototype was built in 1954. Kadee's HO scale ready-to-run kit will have an MSRP of \$34.95.

This Nashville, Chattanooga & St Louis 50-ton Standard AAR twin-bay hopper is scheduled for release by Kadee in August. It will have an MSRP of \$41.95 including the coal load.



Maple Leaf Trains ([mapleleaftrains.com](http://mapleleaftrains.com)) is selling a cast resin kit for a GP9 slug. The principal contents of the kit are a resin cast body and frame, etched metal parts, cast resin details, and instructions. The HO scale model represents class GY00d and GY00e slugs (CN# 215-241).

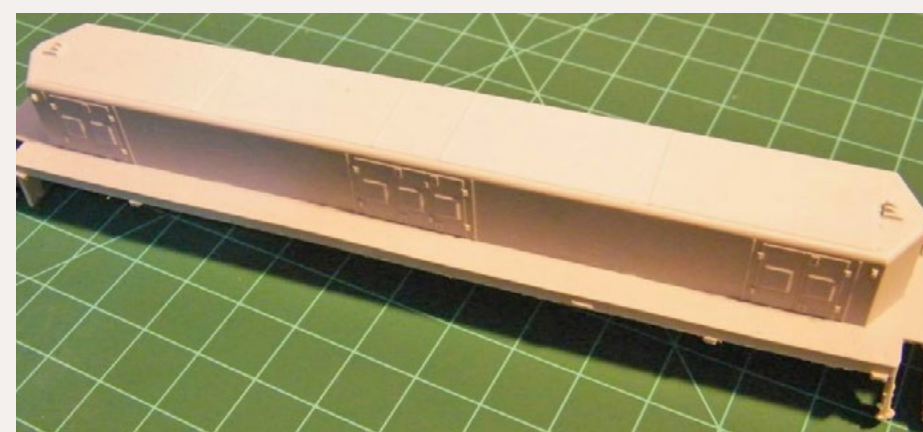

Trucks, side-frames, MU hoses, grab irons, and an LED for the headlight are not included.



NJ International ([njinternational.com](http://njinternational.com)) has introduced a Barrel Rack kit with sufficient material to assemble a rack and 24 barrels. The HO scale kit is composed of molded plastic parts. Kit #6110 has an MSRP of \$19.99.

In conjunction with Canada's Expo 67, a special train was assembled to tour the nation and promote the Expo as well as Canadian history. Named the Confederation Train, equipment was provided by both Canadian National and Canadian Pacific railroads. The consist included FP9As from both roads, a CN steam heater car, and several smooth-side passenger cars. All



of the equipment was decorated in a dramatic paint scheme designed especially for the train. To help signal the presence of the train, the locomotive horns were tuned to replicate the opening notes of “Oh, Canada.”



**Rapido** ([rapidotrains.com](http://rapidotrains.com)) has announced plans to produce an HO scale version of Canada’s Confederation Train. In addition to the unique paint scheme, the locomotives will be equipped with dual-mode ESU LokSound decoders that replicate the “Oh, Canada” horn notes. Rapido will require a minimum of 300 reservations in order to proceed with this unique project. For complete details visit the above website.



Red Caboose will release its Tropicana 57’ mechanical refrigerator car in several paint schemes late this year. There will be eight variations of the white car and four of the orange car.



The MSRP on the HO scale ready-to-run model will be \$39.95. InterMountain

Railway is responsible for marketing Red Caboose products. For additional information visit [intermountain-railway.com](http://intermountain-railway.com).



Here is a preview photo of **Rivarossi’s** newly-tooled GE U25C locomotive. The initial release of the HO scale ready-to-run locomotive is expected later

this month. Two numbers each will be available for Chicago, Burlington & Quincy; Atlantic Coast Line; Northern Pacific; and Pennsylvania Railroad. Models equipped with DCC/Sound will have an MSRP of \$299.99. Models for conventional DC operation will list at \$219.99. According to Hornby America, Rivarossi’s North American distributor, the new U25C will be manufactured from all new tooling and has no relation to the model Rivarossi introduced in the 1960s. For additional information visit [hornbyamerica.com/shop/hornby/rivarossi/diesel-locos](http://hornbyamerica.com/shop/hornby/rivarossi/diesel-locos).

**Virginia Foundry & Model Works** is taking reservations for a resin kit for an HO scale 34’ boxcar from the truss rod era. The prototype was a New York, New Haven & Hartford double-sheathed boxcar with an outside end sill built by the Michigan Peninsular Car Co. in 1895. The kit is composed of several cast



resin parts including the floor, doors, running board, bolsters, end sills, some support pieces, and a one-piece body. Kadee #5 couplers are included along with additional

detail parts by Tichy, PSC, Bitter Creek, and Grandt Line. Trucks are either 30-ton Fox from Shapeway, or Tahoe arch bar trucks with InterMountain metal wheelsets.

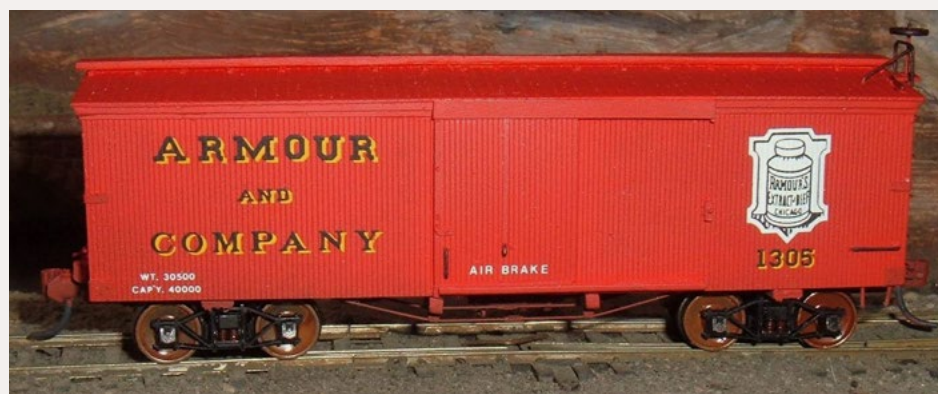

Prototype specific details provided in each kit allow it to be built to represent cars for the following road names: Kansas

City, Pittsburg & Gulf; Rutland Railway; Armour & Company; Big 4; and New York, New Haven & Hartford (with Fox trucks, all others have arch bar trucks). The kits are priced at \$41.00 each plus postage, however advance payment is not required. For additional information or to make a reservation send an email to John Canfield at [jcan2x@hotmail.com](mailto:jcan2x@hotmail.com).



**Walthers ([walthers.com](http://walthers.com))** is accepting reservations for Proto series Union Pacific E9AM and E9BM locomotives.

Delivery is scheduled for April 2015. The HO scale ready-to-run

models will be decorated in UP's Heritage scheme as applied to equipment used in excursion service from 1993 to 2000.



WalthersProto passenger equipment to match the UP Heritage E9 locomotives will be

available beginning this October. The mix includes five ACF 85' cars: a coach, a dome-coach, a diner, a dome-diner, a dome-lounge (above), and a Budd-built 10-6 sleeper. All are HO scale ready-to-run models.



Walthers has just released a Mainline® series ALCo DL109 diesel locomotive. In addition to the

Milwaukee Road scheme shown illustrated here, the HO scale ready-to-run model is available in four different New Haven liveries; McGinnis, Cranberry, Hunter Green with gray stripes, and Pullman green with simplified striping. Visit the above website for additional details and pricing.



Walthers is scheduled to release a group of PRR class N6B wood cabin cars with centered



cupola in July. A total of six decorating arrangements will be available including the one shown here with a black cupola and a shadow keystone positioned above

the road name. The HO scale ready-to-run cabooses will have an MSRP of \$44.98.

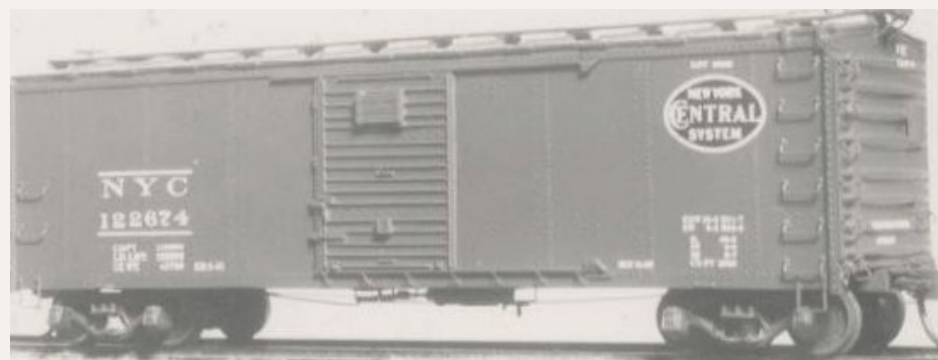

**Westerfield Models** ([westerfieldmodels.com](http://westerfieldmodels.com)) has issued upgraded versions of its 2900 series kits for USRA steel

boxcars. The remastered kits feature a one-piece cast resin body. The New York Central version has Dreadnaught ends. Cars with 7/8 Murphy ends are available for Cleveland, Cincinnati, Chicago & St. Louis; Peoria & Eastern; Hannibal Connecting Railroad; Northampton & Bath; Maine Central; Northern Ohio Railroad; and Bangor & Aroostook. The kits come with appropriate decals but without trucks or couplers. They are priced at \$39.00 each.



**York Modelmaking Ltd.**, ([yorkmodelmaking.co.uk](http://yorkmodelmaking.co.uk)) sells an interesting selection of laser-cut kits including the foot bridge shown here. Although this item is OO (1:76) scale it can be effectively used in many HO settings. Visit the above website for additional information.

## N SCALE PRODUCT NEWS



**American Model Builders** ([laserkit.com](http://laserkit.com)) has a new kit for a Norfolk & Western class CF wood caboose. The N scale kit replicates the as-built prototype with the option

of modeling the car with the original canvas covered roof or the metal roofing the prototype received in later years.

The kit features laser-cut components with laser-scribed birch plywood side, end walls, and cupola. Windows, doors, and trim are peel & stick. Additional details include metal end platforms, ladders, end railing, hand grabs, toilet hopper, tool box, and brake wheels. Also cast resin platform steps and brake gear, and a plastic smokejack. The illustrated instructions include information on painting and decaling the assembled model. The N scale kit has an MSRP of \$31.95 less trucks, couplers, and decals (Microscale #60-482 recommended).



**Athearn's** ([athearn.com](http://athearn.com)) release schedule for December includes a PS-2 2893 covered hopper. In addition to the

blue GT car shown here, road names will include Reading, Central of Georgia, C&O (progress scheme), and a gray SP car with red lettering. The N scale model will have an MSRP of \$19.98 each.



**Atlas ([atlasrr.com](http://atlasrr.com))** plans to release an N scale 40' PS-1 boxcar during the 4th quarter of 2014. Two numbers each will be

available for Ann Arbor, Atlantic & West Point, Central of Georgia, Louisville & Nashville, Rock Island, Virginian Railway, and Great Northern. The N scale ready-to-run model will have an MSRP of \$27.95. An undecorated version will list at \$21.95.



Also coming from Atlas in the 4th quarter of this year is a 90-ton open hopper complete with a load of coal. The Trainman series model will

be available in three numbers each for Conrail, BNSF, Burlington Northern, Clinchfield, Norfolk & Western, and Rio Grande. The ready-to-run model will have an MSRP of \$18.95. An undecorated version of the N scale car will list at \$13.95 each. All Atlas N scale cars come with AccuMate operating couplers.



**Bachmann ([bachmanntrains.com](http://bachmanntrains.com))** has released an N scale EMD NW2 diesel switcher in five decorating schemes. In addition to the Great

Northern version shown above, the ready-to-run locomotive will be available for Union Pacific, New York Central, and Pennsylvania Railroad. It will also be available painted yellow and black but without any lettering. The model has an MSRP of \$149.00.

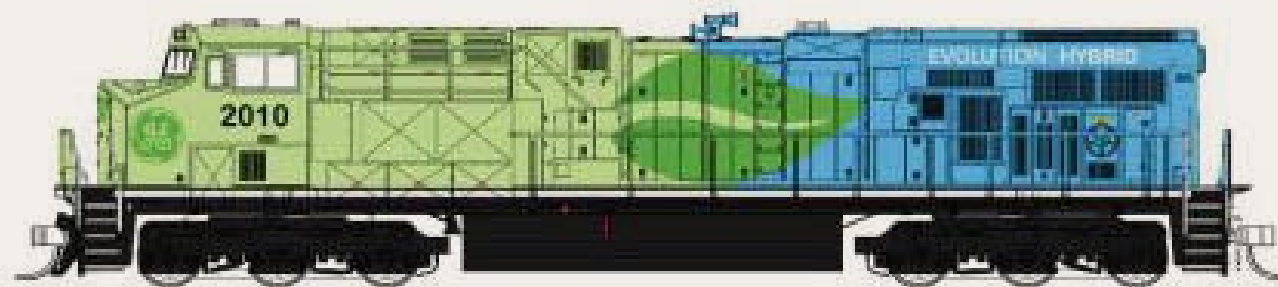

**Fox Valley Models ([foxvalley.com](http://foxvalley.com))** has scheduled a new production run of its ES44AC GEVO locomotive for release late this year. New tooling will be used to produce three different bodies with three different cabs. Road names will be Citirail, UP (ES44A with new PTC antenna array) and General Electric Evolution Hybrid scheme as illustrated here. The N scale ready-to-run models will have an MSRP of \$130.00. They will operate on standard DC and will accept an after-market DCC decoder (not provided) such as a Digitrax DZ125IN or TCS EVN651. InterMountain Railway is responsible for marketing Fox Valley products. For additional information visit [intermountain-railway.com](http://intermountain-railway.com).



**The Hobby Smith ([hobbysmith.com](http://hobbysmith.com))** is selling N scale Spokane, Portland & Seattle Alco RS-3 diesel locomotives in the as-delivered maroon, olive green and tiger

stripe scheme. Road numbers 95 and 98 are available as well as a painted but unnumbered version. The ready-to-run locomotive models are manufactured by Atlas for The Hobby Smith. They are DCC-ready and come with body-mounted couplers and directional lighting. The MSRP is \$119.00 each or two for \$218.00.



F2B), Chicago, Burlington & Quincy (two F2A), Rock Island (two F2A), and Chicago & North Western (two F3A).



KOD8 or Digitrax DN163KOB. Visit the above website for pricing information.

**KatoUSA** ([katousa.com](http://katousa.com)) plans to begin shipping two-packs of EMD F2 and F3 locomotives this month. The release includes Atlantic Coast Line (F2A,

All units are powered for standard DC operation. They are DCC ready and compatible for after-market decoders (not supplied) such as TCS

**Micro-Trains Line** ([micro-trains.com](http://micro-trains.com)) has several new releases including this 50' Atchison, Topeka & Santa Fe

double-door boxcar. This modern car is equipped with a Shock Control cushion underframe and ends with six non-terminating box ribs.

Micro-Trains has decorated this 40' Chesapeake & Ohio boxcar with dark blue side and black ends and a large yellow C&O



Maryland Railway. It was later combined with the Seaboard Coast Line and Louisville & Nashville, to become a key portion of CSX Transportation in the 1980s.



release of this 83' Pullman 12-1 sleeper. The car is painted in NYC post-war two-tone gray scheme. Centered below the window is the name East Alton.

Additional new N scale ready-to-run models from Micro-Trains include a 39' single dome tank car painted black with white lettering for the Mid-Continent Petroleum Corporation. Also new is a CB&Q 50' boxcar with double Youngstown doors. It has a full ladder but no running boards.



are post-1948. By 1966 the car was stenciled for hide service since its interior was not suitable for clean loading.

M-T modeled this DRGW 50' plug-door boxcar after a prototype built by Pacific Car & Foundry in 1962. The decorating scheme

logo. The C&O became part of the Chessie System in 1972 along with the Baltimore & Ohio and Western

M-T continues to expand its selection of N scale heavy-weight passenger equipment with the

The prototype of this Northern Pacific 40' double-sheathed wood boxcar was built in 1925. The 4' monad and the Mainstreet slogan



on the N scale ready-to-run model includes a green “No Damage” stripe. Pricing and additional details on all Micro-Trains product can be viewed at the

their website.



**Rapido Trains** ([rapidotrains.com](http://rapidotrains.com)) is accepting reservations through June 13 for its new

Canadian National GMD-1 diesel locomotive. The prototype was designed and built by General Motors, London, Ontario. Rapido’s N scale version will be available with a DC/DCC dual mode ESU decoder or an ESU DC/DCC/Sound LokSound decoder.

In addition to the original GMD-1 1000-series with the cab interior configured for operation with the long hood forward, Rapido will also offer the 1988 rebuilt 1600 series GMD-1A. The rebuild involved reorienting the cab controls to run short hood forward. Additional changes included the installation of a chemical toilet with an access door in the short hood, relocating the batteries, and the addition of anticlimbers, ditch light brackets, and straight exhaust stacks.

Paint schemes will be Canadian National (green), CN (noodle, black), CN (noodle, black and red), and undecorated, all with DCC/Sound at an MSRP of \$249.00 each. Models for standard

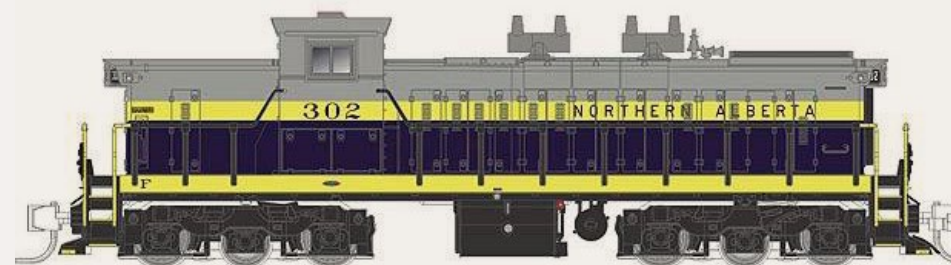

the above website for details including special pricing on models decorated for Northern Alberta Railways.

DC operation will list at \$159.00. A power chassis only will also be available. Visit



in several paint schemes late this year. There will be eight variations of the white car and four variations of the orange car.

**Red Caboose** will release its Tropicana 57’ mechanical refrigerator car



Railway is responsible for marketing Red Caboose products. For additional information visit [intermountain-railway.com](http://intermountain-railway.com).

The MSRP on the N scale ready-to-run model will be \$26.95. InterMountain

## NEW DECALS, SIGNS AND FINISHING PRODUCTS

New items from **Mask Island Decals** ([maskislanddecals.com](http://maskislanddecals.com)) include the PS-built Southern Hydro Cushion gondola shown on the next page.

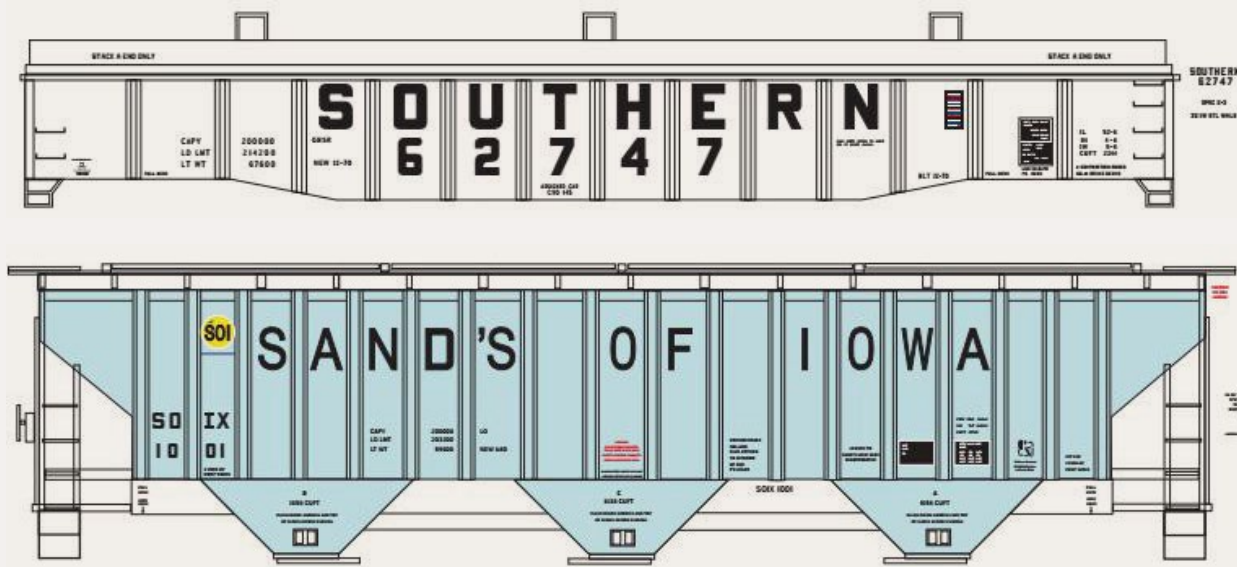

Also new are five road names for 4750 triple-bay covered hopper cars including the Sands of Iowa set for a light blue car. The others are Tidewater Grain, Missouri Pacific (screaming eagle), Missouri Pacific (buzz saw medallion), and Farmers Coop. Added to the most recent listing are decals for a Great Northern 70-ton twin-bay covered hopper. Visit the above website to order.

## DISCLAIMER ..

The opinions expressed in this column are those of the writer and do not necessarily reflect the opinion of Model Railroad Hobbyist or its sponsors. Every effort is made to provide our readers with accurate and responsible news and information, however, neither Model Railroad Hobbyist or the writer of this column can be held responsible for any inaccuracies or typographical errors that may inadvertently appear in this column.



## Send us your product announcements

If you are a hobby manufacturer with a product announcement, just [click here](#) and submit your announcement to us.

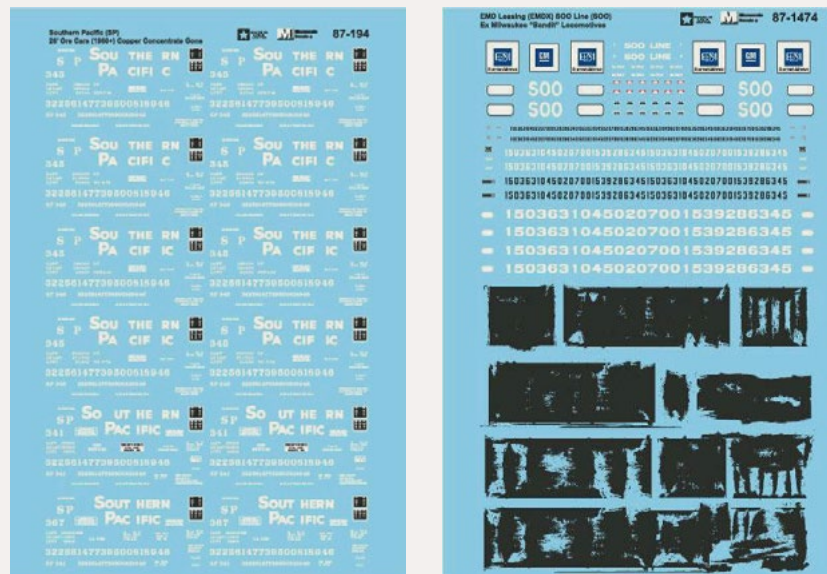

New wet decals from **Microscale Industries** ([microscale.com](http://microscale.com)) include Southern Pacific 26' ore cars (above left); locomotives, freight cars, and cabooses for U.S. Army, Air Force, and Dept. of Defense (DODX); EMD Leasing

(EMDX), and SOO Line (SOU) ex-Milwaukee "Bandit" locomotives (above right). All are available in N and HO scale. Also new are N, HO, and O scale decals for Southern Railroad (SOU) wood chip cars and gondolas.

Advertisement

CHECK IT OUT!

# Click Here

## FIFER HOBBY SUPPLY LLC

### Your Local Online HO & N Scale Hobby Shops

575-523-9743 • [fiferhobby.com](http://fiferhobby.com) • [fiferhobbyho.com](http://fiferhobbyho.com)





## Briefly noted at press time...

### ... New ownership for the Great Scale Model Train Show

John "Scott" Geare and Michael Joseph Militello, owners of Makin' Tracks of Crozet, VA, have purchased the Ellicott City Scale Model Railroad Association and all of the Great Scale Model Train Shows from Howard Zane and Ken Young. Zane will be an active advisor to the new owners, as well as continue as a vendor at the shows he established in 1982. Young will provide training and high-tech support for the event. The new owners have pledged to continue the well-established pricing and exhibitor policies for vendors, and show attendees. The next Great Scale Model Train Show will be held June 21-22 at the Maryland State Fairgrounds, 2200 York Road, Timonium, MD. Inquiries should be directed to Scott Geare at [jsgeare@yahoo.com](mailto:jsgeare@yahoo.com).

### ... Athearn

Athearn plans to deliver Genesis HO scale SD45-2 and FP7 locomotives in late December in all new decorating schemes. The SD45-2 will be produced for CSX, Erie Lackawanna, Norfolk Southern, and two Santa Fe schemes: Bicentennial and Kodachrome. The FP7 will be available for Penn Central, Rock Island, and Atlantic Coast Line.

Also coming from Athearn in late December is another run of HO scale GE Dash 9-44CW Ready-to-Roll® diesels in the livery of Santa Fe, British Columbia Railway, Chicago & North Western Burlington Northern, Norfolk Southern and Union Pacific.

Additional production runs of Athearn's PS 50' 5344 boxcars and a Trinity 5161 triple-bay covered hopper have been scheduled for delivery in November. We'll have road names for you next month. Also due in November are both HO and N scale versions of individual Husky Stack cars. Road names will be BNSF, CSX, Trailer Train, TTX, and TTX with new logo. We'll have photos and additional information on all of Athearn's latest products next month. ■

Get the first 50 issues of  
**Model Railroad  
 Hobbyist magazine™**

On a data DVD for \$10!

**Send me one!**

*(Sold by Model Trains Video)*

**Includes a coupon  
 good for \$20 off on  
 TrainMasters TV**

**Over 5000  
 pages of  
 how-to  
 information  
 on model  
 railroading**



**Save  
 yourself  
 endless  
 hours of  
 downloading**

## Selected Events



### June 2014

**CALIFORNIA, FREMONT**, June 14-15, 3rd Annual TCSME Open House sponsored by Tri-City Society of Model Engineers with N and HO scale layouts in operation plus swap meet on Saturday, at Niles Plaza, 37592 Niles Blvd. Info at [nilesdepot.org/niles/home.html](http://nilesdepot.org/niles/home.html).

**CALIFORNIA, RICHMOND**, June 21, San Francisco Bay Area Prototype Modelers Meet, at St. David's School Hall, 871 Sonoma St. Info at [bayareaprototypemodelers.net](http://bayareaprototypemodelers.net).

**CALIFORNIA, SAN JOSE**, June 14, Open House at Silicon Valley Lines featuring 600 foot long mainline double-deck HO scale layout, at 148 E. Virginia Street (basement). Info at [siliconvalley-lines.com](http://siliconvalley-lines.com).

**CALIFORNIA, VISTA**, June 7, 2nd Annual Open House & Swap Meet sponsored by Short Track Railroad Club, at the Antique Gas & Steam Engine Museum, 2040 North Santa Fe Avenue. Info at [shorttrackrr.org](http://shorttrackrr.org). For table reservations contact Milt Perkins at [miltperkins@roadrunner.com](mailto:miltperkins@roadrunner.com).

**FLORIDA, TALLAHASSEE** June 28, Model Railroad Sale & Show, at North Florida Fairgrounds, 441 Paul Russell Road. Info at [bbmra.org/show.html](http://bbmra.org/show.html).

**MARYLAND, TIMONIUM**, June 21-22, Great Scale Model Train and Railroad Collector Show, at Cow Palace, Maryland State Fair, 2200 York Road. Info at [gsmts.com](http://gsmts.com).

**OHIO, BRADFORD**, June 21, Rail Festival at Bradford Ohio Railroad Museum, 200 North Miami Ave. Info at [bradfordrrmuseum.org](http://bradfordrrmuseum.org).

**TENNESSEE, MEMPHIS**, June 13-15, NMRA Joint Convention of Southeastern Region and Mid-Continent Region, at Hilton Memphis Hotel, 939 Ridge Lake Blvd. Info at [mrtm.org/convention](http://mrtm.org/convention).

**TEXAS, ROUND ROCK**, June 4-8, NMRA Lone Star Region 2014 Convention. Info at [bluebonnetlimited.com](http://bluebonnetlimited.com).

**UTAH, SALT LAKE CITY**, June 19-22, NMRA Rocky Mountain Region Golden Spike Limited Convention, hosted by the Northern Utah Division. With clinics, layout tours, and prototype tours including Golden Spike National Monument at nearby Promontory. Info at [gsl2014.org](http://gsl2014.org).

**VIRGINIA, ROANOKE**, June 25-29, National N Scale Convention at Sheraton Roanoke Hotel & Convention Center, 2801 Hershberger Road. Info at [nationalscaleconvention.com](http://nationalscaleconvention.com).

**WASHINGTON, TACOMA**, June 18-21, NMRA Pacific Northwest Region Convention at La Quinta Inn 1425 East 27th St. Info at [wnrr.net/PSX2014](http://wnrr.net/PSX2014).

### July 2014

**CALIFORNIA, McCLELLAND (Sacramento)**, July 16-20, 2014, National Summer Steam Up – Small-Scale Live Steam Event, HQ at Lions Gate Hotel. Info at [summersteamup.com](http://summersteamup.com).

**NEW JERSEY, GLASSBORO**, July 12, Annual Train Show sponsored by the Strasburg Model Railroad Club, at St. Thomas Parish House, Routes 47 & 322 Focer Street. Info from Dave Luciano at [luciano1@comcast.net](mailto:luciano1@comcast.net) or call (856) 988-0689.

**OHIO, CLEVELAND**, July 13-19, 2014 NMRA National Convention. Info at [2014cleveland.org](http://2014cleveland.org).

**OHIO, CLEVELAND**, July 18-20, 2014 National Train Show at New Cleveland Convention Center, 300 Lakeside Avenue. Info at [2014cleveland.org](http://2014cleveland.org).

**WISCONSIN, La Crosse**, July 19, 4000 Foundation Rail Fair, model railroad swap meet plus tours of restored CB&Q locomotive 4000, Milwaukee Road caboose 0359, and Grand Crossing Signal Tower. Sponsored by 4000 Foundation, at Copeland Park. Info at [4000foundation.com](http://4000foundation.com).

## Future (by location)

**CANADA, QUEBEC, LAVAL**, October 4-5, The North Shore Train Show, at Complexe Multi-Sports, 995 rue Bois-de-Boulogne. Info at [salondutrainrivenord.org](http://salondutrainrivenord.org).

**ARIZONA, PRESCOTT**, August 16, Annual Beat The Heat Swap Meet, sponsored by Central Arizona Model Railroad Club at Prescott Activity Center, 824 E. Gurley Street. Info from Steve Bumgardner at 928-775-3184.

**CALIFORNIA, SAN DIEGO**, September 3-7, 2014 NMRA Pacific Southwest Region Convention, at Courtyard Marriott, Hotel Circle South. Info at [psrnmra.org](http://psrnmra.org).

**CALIFORNIA, TEHACHAPI**, August 9-10, Summer Model Train Show, sponsored by Tehachapi Loop Railroad Club, at West Park, 491 West D Street. Info at [tehachapilooprailroadclub.org](http://tehachapilooprailroadclub.org).

**FLORIDA, PALM BAY**, December 21, HO Scale Module Display sponsored by Palm Bay Model Railroad Club, at Franklin T. Degroodt Memorial Library, 6475 Minton Road.

**FLORIDA, THE VILLAGES**, August 16-17, Summer Model Train Show and Sale at Savannah Regional Recreation Center, 1545 Buena Vista Blvd. Sponsored by The Villages Railroad Historical Society. Info from Alan Goldberg 352-205-4322, or email: [amgold15@hotmail.com](mailto:amgold15@hotmail.com).

**GEORGIA, KENNESAW**, September 18-20, 2014 Atlanta Railroad Prototype Modelers Meet, jointly sponsored by the Southern Railway Historical Association, Atlantic Coast Line & Seaboard Airline Railroads Historical Society, Central of Georgia Railway Historical Society, and Nashville Chattanooga & St Louis Preservation Society. At the Southern Museum of Civil War and Locomotive History, 2829 Cherokee Street. Info at [srha.net](http://srha.net) or contact Frank Greene at [frgreene290@comcast.net](mailto:frgreene290@comcast.net).

**ILLINOIS, COLLINSVILLE (Metro St. Louis, Missouri)**, August 8-9, St. Louis Railroad Prototype Modeler's Meet, at Gateway Convention Center. Info at [icg.home.mindspring.com/rpm/stl-rpm.htm](http://icg.home.mindspring.com/rpm/stl-rpm.htm).

**ILLINOIS, NAPERVILLE**, October 9-11, 21st Annual Naperville RPM Conference, hosted by Joe D'elia at Sheraton Lisle-Chicago Hotel, 3000 Warrenville Road, Lisle. Info at [railroadprototype-modelers.org/naper\\_meet.htm](http://railroadprototype-modelers.org/naper_meet.htm).

**KANSAS, OVERLAND PARK (Metro Kansas City, Missouri)**, September 3-6, 34th National Narrow Gauge Convention. Info at [kansascity2014.com](http://kansascity2014.com).

**MASSACHUSETTS, PALMER**, September 11-14, 2014 NMRA NER Convention. Info at [nediamonds2014.org](http://nediamonds2014.org).

**NEBRASKA, NORTH PLATTE**, September 19-21, North Platte 2014 Rail Fest Model Train Expo, at National Guard Armory, 1700 N. Jeffers St. Info at [nprailfest.com](http://nprailfest.com).

**NEW HAMPSHIRE, CONCORD**, August 17, 29th Annual Train Show, sponsored by Concord Model Railroad Club, at Everett Arena. Info at [trainweb.org/cmrc/index.html](http://trainweb.org/cmrc/index.html).

**OHIO, WEST CHESTER**, October 11-12, NMRA, Mid Central Region, Cincinnati Division 7, 47th Annual Model Railroad Show. At Lakota West High School, 8940 Union Centre Blvd. Info at [cincy-div7.org](http://cincy-div7.org). Sales table info from Roy Hord at (513) 777-5337 or [rhord@fuse.net](mailto:rhord@fuse.net).

**PENNSYLVANIA, EVERETT**, August 23-24, N-Scale Weekend Model Train Show, sponsored by Bedford Model Railroaders, at Sportsplex, 125 Willow Grove Drive.

**TEXAS, FOREST HILLS**, Oct 11-12, Texas Western 2014 Train Show featuring model train modular layouts, vendor displays, clinics, nearly 100 sales tables, contests, door prizes, and free parking. At Forest Hill Civic and Convention Center, 6901 Wichita Street. Info at [twtrainshow.com](http://twtrainshow.com).

**VIRGINIA, CHANTILLY**, August 7-10, Capitol Limited N Scale East Convention, co-sponsored by Northern Virginia NTRAK and Greenberg Train and Toy Shows, at Dulles Expo Center. Additional information available at [info@bigtrainlayout.org](mailto:info@bigtrainlayout.org).

**VIRGINIA, FREDERICKBURG**, September 12-13, 2014 Mid-Atlantic Railroad Prototype Modelers Meet, with model displays, clinics, and RPM camaraderie. Wingate by Wyndham Hotel, 20 Sanford Drive. Info at [marpm.org](http://marpm.org).

## Future 2015 (by location)

**FLORIDA, COCOA BEACH**, January 8-10, 2015, Prototype Rails RPM meet hosted by Mike Brock, at Cocoa Beach Hilton Hotel, 1550 North Atlantic Avenue. Info at [prototypetrails.com](http://prototypetrails.com).

**OREGON, PORTLAND**, August 23-30, 2015, NMRA National Convention and National Train Show. Info at [nmra2015.org](http://nmra2015.org).

**PENNSYLVANIA, PHILADELPHIA**, May 15-17, 2015, Biennial Meet of the East Penn Traction Club, at Pennsylvania Convention Center. Info at [eastpenn.org/2015\\_meet\\_announcement.htm](http://eastpenn.org/2015_meet_announcement.htm).

**TEXAS, HOUSTON**, September 2-5, 2015, 35th National Narrow Gauge Convention. Info at [nngc-2015.com](http://nngc-2015.com).

## Future 2016 and beyond (by location)

**INDIANA, INDIANAPOLIS**, July 3-10, 2016, NMRA National Convention and National Train Show. Info at [nmra2016.org](http://nmra2016.org).

**MAINE, AUGUSTA**, Sept. 7-10, 2016, 36th National Narrow Gauge Convention. Info at [nngc2016.org](http://nngc2016.org). ■



# Clickable advertiser index

[Accu-Lites](#)  
[Archer Fine Transfers](#)  
[Atlas Model Railroad Co.](#)  
[Bachmann](#)  
[Bachrus](#)  
[Backdrop Junction](#)  
[Berrett Hill Trains](#)  
[Blair Line](#)  
[BLMA](#)  
[Bollinger Edgerly Scale Trains](#)  
[Bowser](#)  
[Canyon Creek Scenics](#)  
[Clever Models](#)  
[Coffman Graphics](#)  
[Coastmans Scenic Products](#)  
[Con-Cor](#)  
[Credit Valley Railway](#)  
[DCC by Design](#)  
[Digitrax \(2 page spread\)](#)  
[D's Model Trees](#)  
[ESU LokSound](#)  
[ExactRail](#)  
[Fast Clock](#)  
[Fast Tracks \(2 page Spread\)](#)  
[Fifer Hobby Supply](#)  
[Fox Valley Models](#)  
[GLX Scale Models](#)  
[Great Decals](#)  
[Iowa Scaled Engineering](#)  
[Iwata-Medea](#)  
[Jelsma Graphics](#)  
[Litchfield Station](#)  
[Logic Rail Technologies](#)  
[Microscale](#)  
[Minimalist Model Railroad](#)  
[Motrak Models](#)  
[Mr. Detail Parts](#)  
[MRH Store \(Model Trains Video\)](#)

[M.T.H.](#)  
[Mullet River \(O scale\)](#)  
[Nano-Oil](#)  
[National Narrow Guage](#)  
[NCE \(2 page spread\)](#)  
[Nick & Nora Designs](#)  
[North American Railcar](#)  
[Rail Design Services](#)  
[RailMaster Hobbies](#)  
[Railroad Explorer](#)  
[Rapido \(2 page spread\)](#)  
[Ring Engineering \(1\)](#)  
[Ring Engineering \(2\)](#)  
[RR-CirKits](#)  
[RSlaserKits, Inc.](#)  
[Rulers-of-the-World](#)  
[Rusty Stumps](#)  
[San Juan Car Co.](#)  
[Streamlined Backshop](#)  
[Scenic Express](#)  
[Signature Press](#)  
[Scotty Mason Show](#)  
[Soundtraxx](#)  
[Southern Digital](#)  
[Sylvan Scale Models](#)  
[TAM Valley Depot](#)  
[TCS](#)  
[Tony's Train Exchange](#)  
[TrainMasters \(1\)](#)  
[TrainMasters \(2\)](#)  
[TrainMasters \(3\)](#)  
[True Line Trains](#)  
[True Scene Modeling](#)  
[Westerfield Models](#)  
[Yankee Dabblor](#)  
[Yarmouth Model Works](#)

# Clickable topic index

[Editorial – Publisher's Musings](#)  
[Editorial – Reverse Running](#)  
[First Look – RR-Cirkits](#)  
[Getting Real – Relocating Williams Creek bridge](#)  
[Layout – \\$500 Layout Contest - 1st Prize](#)  
[News – June Newsletter](#)  
[News – June Events](#)  
[Q and A – MRH Questions, Answers, and Tips](#)  
[Rolling Stock – Modeling Seaboard B-8 and B-9 Box cars](#)  
[Rolling Stock – Weathering Steam Era Freight Cars](#)  
[Scenery – Fast and Easy Trees](#)  
[Structures – Vallejo Earth Texture for Roofs](#)  
[The Lite and Narrow – A narrow gauge coal tipple, Part 1](#)  
[Yes It's a Model – Monthly Photo Album](#)  
[What's Neat – Joe Steimann's weathering decals](#)  
[Wiring – Picaxe circuits for Model Railroading](#)

---

[Other – Bonus Extras](#)  
[Other – Cover](#)  
[Other – Derailments](#)  
[Other – Hobby Marketplace](#)  
[Other – MRH Sponsors](#)  
[Other – Staff Notes](#)  
[Other – Table of Contents](#)



# Really railroading!

## Reverse Running: Stepping outside the box with a contrary view

by Joe Fugate

I love this photo of Brian Bennett from one of Mike Confalone's operating sessions. To me, this photo speaks to the fantastic job Mike Confalone has done creating a model railroad in miniature that feels like it's a real railroad.



Not everyone is into prototype or proto-freelance modeling operations. I recall the janitor at my high school liked model railroading, and so did I. The janitor didn't care one iota about ops, but did he love building models! We had a great time talking trains, leaving many fond memories.

But for me, it's the operations side that excites me the most about the hobby. The model building, the wiring, the benchwork and trackwork – that's all a means to get to the part I love the best: running the trains realistically.

When I think back to what fascinates me most about trains, it's the noisy, gritty, big machines hauling tonnage.

MRH has been doing what we call our "Allagash Bash" with the two-part railfan trip in January/February, and the new eBook series since January – not because we think modeling 1980s Maine in April is cool. No, we think Mike Confalone has captured the essence of really railroading with his models in a way that more modelers need to learn about.

As part of gathering content for the Allagash Bash, I attended one of Mike's operating sessions in July of 2013. I must confess, I was impressed – and as one who has seen hundreds of model railroads now, it's not easy to impress me at the "that's amazing" level, but Mike's HO Allagash managed to do that for me.

First, Mike has executed his layout scenery and photo backdrops with finesse. The scenery-to-track ratio often favors the scenery, further driving home the rural setting.

Second, there were no derailments I can recall during the entire op session. That is rare. It takes good equipment and trackwork to pull that off, as well as an experienced crew that's not making a lot of mistakes like running turnouts thrown against them.

Thirdly, Mike overweights his rolling stock by roughly double the NMRA weight standard. As a result, all the trains on the Allagash feel more massive, the cars don't "wobble" and everything stays on the track better. The trains feel more like "tonnage" when they roll by because they actually do have more mass.

Finally, every loco on Mike's layout has sound. All too often sound can become annoying, but Mike's got it just right. Mike turns the volume down so you can't hear locos from across the room – the sound isn't blaring. You need to be close to the loco to really hear it well.

The total effect of all this makes the Allagash feel different than many model railroads. It seems like you are looking at a scaled-down version of a real railroad rather than just some plastic toys. You get pulled into the action like few model railroads I've seen; you feel as if you're really railroading, with those big gritty, noisy machines pulling some serious tonnage!

# Deraillments

humor, bizarre and fun facts (allegedly)



In this slightly tongue-in-cheek music video, there's a good message: if circumstances are headed for a "train wreck", why hang around and be in the wreck? Notice all the warning signs and "get off the tracks" before the wreck! (See the lyrics on the right.)

If you're the first to [submit a bit of good humor or bizarre facts](#) and we use it, it's worth \$25!



## For the love of model trains

### Coming in the July issue

- Accurate backdrops with computer terrain software
- Build a 2-stall enginehouse
- Modeling 50-foot Gunderson box cars
- One modeler's track cleaning discoveries
- PICAXE circuits for model railroaders, part 2
- \$500 second prize layout contest winner ...and lots more!



### More Deraillments humor and bizarre facts ...

Lyrics from the song "You Can't Blame the Wreck on the Train" by Terri Sharp:

"When the gates are all down  
And the signals are flashing  
And the whistle is screaming in vain,  
And you stay on the tracks, ignoring the facts  
Well then, you can't blame the wreck on the train."