

Sheffield Velocipede • A radio base station • SD45

# Model Railroad Hobbyist magazine™

January 2014

Price: Forever Free

## HAVING FUN WITH TRAINS



Click here for the  
landscape version



# Railfanning the Allagash

*Celebrating MRH's 5th Anniversary*



Standard edition - Portrait



download



contents



index



# RUN #4

The research is done! Introducing the 4th run of our PS-2CD 4000 Covered Hopper.



**COMING SOON IN SIX NEW PAINT SCHEMES!**

**CLICK HERE TO SEE MORE**



# Model Railroad Hobbyist magazine™

Issue 47

**Front Cover:** We feature Mike Confalone's Allagash Railway this month as MRH celebrates its fifth anniversary. Join us as we railfan the Allagash, one visually impressive model railroad!

**ISSN 2152-7423**

## Editorial Staff

Joe D. Fugate, Publisher and editor  
Don Hanley, Assistant editor

## Production

Patty Fugate, pasteup and layout  
Joe Brugger, copy editing  
Mike Dodd, copy editing

## Technical assistants

Jeff Shultz  
Jimmy Simmons

## Advertising

Les Halmos, Account manager  
Daniel Nava, Advertising assistant  
Jean-François Delisle, Marketing assistant

Published for the glory of God. [What's this?](#)



## Columnists

Richard Bale, News and events  
Jeff Shultz, News and events  
Les Halmos, Modular railroading  
Ken Patterson, Reporter at large  
Bruce Petrarca, DCC

## Special Correspondents

Joe Brugger, Questions & answers  
Charlie Comstock, Contributing editor

Issue password: Jan2014

Cover and MRH masthead



contents



index



click to learn more about this sponsor



click to learn more about this sponsor



click to learn more about this sponsor



click to learn more about this sponsor



**NEW SPONSOR!**

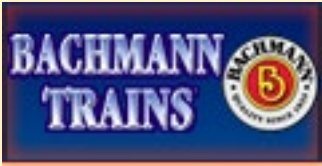

**NEW SPONSOR!**



click to learn more about this sponsor



click to learn more about this sponsor

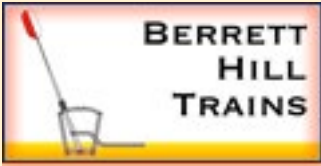

**NEW SPONSOR!**



**NEW SPONSOR!**



**NEW SPONSOR!**



click to learn more about this sponsor



click to learn more about this sponsor



click to learn more about this sponsor



click to learn more about this sponsor



**NEW SPONSOR!**



click to learn more about this sponsor



click to learn more about this sponsor



click to learn more about this sponsor



click to learn more about this sponsor



click to learn more about this sponsor



**NEW SPONSOR!**



**NEW SPONSOR!**



**NEW SPONSOR!**



**NEW SPONSOR!**



click to learn more about this sponsor



click to learn more about this sponsor



click to learn more about this sponsor



**NEW SPONSOR!**



click to learn more about this sponsor



click to learn more about this sponsor



**NEW SPONSOR!**



click to learn more about this sponsor



click to learn more about this sponsor



click to learn more about this sponsor



click to learn more about this sponsor





click to learn more about this sponsor



click to learn more about this sponsor



click to learn more about this sponsor



click to learn more about this sponsor



click to learn more about this sponsor



click to learn more about this sponsor



**NEW SPONSOR!**



click to learn more about this sponsor



**NEW SPONSOR!**



click to learn more about this sponsor



click to learn more about this sponsor



click to learn more about this sponsor



click to learn more about this sponsor



click to learn more about this sponsor



click to learn more about this sponsor



click to learn more about this sponsor

# Want your logo on this page?

Click to find out how....

# 90,000+ unique device views per month...

**Tell me more**

<b>MRH HOBBY MARKETPLACE - 1</b>		<b>MRH HOBBY MARKETPLACE - 2</b>	
Affordable custom and modular benchwork.	<b>WESTERFIELD</b> 4900 Series R-30-4/5/6 PFE Reefers Re-Released! NEW KITS AVAILABLE. www.westerfieldmodels.com	<b>RULERS-of-the-WORLD</b> Scale Rulers \$4 each Over 150 scales! Metric or Imperial www.rulers-of-the-world.com	<b>Great Decals!</b> is now selling decals produced by After Hours Graphics for Midwestern railroads. Roads offered include C&G, Cincinnati Union Terminal, Conrail, CSX, DTA, Great Miami, Indiana and Ohio, Interstate, N&W, Norfolk and Western, Pure Marquette, Southern, Transylvania, and private libels Dow and Owensboro Grain. For the complete list, see: www.greatdecals.com/AfterHours/AfterHoursList.html Great Decals! P. O. Box 994, Herndon, VA 20172
<b>BenchWork</b> Goes on easy! All Scales All Brands Make a Time or Retire Green Grip from a Jar WWW.BULLFROGSNOT.COM	<b>CLEVER models</b> Cardstock models & Building materials www.clevermodels.net	<b>Island Modelworks</b> Commuter Trains, Subways, LRVs Models available in HO, N, & O scales Boston - Chicago - Connecticut - Long Island Maryland - New Jersey - New York City Philadelphia - Portland	<b>NEW!</b> WORK EXITS Where? Here!
MRH Jan 2014 MRH Hobby Marketplace 1	MRH Hobby Marketplace 2		

# Looking for something? Check our Hobby Marketplace!

**Take me there**



## Table of Contents - 1

# Main Features

*Click title  
to view*



## [Journey to Allagash country, Part 1](#)

**Railfanning a fantastic layout**

*by Mike Confalone*



## [Yes, it's a model](#)

**MRH's great modeling photo feature**

*compiled by the MRH staff*



## [Sheffield velocipede](#)

**Maintenance-of-way equipment from the 1900s**

*by Ray and Renee Grosser MMR*



## [Modeling a radio base station](#)

**An inexpensive one evening project**

*by M. R. (Matt) Snell*



## [Santa Fe SD45](#)

**Improving a 1970s Athearn locomotive**

*by Dirk Reynolds*



## [Mold making with CompositMold](#)

**Tips and techniques for making molds**

*by Terry Terrance*

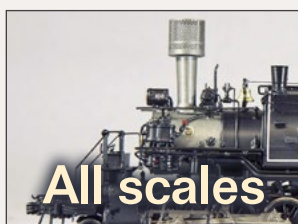

## [January Model Railroading News](#)

**MRH news and events**

*by Richard Bale and Jeff Shultz*

## Table of Contents - 2

# Other Features

*Click title  
to view*

[Our 5th Anniversary](#)

[Publisher's musings](#)

*by Joe Fugate*

[MRH Staff Notes](#)

[2014 New Year's resolutions](#)

*by the MRH staff*

[MRH Q - A - T](#)

[Questions, answers, and tips](#)

*compiled by Joe Brugger*

[Hobby Marketplace](#)

[Vendor ads](#)

[Derailments](#)

[Humor?](#)

# Columns

[Using multiple speakers](#)

[DCC Impulses](#)

*by Bruce Petrarca*

[Building and rebuilding part 2](#)

[Getting Real](#)

*by Mike Rose*

[Scott Sanders' weathering](#)

[What's Neat](#)

*by Ken Patterson*

[Laying a foundation](#)

[Reverse Running](#)

*by Don Hanley*

[Subscriber-only extras](#) (*subscribers click here to access*)





**FINAL ORDER DEADLINE  
JANUARY 24!!**





# Stainless. *Superior* Stainless.

AMTRAK • ACL  
ATSF • C&E  
CRI&P • MTA  
NYC • PC  
PRR • SAL  
SCL • SOU  
UNLETTERED

FLUTED PASSENGER CARS FROM RAPIDO TRAINS INC

S U P E R I O R *Stainless*

**FINAL ORDER DEADLINE  
JANUARY 24!!!**



Email



Phone



contents



index



# EXACTRAIL®

The Next Generation of Model Railroading

**HO** NEW AT EXACTRAIL  
THE WORLD'S  
FINEST WHEEL SETS [▶](#)

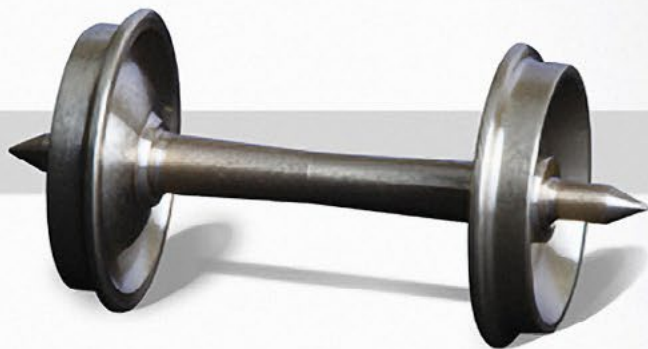

**NOW AVAILABLE**



## BETHLEHEM 3483 HOPPER

Available in 7 Paint Schemes

**HO** [LEARN MORE ▶](#)



**HO** BETHLEHEM 3737 HOPPER

**COMING SOON**





# MRH's fifth anniversary

Looking back and looking ahead



## Publisher's Musings

by Joe Fugate

**A**s of the January 2014 issue, we're officially 5 years old! Issue 1 rolled out January 2009, five years ago this month. When I look at how far we've come and how far digital publishing technology has progressed, I'm amazed.

To prepare for this editorial, I looked back at the very earliest postings on the MRH website forums. Someone commented that reading MRH on a computer would be a lot less portable than reading paper magazines – making a digital magazine something of a pain to read.

So I posted this response to these concerns back in the summer of 2008:

*I don't think the device you're looking for is here yet.*

*IMO, the perfect device would be close to 8 x 11 in size and display PDFs in color. It would also be inexpensive, maybe selling for \$300 or so.*

*If the iTouch or iPhone had good native PDF support, it might work. You would navigate by flicking pages left or right, and double tap to zoom to readable size on a page area. But*





## BACHMANN SHATTERS THE N SCALE SOUND BARRIER! THE DCC SOUND VALUE-EQUIPPED EMD DD40AX

Bachmann is excited to offer the *EMD DD40AX* Centennial Diesel as our first DCC sound-equipped N scale locomotive. This powerhouse includes our Sound Value *SoundTraxx*® diesel sound package with prototypical prime movers (dual-motor sound), three air horns, and bell—all in 16-bit polyphonic sound. The *DD40AX* is loaded with features, including dual motors with flywheels, operating "gumball" light, 16-wheel drive, lighted number boards, weathered air intakes and exhausts, and *E-Z Mate*® Mark II couplers. Visit your favorite hobby dealer for a sound-shattering experience in N scale!

**MSRP \$209.00 each  
SHIPPING NOW!**

Click for more  
information.



UNION PACIFIC® #6900  
Item No. 65151



UNION PACIFIC® #6929  
Item No. 65152



UNION PACIFIC® #6940  
Item No. 65153



Bachmann Industries, Inc. • 1400 East Erie Avenue • Philadelphia, PA 19124 USA • [www.bachmanntrains.com](http://www.bachmanntrains.com)

*Click to learn more.*



*Apple and Adobe have had something of a falling out, so that's not likely to happen any time soon.*

*In the meantime, the most "portable" in a sense is to burn the magazine to CD and read it on a laptop or some other computer.*

*Imagine what would happen to the publishing business if these things reached \$300 - \$600 in price. I think it's only a matter of time ...*

Wow, I wrote that in 2008? Pretty good guess!

In 2010, Apple's release of the iPad started the mobile device craze which is showing every sign of relegating traditional computers to secondary status the same way TV has relegated radio to secondary status in broadcasting.

You can now get a full-sized iPad for as little as \$399 and an iPad mini (7") for only \$299. And if you prefer something *not*

### Advertisement



Structures  
of  
simple  
elegance ...

Made in  
the USA

**ALPINE  
- DIVISION  
SCALE  
MODELS**

**Click to  
Learn  
more...**

**alpinemodels.com**



from Apple, a new Google Nexus 10 can be had for \$399 and a full-sized Kindle Fire HD goes for \$379.

Remember, I was writing this in 2008 when a full-featured laptop was \$1000+ and a low-end laptop was \$600.

We were certainly a bit ahead of our time back in 2008-2009. Technology has caught up with us: MRH is now quite readable and very portable on tablets and smartphones – and searching an electronic magazine is a breeze compared to paper!

I could go on-and-on about the publishing innovation side of MRH, but this little look back shows how we were at the right place at the right time. If you want more retrospective on the publishing innovation side of MRH, see this issue's Staff Notes.

How about the content? How have we done there?

With this issue, we've now produced 47 magazines, each of 120 pages (Gen2: spreads) or more. If we look at total article content and take out the ads, we've delivered over 3500 pages of articles on model railroading, all completely free!

Of course, the hobby advertisers have paid the freight for you, so we owe them a lot of thanks.

The recent concern expressed on our forums that we don't feature enough steam lead me back to see how we've done on cover stories across these 47 issues, and here's what I found:

- Our first steam cover: Issue 1
- Our first diesel cover: Issue 7
- Total steam covers: 9
- Total diesel covers: 20
- Total rolling stock covers: 11
- Total other<sup>1</sup> covers: 6

---

<sup>1</sup> Other covers include more artistic covers like issue 3's servos cover or covers that show modelers running trains on a layout



# The Amherst Railway Society Railroad Hobby Show

Our 2014 Show will be

# January 25 & 26, 2014

Save the dates!



**Click to  
learn  
more ...**

## About The Show

Every year late in January or early in February, the Amherst Railway Society holds its Railroad Hobby Show at the Eastern States Exposition Fairgrounds (The home of The Big E) in West Springfield Massachusetts. More than 25,000 railfans and public attended the Show each of the past three years.

The event features real life railroads and scale model railroads, historical societies, travel agencies, art shows, flea market dealers, importers, manufacturers and photographers. You have to see it to believe it!



So the diesel covers do out-number the steam covers roughly two-to-one. In defense of our coverage of steam, we did do a four-part in-depth article on scratchbuilding a steam loco in styrene. That's something we've never done for diesels.

I do agree we need more steam articles to balance the scales better, so we've put the call out for more articles on steam subjects. We're getting promises from authors that they're working on it, so stay tuned.

What does the future hold for MRH?

Our goal remains to help you do the hobby well, and to that end we will keep bringing you the best in intermediate and advanced modeling articles as well as keep providing more encyclopedia-style articles like the pieces on freight car trucks and brakewheels.

And of course, we'll keep bringing you the best in model railroading photography with things like Yes, it's a model.

We have some great material lined up for 2014, which includes not only articles and supplemental videos in MRH, but more in-depth material coming in eBooks and DVDs this year.

For those who are TrainMasters TV subscribers, the DVDs will also be coming to TMTV roughly 6 months after the DVD has been released.

So how do you think we've done in our first five years? We'd love to hear your comments, good, bad or otherwise.

While the attaboys are nice, it's the helpful critical comments that will allow us to make the next five years of MRH even better than the last!

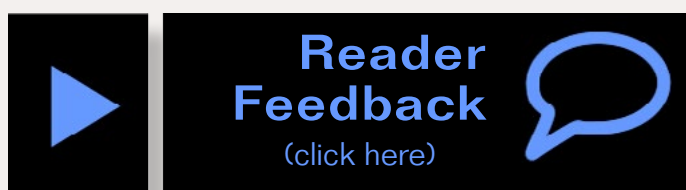
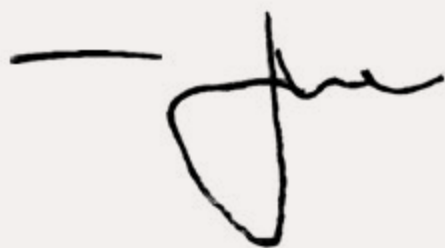





# WOW!

# Premier Scale Trees



Many species of  
Conifer trees available!



Lodgepole  
Pine



Green  
Spruce

Blue  
Spruce

Also see our other  
conifer offerings ...

Click for  
more -  
lots more!



Email



Phone



contents



index

# Notes from the MRH STAFF

New Year's resolutions, Bear Creek 10th Anniversary, and more ...



**H**appy New Year! If you are like many of us on staff, you are probably wondering, where did 2013 go? It seems like it was only a few days ago that we made our New Year's resolutions. You know, the promises we make to ourselves to reach certain milestones on the layout. We will venture a guess that 99% of us missed the goals, or broke our resolutions, so don't feel too bad.

Of course there are some of us who have long ago given up on making New Year's resolutions. We know we won't keep them, so why bother? If you are in that category, why not join the rest of us and let's have some fun with resolutions this year!

We will start a thread on the forum with the release of this issue for our New Year's resolutions. This time next year we can go back and review what we wrote. This will give each of us the opportunity to see how close we came to achieving the goal or goals we set. This is not a club to beat ourselves over the head, but to see how much life really gets in the way. No doubt there will be some surprises.



## Dec 2013 MRH Ratings

The five top-rated articles in the [December 2013](#) issue of MRH are:

- 4.7 DCC Impulses: Tips for DCC motor control
- 4.5 Weathering wall signs
- 4.4 The better way to cove your corners
- 4.4 Yes, it's a model
- 4.4 Installing sound decoder in an HO brass engine
  
- Issue overall: 4.6

***Please rate the articles!***

Click the reader feedback button on each article and select the star rating you think each article deserves. ***Thank you!***

Advertisement



# Rusty Stumps

Scale Models

WE ONLY SELL WHAT WE MANUFACTURE

## DETAILS

IN HO, O, S & N SCALES

LASER CUT SHINGLES, DOORS & WINDOWS, FENCES, SIDING, CRATES. Also RESIN and WHITE METAL DETAILING CASTINGS.

## CRAFTSMAN KITS

IN HO, O & S SCALES

CHECK IT ALL OUT AT

[WWW.RUSTYSTUMPS.COM](http://WWW.RUSTYSTUMPS.COM)

Send \$3.50 for Catalog - Specify Scale

### RUSTY STUMPS SCALE MODELS

6785 Cherry Blossom W. Dr., Fishers IN 46038

Phone (317) 595-9489



Email



Phone



contents



index



Use a servo like an undertable switch machine?

BERRETT HILL TRAINS

www.berretthillshop.com

What will they think of next?

## Up the Creek

We suspect that many of our readers have been wondering where Charlie and his *Up the Creek* column have been lately. Well, the 10th anniversary of the Bear Creek and South Jackson is fast approaching, so Charlie has been focused on completing the trackwork, making the peninsula expansion operational, and having a golden spike ceremony. So here are a few words from Charlie.





“It seems like only yesterday that construction began on the third iteration of my HO Bear Creek and South Jackson. Time flies, and January marks the 10th anniversary of the "Bare Crick," as it’s affectionately called by some.

The layout still isn’t complete, but progress has been steady and it looks like there will be a golden spike ceremony this year, probably in June or July when the full five miles of mainline is completed.

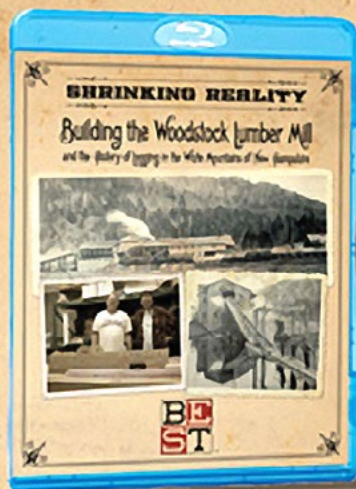

Recorded in  
**High Definition!**

Available in  
**Blu-Ray**  
or  
**DVD**

A Documentary on logging in the White Mountains of NH and tips on building models all in one!



**Bollinger Ederly  
Scale Trains**

[www.besttrains.com](http://www.besttrains.com)



**When talking  
to hobby  
vendors,  
please  
remember  
to mention  
MRH.**



contents



index

If you've been following the "Up the Creek" column, you've seen the layout change over the past five years – indeed, the BC&SJ was featured in the first issue of MRH back in January 2009.

Here are a couple of photos, one historical, the other a view of latest new track with me having fun with trains. Yes, the temporary Salem staging finally was moved and the construction crew was quick to extend the benchwork and mainline (upper) from Oakhill down to – and the Siskiyou branch (lower) up to – Bear Creek. My crew is eagerly anticipating this month's op session with a scale mile of new mainline in place.

The April 2014 MRH cover story will take an in-depth look at the 10th anniversary version of the BC&SJ. Horace Fithers tells me he "jest can't wait to see it!" Now if you'll excuse me, I need to make more sawdust and get some more track laid.

## Allagash Bash

To help celebrate our fifth anniversary, we're doing what we call an "Allagash Bash" the first 6 months of 2014. If you know anything about Mike Confalone's Allagash Railway, you will no doubt agree it represents some superb modeling that's not like what you see every day.

Even though Mike models 1970s Maine in the March-April timeframe, many of Mike's techniques can be used on any model railroading project regardless of scale or era. We hope to bring you some of the best of Mike's useful tips, techniques and modeling philosophy as we do our "Allagash Bash" over the next 6 months.

As far as MRH goes, we kick off the Allagash Bash this issue with a railfanning cover story on the Allagash. The railfanning adventure wraps up next issue in part 2.

Also this month on TrainMasters TV, we'll be featuring a special one-hour interview with Mike as we delve into his approach to the hobby, and his learnings while modeling the Allagash. This video also features a lot of fun eye-candy shots of Mike's layout with trains running through his outstanding scenery. Watch for it on TMTV around January 20th.

And that's not all! We also asked Mike to put together a definitive eBook on his Allagash, how he conceived it, how he has built it, and how he's doing his proto-freelanced roster. We also asked for Mike to get into how he built and prepared the layout for prototype ops, and how he does op sessions.

Having attended an Allagash operating session, I can tell you Mike's layout runs every bit as well as it looks. During an entire six-hour op session, I don't recall a single derailment!

## January 2014 Bonus Extras!

*Available to subscribers!*

**DVD and HD quality versions of the videos in this issue, plus:**

- **Zoomable Allagash Railway Track Plan**

[Click here to access](#)



contents



index

# 2014

## Looking For a Bargain? Look No Further!

*(while supplies last)*



*Click to see our ....*

**HO**

**DCC**

**ALL SCALES**

- Digitrax
- SoundTraxx
- Kadee
- NCE
- And more!



As Mike put this eBook together, it just kept growing, and growing, and growing – to become a thorough chronicle of how to do an effective model railroad.

As a result, this one eBook has turned into a four eBook series! We will be releasing one eBook per month over the next 4 months, and if you want to [pre-order the full series](#), you can get a great discount on it.

And that’s still not all!

In May and June, we’ll release Ops Live volumes 5 and 6 on the Allagash. We put several hours of Mike’s six-hour op session on video and we’ll be making it possible for you to visit this op session on video with us!

These videos will be available as DVDs and downloadable, and they will come to TMTV later in 2014 for TMTV subscribers.

This is all coming the first six months of 2014. We think



Staff notes - 4



contents



index



Mike Confalone's work represents state-of-the-art model railroading at its best, and we want to share it with you this year.

## MRH and digital publishing

In preparing for our fifth anniversary, we looked back to the earliest posts on the MRH forum and found some interesting discussions around our then-new approach to digital publishing for model railroading.

One reader expressed concern over how to consume digital MRH content and how much time it could take away from actually modeling. Joe Fugate posted the following to answer this question:

The way MRH will work is you can pick the level of involvement you want – there is no right or wrong way to approach it, since you have to be the judge what constitutes the best use of your time. If you try to take it all in, you are right – you won't have much time to actually be a model railroader.

Here are the levels of involvement I see people having:

1. Just read the magazine. Forget all the web site stuff.
2. Read the magazine and associated article comment threads. Forget the blogs and forums on the MRH site.
3. Read the magazine, associated comment threads, and read the blogs. Forget the discussion forums.
4. Read the magazine, associated comment threads, all the blogs, and all the discussion forums - and never get any model railroading done 'cuz your planted in front the dang computer so much!

If you're clever, you'll cherry pick – read the stuff that looks useful and ignore the rest.



contents



index

In terms of the most focused content – it's the magazine. I expect the comment threads associated with the articles will be some pretty focused material as well, along with good clarifying questions and answers.

The least focused content is the discussion forums - they can be all over the map, with lots of chaff - they're just an electronic version of a bull session discussion.

Blogs will tend to be more focused because they're orchestrated by one person, with attached comments.

I see no problem with just reading the magazine and avoiding the MRH web site because the signal-to-noise ratio is higher. The magazine gives you hobby information in its most concentrated form with minimal "all over the map" diversions than is possible on an unmoderated web site.

*Advertisement*

# Rslaserkits

Kits in all scales from O to Z and even some

**New HO scale small  
water tower perfect for  
small town on Industry  
water supply**

**Now in O and N scales  
Mispillion Lighthouse**



**Dealers welcome  
Salem, OR  
503-371-4290  
Sales@rslaserkits.com**



**Custom Laser Cutting  
and design**

[www.rslaserkits.com](http://www.rslaserkits.com)



Others expressed concern over how long MRH would be free. They obviously wondered if the free thing was to get you hooked – and then we'd start charging money for it. Joe Fugate replied:

The magazine needs to remain free for the business model to work.

By being free and you all doing your part by telling everyone you know about us and by shopping at our sponsors first – we will get the widest possible distribution and advertisers will consider us to be an essential part of their campaign to reach modelers.

Joe also outlined how MRH's digital format allows us to do things you just can't do in a paper magazine. Joe said:

Over time, I want our contributors to get used to the idea of including rich media goodies with their submissions:

*Advertisement*

Interested in O Scale?

THE

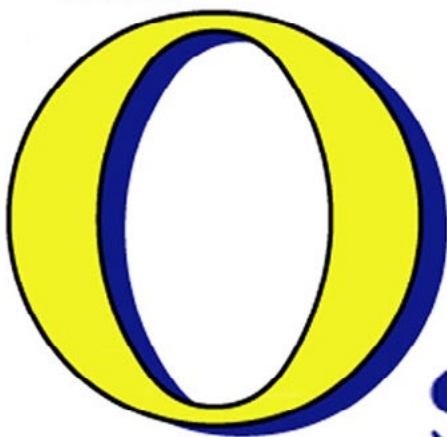

SCALE

RESOURCE<sup>®</sup>

[www.oscaleresource.com](http://www.oscaleresource.com)

Listings of O Scale manufacturers, dealers, and suppliers.



contents



index

- 3D virtual reality images (click-n-spins, easy to do)
- Short video clips (harder, but not that hard)
- Audio clips (not always applicable, but easy to do)
- Screen captures of things like Google Earth and SketchUp!

Literally dozens (or even hundreds!) of photos are possible with an article: you can just click through them powerpoint style.

We also predicted the common availability of HD video back in 2008. At that time, the only smartphone on the market was the newly-introduced iPhone and it didn't have video capability back then. Joe Fugate posted in 2008 on the MRH forum:

I predict HD video cameras will become like cell phones and in 5 years they will be everywhere.

This also means anyone who submits an article to our new mediaZine can easily shoot HD video footage to include in their article. *Model Railroad Hobbyist* is all set to deliver this kind of cool interactive media in our free mediaZine!

My how far we've come! Today, HD video in a smartphone or tablet is considered standard equipment – to the point they've almost killed the low-end digital video camera market!

So how about it guys? Build us an article and send along some phone photos or video. No need to do anything more complicated than that!

## **TrainMasters TV**

We launched Trainmaster TV (or TMTV for short) in November, and it's getting favorable comments by the subscribers. TMTV was the December cover story.

[... On to next page of text →](#)



## Combo Right Clamp™

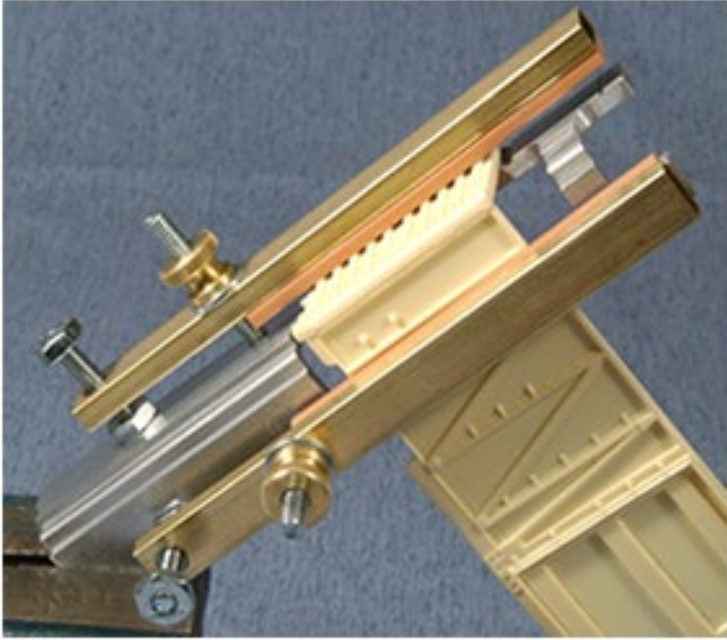

Combo Right Clamp™  
with cast resin boxcar

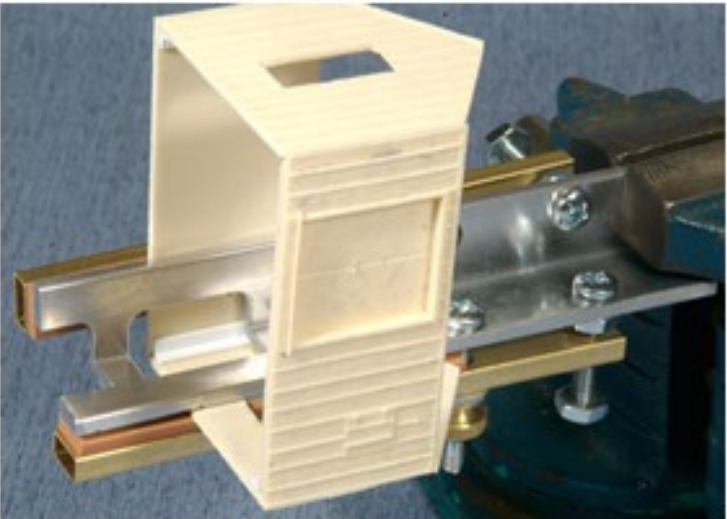

Combo Right Clamp™  
with Wolf Design Pump House

[Click here for  
all our products ...](#)

**Tools for Modelers**

Coffman Graphic Solutions Co.  
1500 River Circle, Richmond,  
KY 40475-7907

Remember  
You can click  
on the Email  
or Phone  
buttons to  
contact a  
sponsoring  
advertiser!

Also tell them  
“Thanks for  
sponsoring  
MRH!”



Email



Phone



contents



index

[← back to previous page of text ...](#)

For those who may be wondering what the relationship is between MRH and TMTV, TrainMasters TV is a separate company, with MRH being the sole distributor.

The MRH staff works closely with Barry Silverthorn of TMTV to coordinate content, with the goal being to help you do the hobby well, as TMTV says, one video at a time.

Because of the cost and effort needed to produce video, TMTV uses a no-ads, paid-subscription business model. If you're not sure you want to pay for a TMTV subscription, no problem, you can preview many of the videos for free.

Since it's only \$5.99 to subscribe for a month, you can try out TMTV and you can check out as many videos as you want. If you like what you see, subscribe for longer for as little as \$4.12 per month. Skip one Starbucks coffee and you have your entire monthly subscription cost paid for!

Barry of TMTV continues to post weekly acts on the site, building toward each monthly show. Each act is different, so there's something new to watch each week.

There's also a growing archive of how-to DVDs in our online library, so make sure you check it out.

## **This issue**

In this issue we celebrate our fifth anniversary with a rail-fan tour of Mike Confalone's Allagash Railway. Many of us have seen photos posted and articles about new industries added to the layout: The St. Regis Pulp & Paper Mill

[... On to next page of text →](#)



# TRAINMASTERS.TV

Coming in January...

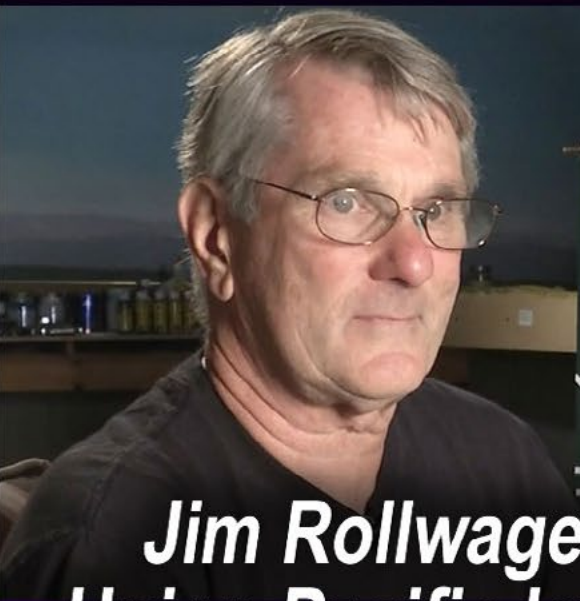

**Jim Rollwage's  
Union Pacific layout**



**DOCUMENTARY**



**Oak Ridge Horn Honk**

**BACKSHOP CLINIC**



**Chris Lyon on backdrop painting**

**BARRY'S BACKYARD**



**Barry Birkett's G scale outdoor railroad**

**BONUS INTERVIEW + LAYOUT FOOTAGE**



**Building the Allagash Railway (1 hour)**

**Visit TrainMasters.TV website ...**



[← back to previous page of text ...](#)

in [mrh12-04-apr](#), [mrh12-05-may](#), [mrh12-06-june](#) and The Allagash Gets a Quarry in [mrh12-09-sep](#) and [mrh12-10-oct](#).

Now we get a railfan tour of the layout through a fictional railfan trip. The photos in this article (and in part 2 next issue) show portions of Mike's layout that have never been published before.

Master Model Railroaders Ray and Renee Grosser build a unique piece of maintenance-of-way equipment: the Sheffield Velocipede used by railroads across the country in the early 1900s.

Matt Snell moves us into the modern era with modeling a radio base station. Radio communication has revolutionized the railroad industry and is a necessary detail on any modern railroad.

Have an old locomotive that needs tuned up? Dirk Reynolds provides instructions on how to upgrade a 1970s Athearn blue-box locomotive.

Ever wanted to know how to make molds and cast your own details? Terry Terrance shows us how to make our own unique details through molding and casting parts.

In our columns, we have our usual great lineup. In DCC, Bruce Petrarca describes the best way to safely install multiple speakers in a locomotive.

Mike Rose continues with part 2 of his layout reconstruction. In the conclusion, Mike gets the layout back to operational status. In a future *Getting Real* column, Mike will share about the scenery reconstruction.



Ken Patterson continues sharing great models along with his great photography in *What's Neat This Week*. Make sure and check it out, especially Ken's video. He puts a lot of effort into making superb video to go with his column and if you're not watching the video, you're missing some of the best parts of Ken's column.

We finish up this month with *Reverse Running*, thinking outside of the box with the proper foundation, as well as our famous (or should we say, infamous) Derailments, MRH's alleged humor and bizarre facts column.

Have a great read this month.

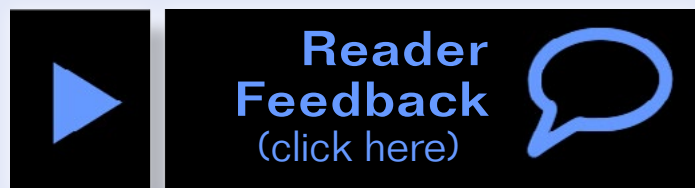

Advertisement



**1<sup>st</sup> choice for model railway supplies and service.**

**Expedited mail service available across North America.**

Click to visit:  
**WWW.CVRCO.COM**  
**1 800 464 1730**



# N



# The Power

## Overstated? Not at All



585.265.0230  
 9am-4pm EST.  
[www.ncedcc.com](http://www.ncedcc.com)

The Number  
 Rated DC

Our products are proud



# FREE Cover of DCC

All - DCC at its *Finest*

Number ONE  
DCC System

Call or Email  
for FREE Brochure  
[support@ncecorporation.com](mailto:support@ncecorporation.com)



Made in the U.S.A.



Email

Phone

contents

index

# MRH

## Questions, Answers and Tips

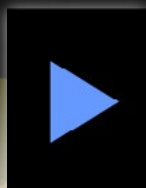

Reader  
Feedback  
(click here)



## QUESTIONS AND ANSWERS

### Bachmann ore cars

**Q.** Does anyone have info concerning Bachmann's 27' ore car (1), with square ends and sides w/large outside ribs? These are not the typical ore car as used in the Iron Range. I am trying to find out if they copied a prototype and if so, what manufacturer. I cannot determine how the car discharged its load as the sides have five large ribs, four small ribs, and there is brake gear on the bottom near the center of the car.

– Dave

**A.** I am not familiar with that model but it sounds like a former PRR or SP ore car, said Dave Husman. Search for "PRR ore car images" on Google or a railroad photo site. The PRR carried



taconite pellets to steel mills. The SP cars were used for ore and are now used for aggregate loading in Texas.

Reserve Mining, now called North Shore Mining, used this type of car, said Thomas G. They hauled iron ore-bearing rock, not pellets, to a mill on the shore of Lake Superior. Check out [mnopedia.org/multimedia/first-train-taconite-silver-bay-reserve-mining-company](http://mnopedia.org/multimedia/first-train-taconite-silver-bay-reserve-mining-company).

The Reserve Mining photo is dated 1955, making Bachmann's product pretty much a diesel-era car, or a new car in the very late steam era.

Bernd suggested [oil-electric.com/2010/10/whale-rail-connection-part-iv.html](http://oil-electric.com/2010/10/whale-rail-connection-part-iv.html) as a web site that has some pictures of the real ore cars that you have. There's lots of info here on a Brazilian ore-hauling line using North American-style equipment.

– MRH



**1: Bachmann's ore gondola works as a Pennsylvania RR prototype. Bachmann photo.**



contents



index

2

BALLAST  
4185 CUBIC YARDS PER MILE  
(BASED ON 24 TIES PER 39' RAIL LENGTH)  
SUBBALLAST  
2793 CUBIC YARDS PER MILE  
ADD 798 CUBIC YARDS PER MILE WHERE  
OFF-TRACK ROADWAY IS TO BE PROVIDED.

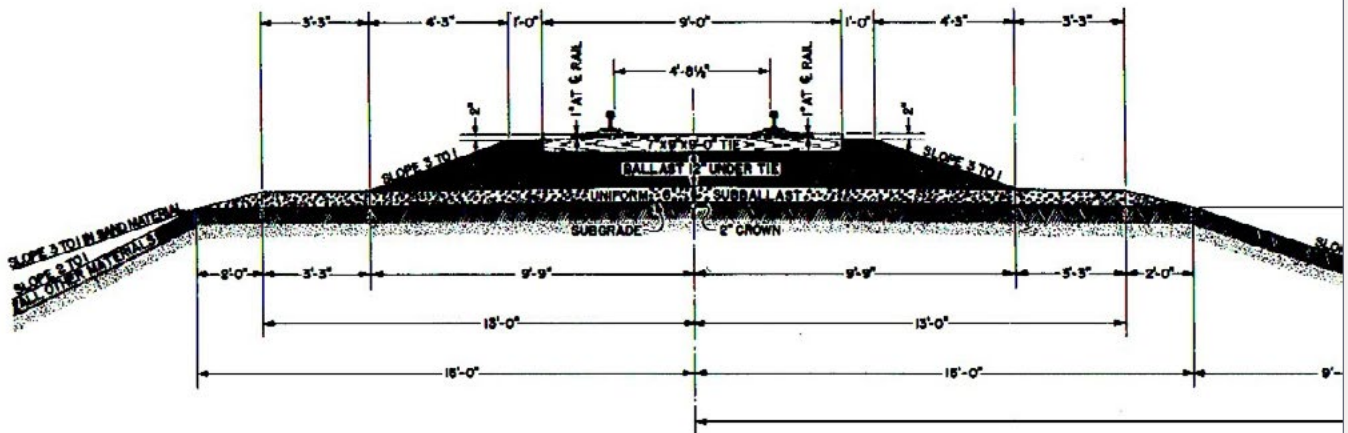

ROADBED SECTION

2: A mainline track profile is wide and deep.

### Ballast profile

Q. My flex track is mounted on cork ballast but the slope doesn't look like it does in train pictures I find on the web. Did I get the wrong product?

– Ernie G.

A. Cork roadbed is a perfectly acceptable material for model track, but your work doesn't end there. The next step is to apply ballast, available from companies like Woodland Scenics and Arizona Rock & Mineral.

There are dozens of how-to articles on the Internet. Search for "model railroad ballast tutorial" and take your pick. What the videos and articles rarely tell you is how much ballast to apply, and what sort of slope the edges of the finished roadbed should have. Railroad historians and historical societies have made this kind of information available, and the prototypical slope is more gradual than what's usually seen on model railroads.

There are a couple of key dimensions in the main line profile (2). Note that the ballast should be about 2" lower than the top of the cross ties, not level with them. The diagram shows 12" of ballast under the ties, and a uniform 6" of sub-ballast below that. The sides are sloped at 3:1, and the roadbed extends for a foot on either side of the ties before it slopes off.

Not too many modelers are going to work to those exact dimensions, but it gives you the proportions of how main line track would have looked at the time of this 1979 diagram. A branch line profile (3) is a little different. There is only 8" of ballast under the ties, and only 6" beyond the end of the ties. The edge slope is the same, 3:1, and there is still a 2" layer of larger crushed rock under the bed of ballast. For a point of comparison, the mainline spec called for 4185 cubic yards of

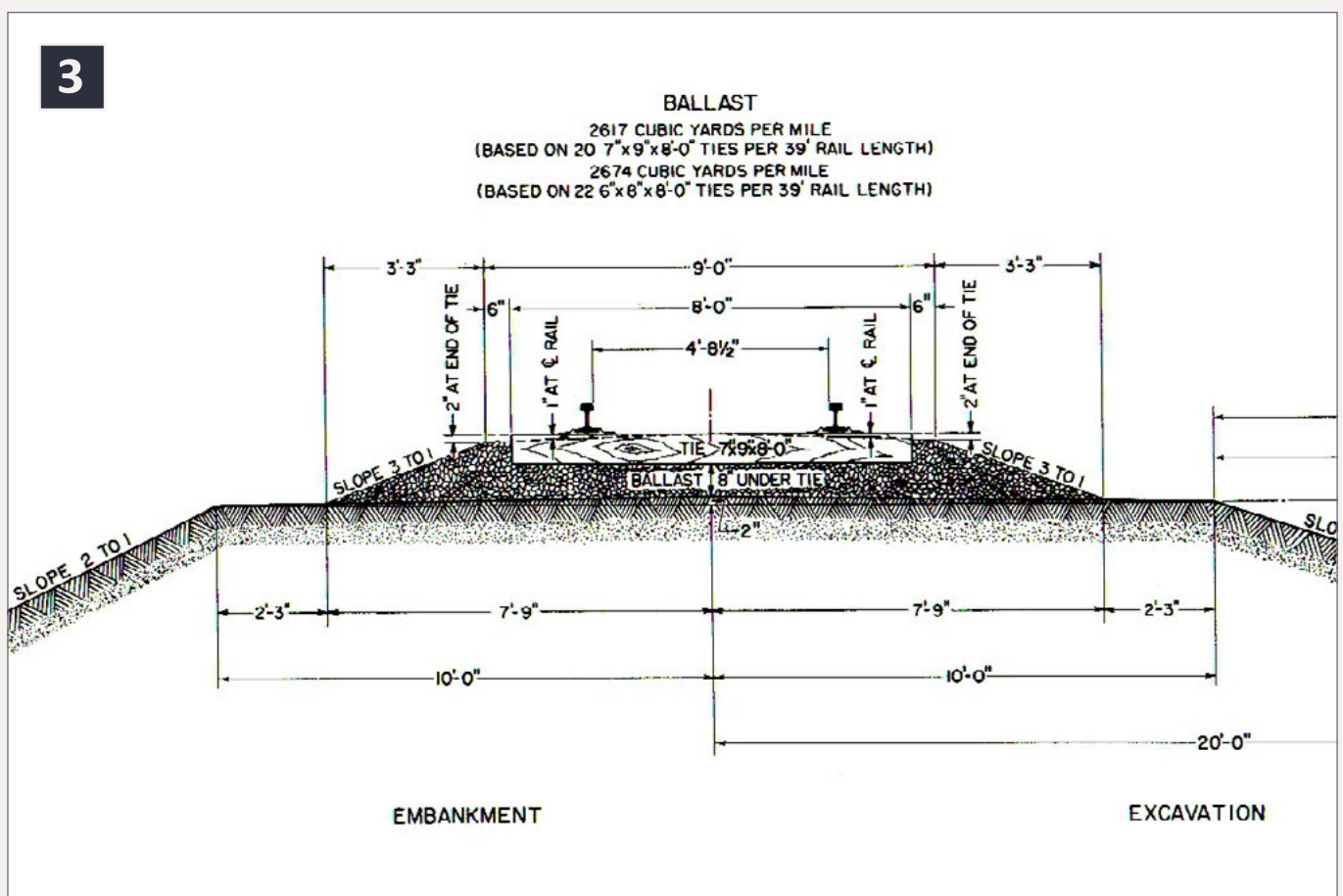

**3: Branchline track uses less rock and is rated for lower speeds.**



contents



index

ballast per mile. Branch line track would use only 2617 cubic yards for the same distance.

All of this is generic data. Dedicated prototype modelers can track down what “their railroad” did through old engineering documents or historical society publications.

Arizona Rock & Mineral: [rrscenery.com](http://rrscenery.com).

Woodland Scenics: [woodlandscenics.woodlandscenics.com/show/category/ballastandcoal](http://woodlandscenics.woodlandscenics.com/show/category/ballastandcoal).

## Using Krylon Matte spray

**Q.** I have my powders and water-based paints to do my weathering. I was going to try the powder and 70% alcohol mix, Elmer’s white glue and powder, and mix powder with paint. I’ve seen people using Krylon Matte finish instead of



**4:** Accurail hopper cars painted using Krylon spray cans.



## Testors Dullcote. Should I spray the car with the matte finish before I add the powder and paint and then again afterward to seal it?

– Roundhousecat

**A.** Two questions here. We'll talk about paint brands first. A couple of experienced readers, Dave Branum and 'Bing,' aren't satisfied with Krylon sprays for HO models, though they say they're OK for larger scales. They suggest using Testors Dullcote, in either a spray can or with an airbrush. They say the coarse spray from the large Krylon cans can block up details and put too much paint on a model.

“In trying various spray paints in the rattle-cans, I have found Krylon to be a heavier paint than Testors. In other words, Krylon tends to go on thicker and tends to hide details such as rivets and details that are not very high above the body surface,” Bing said. “I have tried Krylon in the past, and now have a few, very few thankfully, to strip and redo. I find that Testors is a thin paint and is much better. Of course, an airbrush allows you to control the paint density for much better coverage.”

Model Masters Flat Clear Acryl is also a good matte finish. But, when handled carefully, Krylon can give good results. The cars in the photo (4) were sprayed with indoor/outdoor Ruddy Brown primer, a light coat of Crystal Clear gloss, and, after the decals had set up, with Krylon 1311 matte finish. Work in a warm environment, shake the can very vigorously before spraying, pause between light fogged coats to check the effect, and you're good to go. Running the spray can under a hot water tap also helps to spray a thin, even coat.

Before any clear-coating, the car sides were lightly wet-sanded with 400-grit paper to get the desired level of “show-through”



contents



index

of the old lettering. The cars were then decaled. Krylon does not produce the tight, glossy finish of Scalecoat, Modelflex or Tru-Color, but is more than acceptable in the right application.

The second question is about applying chinks. Chinks and other weathering powders cling better to a rough surface than to something that is slick like clean plastic. A light coat of dull finish helps the dry weathering to stick, and the finished product can be sealed with another light coat of clear matte spray.

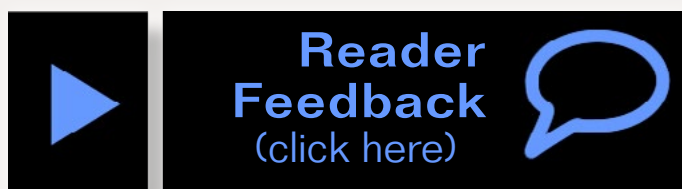

## TIPS

### Poster putty

Try using poster putty (5) to hold those pesky small screws to your screwdriver when attaching your coupler pockets. I also use it for temporary mounting of HO people on my layout until I am sure I like their placement. Use it to hold small parts on a piece of wood or cardboard for painting. The uses are endless!

– Dave Dexter

### Lint roller

The other day as I dropped a small part on the carpet and could not find it, it dawned on me that I could use a lint roller to pick up the part. Getting the part was super easy.

In the past I would spend 15 minutes looking for a small part, laying with my head sideways trying to see it! The dogs always wondered why I would do this. Anyway, by simply

5



## 5: Poster putty has model railroad uses.

running the lint roller over the carpet, it picked up the part I lost, and a few other things that I had dropped before.

The Scotch-Brite lint roller works well for about \$3.69. It comes with more than 50 sheets so it lasts a long time. I will share the cash with my dogs, as it was their lint roller I used.

– Marty Petersen



## GET \$25 PER TIP

We pay \$25 USD for each tip we publish.

[Send your modeling tips to Model Railroad Hobbyist](#) and we'll get payment to you upon acceptance.

Just think, for only a few minutes effort, you could fund your next piece of rolling stock – or even pay for an entire train if you send in several tips and we publish them!

If you include any photos with your tip, we pay a bonus of \$10 per photo we use with the tip. ■



contents



index



# Digitrax No Worries Warranty

That's it! A simple, straightforward warranty with no tricky language



You're protected against

Learn

Need tech support?

[www.digitrax.com/contact](http://www.digitrax.com/contact)

Need a repair?

[www.digitrax.com](http://www.digitrax.com)



**NO WORRIES  
WARRANTY**

**... Keeps Your Layout Running!**

**... for one year  
...!**

**... defects and accidental damage.**

**... more at: [www.digitrax.com/noworries](http://www.digitrax.com/noworries)**

[www.digitrax.com/repair](http://www.digitrax.com/repair)

**Need a throttle conversion?**

**[www.digitrax.com/upgrade](http://www.digitrax.com/upgrade)**





# Southern Digital

*Specializing in DCC Since 1992*

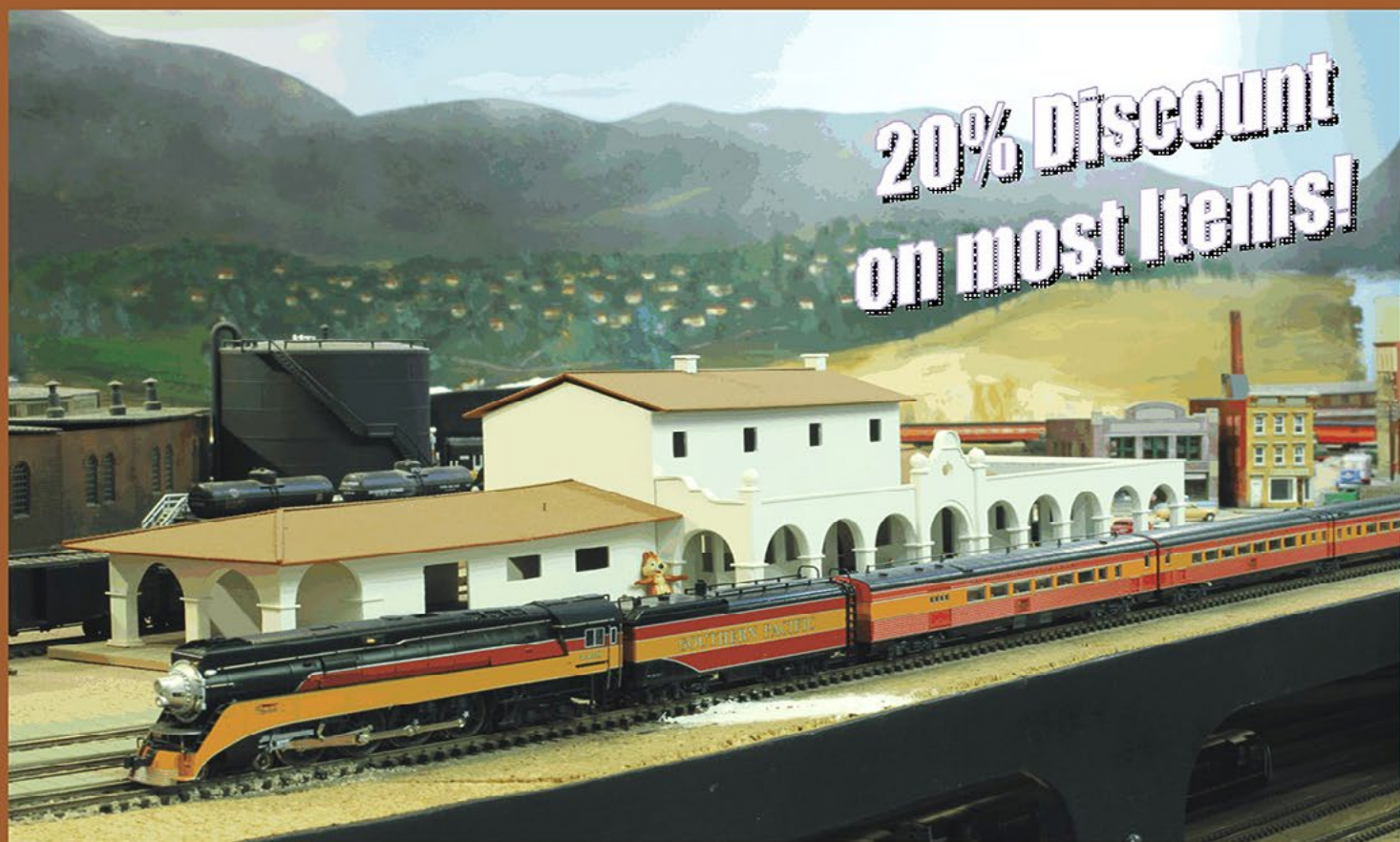

**20% Discount  
on most items!**



## DCC Conversions & Service

Orders Received by 3:00 pm EST ship the same day

**WWW.SODIGI.COM**

E-mail: [sales@sodigi.com](mailto:sales@sodigi.com)

(770) 929-1888

*(Photo's are from our N-Scale layout)*





# How to safely connect multiple speakers

More speakers = more sound

**DCC Impulses column**  
by Bruce Petrarca



## Getting more sound out of your DCC locos

**T**he acoustic design of sound DCC decoder installations is frequently challenging. Getting the right baffling or enclosure is important. See my August 2012 column, How Do I Get The Sound Out ([mrh-2012-08-aug/dcc\\_impulses](http://mrh-2012-08-aug/dcc_impulses)), for some of the basics. What I'm offering in this column is another tool in the toolbox, multiple speakers.

There are several reasons for wanting more than one speaker in an installation:

- Better bass reproduction – doubling the number of speakers can add an octave of bass. One speaker upgraded to two is frequently good; two to four can help; more than four is usually a lost cause.
- Adapting to the available space is sometimes easier with two (or more) speakers - two rectangular speakers in the hood of a road switcher diesel or a small car (1) are frequently possible and usually sound good.
- Distributing the sound over several units, such as:

- Steam loco and tender - in reality tenders don't make much noise, but they are one of the best places to put speakers in models.
- Multiple diesel units with a single sound decoder - "MU hoses" can carry audio between units to distribute the sound across a lash-up.

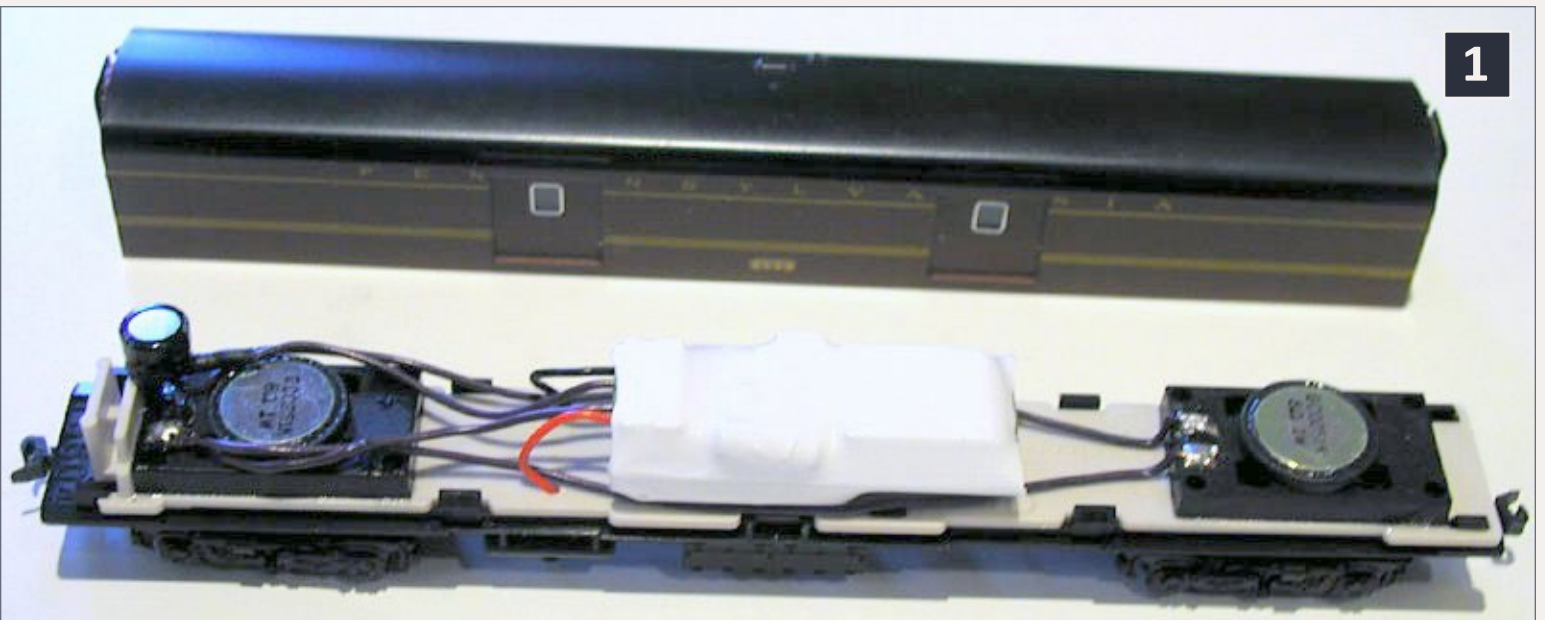

### 1: N-scale Kato baggage car with (an older) DSX sound-only decoder and two speakers to improve bass response.

Starting out, let me say that I'm going to deal with multiple identical speakers in this column. I've tried larger (woofer) and smaller (tweeter) speakers with crossover networks in models. Even in G scale, where I could use a 4" in the tender and a 1-1/2" in the smoke box, I found the results were less than what I wanted and certainly not worth the effort or expense. In that case, the 4" provided a depth of sound that was only diminished by trying to add a "tweeter."

## Decoder specifications

Your decoder was designed to provide a certain amount of audio power into a specific load impedance. A very common



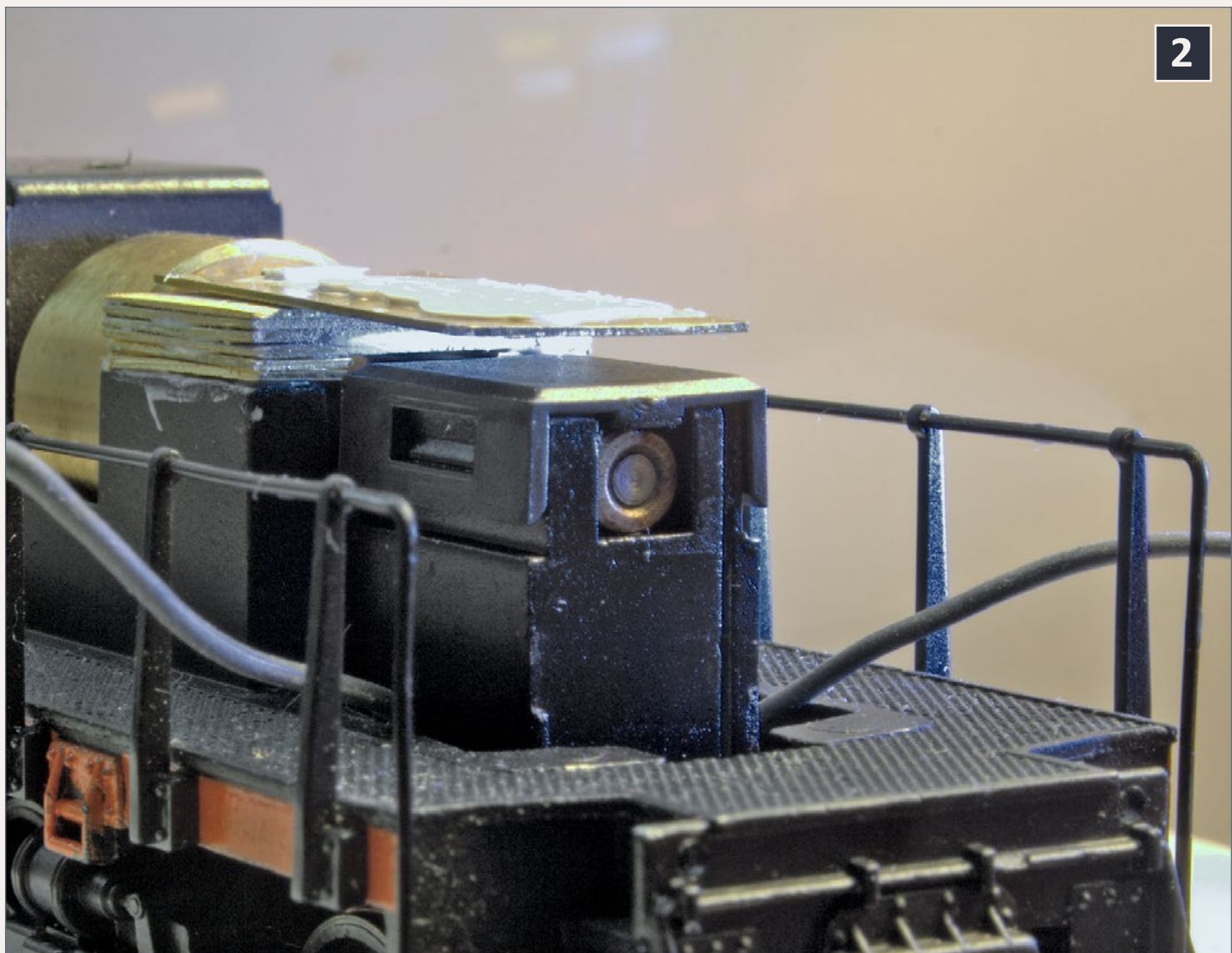

**2: Atlas HO scale S-2 loco with brass riser and plate for mounting a TSU-750 Micro Tsunami decoder. The brass conducts the heat from the decoder into the frame of the loco and is glued together with thermally conductive epoxy.**

rating is 1 watt into 8 ohms. Does this mean that you can't have different load impedances? No. But the amplifier will change based upon the load. Some of these changes may be good. Some may be fatal to the amplifier or the speaker(s).

Lower impedance (4 ohms, for example) will increase the load on the amplifier, making it work harder. It may be able to provide more power into the lower impedance: for example 1.5 watts into 4 ohms. The cost of this increased power is more



heat in the amplifier. This added heat can damage or destroy the decoder, depending upon the amplifier design.

Higher impedance (say 16 ohms) will reduce the load on the amplifier, but the amplifier may not be able to push as much power into the lower load: 3/4 watt into 16 ohms would be a common result. Generally, higher impedance loads are not harmful to the decoder; you just reach a point where the diminished audio power isn't compensated by the increased efficiency of adding more speakers.

I recommend checking with the decoder manufacturer before you contemplate any impedance other than the rated load, be it a single value or a range of loads.

3

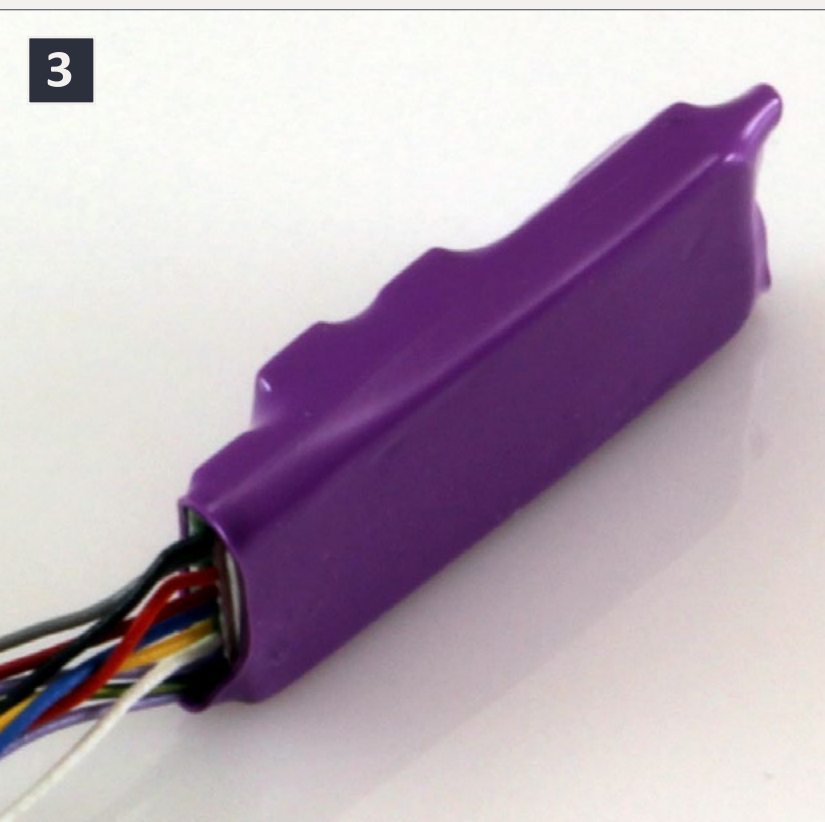

**3: TSU-750 Micro Tsunami, showing flat side where the internal heat sink is located. This should be attached to a metal surface to remove heat from the decoder.**

## Heat

Be aware, as we make smaller and more powerful (both electrically and feature-wise) decoders, heat generated inside the decoders becomes more of an issue. How the heat will get out of the decoder should be a design criterion in every installation. With small sound decoders, it becomes very important. If you are contemplating pushing the envelope on load imped-



**4: Line array of four identical speakers - wired in a series-parallel combination, the resulting unit is rated at 8 ohms and 8 watts.**

ance (4 ohms on a decoder rated for a nominal 8 ohms), then heat may become an even bigger issue.

Figure 2 shows a mounting plate for a TSU-750 micro Tsunami I built out of brass sheets held together with thermally conductive epoxy (see my December 2012 column - [mrhmag.com/dec-2012-dcc-impulses](http://mrhmag.com/dec-2012-dcc-impulses)). Brass sheets (0.032" thick) were cut to the size of the top of the frame where the driveline went between the motor and the front gear tower. They are stacked up until they are tall enough to clear the gear tower at the limits of its height when pivoting and swinging. Then a single sheet is glued extending forward to provide a decoder mounting location. In the photo, a bit of white epoxy is visible where the decoder mounts. I had previously mounted a decoder on this stack, and removed it by light prying. The Alumina Thermal adhesive broke cleanly away from the decoder shrink tubing. A dab of thermally conductive epoxy and the decoder will be back in place – flat side against the brass plate.

So how does this work? The components inside the decoder that need to be cooled are connected through thermally conductive foam to a metal plate that is held in place with the



shrink tubing inside the decoder wrap. That makes one side of the decoder flat. This flat side (right side in 3) is held down to the brass plate (2) with thermally conductive epoxy. The heat is conducted from the decoder into the brass plate and into the frame of the locomotive. The heat that is conducted away in this fashion will help keep the decoder cool.

With that technical stuff aside, let's get started planning an installation.

## What will physically fit?

Sometimes things just work out. When you open up a loco to put sound into it, you find a pre-made opening for a standard size speaker (or two) and you are good to go. But that's not always the way.

When converting older locomotives, frequently the installer is left with the task of designing the acoustics as well as the normal issues of an installation.

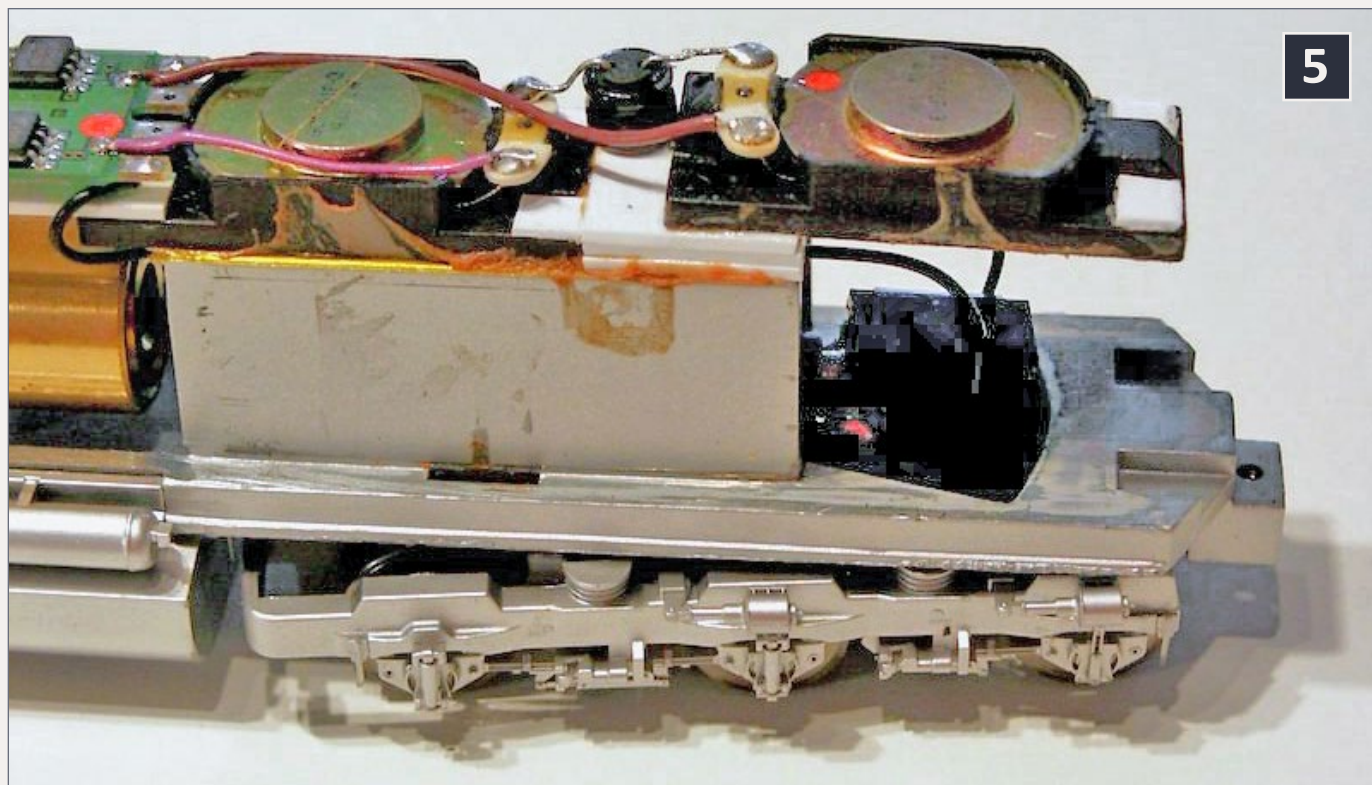

5

**5: Two 16 x 35 mm speakers in an HO scale Athearn Genesis SD75M.**

For example, I was asked to install sound into an O-scale F3A. The top of the shell had a lot of fan grille openings, but the space below them was a long rectangle. To maximize the sound, I used the array shown in (4). A total of 4 (27 mm diameter round high-bass) speakers were assembled onto a sheet of thick (0.08 to 0.10" thick) black plastic. This was sealed to the roof of the locomotive so that the sound would be forced out the top of the loco and the negative pressure (see my August 2012 column [mrhmag.com/aug-2012-dcc-impulses](http://mrhmag.com/aug-2012-dcc-impulses), if you don't understand the term) gets routed through the loco and out the openings for the trucks.

Similarly, I had room for two 16 x 35 mm rectangular speakers in an Athearn Genesis SD75M HO-scale locomotive, as shown in (5).

Okay, once you decide on what sort of acoustic baffling you are going to use and what size speakers will fit, it is time for the electronic side of the design.

*Advertisement*

# END OF TRAIN DEVICE



**Bright Red Flashing Light!**

Installs in minutes with no freight car modification required!

**RE RING**  
ENGINEERING

Patented Technology - US Patent 7,549,609

**Does not affect Load!**

↓ Car without Load ↓

↓ Car with Load ↓



For video and more click here!



# Impedance

You now know what impedance your decoder wants to see and what range it will tolerate. You also know how many speakers you want to use in your installation. For the purposes of this column, I'm going to assume that you are using a decoder that is designed for an 8-ohm load and will tolerate any load between 4 and 16 ohms. So my goal is to provide as close to 8 ohms as possible and not to go outside the 4 to 16 ohm range. See Mr. DCC's Workbench at the end of this column for more insight into speaker specifications.

There are two ways to wire two electronic elements: series and parallel. How you wire multiple speakers will determine what the total impedance seen by the decoder will be.

Series wiring is where all of the electrons go into one unit and come out and go through the second unit. When you wire two identical speakers in series, the impedance doubles: two 8-ohm speakers in series will be a total of 16 ohms. With three identical speakers in series, the impedance triples: three 4-ohm speakers in series will yield 12 ohms.

Parallel wiring is where the electrons split and part of them go through each unit and they join up together afterwards. Wiring identical speakers in parallel will halve the impedance: two 8-ohm speakers in parallel will provide a load of 4 ohms.

# Polarity

If you are only wiring one speaker to a decoder, the polarity markings on the decoder or speaker are meaningless. Just hook them up and go.

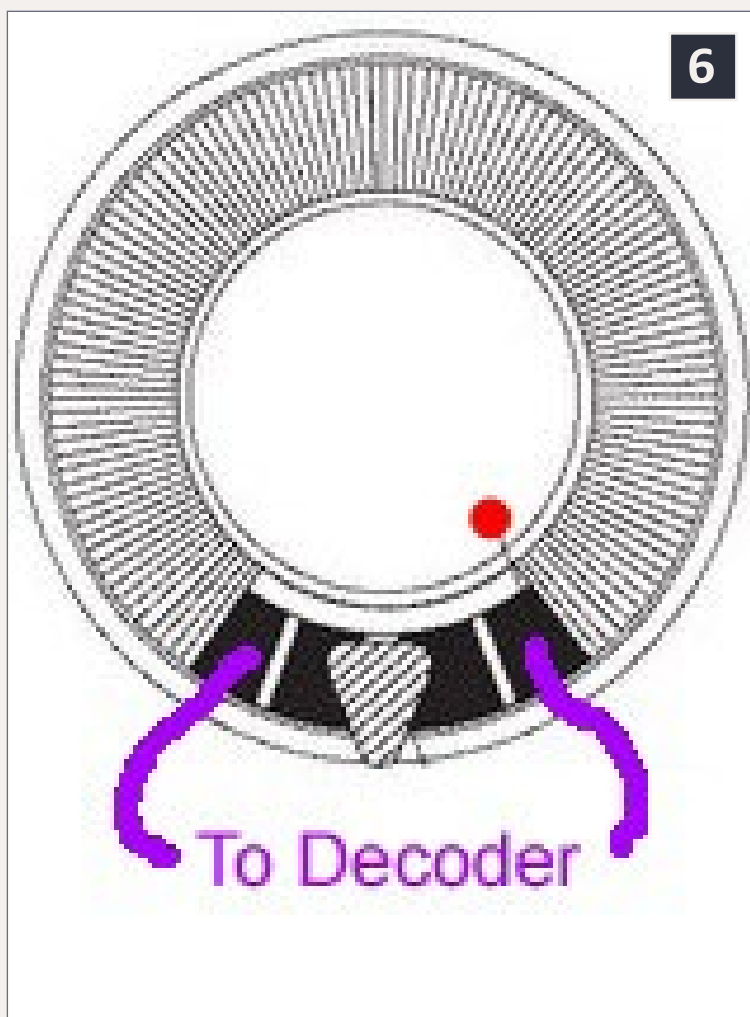

While there are times when you want to intentionally wire speakers out of phase, they are few and far between in model railroading. So, I'm going to discuss how to have the speakers be in phase – meaning that all the cones go in the same direction at the same time, effectively doubling the size of the speaker.

If you have any questions, try an experiment. Hook two speakers up in phase and listen. Reverse the leads to one speaker (making them out of phase) and listen. You will probably hear a reduc-

**6: A speaker with a polarity mark (red dot in the drawing). The speaker probably will come with one. If not, you may add your own.**

tion in the low frequency (bass) reproduction and a loss of directionality of the midrange and high frequency sound. The sound will frequently appear to be in a large ball surrounding the locomotive, as compared to a point source between the speakers.

Over the years, I've only had one installation where I intentionally wired the speakers out of phase and it was for two switchers separated by a flat car with a speaker in each loco. The "ball



contents



index

of sound” worked better than the point source located in the middle of the flat car in this instance.

Speakers are usually marked as to polarity. If you look at the terminals on the (identical) speakers you are installing, you will probably find some mark next to one of the terminals. It may be a drop of paint or a variation in the shape of the terminal or something. Absent any other indication, just line the speakers up on your workbench, cone side down with the terminals facing you. Take a marker and put a dot next to the terminal on the right. Now you have a mark to use in wiring the speakers.

## Two speakers

Be sure to know the allowed range of load impedance before selecting and wiring two speakers. Why? As I mentioned previously, when

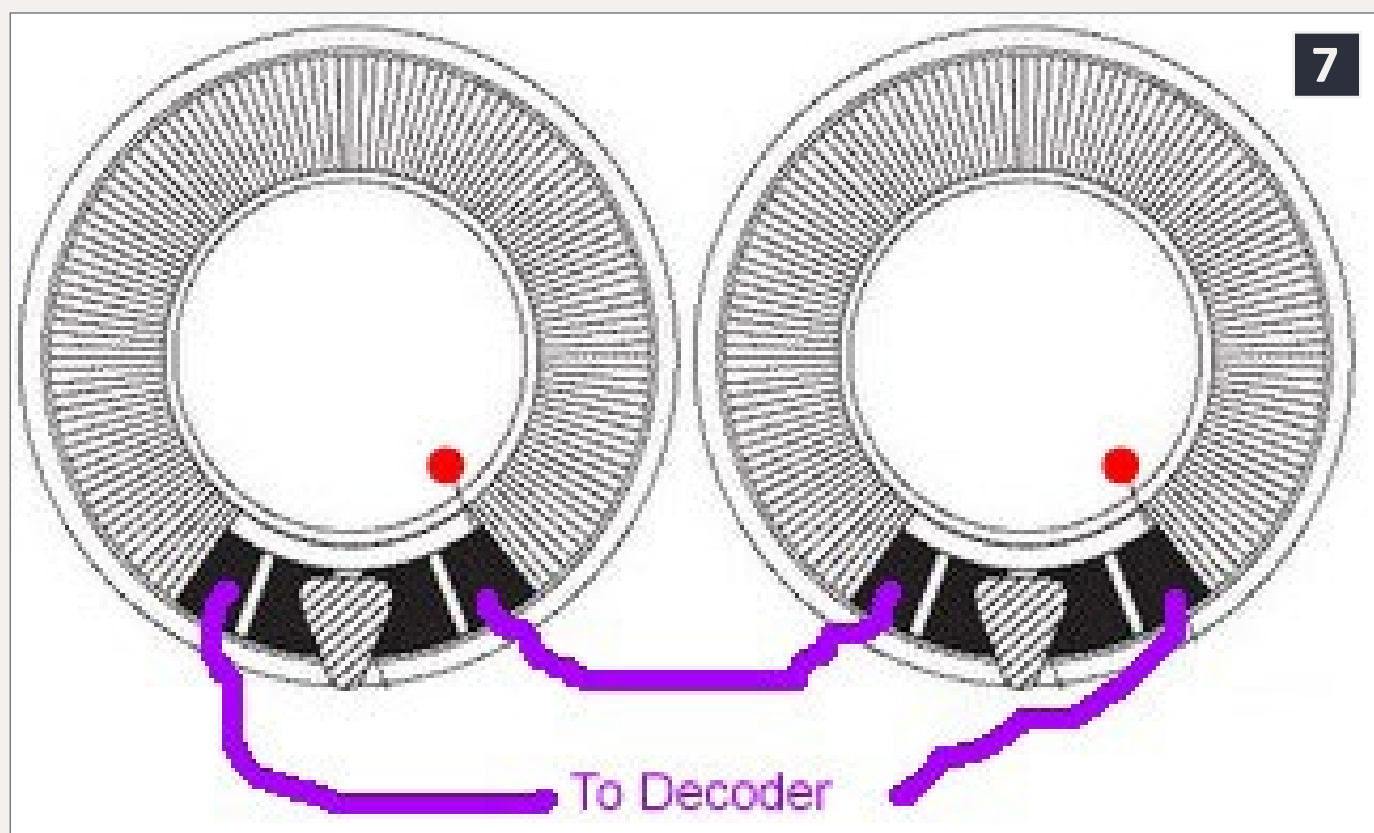

**7: Two speakers wired in series – the final impedance will be twice the speaker rating – 8-ohm speakers yield a 16-ohm load or 4-ohm speakers yield an 8-ohm load.**



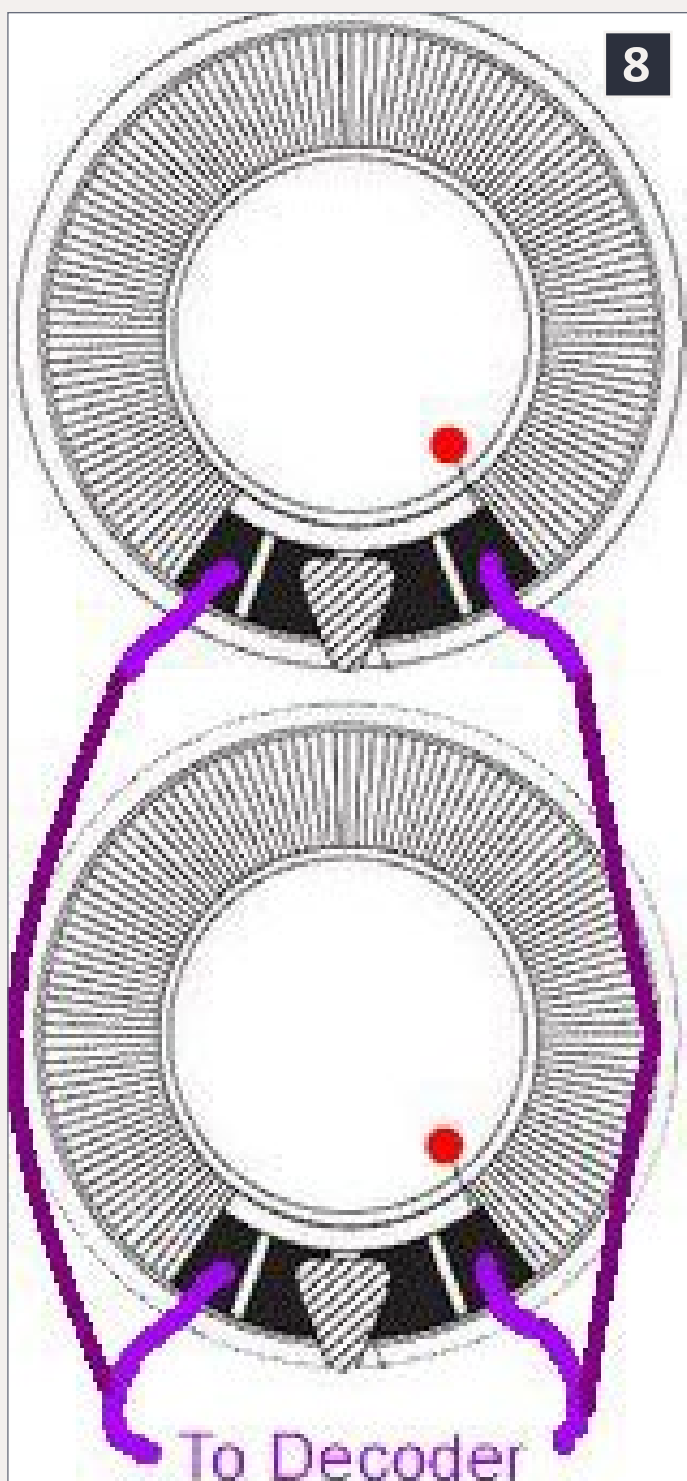

**8: Two speakers wired in parallel – the final impedance will be half the speaker rating – 8-ohm speakers yield a 4-ohm load.**

If you cannot find a 4-ohm version of your desired speaker, then use an 8-ohm version and still wire them in series. This will give a 16-ohm load that is usually better for the decoder.

wiring two speakers, you have two choices as to final impedance: double or half the impedance of each.

So, let's look at a decoder that likes 8 ohms, but will tolerate 4 to 16 ohms. If you are really lucky, the speaker size you planned on will be available in a 4-ohm version. Since LokSound has designed their decoders for a 4-ohm target, there are more and more 4-ohm speakers showing up in the DCC shops. That's great. Wire two 4-ohm speakers in series and you have 8 ohms, as shown in (7). Note that the connection between speakers goes to the marked terminal on one speaker and the unmarked terminal on the other. This is how the speakers are wired in figure 5. Don't worry; there is a capacitor between the two speakers instead of a wire, as the older decoder needed a capacitor. Modern decoders would just use a wire.



contents



index

One exception to this idea is the current version LokSound decoders (or others) that actually like 4-ohm loads, so wire the two 8-ohm speakers in parallel, as shown in (8). That's why I suggested you find out what your decoder likes and what it will tolerate before you start.

## Three speakers

Three 4-ohm speakers in series, as in (9), will yield 12 ohms which will work just fine with almost all decoders designed for 8 ohms. I did this in a brass HO-scale Overland narrow hood diesel and the results were amazing.

## Four speakers

The four speakers shown in (4) were wired in a series-parallel fashion. That is, two sets of two speakers are wired in series, as shown in (7). Each series group has twice the impedance as the original speakers. Then these groups are wired in parallel, making the final impedance exactly what the speakers started with.

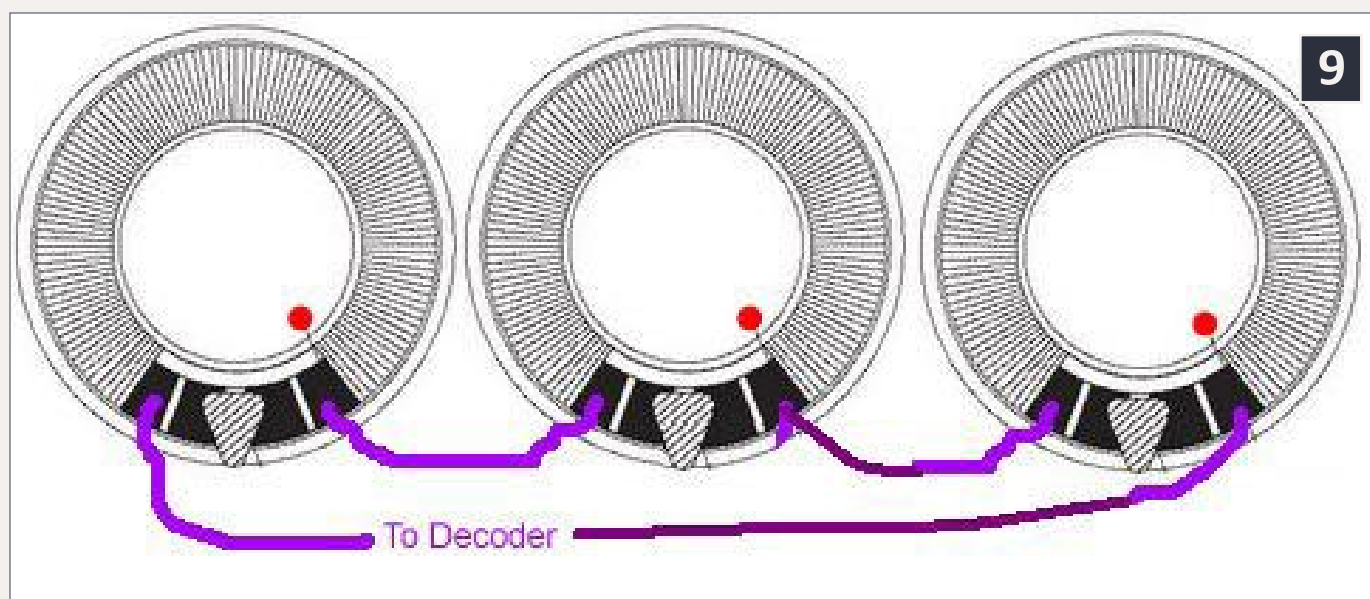

**9: Three speakers wired in series – the final impedance will be three times the speaker rating – 4-ohm speakers yield a 12-ohm load.**

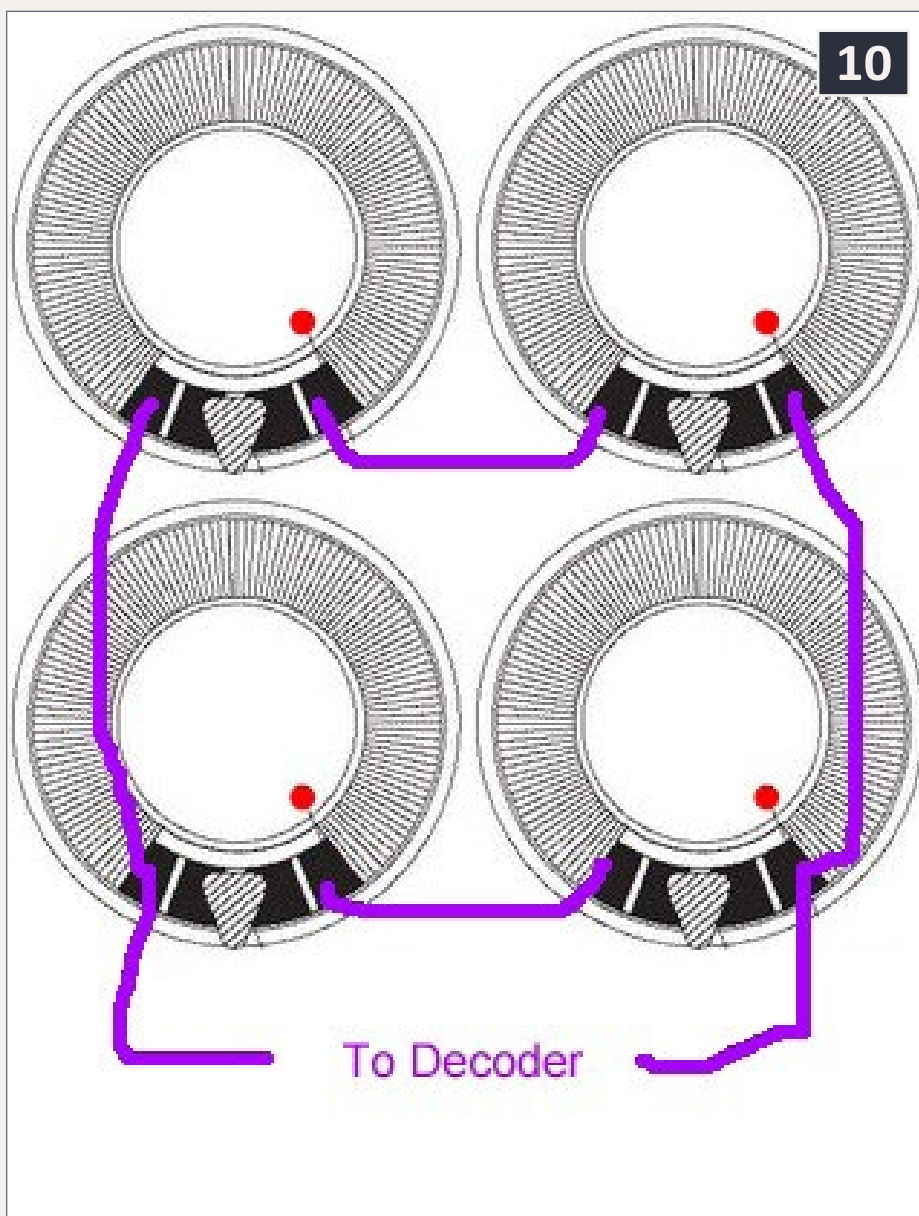

10

So, four 8-ohm speakers wired this way will yield an 8-ohm load. The wiring diagram is shown in (10).

## Power rating

While it is usually not an issue, most speakers are rated for one watt of power and most decoders will only put out a watt or two. The total power rating of an array of speakers will be the rating of the individual speaker times the number of speakers in the array. For example, three 1-watt speakers in an array will handle 3 watts.

So, now you can see how speakers can be matched to the specifications of your

**10: Four speakers in a series-parallel array – the final impedance will be the same as the speaker impedance – 8-ohm speakers will yield an 8-ohm load.**

decoders. For a bit more in depth on speaker specifications, check out this month's Mr. DCC's Workbench. There is a bunch of data on my web site. I suggest you start at the speaker page [mrdccu.com/curriculum/speakers.htm](http://mrdccu.com/curriculum/speakers.htm) and work from there.

If you found this column helpful, please click on the Reader Feedback link here and rate it awesome. Please join in the



contents



index

conversation that invariably develops there about the topics presented in the column. Share your experiences. Thanks.

Until next month, I wish you green boards.



**NEW!**

**DCC Train Shuttle ... aka, "Prof Silencer"**

**TamValleyDepot.com**



### NEW! Tsunami® TSU-GN1000 for Athearn Genesis ES44AC (GEVO) Locomotives

Featuring the GE GEVO-12 prime mover and all of our great Tsunami features!

- Designed for 1.5V bulbs - No resistors needed
- Realistic sound, lighting, and motor control
- Manufactured in the U.S.A.

Visit the TSU-GN1000 Web Page



# Get Better Sound from your Locomotives

Can't get a good sound from your sound decoder?  
Give our speakers a test drive with your ears.



**RAILMASTER HOBBIES**  
**9815 WALNUT ST #106**  
**BELLFLOWER, CA 90706**

Bass Reflex  
Speakers



High Bass  
Speakers



When it comes to speakers we have high quality speakers to fit many different applications. We are also a full line hobby shop. Need anything? We are an authorized dealer for Soundtraxx, Digitrax, Athearn, Walthers and many others. We provide quality speakers for your DCC sound systems and quality service.

**Click here for  
the *sound* answer ...**



# From Mr. DCC's workbench

## – Speaker specifications

In this column, I've discussed speakers as if they had constant impedance, for example 8 ohms. They don't. Figure 11 shows a plot of impedance vs. frequency for a typical 8-ohm speaker. While this speaker would be too large to fit in our locomotives, the concept is what is important. How do I know that this speaker is too large? It has a resonant frequency in the 35 Hz range. Since one of the major contributors to this resonance is the size of the cone, and speakers that fit in locos resonate from 100 to 400 Hz, this speaker is too large. It's just a matter of physics.

What is important to see is that this "8-ohm" speaker ranges from about 6-ohms to 50-ohms. So the decoder will not be seeing exactly 8 ohms at more than a few frequencies. It will be close, though. If you measure this speaker with a DC ohmmeter, you will probably get a reading around 5 or 6 ohms.

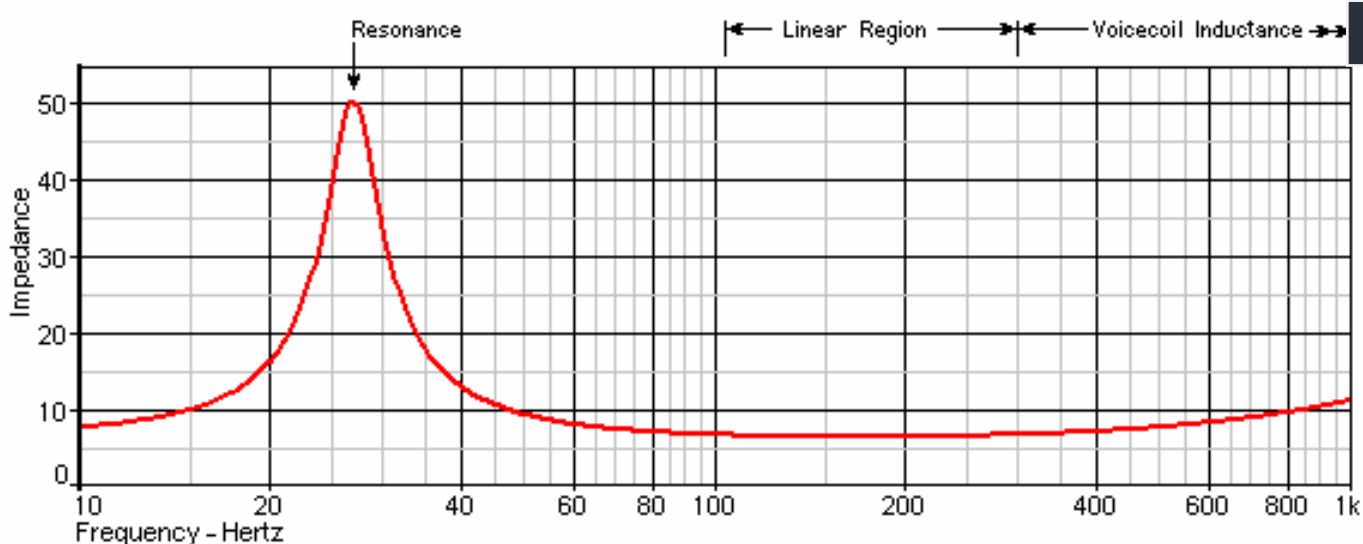

**11: Impedance vs. frequency for a typical 8-ohm speaker, showing a resonance at about 35 Hz.**

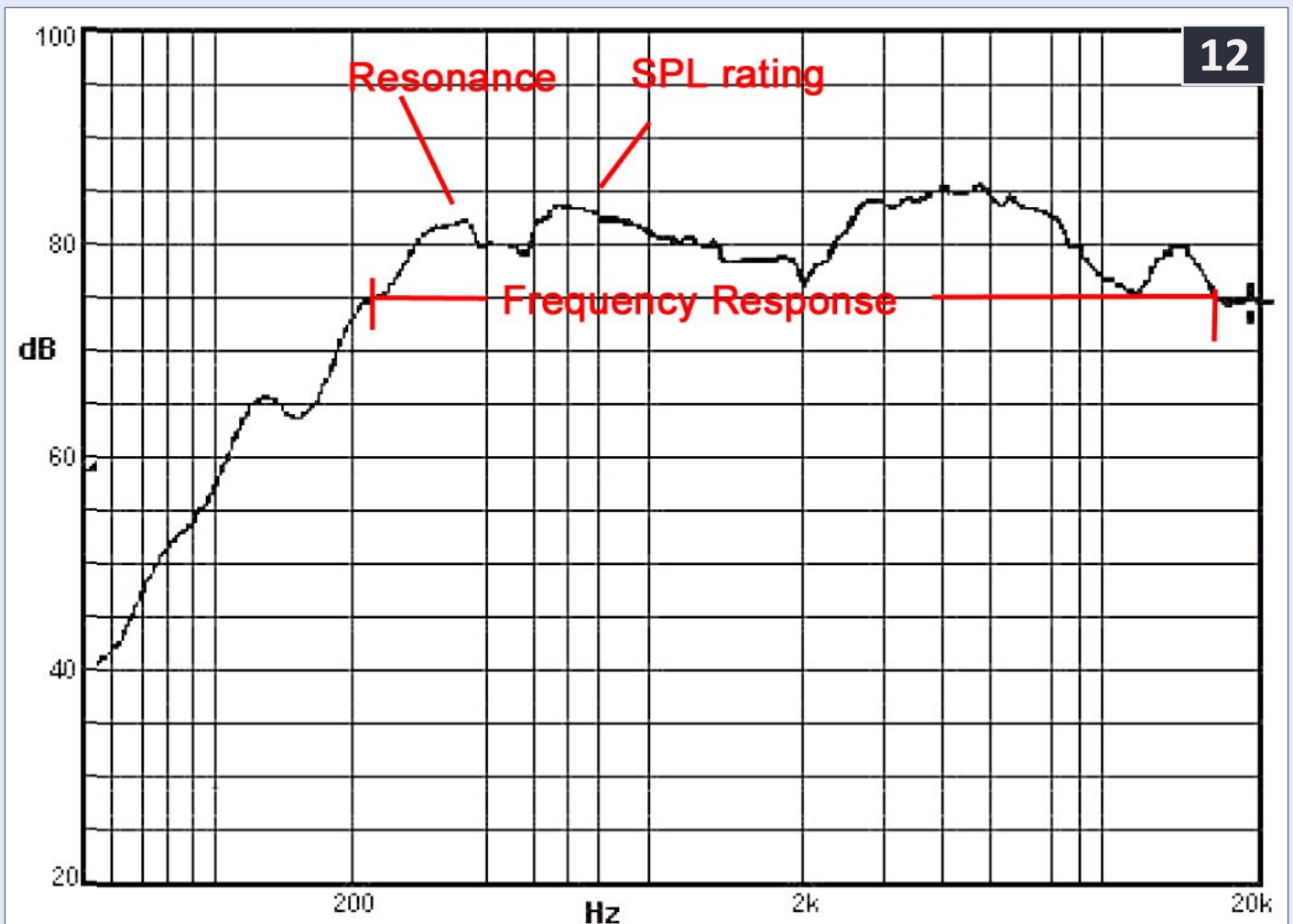

## 12: Frequency response (sound pressure level or SPL vs. frequency) of a typical speaker used in model railroading (28 x 35 mm – 8 ohms).

Another specification of speakers is frequency response. One might expect a nice smooth response, not what you see in 12.

There are several sound-related specifications to take away from this chart.

First, the resonant frequency is the bump about 350 Hz. The lower this number is the better the bass response.

Secondly, the Sound Pressure Level (SPL) rating is usually calculated from the average of the output level at several frequencies around 1000 Hz. This speaker is rated at 82 dB. The larger this number, the louder the speaker will be.





contents



index

Frequency response is usually calculated as the frequencies where the curve drops below a level 10 dB below the peak. This speaker peaks about 85 dB about 4000 Hz. So, the places where it drops below 75 dB will be the frequency response (about 225 Hz to about 16,000 Hz). ■

 **Reader Feedback**  
(click here) 

**Wire a Tortoise without solder? Really?**

**BERRETT HILL TRAINS**

[www.berrethillshop.com](http://www.berrethillshop.com)

**What will they think of next?**

  
**Email**

  
**Phone**

**RailPro™** **NEW TECHNOLOGY**

**DIRECT™ RADIO**

**RE RING™ ENGINEERING** **NEW Starter Kit \$399.99 MSRP**

- Includes Wireless Color Touch Screen Handheld Controller and 56 Watt Power Supply
- Expandable to Virtually any Size Layout

**NEW Locomotive Module** **LM-2 & LM-2S**

- Direct Radio RF
- Sound and Non-Sound
- New Tiny Size
- 6 Light Outputs

**Click Here to Learn More**

For more information visit our Internet site: [www.RingEngineering.com](http://www.RingEngineering.com)

  
**Email**

  
**Phone**

  
contents

  
index



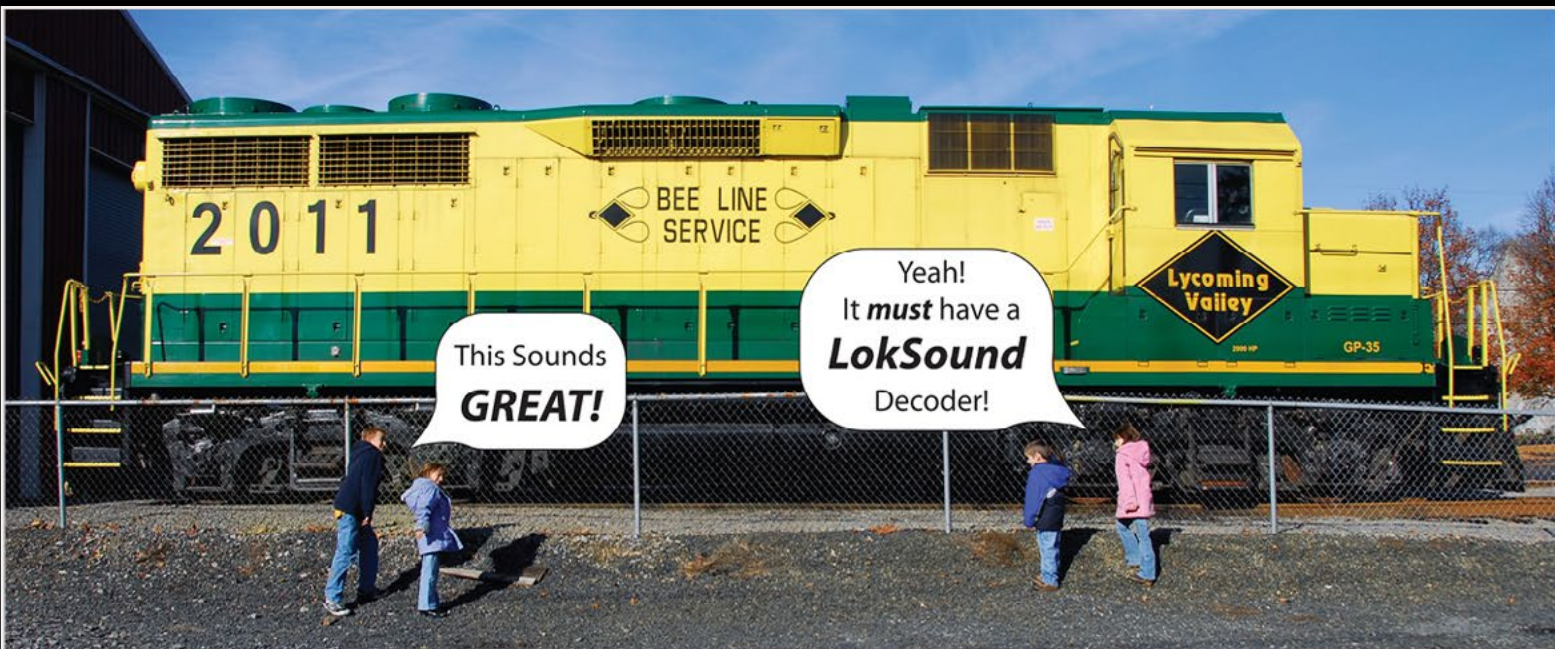

**SO REAL...You'll Think You're There!**

**LokSound Select · 3 SIZES, ENDLESS POSSIBILITIES!**

**INDUSTRY LEADING  
MOTOR CONTROL**

- Multiple Bell types
- Multiple Brake squeals

**4 OR 8 Ohm  
SPEAKERS!**

- 4 or 6 Output functions depending on the style
- Up to 4 Prime Movers or Steam Sounds on EACH decoder
- 16 Very Playable, LOUD Horns or Whistles depending on Profile
- All Changeable by using ONE CV! No Programmers or Boosters needed!\*

Small Size  
**BIG POWER! 1.1Amp!**  
LokSound Select  
**"4 AUX"**

**ONE SIZE FITS ALL!**  
LokSound Select **"DIRECT"**

Tiny Size,  
**HUGE Versatility!**  
LokSound Select  
**"MICRO"**



\$99.99



**LOKSOUND  
SELECT**

Only Available From  
ESU LLC (USA) 



\$109.99

6 Outputs!  
LED Resistance  
Built In!



**LOKSOUND  
SELECT**

Only Available From  
ESU LLC (USA) 



\$99.99



**LOKSOUND  
SELECT**

Only Available From  
ESU LLC (USA) 



[www.LokSound.com](http://www.LokSound.com) Now on facebook!



477 Knopp Drive - Muncy, PA - 570-649-5048



**SOUNDTRAXX™**

Blackstone  Models™



## *Year Round*

We have the **BEST** selection of  
DCC Products, Great Service  
& Professional Installation!

*Check us out  
on the web!*



## *Litchfield Station*

# **www.Mr-DCC.com**

# **623-298-7355**





## “How Long Did It Take You To Build Your Layout?” – Part 2



### Getting Real column

by Mike Rose

## Continuing the “reconstruction” of my layout

**L**ast month I finished up with the relocation of "Grainzilla" and the work necessary to hid the utilities where its new home is located. Now it's on to building Towanda.

### **Towanda: Out of the ruins of Hammill Yard**

The very next thing I wanted out of the way before building Towanda proper was to install a curved corner there in place of a mountain. After mulling different methods, I decided that I wanted it done with drywall so I could seamlessly blend it in with the existing walls. The first thing I did was to determine where the curve needed to be and mark those spots on the walls. Basically I needed to screen a hidden track, plus allow that track to penetrate the partition to get behind the curve. Since it would be beneficial to do this with a stud on each side, I cut out the existing drywall up to a stud, then scabbed another nailing surface onto the side of the stud as shown below. I was then able to cut a piece of ¼" lauan plywood to fit from the extreme left to the extreme right of those grooves.



37



38



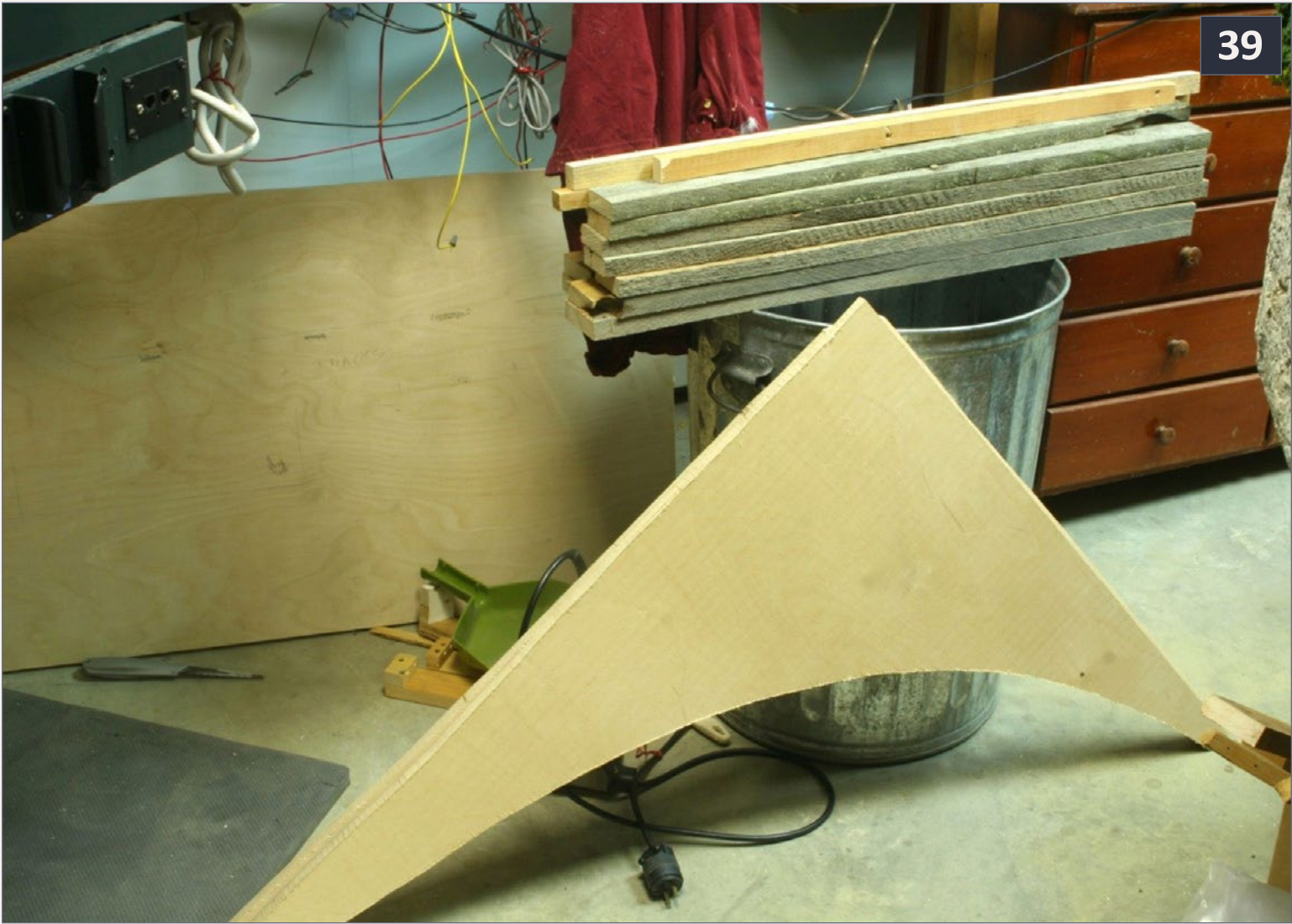

**39:** One of the plywood corner formers used to create the curved corner. The vertical pieces that would act as studs are stacked on top of the garbage can, ready to assemble and install.

**37:** The corner is ready for the curved backdrop. It's not a pretty sight right now.

**38:** Now I needed to build the stud structure that would be what the plywood and drywall were screwed to. With the lauan in place, I used cardboard to determine what the top and bottom "formers" would look like, and cut these out of plywood.



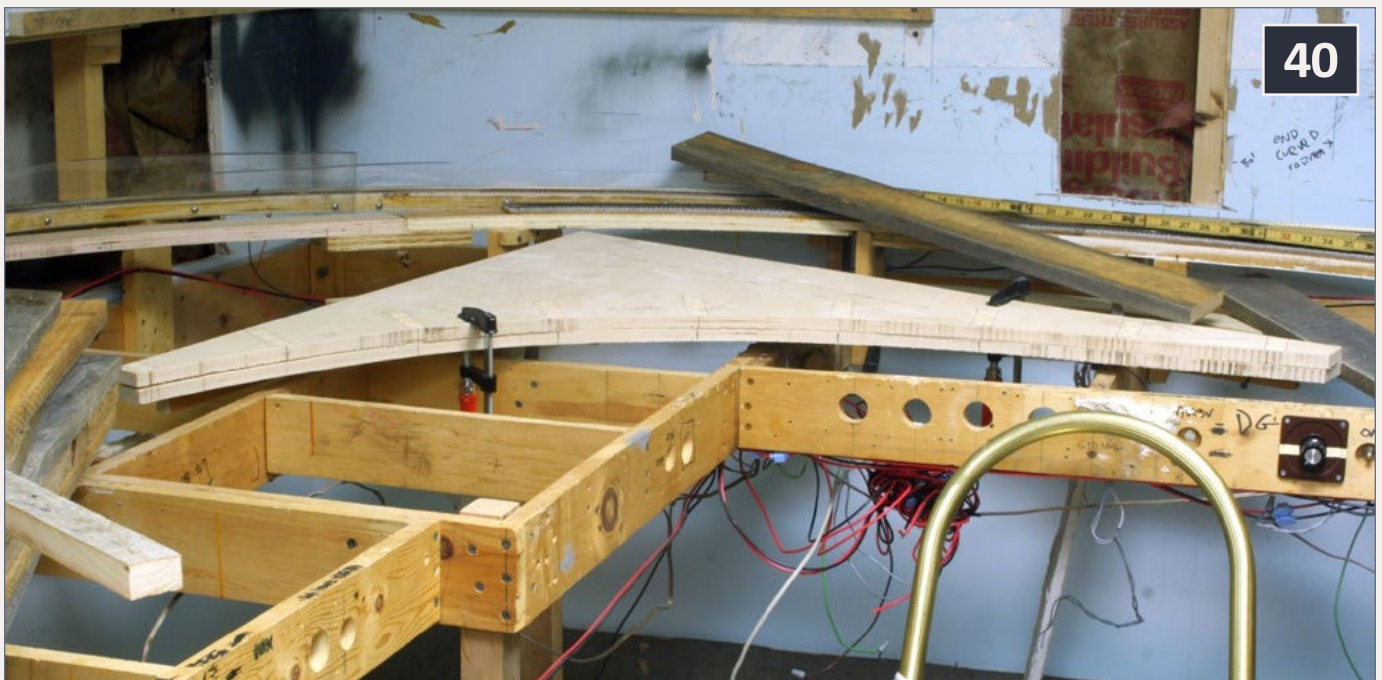

**40:** Here the top and bottom formers are clamped together so that I could measure and mark the stud center locations accurately on both pieces.

**41:** It took a little planning to determine how to build the assembly, since I had no way of drilling down into the top former once it was in place. I chose to screw all of the studs to it first, then pre-drill and insert the screws for the bottom piece. Here it's upside down on top of the partially assembled corner. I used 2½" coarse-thread drywall screws for all of this assembly.



42: Here's the assembled curve corner stud assembly in place. Note that it fits up flush to the ceiling but does not attach to it in any way, in case I needed access to anything above the tiles.

## Did you see this MRH video?



**A full-sized F7  
cab in the  
layout room?**

**Watch the video now**



contents



index

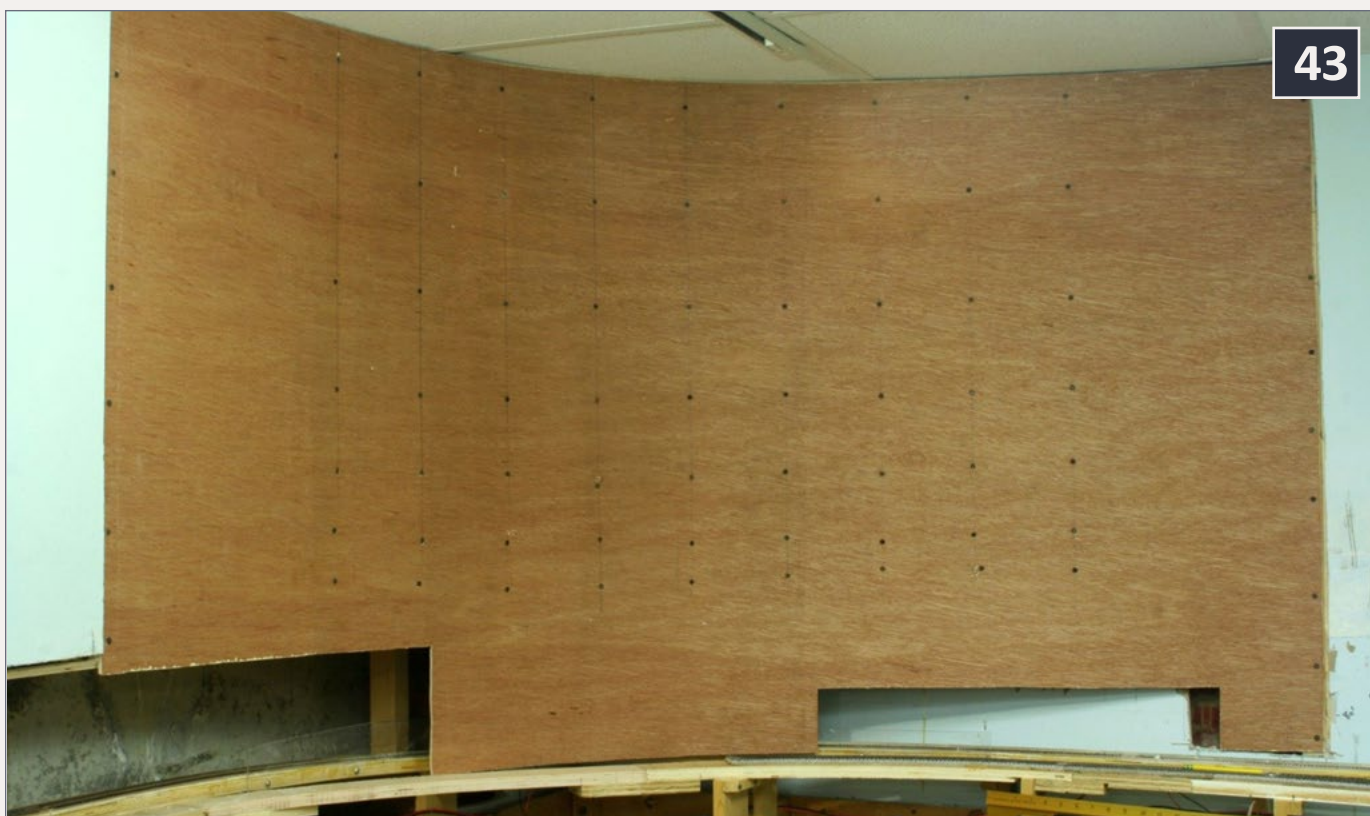

43: Here the lauan 1/4" plywood is screwed in place. It's a two-man job, but I did it myself! The many screws ensure against pull-out, as the panel is under a fair amount of stress.

Get the Latest Model Railroading News, Tips, Reviews & Opinions

# The SCOTTY MASON

## S H O W

*The Original Model Railroad Podcast*

### -Monthly Interviews

- Modeler's Spotlight: Top Modeler's Talk
- Narrow Gauge Modeling w/Chris Lane
- Contemporary Modeling w/ Mike Rose

### -More Product Announcements & Reviews

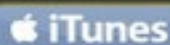

Our feed has changed! To get the latest shows, Please search Scotty Mason and subscribe to the new feed!

[www.TheModelRailroadPodcast.com](http://www.TheModelRailroadPodcast.com)

Scott Mason

Jimmy Simmons

Mike Rose

Joe Duckworth





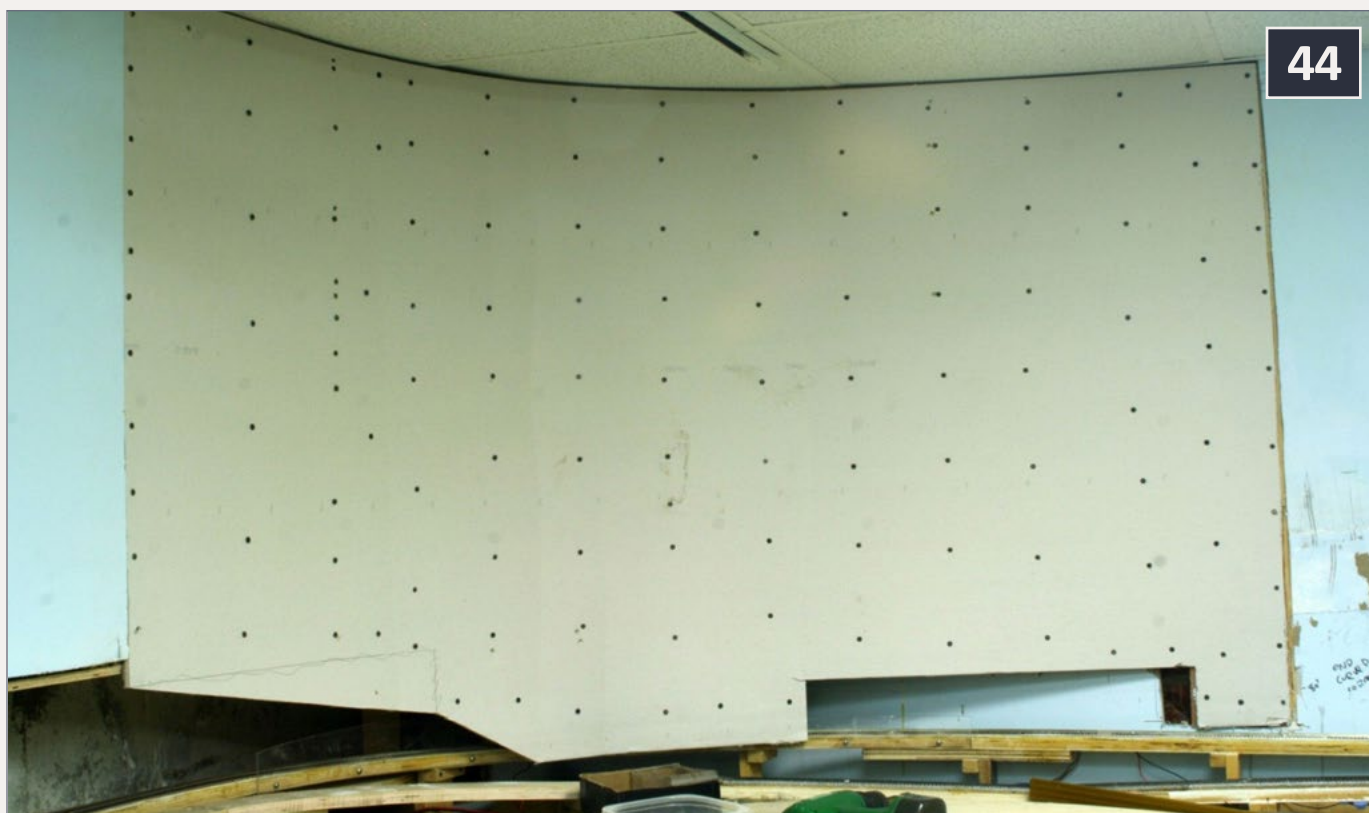

44: I smartened-up for the drywall portion and waited until Train Night when my friend Dave Santos could come over and help me hang this piece of “flexible” drywall. It’s in quotations because it’s not nearly as flexible as I thought it would be, and it actually snapped in a couple of places. I should have soaked it more thoroughly, but I was in a hurry.

**When talking to  
hobby vendors,  
please remember  
to mention MRH.**



contents



index



**45: Joint compound to the rescue! With sufficient compound (and sufficient time and patience!) this non-pro was able to eventually get a very smooth curve.**

**46: Here's the finished surface after primer has been applied.**



47: Once the sky-blue paint was applied with a roller, the entire area looked quite different indeed. Compare this view with early demolition shots that showed a corner and a mountain here.

*Advertisement*

**Click Here**

**FIFER HOBBY SUPPLY LLC**

**Your Local Online  
HO & N Scale Hobby Shops**

575-523-9743 • fiferhobby.com • fiferhobbyho.com



[← back to previous page of text ...](#)

## Time for Sub-Roadbed

Finally with all of the backdrop work completed I could begin trackwork. I wasted no time hoisting the piece of 3/4" birch plywood back on top of the risers and planning my trackwork for East Towanda and Towanda Yard.

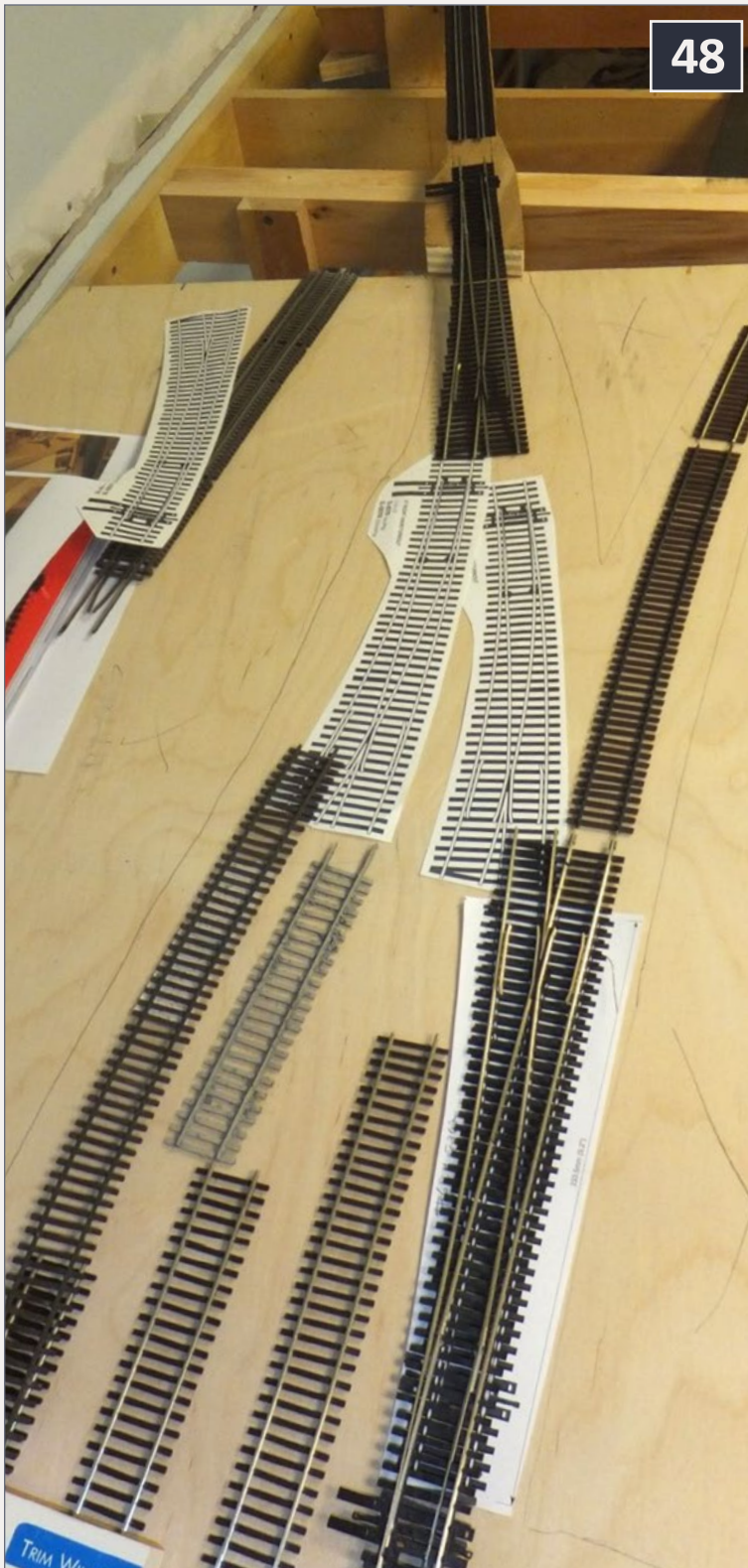

**48:** Peco makes some very handy turnout templates that are a free download from their website. I planned to use a mix of code 70 and code 83 track and turnouts in this area, since I really needed a few of Peco's curved #8 turnouts. Yet I was connecting with an area that was all done with code 70 track and Micro Engineering turnouts.

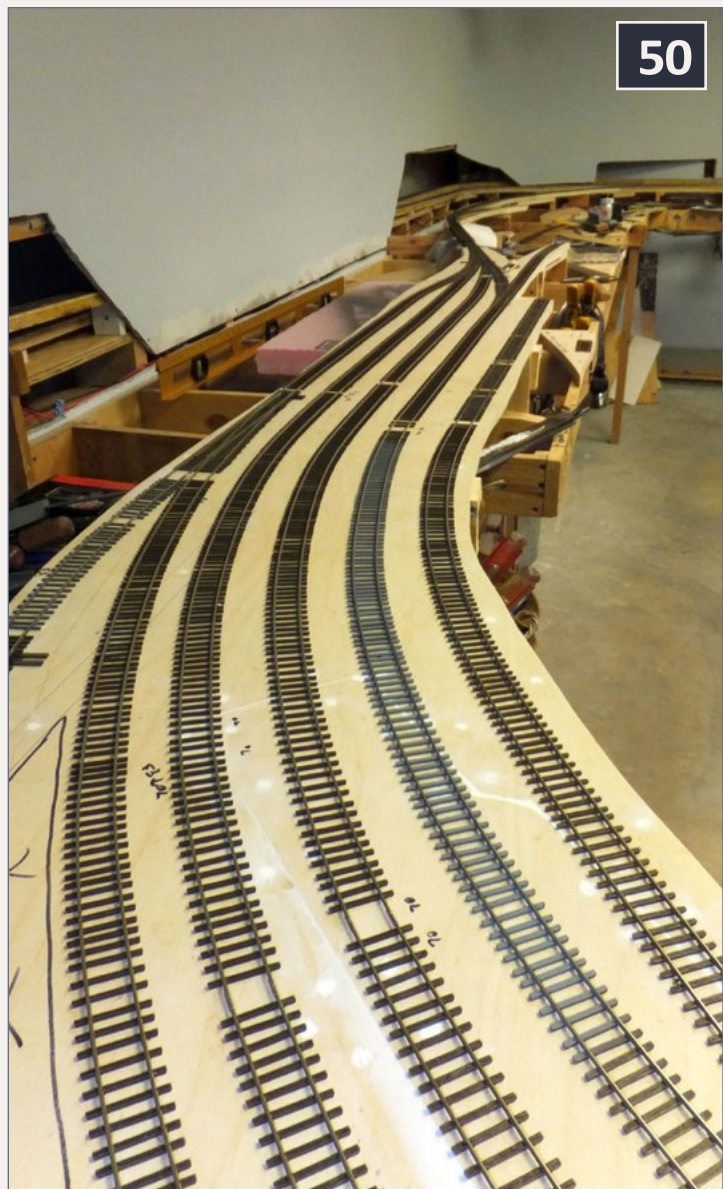

**49:** Once I'd arrived at a track layout, I used the track arrangement to mark the cuts on the big sheet of plywood, and the here is the result. Note the cut at the bottom to fit existing sub-roadbed.

**50:** In this view, the yard and ladder down at the far end are all in place. I chose to add feeders as I built it, with each piece of rail getting a feeder, and turnouts getting quite a few.



contents



index



**51: Looking back the other way, this view shows how the yard was extended and connected into existing, modified track.**

***Want to keep MRH free?***

**CLICK on ads.**

*If ads in MRH don't get clicks, then advertisers won't advertise with us, it's that simple ...*

I had told my friends that if I ended up being where I needed to be by the end of June, that I'd take July to clean up and prepare so that the op session could commence as planned in August. That's exactly what happened.

Sometimes it's nice to have a deadline! A massive cleanup ensued, and the op session rolled along beautifully in mid-August with minimal hassles – a few stray cars that needed trucks or coupler tweaks, two or three small sections of track with minor problems that were quickly fixed, and a recalcitrant turnout in Mehoopany. Jim Lincoln ended up staying late for a couple of hours until he methodically got it to work to his satisfaction. We moved over 250 cars in prototypical fashion using switch lists, and everybody agreed that not only was it about time we operated here again, but that it should not be years between sessions!

Some other discussions about things I'd been on the fence about resulted in a few interesting scenic changes in an area to be called Athens, which on the prototype and my railroad is just south of Sayre, PA. I scheduled another op session for early November 2013, and the plan is to rough-in Athens, plus do some other scenic efforts before cleaning up again for it, then take the winter and really hit the scenery in and around Towanda as hard as possible. It's great to see the layout Getting Real!

I plan to post video of operations in and around Mehoopany as an adjunct to this column.

*Continued on next page ...*



contents



index



**52:** There will be a nice little river crossing scene here, I hope, separating East Towanda and Towanda Yard. It helps me to picture things better when I use mock-ups, so I cut out from cardboard what will eventually be the river, and tried a couple of old abutments at either end of the girders that are just stuck to the side of the sub-roadbed with tape. Pieces of note paper were used to give me a feel for the embankments. This river will disappear out of sight off to the left and rear of Towanda Yard.

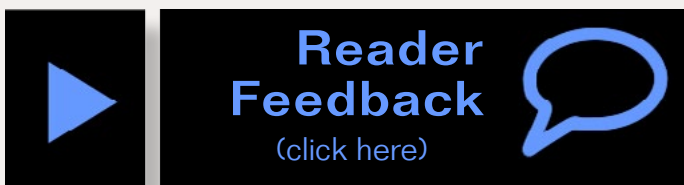



**New  
Innovation**



# Nano Technology Lubricants

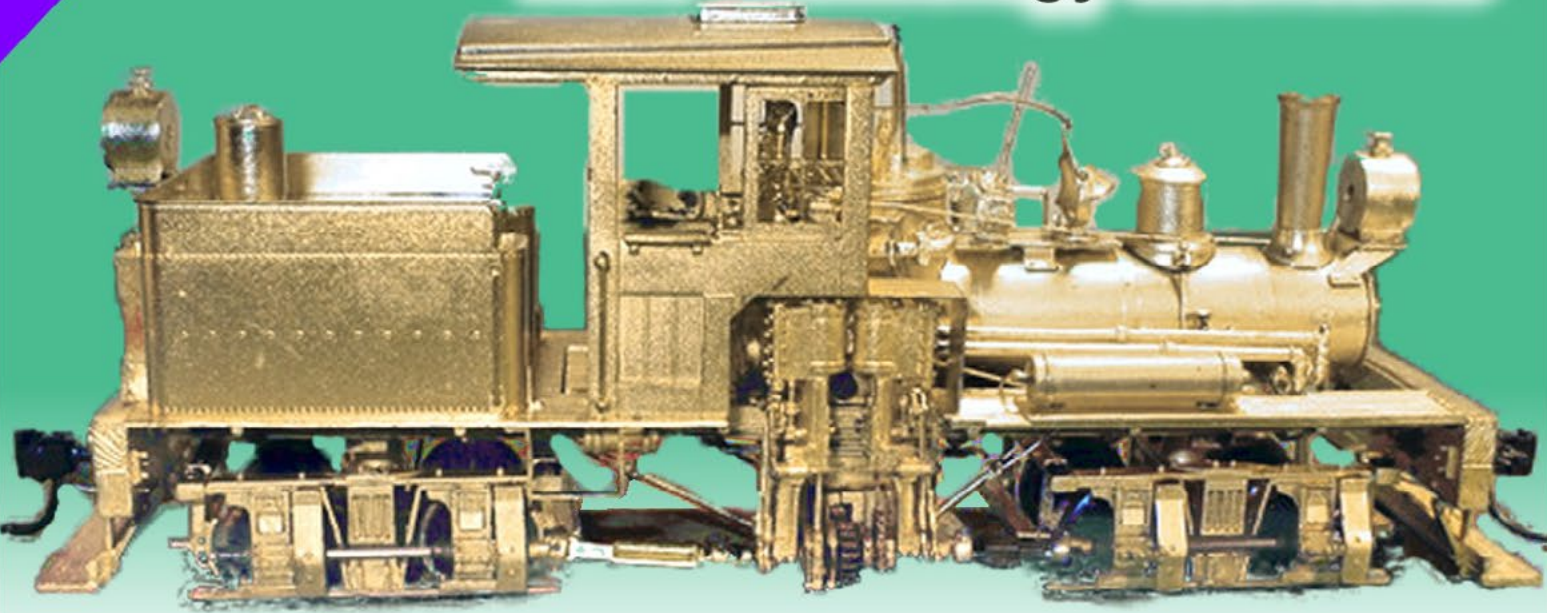

**Nano-Grease**

"After eight years of extensive testing, the only lubricants now used in my shop are Nano-Oils and Nano-Grease. The extreme reduction in power draw by mechanically minimizing friction is simply technologically superior."

- Phil Floyd, 'The Shay Fixer'

**THE SHAY FIXER**  
VISIT US AT...  
**SHAYFIXER.COM**

*Specializing in brass Pacific Fast Mail / United geared locomotives*

**For more details  
click here ...**



# NORFOLK SOUTHERN HERITAGE DIESELS ARRIVE

SD70ACe DCC Sound Equipped With Remote Couplers



## Featuring:

- Intricately Detailed ABS Body
- Die-Cast Metal Chassis
- Metal Handrails and Decorative Horn
- Moveable Roof Fans
- Metal Body Side Grilles
- Detachable Snow Plow
- (2) Engineer Cab Figures
- Authentic Paint Scheme
- Metal Wheels and Axles
- RP25 Metal Wheels
- (2) Operating Kadee Compatible Remote Controlled Proto-Couplers
- (2) #158 Scale Kadee Whisker Couplers
- Prototypical Rule 17 Lighting
- Lighted Cab Interior
- Directionally Controlled Constant voltage LED Headlights
- Illuminated Number Boards
- Operating Ditch Lights
- Powerful 5-Pole Precision Flywheel Equipped Skew-Wound Balanced Motor
- Locomotive Speed Control In Scale MPH Increments
- Operates On Code 70, 83 and 100 Track
- Built-In 28-Function DCC Decoder
- 1:87 Scale Proportions
- Proto-Sound 3.0 With The Digital Command System Featuring Freight Yard Proto-Effects
- Operates On 18" Radius Curves



See why M.T.H. HO Trains

**Do More**

Follow Us Online!



**HO  
SCALE**



[www.mthHOtrains.com](http://www.mthHOtrains.com)



©2014 M.T.H. Electric Trains





# Scott Sanders - Weathering and locomotive artist

Photos and video of superb models

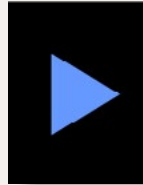

**Reader  
Feedback**  
(click here)



## What's neat this week column by Ken Patterson

1



**1: Scott Sanders is easy to work with, and interesting to listen to. He pays attention to details some might miss.**



**S**cott Sanders' models are exquisite renditions of the real thing, a level all of us desire to achieve at some point in our modeling career.

The video accompanying this shoot shows his models from various angles, and has a running sequence of his freight cars. During a prototype run-by, things happen that you really don't expect. In the interview, Scott describes the detail and effort that goes into his locomotives.

Take a good look at the still photos and captions, then check out the video. If you really like this feature, click on the Reader Feedback for What's Neat This Week and rate it "awesome."

[... On to next page of pictures →](#)



**Playback problems?** [Click to try a different version.](#)

# NEW FROM ACCURAIL



## EASY TO ASSEMBLE HO SCALE KITS

#2424 Philadelphia & Reading  
USRA Hopper



#8957 Union Pacific 89' TOFC Flat Car  
3-Car Set



Also available as singles #8918

CSX 'How Tomorrow Moves' 3-Car Set #20998



#5652 Burlington 50' Steel Boxcar



3-Bay ACF Hopper

Also available as singles #2099



#4638 DT&I  
Double  
Sheath  
Wood  
Boxcar



#4115 Central  
New Jersey  
40' Exterior  
Post Wood  
Boxcar

#1217 FGEX/WFEX 2-Car Set



#8041 B&O USRA Hopper  
3-Car Set



#8315 Canadian National



40' Steel Reefer

#8042 Pennsylvania  
'Coal Goes to War' Twin Hopper



**PLEASE SEE YOUR LOCAL HOBBY DEALER FIRST  
OR CALL 603-965-1173 FOR DIRECT ORDERS  
ACCURAIL INC. PO BOX 278 ELBURN, IL 60119**





**3: On an Atlas caboose, Scott relocated the side windows, raised the cupola, rebuilt the end cages, and blanked one window on each end. He also detailed the interior and built a full underframe. The paint is Modelflex MKT Green, with Microscale decals. All weathering is by hand, with oils and pastel powders.**

[← back to previous page of text ...](#)



### Advertisement



## N SCALE GP60M & GP60B



**READY TO LEAD YOUR  
PRIORITY TRAINS  
IN STORES NOW**

**SANTA FE WARBONNET - BNSF H2  
BNSF H3  
[www.foxvalleymodels.com](http://www.foxvalleymodels.com)**

**4: The Athearn PS 5344 boxcar is a factory-painted Texas & Mexican, with new data and patches added using Microscale thin trim film. Complete details are added to the under-frame. The car has Sergent couplers and is weathered using oils and pastel powders.**



Email



Phone



contents



index



**5:** This Walther's Ortner rapid-discharge hopper has factory paint. The car is upgraded using brass wire, angle and flat bar for all of the handrails and stirrup steps. The underframe is detailed with brass angle, and Kadee springs for the actuators. Sergent couplers are added. The model was weathered with oils and pastel chalks.

**6-7:** Scott added details, air lines, actuating hoses, MU hoses, a firecracker antenna, Sergent couplers, a speed recorder, sand lines, and markers to these factory-decorated Atlas GP40s. They are weathered with oils and pastel chalks.



6



7



contents



index



8: His custom-built slug uses an Atlas frame and trucks. The body is built from styrene and painted with Modelflex. Added details include MU cables, actuating hoses, sand lines, traction motor cables, and oil and pastel powder weathering.

Advertisement



*"Archer rivets are easy to apply and look great. To me, they are now a vital tool in building railroad models."*

Tony Thompson, Model Railroad Author/Historian



MADE IN THE USA

# Archer

**FINE TRANSFERS**  
PROUDLY SERVING MODEL BUILDERS SINCE 1989

**THE ORIGINAL**  
**SURFACE DETAILS™**

**PRECISE SCALE RESIN RIVETS,  
LOUVERS, TREADPLATE, WELD BEADS  
AND MORE ON MICROSCALE CLEAR  
DECAL FILM**

HO, O, N, S AND G-SCALES, RESEARCHED BY EXPERTS

➔ **CLICK HERE TO  
VISIT OUR WEBSITE!** ➔

Archer Fine Transfers • PO Box 1277 • Youngsville, NC 27596 • USA  
(919) 570-1026 • info@archertransfers.com • archertransfers.com

MRH-Jan 2014





9a-9b: The MKT slug-mother set operates as a single unit and was never parted, except for heavy maintenance. Katy crews nicknamed the set "The Three Stooges."

Advertisement

Free Shipping on all US WEB orders over \$125.



ACCU-LITES, inc

Your DCC Center!



Watch for our monthly specials!

New from ACCU-LITES! Make LocoNet wiring extremely simple!

"... great time saver as well as providing flexibility to change things ..." - Terry Nathan

PM42 breakout board



BDL168 Multi-zone breakout board

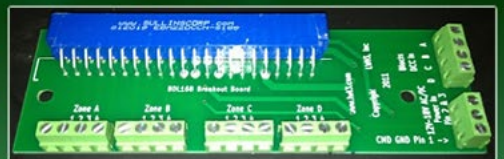

SE8C breakout board



BDL168 Single-zone breakout board



<http://www.acculites.com>

CLICK TO LEARN MORE ...







contents



index



10: Modeled after an ex-ICG engine that the Katy bought in the mid-1980s, this Lifelike GP38-2 was factory decorated and patched by Scott to match the prototype. He changed details to make it an accurate GP38AC, and added a single chime air horn, air filters, MU hoses, air lines, and Sergeant couplers.

*Advertisement*



**TOP QUALITY PRODUCTS**  
FOR THE MODEL RAILROAD CRAFTSMAN



**Propane Tanks**

**Click here to buy now**



HO Scale

[WWW.GLXSCALEMODELS.COM](http://WWW.GLXSCALEMODELS.COM)



11



12



**11: Weathering with chinks and oils brings out the details in the MKT slug unit.**

**12: Dynamic brakes are added to this factory-decorated Atlas GP40 to represent an ex-Conrail engine that the Katy bought in the mid-1980s.**



contents



index



**13: Scott reworked the windows, cupola, end cages, and underframe on this MKT caboose. The interior and underframe are fully detailed. Modelflex MKT Green and Microscale decals finished it up.**

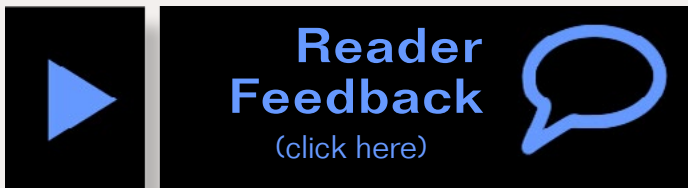



# Bowser

## EXECUTIVE LINE

HO Scale

New Products - See our web site for details



ALCo Century C-430



ALCo Century C-628

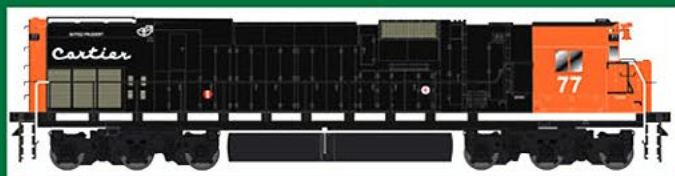

ALCo Century C-636



U-25B

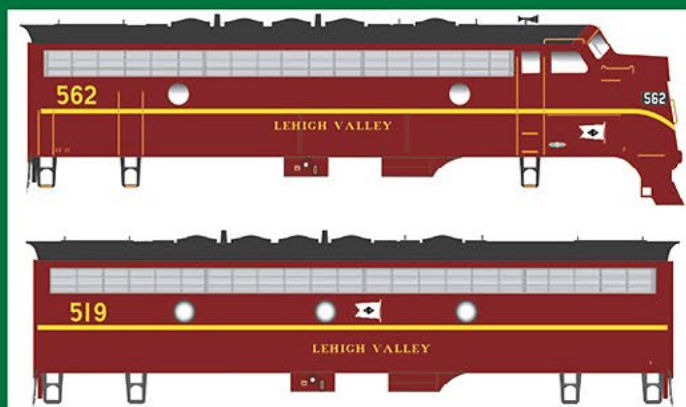

F Units



3 & 5 Unit Spine Cars

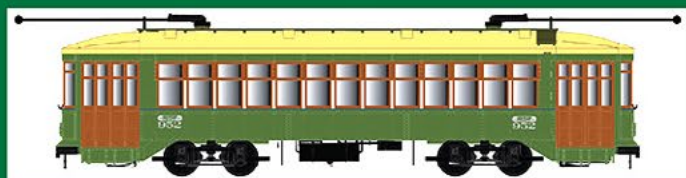

New Orleans Streetcars

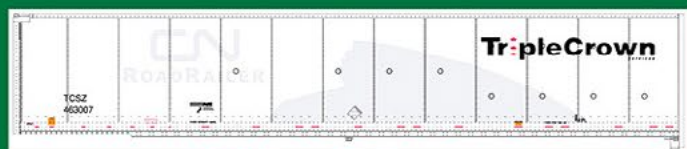

53' Roadrailers



G-39 Ore Jenny



Baldwin S-8 & S-12 Switcher

70 Ton 2 Bay Covered Hoppers



GLa 2 Bay Hoppers



Click here to check out the details for these and other great Bowser products!



# MRH HOBBY MARKETPLACE - 1

Affordable custom and modular benchwork.

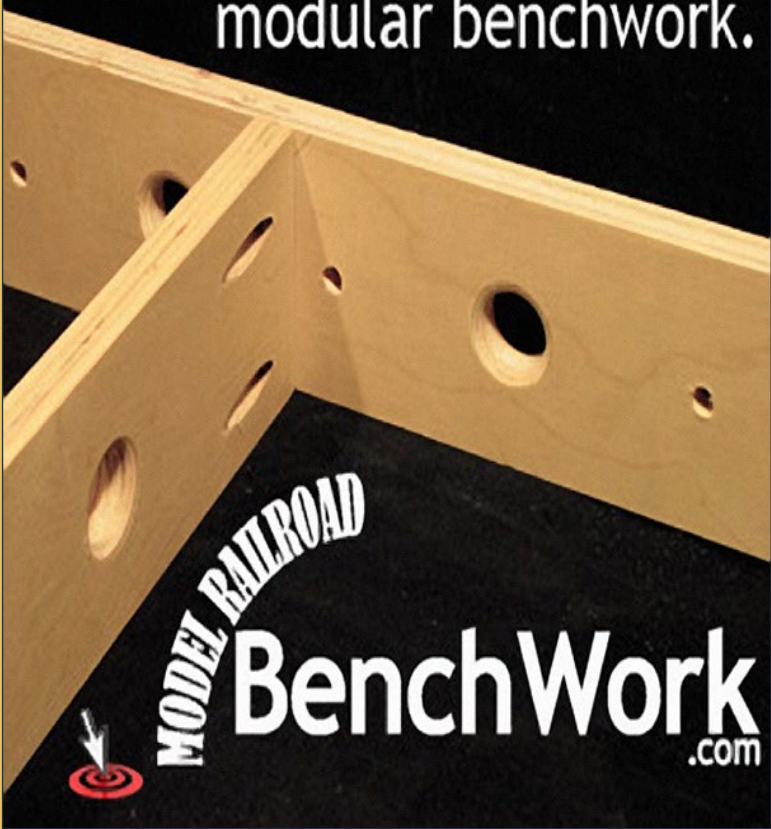

## GOLDEN AGE LINE **WESTERFIELD** MODELS, LLC



**4900 Series R-30-4/5/6 PFE  
Reefers Re-Released!  
NEW KITS AVAILABLE.  
westerfieldmodels.com**

## clever models LLC

### Cardstock models & Building materials

**CLICK HERE**

[www.clevermodels.net](http://www.clevermodels.net)

click here!

Recommended installation tool

Goes on easy

All Scales

All Brands

Make a Tire or Retire

**SNOT = SAND**

99% Know It Works!

**Green Grip from a Jar**

[WWW.BULLFROGSNOT.COM](http://WWW.BULLFROGSNOT.COM)

## True Scene™ Modeling

**NEW FusionFiber™**

Scenery Base Material for the 21st Century!

**SATISFACTION GUARANTEED!**

[www.truescene.com](http://www.truescene.com) or 716-523-7305

# MRH HOBBY MARKETPLACE - 2

## RULERS-of-the-WORLD

Scale Rulers \$4 each

Over **150** scales!

Metric or Imperial

[www.rulers-of-the-world.com](http://www.rulers-of-the-world.com)

Rail Design Services

# Need Heralds & Signs?

[click HERE to learn more](#)

## Great Decals!

is now selling decals produced by *After Hours Graphics* for Midwestern railroads. Roads offered include C&O, Cincinnati Union Terminal, Conrail, CSX, DT&I, Great Miami, Indiana and Ohio, Interstate, NKP, Norfolk and Western, Pere Marquette, Southern, Transkentucky, and private labels Dow and Owensboro Grain.

For the complete list, see:

[www.greatdecals.com/  
AfterHours/AfterHoursList.  
html](http://www.greatdecals.com/AfterHours/AfterHoursList.html)

Great Decals!

P. O. Box 994, Herndon, VA 20172

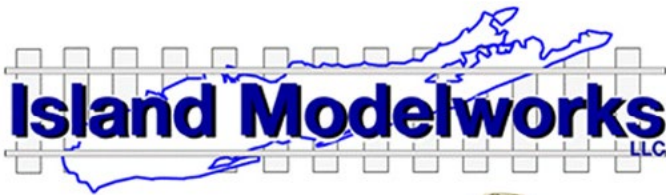

### Commuter Trains, Subways, LRV's

Models available in HO, N, & O scales

Boston - Chicago - Connecticut - Long Island

Maryland - New Jersey - New York City

Philadelphia - Portland



**NEW!**

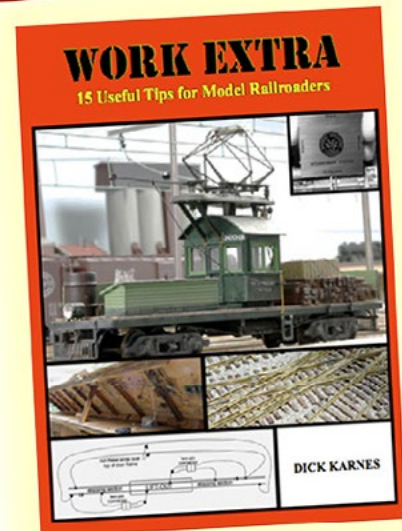

Where?

**Here!**

**RLN**Publishing

PO Box 6104, West Orange NJ, 07052-6104  
[www.1-64ModelingGuide.com](http://www.1-64ModelingGuide.com) [rlnpublishing@me.com](mailto:rlnpublishing@me.com)



# MRH HOBBY MARKETPLACE - 3

## KMJ MODEL TRAINS



WE ARE  
**"ALL ABOUT TRAINS"**

FIND SOME OF THE BEST PRICING ANYWHERE

CLICK HERE FOR THAT  
 TRAIN RIDE TO COMPLETE  
 SATISFACTION.



## STREAMLINED BACKSHOP SERVICES

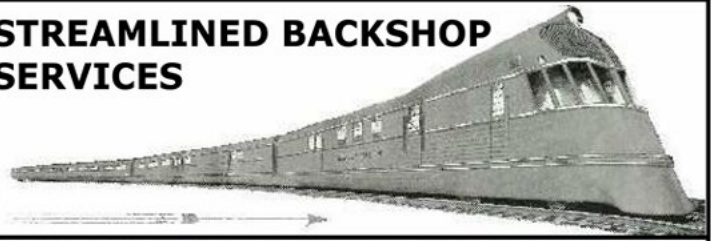

## Z-N-HO-G DCC INSTALLATIONS



[www.SBS4DCC.com](http://www.SBS4DCC.com)

## Minimalist Model Railroading



New Approach to  
 Model Railroad Design

Click here to learn more...

[minimalistmodelrailroad.com](http://minimalistmodelrailroad.com)

Don't settle for lifeless signals!

We've got signaling circuits!

**LOGIC RAIL™**  
 TECHNOLOGIES

"Sophisticated  
 Model Railroad  
 Electronics"

Please visit our website and online store!

21175 Tomball Pkwy  
 Suite 287  
 Houston, TX 77070

Phone: (281)251-5813  
<http://www.logicrailtech.com>  
[info@logicrailtech.com](mailto:info@logicrailtech.com)

AMERICA'S NUMBER ONE  
 RAILROAD PRINT SOURCE

**Jelsma**  
 Graphics

...America's Railroad Embroiderer

Railroad Art-Prints,  
 Caps, Jackets,  
 Shirts and More ...  
 Jackets starting  
 at \$79.95

[www.jelsma.com](http://www.jelsma.com)

1-904-221-3513 • Jacksonville, FL.

Avoid the hassle and let us plan your  
**SurroundTraxx**  
 Integration and Transponding System

from **DCC by Design**

Take advantage of our experience

[www.dccbydesign.com](http://www.dccbydesign.com)

**HOBBY  
 MARKETPLACE**  
 ads are  
 economical and  
 effective.

Click HERE to learn more.



## New Baseline Capture Feature



## Backdrop Junction

Your stop for  
Model Railroad Backdrops



*click here to visit our website*  
**backdropjunction.com**  
*N, HO, O Scales • Custom Orders*

Did you see this  
MRH video?



Watch the  
video now



Your ad could  
be in this space  
for just \$55 a  
month.

*Click to  
learn more ...*



# Journey to Allagash Country, Part 1

– **Mike Confalone**  
Model Photos by the author



## Two teenage railfans head north! ...

**O**n April 18, 1980, my friend Joe Posik and I packed his 1977 Pontiac Grand Prix and left our college dorms at the University of Scranton in Pennsylvania in the dead of night. Due to college class schedules, and very little money



**1: Allagash Bicentennial  
M420 200 leads train  
CPIP at Sandy River Jct.**

*for gas, food, and hotel, we could devote only two days track-side, plus a day for travel. It was going to be tight so we had to take advantage of what limited time we had. We were headed into uncharted territory in the wilds of Maine. We were headed for Allagash country!*



contents



index

## Part 1

As young teens, Joe and I had been fascinated by New England railroads. We were especially fond of the railroads in Maine, particularly the Maine Central, Bangor & Aroostook, Allagash, and Atlantic Great Eastern. Our exposure to them was limited to the railfan magazines of the time, but that was more than enough to pique our interest. As we grew up, the itch to actually do some serious railfanning in Maine on our own became unbearable.

Joe had spent time at school in Plattsburgh where he played ice hockey, but transferred over to Scranton. He had recently obtained his drivers' license and had his car with him at school. We were both juniors there, and were doing our share of serious partying. Now it was time to get serious about seeing some trains. We had the wheels – we just needed a plan.

Interestingly, one of the railfan magazines had published an interesting article, essentially a trackside guide to current operations for the railroads of Maine. We picked up a copy at the local hobby shop and studied it cover-to-cover. Where to go? Maine Central? Bangor & Aroostook? Or maybe one of the short lines such as the Belfast & Moosehead Lake or Aroostook Valley? We considered all of the options and finally settled on the Allagash Railway (AGR). The AGR had a cool mix of first- and second-generation power from both EMD and ALCo, and rumor had it that they recently picked up a bunch of vagabond former-Conrail ALCos. As of the year before, they also had a few F-units and a couple of RS3s still running around, but they were probably in the deadline.

We booked a small mom-and-pop motel in the town of Weld, Maine, located right next to the AGR's Androscoggin Subdivision.



The weather forecast was typical for early spring in northern New England – cloudy with a chance of rain the entire time. We didn't have time to be picky about the weather. We departed Scranton at 9 p.m. and began the long, nine-hour drive to Weld. We drove through the night, listening to an assortment of FM radio stations along the way, as we tried to stay awake. Billy Joel's "You May be Right" and Blondie's "Call Me" were big hits back then. We heard each of them at least a few times.

The dawn broke gray as we arrived in Weld the next morning. We were tired but ready for action. We checked in at the Mt. Blue Motel in Weld, grabbed a quick bite at the general store in town, and tried to come up with a plan. We decided to head for the division point yard at Madrid, around 19 miles to the north. The trackside guide warned that the Allagash had recently adopted a strict no-trespassing policy. The railroad had always been friendly to railfans, but things had apparently changed. We didn't know what kind of reception we would get.

**“As young teens, Joe and I had been fascinated by New England railroads.”**

We arrived at Madrid a little while later. The reports were correct. As we drove into the terminal, we were quickly confronted by a railroad security cop. Fortunately, he was a friendly sort. We explained what we were doing and he told us about recent problems with vandalism, and that he just couldn't let us wander around the yard. He did say he'd call the yardmaster to see if he could get us some information. We could see AGR power lined up on the diesel servicing tracks and inside the road's brand-new, two-stall modern engine house, but we couldn't get close enough to get any pictures.



contents



index

After about 15 minutes, the cop returned and advised that there were two trains in the picture, both on the Androscoggin Sub. Southbound CPIP (Canadian Pacific-International Paper) was out of Jackman a couple of hours ago and northbound BM2 (Bethel-Madrid) was working at Dixfield. It looked like a meet would take place at Carthage. This was enough info to get us started. We thanked the gentleman and headed south to find a spot to set up for CPIP.

Several miles out of Madrid we found Sandy River Jct. This was the location where the White Mountain Branch split off the Androscoggin Sub. We hung around for about an hour watching the clouds thicken and lower. It was obvious there would be no sun today. Just when we thought we couldn't wait any longer, finally there was a horn in the distance, and then a headlight on the horizon! We grabbed the cameras, fully loaded with Kodachrome 64, and got into position. A haze of smoke made it



**2: CPIP stops shy of the Route 156 crossing in downtown Weld.**

3a



### **3a-3b: ALCo C425 251 leads BM2 around the big curve at Knox Farm.**

clear there was ALCo power on the train, but the colors of the lead unit were strange ... not the typical Allagash green and gold. Turns out it was AGR Bicentennial MLW M420 200, flying solo! Behind the 200 was a short slug of green Canadian Pacific paper boxcars. Despite the dreary conditions, the 200 made a fine sight crossing the bridge over the Sandy River and passing the station sign for Sandy River Jct. (1). The chase was on!

We leaped into the car and sped ahead to Weld. We had just a minute to jump out and grab a shot as CPIP drifted into town, (2) where he took the siding. The crew headed over to the Weld General Store. A quick chat revealed that BM2 (Bethel-Madrid) had stalled on wet rails at Homan Summit, south of Carthage, and had to double the hill. The dispatcher held CPIP at Weld. The meet would be here.

[... On to next page of text →](#)



contents



index





contents



index

[← back to previous page of text ...](#)

We contemplated an action plan. Was BM2 back on the move? We decided to try to flush him out, so we headed down route 142 toward Carthage. If he was still doubling into Carthage, we would be safe. But there were several miles between Weld and Carthage where the rails disappeared into deep woods and we could easily lose sight of the train. We were taking a considerable risk. About three miles out of Carthage we caught the sight of a northbound train at speed through the trees. Oh no! We came to a screeching halt, reversed direction and passed back toward the big farm curve at Knox. This shot was a must-have.

After several minutes of white-knuckle driving, we arrived at Knox and set up at the foot of the hill near the farm road crossing. The unmistakable sound of a Nathan M3 chime was soon heard along with the chant of ALCo V16 251 and EMD 645 prime movers. For just a second, the sun peeked out on the distant hillside as the train rounded the curve (3). On the point



**4: BM2 enters Weld with empty pulpwood cars on the team track, and an empty feed box car at the Osgood shed.**



## 5: CPIP and BM2 pass in the center of Weld.

was one of the former Conrail C425s, the 251, recently painted into AGR's yellow dip scheme. Trailing were a pair of GP38s in the old solid green. The train hammered by at track speed as we got back in the car and headed for Weld.

We made it back into Weld with time to spare. We parked the car at the general store, and Joe and I split up. Joe lensed the 251 as it crept into town. The sun popped out and brightened the sky for a minute (4). I shot from the porch of the general store as the two trains passed at the Route 156 crossing (5). Joe got a great shot of the deluxe caboose on BM2 passing the 200 (6a-6b), and then it was time to chase again.

We decided to leave CPIP and go with BM2. After a few minutes, we caught up with the train and went ahead to set up at a through-girder bridge over a small river (6c). Three local railfans were already there for the shot. The black storm clouds were incredible as the 251 lead BM2 down the 1% grade. One more

[... On to next page of text →](#)



contents



index







contents



index

[← back to previous page of text ...](#)

going-away shot of BM2 crossing the Sandy River was all we could get as the train accelerated toward Madrid. (6d).

We chatted with the locals, and they advised that a gravel extra was somewhere on the Androscoggin Sub. Apparently it had trailed BM2 out of Dixfield earlier that morning. What was not clear was whether the train had made the hill at Holman. The guys reported that the empty train had gone down to the Dixfield pit the day before and that coming back, the lead unit should be former Conrail C420 2072, still in Conrail blue. Now this was getting interesting! We all decided to head south in hopes of running into him.

We got up to Knox and started to get that nervous feeling. There were no signals to consult (the Allagash is a dark rail-road) and we didn't have a scanner radio. We all parked ourselves on a hillside overlooking the farm bridge at Knox to wait it out. Old man Knox himself came out to see what all the excitement was about. He said he didn't recall seeing or



**6a-6b: M420 200 passes the rear of BM2 with caboose #23 bringing up the markers.**



**6c: With storm clouds brewing, AGR 251 leads BM2 across a through-girder bridge outside Weld.**



contents



index

hearing anything recently, but he couldn't be sure. We spent the next few minutes discussing the Rams' loss to the Steelers in Super Bowl XIV before we finally heard a horn in the distance and the rumble of prime movers. This time there were no EMDs in the din. It was pure ALCo thrashing. Within 10 minutes the train was on us as he passed under the bridge and out of sight, hoppers loaded to the max with gravel. A former PC C425, still in PC black was in the trailing position. (7a-7b). The chase resumed, and we got a grab shot of him at the opposite end of the curve at the Milepost 13 marker. (8). We decided to bypass Weld, instead opting for a close-in shot near a white farm house along the river at Milepost 7 (9). The storm clouds were brewing again. In minutes, the sky opened up as the train headed for Madrid. We ended the chase here.

At this point we were faced with the typical mid-day lull. We decided to grab some lunch at the pizza joint in Weld. Before the other railfans headed home, we asked if they knew of

[... On to next page of text →](#)



**6c: BM2 accelerates toward Madrid as it crosses the Sandy River.**



**7a-7b: Extra 2072 North eases downgrade at Knox.**



**8: Former Conrail C420 2072 leads the gravel extra through the rain and past the marker at Mileage 13.**



contents



index





contents



index

9



**9: Under threatening skies, the gravel extra passes Milepost 7 and the “farmhouse on the hill.”**

10



**10: AGR RS3 303 emerges from an ice-filled rock cut and passes the station sign at Andover.**



11a



## 11a-11b: The 303 switches the Andover Wood Products chip mill.

[← back to previous page of text ...](#)

anything else that might be running. They informed us that an MX job (Madrid Extra) had been called for 0800, but they were unsure where it might be. This job usually went down the White Mountain Branch out to Andover. The guys told us that the branch had been embargoed, but was open again with a petition for abandonment pending. Back in '78, the Allagash attempted to spin it off, leasing it to a shortline called Western Maine. That attempt failed, with the WM lasting less than a year. AGR had resumed operations, but on an as-needed basis. Apparently they still hauled chips and pulpwood out of Andover and White Mtn. Jct., and had recently resumed shipping stone out of the Andover Sand & Gravel quarry. It was a long shot, but we had nothing else to do, so we headed for

[... On to next page of text →](#)



contents



index





contents



index





contents



index

12b



**12a-12b: The 303 carefully negotiates the sharp curve of the Andover Sand & Gravel pit spur. A cement truck heads up the road from the batch plant.**

13



**13: The 303 sets in empty stone cars as the pit crew prepares to load.**

14



**14: With three loaded wood chip cars in tow, AGR 303 enters the small yard at White Mountain Jct.**

15



**15: The 303 is headed for Sandy River Jct. as it passes the Prentiss & Carlisle wood yard at White Mountain Jct.**



contents



index

[← back to previous page of text ...](#)

Andover, about a 90-minute drive. As luck would have it, the MX was indeed running. After about a half-hour wait, ALCo RS-3 303, light engine, came through the snow-and-ice-filled rock cut into “town.”(10) There wasn’t much there – a short siding into a wood yard, an active but dilapidated wood chip mill, and a small yard with track that was in very poor condition. The 303 switched out the chip mill (11) and then headed a couple of miles to the Andover Sand & Gravel quarry. He spotted some empties into the pit siding (12-13) and returned to the yard, where he grabbed three wood chip loads and quickly departed. We had hoped to talk to the crew to see what work they might have on the way back to Madrid. We scrambled around a bit and decided there would be no point in trying to get him before White Mtn. Jct., as there were no



**16: AGR RS3 303 creeps along at 10 mph at Milepost 4 on the White Mountain Branch.**





## 17: Meet at Sandy River Jct. AD1, the “Lumberjack” is headed for Dixfield as it passes the 303, in the clear at Sandy River Jct.

good roads that followed the railroad. So we went ahead to White Mtn. Jct. and got a couple of shots of him drifting past the Prentiss & Carlisle wood yard (14-15). There weren't any loads to pick up at the wood yard, so the 303 and modest train departed for Sandy River Jct. Speeds are 10 mph on the White Mountain Branch, so we were able to get ahead of him and grab one tight shot of him in the woods, at Milepost 4 (16). Next up was Sandy River Jct., where the 303 stopped for the junction switch and waited. We were able to talk to the crew, and they informed us that they would remain here until AD1 (Allagash-Clayton Lake-Dixfield), affectionately known as the “Lumberjack,” passed. Our luck couldn't have been better! AD1 was a big-tonnage train made up entirely of wood chips and pulpwood from both the Allagash and neighboring Atlantic Great Eastern (AGE). It served the AGR's biggest customer – International Paper at Dixfield.

[... On to next page of text →](#)



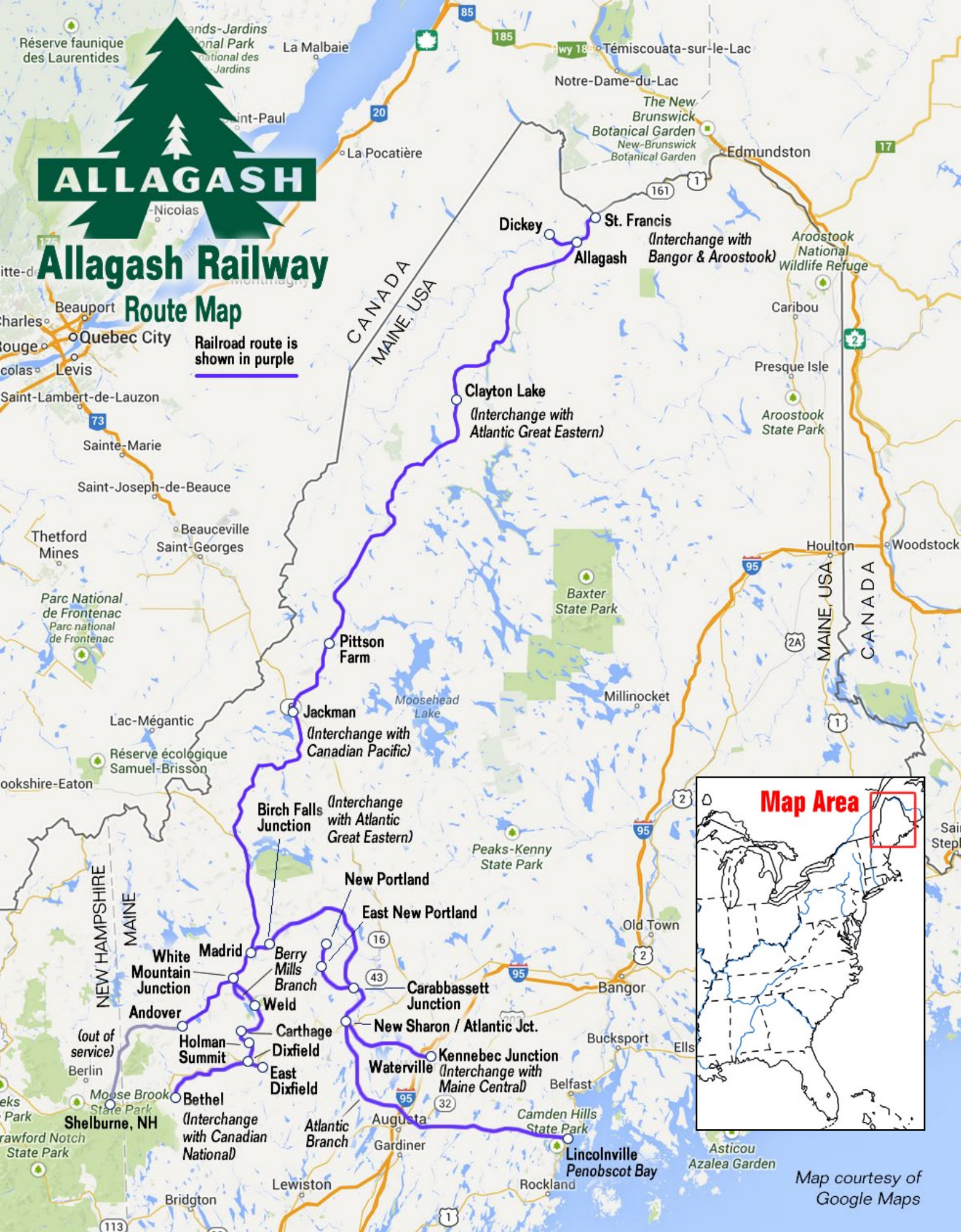

18: Route Map of the Allagash Railway (zoom in to study the details).



Mike Confalone's

# ALLAGASH STORY



## 4 volume eBook series

**Includes Video!**

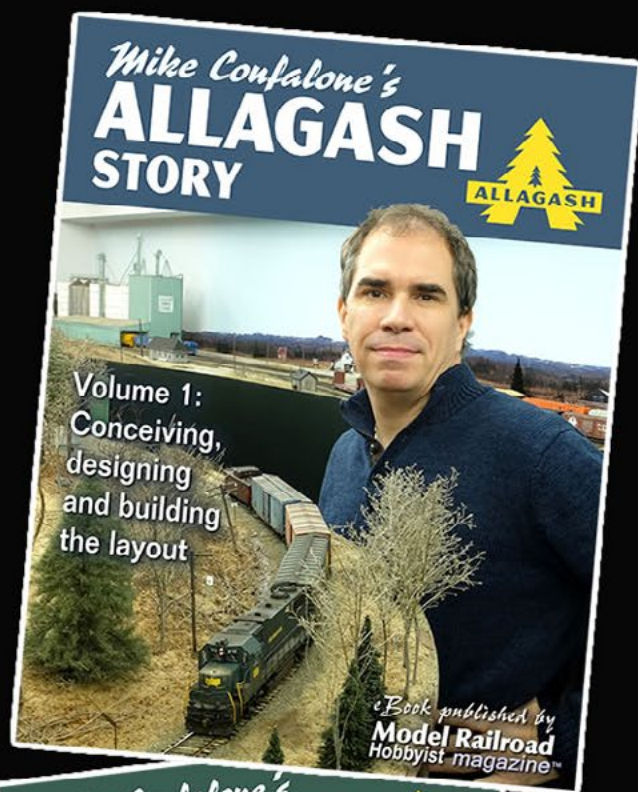

**Vol 1: Building the layout**  
January 28th - \$8.99

**Vol 2: Building the roster**  
February 28th - \$8.99

**Vol 3: Planning prototype ops**  
March 28th - \$8.99

**Vol 4: Bringing the layout to life**  
April 28th - \$8.99

4 vol set: \$29.99

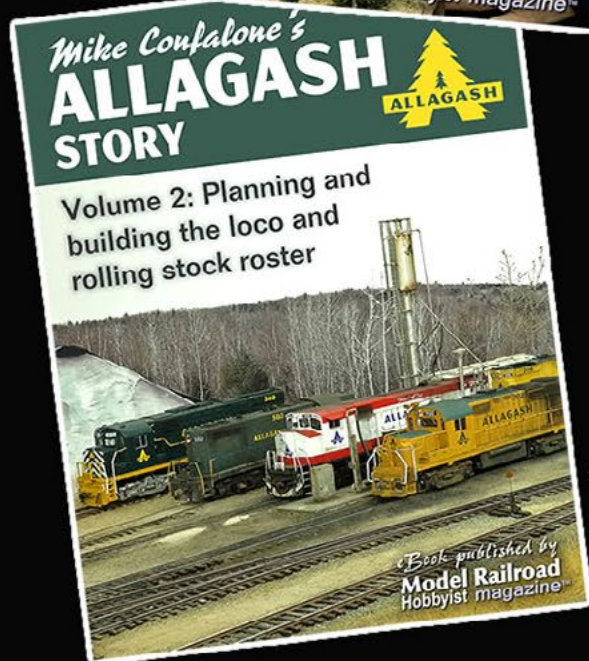

**Vol 1: Pre-order special: \$7.99**

**4-vol set Pre-order special: \$21.99**

**Pre-order Allagash Story**

Formats: PDF - ePub - Kindle

from the  
**Model Railroad  
Hobbyist Store**



[← back to previous page of text ...](#)

The day was getting long and dark, but we finally were rewarded with the train as the “Lumberjack” came into sight. And the power couldn’t have been better. It turns out the Fs were not all in the dead line! Beaten-but-proud F7 607 was in the lead, ahead of a yellow GP38. Although it’s hard to see in the photo (17), in the trailing position was a bright red Atlantic Great Eastern ALCo RS11, one of just two on the AGE. Both were on short-term lease to the Allagash.



Mike Confalone grew up in Smithtown, New York, and got into model railroading at age 10 or 11.

College in the mid 1980s took him away from the hobby for a while, but he still found time to visit the local hobby shop in Scranton, Pennsylvania, and do some modeling on the side.

Railfanning also became a favorite pastime. After graduation in May 1989, he and his wife, Susan, moved to New Hampshire.

He publishes a Northeastern prototype railroading magazine called Railroad Explorer ([railroadexplorer.com](http://railroadexplorer.com)) and has published six books on prototype railroading.

Mike’s proto-freelanced and under-construction Allagash Railway occupies a 58’ x 24’ space – his entire basement and the former two-car garage.

Besides the trains, he and Susan love to garden and landscape their wooded two-acre property in southern New Hampshire. He also plays a mean guitar.

We contemplated chasing, but the light was getting dim. We were beat, and in need of food and a nap. We headed back to Weld, grabbed a pizza and went back to the motel. We crashed for a while, then woke up refreshed. We knew that the AGR ran jobs over the Androscoggin at night, and we had brought along a stash of #2 flashbulbs for our flashguns, and tripods for the cameras. We were ready for night action!



Don't miss *Building the Allagash* with Mike Confalone coming to [TrainMasters TV](#) January 20th ...

This bonus video of the switching job at Andover, MA illustrates how Mike's Allagash Railway does an effective job of making a model railroad feel like the real thing.

## Video: Switching Andover ...



Playback problems? [Click to try a different version.](#)



contents



index

# Yes, it's a model

**Model Railroad Hobbyist's  
monthly photo album**



1: The sun sets on a cold April day while CP 141782 awaits pickup from Cullen Sand and Salt on Ryan Mendell's Algonquin Railway.

Ryan's Algonquin is a freelance railway set in northeastern Ontario in April of 1977. The boxcar is an Intermountain 40' car that has been modified to resemble one built by Canadian Car and Foundry.





2: Ruphe and Tumbelle number 28 eases its train down the side of Pioneer Pass and rolls over a small fill and culvert, one of many the R&T uses to cross the numerous creeks in the area. The rock cut in the background leads into tunnel 1, the last tunnel on the line before the R&T emerges into the foothills and arrives at the town of Tumbelle.

Rick Reimer modified and re-painted On30 BLI C-16. This area is the first scenery to be built on his layout and it sparkles anew since he began augmenting the layout lighting with LED spotlights.



contents



index



3 - 4: An abandoned slaughterhouse slowly decays as the elements take their toll on the structure. No cows and no business for a long time. Just rust, ruin and memories of better times.

The photos were taken on Jure Sporn's freelance layout Wausau & Western, a Milwaukee Road subsidiary set in the 1950s. The structure is scratchbuilt from styrene, covered with paper textures, and weathered.

5 - 5a: ARMN 765123 is the lead car in a string of airfreighted cars waiting to leave California's San Joaquin Valley and head east.

Kevin Packard began with an undecorated Athearn blue box car and modified it with numerous details. He painted, decaled and weathered the model. Weathering was done with acrylic washes, oils, and powders. The weathering was sealed with Dullcote.









contents



index



6: Buck and Loretta (local residents on Rick Wade's HO layout) awoke in the morning and saw all of the food cans on the track and were thankful for the gift they received overnight. However, they were soon disappointed when they realized that they didn't have a can opener large enough to open the cans.

Rick Wade posted this photo on the MRH website to document construction progress on his new layout.

## Advertisement

### Craftsman Kits and Details

**HO Scale Kit, \$149.95**

Includes Lighting & Lots of Details

Coming Soon  
in N & O Scale

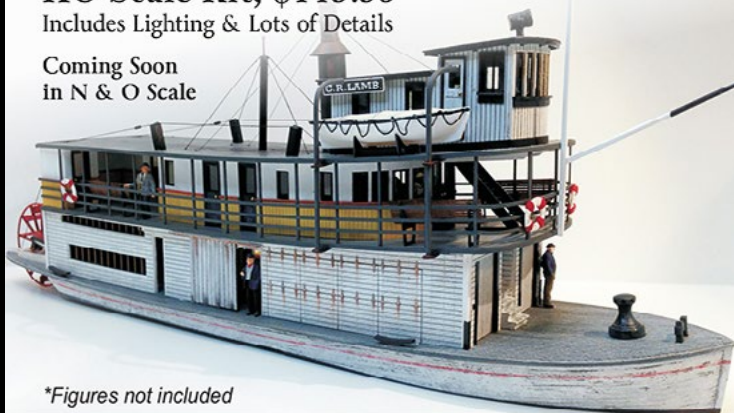

*\*Figures not included*

**HO & N Scale Laser Cut  
Model Kits & Details**



PayPal

Secure on-line ordering

[www.interactionhobbies.com](http://www.interactionhobbies.com)

**INTER-ACTION**  
Enterprises

E-mail: [sales@inter-action.ca](mailto:sales@inter-action.ca)  
Phone: (888) 850-1742



**Reader  
Feedback**

(click here)



Yes, it's ... - 4



contents



index

Our Yes, it's a model monthly photo feature presents some of the most inspiring modeling and photos from the MRH website. If you'd like to get *your modeling* in our photo feature, just start posting your photos on the MRH website, especially in the [Weekend Photo Fun thread](#) created each weekend.

Many of the photos posted show HO modeling, but we'd like to encourage modelers in other scales to post on the MRH website as well. We don't want this to just be an HO photo feature!

For info on how to post photos to our website, [see this help how-to](#). You need to be an MRH subscriber to post photos to our website, and becoming a subscriber is free, [just fill out this form here](#). ■

### Advertisement



Announcing our newest HO-Scale  
Craftsman Structure Kit . . .

## The Tiffany Clockworks



Order yours today at [www.motrakmodels.net](http://www.motrakmodels.net)





# Sheffield Velocipede

-Ray & Renee Grosser, MMR

Photos by the authors

Turn of the century  
MOW equipment ...



Reader  
Feedback  
(click here)



**T**he Sheffield Velocipede was invented by a Michigan farmer named George S. Sheffield in 1879. The contraption was used by a number of railroads, including the Soo Line. I distinctly remember riding on one of these as a kid in the late 1940s on the RIP track of the Glenwood Minnesota division point of the MSt.P&SSM, where my dad worked as a brakeman. The pedals and moving handle bars were what powered it, and it worked so well that an 8-year-old could operate it. Manufacturing rights were sold to Fairbanks-Morse in 1888 and the machine was made by them for the rest of its life.



Originally these were used by section men to check their section of track. By the time I remember riding on the one at Glenwood the section, crews all had the Fairmont Motor "safety first speeders" so they could cover more track in less time and carry track tools with them.

I found that if you do a 'Search' for "Sheffield Velocipede" you could read all night long. Here is a web page showing a restoration of one of these in California. [slorrm.com/pix\\_stock/velo\\_poster.pdf](http://slorrm.com/pix_stock/velo_poster.pdf)



## 1: 1879 edition, Car-Builders' Dictionary

### The model

The O scale kit is a straightforward white-metal casting that Keith Wiseman makes in his own shop. They are much too fine and delicate to try to solder together, so I assembled mine using ACC gap-filling PS-2. The kit goes together without any problems, and all the parts fit very nicely together.

I found the isometric drawing to be a little confusing, especially the drill sizes to use for the locating pins and various axle holes. The kit has two sizes of wire – .016" and .033". Other than one note stating to drill a #76 hole for the guide arm



contents



index

brace, I found no other reference to the hole sizes needed for the other axle shafts, so I made all the other holes the clearance size for .016" wire (#78 drill bit).

After mounting the .016" wire as the guide arm brace, it looked too light, so I changed it to a .033" wire that gives my model a more meaty appearance. All the other holes should be drilled with a #78 drill bit, for clearance of a .016" wire that is included in the kit. Other than that, the kit went together easily – well, reasonably easily for my 71+ year-old fingers.

## Fidelity

It is difficult to measure this thing precisely, but given the data I was able to find, it appears to be spot-on with the prototype. The model is gauged for Proto 48 track, but it can be built to any of the O scale track gauges and, since it is a non-working



## 2: The Wiseman Model Services O scale kit.





**3: A trackman talks with the station agent and coworker about the weather before climbing aboard his velocipede and starting his day of inspecting the rails.**

model, the gauge does not have to be precise. I built mine to Proto 48 scale because it was going to be a static model outside the coaling shed. The short outrigger may be installed for the narrow gauge model of 3' but the arm will need to be shortened a little to make the 30" gauge model.

The PDF I found shows a restored model to be painted safety yellow, so I painted mine with Floquil #31 Reefer Yellow.

## Conclusions

The machine is compatible with almost every railroad and diorama in the US and a number of foreign countries as well.



This is a non-working model, so I did not attempt to make it functional in any way, including making the wheels turn on the axles.

I really enjoyed making this interesting detail model. Velocipedes were light enough to allow one man to clear the track by lifting one end and walking back with the whole shebang.

The kit does not have any decals, but a very small one in black reading SAFETY FIRST might be nice.



**4: A velocipede setting off the tracks waiting for a trackman to use it.**

# Parts List

Sheffield Velocipede from Wiseman Model Services Inc.

The white metal kit retails for \$9.95 from Wiseman Model Services Inc.

898 Black's Cross Road

Paris KY 40361

859-484-9573

[kwiseman@pqisp.com](mailto:kwiseman@pqisp.com)

[www.wisemanmodelservices.com](http://www.wisemanmodelservices.com) ■



Ray Grosser MMR 362 has been model railroading since his first train in 1948. Renee Grosser started scratchbuilding her structures in 1992 first in HO and then in O scale. She scratchbuilt all

but a few of the structures on the O scale Nostalgia Trip railroad and this layout is just a display pedestal for her work.



contents



index

# Modeling a railroad radio base station

– By **M.R. (Matt) Snell**

Photos by author

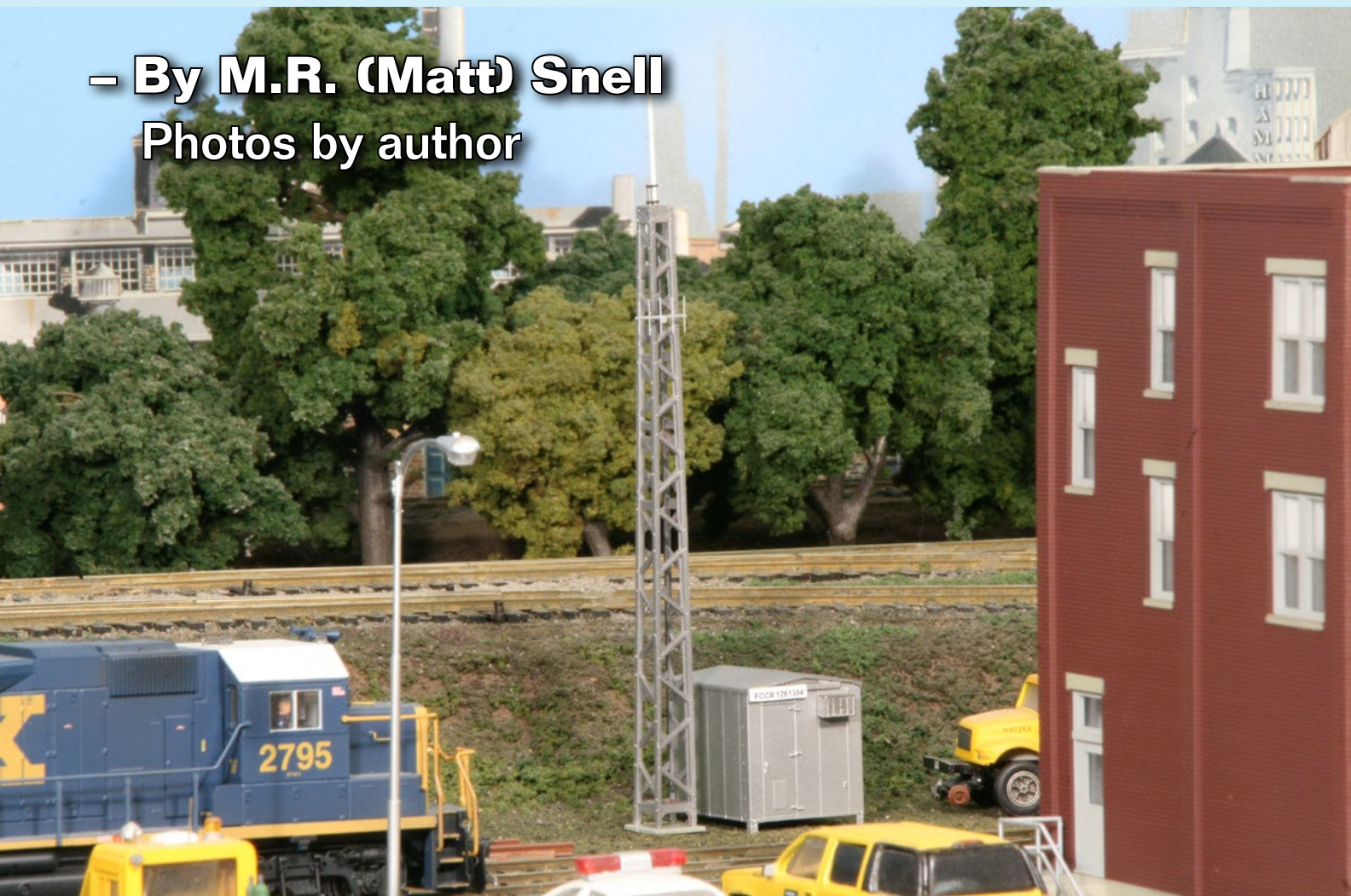

**An inexpensive one evening project ...**

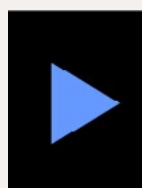

**Reader Feedback**  
(click here)



**O**ver the last century railroading has undergone numerous changes as new technology has made train operation safer and more efficient. We've witnessed the development of advanced signaling systems, continuous welded rail, and high-capacity freight cars yet one of the most profound developments of the 20th century often remains unrecognized.



Radio has forever changed the railroading landscape, enabling train dispatchers to control their territories from hundreds or even thousands of miles away while eliminating the need for towers and wayside operators. No longer is a tower operator required to hoop up train orders. Instead, communication between train crews and dispatchers is now direct, facilitated by a series of wayside radio base stations carrying radio and data signals throughout the railroad.

Strategically placed to maximize signal strength, the exterior of a base station presents nothing more than a group of small antennas mounted on a tower accompanied by a nondescript equipment housing, making it a lineside detail that is easily overlooked.

Although plain on the outside, the interior is quite complex as groups of electronic devices receive and transmit signals enabling radio communication over large distances. Since our focus as modelers is in replicating the visible rather



**1: The prototype used as the basis of this kit-bash. It's located on the NS Chicago line.**



contents



index

than the unseen, adding a radio base installation to a layout is a fast and easy project that fills a void in modern era detailing while demanding very little space.

## Study the real thing

Before we start our project, let's briefly look at a typical radio base station. Located at MP 193.85 of the Norfolk Southern's Chicago Line is an easily overlooked short lattice style tower and standard railroad style equipment enclosure, carrying a small sign displaying FCC ID# 1261384 in black lettering. A check of this Federal Communications Commission identification number shows that this par-



### 2: The Tyco microwave tower that is used for the kitbash.

ticular tower was erected in February 2008 with an overall height of 22' 9".

A visual inspection shows it carrying one whip style antenna at the top, with smaller yagi antennas mounted on the lattice framework of the tower. This short tower requires no guy wires for stability. It is exempt from the FAA requirement of aviation orange and white striping with warning lights, a regulation generally applied to installations in excess of 200' above ground level.

Now that we've looked at the basic components of a base

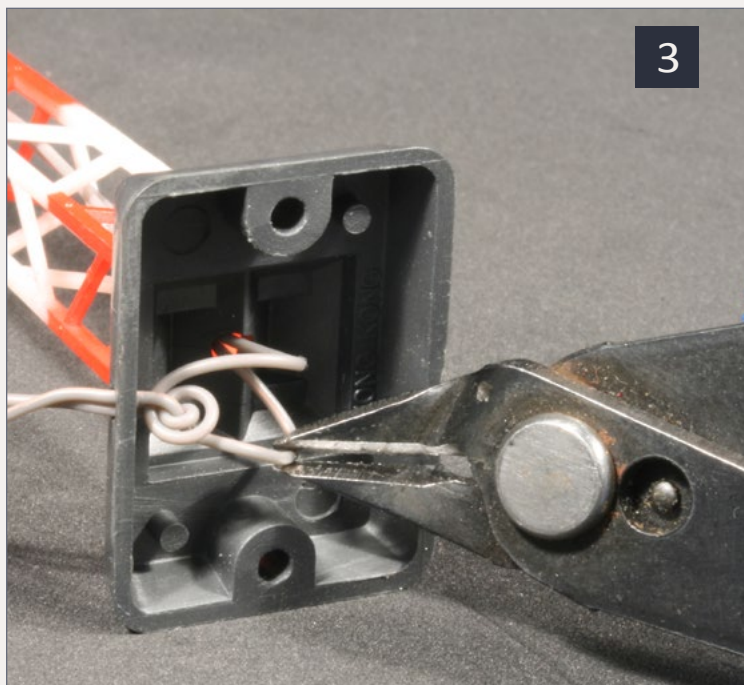

**3: Begin disassembly of the microwave tower by cutting the wires at the base.**

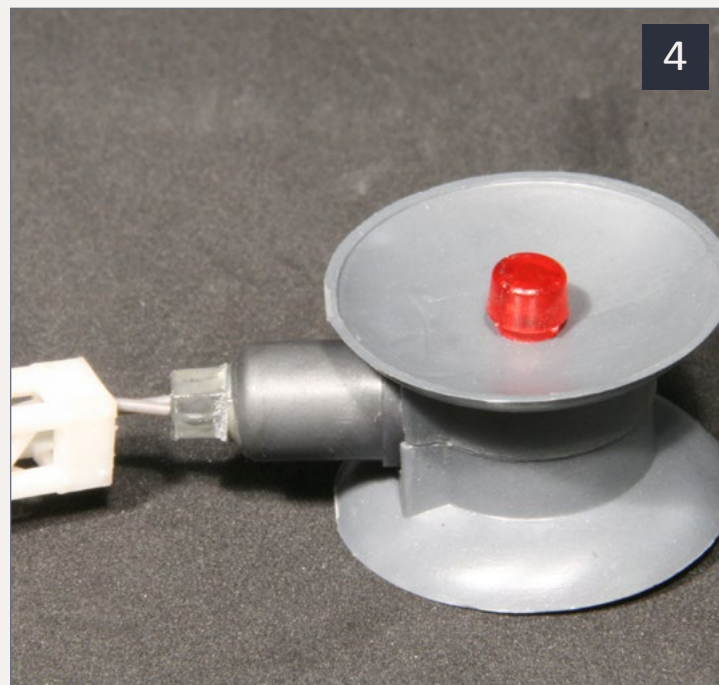

**4: Remove the microwave dish from the top of the tower.**

installation, we can begin constructing our own vignette using an accessory commonly found in the scrap bins of many train show vendors – the Tyco Microwave Tower. Originally marketed in the Tyco Light-Ups line, this model is still available today from NJ International (#525-1974). Although it's unreasonably short for its intended microwave installation, its 38' scale height and lattice framework make it ideal for kitbashing into a base station antenna tower.

## **First step: Disassembly**

Initially produced in the 1960s, the Tyco tower is typical of many older accessories, with thick paint and copious amounts of glue making disassembly the first step in enabling the tower to be tailored to its new use.

As this was designed as an operating electrical accessory, we'll begin by cutting the two wires extending between the rear of the base and the microwave dish at the top of the



contents



index

tower, removing the wiring from the hole in the base. With the wiring severed, we can now remove the dish casting and bulb mount assembly from the top of the tower by gently pulling it intact from the tower. If it cannot be removed due to glue, cut or break off the small mounting stem of the bulb housing and leave it embedded in the top of the tower. The final step in tearing it down is to remove the crude oversize base from the lattice tower by carefully cutting through each leg with a razor saw. Leave as much of each leg intact as possible.

We are now left with a bare lattice tower that can be rebuilt from the bottom up, starting with a new concrete base. Unlike the Tyco accessory, the concrete base of a tower is generally small and low profile, easily replicated by a single square of Evergreen #4518 sidewalk styrene. Pre-scored into  $\frac{1}{2}$ " x  $\frac{1}{2}$ " squares, a single square presents us with a base 43 scale



**5: The final step in tearing it down is to remove the crude oversize base from the lattice tower by carefully cutting through each leg with a razor saw.**



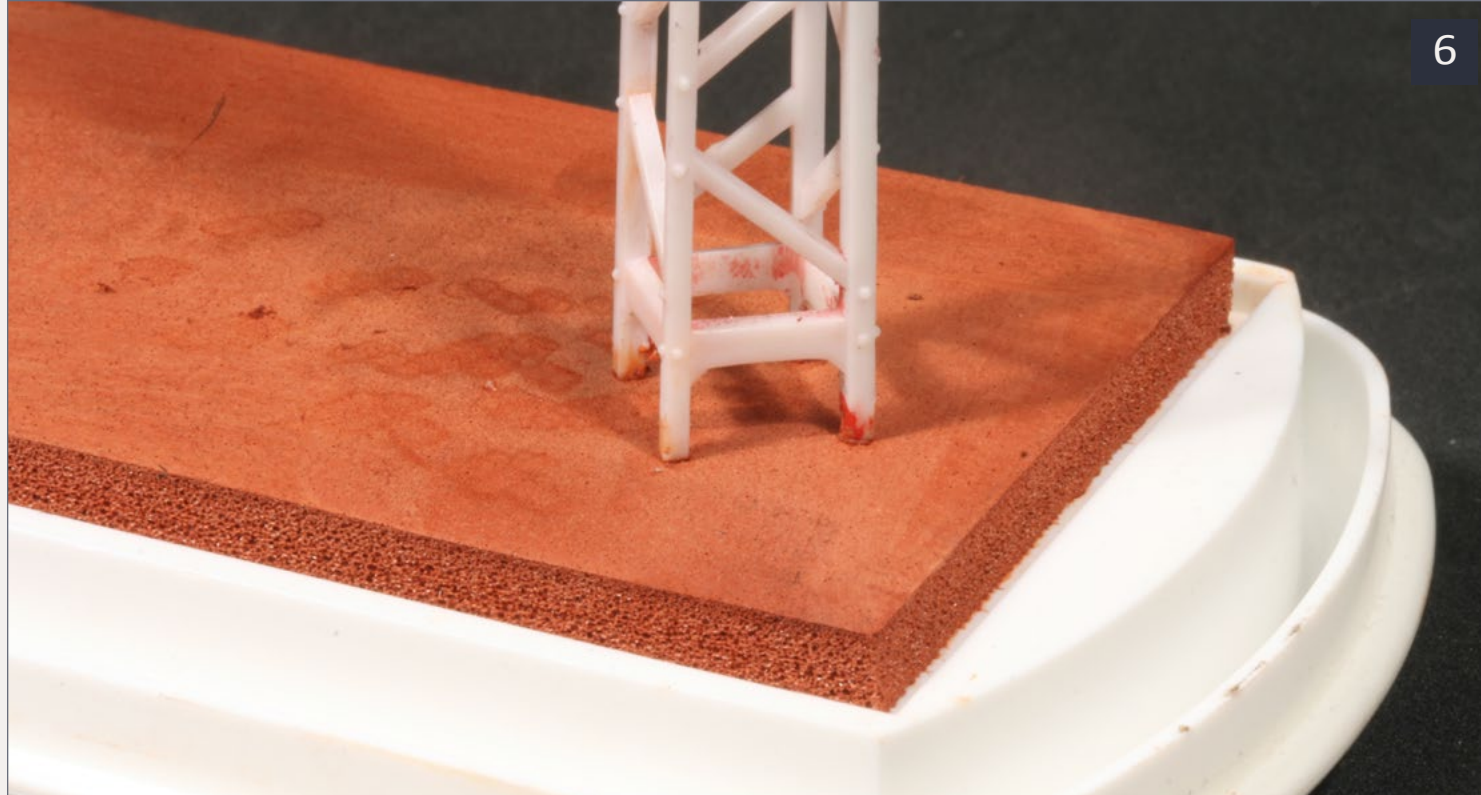

**6: Level all four legs of the tower with a file. Take your time so that the tower will stand vertical and not lean to one side or the other.**

inches across and .040" thick, deep enough to rise above its surrounding ground cover, yet shallow enough to easily blend with its surroundings.

## **Locating tip**

While creating the new base requires little more effort than snapping scored styrene, mounting the tower on it can be frustrating and time consuming. Anyone who has ever installed a detail with multiple mounting stems can attest how difficult aligning the drill points can be. Mounting the tower on the base requires drilling four holes, one for each leg of the tower. Rather than locate the drill points by measuring and marking intersecting lines, an easier way is to level all four legs of the tower with a file and then dip them into a stamp pad. Carefully place the tower on the base, allowing the bottom tip of each leg to transfer the stamp ink to the base, instantly creating accurate points that can be drilled with a pin vise.



contents



index

With the base complete, we can move to the opposite end of the tower. Removing the dish and bulb assembly from the top of the tower leaves a large hole which must be filled to support the new whip antenna. If the bulb housing was removed cleanly, cement a short length of Evergreen #105, .100 x .100" styrene strip into the top of the tower and cut it flush. This will fill this large hole. The thick factory-applied red and white paint can be removed with Scalecoat 2 paint stripper, leaving a clean surface suitable for airbrushing a dull steel color

After airbrushing, the rebuilt tower can be further tailored to its new use by adding several antennas suitable for way-side base stations. A photograph of the Norfolk Southern

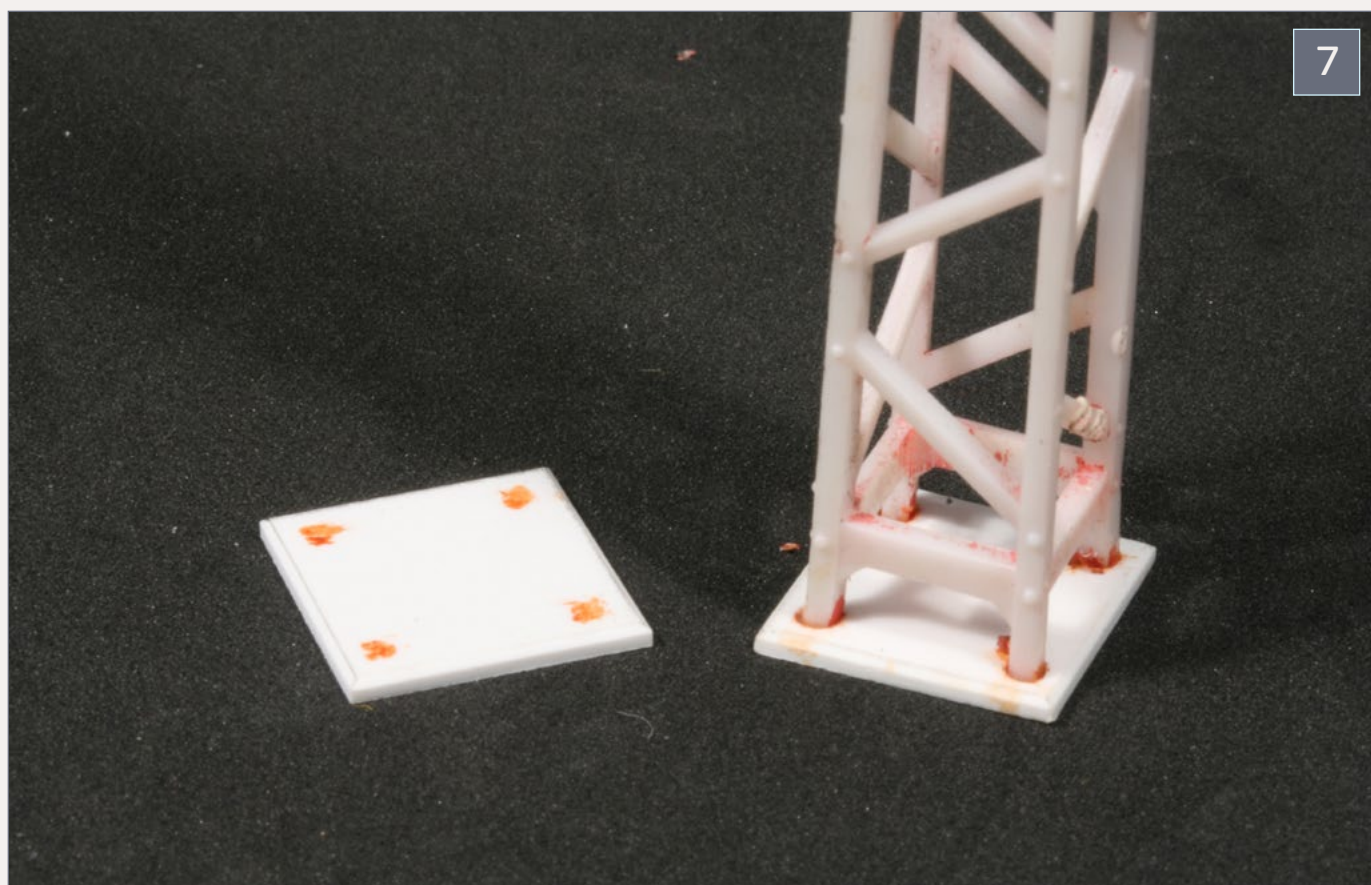

**7: Dip the legs into a stamp pad. Carefully place the tower on the base, allowing the bottom tip of each leg to transfer the stamp ink to the base, instantly creating accurate points that can be drilled with a pin vise.**

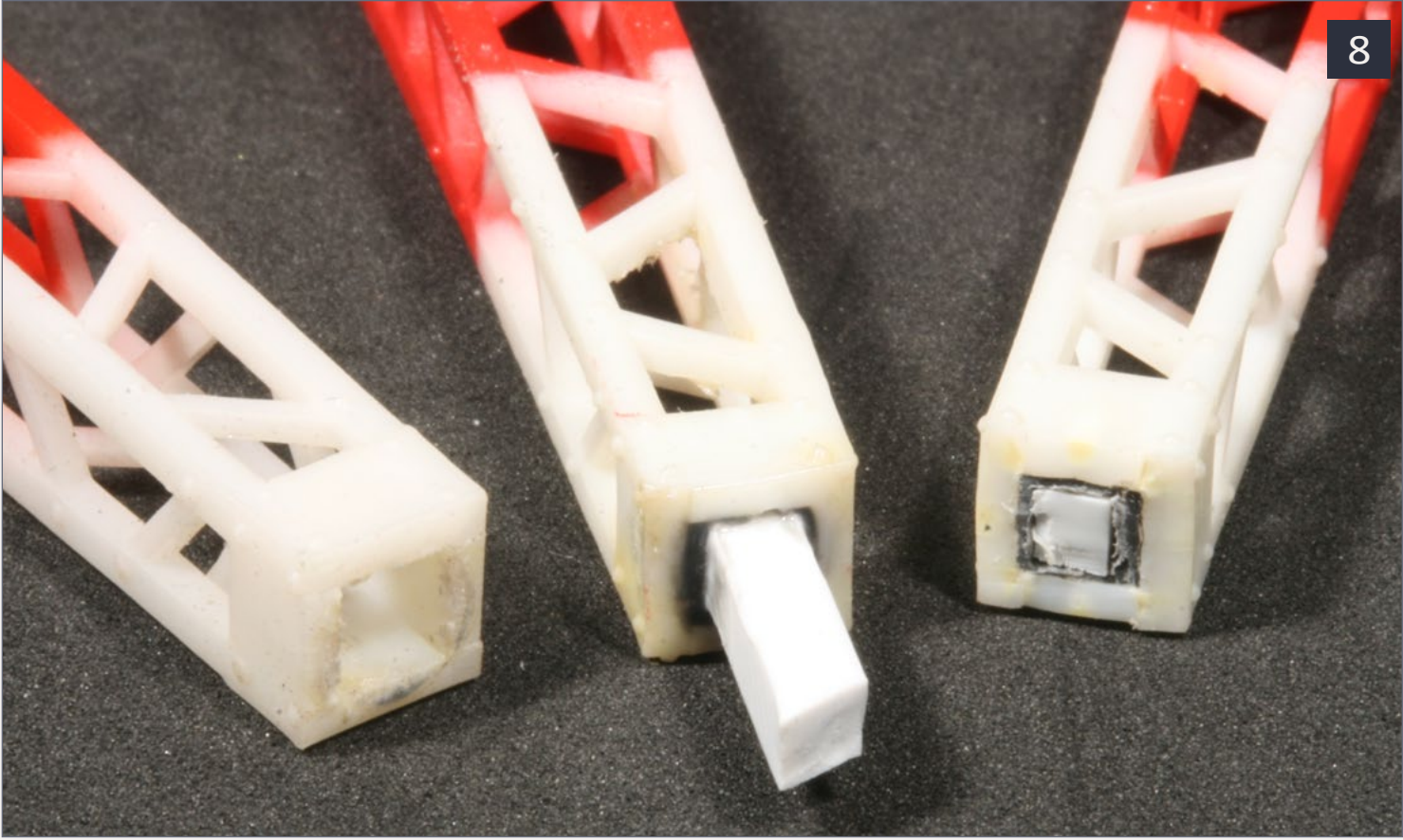

**8: A short length of Evergreen #105, .100 x .100" styrene strip into the top of the tower and cut it flush. This will fill the large hole.**

installation reveals a long omni-directional whip style located at the top of the tower. Replicating this style of antenna is almost effortless using thin brass rod which can be easily cut and formed. However, in this instance, looks may prevail over true prototype dimension.

## **Scale parts and visibility**

In photography, we often encounter a phenomenon known as perspective distortion, wherein the angle of a photograph will change the way elements appear in the photo. Similarly, when we view an object such as a tower-mounted antenna, it may appear a different size or even a different color depending on factors such as lighting and the background it is viewed against.

Keeping this in mind, I recommend using materials with dimensions that look good in your own individual situation,



basing them on the angle of view, the proximity to the viewer, and the tower's surroundings.

9



**9: The Norfolk Southern installation reveals a long omni-directional whip style located at the top of the tower. The smaller directional antennas have the look of an older style television antenna, often referred to as yagis.**

For example, to create the base antenna for my own tower, I chose .033" diameter brass rod (Detail Associates #2509) whose scale diameter is nearly twice that of the typical prototype base antenna. Likewise, I doubled the typical 42-48" length, which makes the thick antenna appear thinner yet still provides enough mass to stand out amongst the trees and busy backdrops.

After choosing an appropriate size, it's now simply a matter of constructing the antenna and its support pipe, then adding them to the top of the tower. Cut two lengths of rod, the first to a scale 24" and the second to the desired antenna length, adding 12 scale inches. Next, drill two holes of the corresponding rod thickness into the top of the tower, locating the two side by side and as close together as possible.

Cement the shorter rod in place, allowing half of it to extend from the top of the tower to form the support pipe. Then insert, but do not cement, the antenna rod into the hole adjacent to the support pipe.

With both the antenna and support pipe extending upward from the tower, we can now fashion brackets from styrene strip to tie them together. Since very little material is required, almost any size of .015" or .020" thickness styrene can be used to form the brackets, provided it is wider than the rod diameter and longer than the horizontal measurement of the two rods mounted side by side.

I chose two ½" long pieces of Evergreen .015" thick styrene strip, which were slightly wider than the rod stock. The plastic was left over from another project, now rescued from scrapbox oblivion.

Begin by drilling two holes side by side, one for the support pipe and the other for the antenna. Next, transform the rectangular strip into a long triangular shape by cutting at a downward angle from top to bottom, removing the excess

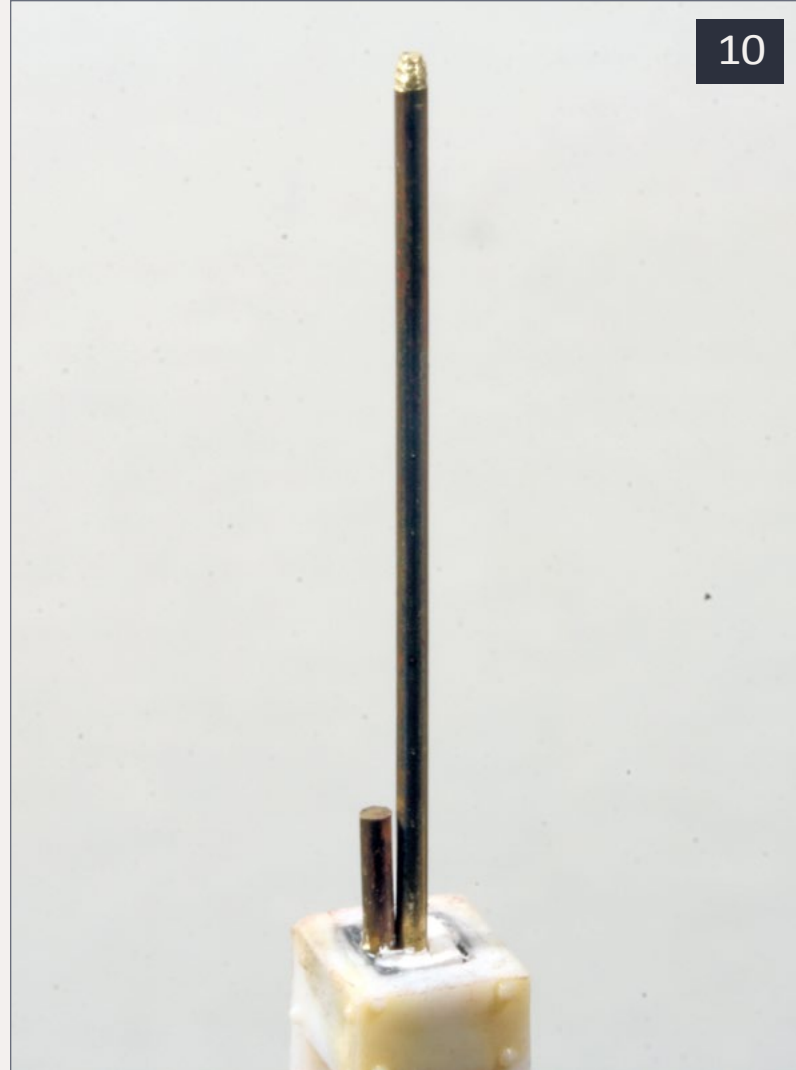

**10: With both the antenna and support pipe extending upward from the tower, we can now fashion brackets from styrene strip to tie them together.**



material extending outwards beyond each hole. Finally, cut downward forming a long rectangular hexagon that will

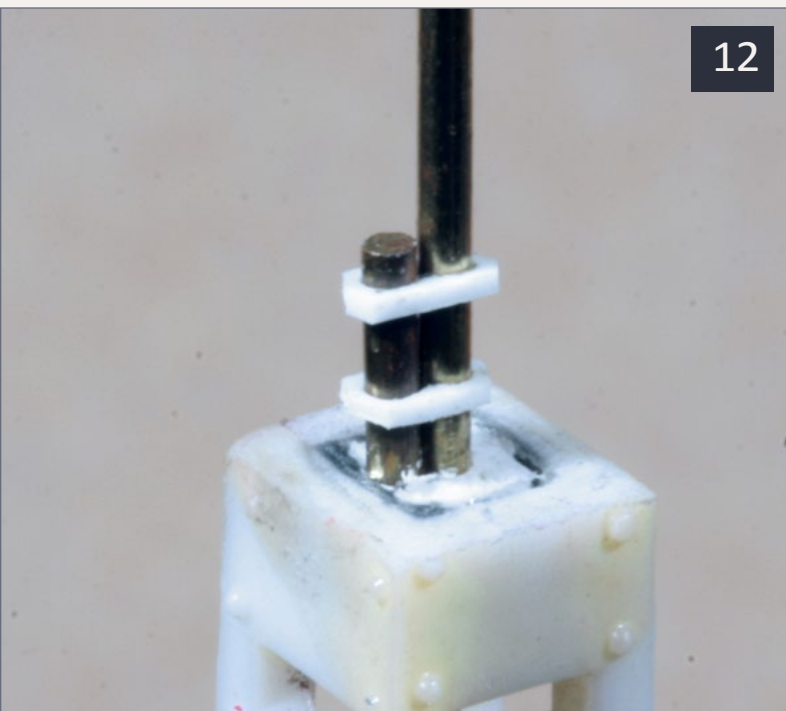
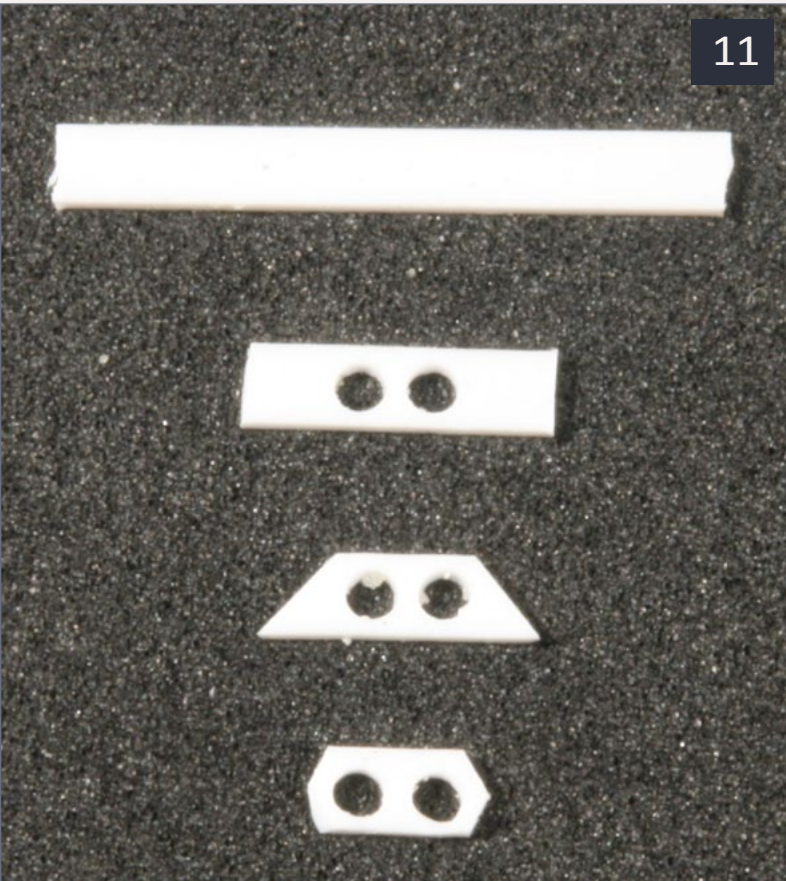

**11 - 12: The brackets that tie the support pipe and antenna together are made from .015" styrene strip.**

slide over both the support pipe and antenna. Then, test fit each tying bracket, further adapting them with a knife or file as necessary. Once you are satisfied with their look and fit, both the antenna and tying brackets can be removed for painting. When the paint has dried, permanently reinstall them to complete the long omni-directional antenna atop the tower.

## **Add the small antennas**

While the large whip antenna may be the most dominant feature of a base station tower, it is also common for a tower to carry multiple smaller antennas as well.

Often referred to as yagis, these smaller directional antennas have the look of an older style television antenna and are easy to replicate using Gold Medal

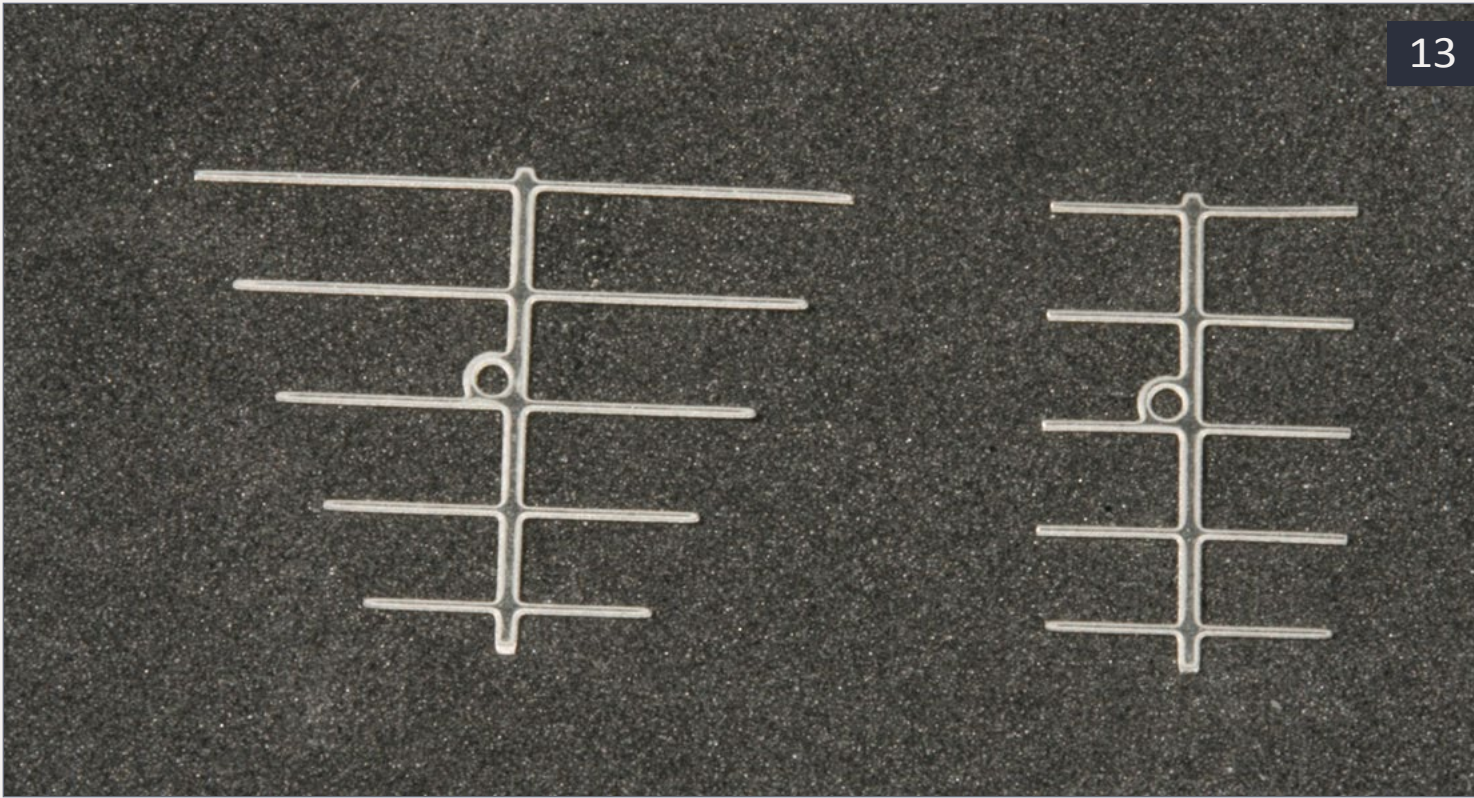

### 13: The "yagis" are Gold Medal Products TV antennas.

Products #8705 rooftop TV antennas. Each photoetched metal kit provides us with three styles of large antennas that can be easily modified into smaller railroad band VHF antennas by simply trimming the thin metal, then mounting the antennas to the lattice frame of the tower.

With the centerpiece of our base installation complete, we can focus on the ground level. With the electronics concealed in an equipment enclosure adjacent to the tower, all we need to model is the enclosure itself. A large electrical box manufactured by BLMA (#4312) has both the correct size and look for this type of modern installation.

While the enclosure generally follows the standards established by a particular road, one difference of a radio base enclosure is the addition of air conditioning. Radio equipment is temperature sensitive and it is common for a base enclosure to have a small window style air conditioner fitted, relieving the sensitive electronics from heat build up.



contents



index

Replicating this requires nothing more than cementing a white metal casting to the enclosure. A Scale Structures #2467 window air conditioner provides a one-piece casting small enough to look appropriate without overpowering the front of the enclosure.

## Make a sign board

The final step in creating our base station vignette is to add a small sign giving a hint to why this particular lineside installation is there. Creating a plain alpha-numeric sign similar to the one mounted to the Norfolk Southern enclosure is easy using a home computer with a spreadsheet program. All it requires is choosing the correct font, then typing in the characters several times using varying sizes such as 8, 9, and

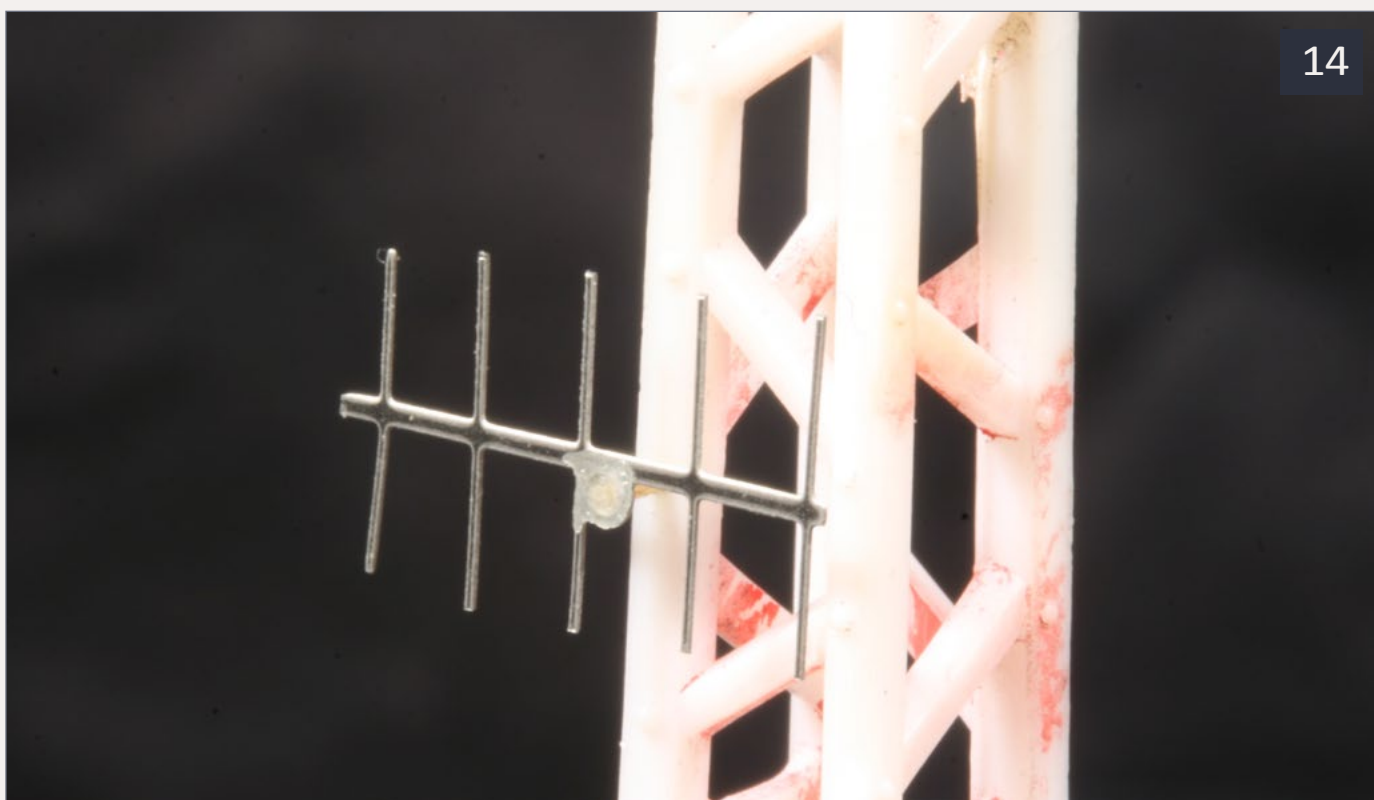

**14: Each photoetched metal kit provides 3 styles of large antennas that can be easily modified into smaller railroad band VHF antennas by simply trimming the thin metal then mounting the antennas to the lattice frame of the tower.**





**15: The prototype equipment enclosure on the Norfolk Southern. I modeled my equipment cabinets after these units.**

10 point type. This will give us a variety of sizes to choose from. Now the sign can be printed onto cardstock, reducing its size by printing using a reduced scale. Then cut the sign to size and mount it to the front of the enclosure, the FCC moniker telling everyone this is a radio installation.

Adding a modern lineside detail to the layout does not require major effort or expense. It may also provide new life for an older accessory that we may have passed over as toy-like, giving it a home beside the latest of our high-tech scale models.

*Information continued on the next page ...*



contents



index

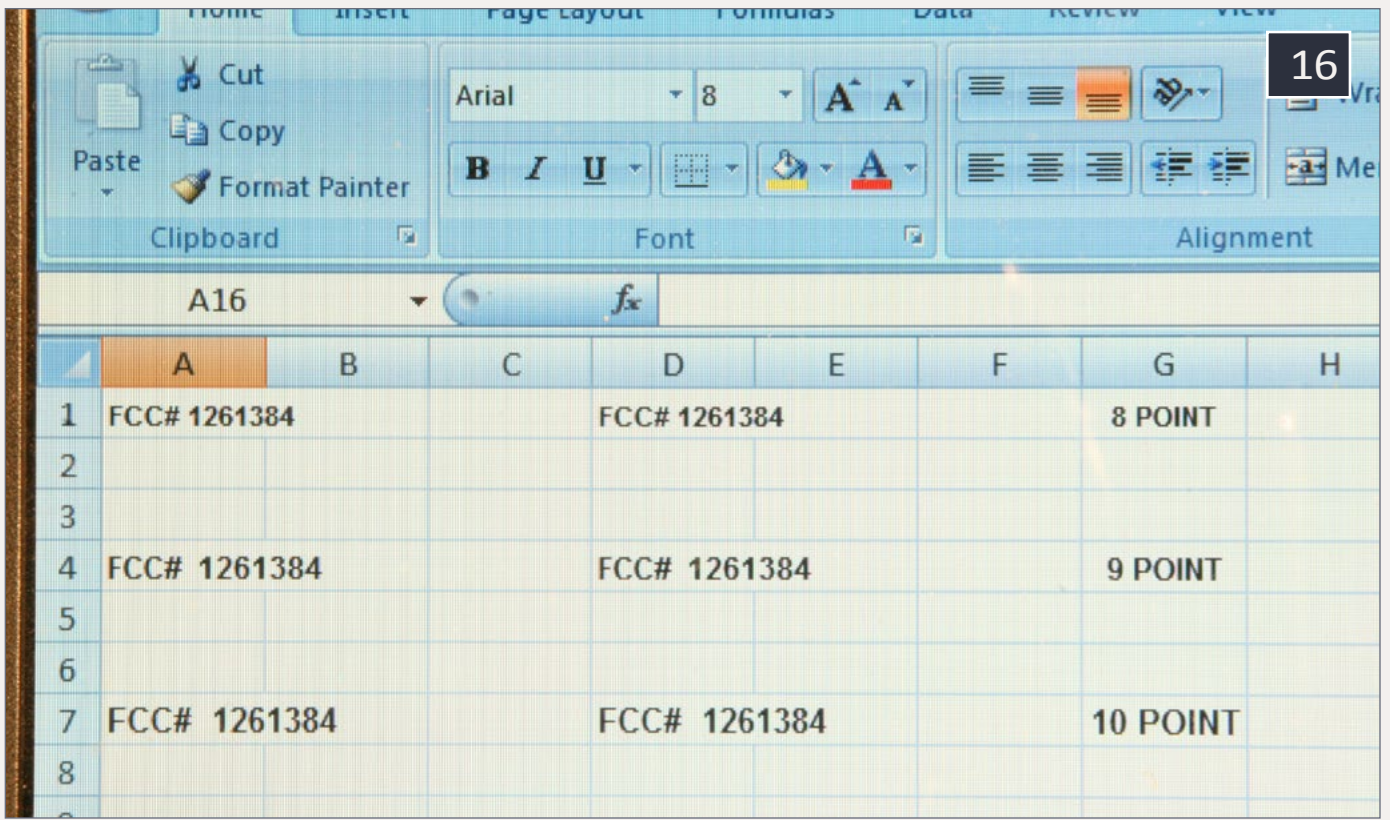

**16: Creating a plain alpha-numeric sign similar to the one mounted to the Norfolk Southern enclosure is a rather easy task using a home computer with a spreadsheet program.**



**17: The completed equipment cabinet.**

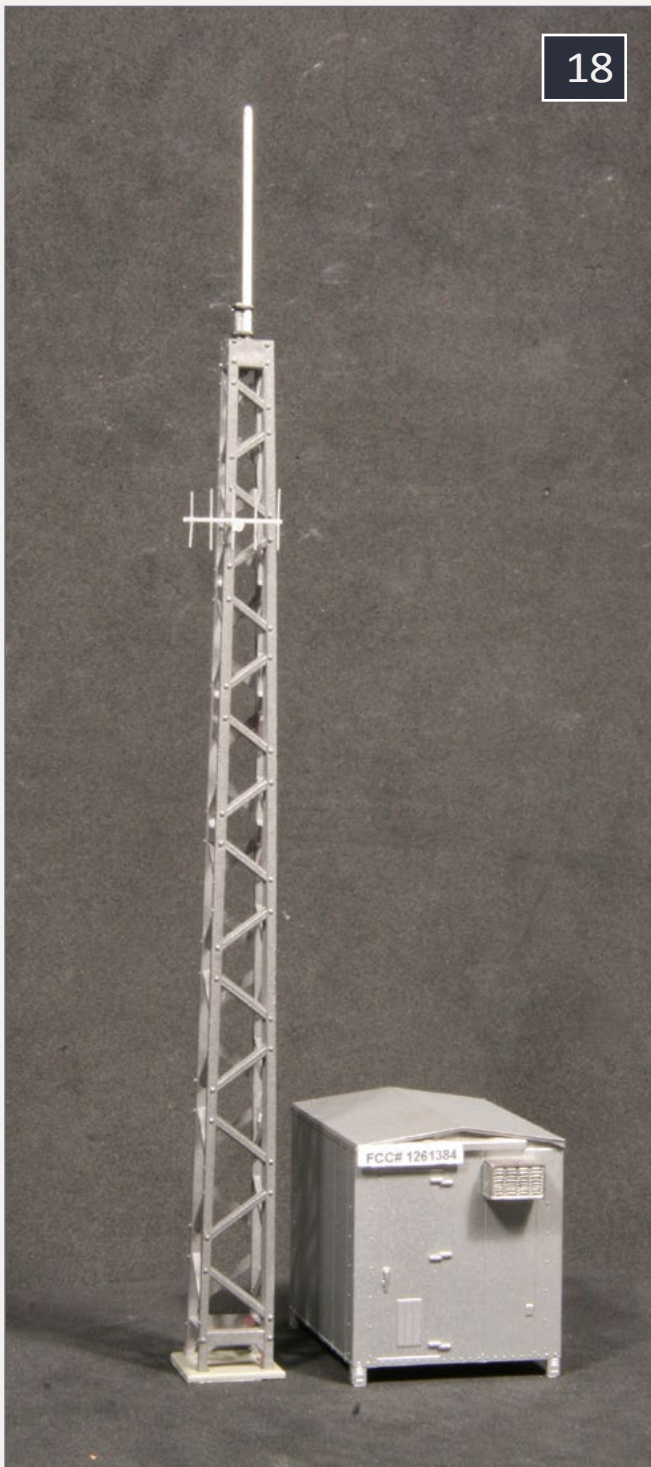

**18: The completed equipment cabinet and radio tower ready for installation on the layout.**

## Parts List

Microwave tower – Tyco (out of production) or NJ International (#525-1974)

Concrete base – Evergreen #4518 sidewalk styrene

Filler for top of tower – Evergreen #105, .100 x. 100” styrene

Whip antenna and support pipe – Detail Associates #2509, .033” brass wire

Antenna brackets – Evergreen .015” styrene strip

‘Yagi’ antenna – Gold Medal Products #8705 rooftop TV antennas

Equipment housing – BLMA #4312 large electrical box

Air conditioner – Scale Structures #2467 window air conditioner

Paint remover – Scalecoat II paint remover for plastics (#640-10568)

Paint – Testors Steel, Floquil Concrete, Floquil Reefer White ■





M.R. (Matt) Snell has been a model railroader and railfan for 30 years. His interest in railroading blossomed while growing up in New Jersey surrounded by multiple freight and passenger rail lines including Amtrak's Northeast Corridor.

Presently residing in Ohio far from his railroading roots, Matt and his wife Debbie share the hobby, modeling the area he grew up in: north-central Jersey.

Their "Conrail New Jersey Division" layout has been featured in Great

Model Railroads, Rail Model Journal, and in the Allen Keller Great Model Railroads DVD series. Matt has had articles in Railroad Model Craftsman, RailModel Journal, Scale Rails and Model Railroader, as well as online at railroad.net.

Advertisement

# Don't Waste Time!

Get an **IOWA SCALED ENGINEERING**

**WIRELESS NETWORKED**

**Fast Clock System!**

**CLICK TO  
LEARN MORE!**

<http://iascaled.com/fastclock>



open source  
hardware



Simple Installation (No Wires!)

Unlimited Remote Displays

Highly Configurable

MRH-Jan 2014



# Railroad Radio

As modelers we commonly add detail castings representative of radio communication to our models without giving any thought to how radio systems work and how vital they are to modern rail operations.

Most railroad radio communication in the USA and Canada utilizes 96 radio frequencies located between 160 and 162 MHz on the VHF (Very High Frequency) radio band. The frequencies are standardized by the American Association of Railroads and each has been allocated a channel number between 2 and 97. Modern radios are capable of accessing the full spectrum. In the past, with simpler radios, leading locomotives had to be a home road unit equipped with the proper radio channels for the territory it was operating in.

In addition to the VHF spectrum, bands on the UHF (Ultra High Frequency) spectrum are also in limited use for End-Of-Train telemetry. Both bands can be monitored with a hand-held scanner, enabling railfans to hear conversations between dispatchers and trains, crews performing switching, talking defect detectors, and other rail operations.

While 96 channels are available, it is important to note that only certain channels are in use within specific geographic areas and that specific channels are also designated by road. This insures that everyone within a railroad district is using the same frequencies. The frequencies for a geographic area or rail line are generally listed in the railroad's employee timetable.

## Listening in

Monitoring railroad communications can be more than just fun, it can help us learn how the prototype operates while also providing a useful tool for railfanning.

# AAR Channel Designations

Ch	Frequency	Ch	Frequency	Ch	Frequency	Ch	Frequency
2	159.81	26	160.5	50	160.86	74	161.22
3	159.93	27	160.515	51	160.875	75	161.235
4	160.05	28	160.53	52	160.89	76	161.25
5	160.185	29	160.545	53	160.905	77	161.265
6	160.2	30	160.56	54	160.92	78	161.28
7	160.215	31	160.575	55	160.935	79	161.295
8	160.23	32	160.59	56	160.95	80	161.31
9	160.245	33	160.605	57	160.965	81	161.325
10	160.26	34	160.62	58	160.98	82	161.34
11	160.275	35	160.635	59	160.995	83	161.355
12	160.29	36	160.65	60	161.01	84	161.37
13	160.305	37	160.665	61	161.025	85	161.385
14	160.32	38	160.68	62	161.04	86	161.4
15	160.335	39	160.695	63	161.055	87	161.415
16	160.35	40	160.71	64	161.07	88	161.43
17	160.365	41	160.725	65	161.085	89	161.445
18	160.38	42	160.74	66	161.1	90	161.46
19	160.395	43	160.755	67	161.115	91	161.475
20	160.41	44	160.77	68	161.13	92	161.49
21	160.425	45	160.785	69	161.145	93	161.505
22	160.44	46	160.8	70	161.16	94	161.52
23	160.455	47	160.815	71	161.175	95	161.535
24	160.47	48	160.83	72	161.19	96	161.55
25	160.485	49	160.845	73	161.205	97	161.565



There are several ways we can listen in on railroad communications. The traditional way is to use a scanner, a radio capable of listening to communications in the VHF and UHF radio spectrum. Programmable radio scanners are available in both hand-held and mobile/base models with various features. A scanner for monitoring railroads should be capable of receiving the 160-162 MHz range, the frequencies reserved for railroad communications.

*IMPORTANT: Laws governing scanner usage while in a vehicle vary from state to state. It is essential to verify the laws in your region prior to purchasing or using radio equipment.*

A second way to listen to railroad communications is via live radio streams on the Internet. These online scanner feeds allow us to listen in on radio talk from various roads or regions around the U.S. For more information on live streams visit: [railroadradio.net](http://railroadradio.net). ■

*Information continued on the next page ...*



contents



index

# Detailing A Radio Equipped Fleet

Careful observation of prototype equipment will generally provide us with evidence of radio equipment invisible from the outside. One telltale is an antenna, a detail many modelers have been adding to their fleets for years. Antennas for rail equipment are often specialized, and their style and placement varies from road to road. Antennas are optimized for performance in the service and the operating terrain.

Several of the most common are:

- The whip antenna. This style of antenna is most commonly found on vehicles and maintenance of way equipment. Some roads have chosen the whip style for locomotives and cabooses as well. Found in lengths from 12" to 36", this detail can be easily added using thin wire inserted into a small hole drilled into the roof of the equipment.
- The Sinclair antenna. Looking more like a large handle than a radio antenna, the Sinclair style is used almost exclusively by railroads. Commonly installed on the roof of a locomotive cab, the Sinclair is a detail that can be added using castings from Detail Associates, Details West, and several other parts manufacturers.
- The End-Of-Train antenna. Resembling a much smaller version of the Sinclair style, the EOT antenna is common to roads using end of train equipment that transmits on the UHF band.
- The firecracker antenna. Aptly named, the firecracker style is one of the most visible antennas, as it stands straight up from the roof it is installed on. While an easy detail to add using castings, it is also easily broken so a metal casting is recommended for models that will be handled.





**19-20:** The roofs of this maintenance truck and a locomotive show two installations of whip antennas. Whips are generally mounted near the center of a roof to create a ground plane which optimizes the performance of the antenna.

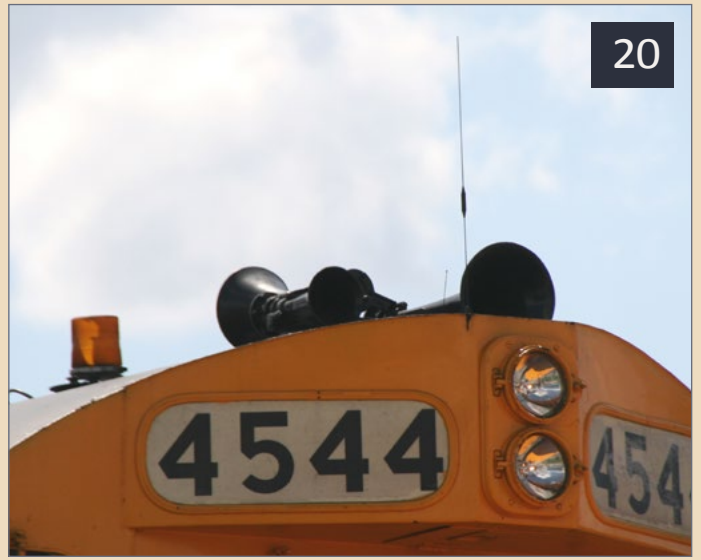

- The dome antenna. A more modern installation, the dome incorporates multiple antenna technologies within one enclosure. Found in square, octagonal and round styles, this detail is available from multiple manufacturers, including Hi-Tech Details whose white plastic molding requires no painting.
- The antenna array. Becoming more common as radio equipment becomes more advanced are arrays consisting of multiple antennas capable of transmitting and receiving data, voice and GPS data.

*Information continued on the next page ...*

Advertisement

**IT'S TIME**



LOCOMOTIVES, CARS, BUILDINGS AND KITS

*Click here to get started in TT scale*

[WWW.SAZMODEL.COM](http://WWW.SAZMODEL.COM)



contents



index



21: The roof of this Norfolk Southern locomotive provides a clear contrast between the Sinclair style and the smaller EOT antennas. Multiple antennas often indicate the locomotive is equipped with additional specialized radio equipment for features such as DPU (mid-train helper) control, allowing the additional units to be operated from the lead locomotive.



22: The firecracker may be the most visible antenna, as it stands straight up from the roof. It also makes it the most susceptible to damage on our model locomotives.



23: This Norfolk Southern locomotive shows us the large square dome style that incorporates multiple antenna technologies into one protected unit.

# NEW for JANUARY '14

87-1451 & 60-1451

Du-Pont, ARCO Polymers, Continental Polymers  
ACF Centerflow Plastics Hoppers 5250 cuft.



87-1454, 60-1454

Nacionales De Mexico (NdeM)  
Passenger Cars



87-1455 & 60-1455

Delaware & Hudson (D&H)  
GE U boat and Alco RS Switcher  
Yellow Striping

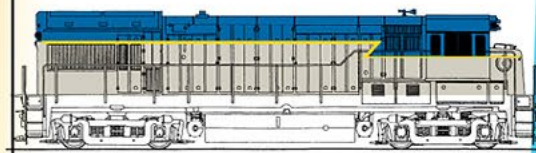

87-1456 & 60-1456

US Highway Sign Lettering, Striping and  
Highway Symbols/Shields



87-1457 & 60-1457

Baltimore & Ohio (B&O)  
Assorted Steel Caboose



87-1458 & 60-1458

Napa Valley Railroad (NVR)  
Wine Train Passenger Cars Incl Super Dome

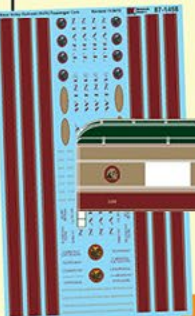

View all the past 2013 Decals [click here](#)



microscale.com

MADE IN THE USA



24

24: This array on the roof of a CSX locomotive shows us a variety of antennas, including a small whip, a wide cone, and a small dome style. ■

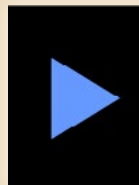

Reader Feedback  
(click here)



contents



index

TRAINS

*Athearn*

IN  
MINIATURE

AUTHENTIC — REALISTIC  
Scaled from official blue prints

# Improving a 1970s Athearn Santa Fe SD45

## Reliable operations for a 1970s locomotive ...

– **Dirk Reynolds**  
Photos by the author



**Reader  
Feedback**  
(click here)



**I**t's the '70s again! Can you hear the Athearn “growl” going around your layout? How many remember the Athearn SD45 running on their layout with those horn hook couplers? Ah yes, those were the days.

Some of us still use the Athearn product on our layouts. However, I can't bring myself to buy the updated DCC version that starts at \$134.98 MSRP. None of the RTR SD45 engines from Athearn/Horizon are offered with sound. Another manufacturer offers an SD45 with DCC and sound with a MRSP of \$298.00.

While at a train show, I found two of the older Athearn SD45s, one in Santa Fe pinstripe freight and the other in the yellow bonnet paint scheme. I bought them, came home, and laid out my project. Let us begin to improve the units from the 70s.



## STEP 1: Laying out the parts



1: I like the pinstripe paint scheme, so I chose one for this article. The same steps are used on ATSF 5386, the yellow bonnet unit. I laid out all of the parts that come with the unit. The number on the bag of parts is 75106. The little pile under the Athearn pocket covers is bits of metal left over from the stanchions. These can be used for scenery. It's a cardinal rule of model railroading, never throw anything away.

1a: We will not use the horns, coupler pocket covers, and the couplers. Be aware there are different length stanchions to be used. Always make sure you have the parts you will need to complete the project.

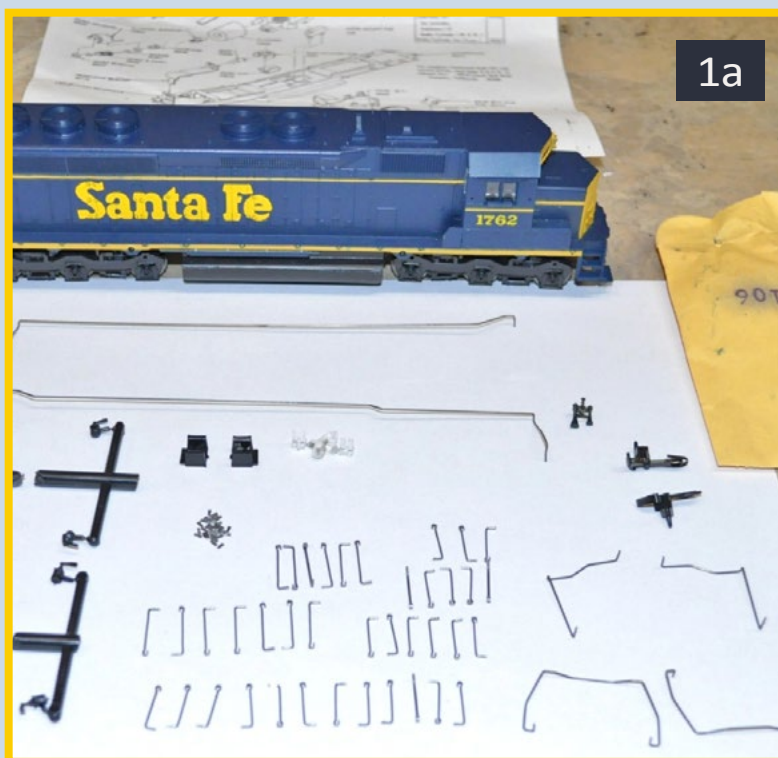

contents



index

## STEP 1: Laying out the parts *Continued ...*

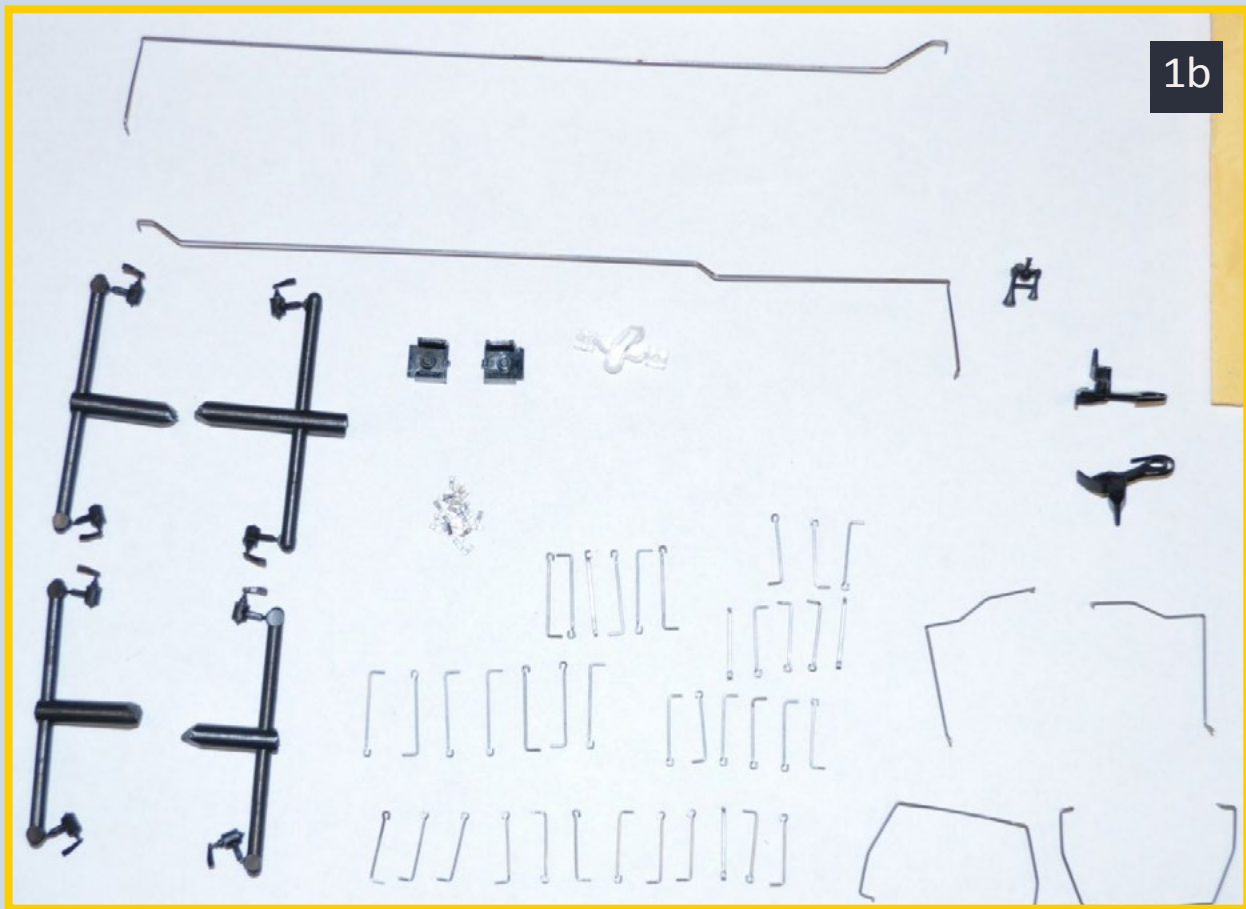

**1b:** Most model railroaders have tons of parts accumulated over the years. If you are a beginner, you can find these people at train shows. They will gladly sell, or sometimes give you, the parts you need.

## STEP 2: Electrical Improvements

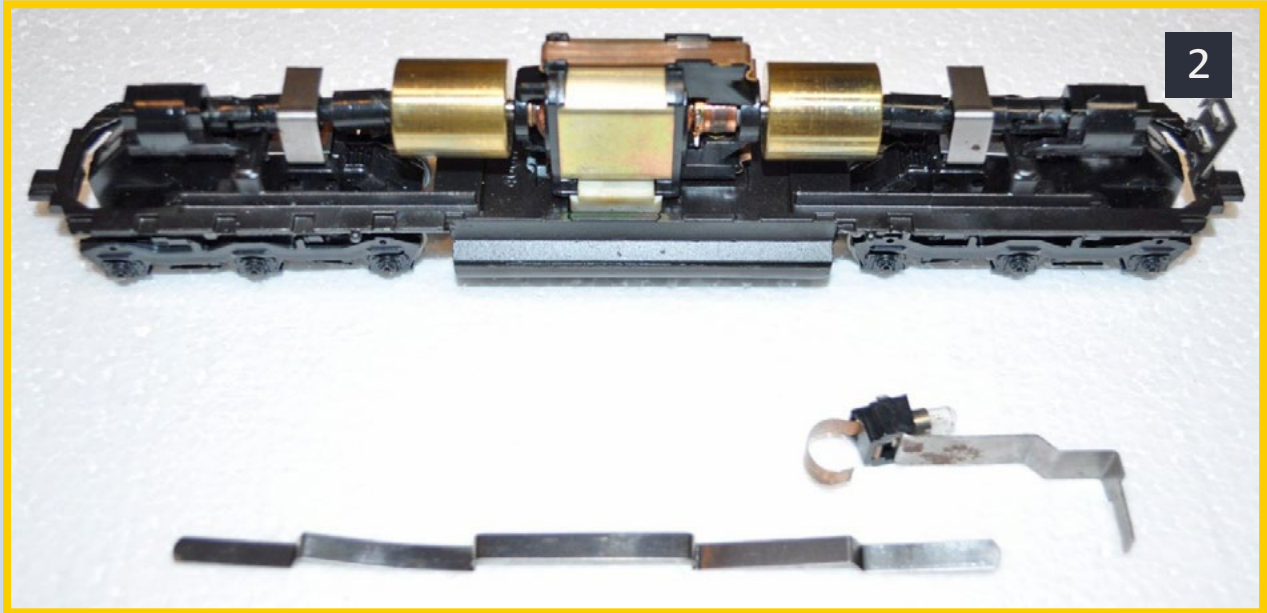

2: The first improvement is to remove the electrical metal bar. This unclips from the power chassis. With a pair of pliers, remove the huge electrical light bulb and its metal mount. This bulb draws over an amp of power and illuminates the entire cab. It also gets hot over time and can melt the plastic. I replaced this with micro bulbs to move the headlights to the correct position and eliminate lighting in the cab. Note: This wiring is for operations on DC layouts. Wiring for DCC is a completely different animal.



contents



index

## STEP 2: Electrical Improvements *Continued ...*



2a: Here are the tools I use, along with the discarded parts. From left to right: a solder gun, solder, insulated terminals, pliers, soldering paste, jewelers flat head screwdriver, and some wire to reconnect the power from the motor to the trucks.

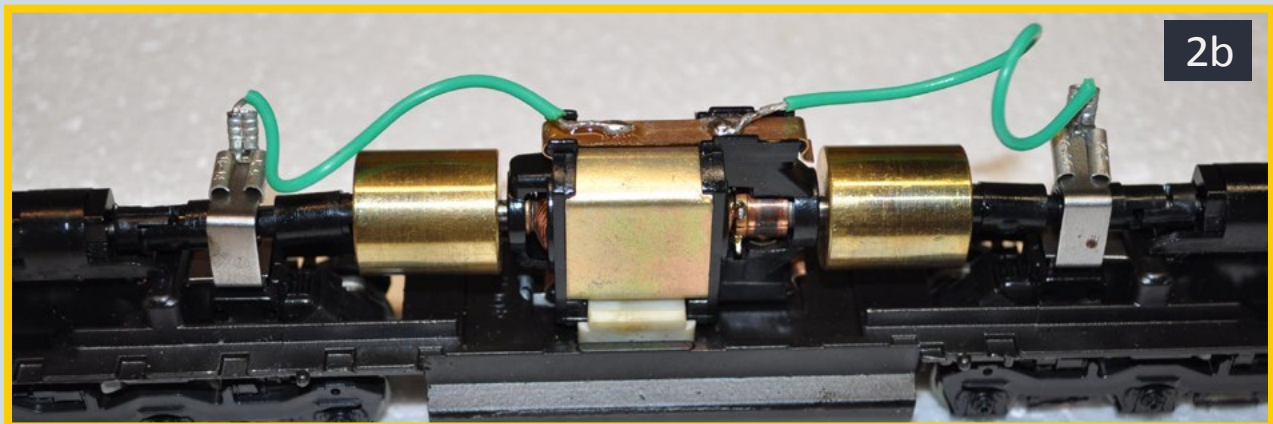

2b: I attach the wire to the terminals and solder the wire to the positive wire on the motor as shown in the picture. The terminals slide onto the truck clips. The negative connection is made by the metal clip on the motor bottom that contacts a polished spot on the frame.



## STEP 3: Lubrication

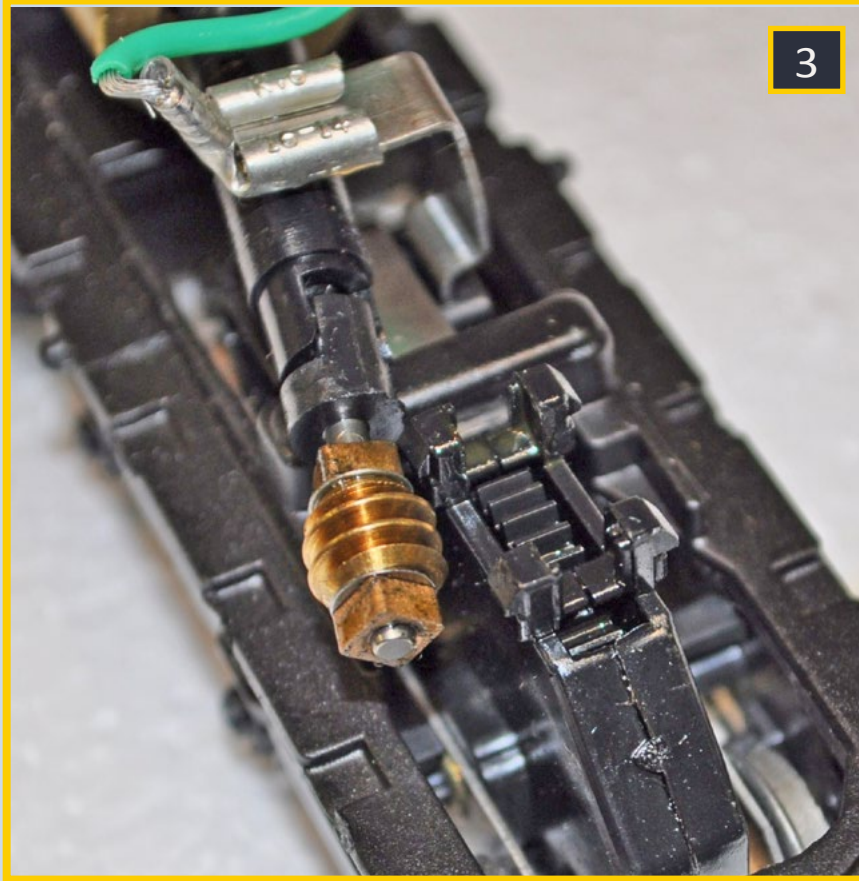

**3:** Remember the Athearn “growl”? You can tone this down. Carefully pry off the gearbox cover on each truck. I have used Vaseline for years with no problems for this step. If you are not comfortable using Vaseline, apply a plastic-compatible grease to all of the gears you can see. Put in a large amount. Apply it to the metal drive gear also. Put the unit on your track and run it back and forth a few times to work the grease through the gear system. Apply more if unit continues to growl.

Another method to reduce the “growl” is by cleaning out any flash in the gears, and by reducing the end-play in the worm gear with NWSL washers (see photo above). This method is more involved and requires further disassembly of the trucks. If grease alone doesn't solve it, use this method as a last resort.



contents



index

## STEP 4: New Headlights

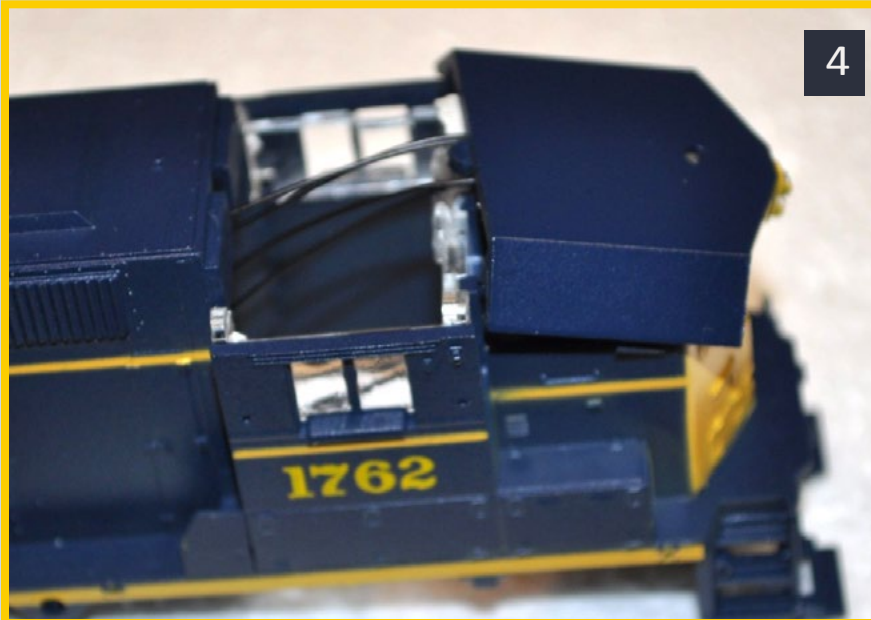

4: Attach the light bulb wire to the terminals and solder it to the positive wire on the motor as shown. The terminals slide onto the truck clips.

4a: I will not be using the headlight portion of the clear molding. Save the number board inserts.



Insert the number boards in the cab unit and glue them in place with Testors window glue. While the cab roof is still off, I insert the lights into the holes for the headlights.

## STEP 4: New Headlights *Continued ...*

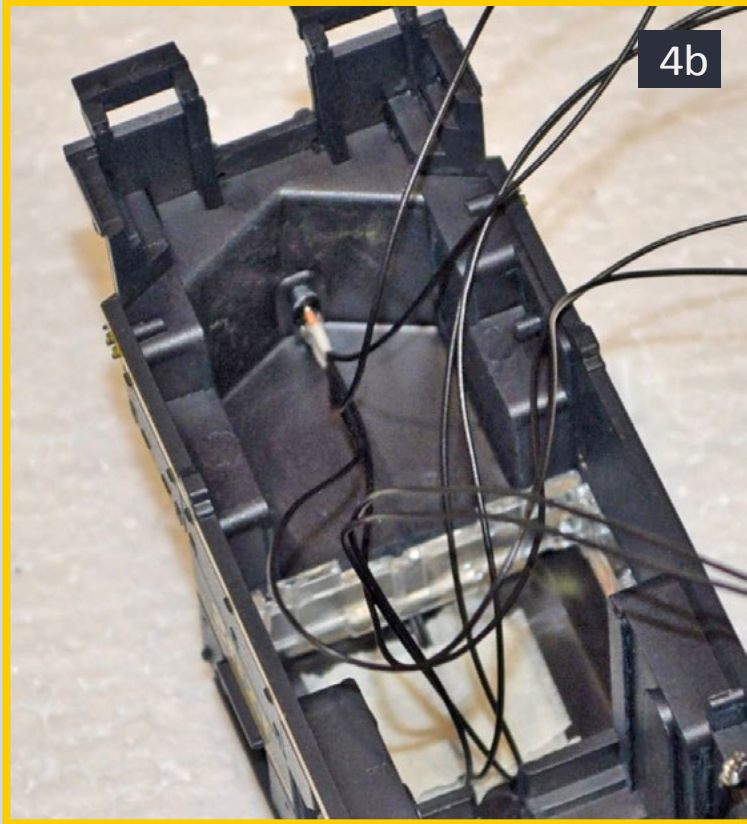

**4b:** Cement them in place with CA. I use masking tape to hold the top lights in place before gluing them.

**4c:** I use Miniatronics Corp. incandescent 12 volt 30mA 1.7mm diameter lamps. I had to slightly ream the existing holes to accommodate the lights.



contents



index

## STEP 4: New Headlights *Continued ...*

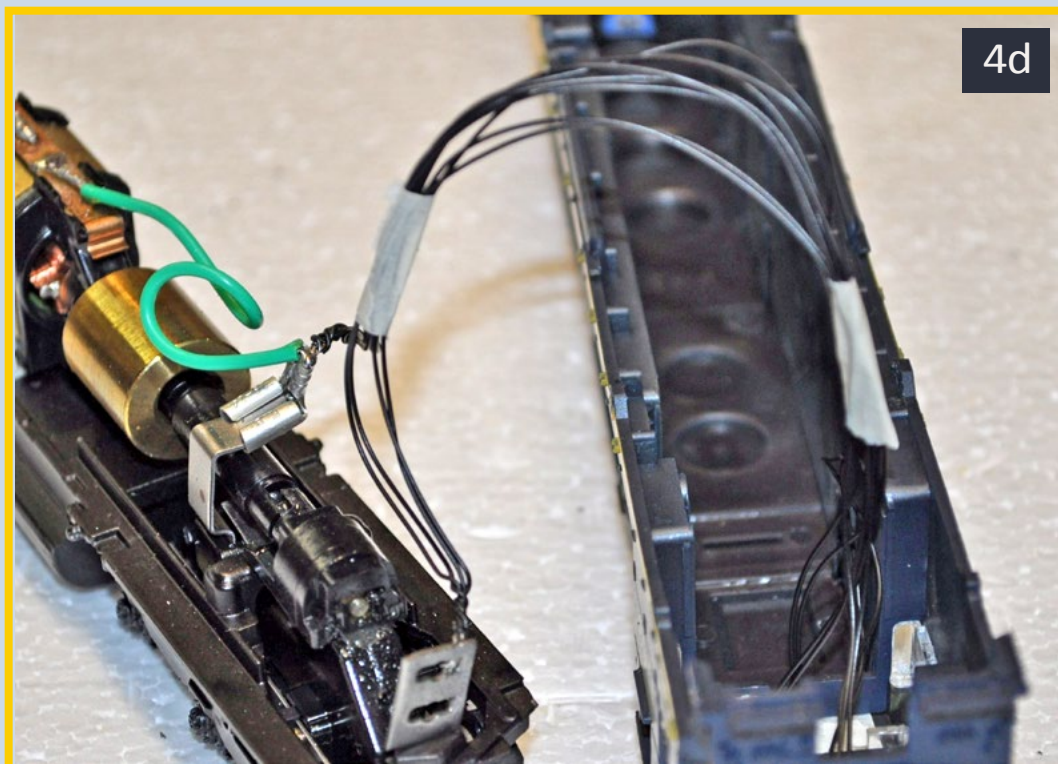

**4d:** Solder the + wires to the power clip, and the – wires to the metal clip on the power chassis for the negative ground. Tape the wires together to ensure they don't foul the gearing and the motor. Reattach the shell to the power chassis.

## STEP 5: Painting the handrails



5: After applying handrails, I noticed they continued to move a bit even after pinching the tops of the stanchions closed. I want them to stay in place vertically so I used a Micro

Brush to apply CA where the metal stanchion plugs into the plastic body. I squeeze the CA into a plastic KFC side order lid and dip the Micro Brush in that. That solves the movement problem.

5a: For detailing, I start with a picture from the Internet. [railpictures.net/view-photo.php?id=326868](http://railpictures.net/view-photo.php?id=326868). shows a Santa Fe SD45. The stanchions are Santa Fe Blue and the railings are Santa Fe Yellow. I put the picture where can see and refer to it as I paint the stanchions.



contents



index

## STEP 5: Painting the handrails *Continued ...*

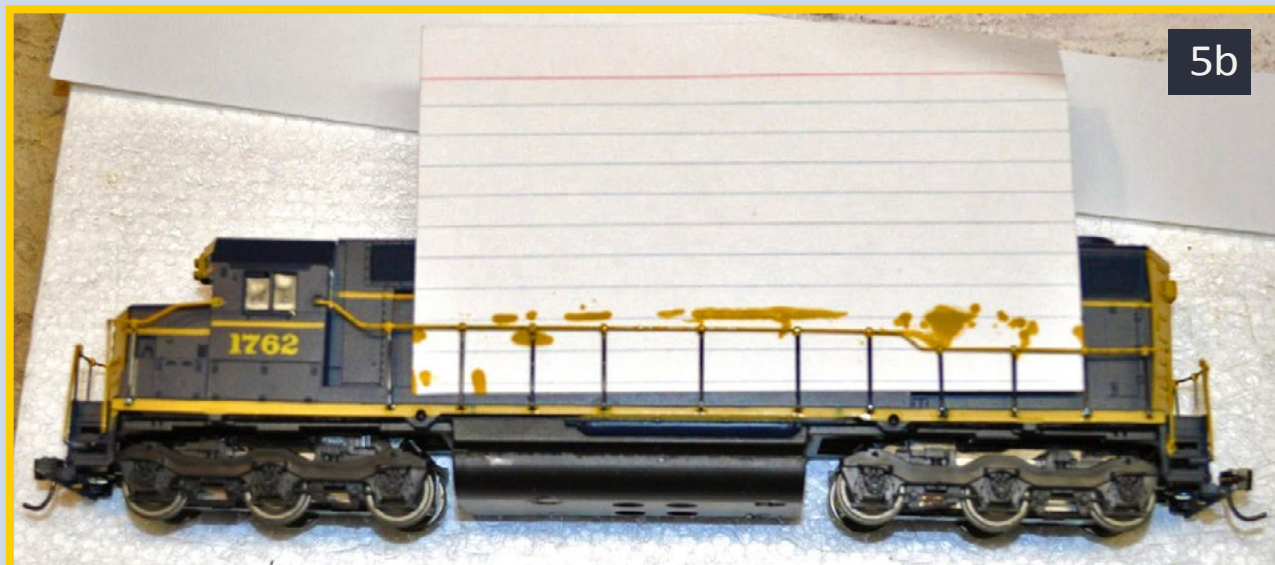

5b: You don't want paint to get on the body. This is where a 3x5 card comes in handy. I place it under the stanchions to be painted. I follow the picture and paint away.



5c: Painted handrails make a big improvement in the engine's looks. Once you make this simple improvement you will never skip it.

## STEP 6: Final details

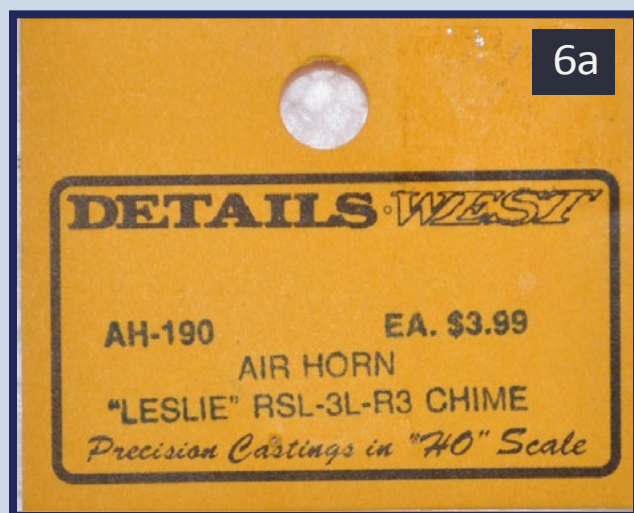

6-6a: Apply the air brake cylinders supplied by Athearn. Although I am not super detailing the model, I did replace the original air-horn set with a more prototypical one, a Details West AH-190 Leslie RSL-3L-3R. This small addition makes a big difference.



6b: The prototype photo shows a snowplow. To add this detail, I cut off the pilot steps and then cemented the plow to the body with CA.



contents



index

## STEP 6: Final details *Continued ...*



6c: I paint the plow Santa Fe blue. While working on the ends, I paint the running lights with a touch of silver to represent the clear glass lens.



6: Santa Fe blue pinstripe freight SD45 1762 is ready for freight duty. She sits on the bridge waiting for a signal.



## STEP 6: Final details *Continued ...*



6e: With lights glaring, 1762 passing a Santa Fe FA and PA on the point of a southbound freight. ☑



Dirk Reynolds has been model railroading since the dinosaurs roamed the earth. His family comes from Dupou, Illinois, and his grandfather engineered the "doodlebug" motor car that ran from St. Louis, Missouri to Marion, Illinois.

Dirk also ran his own hobby shop for 9 years in Dupou, Illinois under the name of Reynolds Railways. It closed in early 2010, but he is now operating out of his home in Columbia, Illinois under the name of Dirk's Trains.



**Reader  
Feedback**  
(click here)



contents



index



BCOL VARIATION SHOWN WITH METAL ROOF WALK AND ICICLE BREAKERS. CP VARIATIONS INCLUDE WOOD ROOFWALK, WITH AND WITHOUT LUMBER DOORS.

# YOUR ORDERS ARE DUE NOW. MADE. TO. ORDER.

**CP Rail** **CANADIAN** **BCOL**



**PACIFIC RAILWAY**

*Canadian Pacific*

**CANADIAN PACIFIC**

TRUE LINE TRAINS and its' intellectual property are solely owned by HOBBYCRAFT CANADA a division of 2236675 ONTARIO LIMITED. 445-1 RIDGELY BLVD, CONCORD, ONTARIO L4K401 (905) 738 6556 - contact us in the USA at [usinfo@truelinetrains.com](mailto:usinfo@truelinetrains.com) and in Canada at [caninfo@truelinetrains.com](mailto:caninfo@truelinetrains.com)



# The easiest way yet to make molds

– **Terry Terrance**

Model Photos by the author

Have you wanted to try mold-making and casting, but didn't believe that you had the time or skill? Here's an easy way to give it a try ...

**M**aking molds and casting parts is a technique many model railroaders use to make multiple copies of scenery items, rolling stock parts, and other detail items.

Making a mold usually involves carefully measuring, mixing, and pouring a two-part silicone or urethane rubber material around a master, waiting for the rubber to



**Reader  
Feedback**  
(click here)



cure, removing the master, and then casting a duplicate part in the cavity that remains.

Mold-making rubber is not inexpensive and has a limited shelf life, usually less than six months. The mold that it produces is permanent and can only reproduce the part for which it was constructed. This is all well and good if you need to make a significant number of the same parts. But what if you only need an occasional casting or two? Is there a process that can make a mold quickly, one that can be reused when the mold is no longer needed?

Yes, there is. The product is called ComposiMold. It is a thermal polymer that can be readily melted in a microwave or double boiler, and poured around a master to produce a mold. When all of the castings have been made, the ComposiMold material can be reheated and returned to its jar or used to create another mold. This cycle can be repeated many, many times.

In addition, ComposiMold does not smell (in fact, it has a pleasant odor when melted), is non-toxic, and cleans up with water. The process of mold-making can be completed in about an hour. You can cast plaster, concrete, resin, silicone, urethane, epoxy, wax, soap, and even chocolate in ComposiMold. ComposiMold's only drawback is that it is somewhat soft and you will only be able to produce a few castings from the mold before it is no longer usable. If you still have the master, you can always remelt the ComposiMold to make a fresh mold and carry on.

## **Trial size**

ComposiMold is available in 6, 16, and 32 ounce jars (1). Because ComposiMold is measured in fluid ounces rather than by weight, you can sometimes measure the volume needed

to cover your master using water as a surrogate (thank you Archimedes!) and buy only the amount of CompositMold that you will need. The 6 ounce jar is intended to allow you to try CompositMold and is enough to cast items using a paper cup as a mold box, as we will see.

To make a mold, in addition to the CompositMold you will need a few Popsicle sticks, some toothpicks, suitable mold boxes, mold release, and access to a microwave oven. The mold box holds the master while you pour the mold-making material around it.

Conventional silicone or urethane rubber processes can use loose-fitting mold boxes made of wood with unsealed joints because the rubber is too thick to leak out. Because CompositMold is a liquid, the mold box used with it must be watertight. Paper cups are ideal for casting smaller detail parts, and baking pans (regular or disposable) are better for

larger items. While CompositMold is non-toxic and cleans up readily with water, it's probably a good idea to buy some baking pans from the dollar store rather than use the household bake ware – you'll have fewer “discussions” that way.

Mold release can be anything from petroleum jelly, talcum powder (although this leaves a powder to deal with), lotions, cooking spray,



**1. CompositMold comes in a variety of sizes.**



contents



index

2

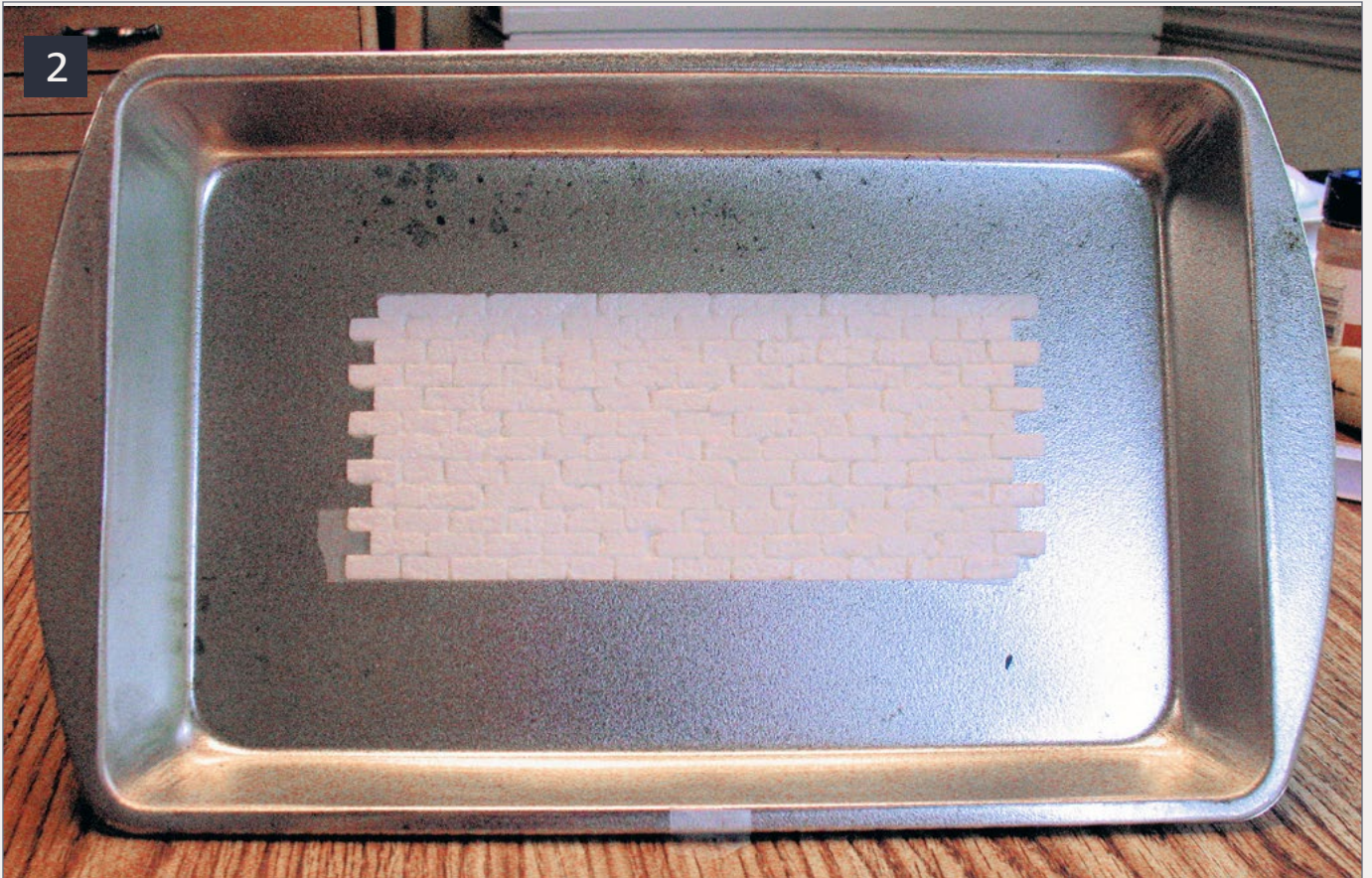

## 2. Master in a water-tight mold box.

wax, vegetable oil, or any universal mold release. I've used cooking spray successfully – just use it sparingly.

You'll want to fix your master to the bottom of the mold box (2). A section of cut-stone wall used as a master is stuck to the bottom of a baking pan being used as a mold box. To make efficient use of the ComposiMold, try to make the mold box fit more closely to the master than in this example. A tighter-fitting mold box allows you to use the minimum amount of ComposiMold or, alternately, to increase the depth and therefore the strength of the mold. Allow  $\frac{1}{2}$ " room around the master on all dimensions.

## Seal the master

Remember, ComposiMold pours on as a liquid, and a rather dense one at that. Therefore, any master that can float, will

float; including some plastics. Masters made of porous material (wood, plaster, etc.) must be sealed beforehand with sanding sealer or paint. Keep in mind that the rubber will be at about 130° F as it pours, so your master must be able to withstand that heat, and so must the glue holding it to the bottom. Polymer clay is a versatile method for attaching the master to the mold box. Hot glue works well and can usually be broken free from a non-porous master and the metal of the pan after the mold has been removed, thereby preserving the master.

Here's a trick that I discovered quite by accident. If your master begins to float away, immediately push it down with a couple of Popsicle sticks. A thin layer of CompositMold will be caught between the master and the mold box. It will quickly cool and solidify, thereby holding the master to the bottom.

Once you have your master affixed to the mold box, apply the mold release. In this case I used cooking spray. Now begin to melt the CompositMold in the microwave with the jar cover off. There is a table of melting times on each jar of the material – don't believe it. My microwave, which admittedly is a very powerful one, melted the CompositMold much more rapidly than the label indicated. Start with one minute and stir the CompositMold with a Popsicle stick.

If it still has some lumps in it, put it back in for no more than another minute. 30 seconds would be better. Remove and stir again. Stir gently so as to introduce the minimum number of bubbles into the mix. Repeat this process until the CompositMold is the consistency of heavy syrup. At that point it's ready to pour. CompositMold's instructions warn not to let the product get to 200° F as overheating will eventually degrade the CompositMold.



contents



index

3



**3. ComposiMold as poured, with room left around the master to produce a stable mold.**

## **Pour the mold**

The jar will be hot. Hold it with oven mitts and pour the ComposiMold into a corner of the mold box – not directly onto the master – and let the rising level of the liquid cover the master. You should cover the master by at least  $\frac{3}{8}$ " on all sides and the top;  $\frac{1}{2}$ " or more would be better (3). If your master floats away, deal with that first. Remember, if you can't get the master settled down, all is not lost. You can let the mess cool, peel off the ComposiMold, re-affix the master, remelt the ComposiMold and try again.

Use a toothpick to dislodge any bubbles clinging to the surface of the master. If you don't, you'll have blemishes in your mold



but, of course, you can always try again! ComposiMold's transparency allows you to see the surface of the master to prick and coax the bubbles away from the master's surface.

Once the master is free of bubbles, all you have to do is to wait for the mold to cool – not just solidify. A solidified mold may still be soft on the inside and may tear or distort as it is pulled away from the master. Cooling can be accelerated by placing the mold in the refrigerator or freezer; just remember to keep it level, and let your spouse in on what you're doing. The mold produced by ComposiMold (4) is shown on top of a sheet of white paper to enhance contrast.

The mold will be somewhat soft compared to silicone rubber molds. This is normal. The mold is sprayed with mold release before filling the mold with plaster (5). The mold is peeled away to reveal the completed casting (6).

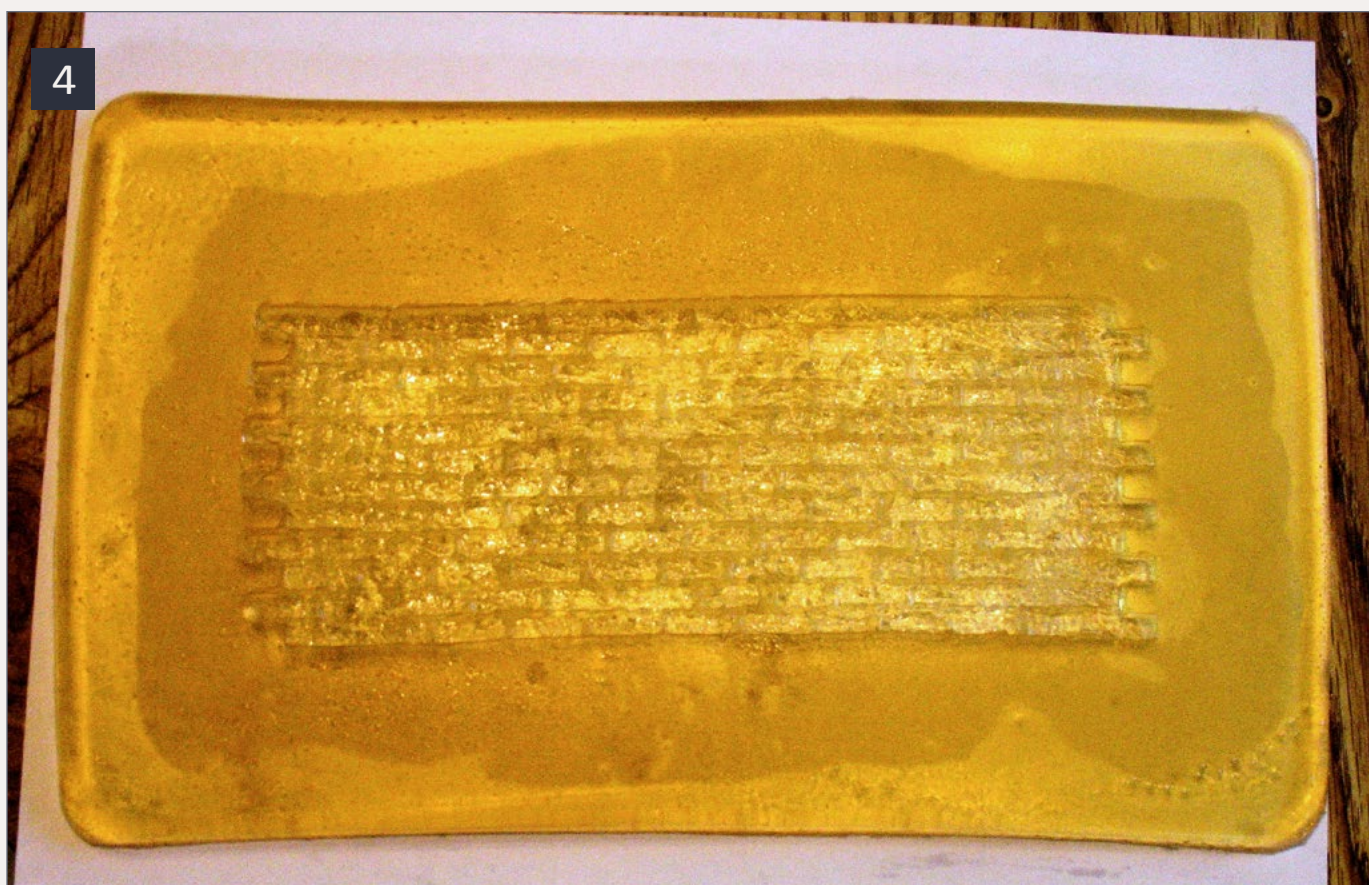

**4. The wall section mold produced by ComposiMold.**



contents



index



**5. Plaster-filled mold.**



**6. Completed plaster casting. The tiny bubbles seen are in the plaster pour, and not in the mold.**

## Mini-mold boxes

I find that for smaller detail parts, a paper hot-cup makes an excellent mold box. An O scale barrel and crate that I want to reproduce fit into a mold box (7) consisting of a paper cup cut down to allow me to glue the masters to the bottom.

The masters are stuck to the bottom of the cup with hot glue (8). The assembly will be sprayed with cooking spray before the polymer is poured.

Melting and pouring the CompositMold proceeds as before. Bubbles near the surface of the filled mold box (9) do not affect the detail of the mold.

The paper cup is simply torn away (10) to release the mold.



**7. The mold box for an O scale barrel and crate consists of a cut-down paper cup.**



contents



index

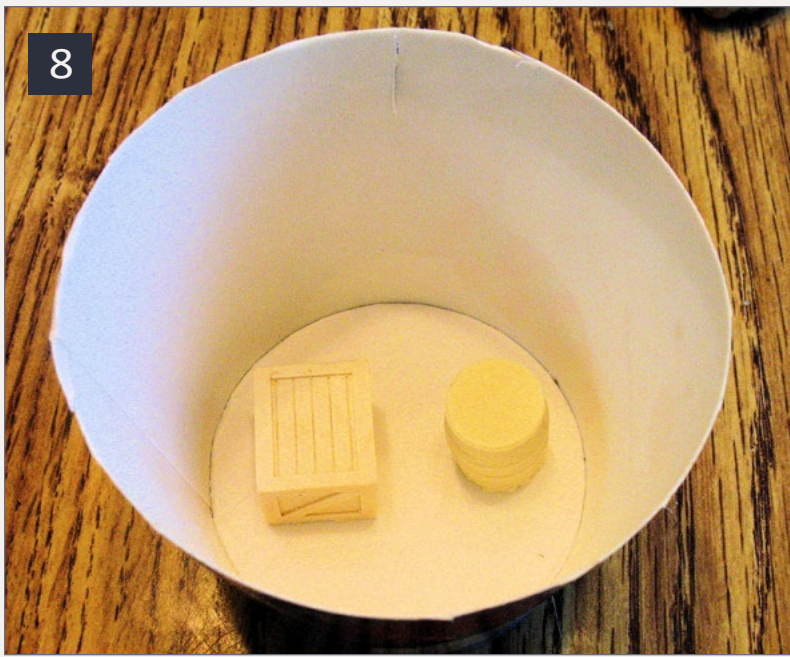

8. The masters are stuck to the bottom of the cup with hot glue before pouring heated CompositMold.



9. The filled mold box. Bubbles near the surface do not affect the detail of the mold.



10. The paper cup is simply torn away to release the mold.

Ordinarily, the raised boards on the crate would be undercut that would lock the master into a conventional silicone rubber mold, and certainly into a stiffer urethane mold. The cured CompositMold flexes enough to release this master easily (11). The detail from the crate can be seen in this picture of the mold.

To test CompositMold with resin casting, I obtained some EasyCast clear casting epoxy from a local Michael's Arts and Crafts, along with other materials (12) that I used to cast the barrel and crate in epoxy. Items include the EasyCast epoxy, sticks for use as stirrers, the mold, a paper mixing cup, and two medicine cups for measuring the epoxy. The EasyCast instruction specify that the cups cannot be waxed or otherwise coated.

The two-part epoxy was measured and mixed according to the package directions. If I were to repeat this demonstration, I would not use the EasyCast. It requires a two-step mixing process and the cure time for castings of even this modest size was measured in days rather than minutes.

The inside of the mold was coated with cooking spray as mold release. The mold was placed on newspaper before filling, to protect the table surface (13).

The finished reproduction crate (14) has been given a coat of gray primer so that the otherwise clear casting could be photographed.

A sister product to CompositMold – PowerMold – is more firm and is capable of making two-part molds by freezing the first half of the mold before pouring the second half and then refrigerating the whole to accelerate cooling. CompositMold is working on a product specifically for plaster casting called ReMold; contact CompositMold for availability.

More information and videos on CompositMold and PowerMold can be found on their website: [composimold.com](http://composimold.com).



contents



index

11

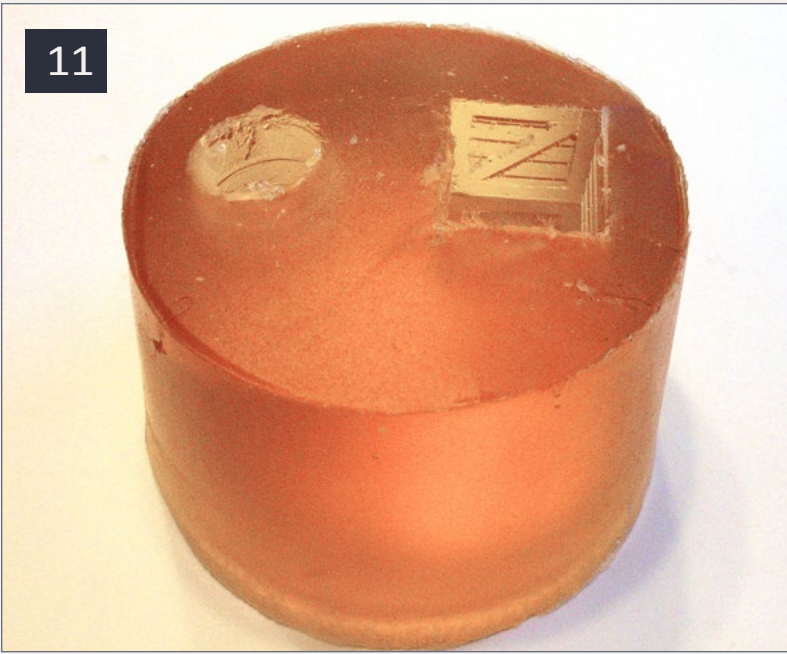

11. The cured CompositMold flexes enough to release this master easily. The detail from the crate can be seen in this picture of the mold.

12



12. From left to right are: EasyCast epoxy, Popsicle sticks for use as stirrers, the mold, a paper mixing cup, and two medicine cups for measuring the epoxy.

13



13. To protect the table, place the mold on newspaper before filling. This mold is filled with epoxy.

## Time and money savings

If you have not ventured into casting because of the expense or complexity of conventional mold making processes, or you feel that you do not have the time or the skill, you should try ComposiMold. ComposiMold offers several advantages for the low volume or occasional caster. ComposiMold is inexpensive, reusable and has no shelf life. The ComposiMold used for this article is over a year old.

The process of making a mold is quick and, because ComposiMold is reusable, it's very forgiving and mistakes are easily corrected. The material is flexible so some problem masters with irregular shapes are no longer problems. It works with whatever medium you want to cast, as well as whatever you have on hand for mold release. It's an easy material to use and you will not be banned from the house because of the smell. Give it a try, you'll be pleased.

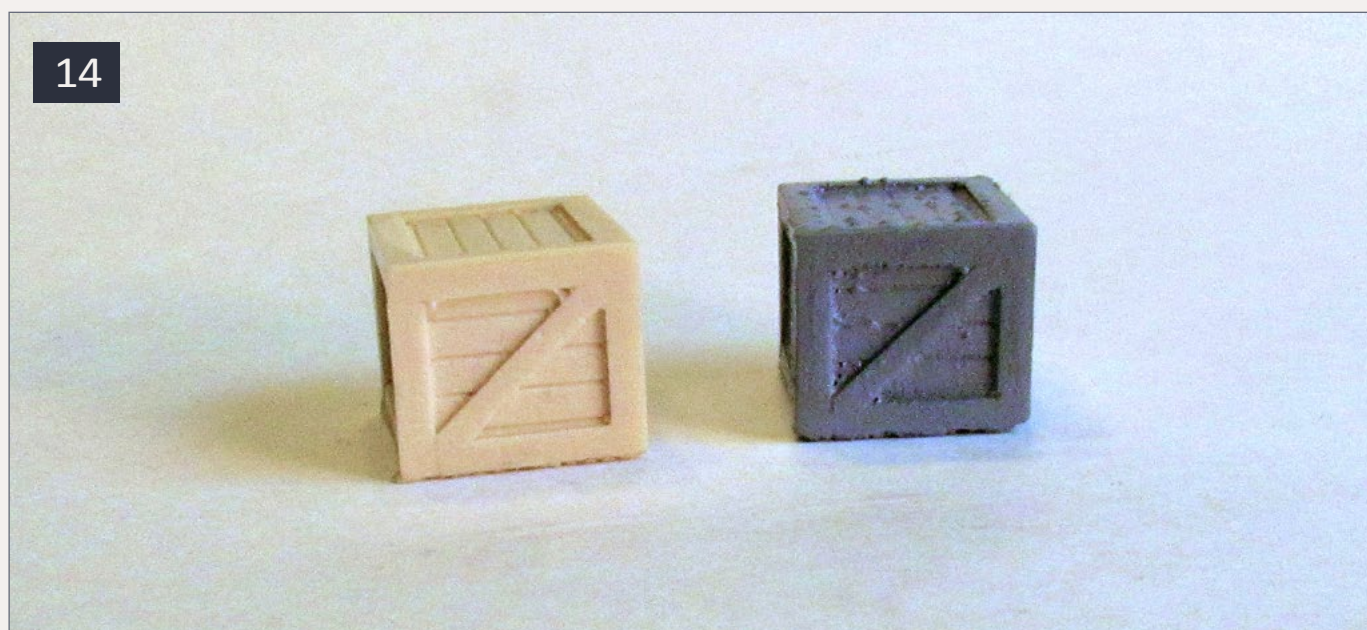

**14. The original crate and the reproduction. The reproduction (on the right) has been given a coat of gray primer so that the otherwise clear casting could be photographed.**



contents



index



Terry Terrance has been a model railroader since receiving his first Lionel train set at age 7. The next couple of decades he spent as a 3-railer attempting to scale model in the days before 3 Rail Scale.

Eventually, rather than go the HO route, Terry jumped into 2-rail O Scale where he has been ever since. Currently he is building a model of the B&O "West End" centered around the M&K Junction helper station circa 1950/2 in his basement. The layout features the Cranberry (three-track) and the Cheat River (two-track) grades and is designed for helper operation closely following the prototype.

Terry's blog ([2railoscale.blogspot.com](http://2railoscale.blogspot.com)) features the construction progress as well as tips and techniques articles and videos. Terry is part of the regular crew of the Model Rail Radio podcast and has appeared on the Model Railcast podcast.



**For the readers of Model Railroad Hobbyist, ComposiMold is offering 10% off your order.**

**Use coupon code TRAIN2012 when ordering ([composimold.com](http://composimold.com)).**



# "O" Scale Standard Gauge



**\$89.95 each**

San Juan Car Co. 190 Turner Drive Unit C, Durango, CO 81303

(970) 385-5256 Fax: (970) 385-1030

sanjuancar@durango.net • www.sanjuancarco.com



# iwata

by ANEST IWATA

## *Just Rolling By...*

## Make It **REAL** With Iwata *Climb Aboard!*



**Eclipse  
HP - CS**



**Revolution  
HP - TR1**



## **Visit...** [www.iwata-medea.com](http://www.iwata-medea.com)

## **To Check Out Our Full Product Line!**

*Models By... Alan Houtz,  
North American Prototype Modelers*



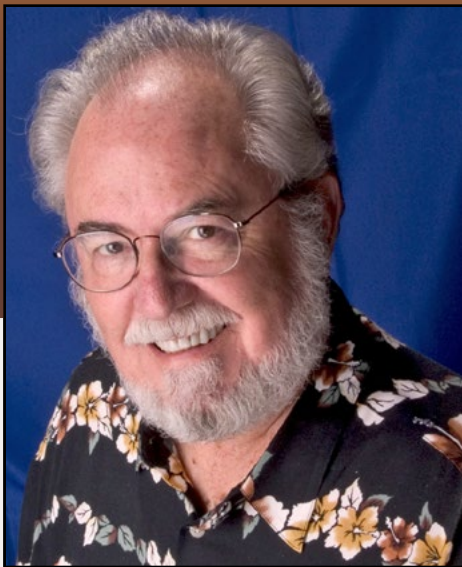

*The Old  
Yardmaster*

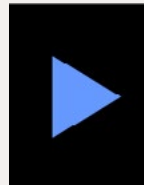

**Reader  
Feedback**  
(click here)



## **January 2014: The latest model railroad products, news & events**

*by Richard Bale and Jeff Shultz*

### **Atlas shifts executive lineup**

Tom Haedrich, the CEO of Atlas Model Railroad Company for the past 30 years, has announced a series of changes in the senior executive staff of the company. He will become the executive chairman of the board of directors, while Paul Graf, currently chief operating officer, will become the new CEO. Jarrett Schaffan Haedrich, currently vice president marketing and the great-grandson of Atlas founder Stephan J. Schaffan Sr., will become the new COO. The company's current marketing coordinator, Eric Mosher, will become vice president marketing. In announcing the changes, Tom Haedrich said, "This year Atlas is celebrating its 90th anniversary as a family owned business, and we are very fortunate to have qualified in-house personnel to continue managing our company" ...

### **Investment firm to purchase Horizon Hobby**

Horizon Hobby, Inc., the parent company of Athearn Trains, will be sold later this month to an investment group led by Joe



Ambrose, Horizon's chief executive officer. The transaction was approved in early December by the company's board of directors. A press release issued by Horizon in December said the transaction will provide capital to enable the company to pursue an aggressive growth strategy. Horizon's current management team will be retained. The sale is expected to appear seamless to the company's suppliers, employees, and customers. Horizon is currently an employee-owned company, and employs nearly 700 people. It is active in the sale of hobby products in more than 50 countries around the world ...

## **Piedmont Division MR Club**

In a recent broadcast of its TV magazine show, "This is Atlanta," PBS affiliate PBA 30 presented a report on the Piedmont Division Model Railroad Club. The club represents a group of over 400 model railroaders in north Georgia. The segment can be viewed at [youtube.com/watch?v=5UQ6tT0mRWs](https://www.youtube.com/watch?v=5UQ6tT0mRWs) ...

## **Boston Trolley Meet Canceled**

The Boston Trolley Meet planned for June, 2014 has been canceled. Officials noted that increased cost of operations at the facility and predicted low attendance made it unlikely the event would break even. The meet was established in 1981 by the Boston chapter of the National Railway Historical Society ...

---

## **NEW PRODUCTS FOR ALL SCALES**

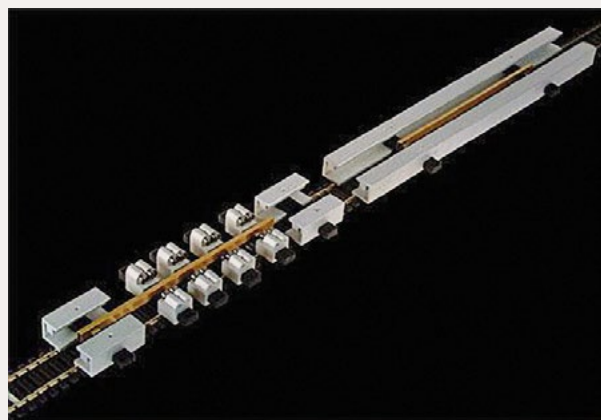

**Bachrus Inc. ([bachrus.com](http://bachrus.com))** is selling locomotive running stands for N scale (9mm) through G scale (45mm) equipment. Power application can be AC, DC, or DCC

on any two-rail or three-rail track. The modular design of the wheel saddles and stirrups provides full support to all wheels (including tenders) and permits using the system on the workbench, in active display, or on any layout track. Visit the above website for complete details.

---

***“Railroading on the Wabash Fourth District”*** by Victor Baird, is available now from Erstwhile Publications, of Fort Wayne, Indiana ([erstwhilepublications.com](http://erstwhilepublications.com)). The book provides a history of the Wabash Railroad's Fourth District that extended from Montpelier, Ohio through northern Indiana to Chicago. Track diagrams, maps, and hundreds of photos are included. Although slanted to the steam and steam-diesel transition era, a postscript chapter covers the diesel period through 1964. For additional information and ordering instructions, visit the above website.

---



Kalmbach Publishing ([mrr.trains.com/magazine/special-issues](http://mrr.trains.com/magazine/special-issues)) will release *Model Railroad Planning 2014* late this month. This year's cover story is about modeling the trackwork required for realistic operations at the New Orleans Public Union Terminal, built by Cliff Powers. Additional features are depicting the era you want to model, updating a published track plan to fit your needs, a 4' x 8' rail-

marine track plan, switching a breakfast cereal plant, downsizing a layout to fit a smaller home, and building a multi-deck N scale masterpiece. The publication will be available in both



contents



index

print and digital formats. Visit the above website for pricing and ordering information.

---

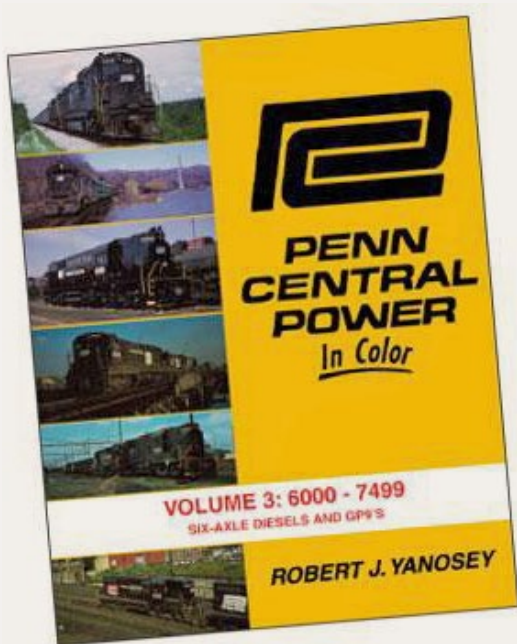

**Morning Sun Books ([morning-sunbooks.com](http://morning-sunbooks.com))** has released *Penn Central Power, Volume 3*, by Robert J. Yanosey. Both roster and action photos of SD35s, SD40s, SD45s and GP9s are among the PC locomotives detailed in this study. Also new this month is *Steel Mills Railroads, Volume 6: Southern Style*, by Thomas Lawson Jr., and Stephen M. Timko. Visit

the above website for pricing and ordering information.

---

***Rivers, Rapids, and Rushing Water*** is the latest publication from Tim Mulina's Mastering Model Railroading series of how-to books. For full details including pricing and ordering information visit [quickpicbooks.com/MMR/Scenery/Rivers.html](http://quickpicbooks.com/MMR/Scenery/Rivers.html).

---

**Woodland Scenics ([woodlandscenics.com](http://woodlandscenics.com))** is scheduled to release several new terrain system products early this year.

One of the most interesting is a self-supporting terrain building

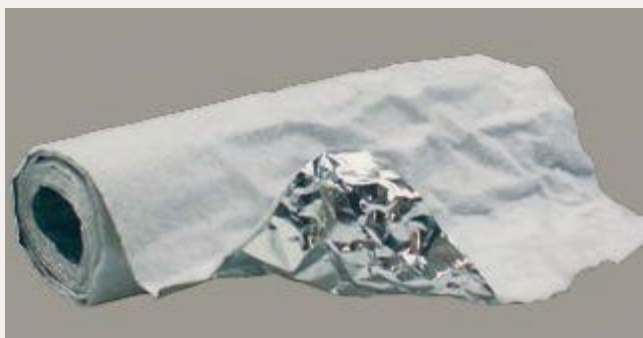

material (previous) that can be shaped and reshaped to form any type of terrain. Named Shaper Sheet™, the new material requires no supporting understructure. Shaper Sheet bonds with plaster to lock-in the shape and create a hardshell surface (above right). It will be available in 6' rolls 9" and 18" wide.

Another new product coming from Woodland Scenics is Ready Rocks™. These are precast, prepainted, plaster rock castings. The assortment includes seven types of rocks. One group of rocks, called Shelf Rock™, are cast in such a way that they can fit together in one contiguous wall or be set individually.

Also coming soon are Road Striping Pens and a flexible marking guide called Flexi Edge™. Used together, a hobbyist can create realistic road markings in any scale. The pens will be available in yellow and white. A line remover is also available. Visit the above website for additional information.

---

## O SCALE PRODUCT NEWS

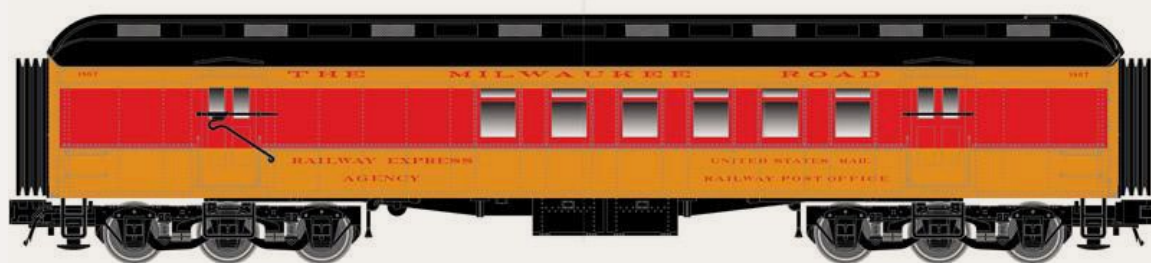

Atlas O ([atlaso.com](http://atlaso.com)) will release four 60' passenger cars during the third quarter of 2014. Based on C&NW prototypes, the group includes a coach and a combine with four-wheel trucks, and an RPO and a baggage car with six-wheel trucks. In addition to the Milwaukee Road scheme shown on the RPO car, road names will be CNJ/NJDOT, Burlington, Chesapeake & Ohio, and New York Central. Models ready for three-rail operation will have an MSRP of \$99.95 each. Two-rail versions will list at \$104.95.



contents



index



A 50' 6" Trainman® series boxcar is also due from Atlas O in the third quarter. In addition to the TASD car shown here, road names will

include Railbox (small logo), Norfolk Southern, Santa Fe, Union Pacific, and U. S. Army. The MSRP on three-rail models will be \$55.95. Two-rail versions will list at \$58.95.



The final item in Atlas O's third-quarter release will be a Masters® series Coalveyor Bathtub gondola based on an ACF prototype from

the 1980s. Road names will be Iowa Southern Utilities, AIG Rail Services, Kansas City Power & Light-SJLP, Midwest Railcar, Sullivan Scrap Metal, Transload America, and David J. Joseph – DJJX. Three-rail models will have an MSRP of 64.95. Two-rail versions will list at \$69.95.

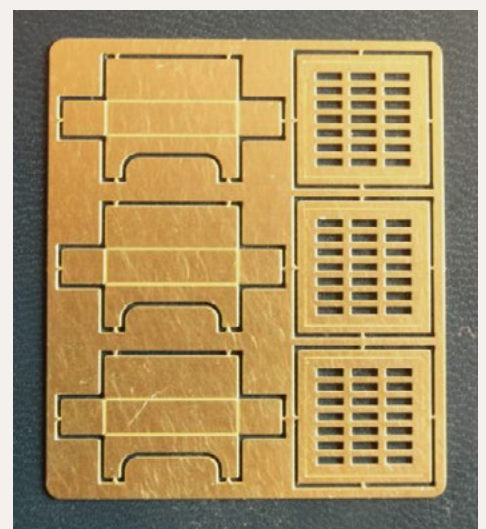

**Great Lakes Models ([greatlakesmodels.com](http://greatlakesmodels.com))** is selling a simple etched metal kit that makes into nicely detailed street



sewer grates and inlets. The O scale model is based on a prototype located in Milwaukee, Wisconsin. Similar fixtures were used throughout the nation during the 20th century. A package of three grates and three inlets has a retail price of \$5.13. Additional information is available at the website.

---

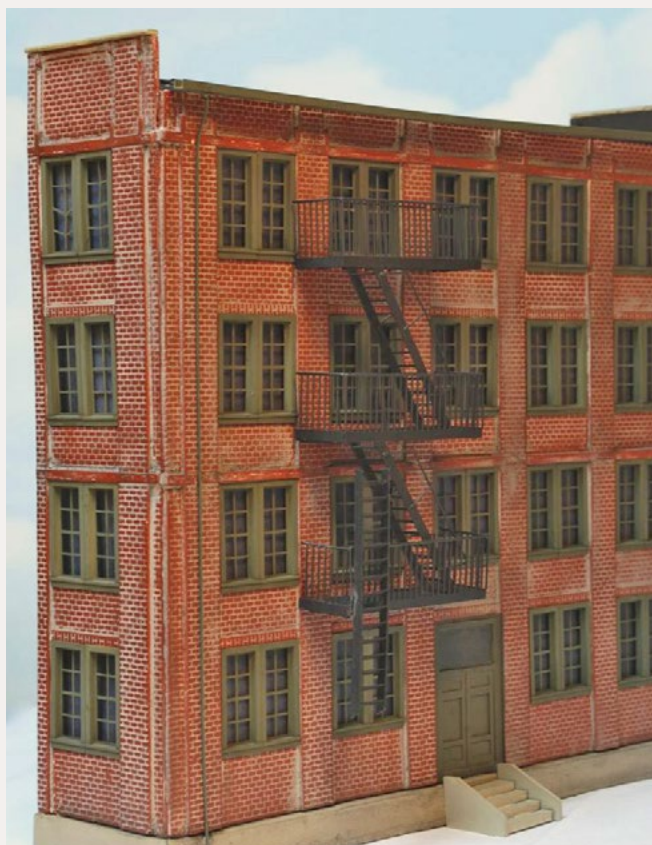

**Korber Models ([korbermodels.com](http://korbermodels.com))** has introduced two new kits for O scale structures. They include a multi-story Background Apartment Building (left) that features over 50 windows and a nicely detailed fire escape. The finished building is 12" tall and has a footprint of 3" x 13". Also new is a Background Tall City Building that tops 32" in height with a 1" x 11" footprint. The 13-story building includes

detailed laser-cut parts, three-dimensional limestone walls, and arched two-story windows on the lower level. The finished kit is designed to be placed against a wall or other back area of the layout. There is room to add interior details such as window shades, and lighting. Visit the above website for additional illustrations, pricing, and ordering instructions.

---

**Rusty Rail ([rustyrail.com](http://rustyrail.com))** has three new O scale resin-cast junk boxes. The larger box, which contains assorted gears, is 1.5" x 0.75" x 0.5" tall. The medium-size box contains a variety of hand tools, while the smaller of the three boxes is full of pipe fittings.



contents



index



The boxes are sold as a set of three, unpainted, at \$7.00. The figure is not included. Visit the above website to order and to view similar detail parts.

---

## S SCALE PRODUCT NEWS

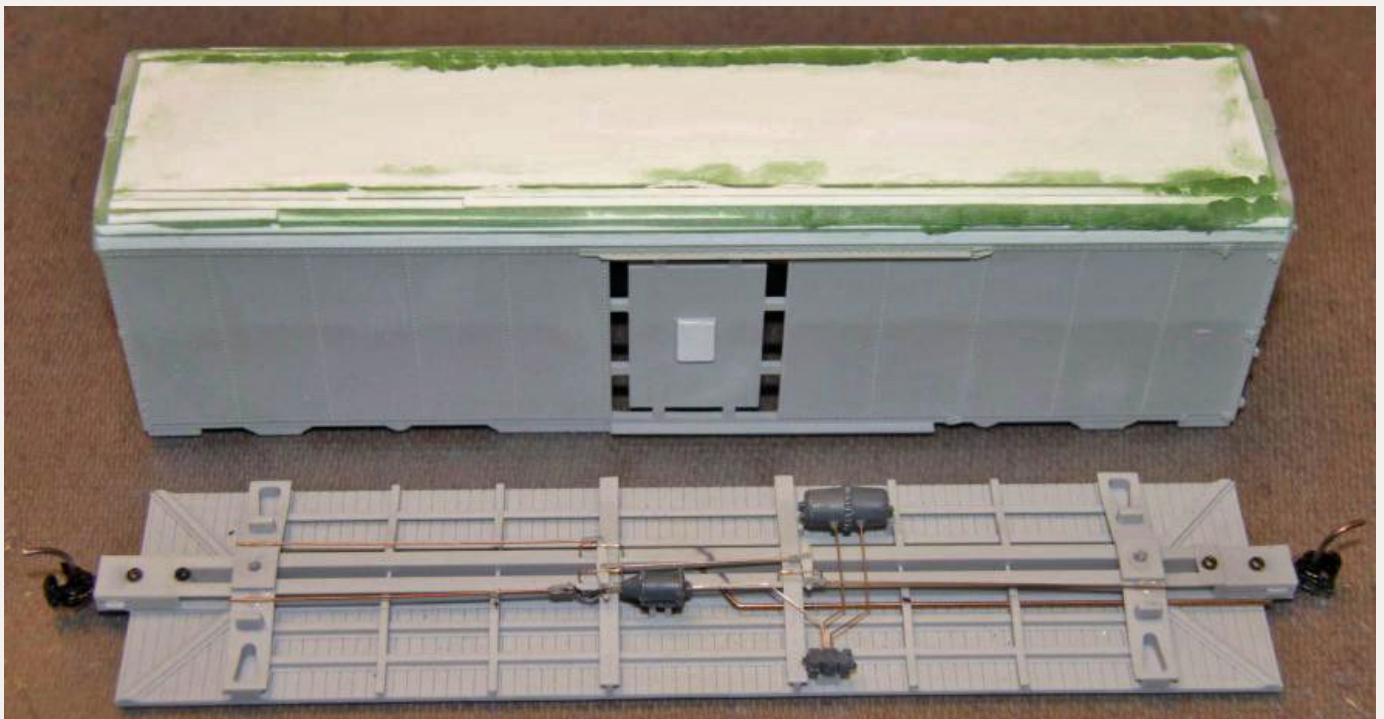

**Smoky Mountain Model Works ([smokymountainmodelworks.com](http://smokymountainmodelworks.com))** has a kit for a Seaboard Air Line class B7 boxcar with a turtleback roof. The S scale kit includes a one-piece urethane cast body with roof rivets, separate doors, underframe, brake gear, decals, and Kadee #803 couplers. Also included are photo-etched steps, grab irons, running board, and a brake

platform. Trucks are not included. Kit #64-B4 has an MSRP of \$80.00. Shipping is extra. The S scale decal included in this kit is available separately. For details please refer to the decal section of this news report.



Smoky Mountain's previously announced project to produce an S scale GP38/GP38-2 has been canceled due to low interest and difficulty

in obtaining certain mechanical parts.

---

## HO SCALE PRODUCT NEWS



New HO scale kits recently announced by **Accurail** ([accurail.com](http://accurail.com)) include a 40' PS-1 steel boxcar decorated for Toledo, Peoria &

Western with a rocket logo and slogan.



Also announced is an 89' Great Northern TOFC piggyback flat car.

The kit is available individually at \$16.98, or in a three-car set at \$48.98.



contents



index



A kit for a single-sheathed 40' boxcar decorated for New Haven has also been

announced. The model features six-panel outside bracing and wood ends. All of the individual Accurail HO scale kits mentioned have an MSRP of \$16.98 each.

---



**Alpine Division Scale Models ([alpinemodels.com](http://alpinemodels.com))** is selling a kit for a small rural freight station. Although based on a freight house on the New Haven Railroad, the fundamental design of the structure

makes it suitable for any model setting. The kit includes plastic windows and doors, laser-cut wood sides, wood bracing, and trim. Also included are a coal bin, large drums, and feedbags for the loading dock. The assembled model has a footprint of 9" x 3". Kit number 5805 is available direct at \$39.99.

---



**Athearn ([athearn.com](http://athearn.com))** has released 10 decorating schemes of Norfolk Southern Heritage series SD70ACe locomotives including the Illinois

Terminal version shown here. Complete details are available at the above website.



Athearn has also released GP35 locomotives in its economically priced Ready To Roll® series. Road names include Soo Line, Seaboard Air Line,

Chessie/C&O, and the BNSF Heritage I scheme shown here. F59PHI commuter locomotives are also available now. Check the above website for full details including pricing.



Scheduled for arrival in July is a new group of Southern GP39X/ Norfolk Southern GP49 locomotives. The Genesis series models are based on a group of six GP39 (above left) 2600 hp locomotives EMD built in the late 1980s as test beds (note the X designation) for future medium-horsepower locomotives. In accordance with Southern Railway practice, locomotives 4600-4605 were built with 81" high short hoods with control stands positioned for operation with the long-hood forward. EMD upgrades in 1982, including rebuilding the prime movers to 2800 hp, made the six units true GP49s. After ownership switched to Norfolk Southern, they retained their original road numbers while receiving a black "Thoroughbred" paint job (above right). The Genesis series models will be available without sound at an MSRP of \$169.98 and with Tsunami® sound at \$269.98.



contents



index



Additional items scheduled for release in July include AMD-103/P40 locomotives in Amtrak Phase III, IV, and V decorating schemes.



An Eastern-style steel caboose with a centered cupola is due to be released this summer in Athearn's economical Ready to Roll<sup>®</sup> series at a list price of \$24.98. In addition to the LV Bi-Centennial scheme shown here, the model will be available decorated for LV (jade scheme), LV (white scheme), Western Maryland, Conrail, Reading, and Penn Central. Additional information on other Athearn models can be viewed at the above website.



**Atlas Model Railroad Company** ([atlasrr.com](http://atlasrr.com)) is preparing a Thrall 2743 gondola for delivery in the third quarter of this year. The Master<sup>®</sup> series car will be available decorated for Chicago

Freight Car, Norfolk Southern, R. J. Corman, Wheeling & Lake Erie, and Gondola Connection as shown here. Special features include etched metal platforms and end reinforcement plates. The ready-to-run model will have an MSRP of \$29.95.



Additional HO scale models coming from Atlas in the third quarter include an ACF 50' 6" boxcar. Road names will be Ashley Drew & Northern,

Railbox (small logo), Bath & Hammondsport, BNSF, Norfolk Southern, Clarendon & Pittsford, and U.S. Army. The MSRP on the Trainman® series model will be \$21.95.



**Blackstone Models** ([blackstonemodels.com](http://blackstonemodels.com)) is taking advance reservations for the third

release of its D&RGW 800 series drop-bottom gondolas. The ready-to-run models replicate the appearance of the D&RGW fleet after their rebuilding in 1926. New road numbers with the Flying Grande herald include Nos. 821, 830, 858, and 890. Number 805 will have the Moffat Tunnel herald and No. 878 will feature the Royal Gorge Route herald. They will be available in freshly shopped boxcar red.

Blackstone is also taking reservations for the third release of its D&RGW 6000 series flatcars. The run will include four new D&RGW road numbers and one new RGS number. Numbers



contents



index



6001, 6040, 6056, and 6077 will feature D&RGW lettering, and No. 0616 will have RGS livery. These models represent the appearance of the D&RGW cars from the beginning of the 20th century into the 1940s. The flat cars will be painted boxcar red with wood-grain decking. A painted, unlettered model will be included in this production run. Delivery of both the gondola and flat car is planned for May. Visit the above website for pricing information.



**Bowser** ([bowser-trains.com](http://bowser-trains.com)) is taking advance orders for a new production run of its PCC streetcars. Delivery is expected sometime this fall. Cars will be available decorated for San Francisco Muni F-Line, Pacific Electric (above), SEPTA Phase II, Pittsburgh, Los Angeles MTA, and Toronto (below).



Features of the HO scale ready-to-run model include an injection-molded plastic body, window glass, operating headlight, authentic painting and decorating, and operating roof poles (F-Line cars have dummy poles). Propulsion is through a 6' 6"



wheelbase truck with flywheel-equipped can motor. Standard DC versions have an MSRP of \$159.95 and include a 21-pin plug for an aftermarket DCC decoder (not supplied). DCC models list at \$259.95 and come with a factory installed LokSound Select dual-mode decoder which allows the model to operate on standard DC as well as on DCC layouts.

---



**Concept Models ([con-sys.com](http://con-sys.com))** is selling a body kit for an 89' car the Santa Fe Railroad used to transport large, lightweight aluminum wing assemblies for C5A aircraft. The basic components of the model are cast resin. Styrene sheathing is supplied for the face of the top shells. The entire lower side is a one-piece resin casting. The model has four separate shells that make up the top, which can lift off for loading and unloading. Decals and instructions are included, but grab irons, ladders, trucks, couplers, and other metal detailing parts are not provided. The kit is available direct at \$39.99.

---



**ExactRail ([exactrail.com](http://exactrail.com))** has released a Thrall 54' Conrail Coil Shield car. The ready-to-run Platinum

series HO scale model is available in 24 different road numbers at an MSRP of \$46.95 each. A discount of 10% applies to orders



contents



index

for six or more cars. The ready-to-run model comes with Kadee #156 couplers and ASF 100-ton Ride Control trucks with machined 36" wheels.



ExactRail has retooled the latest version of its Bethlehem 3483 cu. ft. covered hopper car with an improved narrow draft box with

the striker contour closer to scale. Shank wedges and complete nut-and-bolt detail have been enhanced. Additional features on the HO scale ready-to-run model include Wine double-door locks, equalized 100-ton ASF Ride Control trucks, machined metal wheelsets, and Kadee #58 couplers.

In addition to the Burlington Northern 1976 Havelock repaint shown here, Exact Rail's ready-to-run model is available decorated for Burlington (CB&Q 1967 Monogram HT-13B), Burlington (CB&Q 1969 Helvetica HT-13D), and Great Northern (1964 as delivered). The model is also available in three Rio Grande liveries including as delivered 12000-12499 series, 1996 Denver Post SP repaint, and with "Mainline thru the Rockies" slogan. All schemes are available in multiple numbers and a choice of either heaped or flood-style load. Check the above website for pricing and ordering information.



**Full Steam Ahead ([fullsteamahead.ca](http://fullsteamahead.ca))** has introduced a new waterfront structure kit called McMullin's Fresh Fish. The HO scale kit offers several construction options such as using either clapboard or cedar

shake siding, corrugated metal rolled roofing, or a combination of materials. The completed structure has a footprint of 5.5" x 3.25" plus the two loading docks. Additional information, including pricing, is available at the above website.

---



InterMountain Railway ([intermountain-railway.com](http://intermountain-railway.com)) has scheduled another run of its HO scale GP10 Paducah diesel locomotive for release next December. Details unique to the GP10 include a Horst air filter, horizontal nose headlight, extended right-front tool box, and rooftop engine access hatches. In addition to the Twin Cities scheme shown here, road names will be Illinois Central (death star scheme), Illinois Central Gulf (orange and gray), Illinois Central Gulf (orange and white), Paducah & Louisville, Precision, Farmrail, and U. S. Army. Basic DC versions of the ready-to-run model will have an MSRP of \$189.95. Locomotives equipped with an ESU LokSound decoder will list at \$279.95.



InterMountain plans to deliver 40' PS-1 boxcars this summer decorated for Canadian Pacific Railway, Union Pacific, Denver & Rio Grande Western, Southern (modern scheme), Erie Lackawanna, U. S. Air Force, ATSF (large herald), Soo Line, Seaboard Air Line, and Chesapeake & Ohio. The HO scale ready-to-run model comes with metal wheelsets and Kadee couplers. It will have an MSRP of \$34.95. An undecorated kit will be available with either 6', 7', or 8' doors. It comes with plastic wheels and no couplers. The kit will list at \$19.95.

---



contents



index



Kadee ([kadee.com](http://kadee.com)) has scheduled a March release for two new HO scale ready-to-run 40' PS-1 boxcars based on prototypes built in the 1950s. They include an Akron, Canton & Youngstown boxcar with 6' doors, narrow bolster tabs and a boxcar red paint job like the prototype. The model will have an MSRP of \$34.95.



Kadee's second PS-1 due in March will be a Columbus & Greenville car with 8' doors and wide bolster tabs. The MSRP will be \$37.95.

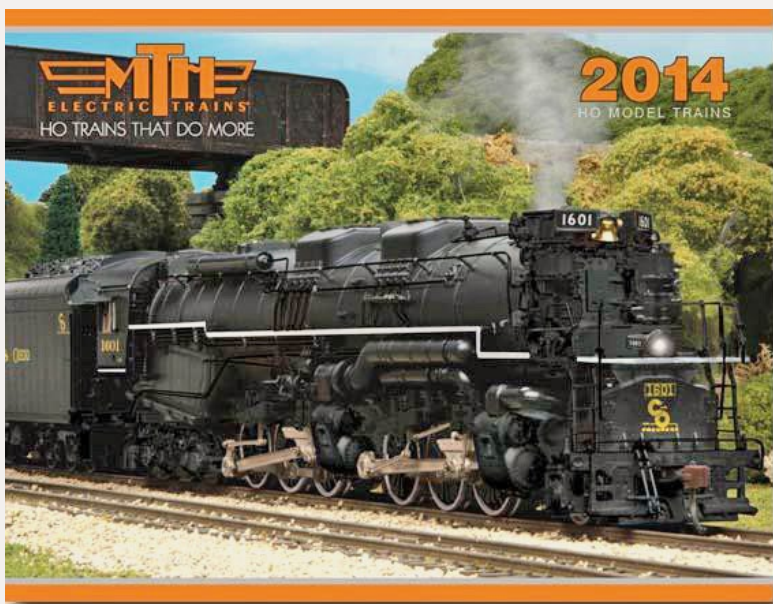

M.T.H. Electric Trains 2014 HO scale online catalog is available for viewing at [mthtrains.com/news/530](http://mthtrains.com/news/530). The online format offers page flipping, and hot links for favorite items. Keyword searching is available along with the ability to zoom-in on items, print individual pages, and email favorite pages to your friends.



The New York Central System Historical Society ([nycshs.net](http://nycshs.net)) has commissioned Accurail to produce several versions of MDT class M4 wood reefer cars. The wood sides and ends, fish-belly underframes,

four-foot door openings with three hinges, wooden door rests, Murphy XLA metal roofs, and AB brakes, combine to effectively represent 1920s construction as altered by post-1936 rebuilding. The yellow models are appropriate for 1943 though about 1952 while the yellow-orange versions represent equipment from a later period. Reservations are being taken now for HO scale kits scheduled for delivery in early March. The kits are priced at \$20.00 for NYCSHS members or \$25.00 to non-members. Additional details are available on the above website.

---

**Precision Scale Models ([precisionscaleco.com](http://precisionscaleco.com))** is scheduled to release several versions of this 2-6-6-2T



steam locomotive later this month. Built by Baldwin Locomotive Works specifically for the lumber trade, PSM is offering several road names with road-specific details and unique decorating schemes. They include Weyerhaeuser, Potlatch, Saginaw, White River, Rayonier, Clover Valley, and Feather River Lumber Company. Visit the above website for availability.



contents



index



**Red Caboose** plans to deliver an HO scale 1937 AAR boxcar with double doors next July or August. Road names

on the ready-to-run model will be Seaboard Railway, Lehigh Valley, Union Pacific (Automated Railway slogan), Union Pacific (Ship & Travel slogan with three-color shield), Northern Pacific, MKT, Atlantic Coast Line, and SSW-Cotton Belt (Blue Streak slogan). The MSRP will be \$34.95. InterMountain Railway is responsible for marketing Red Caboose products. For additional information visit [intermountain-railway.com](http://intermountain-railway.com).

---



**RSLaserKits** ([rslaserkits.com](http://rslaserkits.com)) has released a kit for a small water tower with a pump house. The assembled HO scale model has a footprint of 2.375" x 2.375". The model is suitable for a variety of applications including an industrial structure or area, a small town water supply, or at a service site for steam locomotives using a remote standpipe spout. Visit the above website for pricing and ordering instructions.

---



**SoundTraxx** ([soundtraxx.com](http://soundtraxx.com)) has released new Tsunami® Digital Sound Decoders™ for Athearn

Genesis ES44AC and Kato P42 HO scale locomotives. The TSU-GN1000 Tsunami Digital Sound Decoder (previous) now includes the GE GEVO-12 prime mover for Athearn Genesis ES44AC diesels and similarly designed models. The decoder is intended to replace the factory light board and includes hardware to accommodate 1.5V bulbs. Sounds include engine startup, shutdown, and eight throttle notch settings, as well as 16 air horns appropriate to the prototype. The GEVO-12 decoder (item #828059) has an MSRP of \$99.95.



For Kato P42 HO models, SoundTraxx has engineered a TSU-KT1000 featuring the GE-FDL-16 Modern prime mover. This format is designed specifically for Kato HO P42 models that have dual truck-mounted coreless motors. The decoder comes equipped with board-mounted LEDs positioned to fit the model's light piping and includes two extra 3.3V regulated outputs. Sounds include engine startup, shutdown, and eight throttle notch settings, plus 16 airhorns. The TSU-KT1000 (item #828068) has an MSRP of \$119.00.



**Walthers ([walthers.com](http://walthers.com))** has released Cornerstone<sup>®</sup> Merchants Row IV kit that assembles into one building with three two-story commercial stores under one roof. The

footprint of the assembled structure is 10.625" x 5" x 4" tall. The kit has an MSRP of \$39.98.



contents



index

Walthers has also released HO scale Gunderson express boxcars decorated for International Bridge & Terminal, Amtrak (silver), and Amtrak phase IVb (with stripes), and phase IVb (without stripes). The ready-to-run HO scale Proto<sup>®</sup> models has an MSRP of \$34.98.

---



**Westerfield Models** ([westerfieldmodels.com](http://westerfieldmodels.com)) has HO scale resin kits for several versions of Pennsylvania Railroad class X23 single-sheathed, outside-

braced boxcars including the original car (above). Kits are also available for cars with a new roof, with a new door and old roof, and with new roof and door (below).



Westerfield's craftsman-type cast resin kits come with appropriate decals, but without trucks or couplers. The kits mentioned above are available direct at \$42.00 each.

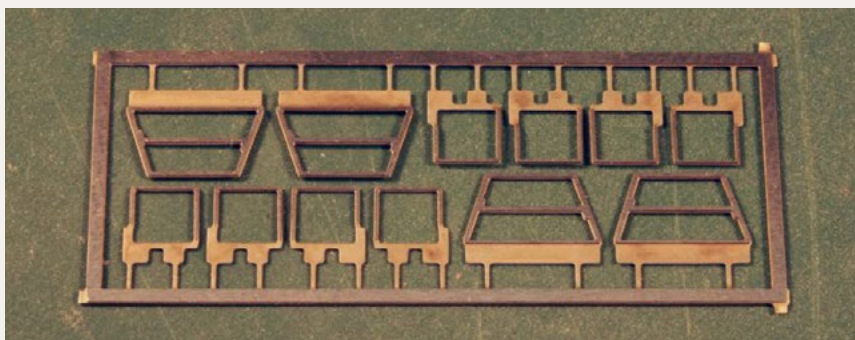

**Yarmouth Model Works** ([yarmouth-modelworks.com](http://yarmouth-modelworks.com)) has etched replacement stirrups



specifically designed to upgrade Intermountain's PFE reefers. As illustrated above, the fret has enough material for two cars. It sells for \$3.00. These won't snap off like the factory-supplied plastic ones. Owner Pierre Oliver reports that more etched stirrups for plastic cars are being developed.

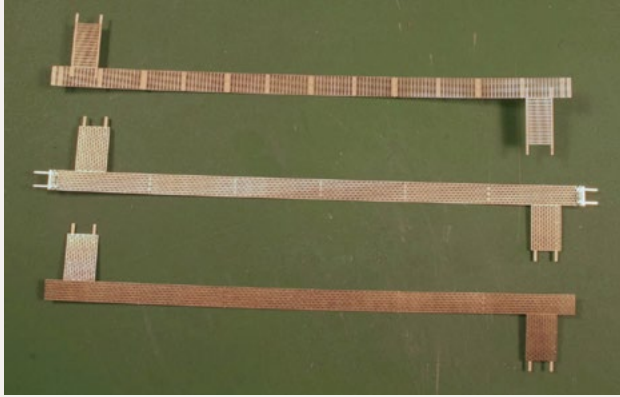

Here is a preview of some HO scale etched running boards coming soon from Yarmouth. From the top, they represent Apex, Kerrigan, and Morton metal running boards. Brake steps are also under development.

---

## N SCALE PRODUCT NEWS



N scale Bethgon Coalporter cars are now available from **Athearn ([athearn.com](http://athearn.com))** in several schemes including the CSXT car shown here. Additional road names are NS, CN, BN (black body), and BNSF (silver body). The models are available in five packs with different road numbers at an MSRP of \$99.98. Individual cars list at \$19.98 each.

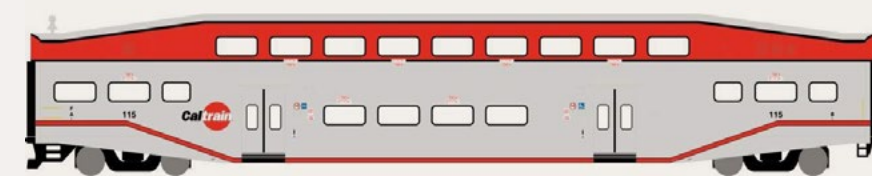

Also available now from Athearn are Bombardier commuter coaches



contents



index

decorated for METLK, CALTN, and WCE. They have an MSRP of \$49.98 each or \$149.98 for a three pack.



New N scale items coming from Athearn this summer include a GATC 2600 cu. ft. Airslide covered hopper cars decorated for American Maize Products; Atlantic Coast Line; Golden Loaf Flour; Western Maryland; and Chicago, Burlington & Quincy. The ready-to-run models will be available in three road numbers at an MSRP of \$21.98 each.



A 50' PS-1 boxcar with metal see-through running boards is also due from Athearn in

July. Priced at \$19.98 each, road names for the ready-to-run N scale models will be Missouri Illinois, Chesapeake & Ohio, Rock Island, Reading, Seaboard Coast Line, and Western Pacific.

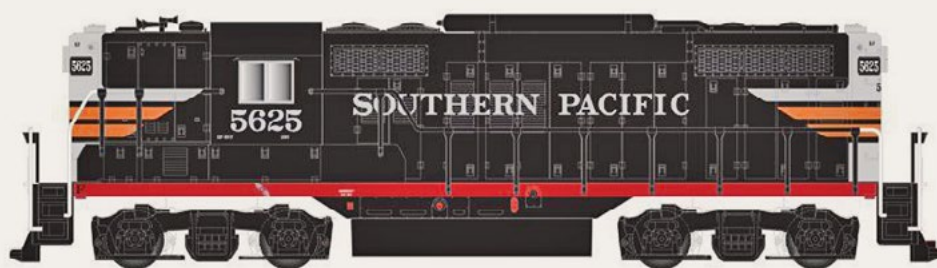

Atlas ([atlasrr.com](http://atlasrr.com)) will release another run of its Master® series GP9TT

“Torpedo Tube” locomotive during the third quarter of this year. In addition to the Southern Pacific version shown here, decorating schemes in the release will include Black River & Western, Central Vermont, Vermont Railway, Grand Trunk Western, Soo Line, and Clarendon & Pittsford. The MSRP will

be \$109.95. N scale models fitted with an NCE decoder will list at \$144.95.



An N scale 40' PS-1 boxcar is also due from Atlas in the third quarter of 2013. The ready-to-run models will have Barber S-2A 50-ton trucks. Road

names will be Boston & Maine, Chicago & North Western, Frisco, Norfolk & Western, Southern, U. S. Army, and Grand Trunk Western. Depending on the practice or the road being modeled, the 8' doors will be Youngstown, Pullman-Standard, or Superior. The MSRP for the Master<sup>®</sup> series model will be \$26.95. An undecorated model with all three types of doors will list at \$21.95. N scale modelers can look forward to a new release of Atlas' 11,000-gallon tank car during the second quarter of next year. ACF built the high-pressure prototype cars in 1947 for LPG service. In addition to the Hooker version shown above, the ready-to-run model will be available for Canadian Liquid Gas (CGTX), Dupont, MCVX Safety Train, PSPX, Union Texas Petroleum, and United States Army (USAX). Models without the loading platform will be available for Warren Petroleum, and Ryan Ruralgas (RRGX). The MSRP will be \$26.95. An undecorated model will also be offered at a list price of \$21.95.



Atlas will include an N scale Trainman<sup>®</sup> series 70-ton ore car in its third quarter release. Road names will be Canadian National, Canadian



contents



index

Pacific, Northern Pacific, Lake Superior & Ishpeming, Missabe “Quad” scheme, and Missabe “Safety First” scheme as seen here. The MSRP will be \$14.95. An undecorated version will list at \$11.95.

---



**Blair Line** ([blairline.com](http://blairline.com)) has a new kit for a Farmer's Fertilizer Bulk Plant. The laser-cut floor, sub-roof, and walls of the N scale kit feature tab-and-slot construction.

The roof material, trim, doors, windows and window glazing are also laser-cut. The truck loading conveyer may be positioned on either the side or end of the structure. The kit is priced at \$37.95. An HO scale version is currently under development.

---



**BLMA** ([blmamodels.com](http://blmamodels.com)) is selling a General American 3500 cu. ft. Dry-Flow covered hopper in

six road names. In addition to the Chicago Great Western version shown here, the N scale ready-to-run model is available for Burlington Northern, Pennsylvania Railroad, Union Pacific, GACX-Diamond Sugar, and GACX-Shell Plastics. The model faithfully replicates the prototype built by GA beginning in the mid-1950s and features a nicely detailed roof walk and a chemically etched metal brake wheel platform. The model has body-mounted Micro-Trains couplers and rides on 70-ton ASF Ride-Control

trucks with 33" metal wheelsets. The models are available in multiple road numbers at an MSRP of \$26.95 each.

---



### Con-Cor Trains

([con-cor.com](http://con-cor.com)) has released several versions of an N scale

fully-enclosed tri-level auto rack car. Road names include three Amtrak schemes plus BNSF (swish), Union Pacific, Kansas City Southern, Ferromex, CSX, and Southern Railway. The ready-to-run models feature authentic Micro-Trains Line couplers. The MSRP is \$29.98 each.

---

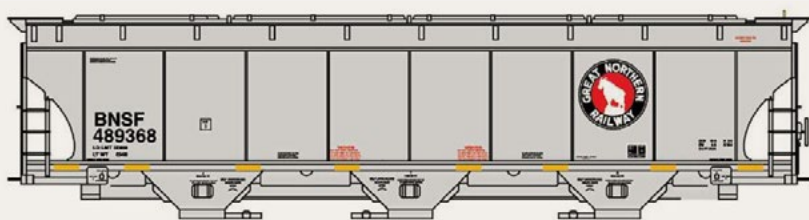

### InterMountain

Railway ([intermountain-railway.com](http://intermountain-railway.com)) is

taking reservations this month for delivery in

late summer for N scale Trinity 5161 cu. ft. covered hopper cars. Road names will be Union Pacific – CMO, Kansas City Southern, David J. Joseph, and Iowa Interstate. Also in the run are BNSF (swish), BNSF (Legacy-Spokane, Portland & Seattle), BNSF (Legacy-Frisco), and BNSF (Legacy-Great Northern) as seen here. The ready-to-run N scale model will have an MSRP of \$24.95. An undecorated kit without couplers will be available for \$10.95.

---



New ready-to-run N scale models released by **Micro-Trains Line** ([micro-trains.com](http://micro-trains.com))

include a 60' ATSF box-



contents



index

car with double plug doors and a large Super Shock Control slo-gan. The model has an MSRP of \$28.95.



Also new is a GATX 56' tank car carrying the distinctive Industrias Zahori name and a three-color Mexican

flag. The model has a list price of \$35.80.



Micro-Scale's latest 36' double-sheathed wood reefer is decorated for the Manhattan Brewing Company of Chicago, IL. The truss-rod era model has an MSRP of \$26.95.

Other new N scale models from Micro-Trains include a 33' twin-bay hopper car decorated for DAFX-United States Air Force, a 39' WSRX single-dome tank car with a silver body decorated for Staroline Gasoline, an SP triple-bay Centerflow covered hopper, a 50' CN (wet noodle) box car with plug and sliding doors, and a Pennsylvania 50' gondola with roof. Additional information, including pricing, is available at the above website.

---

## NEW DECALS, SIGNS AND FINISHING PRODUCTS

Dan Kohlerg ([home.mindspring.com/~paducah](http://home.mindspring.com/~paducah)) has released three styles of HO scale decals for GM&O green PS-1 boxcars. The three are DF non-cushioned 1969+ (ICG-67), 40" Hydroframe cushioning 1966+ (ICG-68), and 60" Hydroframe cushioning 1962+ (ICG-69). Also new are HO decals for Great Northern 50'

Plate C double-door boxcar 1967+ (BN-04), and Burlington Northern 50' Plate C double-door boxcar 1974+ (BN-05). Visit the above website for pricing and ordering information.

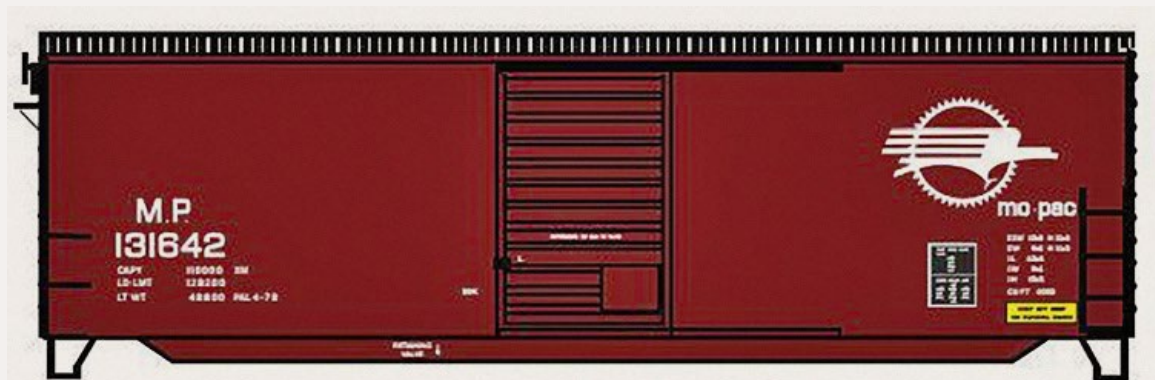

**Mask Island Decals** ([maskislanddecals.com](http://maskislanddecals.com)) has released several new HO scale decals, including a lettering set for a 40' MoPac boxcar with 8' doors and screaming eagle buzzsaw herald as seen here. Additional MoPac sets are for a similar car with a standard buzzsaw logo, and a 50' ACF-built boxcar, also with a standard buzzsaw logo. Also lettering sets for ACL 50' PDS-1 shock control boxcar, a 40' PS-1 DF loader boxcars, a C&EI 50' ACF boxcar, a CNW 40' PS-1 boxcar, and a Milwaukee Road combination door boxcar. Also new are sets for several Southern Railway flat cars. Visit the above website for full details including pricing.

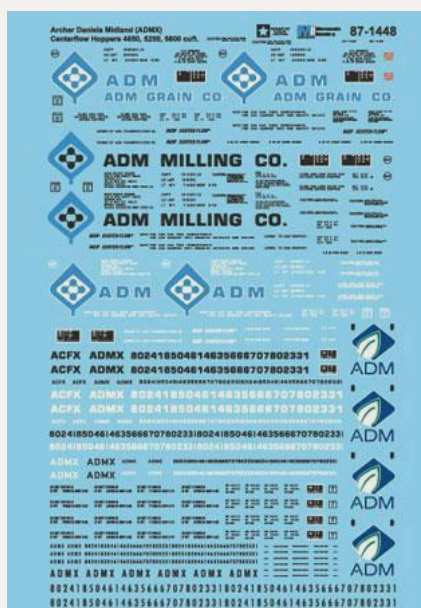

New HO and N scale decals recently released by **Microscale** ([microscale.com](http://microscale.com)) include volume 1 of a new series on Internet Era Business Signs, Archer Daniels



contents



index

Midland (ADMX) 4650, 5250, and 5800 cu. ft. Centerflow hoppers, Linea Mexicana (TMMU) 40' and 20' containers, Ferrocarril del Pacifico (FCP) boxcars, Monon Railroad diesel hood locomotives, and American Car & Foundry Leasing (ACFX) 5250 and 5701 cu. ft. Centerflow hoppers for plastic service. Visit the above website for pricing and ordering information.

---

**Mount Vernon Shops** ([mountvernshops.com/X28.html](http://mountvernshops.com/X28.html)) has HO scale decals for Pennsylvania Railroad X28/X28a boxcars. Each set does three cars with enough data to properly letter one X28 or three X28a cars. Check the above website for pricing and ordering details.

---

**San Juan Decals** ([sanjuandecals.com](http://sanjuandecals.com)) has announced two new decal sets for 1:20.3 scale equipment. Available now are sets for D&RGW MoW flat car, and RGS Sunshine herald locomotive. Visit the above website for pricing and ordering information.

---

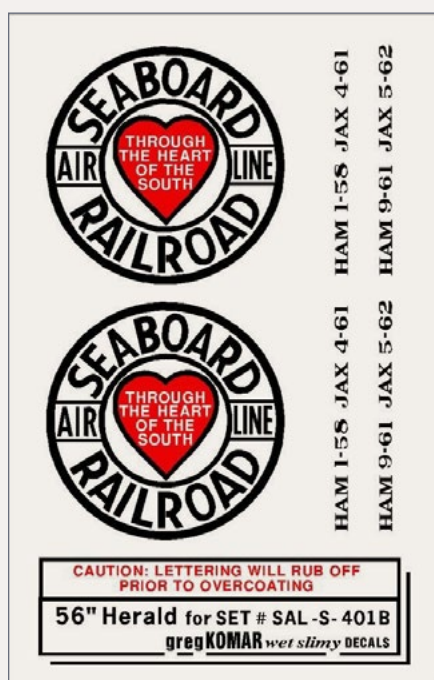

**Smoky Mountain Model Works** ([smoky-mountainmodelworks.com](http://smoky-mountainmodelworks.com)) is selling S scale decals for SAL Class B7 turtleback roof boxcar. The decals cover the 1941-47 period. They are available at \$10.00 per set.

---



N-HO INSTANT S-O  
**DETAILING**  
 AWESOME ..FINISHED  
 \*\*\*LAYOUT READY\*\*\*  
 STRUCTURES & DETAILING

**N SCALE DETAILS**  
 CLICK HERE



**HO SCALE DETAILS**  
 CLICK HERE



**O SCALE DETAILS**  
 CLICK HERE



[WWW.MODELTECHSTUDIOS.COM](http://WWW.MODELTECHSTUDIOS.COM)

**DISCLAIMER ..**

The opinions expressed in this column are those of the writer and do not necessarily reflect the opinion of Model Railroad Hobbyist or its sponsors. Every effort is made to provide our readers with accurate and responsible news and information, however, neither Model Railroad Hobbyist or the writer of this column can be held responsible for any inaccuracies or typographical errors that may inadvertently appear in this column.



**Send us your product announcements**

If you are a hobby manufacturer with a product announcement, just [click here](#) and submit your announcement to us. Our web site and free magazine reach continues to grow, so get on board with this new media train that's hard to stop!

**Reader Feedback**  
 (click here) 



## Selected Events



### January 2014

**FLORIDA, COCOA BEACH**, January 9-11, Prototype Rails 2014 hosted by Mike Brock, at Cocoa Beach Hilton Oceanfront, 1550 N. Atlantic Ave. (Highway A1A). Premier RPM event featuring some 80 clinics presented by a blue ribbon cast of speakers. Info at [prototyperrails.com](http://prototyperrails.com).

**GEORGIA, SAVANNAH**, January 18-19, 25th Annual Model Railroad and Train Show, sponsored by Coastal Rail Buffs Inc. Info at [coastalrailbuffs.org](http://coastalrailbuffs.org).

**MARYLAND, BALTIMORE**, January 5, 12, 19, and 26, 2014, Model Railroad Club Open House, at Baltimore Society of Model Engineers (BSME) with operating HO and O scale layouts, admission by donation. 225 W. Saratoga St. (3rd floor walkup). Info at [modelengineers.com](http://modelengineers.com).

**MASSACHUSETTS, WEST SPRINGFIELD**, January 25-26, Railroad Hobby Show, sponsored by Amherst Railway Society, at Eastern States Exposition Fairgrounds. Info at [amherstrail.org](http://amherstrail.org).

**MICHIGAN, EAST LANSING**, January 12, Train Show & Sale, sponsored by the Lansing Model Railroad Club, at Michigan State University Pavilion. Info at [lmrc.org](http://lmrc.org).

**MISSOURI, ST. CHARLES**, January 18, Train Fair, sponsored by St. Charles Railroad Club, at Heart of St. Charles Banquet Center, 1410 S. Fifth Street. Info at [stcharlesrailroadclub.com](http://stcharlesrailroadclub.com).

**NEW JERSEY, NORTH HALEDON**, January 4-5, 56th Annual Model Railroad Show at 575 High Mountain Road. Sponsored by Garden State Model Railroad Club. Info at [gsmrrclub.org](http://gsmrrclub.org).



**WASHINGTON, SEATTLE**, January 18-20, Model Railroad Show, hosted by Pacific Science Center. For details contact Katelyn Del Buco at [kdelbuco@pacsci.org](mailto:kdelbuco@pacsci.org).

## February 2014

**CANADA, ONTARIO, BARRIE**, February 15-16, 2014, 44th Annual Barrie Allandale Model Train Show, “under the glass” at Bradford Greenhouse, 4346 County Road 90. Info at [barm.ca](http://barm.ca).

**CALIFORNIA, SANTA CLARA**, February 6-8, 2014, O Scale West and S West combined meets, with both standard and narrow gauge modular layouts, dealer tables, clinics, videos, and contests. Hyatt Regency, 5101 Great America Parkway. Info at [oscalewest.com](http://oscalewest.com).

**MARYLAND, TIMMONIUM**, February 1-2, Great Scale Model Train Show featuring more than 700 vendors. Produced by Howard Zane at State Fairgrounds, 2200 Yorke Road.

**OREGON, PORTLAND**, February 1, 2014, SP&S Railway Historical Society Railroad Swap Meet, Holiday Inn at Portland Airport, 8439 NE Columbia Blvd., Portland, Oregon. Additional information from Jerry Pickell at [pickell5141@nsn.com](mailto:pickell5141@nsn.com) or call 360-735-0516.

**SOUTH CAROLINA, EASLEY**, February 1-2, 2014, Annual Train Show with HO layouts, G scale live steam, motor cars, kids activities, and 200 plus vendors. Sponsored by Central Railway Model & Historical Association, at Larry Bagwell Gymnasium, 111 Walkers Way. Info at [CRMHA.org](http://CRMHA.org).

**TEXAS, IRVING (Dallas area)**, February 26-March 1, 2014, 29th Annual Sn3 Symposium, at Sheraton DFW, Irving. Info at [sn3-2014.com](http://sn3-2014.com).



contents



index

**TEXAS, HOUSTON**, February 15, 2014, Greater Houston Train Show featuring 20,000 square feet of operating layouts, instructive classes, photo and model contests, and vendor displays presented by San Jacinto Model Railroad Club, at Stafford Centre, 10505 Cash Road. Info at [sanjac.leoslair.com](http://sanjac.leoslair.com).

## **Future (By location)**

**AUSTRALIA, NSW, ALBURY**, May 24-25, 2014, Annual Train Show sponsored by the Murray Railway Modellers Inc., at Mirambeena Community Centre, 19 Martha Mews, Lavington. Info at [murrayrailwaymodellers.com](http://murrayrailwaymodellers.com).

**CANADA, ONTARIO, OTTAWA**, April 26-27, 2014, Ottawa Train Expo sponsored by Bytown Railway Society. At Ernst & Young Centre, 4899 Uplands Drive. Info at [ottawatrainexpo.com](http://ottawatrainexpo.com).

**ILLINOIS, COLLINSVILLE (Metro St. Louis, Missouri)**, August 8-9, 2014, St. Louis Railroad Prototype Modeler's Meet, with clinics, displays, manufacturer's exhibits, layout visits and operating sessions. At Gateway Convention Center. Info at [icg.home.mindspring.com/rpm/stlrpm.htm](http://icg.home.mindspring.com/rpm/stlrpm.htm).

**INDIANA, INDIANAPOLIS**, July 3-10, 2016, NMRA National Convention and National Train Show. Info at [nmra2016.org](http://nmra2016.org).

**MAINE, AUGUSTA**, Sept. 7-10, 2016, 36th National Narrow Gauge Convention. Info at [nngc2016.org](http://nngc2016.org).

**KANSAS, OVERLAND PARK (Metro Kansas City, MO)**, September 3-6, 2014, 34th National Narrow Gauge Convention. Info at [kansascity2014.com](http://kansascity2014.com).

**MISSOURI, SPRINGFIELD**, March 15, 36th Annual Train/Swap Meet with operating layouts, kids activities, track laying contest, switching challenge, and appraisals/diagnostics for pre-1970 trains. At Remington's, 1655 W. Republic Road. Info at [omraspringfield.org](http://omraspringfield.org).



**NORTH CAROLINA, SPENCER**, May 29-June 1, 2014, Streamliners at Spencer, a gathering of prototype locomotives from the 1930s through the 1950s at the North Carolina Transportation Museum including an Atlantic Coast Line E3 and the Southern Railway's E8 and FP7. Details at [nctrans.org/Events/Streamliners-at-Spencer-\(1\).aspx](http://nctrans.org/Events/Streamliners-at-Spencer-(1).aspx).

**OHIO, CLEVELAND**, July 13-19, 2014, NMRA National Convention and National Train Show. Info at [2014cleveland.org](http://2014cleveland.org).

**OHIO, GREENFORD**, March 20-22, 2014, 21st Annual Midwest Narrow Gauge Railroad Show, cosponsored by the Cleveland Narrow Gauge Society and the Mini Bunch. Features include clinics, vendor tables, and tour of Baird Brothers Sawmill. At Greenford Space Center and Smokehouse Restaurant, Route 165. Info at [maine2footquarterly.com/midwest.htm](http://maine2footquarterly.com/midwest.htm) or [midwestnarrowgaugeshow@yahoogroups.com](mailto:midwestnarrowgaugeshow@yahoogroups.com).

**OKLAHOMA, TULSA**, March 21-23, Layout Design and Operations Meet, sponsored by the Indian Nations Division of the NMRA in conjunction with the Layout Design SIG and Operations SIG. Speakers include Joe Fugate and Tony Thompson. At Shriner's Temple, 28th & Sheridan. Info at [ldop-sigmeet.tulsanmra.org](http://ldop-sigmeet.tulsanmra.org).

**OREGON, PORTLAND**, March 15, 2014, 29th Annual Model Railroad Swap Meet, sponsored by Willamette Model Railroad Club, Kliever Memorial Armory, 10000 NE 33rd Drive. Info from Keith Kieres at [wmrswapmeet@yahoo.com](mailto:wmrswapmeet@yahoo.com).

**OREGON, PORTLAND**, August 23-30, 2015, NMRA National Convention and National Train Show. Info at [nmra2015.org](http://nmra2015.org).

**PENNSYLVANIA, MALVERN**, March 28-30, 2014, 6th Railroad Prototype Modelers Valley Forge Meet, at Desmond Great Valley Hotel. Info at [phillynmra.org/rpmmeet.html](http://phillynmra.org/rpmmeet.html).



contents



index

**TEXAS, HOUSTON, 2015, September 2-5, 2015, 35th National Narrow Gauge Convention.** Info at [nngc-2015.com](http://nngc-2015.com).

**VIRGINIA, STAFFORD, September 12-13, 2014, Mid-Atlantic Railroad Prototype Modelers Meet, with model displays, clinics, and RPM camaraderie.** Wingate by Wyndham Hotel, Fredericksburg, VA. Info at [marpm.org](http://marpm.org). ■



*Advertisement*

# Railroad Explorer Magazine

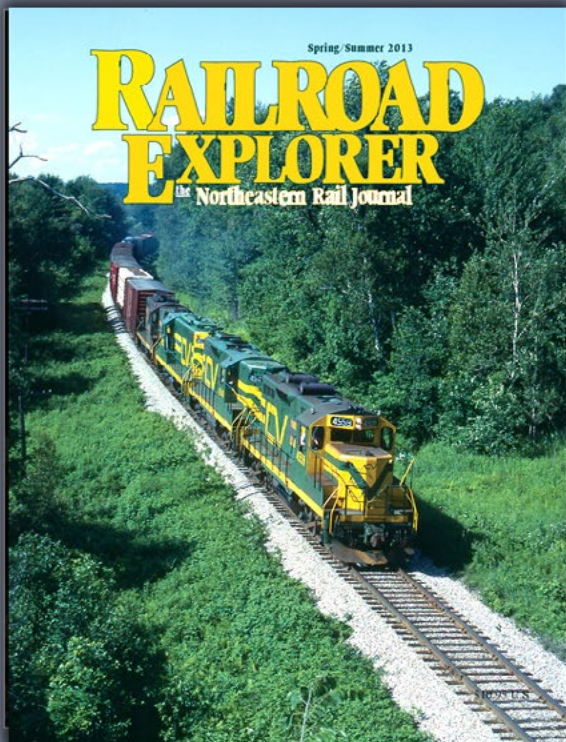

- Three, all-color issues per year.
- Exciting feature stories, spectacular photos.
- Best-in-class photo reproduction.
- Printed on heavy, glossy paper.
- Zero advertising. All content.
- Winter, Spring/Summer and Fall editions.

**Issue 38 - Spring/Summer 2013**

**On sale now**

**Subscribe Today!**

[www.railroadexplorer.com](http://www.railroadexplorer.com)

MRH-Jan 2014



# TRAIN MASTERS

Click to visit us!

Only from:  
Model Railroad  
Hobbyist magazine™

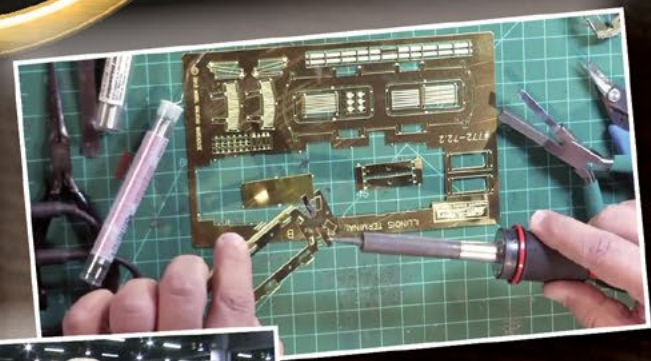

**\$5.99 / month - Annual membership: \$55 per year  
(4.58 / month)**

**Two-year membership special:  
\$99 for two years  
(\$4.13 / month)**

**Sign up today!**



# Laying the foundation

## Reverse Running: Stepping outside the box with a contrary view

by Don Hanley

I recall a story about a group of kids wanting to build a club house: they started with the walls, not the foundation.

So what is the foundation of a model railroad?

Some modelers don't yet have space for any layout, let alone their dream layout. This is where I believe a real foundation can be laid: research.

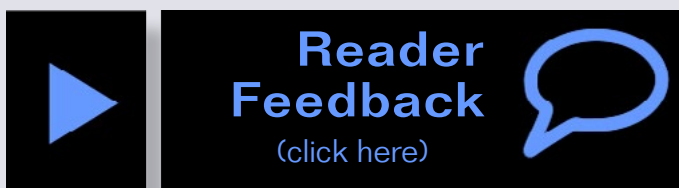

I began my layout research by asking:

- What era of railroading do I like? What am I familiar with?
- What area do I like? Eastern US, mountains, big cities, etc.?
- What railroads do I like the best? If there is more than one road, is there an area where they both operate?
- What type of railroading do I like? Heavy mainline with unit trains, industrial switching, or a backwoods branchline?
- What type of model railroading do I like? Nut and bolts accurate, completely freelance, or somewhere in-between?

After determining your likes, it's time to begin the research. No need to go overboard and spend the rest of your life doing research



(some do it as a profession). Do just enough to feel confident in what you want model.

There's also field work, aka railfanning. Have your camera, notepad, and tape measure handy.

I followed this procedure and then started building rolling stock, locomotives, and small support structures. This is where I have been in the hobby for almost a decade. Only now am I beginning to build a layout.

This process led to several benefits:

- I have confidence about the where, what, and when of my modeling and layout.
- I have improved my modeling skills along the way.
- When the layout is ready for operating, the rolling stock and some structures have already been built.
- I don't feel overwhelmed needing to spend time on both building a fleet of equipment and the layout at the same time.
- As portions of the layout are ready for scenery, I will be able to spend more time adding details (my personal preference) than just building the necessary structures to fill the planned space.
- I can target my hobby spending on pieces of equipment that only fall into the parameters I set for modeling.

It is important to write your plan. If you don't, you can find yourself wandering from it. Find the sweet spot for yourself. Once you have found it, you will have a passion for your hobby that won't go away.

Sometimes you win, sometimes you learn something new, but either way you are laying a solid foundation for your hobby. ✓



contents



index

# Clickable advertiser index

[Accu-Lites](#)

[Accurail](#)

[Amherst Railway Society](#)

[Alpine](#)

[Archer Fine Transfers](#)

[Bachmann](#)

[Backdrop Junction](#)

[Berrett Hill \(1\)](#)

[Berrett Hill \(2\)](#)

[BLMA](#)

[Best Trains](#)

[Bowser](#)

[Bullfrog Snot](#)

[Clever Models](#)

[Coffman](#)

[Credit Valley](#)

[DCC by Design](#)

[Digitrax \(2 page spread\)](#)

[ExactRail](#)

[ESU](#)

[Fifer Hobby Supply](#)

[Fox Valley](#)

[GLX Scale Models](#)

[Great Decals](#)

[InterAction Enterprises](#)

[Island Modelworks](#)

[Iowa Scaled Engineering](#)

[Iwata-Medea](#)

[Jelsma](#)

[KMJ Model Trains](#)

[Litchfield Station](#)

[Logic Rail Technologies](#)

[Microscale](#)

[Minimalist Model Railroad](#)

[Model Railroad Benchwork](#)

[Model Tech Studios](#)

[Motrack Models](#)

[MRH Store \(Model Trains Video\)](#)

[M.T.H.](#)

[Mullet River \(O scale\)](#)

[Nano-Oil](#)

[NCE \(2 page spread\)](#)

[Olin's Depot](#)

[Rail Design Services](#)

[RailMaster Hobbies](#)

[Railroad Explorer](#)

[Rapido \(2 page spread\)](#)

[Ring Engineering \(1\)](#)

[Ring Engineering \(2\)](#)

[RLN Publishing](#)

[RSlaserKits](#)

[Rulers-of-the-World](#)

[Rusty Stumps](#)

[San Juan Car Company](#)

[SAZ Model](#)

[Streamlined Backshop](#)

[Scenic Express](#)

[Scotty Mason Show](#)

[Soundtraxx](#)

[Southern Digital](#)

[TAM Valley Depot](#)

[TrainMasters \(1\)](#)

[TrainMasters \(2\)](#)

[True Line Trains](#)

[True Scene Modeling](#)

[Westerfield Models](#)

[Yankee Dabbler](#)



# Clickable topic index

[DCC Impulses – How to safely connect multiple speakers](#)

[Editorial – Publisher’s commentary](#)

[Editorial – Reverse running](#)

[Getting Real – How long did it take you to build your Layout?](#)

[Layout – Journey to Allagash Country Part 1](#)

[News – January Newsletter](#)

[News – January Events](#)

[Q and A – MRH Questions, Answers, and Tips](#)

[Rolling Stock – Improving a 1970s Athearn Santa Fe SD45](#)

[Rolling Stock – Sheffield Velocipede](#)

[Structures – Modeling a radio base station](#)

[Techniques – The easiest way yet to make molds](#)

[Yes It's a Model – Monthly photo albumn](#)

[What’s Neat – Scott Sanders - weathering](#)

---

[Other – Bonus Extras](#)

[Other – Cover](#)

[Other – Derailments](#)

[Other – Hobby Marketplace](#)

[Other – MRH Sponsors](#)

[Other – Staff Notes](#)

[Other – Table of Contents](#)

# D e r a i l m e n t s

humor (allegedly) and bizarre facts



Ever wonder how the railroads ever settled on a gauge of 4'-8½"? What do horses have to do with determining the gauge? Follow the link to [A Horse's Behind, and Railroad Tracks](#) to read a fascinating story how this bit of history has its fingers on everything from railroads to space travel.

If you're the first to [submit a bit of good humor](#) and we use it, it's worth \$25!



**Reader  
Feedback**

(click here)



# For the love of model trains

## Coming Jan 27th

- Structures in tight places
- Railfanning the Allagash, part 2
- Turnout control protection
- Grand prize winner in MRH's \$500 starter layout contest  
*...and lots more!*



## More Derailments humor ...



Great, now my commuter train is lost as well ...



Oh darn it, Johnson built the super elevation just like I told him to.

Coming next issue



contents



index