

Tar paper roofing • Prototype Ops • Fix staging access issues

Model Railroad Hobbyist magazine™



July 2013

Price: Forever Free

Modeling the City of Miami ... car-for-car



HAVING FUN WITH TRAINS



Embedded edition - Landscape



download

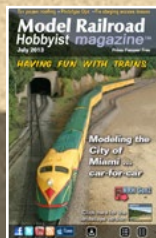

Looking for the Portrait version? [Click here ...](#)



contents



index



GET YOUR **JTTX!**

ACF F89-J 89' Flat Car - JTTX

CLICK HERE TO SEE MORE



Model Railroad Hobbyist magazine™

Front Cover: James Eager takes us through modeling the Illinois Central's stunning name passenger train, the *City of Miami*, starting with this issue.

ISSN 2152-7423

Editorial Staff

Joe D. Fugate, Publisher and Editor
Don Hanley, Assistant Editor

Production

Patty Fugate, pasteup and layout
Joe Brugger, copy editing
Mike Dodd, copy editing

Technical Assistants

Jeff Shultz
Jimmy Simmons

Advertising

Les Halmos, Account Manager
Daniel Nava, Advertising Assistant
Jean-François Delisle, Marketing Assistant

Published for the glory of God. [What's this?](#)

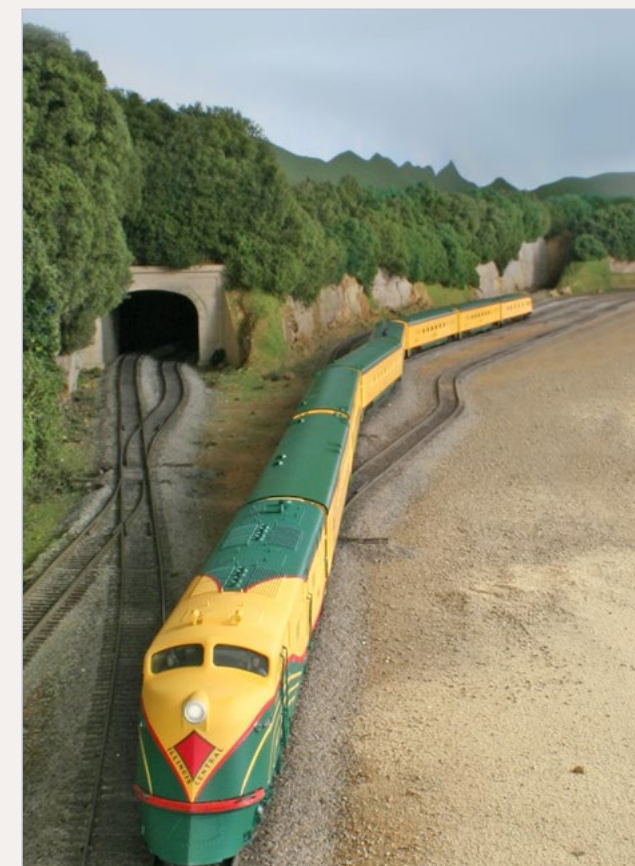

Columnists

Richard Bale, News and events
Jeff Shultz, News and events
Les Halmos, Modular railroading
Ken Patterson, Reporter at large
Bruce Petrarca, DCC

Special Correspondents

Joe Brugger, Questions & answers
Charlie Comstock, Contributing editor

Issue password: Jul2013





click to learn more about this sponsor



click to learn more about this sponsor



click to learn more about this sponsor



click to learn more about this sponsor



click to learn more about this sponsor



click to learn more about this sponsor



click to learn more about this sponsor



NEW SPONSOR!



NEW SPONSOR!



click to learn more about this sponsor



click to learn more about this sponsor



NEW SPONSOR!



click to learn more about this sponsor

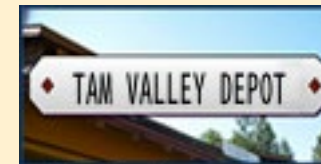

click to learn more about this sponsor



click to learn more about this sponsor



click to learn more about this sponsor



click to learn more about this sponsor



click to learn more about this sponsor



click to learn more about this sponsor



NEW SPONSOR!



click to learn more about this sponsor



click to learn more about this sponsor



click to learn more about this sponsor



click to learn more about this sponsor



click to learn more about this sponsor



click to learn more about this sponsor



click to learn more about this sponsor



click to learn more about this sponsor



click to learn more about this sponsor



NEW SPONSOR!



click to learn more about this sponsor



NEW SPONSOR!



click to learn more about this sponsor



click to learn more about this sponsor



click to learn more about this sponsor



click to learn more about this sponsor



click to learn more about this sponsor



click to learn more about this sponsor



click to learn more about this sponsor



click to learn more about this sponsor



click to learn more about this sponsor



click to learn more about this sponsor



click to learn more about this sponsor



click to learn more about this sponsor



click to learn more about this sponsor



click to learn more about this sponsor



click to learn more about this sponsor

Want your logo on this page? Click to find out how....

90,000+ unique device views per month...

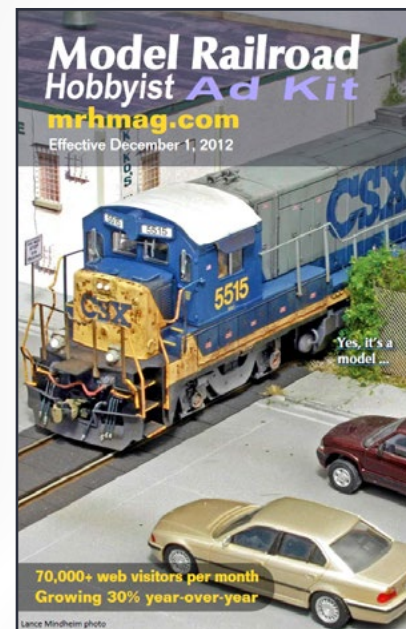

Tell me more

Looking for something? Check our Hobby Marketplace!

Take me there



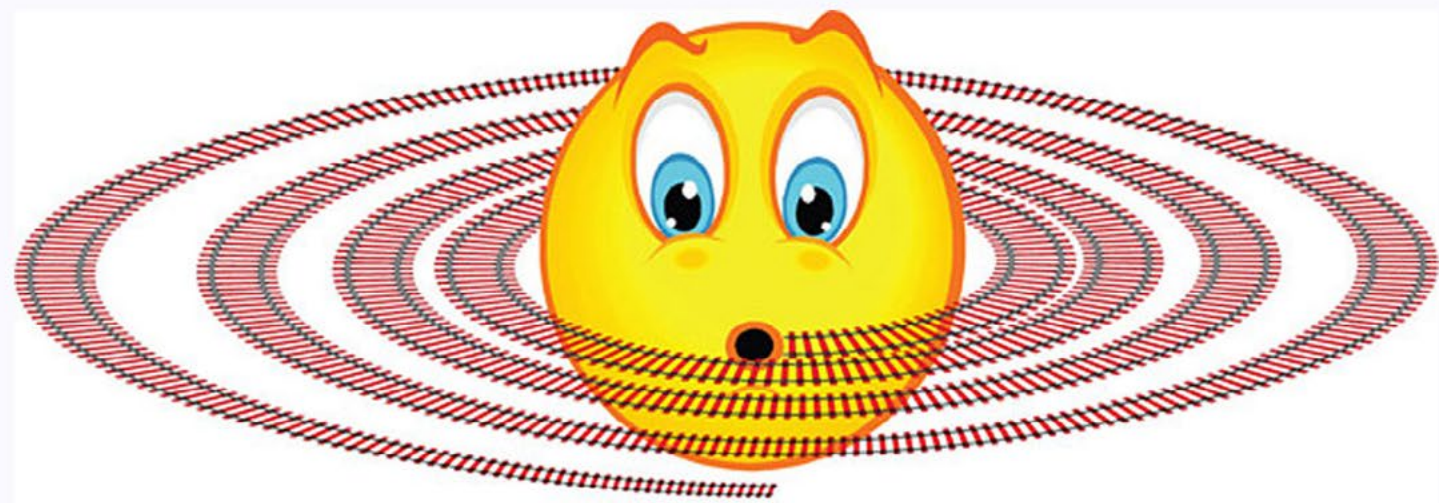

Bendy TrackTM
BY RAPIDO TRAINS INC.

Coming Soon!

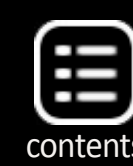

Table of Contents - 1

Main Features

*Click title
to view*



Scale flash photography

Put an animated photographer on your layout
by Geoff Bunza



Modeling the City of Miami, part 1

Replicate this name passenger train, car-for-car
by James Eager



Yes, it's a model

MRH's great modeling photo feature
compiled by the MRH staff



Tar paper and other roofing methods

Covering your structure roof more effectively
by Mike Tylick

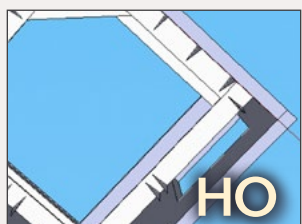

Third place winner, \$500 layout contest

Using free software to design a layout
by Ben Kaur



Erie Railroad boxcars of the '50s, part 4

Mass-production scratchbuilding techniques
by Don Hanley



Athearn 57' WFE Reefer

by Jeff Shultz



July News

*by Richard Bale
& Jeff Shultz*

Table of Contents - 2

Other Features

*Click title
to view*

Modeling to your passion

Publisher's commentary
by Joe Fugate

MRH Staff Notes

Monthly not enough?
by the MRH staff

MRH Q - A - T

Questions, Answers, and Tips
compiled by Joe Brugger

Hobby Marketplace

Vendor ads

Derailments

Humor?

Columns

Staging access issues

Up the Creek
by Charlie Comstock

Proto ops for modelers

Getting Real
by Jack Burgess

Dave Davis' car loads

What's neat this week
by Ken Patterson

Less is more

Reverse Running
by Don Hanley

Subscriber-only bonus extras (*subscribers click here to access*)





EXACTRAIL[®]
The Next Generation of Model Railroading

HO NEW AT EXACTRAIL
THE WORLD'S
FINEST WHEEL SETS

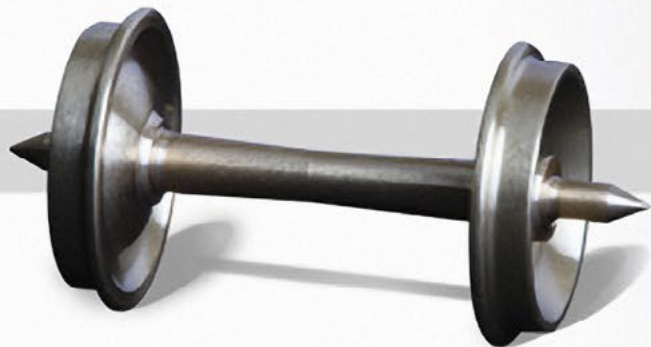

AVAILABLE SOON
IN HO-SCALE!



HO

LEARN MORE



Modeling to your passion

What got you into trains?

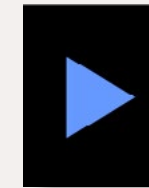

**Reader
Feedback**
(click here)



Publisher's Musings editorial
by Joe Fugate



A real defining moment for me came after I had been in the hobby for quite a while. It hit me like a ton of bricks and it has defined my direction in the hobby ever since: modeling to my passion.

I grew up in southern Oregon, next to the SP Siskiyou Line. I loved to watch the big lumber trains roar by. Railfanning this line as a kid delighted me, and that fun continued right up into the 1980s as a young adult.

I started into trains with a trainset I got for Christmas. After playing with the 3-rail trainset for a few months, I eventually discovered *Model Railroader* magazine and HO scale. The realism of HO (as compared to 3-rail trains) just blew me away.

Through the pages of *Model Railroader* – and later, *Railroad Model Craftsman* – I discovered John Allen and his amazing Gorre & Daphetid. I was totally enthralled.

This put me on a steam-era freelancing kick for many years with my Morale Falls & Sadgino (pronounced “sad-jya-no”) switching layout. This long-term flirtation with freelance kept



EMD SD45 DIESEL HO SCALE



New Roadnames & Numbers

PROTO 2000® - In Stock

Tsunami® Sound & DCC \$299.98 | Standard DC \$199.98

WALTHERSPROTO® FASTFACTS™

EMD celebrated New Years Day 1966 by introducing six new SD series locos including the SD45, with an enormous 20-cylinder power plant cranking out 3600 horsepower. Timing couldn't have been better as American railroads experienced a surge in traffic and were ready to modernize. The SD45 proved popular, and 1,260 were built through late 1971, when production switched over to SD45-2. Original owners began to retire units in the 1980s, but many were rebuilt and sold to regional railroads. Several are now preserved.

- Limited Edition - One Time Run of These Roadnumbers!
- Road-Specific Detailing
- 14:1 Helical Gears for Smooth, Quiet Performance
- Low Speed Under 3 Scale MPH
- Available with Soundtraxx® Tsunami® Sound for DCC & DC Layouts
- Standard DC Versions also Available
- LED Constant & Directional Headlights
- Proto MAX™ Metal Knuckle Couplers

ATSF

Detailed to match units 1985-90+ with:



- Cab Mounted Headlights
- Short Blower Sill Duct
- Modern Style Coupler Cut Lever
- Large Flattop Beacon (Nonoperating)
- Roof-Mounted Air Conditioner
- Raised Leslie S-3L Horn
- Dynamic Brake Vent
- Oval Cab Vent
- Large Sinclair Antenna
- Air Filter Box
- Late Flexicoil Trucks w/Two High, Outside Mounted Brake Cylinders
- Brake Frame w/3 Brake Shoes

920-41050 #5374 Tsunami Sound & DCC
920-41051 #5380 Tsunami Sound & DCC
920-48050 #5377 Standard DC
920-48051 #5400 Standard DC

CNW

Detailed to match units Late 1980s-95 with:



- Cab Mounted Headlights
- Long Blower Sill Duct
- Modern Style Coupler Cut Lever
- Large Round-Top Beacon (Nonoperating)
- Leslie S-3L Horn
- Dynamic Brake Vent
- Firecracker Antenna
- Air Filter Box
- Winterization Hatch
- Late Flexicoil Trucks w/2 High Outside Mounted Brake Cylinders
- Brake Frame w/3 Brake Shoes

920-41052 #6474 Tsunami Sound & DCC
920-41053 #6485 Tsunami Sound & DCC
920-48052 #6472 Standard DC
920-48053 #6482 Standard DC

PRR

Detailed to match units 1966-69+ with:



- Cab Mounted Headlights
- Long Blower Sill Duct
- Standard Style Coupler Cut Lever
- Leslie S-3L Horn
- Large Sinclair Antenna
- Small 2-Strap Signal Equipment Box
- Late Flexicoil Trucks w/2 Low, Inside Mounted Brake Cylinders
- Brake Frame w/3 Brake Shoes

920-41054 #6110 Tsunami Sound & DCC
920-41055 #6127 Tsunami Sound & DCC
920-48054 #6118 Standard DC
920-48055 #6136 Standard DC

UP*

Detailed to match units late 1970s - early 80s with:



- Cab Mounted Headlights
- Short Blower Sill Duct
- Standard Style Coupler Cut Lever
- Large Round-Top Beacon (Nonoperating)
- Raised Leslie S-3L Horn
- Dynamic Brake Vent
- Large Ground Plane w/2 Can Antennas
- Firecracker Antenna
- Air Filter Box
- Small 2-Strap Signal Equipment Box
- Large Cab Arm Rest
- Early Flexicoil Trucks w/3 High Outside Mounted Brake Cylinders
- Brake Frame w/6 Brake Shoes

920-41056 #12 Tsunami Sound & DCC
920-41057 #31 Tsunami Sound & DCC
920-48056 #15 Standard DC
920-48057 #18 Standard DC

Undecorated
920-41058 Tsunami Sound & DCC
920-48058 Standard DC

[Click to Visit Walthers.com for Additional Information](#)

WALTHERS

For up-to-date product information, sign up for Walthers E-Newsletters at walthers.com/signup, or visit your local hobby shop. To find a shop near you call 1-800-487-2467 or visit walthers.com.

Prices and availability as shown were accurate at press time, for updates visit walthers.com. Preproduction models shown, details and colors may vary.
*Union Pacific licensed product. ©2013 Wm. K. Walthers, Inc.



HO

DCC

All Scales

Click to see specials in these categories

Click Here For More Info

July Sale
(while supplies last)

Click to see

- Digitrax
- SoundTraxx
- Kadee
- NCE
- And more!



HOT!

me going until the "V&O Story" in *Railroad Model Craftsman*, circa 1979.

Once I saw the power of prototype-freelancing, I sold the Morale Falls & Sadgino to a modeling buddy, and I started over on a new proto-free-lance layout: my Northern Railway, set in the late 1940s.

I envisioned the Northern Railway as running roughly on the route of the Great Northern, but I assumed the Great Northern and the Northern Pacific never existed. My only competition was the western extension of the Milwaukee Road.

I joined the Layout Design Special Interest Group of the NMRA (see ldsig.org) and started drawing up track plans for my dream Northern Railway layout.

As I developed track plan ideas, I kept advancing the era, eventually landing on the 1960s. I reasoned I could borrow some elements of

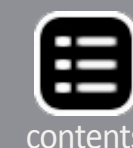

the Great Northern and use a modified version of the Northern Pacific paint scheme for my diesels.

The LD SIG Journal had an article about getting the most satisfying layout design. The secret, according to the author, is to return to what got you into the hobby. It's here where there's a passion for trains that will sustain you and will truly scratch the model railroading itch to satisfaction.

But I'm sometimes slow to get it. After reading this, I went back to my Northern Railway track plans. I was modeling western Washington, running out of Tacoma and up over the Cascades.

One afternoon, while contemplating options for my Tacoma area design, I got an idea. What if I changed history a bit and ran the Southern Pacific north out of Portland, Oregon, and interchanged with the SP on my Northern Railway layout?

The excitement of seeing the gray and scarlet SP on my layout totally captivated me! Having the SP on my Northern Railway excited me more than any other element on my layout.

Okay, hold the phone. Why not just model the SP? The SP Siskiyou Line held strong, fond railfanning memories.

What a forehead-slapping moment! The SP Siskiyou Line is what got me interested in trains way back in the beginning. Hel-LO!

So I began modeling the SP Siskiyou Line and haven't looked back. The LD SIG was right: by modeling what got me into trains, I've never lost my passion for the hobby or my layout. If anything, I'm more satisfied with my modeling subject now than ever.

So what got you interested in trains?

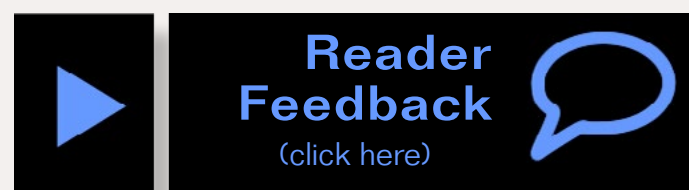

MRH's second annual

Start the hobby for \$500 contest



- You have a \$500 total budget.
- Assume basic tools: hammer, saw, drill, screwdriver, scissors, single-edged razor blades, soldering iron.
- Assume advanced tools like a table saw, router, or lathe are NOT available.
- Must design an operating layout or module (continuous running optional).
- Include a shopping list not exceeding \$500 - must cover benchwork, roadbed, track, wiring, control system, rolling stock, locos, structures, and scenery.
- Common items listed for sale on the web like eBay or Yahoo train yard sale okay.
- Thinking outside the box encouraged.

DEADLINE: November 30, 2013

Winners get get paid for their article when published plus they get a special bonus!

Submit entry
(select Contest)

Enjoy Great Operation ...



\$455.00 MSRP

Super Chief Xtra



LocoNet

Is The Digitrax Difference

- Run Trains
- Sound
- Feedback
- DC Control
- Computer Control
- Lighting
- Turnouts
- Signaling
- Transponding
- Block Detection

...With **Digitrax**



\$225.00 MSRP
Zephyr Xtra

Free Digitrax Toolbox App!
Easy to use tools to enhance your Digitrax experience!

For iPhone/iPad and Android

Download now @
www.digitrax.com!

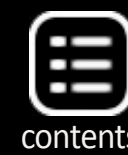

Notes from the MRH STAFF

Monthly not enough?
Our website is the
answer, No DCC
column this month ...

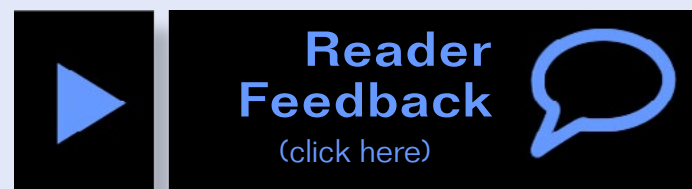

Monthly not enough?

We get emails every so often from modelers asking us if we might consider producing a weekly model railroading magazine, or going to a release model that is just-in-time article-based rather than monthly issue-based.

Let's look at each of these ideas.

First, there's the just-in-time article publishing suggestion. The idea is to publish articles as they're ready, rather than wait to assemble them into a monthly collection of somewhat unrelated articles like we do now with the magazine.

The modelers who suggest this like the idea of getting only the articles they're interested in, and getting them right away instead of having to wait for a monthly issue to be released. These modelers also like the idea of not needing to allocate storage space for articles that don't interest them.

While on the surface this might sound appealing, it's just not practical for our ad-funded-free-to-read publishing model.

June 2012 MRH Ratings



The five top-rated articles in the [June 2013](#) issue of MRH are:

- 4.8 Rob Carey's D&RGW Tennessee Pass
 - 4.7 DCC Impulses - 17 DCC tips
 - 4.5 What's neat - Joe Steimann's freight cars
 - 4.5 Assistant Editor musings - The compound effect
 - 4.3 Yes, it's a model
- Issue overall: 4.5

Tell us you want more (or less) by rating the articles!

Click the reader feedback button on each article's feedback page and select the star rating you think the article deserves.

Advertisement

LAST CHANCE

DOZENS OF DISCONTINUED ITEMS



Click



When talking
to hobby
vendors,
please
remember to
mention MRH.

The reason the magazine is free is because it's a large enough package we can include a good number of ads and there's still plenty of content. Having articles that don't interest you in a monthly publication that also includes ads is the price of free.

Then there's the question of publishing a weekly model railroading magazine.

While we could potentially split an issue up into 2-3 articles per week with ads, there's still a certain amount of fixed overhead to rolling out an issue regardless of its size. This fixed issue rollout overhead takes a couple of days to complete, and so that would be multiplied by 4 (or 5 on some months).

If you do the math, that's 8-10 working days per month now just devoted to rolling out issues taken away from our 20-some days of production time. In short, that cuts our issue production time almost in half, which is not good.

Then there's how to split up ads across weekly issues. All-in-all, monthly is a great balance between frequency and production effort for us, and the hobby vendors are used to a monthly ad routine with all the general model railroading magazines. If we're the one odd-man-out publication with a non-standard release cycle, hobby vendors could very well find we'd be more of a pain for them as a weekly.

To sum it all up, monthly works very well for our production process, and all the hobby vendors follow a monthly process in ad placement, so monthly it is!

The MRH website is your answer

If you need a model railroading information fix more frequently than monthly, then the MRH website is your answer.

When we get those questions about publishing more frequently, not only do we explain that we've considered it but it's not practical, we also point out to these folks they need to go frequent the MRH website. There is something new to read almost every day.

We're not kidding when we say you should go check out the MRH website. Some of the content on our website is every bit as good as the articles in the magazine.

So if you're needing a model railroading article fix because a monthly MRH isn't frequent enough for you, go to mrhmag.com and start reading through the forums and blogs.

To get you started, here's some of the blog (personal journal) threads on the MRH website:

Freight Car Standards - Jim Six: mrhmag.com/node/14270

Advertisement

Free Shipping on all US WEB orders over \$125.

Watch for our monthly specials!

ACCU-LITES, inc
Your DCC Center!

New from ACCU-LITES!
Make LocoNet wiring extremely simple!

... great time saver as well as providing flexibility to change things ... - Terry Nathan

PM42 breakout board

BDL168 Multi-zone breakout board

SE8C breakout board

BDL168 Single-zone breakout board

<http://www.acculites.com>

CLICK TO LEARN MORE ...



Iowa Interstate's West End: mrhmag.com/node/9031
From stagnant to steaming: mrhmag.com/node/14196
Two On30 Critter Builds: mrhmag.com/node/14059
Pittsburgh & West Virginia in N: mrhmag.com/node/14069
Modular Switching Layout: mrhmag.com/node/13639
Gogebic Iron Range 2: mrhmag.com/node/12321
Dakota & Manitoba Railway: mrhmag.com/node/9761
Rutland Yard structures: mrhmag.com/node/11321
Chronicles of a broke model railroader: mrhmag.com/node/14267
Richlawn RR V2 - benchwork height: mrhmag.com/node/14274
How high the benchwork: mrhmag.com/node/14094
SW7 cow and calf project: mrhmag.com/node/12665
L&T building construction: mrhmag.com/node/8250
LK&O Trackwork: mrhmag.com/node/14238
Make a working scale track: mrhmag.com/node/14226
Newport Steel on the K&LE: mrhmag.com/node/14244
Standoff details for graphic buildings: mrhmag.com/node/14199
Building my shelf layout: mrhmag.com/node/5355
Industry Ave modular switching layout: mrhmag.com/node/13976
Smartphone throttles could be more: mrhmag.com/node/5315
Painting backdrops for large layouts: mrhmag.com/node/13989
Tom Johnson's L&IN: mrhmag.com/node/8934
Floquil paint to military color chart: mrhmag.com/node/14152
German HO adventure: mrhmag.com/node/10793
Small switching layout trackwork tips: mrhmag.com/node/11614

Converting an Atlas S2 to DCC w/sound: mrhmag.com/node/1493
Drainage ... adding a culvert: mrhmag.com/node/9944
N scale Ontario Midland: mrhmag.com/node/13955
Proper Magnification: mrhmag.com/node/9522
Finishing up: mrhmag.com/node/12247
Latest Rolling Stock to Hit WN Rails: mrhmag.com/node/6083
Saguaro Cacti: mrhmag.com/node/13743
HO collection: mrhmag.com/node/11983
Tips and Hints for Model Railroad Ops: mrhmag.com/node/11187

This list is just some of the more substantial blogs on our website. There's actually a lot more blogs than this on our site, and for many of these blog threads we list, the bloggers have a lot of other threads as well on their blogs that are similarly great content.

July 2013

Subscriber-only bonus extras!

Available to subscribers!

DVD and HD quality versions of the videos in this issue, plus:

- **XtrackCAD and SketchUp files for the \$500 layout plan third-place winner**

Click here to access

And we haven't even touched the forums yet. Let's do that next.

So what about the MRH forums?

While blogs are more personal journals, forum threads tend to be more questions and topical discussions that focus less on what one modeler is doing.

One of the best examples of the MRH forum threads is the weekly "Weekend Photo Fun" threads. The best way to search through these threads is to type this into our website's search box (include the double quotes): **"photo fun"**

The most recent Photo Fun thread as of this writing can be found here:

Weekend Photo Fun 6-21 to 6-23: mrhmag.com/node/14338

Another useful thread started by Bill Brillinger is called the "Trackplan database". You can find it here:

MRH member trackplan database: mrhmag.com/node/13844

There's also many other interesting forum posts, like these:

Building complex crossings: mrhmag.com/node/14343

Grow your own supertrees: mrhmag.com/node/14251

Newbie Steam Loco question: mrhmag.com/node/14335

Loco Maintenance - get these rollers: mrhmag.com/node/14325

Flat car load ideas: mrhmag.com/node/14302

No DCC column this month

You might notice we have no DCC column this month. That's because Bruce asked for a vacation and after 25-some straight monthly columns, we felt he certainly deserved a month off!

[... On to next page of text →](#)

Bowser

EXECUTIVE LINE

HO Baldwin DS 4-4-1000 Switcher Locomotive



Click here to check out the detail on these and other production paint samples on our website



[← back to previous page of text ...](#)

Bruce Petrarca will be back next month, bright-eyed and bushy-tailed, raring to show you more DCC cleverness.

In this issue ...

This month's cover story features part one of James Eager's *City of Miami* car-for-car name passenger train build. The City of Miami was an Illinois Central crack passenger train from the 1940s, and James shows you how to model it from his carefully researched data. James' modeling techniques can be applied to any such passenger train project, so don't skip the article just because you don't think you would model this specific train. Don't miss all the good tips!

Animation master Geoff Bunza is back with another layout animation project, this time making a model railfan photographer to put into a layout scene. And follow along as Mike Tylick shows you his tricks for modeling tar paper and similar such structure roofs.

We present the third place winner of our \$500 layout design contest this month: Ben Kaur. Ben's design shows what's possible using free design software, and we like how Ben used the free 3D design package SketchUp to explore fitting the benchwork into the room. Finally, Assistant Editor Don Hanley finishes off his building the 1950's Erie boxcars series by showing us how he painted and decal'd his resin cars.

Regular Columnist Charlie Comstock continues the saga of building the new central peninsula housing his layout's major yard, and in the process he's sharing the trials and tribulations of making sure

[... On to next page of text →](#)



SO REAL...You'll Think You're There!
LokSound Select · 3 SIZES, ENDLESS POSSIBILITIES!

- INDUSTRY LEADING MOTOR CONTROL**
- Multiple Bell types
 - Multiple Brake squeals
 - 4 or 6 Output functions depending on the style
 - Up to 4 Prime Movers or Steam Sounds on EACH decoder
 - 16 Very Playable, LOUD Horns or Whistles depending on Profile
 - All Changeable by using ONE CV! No Programmers or Boosters needed!*
- 4 OR 8 Ohm SPEAKERS!**

**Small Size
BIG POWER! 1.1Amp!
LokSound Select
"4 AUX"**

\$99.99

NEW 2011

Only Available From ESU LLC (USA)

**ONE SIZE FITS ALL!
LokSound Select "DIRECT"**

\$109.99

**6 Outputs!
LED Resistance
Built In!**

LOKSOUND SELECT

NEW 2011

Only Available From ESU LLC (USA)

**Tiny Size,
HUGE Versatility!
LokSound Select
"MICRO"**

\$99.99

NEW 2011

Only Available From ESU LLC (USA)

www.LokSound.com *Now on facebook!*



477 Knopp Drive - Muncy, PA - 570-649-5048

[← back to previous page of text ...](#)

things are accessible. Jeff Shultz takes a look at Athearn's new HO 57' WFE reefer with sound in this issue's First Look.

In *Getting Real*, Jack Burgess examines how to make Timetable and Train Order operation something that visiting operators can get into more easily. TT&TO is hard-core stuff, so you should find Jack's suggestions on how to make things easier on visitors to be some welcome insight. Ken Patterson's *What's Neat this Week* shares Dave Davis' approach to making loads for open top cars that look simply amazing – Ken's photos show off Dave's work superbly. But would we expect anything less from Ken?

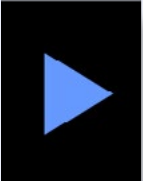
Have a great read! ■

 **Reader Feedback**
(click here) 

Advertisement

STAINED?
Not exactly what we had in mind!
Stained lasercut wood grade crossings available now!

HO/N NOW AVAILABLE STAINED!

WHAT'S NEW?  Our 20th year!
Blair Line

 Email  Phone

Advertisement

 A well juiced frog is a happy frog

Click here to keep your trains rolling with our Frog Juicers...

TamValleyDepot.com

 Email

Advertisement

 **1st choice for model railway supplies and service.**
Expedited mail service available across North America.

Click to visit:
WWW.CVR.CO.COM
1 800 464 1730

Advertisement

 **TIME FOR A REFILL!**
TOP QUALITY PRODUCTS FOR THE MODEL RAILROAD CRAFTSMAN

Railcar Unloading Tower

 Detailed Craftsman Structure Kit
HO Scale WWW.GLXSCALEMODELS.COM

2 for \$39
(plus shipping & handling)

Click here to buy now

 Email

 Phone

 Email

 contents

 index

NCE



The Power of DCC

Overstated? Not at All - DCC at its *Finest*



585.265.0230
9am-4pm EST.
www.ncedcc.com

**The Number ONE
Rated DCC System**

Call or Email
for FREE Brochure
support@ncecorporation.com



Our products are proudly made in the U.S.A.



MRH

Questions, Answers and Tips

Reader
Feedback
(click here)



QUESTIONS AND ANSWERS

Cleaning the layout

Q. It seems that keeping a layout clean means more than just keeping the clutter off the scenery. I have a lot of dust bunnies building up. Spiders find my corners and make webs everywhere. Prolific ladybugs cause derailments by being "run over" by a train. What do you do for general cleaning, and is there a way to prevent the critters from returning?

– Nelson Beaudry

A. We get the coolest questions (and answers) here at MRH Global Headquarters. A couple of the answers to this one include health warnings and precautions people need to follow.

Here are some approaches:

- Electrostatic air cleaners
- Ozone generators

- Hedgeballs
- Chemical pest control
- Sweeping compound
- Latex concrete sealer
- Peppermint
- Box fan and filters

There are two issues. One is dust in the moving air around the layout, and the other is arachnids/insects. Pollen, house dust and lint can be controlled with an air cleaner, either attached to the heating/cooling system or a stand-alone plug-in model. You can also remove carpeting, or vacuum frequently. Your choice.

Tiny wildlife

If you can't tolerate creepy-crawlies, discourage them by sprinkling baking soda and Ant Killer diatomaceous earth around the perimeter of the entire basement or train room, or seal the area and set off Raid fumigator bombs twice a year. The bombs should be done twice within a month to get the hatchlings.

– Crandell

Reader **tommyl** suggests his mom's remedy: Diluting a few drops of peppermint oil with water, and misting it into the basement window areas and lightly around the room will keep spiders away for about 6 months. He admits the train room did smell like candy canes for a day or so.

There is an old-time insect deterrent of hedgeballs (1). Says **Steve in Iowa City**, "I've not tried them myself, but my wife and many others in the family swear by them. She warns me to pass on that they should be kept away from small kids. Maybe hot-glue some up under the layout or maybe even build a barn around one? They are about the same as a pear, or a kiwi, and are a cool-looking retro green color. I've found them in baskets for sale at lawn and garden stores."



(“Hedgeballs” come from *Maclura pomifera*, which you may know better as Osage orange, hedge apple, horse apple, or bois d'arc, bodark, or bodock. It's a small tree or large shrub. The fruit is round and bumpy and filled with sticky white goo. It isn't poisonous to people, but it's pretty unpleasant and a bite

can make you barf. In fall, the fruit turns bright yellow-green. Scientific studies have found that extracts of Osage orange do repel several insect species.)

Dust control

Unsealed concrete will generate an unlimited amount of dust. Unsealed drywall sheds copious volumes of irritating abrasive dust. A layout with a sealed floor and walls will have a fraction of the dust accumulation of a space with open walls and ceiling. Concrete sealer will definitely hold down dust, and make sweeping more effective. Keeping pets out reduces fur and dander pollution.

Bill Brillinger suggests sweeping compound – basically oily sawdust – to keep dust from becoming airborne when sweeping floors. It's available from janitorial supply stores and some big

1: Osage orange balls are an effective indoor insect repellent, tested by time and by scientific studies. They are not edible and should be kept away from kids and pets.

[... On to next page of text →](#)

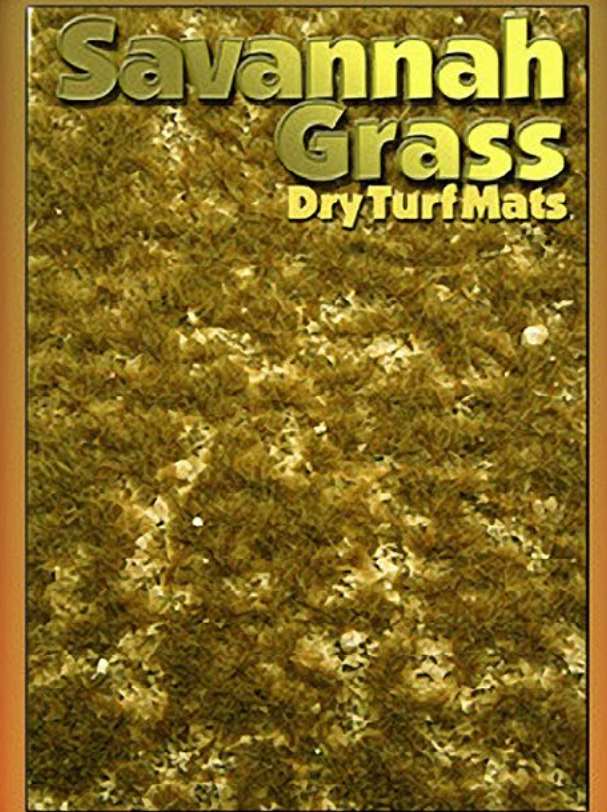

Click for more - lots more!

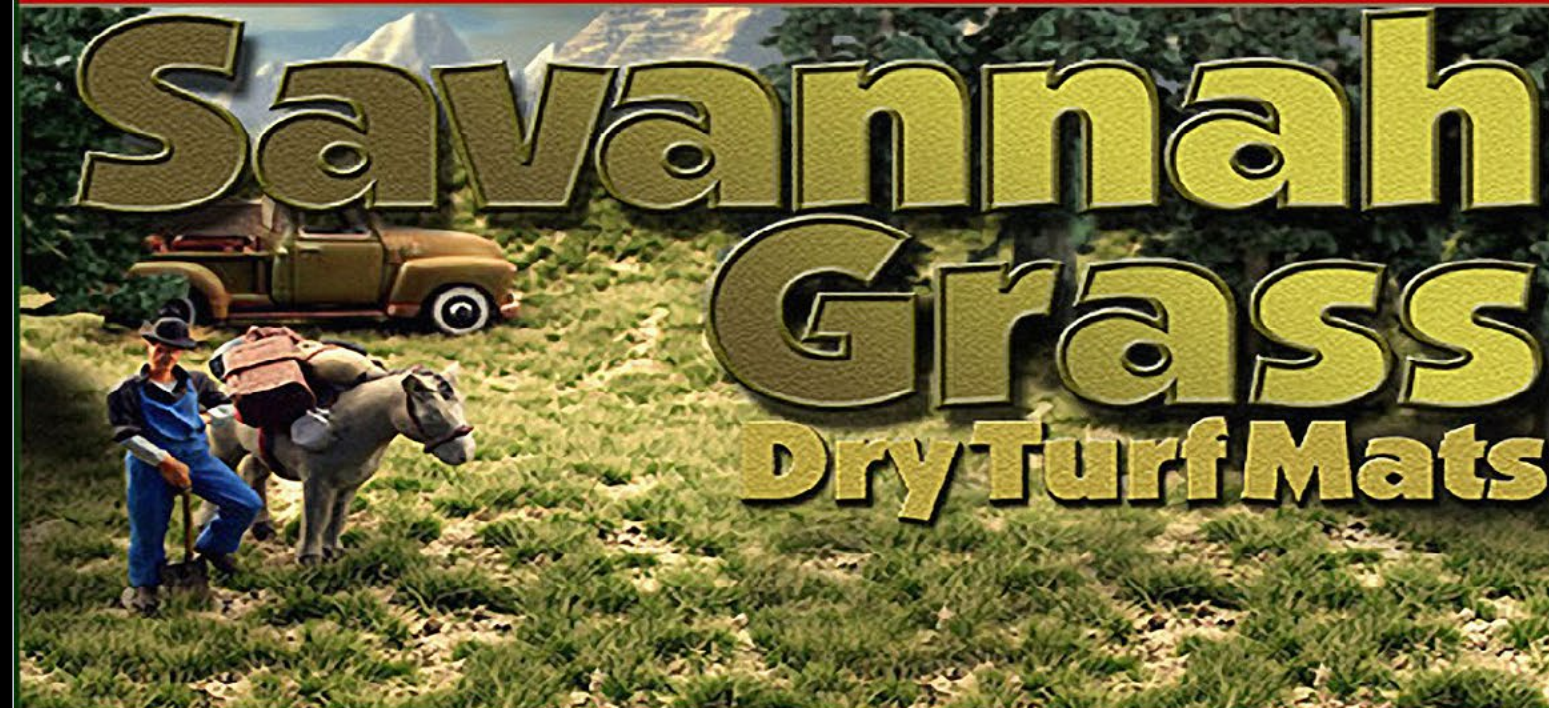

[← back to previous page of text ...](#)

box home stores.

“A long distance friend of mine is very seriously into building military models, so much that he has a small room in his house dedicated to display. He uses electrostatic air cleaners running 24/7 and says it works well.”

– Alan

Charlie Comstock installed central vacuum system outlets in his train room so that dust sucked up does not get recirculated in the room. He's banned power saws of all kinds from the layout room.

Micro-Mark, Harbor Freight and other tool stores sell tiny attachments for shop vacuums, to clean the top of the layout. You can adjust airflow strength, and brush attachments help dislodge dust without disturbing the scenery too much, said **Kevin**.

Ozone

Ozone is a very powerful sanitizer and deodorizer that can kill any living thing, including insects. Kevin bought a powerful ozone machine to de-stink his basement of mildew smell before building his train room, and it eliminated all the mildew and bugs. The machines come with detailed instructions that must be followed for safe use.

“Using such a machine has some hazards, but it is no problem at all if you follow basic rules. Basically, remove any living thing you don't want to be dead, seal off the area, and run the ozone generator for several hours at full blast,” Kevin said. “Stay out of the area for at least four hours after it shuts off, then you're good to go back in. My (annual) cleaning schedule is to close off the basement for 24 hours, run the machine for 12, and let the ozone begin decomposing for another 12. When done, I have no mold, no mildew, no bugs, and no dust mites.”

[... On to next page of text →](#)

Litchfield
STATION



Visit Our Website

**Proudly offering DCC
products and service
worth the
ohhh and
ahhh!**



www.Mr-DCC.com
623-298-7355



[← back to previous page of text ...](#)

“I've been using it for quite a while now. I was concerned about whether or not there were undesirable side effects. So far have seen none. No discoloration of anything, no deterioration of plastic items, no corrosion on any metal surfaces. I was particularly interested in copper, as that affects all the electrical stuff in a room, but there was no visible change in anything. No fading. No cracking. Nothing.”

Excessive use of an ozone generator can break down the plastic in flex-track tie strips. For more on ozone generator safety, look at inspectapedia.com/sickhouse/OzoneAirCleaners.htm.

For more about air cleaners, epa.gov/iaq/pubs/airclean.html.

A simple dust solution, from **Sean M.**, is to take a normal box fan and duct-tape appropriately sized furnace filters on both sides. Hang the fan from the ceiling, and run it on low all the time to minimize the dust. “You can't really even feel the air moving, but there is enough circulation to catch a lot of crud,” he said.

Read the ongoing discussion at model-railroad-hobbyist.com/node/13851.

Narrow-gauge container flat

Q. I'm going to be building an intermodal car for 28' containers—for an HOn30 train. I know that that's pushing the envelope, but they did run some cars 8 feet wide back in the day. Can anyone toss some thoughts as to how it might look? The container must be as close to the track as practical for routine running. Any ideas, sketches, and thoughts would be appreciated.

2a-2c: A Central American narrow-gauge container flat car inspired Art in CA's freelanced creation.

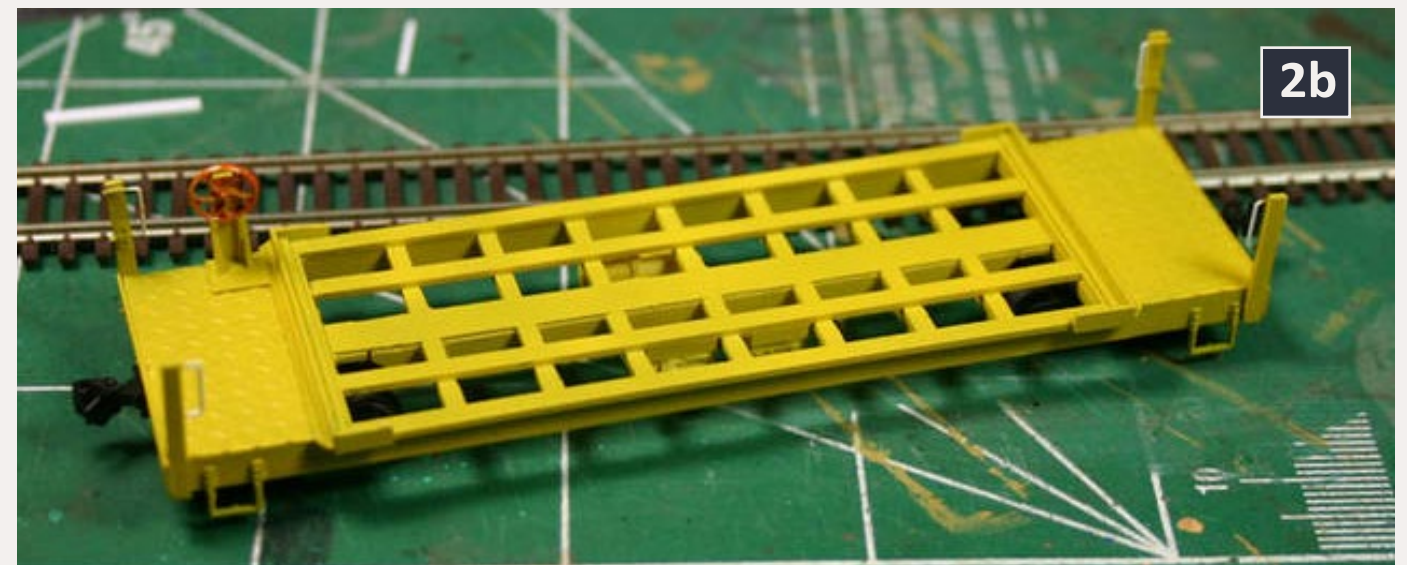

A. Ken Rickman suggested a short well car to get the center of gravity as low as possible would be. "A thing to think about is axle loading . . . If the weight of a car and loaded container is about the limit of what two trucks can carry, then build single unit cars. If a single truck can handle the weight, you could either consider two axle cars or multiple unit cars."

Some photos of narrow gauge container flats are at drgw.free.fr/WP&YR/History/Fifties/WPYR-01-238_en.htm.

– Bremner & Dave B.

Art in CA hit the bullseye with his project: "Here are some shots of one I built (2) based on the cars they ran on the IRCA (International Railways of Central America) from photos I've seen. Built on a whim after seeing the pictures. I did decide that it would look better as an HOn3 model instead, 'cause the HOn30 model is a little tippy. Might work better as a drop center car."

More words and pictures at model-railroad-hobbyist.com/node/14066.

– MRH

Glue plastic to wood

Q. I'm looking to glue Plastruct brick sheet to wood strip. What glue would you use and what works best? Was thinking of using hot glue to place the brick sheet onto the wood and an ink roller to press the wood and plastic strip into place.

– E.G. Hall

A. MEK will soften plastic enough to press the wood into it if the wood is porous and the joint does not need to be super strong, said Ken Rickman. He said, "The advantage is that there's no glue residue, as with most other adhesives. If that doesn't work, I usually try superglue."

Terry Roberts suggests roughing-up the back of the plastic and using wood glue to "grab" the scratches in the plastic. Epoxy will also work.

Peter Herron's suggestion is Aleene's Tacky Glue. "It's the best darn stuff for gluing different materials together," he said. "If you're in a hurry, there's a 'Turbo' version and if you need clear, there's that too. If you need to glue brass or aluminum (like roofing) it works best if you score up the metal first."

– MRH

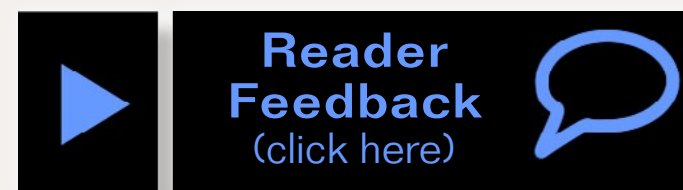

GET \$25 PER TIP

We pay \$25 USD for each tip we publish.

[Send your modeling tips to Model Railroad Hobbyist](#) and we'll get payment to you upon acceptance.

Just think, for only a few minutes effort, you could fund your next piece of rolling stock – or even pay for an entire train if you send in several tips and we publish them!

If you include any photos with your tip, we pay a bonus of \$10 per photo we use with the tip. ■

New Innovation



Nano Technology Lubricants

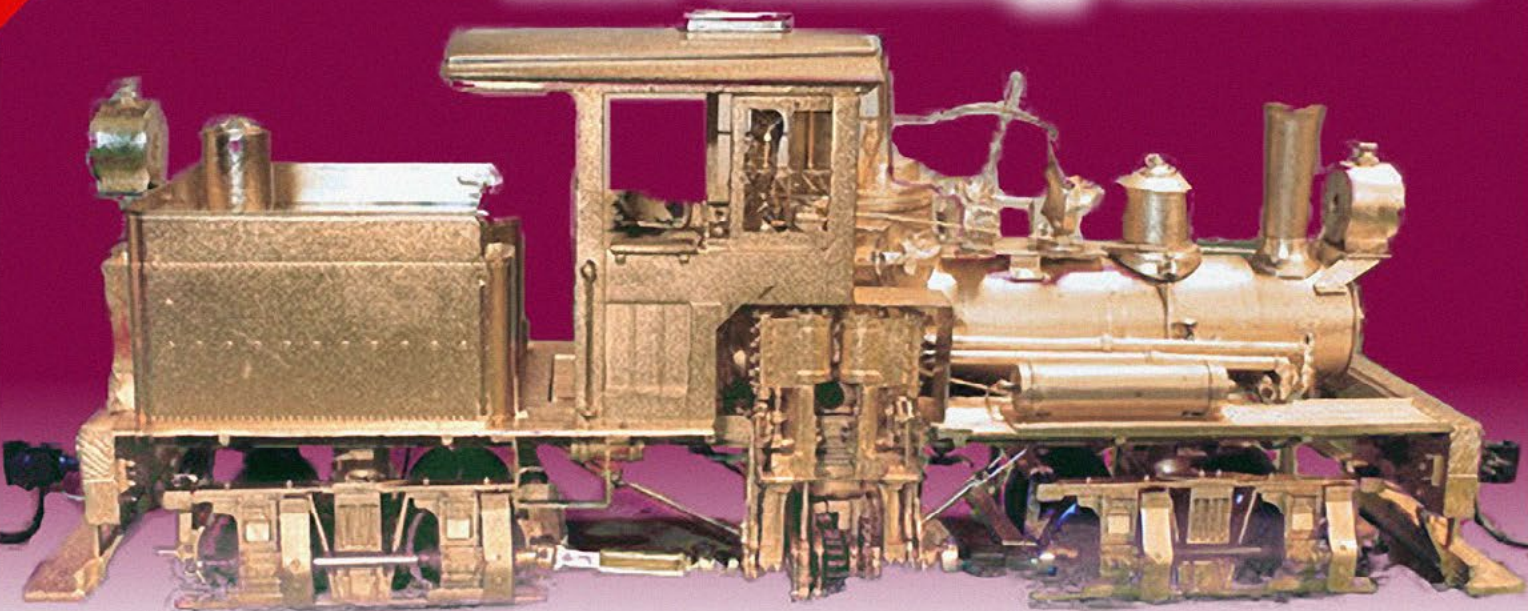

Nano-Grease

"I was skeptical, but my experiments show significant improvement with Nano Oil ... why not lube it with the best?"

- Bruce Petrarca, MRH DCC columnist

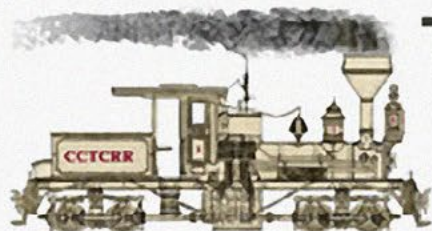

THE SHAY FIXER

VISIT US AT...

SHAYFIXER.COM



Specializing in brass Pacific Fast Mail / United geared locomotives

For more details click here ...



Upper deck roadbed reveals access issues in staging !

A regular report on the construction of a 1950s-something layout

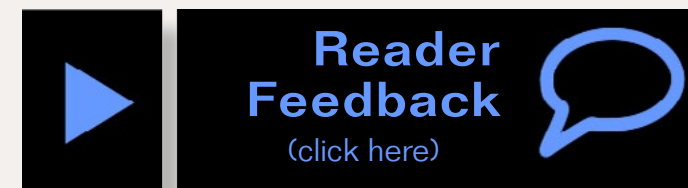

Up the Creek column by Charlie Comstock

The upper deck gets started, and more ...

I'm somewhat impatient. I've long wondered how the installation of the upper deck and the center backdrop along the peninsula would change the look and feel of the Bear Creek and South Jackson. One change is obvious – I'll no longer be able to see the entire layout from one location.

1: Some upper deck roadbed held in place by a few joists with some mocked-up backdrops in place.

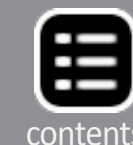



2: What idiot thought putting a turnout here for the B-side main staging area was good idea?

My organized self said cutting upper deck roadbed and building joists would be a waste of time and I'd be better off finishing the turnouts for the B-side main staging area or installing occupancy detectors in the helix. My curious side said I'd need to cut those pieces anyway, so let's see what it's really going to look like.

My curious side won. I also wondered whether putting Bear Creek yard at a 53" elevation would work, and how high the backdrops should be. A trip to a local big box store netted four sheets of plywood and, with a bit of help from a friend or two, roadbed and joists started to materialize. I used cardboard sheets used to separate layers of toilet paper to mock up the backdrop (1).

Boy, am I glad that my curious side won! I knew when I developed the trackplan for the B-side yard that the exit ladder would have some turnouts a bit far from the aisle. But hey, with 17" of rail-head separation between Bear Creek above and staging below, I thought it would be OK. Wrong! Once visible in its configura-

tion (2) it became obvious that those turnouts needed to be closer to the aisle – a lot closer.

You can have too much staging!

Conventional wisdom says that it's not possible to have too much staging for a layout. This isn't true. When the quest for more and longer tracks results in inaccessible turnouts and tracks, you need to ask if the end justifies the means. I'd sold out turnout accessibility to increase the average length of my staging tracks by about 4'. Given that the shortest track in the redesigned staging area still has room for a 25-car train, the answer should be obvious.

Unfortunately it wasn't obvious to me until I saw the staging cavern under the upper deck with paper turnout templates in place. Some looked awfully hard to reach! I'm really glad I figured this out before spiking all those inaccessible turnouts in place! (3) (13)

3: The revised B-side staging area. Turnouts are now much more accessible. See also (13).



General upper deck appearance

Other reasons I had for starting on the upper deck were:

- Would the main yard at Bear Creek be workable 53" from the floor?
- How will the layout feel with the backdrops in place?
- How high should the backdrops be?
- I wanted to look at the Santiam River scene.

Track greed

Not quite two years ago, I'd become concerned that Bear Creek yard wouldn't have sufficient tracks for the classification yard I was planning. So I redesigned it, adding a few inches to the depth of the benchwork.

The yard was originally designed with a 30" depth, with the rear-most track about 27" from the aisle. Facing the actual Bear Creek benchwork and reaching across it showed increasing the depth to be more foolishness. A pro basketball center would be OK running the yard and reaching the back track, but darn few other folks would. I vowed to shrink the yard depth back to its original 30". The yard crews will just have to live within their (track) means.

The 30" depth, while reachable for those near 6' tall may require some kick-around stools for others who need to reach all the way to the rear. Luckily, the rearmost track is a thoroughfare which shouldn't require much direct attention. The most remote class track will be a liveable 24-1/2" from the aisle.

Layout feel with backdrops

Once the temporary backdrops were stapled in place (4) a bit of isolation set in. This was one of the layout design goals – that a crew should feel they were out in a remote location on



4: Albany Junction on the left is taking shape on the banks of the future Santiam River. The aisle here is 36" wide. The backdrop isolates this area from Bear Creek yard (behind it) and the area around the corner.

the high iron. Still, I'd had 9 years to get used to global visibility in the train room so it was a bit of a shock.

One other good thing – I'd been concerned that the aisles would seem much narrower once the upper deck roadbed was installed. After all, we tend to be widest at the shoulders. I was pleased to discover the aisle widths seem to be workable. This was borne out during the most recent op session where the upper deck didn't cause any aisle width problems.

At first I thought the backdrop was reducing light on the layout by preventing light from one row of fixtures reaching other areas – it felt darker. Now I don't think that's true. Once the final backdrops are installed and painted, I expect the light bouncing off them to equalize the layout lighting intensity.

How high?

I had the temporary cardboard backdrops up during the previous op session. I used several backdrop heights: 2', 3', and 4' with the 4' tall backdrop going all the way to the ceiling. I polled the crew – which did they like best? The result? No consensus whatsoever!

A full height backdrop has the advantage of complete isolation and should cut down on layout room noise. However, it will be the most expensive, the most difficult to install, and provides no opportunity for air circulation.

A 2' high backdrop is the most economical in terms of material cost and will probably be the easiest to install. It also is best for air circulation.

But even though a normal height person can't see another person over the top of it, the bright ceiling lights on the other side are quite distracting. (6)

A 3' high backdrop provides isolation nearly as good as a full height backdrop

5: A section of 3' high backdrop shows a bit of UFO-in-the-sky lighting over the top of the sky. In person I find my 67" from the floor eyeballs mostly see backdrop and not the light.



6



6: 3' (left), 4' (middle), and 2' (right) sections of backdrop behind the future home of Bear Creek yard. I (and Horace) like the isolation of the 4' section. I dislike being able to see the lights on the other aisle over the top of the 2' backdrop segments.

and cuts down on the lights visible above the top of the sky, while providing some air circulation. But it will use as much Masonite as a 4' backdrop (although scraps can be used to make fascia panels).

I asked Horace Fithers what he thought. He says I should go with full height backdrops for the best sense of isolation and noise reduction. I'll probably take his advice. An under the layout fan or two (or three) should provide decent air circulation.

Backdrop construction

I have some design goals for the peninsula backdrop:

- It should be as thin as possible to leave the most room for trains and structures. This rules out 2x4 stud walls.

- It should be as inexpensive as possible.
- It should permit smooth curves.
- It should be easy to install and easy to paint.

I'm hoping to laminate two pieces of 3/16" Masonite back-to-back with yellow glue to create a sort of 2-ply spline backdrop. Masonite is relatively inexpensive (compared with plywood), curves nicely, and takes paint well. Experience with the fascias on the second BC&SJ layout, which were two 1/8" Masonite layers laminated together, show that once the glue sets, it should hold its shape.

7: A cross section of the proposed BC&SJ laminated Masonite backdrop between Bear Creek yard and Junction City.

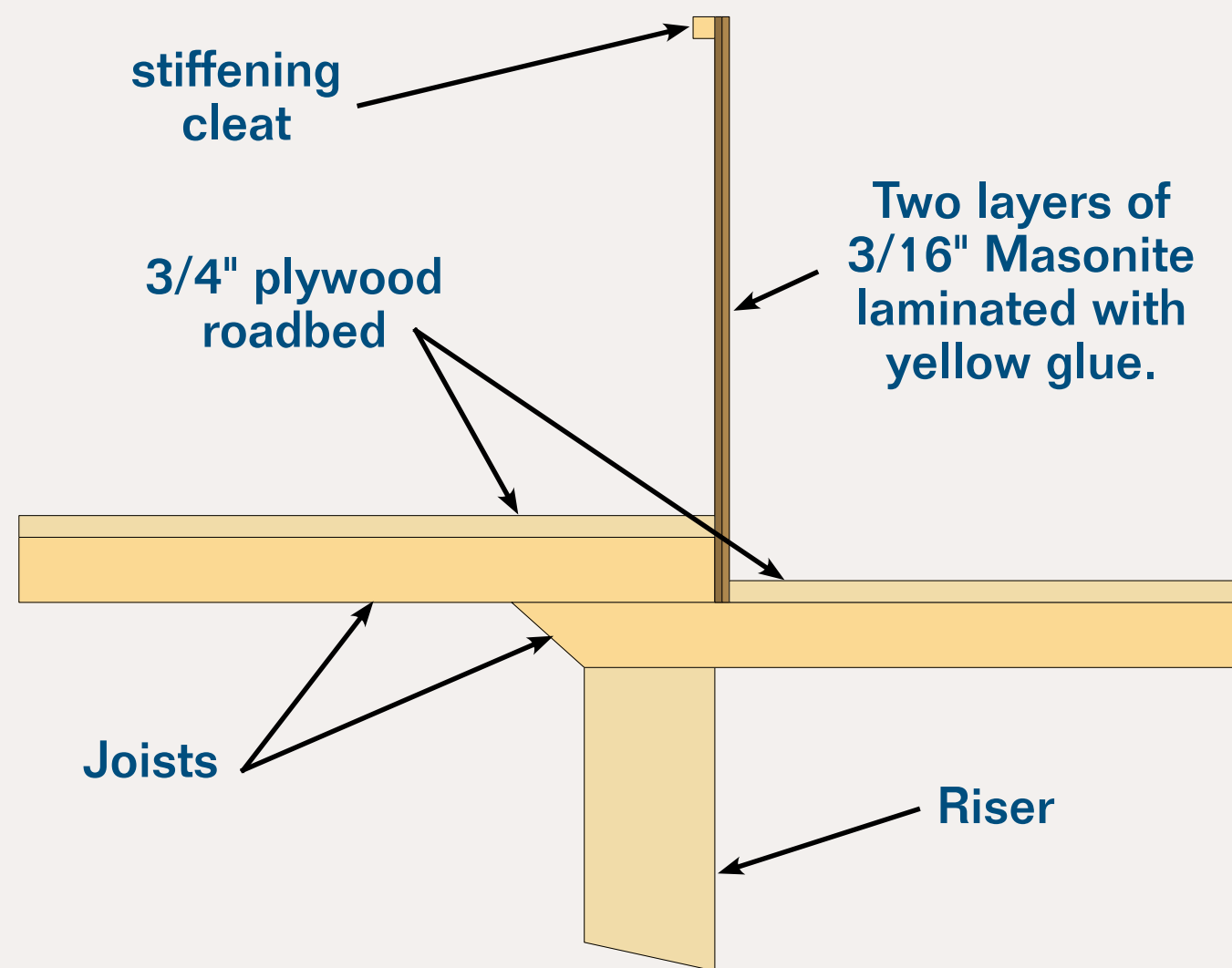

7

Concerns with this technique include avoiding waviness in the backdrop and how to laminate large areas of Masonite without getting yellow glue all over everything.

Will this technique work? I'll report back once I try it out.

Roughing in a river bed

I get a lot of use out of my copy of 3rd PlanIt. But there are some places where I have problems. The biggest problem is visualizing how the area I'm designing will look full-size. The program's 3D view capabilities help, but I usually don't want to take the time to build virtual scenery, and looking at a computer display isn't the same as seeing it for real.

I wanted a river to separate the mainline and Toledo branchline tracks between Junction City and Browning. In my mind I saw river banks sloping gently down to a moderately wide and lazy river.

8: A river separates the mainline (on the aisle side) and the Toledo branchline (on the backdrop side) at Albany junction.

This should yield some great photo opportunities, as will a covered bridge (12).

However, space for the river is tight, leading to lots of fiddling with the tracks to allow more room for scenery while keeping access to Albany Junction in reason.

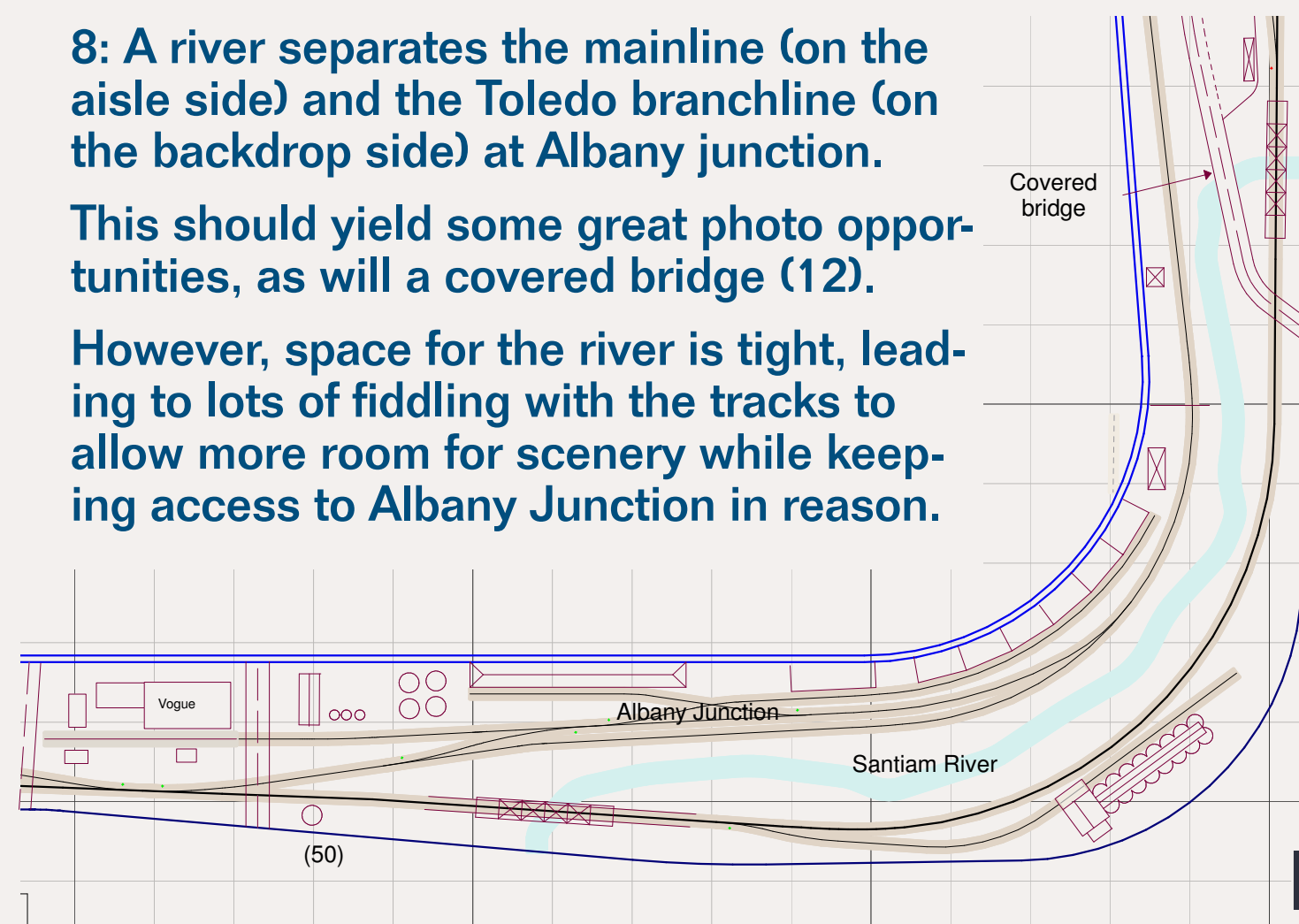

8

9



9: Space for the Santiam River valley is a bit lacking.

It looked good in the CAD drawings, but once plywood was in place I saw some conflicts. I wanted the river valley as wide as possible, but the sidings in Albany Junction needed to be accessible from the aisle. I wanted the river to be a couple of inches below the tracks to make visually striking bridge scenes, but I also wanted gently sloping river banks which significantly reduce the width available for water in the river.

10: Crabtree Creek isn't the Santiam River, but it's nearby and perhaps would make a good substitute.



10

11



11: The riverbed needs to be wider, but the benchwork for Albany Junction needs to be near the aisle. I'll try to work around this issue by modeling Crabtree Creek (10).

Making things worse, the tracks next to the river change nearly an inch in elevation. The nice CAD drawing of the river (8) didn't represent these things well (or at least I missed them). When I started cutting out roadbed for this area it quickly became apparent I had trade-offs to make.

A possible solution is to model a nearby creek instead of the river. Crabtree Creek (near the real Albany) isn't as wide, and

its banks look modelable in the space I have (10). As a bonus there are lots of covered highway bridges in the area (12). I'm hoping to model one of these (8) .

A minor mainline track realignment will let me bring the river (or creek) an inch closer to the aisle, allowing a wider river/ creek or moving the tracks in Albany Junction closer to the aisle for improved switching access.

What's next?

Cutting out some of the roadbed for Bear Creek yard and a few other places was a good break from trackwork. It also paid

12: One of several covered highway bridges near Albany, Oregon.



unexpected dividends by showing me places – before I had laid any track – where I just plain had screwed up the layout design (always a good thing). Now it's time to get back to getting more of the layout available for op sessions.

Reconstruction of the B-side staging throat has commenced. As I write this new roadbed is in place (13) and six of the nine turnouts needed have been built and are awaiting installation.

A clipping from the

South Jackson Gazette

The universe to expand again!

Leading scientists in the South Jackson area are predicting that the universe will expand soon. Dr. Thorty explained further over a beer or two in the South Jackson Tavern. "For a number of years now the universe has been, so to speak, stuck in a rut size-wise. But that will be changing soon and it will be gaining significant new mass."

When pressed for details, the math used by Dr. Thorty quickly put everyone within earshot to sleep.

Horace Fithers had a better explanation. "Well, ya know,

the moon and the sun look to be lining up with all them other planets over the next few months. So it jest kinda stands to reason that the enhanced gravitational alignmentism is gonna stretch things a bit!"

When reached at his office BC&SJ president Charlie Comstock said, "It's about time we had somewhere else to lay some new track!"

This reporter isn't sure what to believe, but more track sounds like a good thing. ✨

* Enjoy the Gazette? Read more at bcsjrr.com

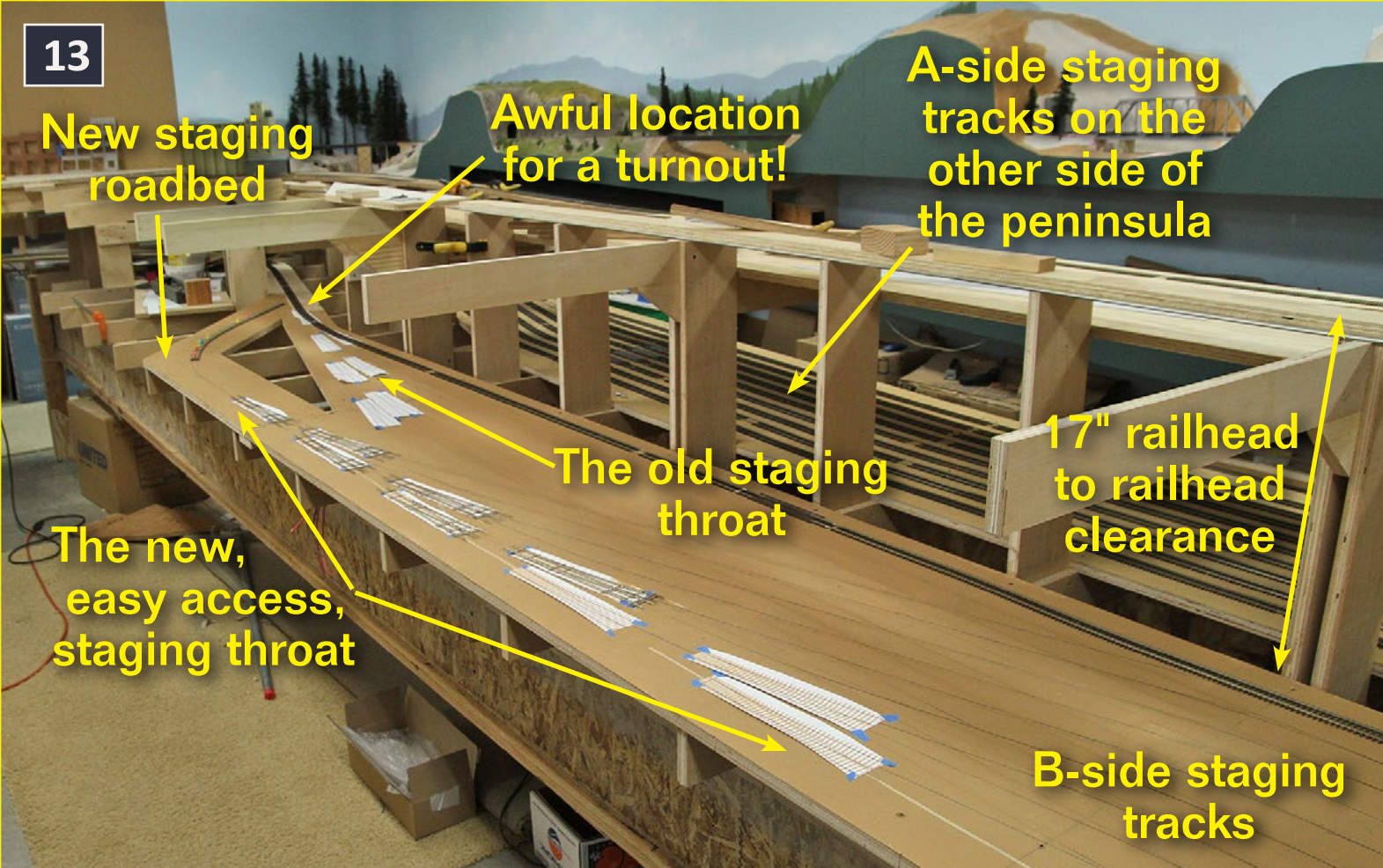

13: New staging level roadbed was needed to access the new, aisle-side turnout locations. The track in this area should be complete by the time you read this.

Once B-side main staging is operational, I'll need to quit procrastinating and install the progress/occupancy detectors in the helix and staging lead tracks. I'd rather do that before I bury the helix under more roadbed and the backdrop. After the detectors and electronics are in place it'll be time to extend the mainline about a mile down-grade from Oakhill to Bear Creek and get the yard in Bear Creek started.

From there track will go around the end of the peninsula to Junction City, passing the river area and Browning before heading down the helix to the main staging area.

Things are getting exciting! Is that smell the sweet aroma of a golden spike?

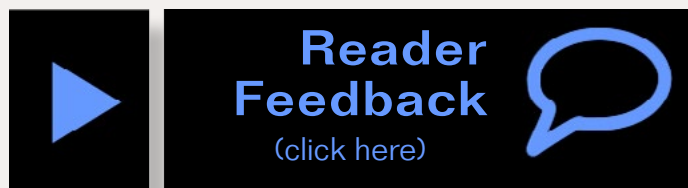

American Freedom 4-8-4 GS-4 Steam Engine
 80-3229-1 w/Proto-Sound 3.0 M.S.R.P. \$499.95
 80-3229-5 w/Proto-Sound 3E+ (3-Rail) M.S.R.P. \$529.95

**Now Shipping From
Your Local M.T.H.
Authorized Retailer**

Choose From:

- Sound-equipped versions with built-in DCC decoder
- Available In 2 and 3-Rail Versions

Featuring:

- 2 Cab Figures
- LED lighting
- Powerful 5-pole 12-volt DC motor
- Available In 8 Different Paint Schemes
- 28 DCC Functions
- Kadee® Couplers
- RP-25 Metal Wheels Mounted on Metal Axles
- Lighted Cab Interior
- Illuminated Number Boards
- Lighted Marker Lamps
- Locomotive Speed Control in Scale MPH Increments
- Operates On Code 70, 83 & 100 Rail Curves

See why M.T.H. HO Trains



www.mthHOtrains.com

©2013 M.T.H. Electric Trains

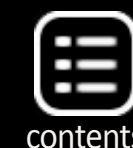

SERIOUS FUN



Containerterminal

GREAT PRODUCTS    

EXCEPTIONAL SERVICE 

Great products. Exceptional service. Serious fun.™

Find products from over 100 model railroad companies at HorizonHobbyTrains.com. All the brands you love—Athearn, Lionel, Bachmann and more—are right there. You'll also enjoy:

- Same-day shipping
- Our deal-filled Savings Station
- eGift certificates

Everything we sell is backed by the best customer service and support available. Our service center team is standing by to help you get the most from whatever you buy. At HorizonHobbyTrains.com, we take having fun very seriously.

Visit HorizonHobbyTrains.com. Exclusively Trains.



HORIZON
HOBBY TRAINS.COM

©2012 Horizon Hobby, Inc. All rights reserved. Athearn, Serious fun and the Horizon Hobby logo are trademarks or registered marks of Horizon Hobby, Inc. All other trademarks, service marks and logos are property of their respective owners. 36139

[Click to learn more ...](#)



Adapting Prototype Operations to Model Operations

A place to build realistic models

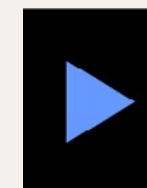

Reader Feedback
(click here)



Getting Real column

by Jack Burgess

Making it easier for visiting operators ...

When I designed my Yosemite Valley Railroad layout back in 1980, I was not that interested in operations, but I also assumed that sustaining my interest in a completed layout required that it also be fun to operate.

Given my lack of interest in operations at the time, I didn't envision a regular operating crew. Therefore, one of my design goals was to develop a track plan which easily accommodated visiting operators.

That meant a logical point-to-point design, and one with a relatively easy to follow track plan. Hence, all of the tracks are visible except for a one-turn helix and a hidden grade to climb from the first level to the second deck. There are no mysteries as to where a hidden track might come back into the open.

I also closely followed my prototype when it came to designing the yards and locations of passing sidings. By having the yards on the layout follow my prototype, I felt confident that I would not find the need to add more turnouts later, or otherwise



change the design of the yards once operations got underway years after construction had started.

Getting started with prototype operations

I started construction of my current layout in 1980 and wired it for “progressive cab control.” Rather than using traditional

control panels to assign blocks, progressive cab control uses track detectors to automatically assign blocks based on locomotive direction and turnout positions.

Occasional informal operating sessions were run on the layout under this control system but I was always limited to running no more than two trains at a time. The system could be expanded

to accommodate dozens of trains at a time but I never installed the additional circuit boards to do that.

With only two trains running at a time, operations were limited to each operator making up a train at one of the two terminal yards, and passing each other somewhere in the middle of their runs.

In 1997, I rewired the layout for DCC and installed

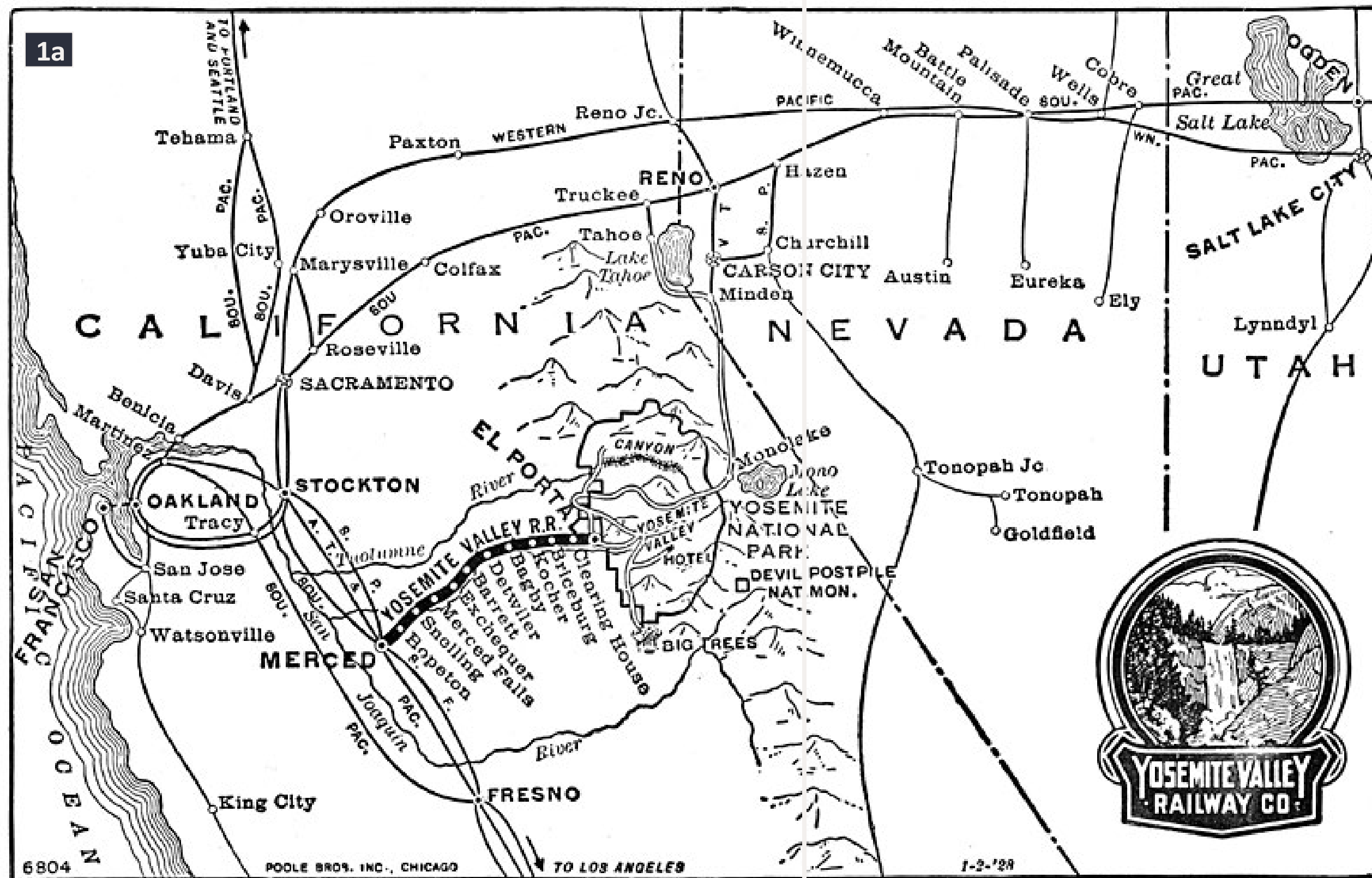

SoundTraxx decoders in all of my locomotives. Finally, 17 years after starting construction of the layout, things were finally in place to begin duplicating the prototype operations of the Yosemite Valley Railroad.

In order to model the trains that actually operated on your prototype, you first need to understand what trains were typically run in the period being modeled. The Yosemite Valley Railroad was operated under TT/TO (timetable and train orders) and the first place to look for that information is an employee timetable for the period. Timetables are not that difficult to find at railroadiana shows, on eBay, and so on.

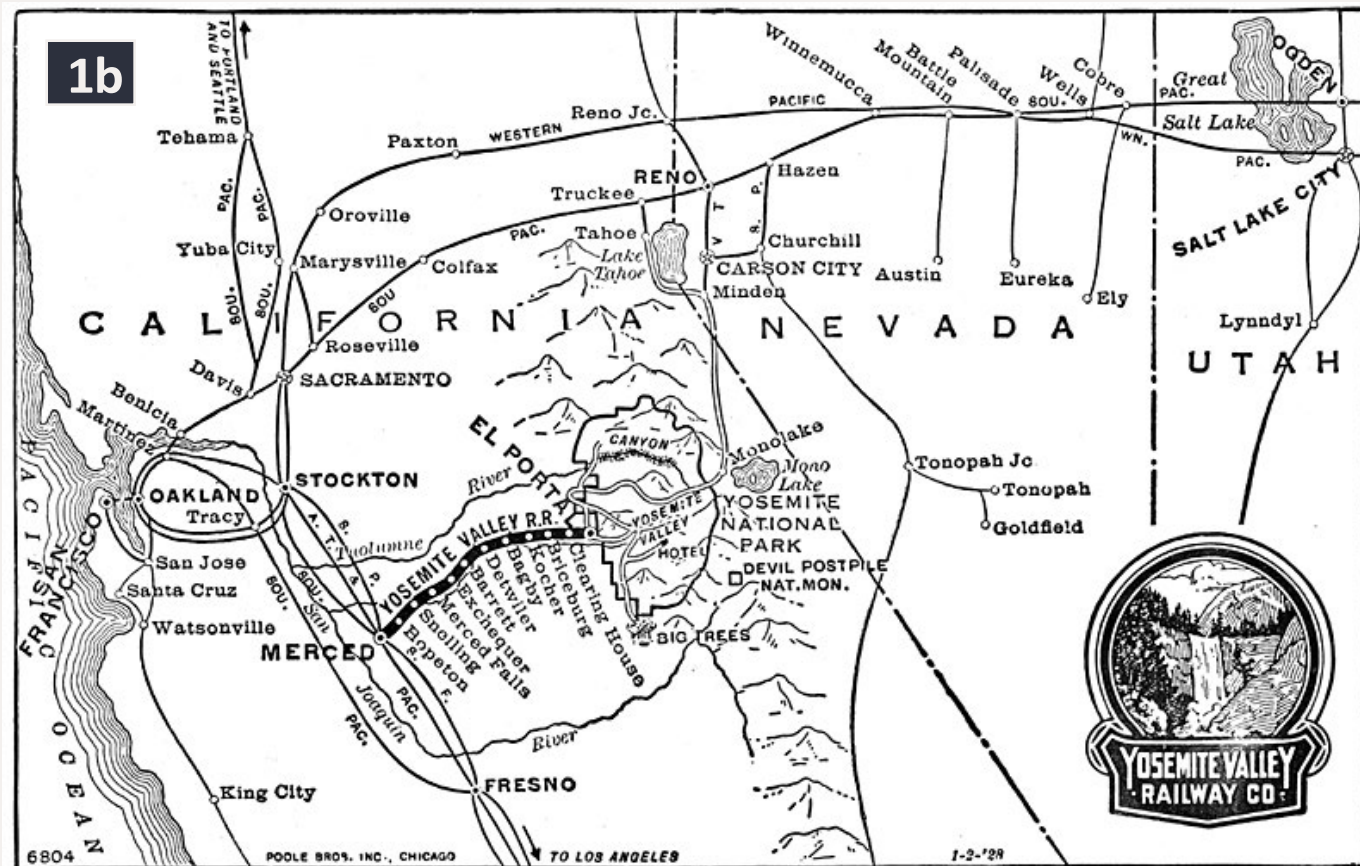

1a-1b: This map of the Yosemite Valley Railroad, from a public timetable, shows its connections with the Southern Pacific and AT&SF railroads in Merced and the major towns and places along the 78-mile route from Merced to El Portal, at the western boundary of Yosemite National Park. [... On to next page of text →](#)

Get Better Sound from your Locomotives

Can't get a good sound from your sound decoder?
Give our speakers a test drive with your ears.



RAILMASTER HOBBIES
9815 WALNUT ST #106
BELLFLOWER, CA 90706

Bass Reflex
Speakers



High Bass
Speakers



When it comes to speakers we have high quality speakers to fit many different applications. We are also a full line hobby shop. Need anything? We are an authorized dealer for Soundtraxx, Digitrax, Athearn, Walthers and many others. We provide quality speakers for your DCC sound systems and quality service.

**Click here for
the sound answer ...**



[← back to previous page of text ...](#)The YV timetable covering August 1939 listed two daily first class passenger trains and two daily (except Sundays) second class freight trains.

The eastbound (toward Yosemite National Park) No. 2 passenger train departed the Southern Pacific RR interchange in Merced each day at 5:30 a.m. after picking up any Pullmans destined for Yosemite National Park. It arrived at the end of the line, at the western boundary of Yosemite National Park, at 9:40 a.m. It then departed El Portal as the westbound No. 3 at 7 p.m., arriving back at the SP depot at 10:45 p.m. Figure 1 shows the general route of the prototype from Merced to El Portal.

The two timetabled freight trains were the No. 8 and No. 9, actually daily log trains which ran between Merced Falls at MP 24 (milepost) and Incline at MP 73. Merced Falls was the location of the Yosemite Sugar Pine Lumber Company sawmill, drying yards, and planing mill. Incline was the lower end of an 8,600-foot-long logging incline down which the YSPLCo lowered loaded log cars from the cutting areas back in the woods.

The crew of the No. 8 went on duty at 7 a.m., pulled out the empty log cars, ran around them and added a caboose before departing at 8 a.m. They arrived at Incline at 11:10 a.m., dropped the empties and grabbed their caboose, running light for the nearby wye at Moss Canyon. Upon turning, they became the No. 9 and returned to Incline to pick up the loaded log cars there. They departed at 12:10 p.m. and were back at Merced Falls at 3:50 p.m.

I share this level of detail for these two trains so that you can better understand them. What I realized, once I studied the prototype YV timetable, is that the passenger train passed Merced Falls at MP 24 even before the log train crew went on duty. That passenger train then laid over at El Portal and departed back

toward Merced 3 hours after the log train crew had tied up. So, neither train had any meets while out on the line.

Of course, an employee timetable only lists regular timetabled trains. A railroad could also run extra trains under train orders issued by the dispatcher. These extra trains (along with the timetabled trains) would be listed each day on the Dispatcher's Record of Movement of Trains, also known as a train sheet.

The late Al Rose, a well-known railfan in the 1930s-1980s, was able to collect nearly the entire set of train sheets from the YV when it was abandoned, along with a number of dispatcher train order books. After realizing how passionate I am about the YV, Al gave me photocopies of all of the train sheets for August 1939, along with the original train order book covering that month.

From these train sheets I learned that the YV ran a pair of extras every day, called the Merced Local and the El Portal Local. These freight trains departed their respective yards at around 4 p.m., usually meeting at Detwiler near the middle of the line. A typical train order for these two trains would read:

Eng 26 run extra Merced to El Portal meet Ext 29 west at Detwiler Eng 29 run extra El Portal to Merced.

After making up their trains, these two freights worked sidings along the line, making set-outs and pickups as specified in their switch lists. With a departure at 4 p.m. or so, the westbound extra needed to be clear of the westbound passenger train, which left El Portal at 7 p.m. and which would overtake it west of El Portal. The eastbound extra likewise needed to be clear of the same passenger train.

[... On to next page of text →](#)

iwata

by ANEST IWATA

Just Rolling By...

Make It **REAL** With Iwata
Climb Aboard!

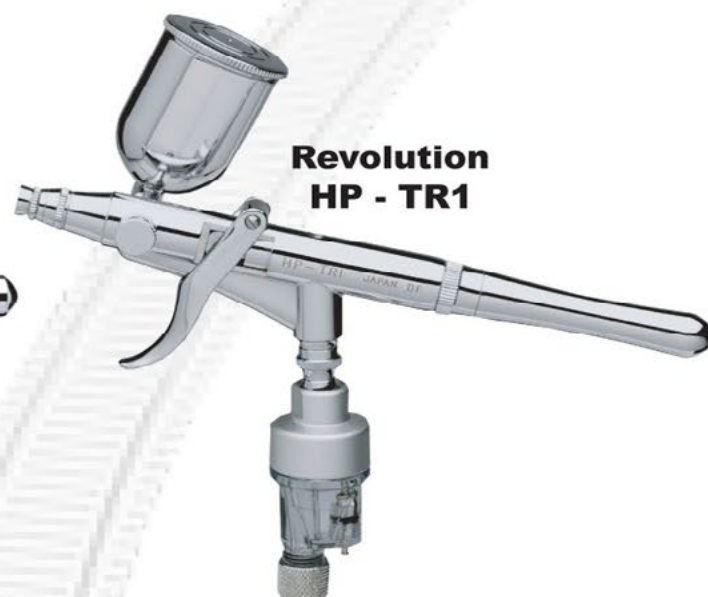

Visit...
www.iwata-medea.com
**To Check Out Our
Full Product Line!**

*Models By... Alan Houtz,
North American Prototype Modelers*

[← back to previous page of text ...](#) **Compromises**

I decided during the layout design phase to not plan for passenger train operations. A typical passenger train in August 1939 would have included a 40-foot-long RPO car, a leased SP diner, one or two heavyweight Pullmans (sometimes more), and the YV's 69-foot-long wooden observation car.

Motive power for these passenger trains was one of the YV's five 2-6-0s but a model 2-6-0 doesn't have tractive effort in proportion to the real locomotive. Accommodating passenger train operations would have required reducing the ruling grades on the layout while increasing track radii, siding lengths, and clearances.

If I had planned to run just the same trains run by the YV in August 1939 without the passenger trains, I would be left with four daily trains without any interactions, such as meets, with the exception of a single meet between the extras. That pace would certainly not be very appealing to visiting operators.

To make things more interesting, I made two changes. First, I chose to add a pair of non-prototype freight trains to handle a portion of the cars typically handled on the prototype by the extras. In addition, the times for departure of all of the daily trains were moved to the morning. This resulted in a fairly busy 2½ -3 actual hours of operation with each operator making 3-4 meets during the session.

With these changes, the trains ran during an operating session include the prototype No. 8/9 log train, the prototype Merced and El Portal Locals (although they run as timetabled trains rather than as extras), and a non-prototype "rock train" which moves what the YV called rock cars (22-foot ex-Great Northern hopper cars) between a limestone quarry operation and the Yosemite Portland Cement Co. plant. These cars were handled on the YV by the locals.

The addition of the rock train provides a job for a fourth operator and, like the log train, it runs the length of the mainline and turns to return to its initial departure yard. I do not have the aisle space for two-person crews so all engineers also take care of uncoupling cars, paperwork, etc.

2

EASTBOUND TRAINS HAVE RIGHT OVER WESTBOUND TRAINS OF THE SAME CLASS

YOSEMITE VALLEY RAILROAD COMPANY

EASTWARD			Miles from MERCED	TIME TABLE		Miles from EL PORTAL	Capacity of Sidings - 40' cars (then incl. engine and engine)	Fuel, Water, Turn tables, Wyes and Phones	WESTWARD		
No. 14 Freight	No. 12 Freight (Rock)	No. 8 Freight (Log)		No. 103a May 27, 1939	STATIONS				No. 9 (Log) Freight	No. 11 (Rock) Freight	No. 15 Freight
Leave Daily	Leave Daily	Leave Daily			Arrive Daily	Arrive Daily	Arrive Daily				
			0.0	MERCED-S.P. Depot	5	77.7					
9:55 AM	2:45 PM	7:30 AM	0.5	MERCED-Y.V. Depot	0	77.2	YARD	W.F.T.P.	8:05 PM	1:00 PM	6:05 PM
			1.0	A.T.S.F. Crossing	15	76.7					
			2.5	Portland Cement	35	75.2			12:55		
	4:15		10.9	Edendale	37	66.8	4				
			15.2	Hopeton	0	62.5					
10:30	4:30	8:05	24.2	MERCED FALLS	0	53.5	8	F.W.T.P.	5:45 ¹²	11:45 ⁹	4:50 ¹²
11:45 ¹¹	4:45 ^{9 15}	9:34	29.6	Starr	0	48.1			4:42	11:40	2:30
			30.7	Exchequer	0	47.0		P.			
			44.2	Kittridge	0	33.5					
12:55	5:25	10:27	47.7	BAGBY	0	30.0	4	W.T.P.	3:50	11:00 ⁸	12:55 ¹⁴
1:10 ¹⁵	5:35	10:45 ¹¹	60.8	Briceburg	0	16.9		P.	3:30	10:40	12:30
3:10 ⁹	6:55		67.0	Emory	0	10.7	5	P.	3:15 ¹⁴	10:25	
			70.4	Bloss	0	7.3		P.			
		11:15	73.0	Incline	0	4.7	14	P.	3:05	9:37	11:20 ⁸
3:40	7:12	11:38 ¹⁵	75.0	Moss Canyon Tank	0	2.7		W.P.	1:17		11:10
4:00	7:24	12:01	76.7	Moss Canyon Wye	0	1.0	5	Y.	12:50 PM	8:50	10:30
5:00 PM	7:40 PM		77.7	EL PORTAL	0	0.0	YARD	T.P.		8:10 AM	9:50 AM
Arrive Daily	Arrive Daily	Arrive Daily							Leave Daily	Leave Daily	Leave Daily

2: My employee timetables are folded, four-sided forms, as were the prototype timetables. This is page three, which is the most important page. The times in bold are meets. I also have a variation of this timetable which deletes the Merced and El Portal Locals (Trains 14 and 15). Under that timetable these two trains are run as Extras. Only one group of operators has ever chosen this option.

Paperwork

In order to operate under TT/TO, you need an employee timetable, train order forms, and clearance cards. For my timetable, I followed as closely as possible the format of the YV timetable in effect in August 1939. I used a desktop publishing program to prepare my timetable but Excel or even MS Word would work. The main page of my employee timetable is shown in Figure 2.

One method of developing a timetable is to graph all of the trains that will run during an operating session so that locations and times of all meets can be determined. That method seemed to me to be most useful when working with time-tabled through or first class trains instead of locals and other trains which have work to do along the line. Instead, I needed an approach that would work with visiting operators and accommodate the switching each train needed to perform.

I began by running a number of trains at appropriate speeds between each town or yard and recording how long they took.

The **SCOTTY MASON** SHOW
S H O W
The Original Model Railroad Podcast

Get the Latest Model Railroading News, Tips, Reviews & Opinions

- Monthly Interviews
- Modeler's Spotlight: Top Modeler's Talk
- Narrow Gauge Modeling w/Chris Lane
- Contemporary Modeling w/ Mike Rose

-More Product Announcements & Reviews

Our feed has changed! To get the latest shows, please search Scotty Mason and subscribe to the new feed!

www.TheModelRailroadPodcast.com

Scott Mason Jimmy Simmons Mike Rose Joe Duckworth

I also measured how long it took for each train to perform the typical switching needed at each location during an operating session. From this information, I could start building a working timetable. I used Excel for this task since it was easy to continually change arrival and departure times at various locations along the line and to adjust times for the meets.

In order to build a timetable, you'll also need to decide on a fast clock ratio. Of course if your layout is large, with long distances between towns, the fast clock ratio can be fairly low such as 2:1 (meaning that 10 minutes by the fast clock is equivalent to 5 actual minutes). Over the years, it seems that operators are moving to lower and lower fast clock ratios. One argument in favor of this trend is that some tasks can't be compressed, such as the time needed for switching and issuing train orders.

However, one of my goals in developing the timetable for my layout was to also produce a timetable which provided travel times between stations reasonably close to the prototype timetable. For example, the prototype YV log train departed Merced Falls at 8 a.m. and arrived in Incline 3 hours 10 minutes later. On my layout the same train takes about 22 minutes for the same run. But if I use a 10:1 fast clock, that 22 minute run will take 3 hours 40 minutes, very close to the prototype timetable run time.

Now, a 10:1 fast clock is a very fast ratio! That means that one minute on the fast clock takes only 6 seconds. If you need to leave a yard at 9:55 a.m., you only have a "6-second window" to leave on time. This can be stressful for some operators. However, while I built my timetable using a 10:1 scale time ratio, I actually operate it with an 8:1 fast clock.

While that might not seem like much, it does give a little more time for things. More importantly, when I timed how long it took to run between yards, I ran trains at only 18 scale miles per hour. In addition, I was very conservative when timing

switching moves. Together, these factors allow operators more time to run between times and complete needed switching.

In addition, all of the major switching needed to build the two locals prior to departure is done long before their departure times. For example, the operator for the Merced Local typically needs to pull their caboose from the caboose track and then pull 4-5 cars from the yard tracks to build their train. Some of these cars might be "buried" behind other cars which need to be put back where they started. But the operator of this local will typically "go to work" at 5:30 a.m. for a 9:55 a.m. departure.

The fast clock is set to 5:30 a.m. when this operator has looked over their switch list, figured out an efficient approach for the work, and

(Form 220 5M-2-42 JJC) 3

Yosemite Valley Railway Company
SWITCH LIST

At _____ Station, Aug 13 1945

TIME _____ M.

CAR	FROM		To	SP	Contents	Remarks
	Initials	No.				
1	UTLX	57954	✓		x Tank	
2	-	58280	✓		-	
3	SP	31646	✓		One	
4	-	96875	✓		-	
5	-	97072	✓		-	
6	Erie	51766	✓		-	
7	Co	40560	✓		-	
8	DR4	50287	✓		-	
9	SP	20456	✓		X	
10	-	20097	✓		X	
11	-	31222	✓		X	
12	IMP	12490	✓		X	
13	SP	20864	✓		X	
14	-	37618	✓		X	
15	-	31851	✓		X	
16	-	32089	✓		X	
17	INC	12338	✓		X	
18	-	12502	✓		X	
19	-	12101	✓		X	
20						
21						
22						
23	Rd	26154	✓	To AT	x Ref.	
24	UP	191662	✓		One	
25	W+W	47901	✓		-	
26						
27						

3: This is a prototype YVRR switch list from August 13, 1945. This switch list was written up for a Merced yard crew, since all of the cars on it are to be taken to the SP and AT&SF interchange tracks. Note that this form shows the name of the railroad as the Yosemite Valley Railway. That change was part of a bond refinancing plan which took place in 1934. I chose to retain the original name since that was the name most commonly associated with the railroad.

is ready to “go to work.” That gives this person over 30 actual minutes to complete this switching. If I feel the operator might need more time, I just have them go to work earlier. Likewise, time basically stops for the operators of the locals when they reach their final arrival yard. They still have work to do to switch out the cars in their train but this work is not governed by the timetable.

(Form 320 SM-2-39 JJC)

4

Yosemite Valley Railroad Company
SWITCH LIST

At _____ Station, _____ 19____

TIME _____ M.

	CAR			TO	TRACK
	Initials	No.	Type		
1					
2					
3					
4					
5					
6					
7					
8					
9					
10					
11					
12					
13					
14					
15					
16					
17					
18					
19					
20					
21					
22					
23					
24					

Conductor
Agent
Switchman

4: To help operators, I’ve added a Car Type column and deleted the Contents column of the prototype switch list on my switch lists. Instead of a Remarks column, I’ve substituted a Track column which indicates which track the car is to be spotted.

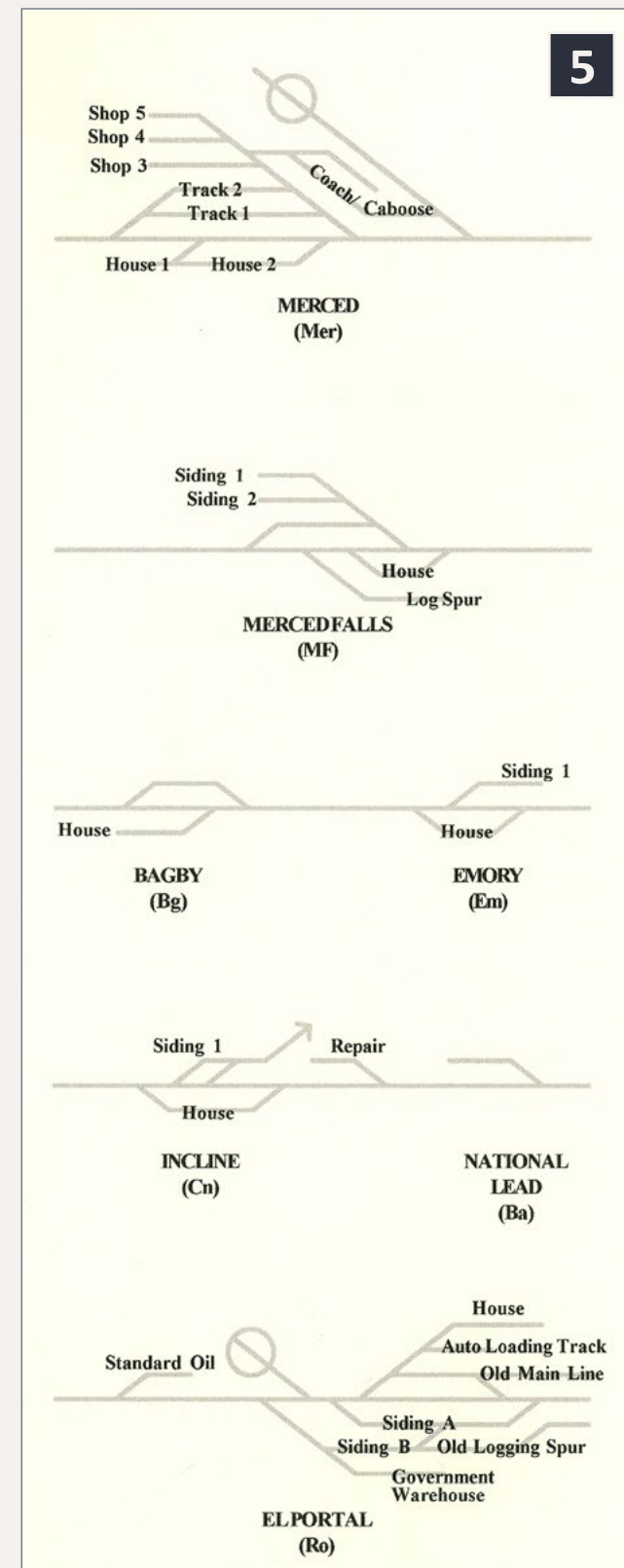

5: The YV used milepost designations on their switch lists for cars to be switched along the line. Instead, I use station names and siding names. The siding names match the prototype ones. The back side of my switch list includes this graphic to assist a visiting operator. The two-three letter abbreviations under the station names are the telegrapher’s abbreviations.

operating session waiting for departure times and meets.

I also tell visiting operators that not only will they have plenty of time to get their jobs done in a prototype manner but will also time to wait for the “brakeman” to throw switches and make a standing brake test after making up a train.

Operators of the locals use switch lists I prepare in advance. This means no car card shuffling or moving car cards from one box to another. The format of my switch lists generally follows the format of the prototype YV switch lists. My clearance cards also are replicas of the actual prototype forms and list any train orders an operator needs to have in their possession before leaving their departure station. Figures 3, 4, and 5 are of a prototype YV switch list and the

front and back of my own switch list. Figure 6 shows one of my clearance cards.

Operators

It seems that there might be a couple of types of model railroad operators. One type, and possibly the most common for many layout owners, are members of the regular crew. These are the ones who show up on a regular basis, maybe once a month or more often, to operate a layout. They might have also been involved in certain aspects of its construction. Regardless, they are intimately familiar with operations on it, the owner's vision for its operation, and all of the jobs on the railroad.

I've never had a dedicated crew who operate my YV on a regular basis, although there are many modelers here in the San

FORM 325-5m-9-39 6

**YOSEMITE VALLEY RAILROAD COMPANY
CLEARANCE CARD**

_____ STATION _____, 19__

CONDUCTOR AND ENGINEER No. _____

ORDERS FOR YOUR TRAIN ARE } **FORM "19"** _____
} **FORM "31"** _____

(If no orders form "19" or "31" endorse "NONE" in space provided for order numbers.)

TIME, _____ **M.** _____ **OPR.** _____

Operators must retain a carbon copy of this clearance.
 This does not interfere with or countermand any orders you may have received.
 Conductors must sign orders Form "31" before accepting from Operator.
 Conductors and Enginemen must each have a copy and see that their train is correctly designated in the above form, also see that the numbers of all train orders received correspond with numbers inserted above.

6: This clearance card uses the same format as the prototype.

FORM 326-5m-9-39 7

**YOSEMITE VALLEY RAILROAD COMPANY
ASSIGNMENT CARD**

ENGINEER _____

TRAIN NO. _____

TRAIN NAME _____

Locomotive No. _____

Caboose No. _____

REPORT TO DUTY:

_____ STATION AT _____ M. ON _____, 19__

To turn on the throttle, push the red Emergency button.

7: This assignment card provides each operator with information on the train number and name of the train they will be running, the numbers of their locomotive and caboose, and where and when they are to report for duty.

Francisco Bay area who have operated on it a number of times. I don't personally operate trains during these operating sessions. Instead, I am the dispatcher as needed and troubleshooter. Keep in mind that operations are not my main interest (which is research and model building). But I still enjoy sharing my layout with those whose primary focus is operations. It is entertaining.

But accommodating visiting operators, especially those who have never previously visited my layout, means incorporating easy-to-understand controls and logical operating practices. As part of this goal, I use two non-prototype forms. The first is a very basic but authentic-looking assignment card (Figure 7).

Once I either assign a specific train to each operator (or they choose themselves, always an option), I give each operator one of these forms. The form simply lists which train (by name and timetable number) each operator will be operating, which

locomotive and caboose is assigned to that train, the yard where they will start their run, and the on-duty time for that operator. The form makes it easy for an operator to know when they are to “get on the clock” and know which locomotive and train is theirs for the session.

Together with an assignment card, and a copy of the timetable (and switch list if

8

YOSEMITE VALLEY RAILROAD

Job: Train 14 Merced Local

TRAIN NO. 14

MERCED - Make up train using Switch List. Obtain Clearance Card from Agent at station. Run to Merced Falls per TT.

MERCED FALLS - Make setouts and pickups as required. Take water. Meet No. 11. Run to Bagby per TT.

BAGBY - Make setouts and pickups as required. Meet No. 15. Take water. Run to Emory per TT.

EMORY - Make setouts and pickups as required. Meet No. 9. Run to Incline per TT.

INCLINE - Make setouts and pickups as required. Run to Moss Canyon per TT making setups and pickups as required.

MOSS CANYON - Take water. Do not turn on wye. Run to El Portal per TT.

EL PORTAL - Make setouts as required. Leave caboose on turntable lead and engine on Siding “B” (oil stains on the track in front of the Government Warehouse.)

Non-OS

8: This is a job card for Train No. 14, the Merced Local. It gives the operator the general scope of work for their train. The notation “Non-OS” in the bottom right corner identifies this job card as one where there isn’t a dispatcher on duty. A slightly different job card includes notes on calling the dispatcher at each station or telephone location, and giving their OS (or “on sheet”) time when a dispatcher is available during an operating session.

9



9: There are no known photos of local freights on the YV while they were running as extras. However, this photo of a mixed train leaving Merced sometime after June 1943 shows what might have been a typical consist in those days. The engine has just passed the semaphore for the AT&SF interlocking plant (Fred Stoes photo).

required), each operator is also provided a job card for their train (Figure 8). One side provides detailed information on what the operator needs to do throughout the session, and the other side provides standard YV whistle signals (for those not so stressed that they forget to whistle for grade crossings, when approaching stations, etc.). These forms are 4¼” x 5½” high, are printed back-to-back, and laminated at the local copy store for permanency.

The purpose of these cards is to provide to a visiting operator with the experience gained by a real YV engineer running

the same train every day — the need to obtain a clearance card before leaving the initial station (and possibly later before changing train numbers), when to take water, etc. As such, it is



10: Locomotive No. 29 is on the head end of train No. 14, the Merced Local, this day. It is shown waiting for the semaphore to drop at the AT&SF interlocking plant so that it can proceed toward Merced Falls and, ultimately, El Portal.



11: While train No. 14 was switching cars onto its train in Merced, locomotive No. 25 was doing likewise in El Portal for the El Portal Local. Here is it pulling a YV flat car loaded with a state roads department Fresno scraper out of the auto loading track.



12: Earlier today, the engineer of the Log Train, the No. 8, picked up its assigned cabooses and left Merced at 7:30 a.m., running light to Merced Falls. There it pulled out the log cars spotted the previous day on the Log Spur, ran around them and then coupled back onto its cabooses. It is now 9:34 a.m. and the No. 8 is just crossing the county road as it leaves Merced Falls for Bagby and a meet with the Rock Train.

much like having a mentor working with you as you take out your first train.

Orientation

All of these efforts to help visiting operators might seem excessive if you only have regulars operate your layout but every operator is a newbie on a new layout. I also provide a quick orientation for visiting operators before the operating sessions. I have a checklist of the things I want to cover during these orientations. For example, I like operators to take water

at all water tanks or water plugs. Some of them are operational so I demonstrate how those work. I also point out the need to return all mainline switches to be lined for the mainline as required by Rule 104, and remind them that all of the derails on the layout are operational.

The goal

During the orientations, I also encourage operators to not chat with each other about current day subjects, such as what television show they watched the night before while waiting for meets or a departure time. It is not a hard and fast rule, but I like operators to get completely immersed in the time and place being modeled. Ideally, by the end of the operating session they will have felt that, for a few hours, they were



13: An hour after the departure of the Log Train from Merced Falls, the Merced Local arrived and made its pickups and setouts. Here No. 29 carefully spots a Great Northern box car along the planing mill shipping dock. It will have plenty of time to complete this work (and its other work) before leaving Merced Falls an hour and 15 minutes after arrival (10 actual minutes).



14: No. 11, the daily Rock Train, departed El Portal at 8:10 a.m. this morning, running light with just its caboose. It is now around 10:30 a.m. and the 4-4-0 has left its caboose on the main and backed into the siding at Emory to pick up the loaded YV rock cars.

actually operating a real train in a real place on a warm day in August 1939.

Pictures continue on the following pages ...



15: No. 8, the eastbound Log Train arrived at Bagby at 10:27 a.m. After taking water, it pulled forward to the clearance point for the siding. Since it is superior by direction, it stayed on the main line. It is now 10:40 a.m. and the westbound Rock Train has arrived for their meet. The Log Train is longer than the siding and is blocking the west switch. Fortunately, the cars in the Rock Train are only 22 feet long and locomotive will slowly pull forward until its caboose is clear, allowing the Log Train to pull out and leave for Incline.



16: The lack of a blackout visor on the headlight dates this photo to probably 1940 or 1941. (Visors were installed on all YV locomotives in early 1942, after the United States joined the Allies in World War II in December 1941.) Train No. 9 appears to be passing Jenkins Hill, about 6 miles west of Incline where it picked up the loaded log cars (Al Rose photo).



17: Train No. 9 has just left Incline with an empty UTLX "Van Dyke" frameless tank car coupled behind the engine and a line of loaded log cars in tow. Jenkins Hill is just around the curve beyond the trestle.

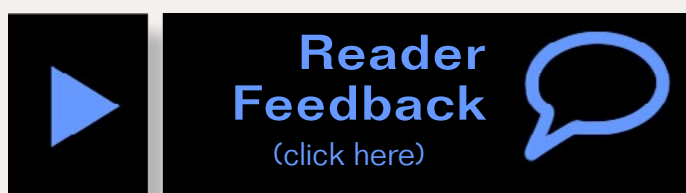

NORTH AMERICAN RAILCAR CORPORATION



© 2011 Kevin Dunk



Click here for Canpotex (CEFX) (CGLX) (CITX) (PTEX)
4275 cu. ft. 3 Bay Covered Hopper

National Steel Car – Potash Service!

Click here for Potash Corp of Saskatchewan (POTX)
4300 cu. ft. 3 Bay Covered Hopper



HO & N Scale... Sold exclusively through

Pacific Western Rail Systems



Meet Model Railroad Artist Dave Davis

Photos and video of superb models

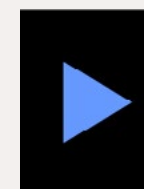

Reader
Feedback
(click here)



What's neat this week column by Ken Patterson

1



1: Dave Davis built this bridge structure load with an idler car.



Dave Davis has talents in all facets of model railroading. From large walk-around home layouts, to totally tricked-out scenic dioramas, to his many published articles in the model press, Dave has done it all. This month we focus on Dave's modeled and weathered freight cars, and their loads. For most of his prototype ideas, he uses railroad historical books such as "The Classic Freight Car Series, Vol 6: Loaded flats and gondolas."

Mild weather in St. Louis this past January gave Dave and I five days to set up a few sections of my home layout outdoors to create a photo and video presentation of some of his flat car models. All are filmed in natural sunlight. The prototype-like run-bys would be hard to create as still photos, yet they pan 8 feet. Cool stuff this month.

[... Article continues on next page →](#)



Playback problems? [Click to try a different version.](#)

NEW FROM ACCURAIL **MADE IN THE USA**
EASY TO ASSEMBLE HO SCALE KITS



Penn Central Insulated 40' Steel Box Car



Southern Pacific 3-Car Set



Central New Jersey 40' Steel Reefer



Also available as singles



Southern Railway Double Door 40' Steel Box Car



Norfolk & Western 50' Steel Combo Door Box Car

Illinois Central 50' Steel Insulated Plug Door Box Car



PLEASE SEE YOUR LOCAL HOBBY DEALER OR CALL 603-965-1173 FOR DIRECT ORDERS
ACCURAIL INC. PO BOX 278 ELBURN, IL 60119

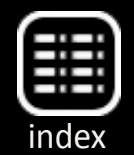
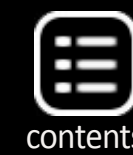



3: This late 1960s-era freight car load, an Overland Models D5 bulldozer, is blocked and banded to a Life-Like 40-foot flat car.



5: This small refinery fractionating tower is loaded on three flat cars. The outside flat cars bear the weight while the center idler flat keeps everything together during movements. The video shows the load running through a curve, illustrating the swing of the load and the cars in action.



4: This model, representing a General Electric-style prototype, sports two Buckeye and two standard AAR 40-ton trucks. The model shows the flat car after the load has been removed, with some of the supporting steel brackets still in place.



6: Dave's bridge beam load viewed from above. The idler car detail shows clearly. The load is blocked with wood fastened with steel, bolts, and nuts.

7



7: This generator load is fashioned after prototype photos, to fit the brass Queen Mary depressed-center flat car. Lots of styrene and bolt castings were used to construct this model.

8



8: The Walthers transformer is loaded on a Walthers depressed-center flat car with Athearn 100-ton trucks and Sergent scale couplers.

9



9: This Intermountain box car is weathered after a prototype photo on page 45 of the C&NW final freight car roster printed by the C&NW Historical Society. Burnt umber oils were used to create this effect.

Advertisement

Click Here

FIFER HOBBY SUPPLY LLC

**Your Local Online
HO & N Scale Hobby Shops**

575-523-9743 • fiferhobby.com • fiferhobbyho.com

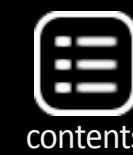

10



10: This InterMountain flat car is loaded with John Deere tractors shipped without the tires. Time was spent carving the tractor rear tire rims to better match the prototype as per photos.

11



11: An InterMountain flat car has seen better days. The heavy weathering of the board by board deck was achieved with shades of gray lacquer paints. This car was inspired by Greg Moe in a RailModel Journal article in 2000.

Advertisement

RailPro™
NEW
TECHNOLOGY



Click here
to watch
our videos!

New Products

- Accessory Module
- Auto Reverse Module
- New Sounds and more!

For more information visit our Internet site: www.RingEngineering.com

12a

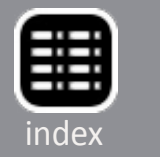



12a-12b: This scratchbuilt transformer was built to be hauled by the brass Queen Mary flat car. The transformer is made from styrene with details from Details West and Vollmer.

▶ [Reader Feedback](#) (click here) 

STREAMLINED BACKSHOP SERVICES



Z-N-HO-G DCC INSTALLATIONS















www.SBS4DCC.com

click here!

Recommended installation tool

Goes on easy

All Scales

All Brands

Make a Tire or Retire

99% Know It Works!

SNOT = SAND



BULLFROG SNOT

Green Grip from a Jar

WWW.BULLFROGSNOT.COM

WESTERFIELD GOLDEN AGE LINE MODELS, LLC

Now Available



USRA Gondola #8151/8161

Also Avail: PSC Ore Car

westerfieldmodels.com

OC1 Quad DCC occupancy detect www.olinsdepot.com

R1	0018	Seg1
R2	R100	Seg2
R3	R100	Seg3
R4	0018	Seg4

The Most Advanced Occupancy Detector EVER !!



Olin's Depot

ON3 - ON30



Click to visit ...

WWW.SANJUANCARCO.COM

Backdrop Junction

Your stop for Model Railroad Backdrops



click here to visit our website

backdropjunction.com

N, HO, O Scales • Custom Orders

REAL CEDAR TRUNKS

Click Here!

AMERICA'S NUMBER ONE RAILROAD PRINT SOURCE

Jelsma Graphics

America's Railroad Embroiderer

Railroad Art-Prints, Caps, Jackets, Shirts and More ...

Jackets starting at \$79.95

www.jelsma.com

1-904-221-3513 • Jacksonville, FL.

True Scene Modeling

NEW **FusionFiber**

Dependable Quality. Easier than Plaster!

SATISFACTION GUARANTEED!

www.truescene.com or 716-523-7305

Affordable custom and modular benchwork.



MODEL RAILROAD BenchWork

www.modelrailroadbenchwork.com

CLEVER
models LLC
Cardstock models &
Building materials

Central
CAMERA CO.
SINCE 1899

CLICK HERE

www.clevermodels.net

CAMBRIDGE TRAIN SHOP
Supplying UK trains to the US
Buying US N scale for the UK

Please email us for details:
info@cambridgetrainshop.co.uk

Click Here

PORTLAND CAR
& FOUNDRY

HO Scale Steam and
Transition Era Specialists

click me!

Minimalist Model Railroading

New Approach to
Model Railroad Design

Click here to learn more...
minimalistmodelrailroad.com

An exciting new
development
is coming from
Model Railroad
Hobbyist this
fall ...
Watch for it!

We have Coal
CLICK HERE

Don't settle for lifeless signals!
We've got signaling circuits!

LOGIC RAIL™
TECHNOLOGIES

"Sophisticated
Model Railroad
Electronics"

Please visit our website and online store!

21175 Tomball Pkwy
Suite 287
Houston, TX 77070

Phone: (281)251-5813
<http://www.logicrailtech.com>
info@logicrailtech.com

Your ad could
be in this space
for just \$55 a
month.

Click to
learn more ...

Get your ad in the marketplace ... click to find out how.

Great Decals!
is now selling decals produced by
After Hours Graphics for Midwestern
railroads. Roads offered include C&O,
Cincinnati Union Terminal, Conrail,
CSX, DT&I, Great Miami, Indiana and
Ohio, Interstate, NKP, Norfolk and
Western, Pere Marquette, Southern,
Transkentucky, and private labels Dow
and Owensboro Grain.

For the complete list, see:
[www.greatdecals.com/
AfterHours/AfterHoursList.
html](http://www.greatdecals.com/AfterHours/AfterHoursList.html)

Great Decals!
P. O. Box 994, Herndon, VA 20172

RULERS-of-the-WORLD
Scale Rulers \$4 each
Over 150 scales!
Metric or Imperial
www.rulers-of-the-world.com

Your Text Ad
Could be here for a remarkably
affordable price!
mrhmag.com/advertise_with_us

Scale flash photography

– Dr. Geoff Bunza
Model Photos by the author

An animated photographer for your layout ...

After I finished my clinic on micro LED lighting at the joint PCR/PNR Convention in Medford, Oregon, Phil Everett asked about using an LED as a flash for a trackside photographer on the River City Modeler Club layout in Spokane, Washington. He wanted the photographer to take only one picture as a train emerged from a

tunnel, and to wait until the train passed before another flash “photo” would occur. I thought it was a great idea, and set to work on hiring my own company photographer.

The project is straightforward. I found that both Woodland Scenics (A1883 Surveyors) and Preiser

1. Company Photographer on the job.

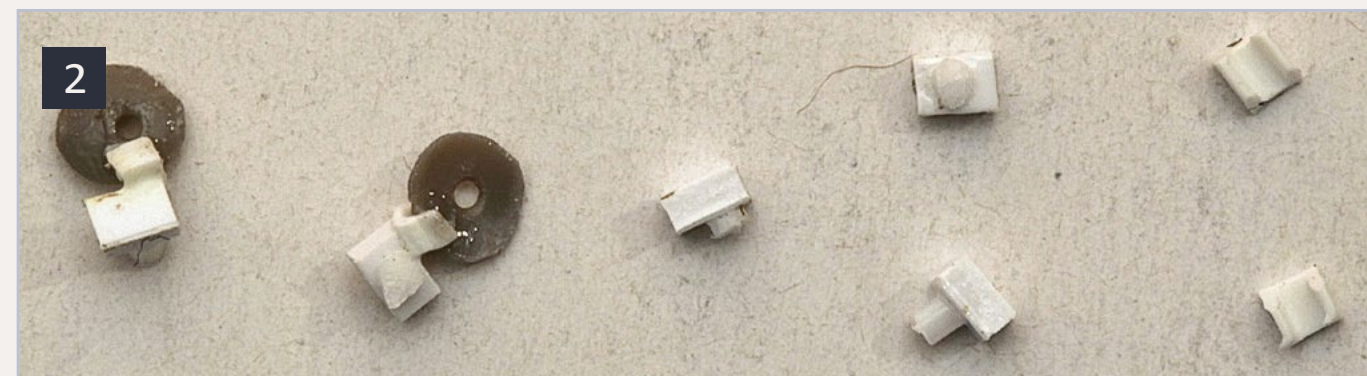

2. Cameras and parts.

(10512 Surveyor Figures) had “surveyor teams. The first step is to mount a “camera” on the top of the tripod with a reflector for a flash on the camera. The photographer in the photo in figure 1 is a Woodland Scenics surveyor with his tripod converted to a camera stand.

First remove the surveyor transit from the tripod and file the top flat. The camera is made from bits of scrap .04” styrene strip cut down to fit with a short stub of .06” styrene rod glued on as the lens. Add the flash next. A Tichy lamp shade acts as a flash reflector. Set it in a small mount formed from U-shaped channel, then trim back, and paint it.

Next wire a #0401 white micro LED (surface mount type with 38 gauge magnet wire). See my article on using micro LEDs in the (issuu.com/mr-hobbyist/docs/mrh12-02-feb2012-ol?viewMode=presentation&mode=embed) February 2012 Model Railroad Hobbyist Magazine for sources and techniques. Leave the leads long enough for placement on your layout. Thread the leads through the hole in the reflector and glue the LED in place with a clear adhesive (ACC, Elmers white glue, watch crystal cement, Micro Kristal Klear, etc). Twist the leads together for strength, run them down one leg of the tripod, and glue them in place. If you did it right, you’ll never notice the wires are there once the tripod is painted. You can see the finished result below and in the video.





3. Preiser surveyor tripod transformed for photography.



4. Tripods after painting without "flash bulb."



5. The company photographer Phil sets up his shot.

The accompanying circuit provides the rest of the magic. It is a simple circuit that pulses the LED with a higher than normal current (about 75 mA measured) for a very brief time (about 8.5 milliseconds) and then waits for some longer period of time for the train to pass. With the component values listed, this time is about 2 minutes. It can be adjusted longer or shorter by increasing or decreasing the 470K resistor and/or the 200uF capacitor. Do not dramatically increase the pulse time to the LED by fiddling with the first NE555's values, or you will blow out the LED. This overdrive technique is used on cell phone flash units all the time, and will reliably yield a nice bright flash.

The circuit is straightforward, and most people familiar with electronics should be able to build it. The track "trigger" consists of wires connected to a bit of a Kadee coupler box spring hovering just above rail height. The ground (or common wire) is connected to the rail below the track sensor. Note: do not use track power in this case to power the flash circuit. I use

either a three cell AA battery pack or a 5-volt “wall wart” DC power adapter rated 200mA or better.

1. As an alternate sensor, I use an infrared photo-transistor and an infrared LED. The Infrared LED is an LEDTech UT1883-81-940. The infrared phototransistor is a matching LedTech LT9593-91-0125 (data here: allelectronics.com/assets/spec/ILED-8.pdf and ledtechusa.com/data/data-sheets/LT7-9X/LT959X-91-0125.pdf). The IR diodes and transistors are available from All Electronics (allelectronics.com), and others from Jameco (jameco.com).

Both trigger circuits are shown in the figures below. The mechanical contact will wear over time, and is subject to abuse – but it is simple! The infrared solution takes longer to set up but, unless you power it with batteries – requires no

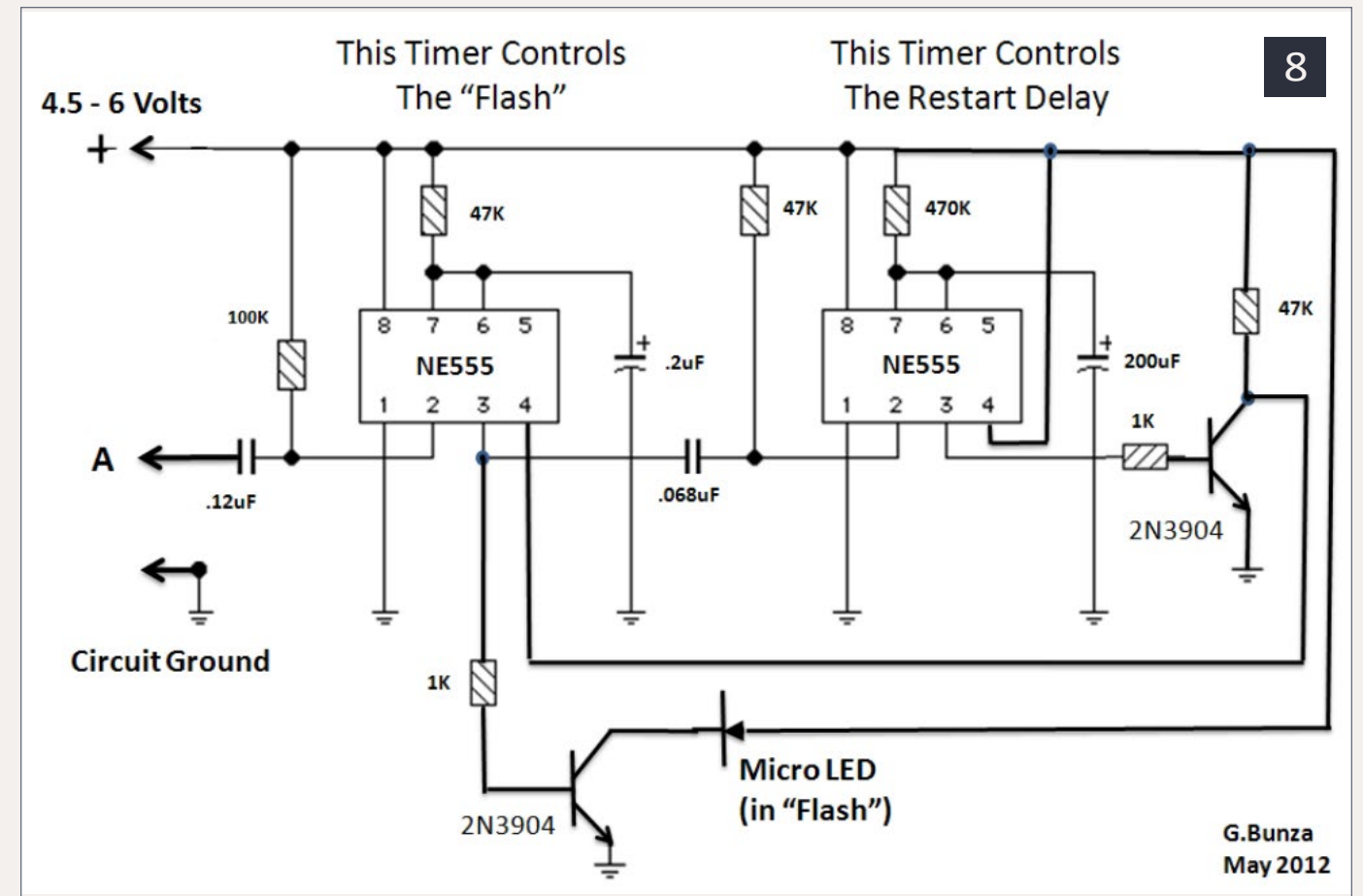

8. Flash timer and delay circuit schematic.



6. Track mechanical contact before burial.

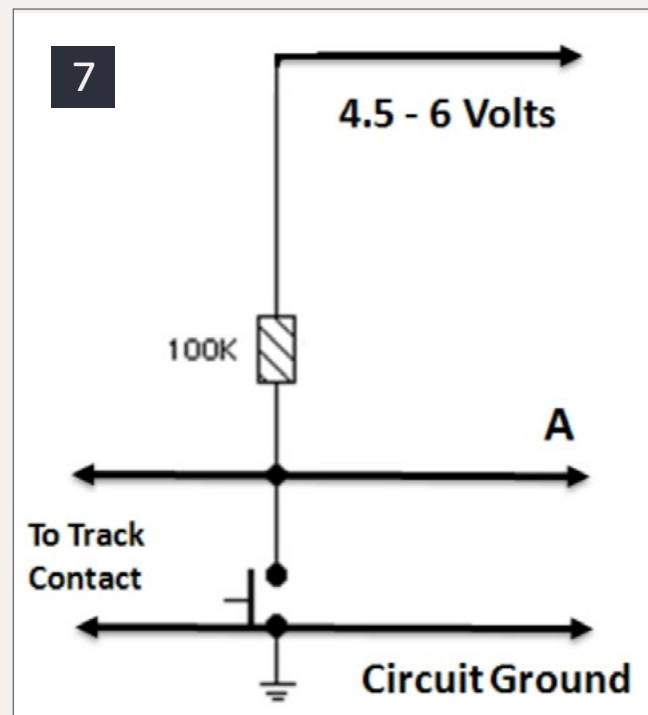

7. Track contact circuit.

Advertisement

Rslasekits

Z scale shown



July Special

N and Z scale
Speeder sheds **25% off**
Includes speeder and
code 40 rail, strip wood
and laser cut parts

Dealers welcome Custom Laser Cutting
Salem, OR
503-371-4290

Sales@rslasekits.com



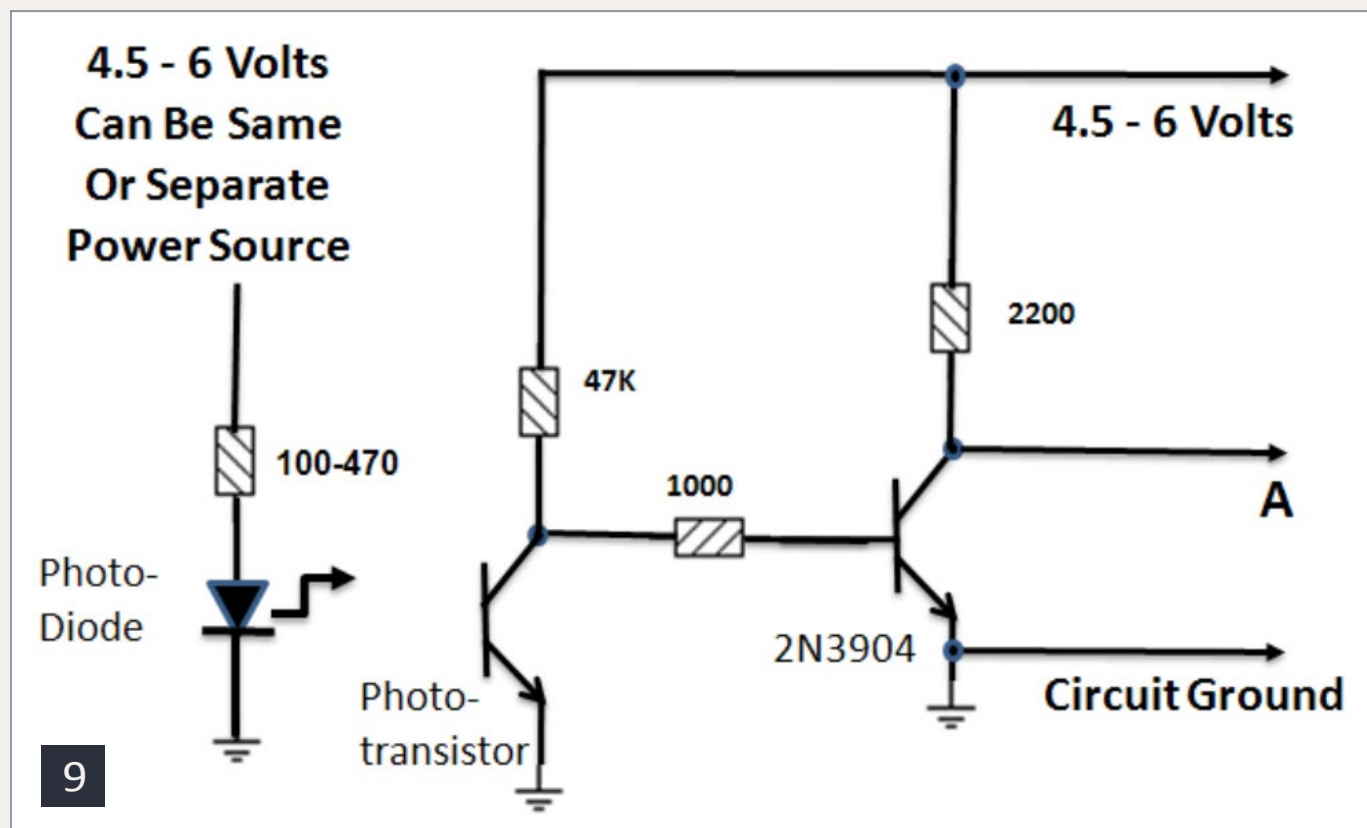

9. Infrared detector circuit.

maintenance, and its light is invisible, allowing you to hide it in your scenery.

Most component values are not critical. The circuits are simple enough that they can be built on a small solderless breadboard. If you use other components, some adjustment to the resistor values may

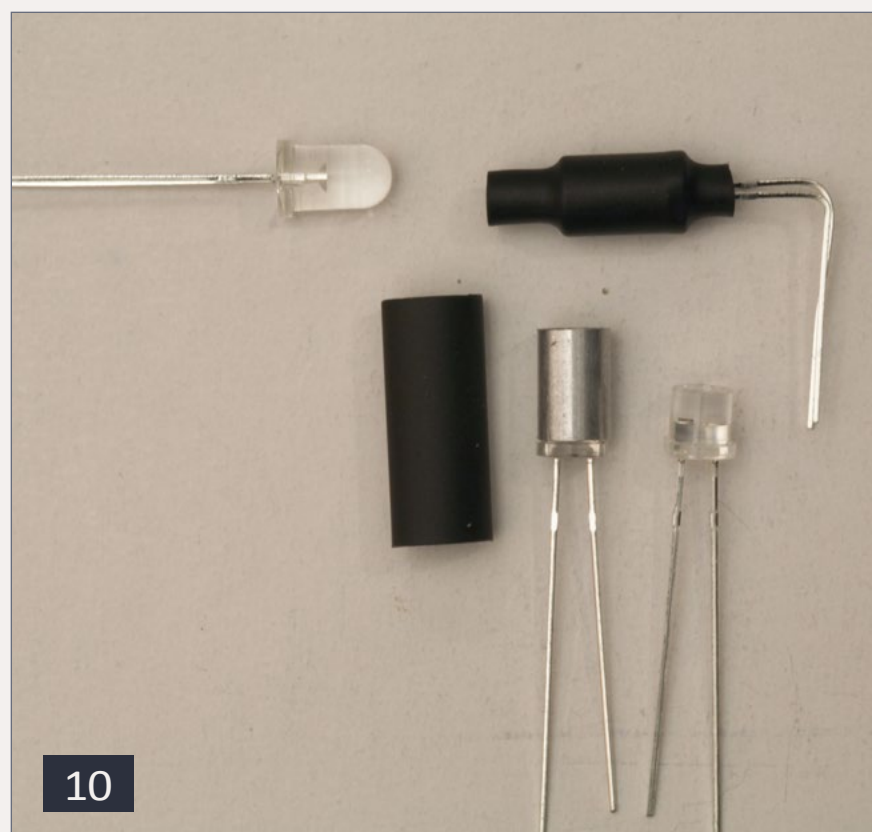

10. Infrared switch components, LED on the left, phototransistor on the right.



11. The company photographer takes his last shot.

be necessary. The components and values were the ones I used and measured.

If you use the infrared phototransistor and LED, cover the end of the phototransistor with a shield made from an appropriately sized piece of ½ inch long metal tubing – I tried plastic but it did a poor job. Glue the shield in place and then cover the assembly with some heat-shrink tubing or tape. This will make the transistor sensor directional and less sensitive to picking up ambient light. Since you can't see the infrared light, pay close attention to placing the powered infrared LED and the phototransistor on opposite sides of the track (where the train will cross to break the beam) so that they point directly at each other.

Now stand back and ask your visitors if they want any pointers from your company photographer as they watch him document your road's latest in motive power!





Geoff Bunza started as a model railroader when he received a Mantua train set for Christmas, at age 6. He fed his interests through college, becoming a member of the Tech Model Railroad Club (TMRC) at MIT while getting his doctorate and three

other degrees in Electrical Engineering. Geoff is blessed with his wife, Lin, in marriage for 33 years, and their two terrific sons. He is a member of the New York Central System Historical Society, a life member of the NMRA, and holds an Extra Class amateur radio license.

Advertisement

Railroad Explorer Magazine

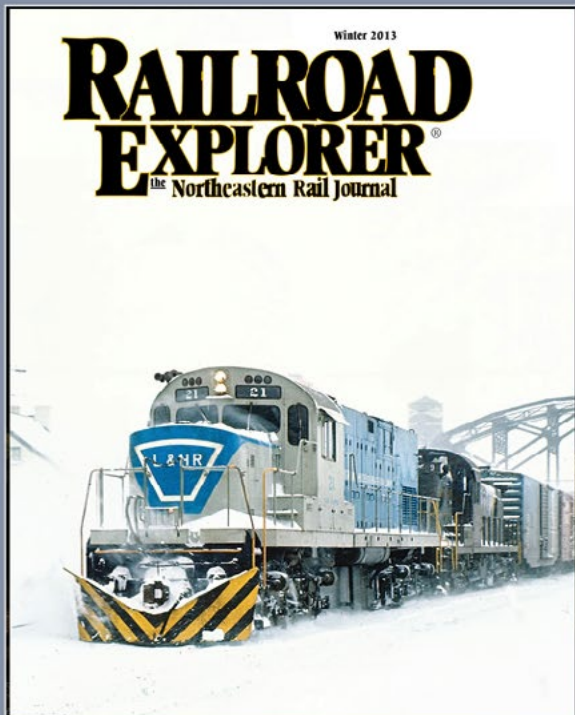

- Three, all-color issues per year.
- Exciting feature stories, spectacular photos.
- Best-in-class photo reproduction.
- Printed on heavy, glossy paper.
- Zero advertising. All content.
- Winter, Spring/Summer and Fall editions.

Issue 37 - Winter 2013
On sale now
Subscribe Today!

www.railroadexplorer.com



Southern Digital

Specializing in DCC Since 1992



DCC Conversions & Service

WWW.SODIGI.COM

(770) 929-1888

(Photo's are from our N-Scale layout)



Modeling the City of Miami, part 1

Model this late steam era name passenger train, car-for-car

By James Eager

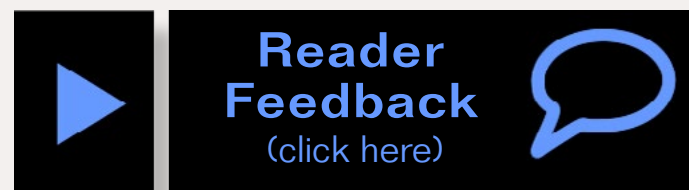

December 18, 1940 the inaugural run of the City of Miami, a seven-car coach streamliner. Its route was from Chicago to Miami, a distance of 1,493 miles (2,403 km). Like a ship leaving harbor, her bow had a wave-like pattern that cut the prairie as she moved.

I first saw an image of this train on the cover of Paul M. Somers book, "Illinois Central Streamliners 1936-1946". A whole chapter of the book is devoted to this train.

My City of Miami train is a study in stops and starts, errors, and doing something over until you get it right. As I learned during this process, passenger cars take more effort to get working correctly than freight cars. I thought they would be easier. I ended up farming out some parts of that could get done faster and better by others.

I also discovered that there are no good color photographs of this train in existence. The only color images I have seen, so far, are a 16mm film of the train. Unfortunately, the film does not show the lettering on the sides of the cars. The only clues to the actual colors are statements such as: "The entire train was painted in an orange and palm green scheme with scarlet stripes and lettering. This color scheme only lasted a few years and then the whole train was repainted into the chocolate and orange scheme that the ICRR settled on."

I decided I would build a version of this train for my layout. This was in the late 1990s, I started by looking around for what was available. Not much, so I shelved the project as my job situation changed. By 2001, I moved and my layout was history. The book was misplaced in the

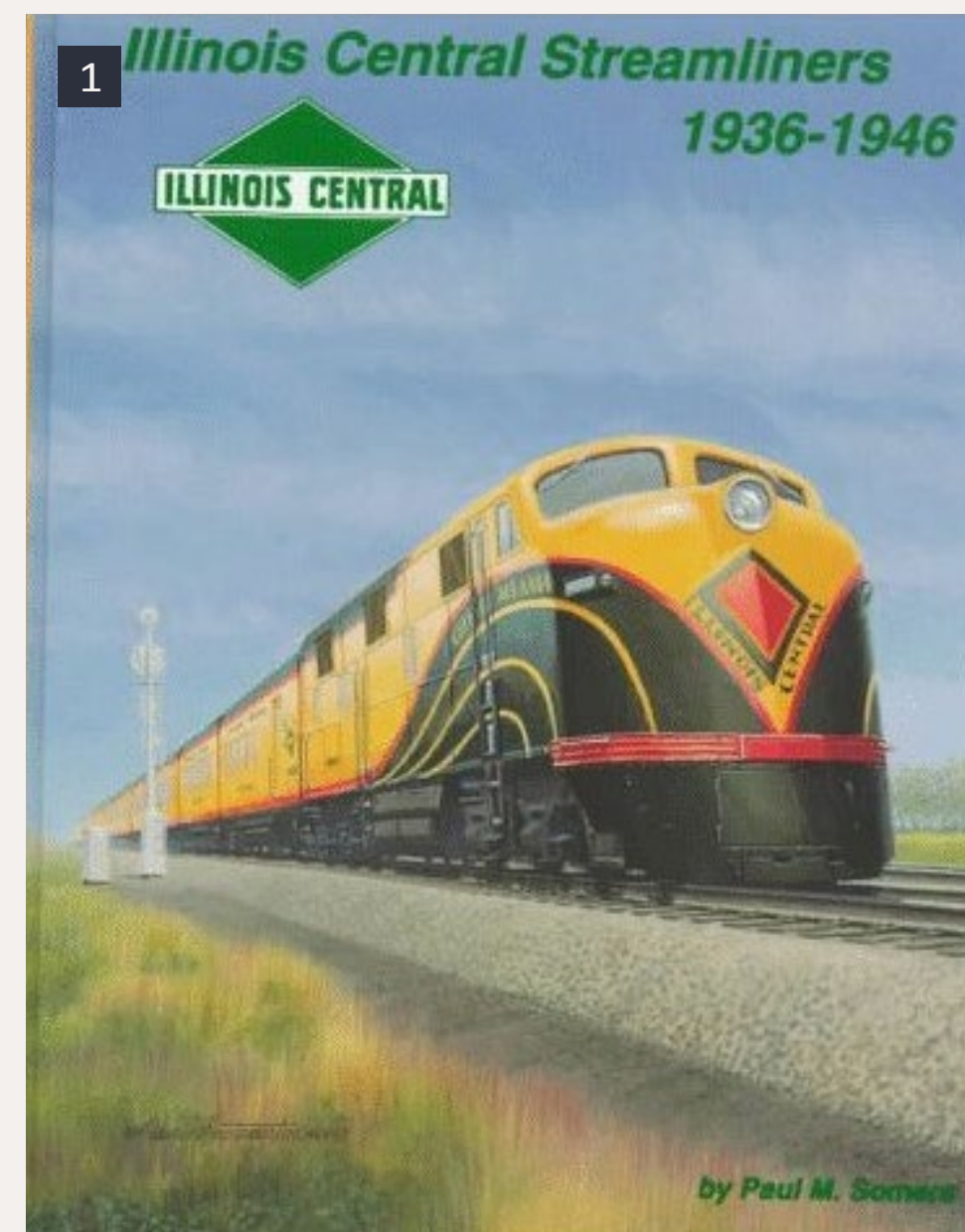

1: The City of Miami on the cover of the book by Paul M. Somers called "[Illinois Central Streamliners 1936-1946](#)". A whole chapter of this book is devoted to this train – it's a research source worth getting.

move, and it wasn't until about 2002 that I found it again. Even though I didn't have a layout, I decided to see what I could do about building the City of Miami.

The cars

By 2004, I found that IHC made 8 different cars in the City of Miami scheme. Using the Sommers book as a reference, I found that the City of Miami only used 5 different car types in the 7 car consist, and 2 of those were different versions of the coach. I decided to buy a copy of all 8 cars offered by IHC, plus 3 extra coaches. I also bought the matching interior kits for each car that I bought.

Among the people I have talked to about the City of Miami paint scheme, there are two schools of thought. Some say the lettering on the cars and road number of the engine were



2: The IHC version of the color scheme using the scarlet letters.



3: The MTH version of the color scheme using the green letters.

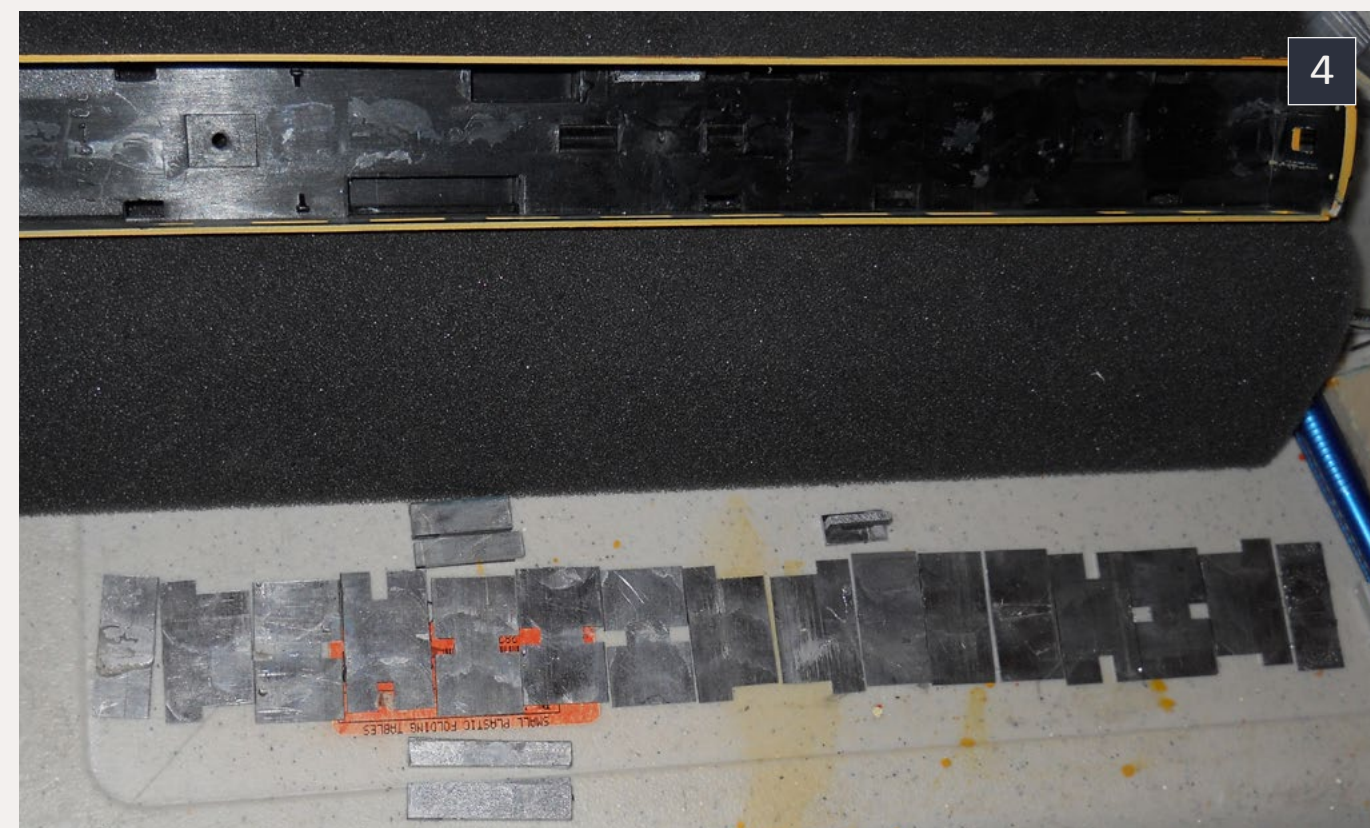

4: The parts of the weight kit laid out before assembly.

green, others red, or scarlet. I'm of the scarlet camp, and so was IHC when they painted the cars.

I used the interior kits that were available and simple to install. However, I opted out of lighting the insides of the cars. I will go over the interior detailing in Part 2.

I also went to a local hobby store and purchased enough Kadee #5/508 Talgo mounting kits to redo all the couplers. McHenry's would have been another option.

I set the cars aside at this time to focus on the engine. It wasn't until 2010 that I got back to the passenger cars. While working with another set of IHC cars, for IC Panama Limited, I found that the cars were too light. This prompted an online search and I found Adair Shops. (IHC went out of business in 2009).

Each weight system for a given car is a bunch of metal pieces in different sizes and shapes, and putting them into the car is like

building a jigsaw puzzle. Once you have the layout of the metal parts figured out, then you glue them down using the glue that comes with the kits. Mostly, they fit between the interior kit and the floor of the car, but some parts are stuck down in undercarriage detail cavities, or up in interior kit detail cavities.

I was testing some other cars at the Suncoast Model Railroad Club (www.suncoastmrrc.com) and found out that many clubs don't want plastic wheelsets running on their layout. In fact, many DCC based layout clubs now forbid non metal wheelsets! This started a search for alternatives. I took some of the cars into a local model train store and we tried several different types of wheelsets, all to no avail. I was pricing entire trucks from several places and the price to re-wheel all of both trains was starting to get expensive.

While I was examining alternative ways to do this, finally it hit me. I e-mailed the folks at Adair Shops and asked them what they used for metal wheelsets on their IHC cars. They said that

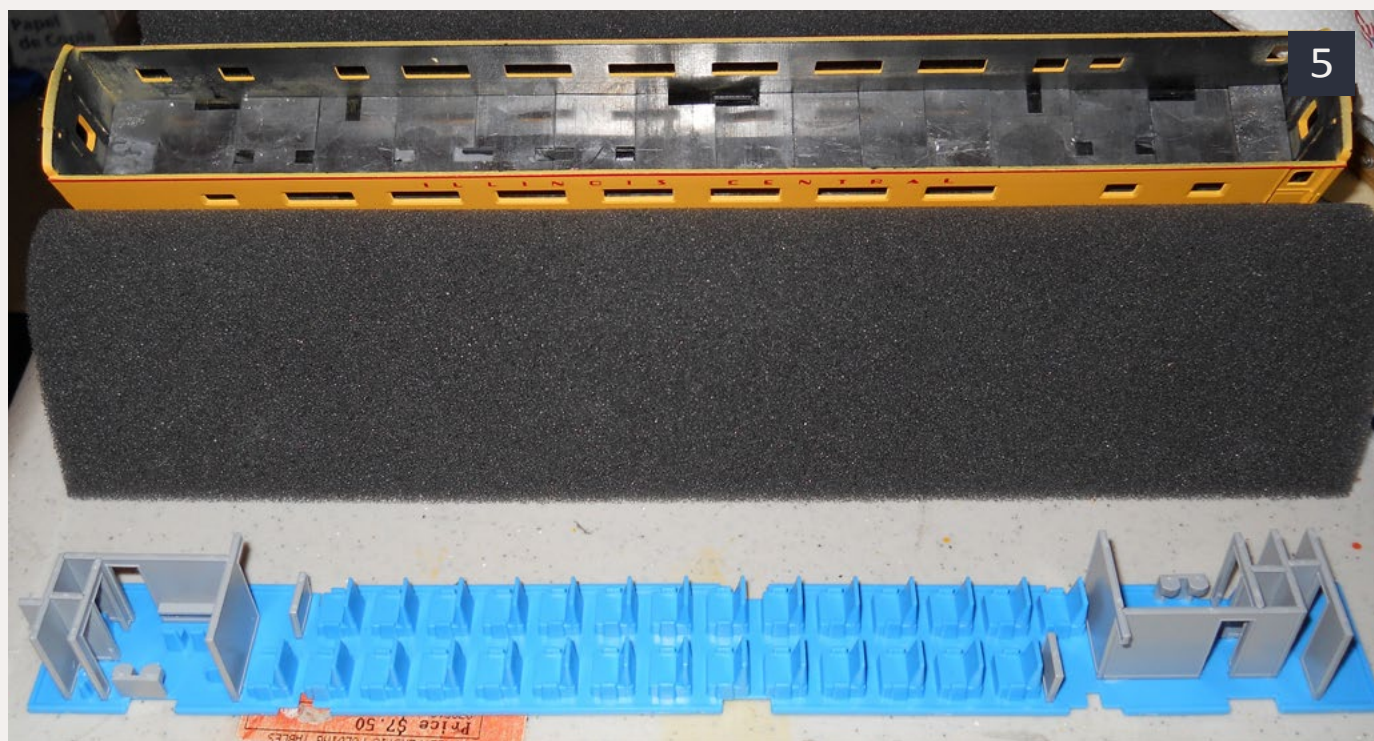

5: Finished assembly of the weight kit.

they used either the 920-21258 Proto 2000 wheelsets or Intermountain 40050 wheels. (In the defense of the local shop I had tried to find wheelsets in, he had neither type in stock when we were trying different wheelsets that day).

Lettering

To get the lettering I needed for the car names that were not available, I scanned the lettering on the sides of the cars using a flatbed scanner and built decals. Using the extra cars I had bought, but were not part of the historical consist, I was able to scan every letter but one. I had to build an "H" in Photoshop by using parts of other letters. The rest of the car names I was able to piece together, letter by letter, using scanned letters.

My first attempt was to paint over the numbers and names with a yellow that matched the cars. That didn't work, so I next tried to scrape off the new paint and the lettering. While this worked, this left damage to the yellow paint underneath and surrounding colors. I initially decaled them anyway and left it at that in 2010. I was not happy with the results.

When I was testing some other cars on the Suncoast Model Railroad Club, I mentioned my dilemma to Carl Marchand. He suggested that I should have "erased" the names and numbers from the cars. After the engine came back, I tried painting over



6: The damaged paint. This is an example of one of the three cars that I tried to rename and renumber.

the damaged areas with the new paint formula that had been used on the engine. While the color matched fairly well, the texture did not. Brush painting versus airbrush, I think was the issue.



7: The lettering partially erased.



8: And completely erased. The results are much better than my previous attempts.

Using eBay, I located the individual who had bought up the stock of the defunct IHC company and was selling it both on eBay and a separate website. I broke down and bought three more coach cars. Know that Carl's "erasing" technique would be valuable information, I "erased" the names and numbers. This worked much better than the previous methods. I stole all the special parts (the #508 Kadees, the Adair Shops weight kits, and the interiors) from the older three cars and put them on the new cars.

Finally, the interiors of the four coaches on the City of Miami were not all the same. (See

the sidebar for the consist). On the practical side, the differences don't show on the outside, as the window arrangements remain the same.

The differences are as follows: All four coaches have unique names and numbers (covered by the renumbering and naming I did). The Camellia has a slightly different design from the other three. It has eight fewer passenger spaces, four seats. It had a nurses quarters, and it was for women only. On the inside of the standard coach, there was a small lounge at each end of the car and revenue seats in between. One lounge was for men and one for women. I decided that, for now, changing the interior kit isn't worth the effort. I can always come back and change that decision later.

Drumhead

The IHC c observation car did have one detail wrong. On the rear of the observation car is a red lens, as if some sort of light was to shine there. The City of Miami had a uniquely shaped drumhead in that position. There was no correct version of this drumhead commercially available.

While the IC streamliners book has a nice photo of the correct drumhead, scanning it does not work. The scan is too pixelated to be usable. Fellow IC modeler Todd Brinkmeyer found the digital image he had made up for his decal set and was nice enough to send it to me.

Using Photoshop, I made up several versions of the drumhead, with slightly different yellows and with slight variations in size, about 10% between sizes. I printed all the variations onto a half page of card stock. Using a brand new #11 blade in my X-Acto knife I cut out the ones with the best matching yellow color in

different sizes. Holding the different heralds up to the car using tweezers, I picked the one that looked the best.

I opened up the car, and it was easy enough to pop the red lens. The problem was that this left a hole in the car. While the drumhead will cover the hole, there is almost nothing left to glue it to. I lined the inside of the hole with a small piece of Scotch tape and sealed the car up. Next, I took some of the glue from the interior weights and added it to the hole in the rear of the car. After I had built up enough, I used some spare card stock to make sure it covered the entire hole evenly. I found that the car had to remain with the rear end held straight up while the glue set. My car cradle and a bunch of hard-backed books made this possible. After curing for several hours, the plug was large enough to allow using super glue to attach the drumhead to the rear of the observation car.

Wheel and coupler fixes

And so, I thought that the cars were done. Well, it was during the first attempts at doing video on the “completed” train that I found out that I was wrong. A couple of things turned out not to work correctly. One was the couplers. Turns out that



9: I began removing the air line for the new body mount coupler kit.

the #5/508 truck-mounted couplers were about 25% too low. This caused them to bind against turnouts in the track, and also to disconnect from the engine at the least amount of interference.

The second problem was that the wheelsets I installed did not turn freely



10: Next I remove the ridges along the edge of the body.

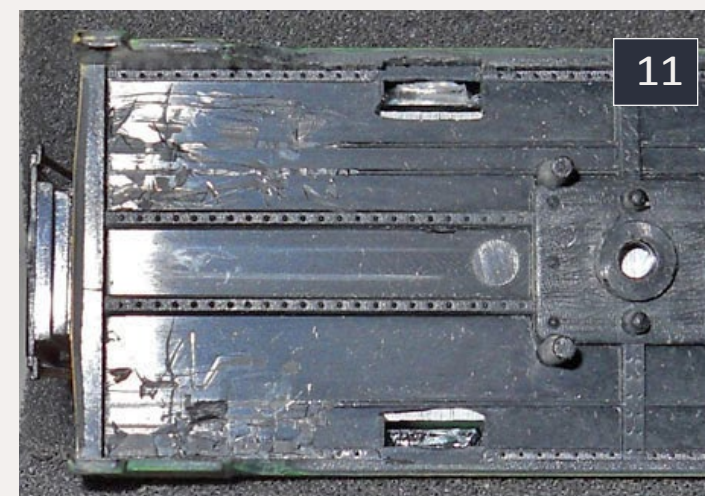

11: The body of the car is now ready for installation of the coupler kit.

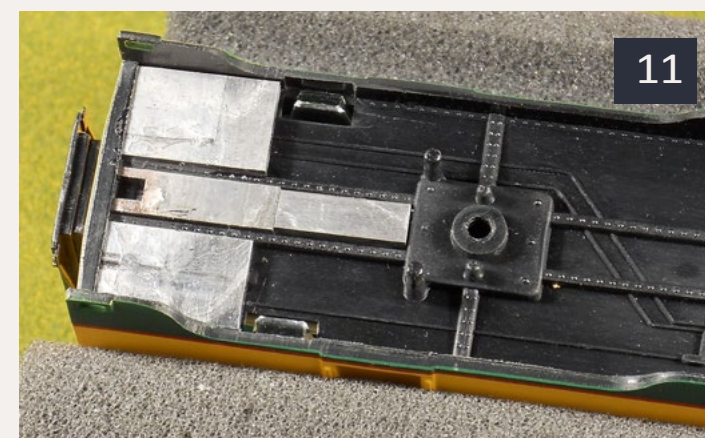

12: The first part of the coupler kit is installed onto the car. Use the cement supplied with the kit.

enough, causing problems. I decided to try the Intermountain wheelsets. The Intermountain wheelsets took some doing to run down, but I did find them, and that solved my problem.

Two solutions to the coupler problem were available. The first would be to replace the #5 Kadees in the #508 Talgo Bolsters with #27 or possibly #147 Kadee couplers. The second is a body-mount solution offered by Adair Shops. I decided to go with the second option.

After I had assembled the Adair Shops kits, the requisite number of #5 Kadee couplers were recycled from the #508 bolsters I already had. I also purchased two new tools I needed, a 4-40 tap and tap wrench and a #17 X-Acto blade. I started with a spare car to get a feel for how these body mount couplers work and how to install them.

You can start with either the coupler box or the car bottom. For the coupler box, starting with the cover with sides, use the 4-40 tap to add threads through the coupler mounting box. Assemble the coupler mounting box using the #5 Kadee coupler and the brass screw supplied with the kit.

On the body, I use the #17 X-Acto blade to remove the air hose lines from the bottom of the cars where the metal plates are to go. Create a smooth surface for the glue to adhere to. The hardest part is the raised line along one edge of this area. This is a cut and fit on the bottom of the car until the plates fit into the slots available (10-12).

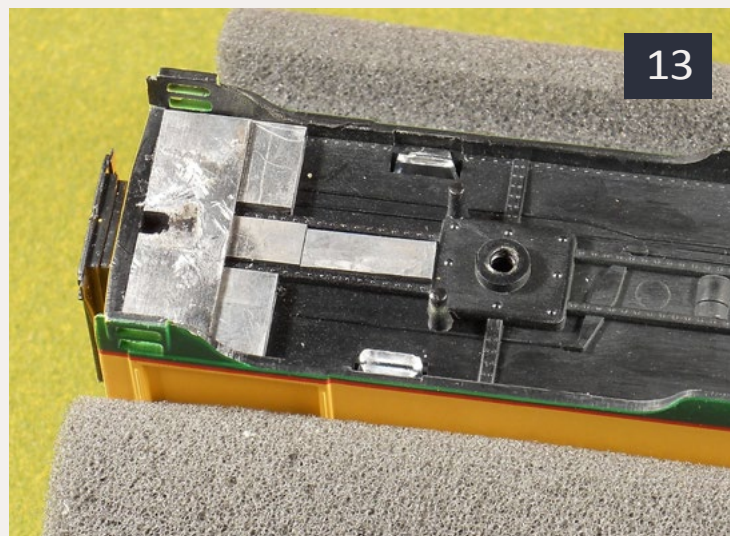

13: The second part of the kit has been added

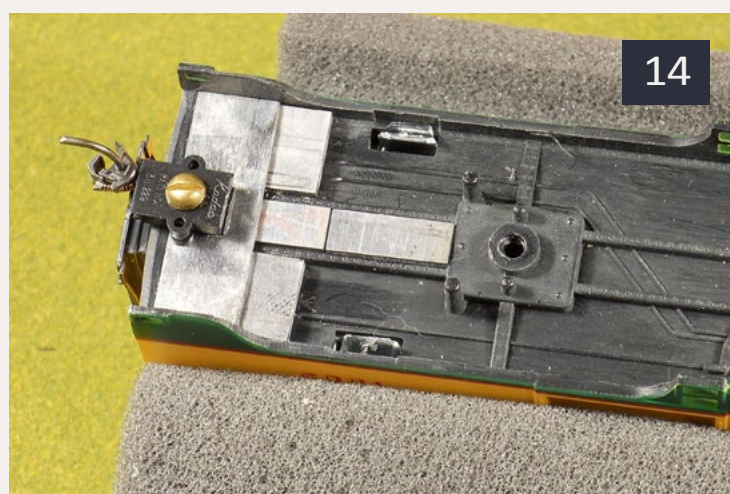

14: The Kadee #5 coupler has been attached to the body with the brass screw supplied with the kit.

Then glue in the metal plates in layers with the supplied glue and finally the coupler boxes. Be sure to drop the end of the brass screw into the hole left in the metal plates (13-15).

Most of the time the coupler height came out correct, but every so often one will be a little too low. There is no way to raise it with the kit supplied. Since these are body-mounted

couplers, I hit upon the idea of using small washers between the truck and the body to raise the body. This also had the benefit of bringing the body roof ends back into alignment as well. I also found that I had to swap out all the truck mounting screws that came with the kits for longer screws.

The engine

The City of Miami was powered by a single EMD E6A 2,000-horsepower (1,500 kW) diesel passenger cab unit.”

No vendor was offering a prepainted engine, but LifeLike was doing an E6A under their Proto 2000 line. I picked up an IC #4003 on eBay (they were no longer available in stores). I then contacted LifeLike and bought an undecorated shell for the E6A, intending to decal and paint it myself. The undecorated shell I purchased had no Mars light, which was prototypically correct for the City of Miami engine.

Working with another fan of this train in 2004, we were trying to build some decals or stencils for the engine. His for an N scale version, mine for HO. I was never completely satisfied with what we came up with, so the engine went back into the storage box.

In March of 2010, I was searching the web and came across Streamstyle Graphics, run by Todd Brinkmeyer. I discussed the



15: IC E6A 4000, the engine for the City of Miami.

project with him by e-mail, and came to the conclusion that I needed to acquire some parts to get where I wanted to be. My intention was to have two shells for the one engine and switch them back and forth to run two different trains. Todd convinced me that a complete and proper City of Miami paint job included the trucks on the engine, which would be the wrong color for the engine if it was running the IC shell.

I needed another E6A engine with any shell on it. So, it was off to e-bay again. Within about a month or so, I had acquired a Seaboard E6A. The IC E6A #4003 was now to go off and form the nucleus of a Panama Limited train.

While Todd was an expert at painting certain color schemes, he had no ability to do any DCC work on the engine. I went to a local train hobby shop (Happy Hobo Trains, Tampa, FL - RIP - 2011) and asked about getting someone to add DCC to one or more engines for me. I was put in contact with Carl Marchand (Suncoast Model Railroad Club) who would not only do that work for hire, but also does seminars at local train shows teaching others to do it. It took several months passing the engines back and forth to get the 7 engines I have done to date.

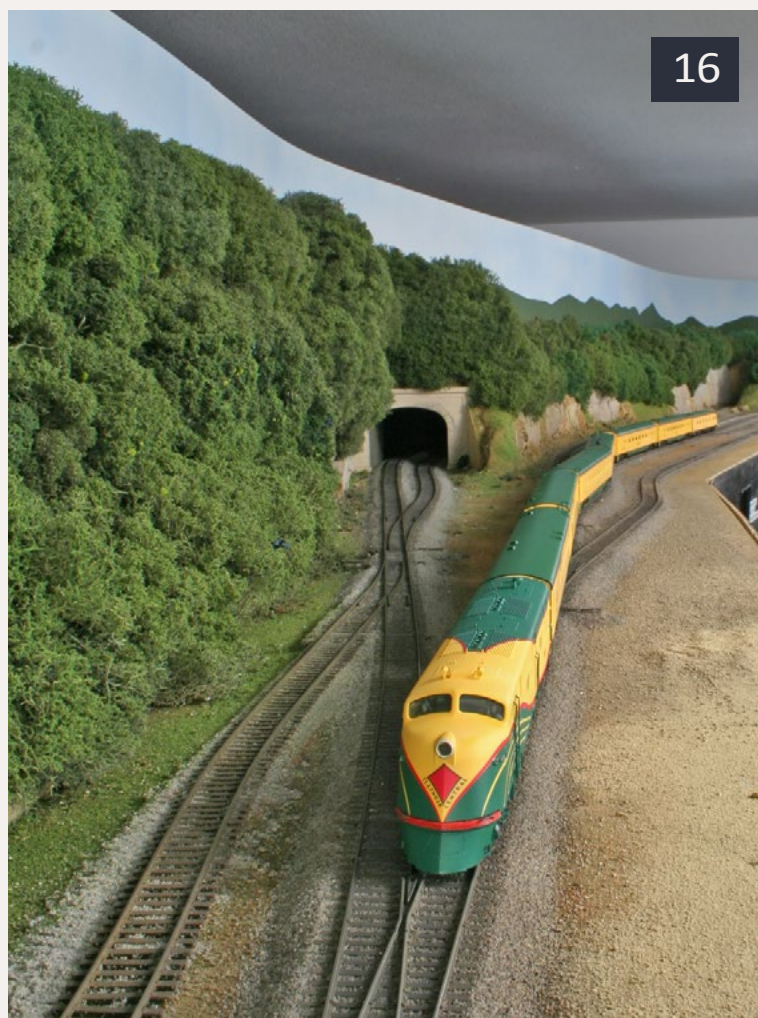

16: The City of Miami on its run to Miami.

I removed the front coupler and swapped in the closed door scoop instead of the open door one. The nice thing is that the Proto 2000 E6As shells came with both scoops. I created a decal with two copies of the number 4000 in scarlet for the engine. Todd is of the green lettering camp of the City of Miami and sells a decal set for re-lettering the whole City of Miami train over into that scheme.

So, in the fall of 2010, the newly DCC-equipped engine went off for a paint job, decaling, and a few details. The details included replacing all the roof lift rings, and adding a diaphragm to the rear of the engine. While the engine was being painted I added one more change (this is called scope creep). I asked Todd to replace the existing LifeLike coupler with a Kadee #5, based upon the experience I had with a fatigued LifeLike coupler on another E6A. Todd also added some cab detailing on the interior of the engine.

The engine came back, but the delivery service was not as careful as it should have been. Some green paint on the diaphragm had flaked off and the diaphragm itself had some edge separation. Using the paint formula supplied by Todd, I ran down the colors and mixed up some touchup paint and fixed the flaked off color.

The consist drawings are taken from *Illinois Central Streamliners 1936-1946*, amzn.com/1883089107

In Part 2 next month, I will go over how I detailed the interior of the cars.



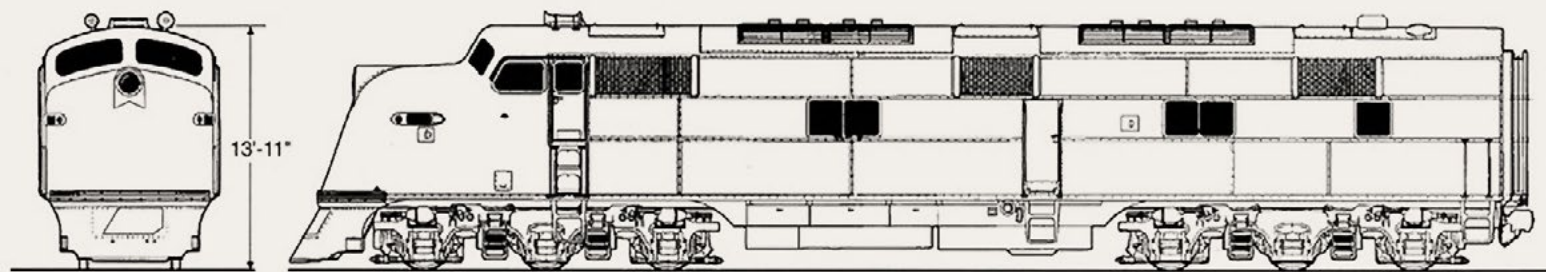

Drawing from [The Illinois Central Streamliners](#)

17: IC 4000 EMD E6A 2,000 hp diesel passenger cab unit (Chicago – Jacksonville),
FEC 1001 EMC E3A 2,000 hp diesel passenger cab unit (Jacksonville – Miami).



Playback problems? [Click to try a different version.](#)

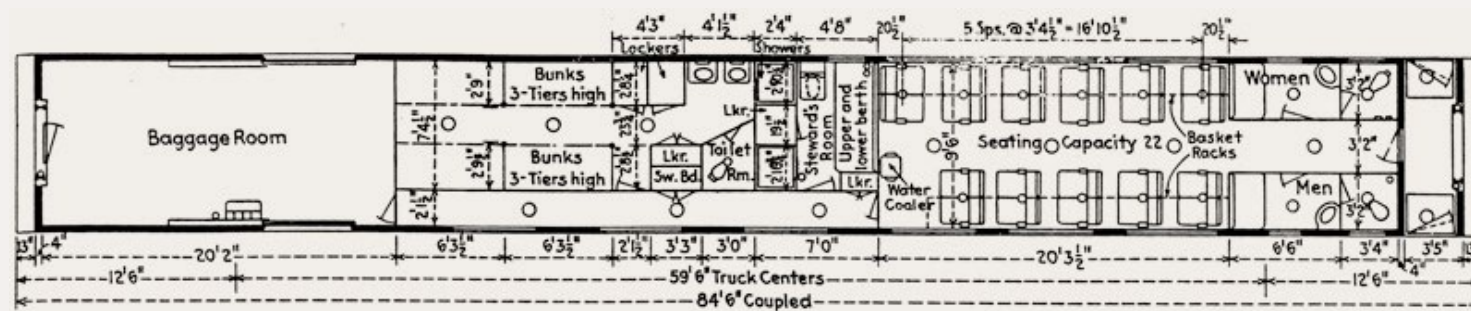

Drawing from [The Illinois Central Streamliners](#)

18: 1900 BOUGAINVILLEA baggage/14 crew dormitory/22 revenue seat coach combination car -Lot 6633/ Plan 7438 Retired 1971, scrapped. Floorplan of the baggage/dormitory/coach No. 1900, Bougainvillea, showing a 20-foot baggage compartment bunk beds for 12, along with lockers, rest room facilities, and a room for the Steward. Spacious public rest rooms at the rear of the car, to accommodate the 22 passengers.



Playback problems? [Click to try a different version.](#)

19

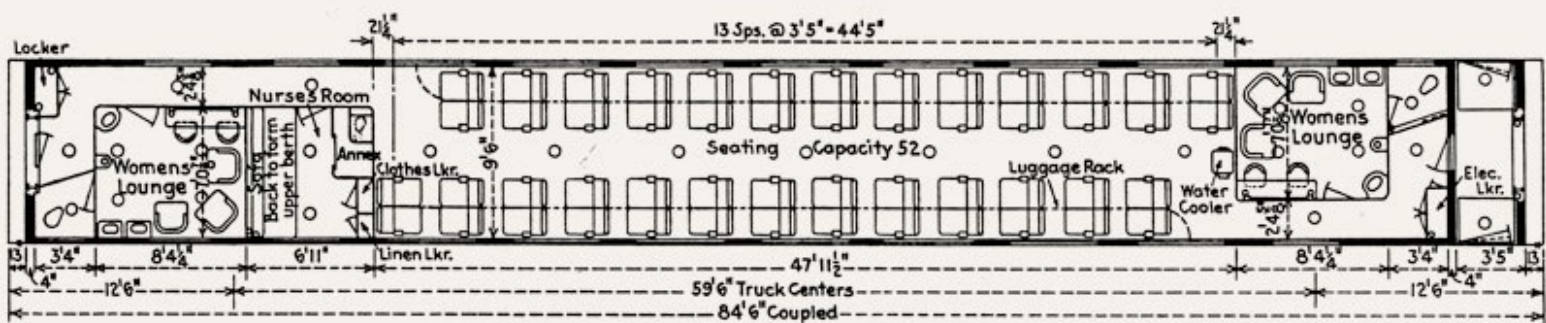

Drawing from [The Illinois Central Streamliners](#)

19: 2600 CAMELLIA 52-revenue seat coach with nurses quarters - Lot 6633/Plan 7439 sold to LA County in 1975.

20



Drawing from [The Illinois Central Streamliners](#)

20: 2601 JAPONICA 60-revenue seat coach - Lot 6633/Plan 7440 wrecked in 1971.



Playback problems? [Click to try a different version.](#)



Playback problems? [Click to try a different version.](#)



21



Drawing from [The Illinois Central Streamliners](#)

21: 4100 PALM GARDEN 48-seat dining car - Lot 6633/ Plan 7441 sold to Amendment Lounge, Shorewood, Illinois. Floorplan of dining car No. 4100, Palm Garden, shows standard seating for 48 passengers occupying roughly half the car and the kitchen the other half.

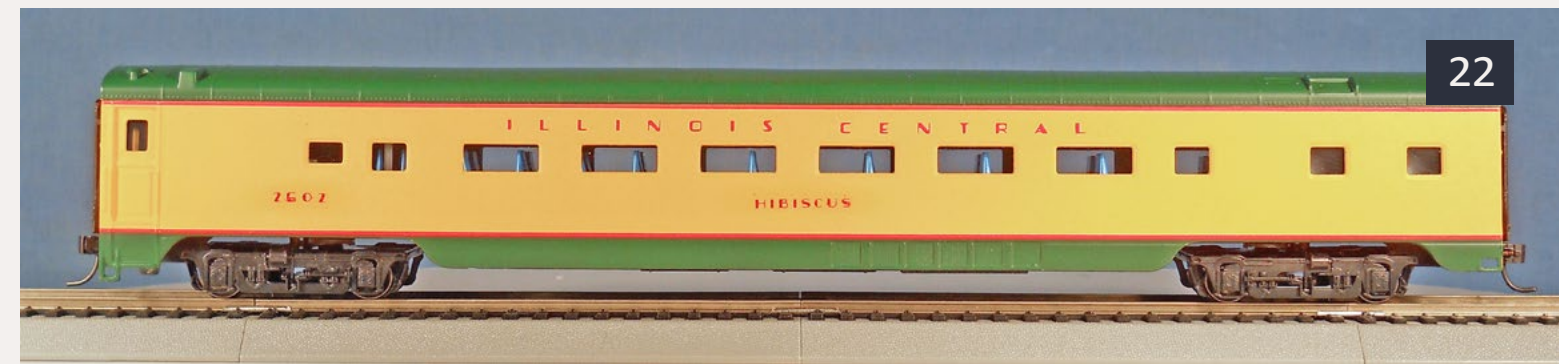

22



Drawing from [The Illinois Central Streamliners](#)

22: 2602 HIBISCUS 60 revenue seat coach - Lot 6633/ Plan 7440 sold to George Silcott, Columbus, Ohio.



Playback problems? [Click to try a different version.](#)



Playback problems? [Click to try a different version.](#)



23



Drawing from [The Illinois Central Streamliners](#)

23: 2603 POINSETTIA 60 revenue seat coach - Lot 6633/Plan 7440 retired 1971 sold to George Silcott, Columbus, Ohio.



24

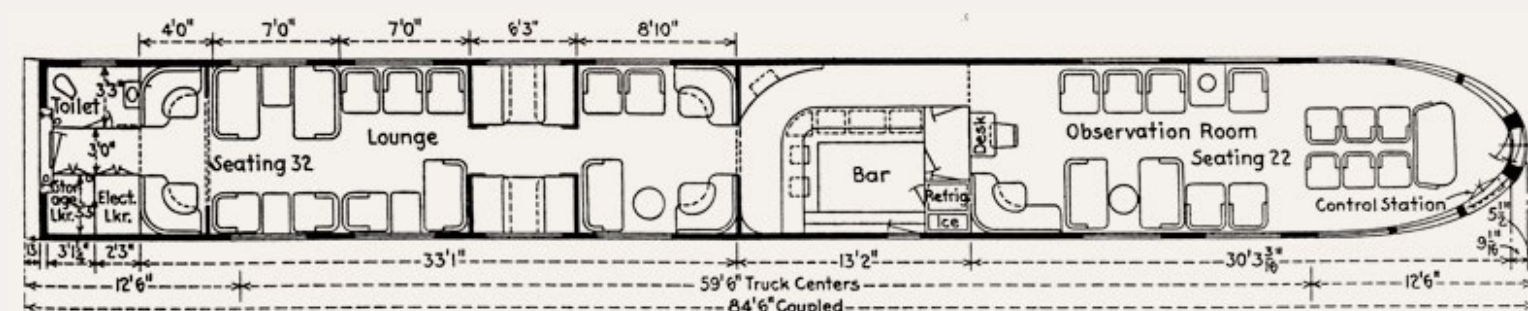

Drawing from [The Illinois Central Streamliners](#)

24: 3300 BAMBOO GROVE 32-seat tavern lounge bar 22-seat lounge observation - Lot 6633/Plan 7442 retired 1969, currently part of Wellington Station Clubhouse, Daytona, Florida. Floorplan of Bamboo Grove shows its three distinct areas, the lounge, the bar, and the observation room with its couch facing the rear.



Playback problems? [Click to try a different version.](#)



Playback problems? [Click to try a different version.](#)



James J Eager has spent the last 30+ years working in the IT field as a programmer and database administrator for a variety of major corporations.

He and his brother each recieved trainsets. This lead to a father and sons layout in the basement, Model Railroading Merit Badge, and a long term interest in model railroading.

In 1997, as part of a Jacksonville model railroad club, one of his structures was shown as part of the TV commercial for the Ronald McDonald House Christmas charity layout at the mall.

He has continued his interest in the Illinois Central Railroad, along with the B&O and ATSF railroads.

Parts List

TCS tcsdcc.com 1024 T4X DCC decoder

Streamstyle Graphics: streamstylegraphics.com
decals: IC 1940 City of Miami E6 #4000 HO

Coach Yard

IC-P-001 full width diaphragm UP yellow

IHC (348) ihc-hobby.com
Not the original, the person who bought the old stock

348-48331 Coach (4 units) & 348-20151 Coach interior (4 kits)

348-48332 Diner & 348-20152 Diner interior

348-48333 Observation & 348-20153 Observation interior

348-48334 Combine & 348-20154 Combine interior

Adair Shops (143) adair-shops.com

truck mount screws (14) (#6x1/4" Sheet metal screws)

143-8061 Coach weight kit (4 packs)

143-8062 Diner weight kit

143-8063 Observation weight kit

143-8064 Combine weight kit

143-8076 Coach, Diner, Combine body mount couplers (6 packs)

143-8078 Observation body mount coupler

Kadee kadee.com 380-513 - #5 couplers and coupler boxes

Hardware store

#6x3/8 sheet metal screws

#6 flat washers

Walthers walthers.com 433-23199 Proto 2000 Diesel E6A Powered – Undecorated

Intermountain Railway Company intermountain-railway.com 40052 33" Semi-Scale Wheels, 40055 for .100" wheels

Vitachrome Graphics vitachrome.com 768-5020 clear decal paper

Paint Formulas

IHC Green: Krylon 1 part Leaf Green; 1 part Hunter Green

IHC Yellow: Floquil – 1.5 part Railbox Yellow; 1.7 part White; 1.35 part UP Reefer Orange

Scarlet: Scalecoat SP Scarlet

Clear: Testors Lacquer Flat

Tools

4-40 tap and tap wrench

#17 X-Acto blades chisel blades for a #1 X-Acto handle.

Sprue nippers

Car cradle

Multiple tweezers, screwdrivers



Yes, it's a model

Model Railroad Hobbyist's monthly photo album



1: SSW 9398 runs light on the east valley line of the SP north of Roseville, California.

Chris Palomarez's HO engine was photographed on a module depicting the area at Sunset-Whitney, California. This photo is a great example of how prototypical weathering can make a moderately detailed locomotive look fantastic.

The photo was taken by Harry K Wong, The HO module was built to the Free-Mo modular standards by Christopher Palomarez & Gregg Fuhriman.



2: Kodachrome SP 8346 takes the point as it leads a general freight heading west towards Sparks, Nevada.

Gary Christensen started with an Athearn locomotive and fine-tuned it with snowplows, antenna, and see through radiator intake grills. Gary took the photo on a diorama he built to photograph his completed models. The model has the look and feel of an SP locomotive that has seen very little attention to its exterior appearance, which was typical of the SP in its latter years.

You can see more of Gary's work at theweatheringshop.com.

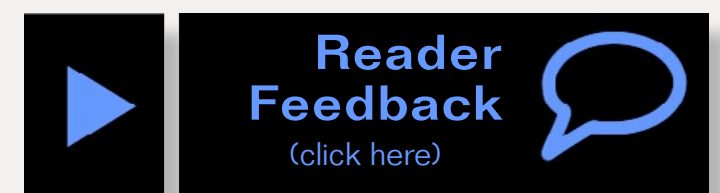



3

3: Ruphe & Tumbelle number 28 gets ready to take on water at Cresco summit on Rick Reimer's layout.

Loco number 28 is a Broadway Limited Imports C-16 which started its life in the D&RGW silver and yellow bumblebee paint scheme. Rick carved off all of the cast on piping and replaced it with wire loosely following photos. He repainted the locomotive in basic black, and lightly weathered it.

The light rail, light ballast, and weeds growing through the ballas add to the feel of a backwoods railroad.



4

4: Railgon 310046 sits alone on a spur as the afternoon sun filters down through the trees.

Dave Branum says, "I built this O scale Railgon from an Ed Reutling/Bill Ramey resin kit. I added the graffiti and weathering using acrylics."

We like the simple realism Dave has achieved with this model. The gondola isn't a "rust bucket" but has the look of a working car that's seeing good use, but isn't on its last legs. This kind of model is a lot more typical, and to get the best realism, we feel you should model the typical instead of the unusual.

We also like the light graffiti. We aren't fans of modern graffiti, since it is after all, vandalism – but if you're going to model graffiti, then the light application Dave applied to this gondola conveys the more modern graffiti look without obliterating the car.



5: It's almost winter in New England as Maine Central 453 eases across road to deliver a boxcar to a small industry not long after Guilford Rail's arrival on the scene.

The loco is an Atlas Alco C-424 and was photographed on Michael Cawdrey's layout located in Queensland, Australia.

Michael painted the background and attached LEDs behind it to create the distant lights. All the light in the photograph was provided by the LEDs.

We think Michael has done a great job of creating look of a chilly New England evening.



6: This HO scale Pacific Fruit and Produce Company by Tim Merkel consists of mixed media materials, with photo images & from web sources printed on 60-pound card stock.

Tim describes the construction process: "I laminated the wall graphics with white glue to a 9 x 12-inch building shape built from stripwood-reinforced foam core board. I used 220-grit sandpaper for the roof, accented with black spray paint and permanent marker tar seams.

"I made the vending machine, roof cooler, produce crates and loading dock deck all from printed graphics glued to wood shapes; the cooler has additional details from my scrap box. I made the loading dock roof from corrugated packing sheet laminated to paint stir stick wood, supported by bamboo skewers. I weathered the building with acrylic craft paint."

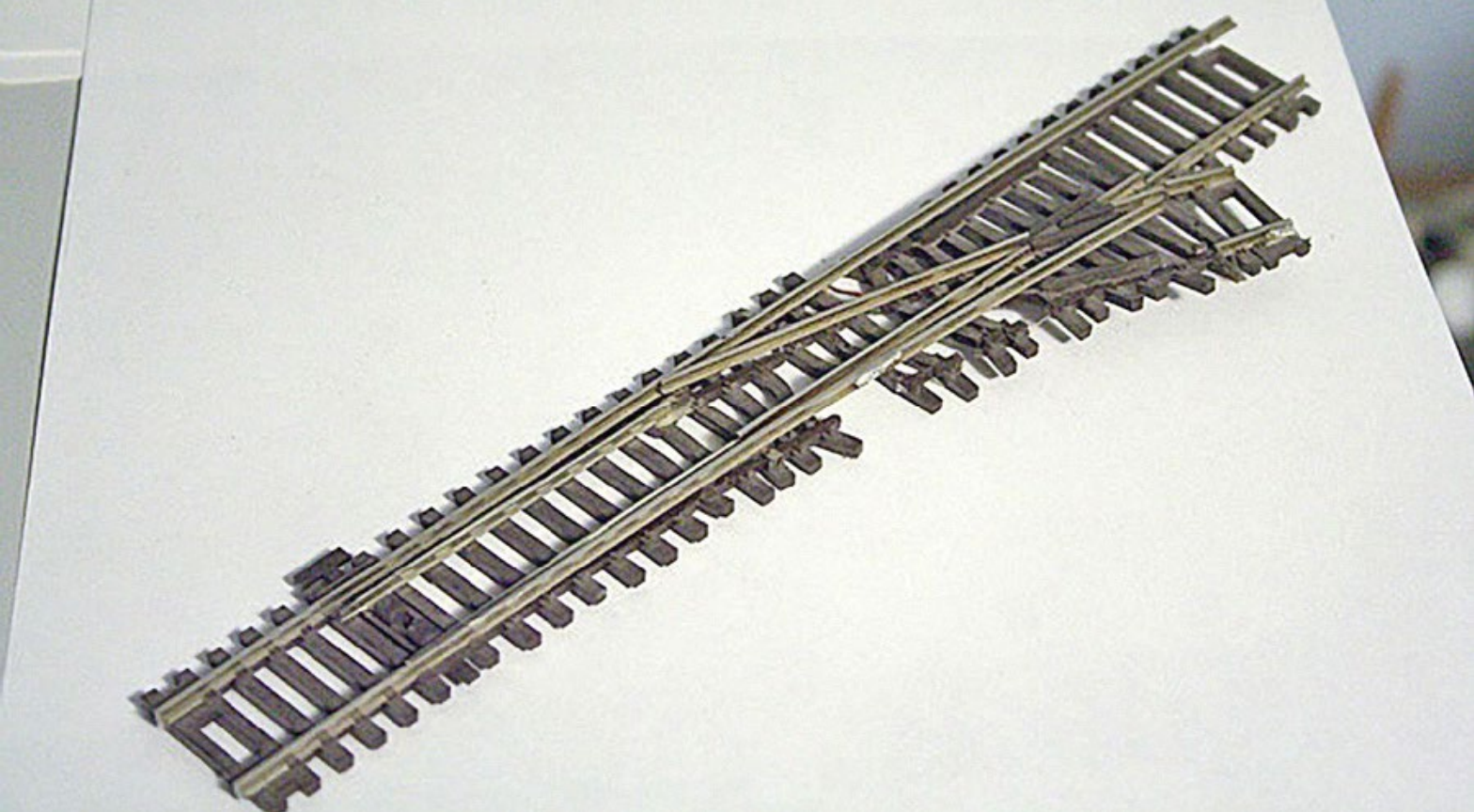

7: **Oops.** This Atlas code 83 turnout in Joe Fugate's staging yard ladder lost the competition with a halogen lamp. Joe used a portable halogen lamp in close to light the work area and *oopsie* ... (sigh).

▶ **Reader Feedback**
(click here)

Get your photo here!

Our *Yes, it's a model* monthly photo feature presents some of the most inspiring modeling and photos from the MRH website. If you'd like to get *your modeling* in our photo feature, just start posting your photos on the MRH website, especially in the [Weekend Photo Fun thread](#) created each weekend.

Many of the photos posted show HO modeling, but we'd like to encourage modelers in other scales to post on the MRH website as well. We don't want this to just be an HO photo feature!

For info on how to post photos to our website, [see this help how-to](#). You need to be an MRH subscriber to post photos to our website, and becoming a subscriber is free, [just fill out this form here](#).

Advertisement

END OF TRAIN DEVICE

FLASH CIRCUIT UNDER TRUCK

TRACK POWERED



READY TO RUN!

Bright Red Flashing Light!

Installs in minutes with no freight car modification required!

RE RING
ENGINEERING

Patented Technology - US Patent 7,549,609

Does not affect Load!

↓ Car without Load ↓

↓ Car with Load ↓



For video and more click here!



Advertisement



Structures of simple elegance ...

Made in the USA

ALPINE
— DIVISION
— SCALE
— MODELS

Click to Learn more...

alpinemodels.com



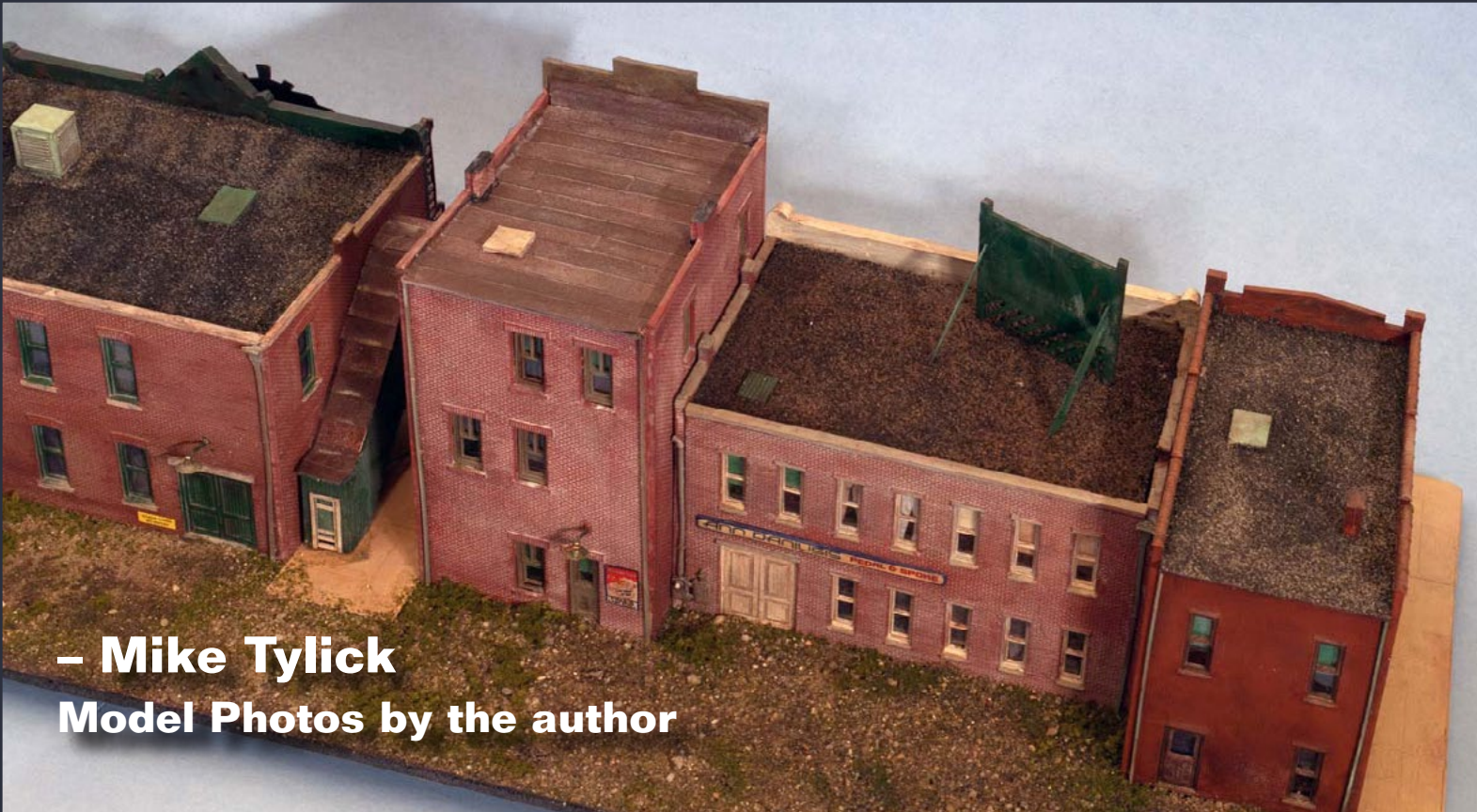

– Mike Tylick
Model Photos by the author

Tar paper and other roofing materials

Tar paper has a historical association with the crude shacks of the depression era. Tar paper shacks conjure up the impression of an individual just eking out a life. Although much more common in the south and west, tar paper sheds are still to be found. In fact, tar paper is still widely used today because of its excellent waterproofing qualities.

The technique that I used for modeling tar paper roofs was introduced to me by Art Fahie, owner of Bar Mills Models. Over the years I have taken his techniques and modified them to create my own. The process is quite simple, the materials required are inexpensive, and it can be done by anyone.



STEP 1: The supplies



1: Art Fahie of Bar Mills models taught me to spray the roofing material with an airbrush along with using a variety of colors. I use Walmart Color Place spray cans. These paints are readily available. I use only the flat paints which are available in gray, black, white, and rust.

I found that these colors meet most of my needs. The pigments are fine, but after a short time the nozzles begin to clog and to splatter. I discovered that I could use the paint splatter to my advantage. I invariably end up using all four colors in varying amounts for each roof.

STEP 1: The supplies *Continued* ...



2: I also use acrylic craft paints. These are widely available at craft stores, and are inexpensive. I stipple these paints onto the roofing material to add texture prior to painting.

I use the dry brush technique, eliminating most of the paint from the brush prior to stippling it onto the roof material. I also use a color that is in the family of colors that I want to have on the finished roof. These paints are great additions if you can't find the color that you want in a spray can, or to just add a little variety.

STEP 1: The supplies *Continued* ...



3a-3b: The tar paper that I use is either Bar Mills self-stick roofing or construction paper. I had run out of the Bar Mills self-stick paper on a project, and experimented with the construction paper. I was very pleased with the results and continue to use it. Here is a portion of construction paper has been painted, and is resting atop a piece straight out of the package.



Michael Tylick has built a number of smaller layouts of various types and scales over the years. Mike has been a long time contributor to Model Railroader, Railroad Model Craftsman, the National Model Railroad Association Bulletin, and other hobby publications. He has also delivered numerous clinics and presentations on various railroad and historical subjects.

He now works as a custom builder of railroad structures and rolling stock, and has recently formed RailDesign Services, for design and graphic aspects of model railroading.

STEP 2: Painting the roof material

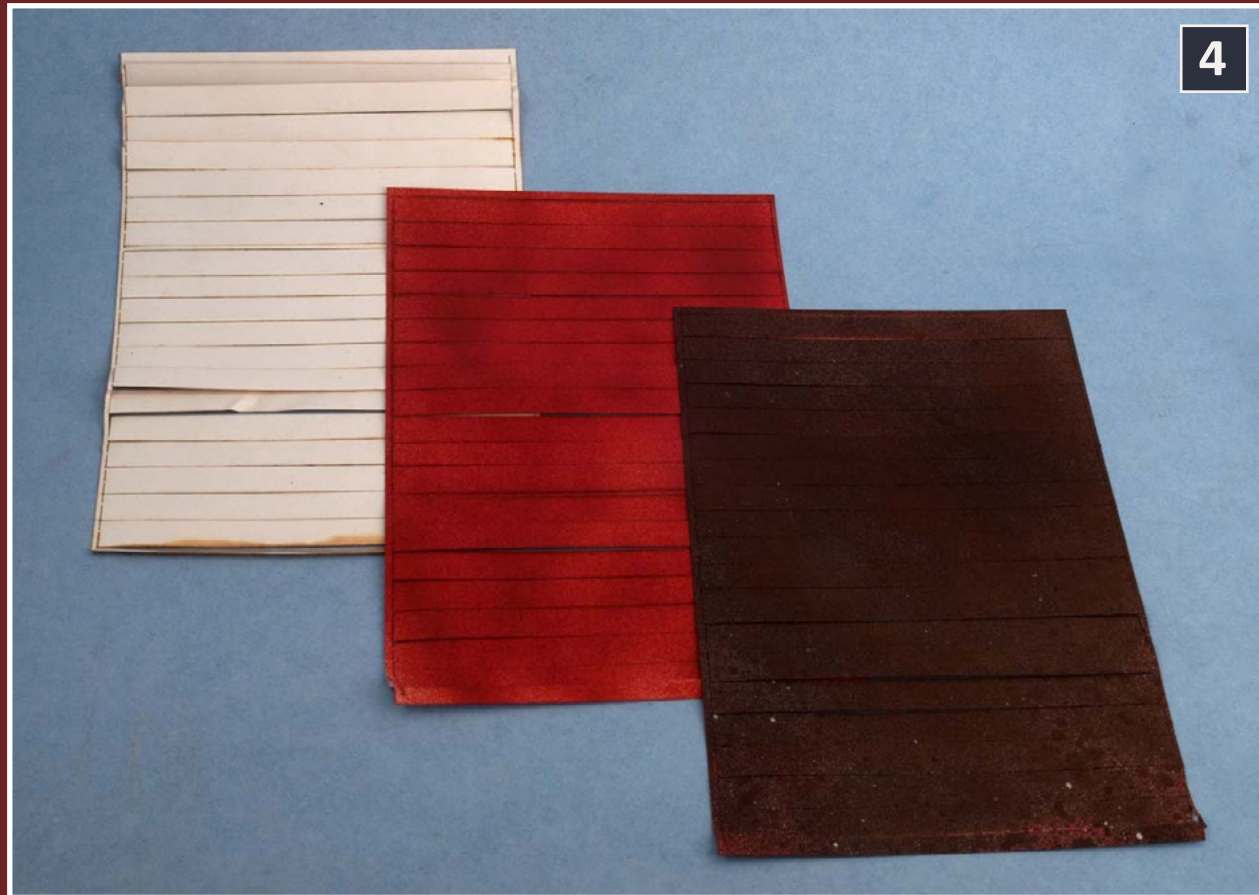

4: Here I am using the Bar Mills self-stick roofing material. In this instance, I began with the bright red prime coat color as my base. Once the base had dried, I over-sprayed with darker colors to achieve the effect that I wanted.



STEP 2: Painting the roof material *Continued ...*

5: In this example I have used two shades of green construction paper, primarily green and olive green. Here I use the splatter-spraying of the paint cans to my advantage. I discovered that the splatter creates a faux gravel texture on the roofing material.

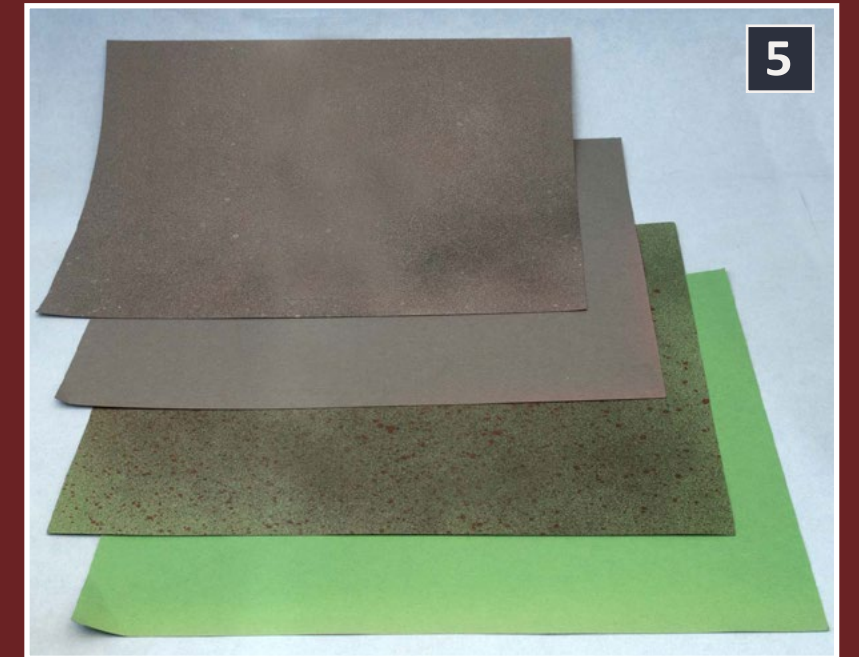

I use short spritzes to achieve this effect, holding the can a little more than a foot from the paper. This lets the paint dray a bit before hitting the surface, giving the sandy pebble effect. I also spray multiple times using the various colors. So instead of tar paper, I have created a rolled asphalt roof appearance.

Once the paper is ready for installation, a paper cutter makes short work of cutting out the rolls. If you don't have a paper cutter, a sharp X-Acto knife and straightedge work just as well.

STEP 3: Applying the roofing

6: Once the roofing material has been painted, it's time to begin installation. Here I am adding the Bar Mills roofing to the sub roof. In order to avoid a homogenous look, I use pieces in random order from different parts of the sheet.

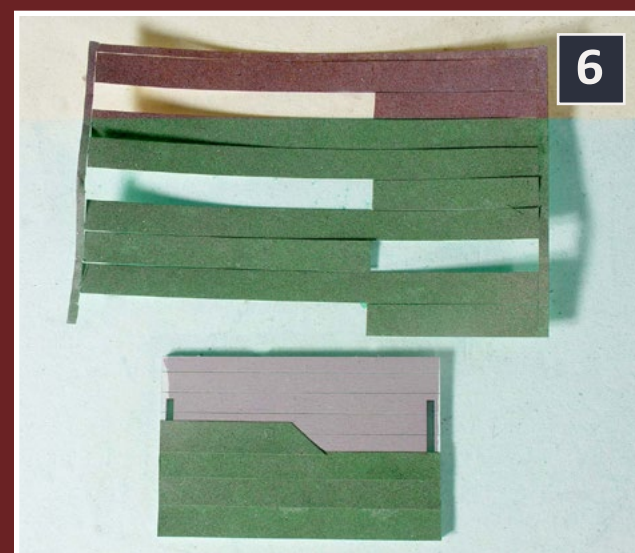

7: You don't need to use the same color roofing stock throughout the roof area. Here I have mixed in odd color pieces to create the appearance of a roof that is well worn, and has been patched.

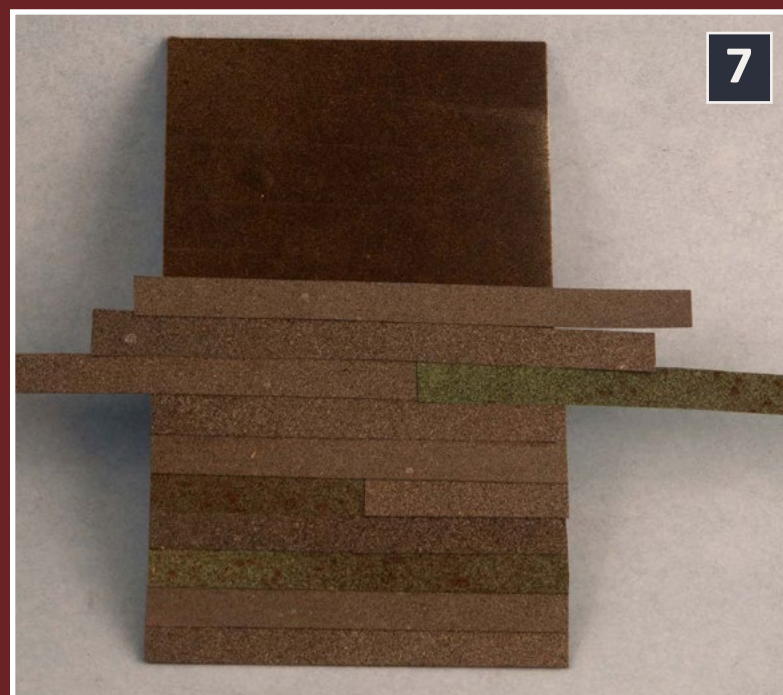

I use white glue to fasten the strips to the sub roof. A word of caution: the glue does seem to ruin the construction paper finish, so work carefully. Another option is to use student glue sticks. They are quick and neat.

STEP 3: Applying the roofing *Continued ...*

8: Here is the roofing material applied to a structure. For this structure I have also added a roof hatch which is glued over the completed roof.



The roofing material is trimmed slightly oversized and then lightly scored at the edge of the roof. The excess is bent upwards and glued to the walls. This serves as the flashing for the roofs. The added benefit is that it can hide any gaps and seals the roof from any light leaks.

9: This is a closeup of the roof on the scratch-built Ronceverte engine house. It was while working on this roof that I developed the construction paper method. Unless you are modeling a very new roof, apply the strips randomly from several sheets of sprayed paper.



STEP 3: Applying the roofing *Continued ...*



10: For the kitchen of a Bar Mills Sweaty Betty's diner, I used the self-stick roofing. The base color is red primer. The main structure in the upper portion of the picture has a gravel roof.

My experience is that the paper strips need to be applied to card stock or wood. If they are glued to a styrene roof, the piece will inevitably warp as the glue dries out, and expansion and contraction take place. I have not experienced this problem with styrene and gravel roofs that I will describe next.

STEP 4: Gravel roofs *Continued ...*

11: Another common type of roof is the gravel roof. With this method, the tar paper has gravel applied over it. The primary purpose of the gravel is to protect the tar paper from the elements.

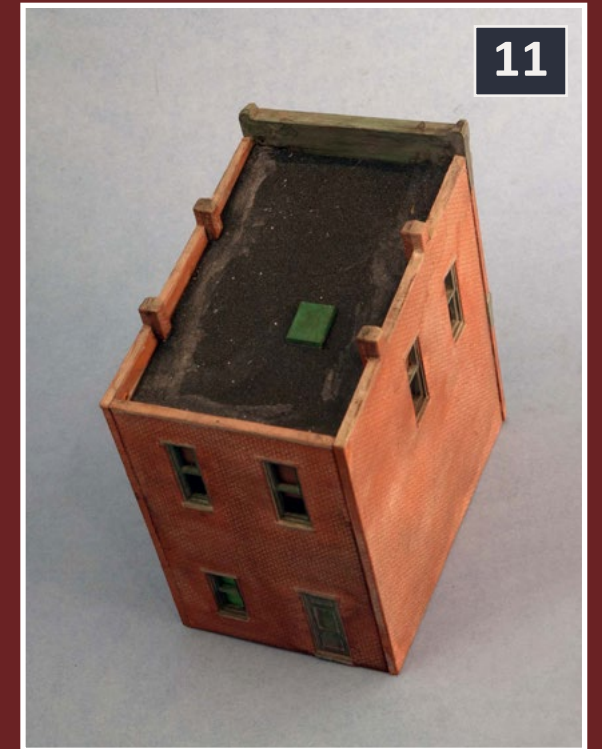

I begin with the raw styrene, adding the chimneys and roof hatch first. If you don't use a black or dark gray styrene, take time to paint the roof first. You don't want any unsightly white holidays showing through.

The roofing gravel I use is a mixture of Woodland Scenics fine cinder ballast and sand. The sand can come from any source such as highway sand, a beach, or sandbox sand from the home improvement store. Whichever you use, sift it and use only the fine particles.

Using slightly-diluted white glue, I paint it over the styrene, making sure that the surface is completely covered. Next I sprinkle a heavy coat of the gravel mix on top of the glue. The excess is dumped off on to a paper to reclaimed it for future use. Finally, I add a few drops of wet water so that the glue will soak into the gravel, and then I let it dry overnight.

STEP 4: Gravel roofs *Continued ...*

12: This is what the finished roof should look like. If you end up with any bare spots, repeat the process in the areas needed.



13: Here are several buildings with different roofing materials put together to create a city block. Notice how the a variety of roofs on the buildings adds to the realism of the scene. I hope that my techniques will encourage you to vary the roofing materials on your models. ☑

NEW for JULY

87-501, 60-501
Pacific Fruit Express (PFE) Ice Reefers 1950 to 1960
two sheet set



87-1421, 60-1421
RJ Corman (RJCC) Diesel Hood and Switcher Locomotives



87-1422 & 60-1422
California Shortline Per Diem Boxcars
Arcata & Mad River (A&MR), Amador Central (AMC)
Camino Placerville & Lake Tahoe (CPLT) Sierra Ry (SERA)
Stockton Terminal & Eastern Ry (STE)



87-1423 & 60-1423
Passenger Car Windows Gaskets
Black and Silver



87-1424 & 60-1424
Misc. Road Arrows, Parking Markers and Stripes



87-1425 & 60-1425
Misc. Road, Railroad Crossing and Pedestrian Markings



Microscale Decals © microscale.com MADE IN THE USA

Wish MRH came out more often than monthly?

The MRH website has lots of great content as well ...

click here



THIRD PLACE WINNER IN THE MRH \$500 CONTEST

A starter layout you can build for under \$500

– By Ben Kaur

A modest but solid foundation for a model railroad with lots of growth possibilities ...



1: While the author does not indicate a prototype or region for his track plan, this simple but very believable scene could be replicated on this layout if we assume a Milwaukee Road prototype. The bare-bones layout presented here can grow with more locos, rolling stock, and scenic details to easily replicate scenes like this one.

When I started in this hobby, I had nothing

in terms of tools. While it would be nice to imagine the average person already owning a



table saw, or a sander, or a power drill, I will assume not even the simplest of implements. Everything called for in the design keeps to the budget of \$500. I further assume regular pricing without any special sales, discounts or other consumer boosters in effect.

I assume that, all told, the cost of shipping and/or taxes runs roughly 10% of the bill, thus reducing our “real” budget from \$500 to \$450 before picking up a single piece of track. To establish spending benchmarks, I assume everybody has a Home Depot or an Ace Hardware in their neighborhood. Lowes, or True Value, or your favorite local stores are suitable substitutes.

The space

I start by finding a place to have my railroad. In my life, I have identified a quiet, containable, confined space where I could indeed build a layout. My particular room is roughly 11 feet square, with three doors and a window. Its primary purpose is for sleeping, but otherwise, it does not see much use.

Let us consider how we use our space. We could build an island layout in the center of a room, but we'd rob the room of any other functions it may have, and we'd have to consider investing in benchwork and legs strong enough to support perhaps 50 pounds per square foot. A layout around the walls would keep the room free for its primary purpose, accommodate the necessary load, and it requires only a minimal support structure. This approach has the bonus that the finished layout lends itself to a modular format.

Preparing the room

The windows are the easiest issue to address. Ultraviolet (UV) light is the single most damaging element on earth. It

irreversibly bleaches and leaches materials at a molecular level upon contact, decimating whatever resale your models might have had in a matter of months or even weeks. Hence, it should be avoided in the train room at all costs, even if it is just a temporary layout.

You can either box or fill the window, depending on the design of your curtain/blind assembly. Because I work the night shift, my window is already covered with a piece of sheet foam against the glass and a blackout curtain sandwiching the blinds against the inside of the foam. In the past, I have gone so far as to use sheet foam to simply box out the window with the curtains and blinds in place. This negates the need for a storage space to save them for when the room needs to be restored to its original configuration. The layout is then unimpeded by the window.

Doors are a bigger problem because we cannot block them so easily. A point to point layout nulls out the issue altogether, but I fully believe it's simply more enjoyable to watch trains move, regardless of operational scheme (or the lack thereof). The longer your track is, the longer you can enjoy continuous movement. A continuous loop thus enables a train to run for an infinite length of time and distance, hence, it is the most advantageous setup.

To accomplish this arrangement, we could utilize turnback loops or duckunders, and as an amendment to duckunders, removable bridges. Turnback loops require an amount of depth into the room equivalent to twice your minimum radius. I want as broad a mainline curve radius as possible, so loops are undesirable. Hence, the three doors will be managed by using two long, removable bridges.

The premise

My goal then is a shelf system consisting of 12" shelf brackets, 12" deep shelves and 2" Styrofoam at roughly 60" elevation,

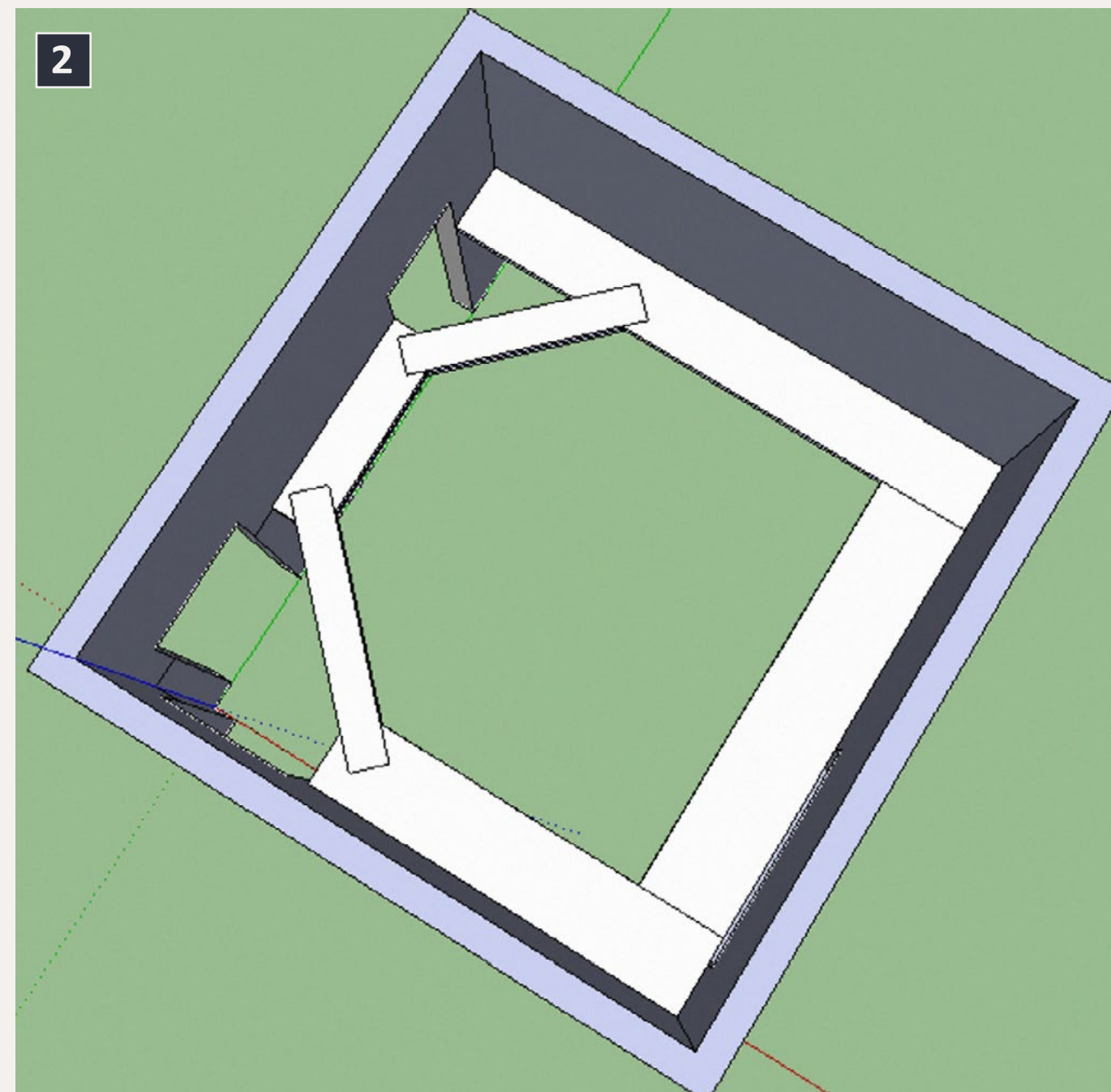

2: Room and benchwork view from above in SketchUp.

the height of my tallest furniture piece, in an arrangement that encircles the room. The long span that is the window will require a reinforcing beam set perpendicular and under the shelf, or it will ultimately sag. The bridges themselves will be 2" Styrofoam, with reinforcing layers affixed together with toothpicks and laminated with white glue either above or below the base piece. A single piece of 2" foam will show considerable deflection, but as foam is built up in layers, it stiffens quite well.

The plan

I used the free program SketchUp to plan out the benchwork placement in my room. MRH subscribers can download the full SketchUp room plan in this month's bonus downloads.

Building the infrastructure

My first tool purchase way back when was the Ryobi 5-in-1 battery-operated set, and having had that experience, I

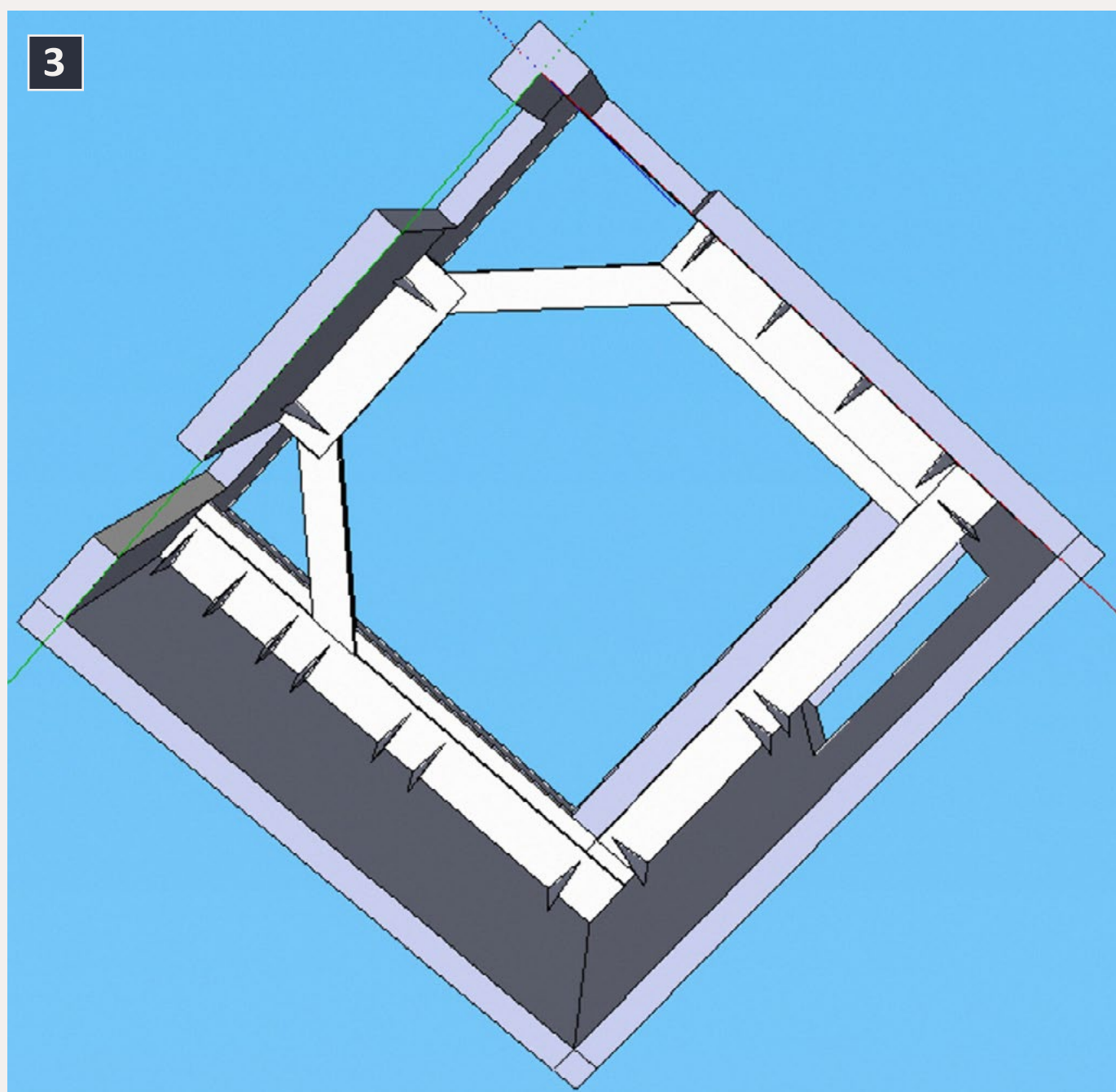

3: Room and benchwork view from below in SketchUp.

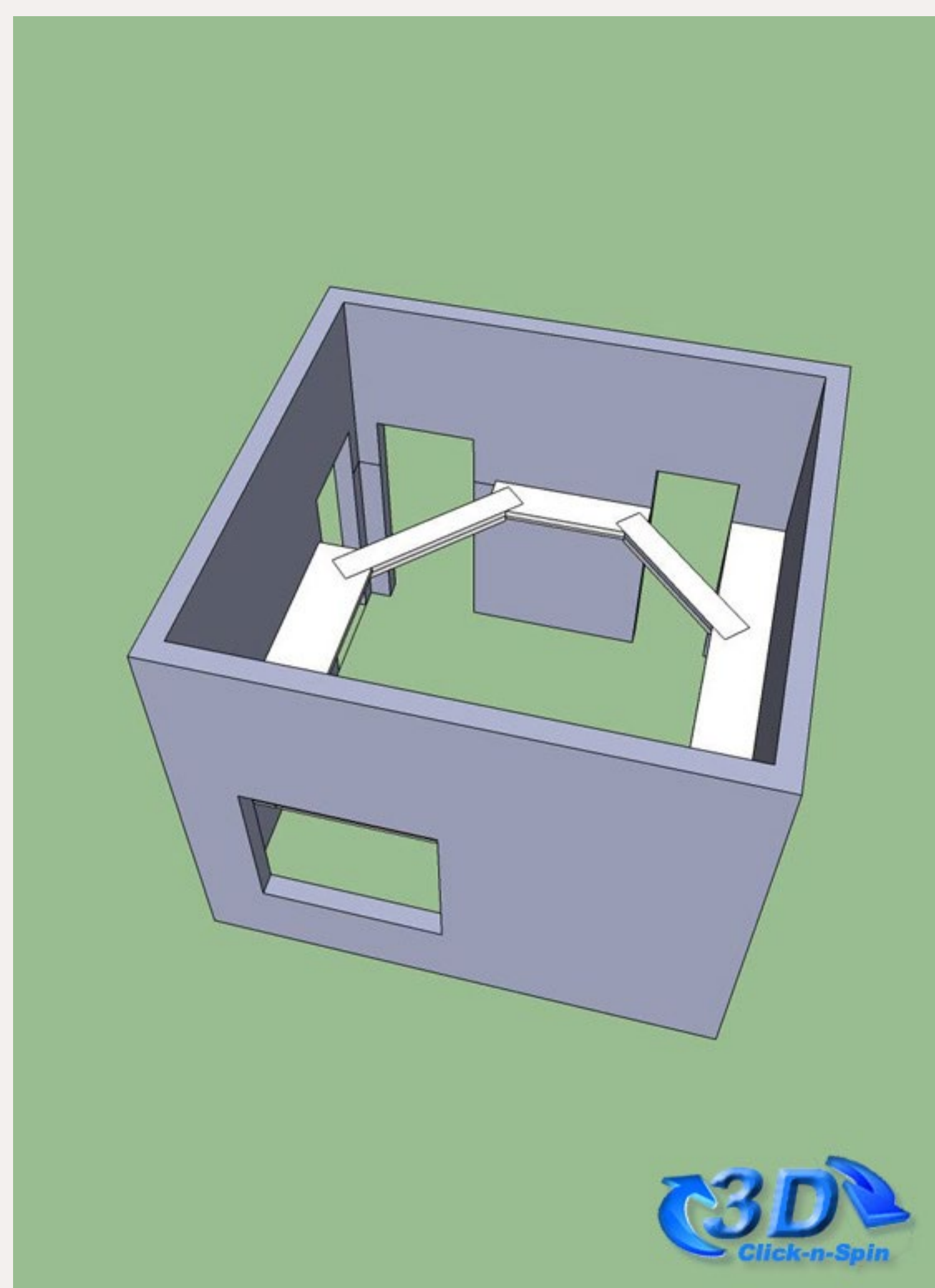

Playback problems? [Click to try a different version.](#)

recommend buying tools with power cords. So I bought a corded Ryobi power drill (\$39.99, Home Depot prices). You may need to pick up a drill bit index (\$19.99) or a masonry bit as well, but in my case I have drywall and I was able to use brass screws to make pilot holes.

The second expenditure is fasteners: a box of 2" brass screws (\$7.50, HD) and a box of 50 wall anchors (\$11.69). I'd add a stud finder with deep penetration and electrical detection (\$19.99) to guard against driving screws into power lines. Otherwise, my pilot holes were made by first driving a pilot screw into the wall and then inserting a wall anchor only if I didn't happen to find a stud. This work was entirely accomplished with my drill, the Phillips apex bit, and a 16" tape measure (\$8.48).

For shelving I selected 12"x14" metal shelving brackets for \$2.99 each at Ace Hardware. I ultimately needed 17. Make shelving from a sheet of 4'x 8' sheet of plywood (\$25.64) if your store will cut it down into 12" strips by whatever length you need to make it around the room. You may have to add a 2'x4' handy panel (\$5.98). One of my 6-foot shelves has to span the window, so I used a 1x3 to reinforce it (\$2.99) and a hand saw with miter box (\$7.96) to cut it. The handsaw will indeed cut the plywood, and while it may be a bear to do it this way, the savings is in the sweat equity!

We need a base underneath our railroad so we can model scenery that is below grade. While many will swear by only blue or pink fine-grain foam, I figure if white coarse-grain bead board is good enough for Woodland Scenics, it's good enough for me. Having used it more than once before, it's no better or worse a material than any other.

The shelves are 12" wide, but with 2" foam we could extend this width up to perhaps 24". I personally would not go much past 20" or even 16". In the shallow areas, my system will allow for a 2" base, while in the deeper parts, I have as much as 6" of depth below grade. My "bridges" across the doorways will consist of a foam 2x6 with a reinforcing foam 2x4 beam placed

Present Budget \$500

Description	Cost	Quantity	Sub Total
Tax/shipping [all project]:	Best Estimate: 10%	1	\$50.00
Ryobi power drill	\$39.99	1	\$39.99
Box of 2" brass screws	\$7.50	1	\$7.50
Box of 50 wall anchors	\$11.69	1	\$11.69
16' Tape measure	\$8.48	1	\$8.48
Metal Shelving Brackets, 12"x14"*	\$2.99	17	\$51.00
Lumber, 1"x3"	\$2.99	1	\$3.00
Handsaw with Miter Box	\$7.96	1	\$7.96
Foam Sheet 2"x4'x8'	\$16.98	1	\$16.98
Foam Board 2"x4"x72"	\$2.98	2	\$6.00
Foam Board 2"x6"x72"	\$3.98	2	\$8.00
Razor knife with snapoff blade	\$9.97	1	\$9.97
Plywood Sheet 15/32"x4'x8'	\$25.64	1	\$25.64
Plywood Handipanel 15/32"x2'x4'	\$5.98	1	\$5.98
Expenditures to this point:			\$252.19

Table 1: Initial purchases.

Description	Cost
Ryobi drill bit index	\$19.99
Stud finder with DP & ED	\$19.99
3-foot shelves [Each]	\$8.47
4-foot shelves [Each]	\$9.98
8-foot shelves [Each]	\$12.64
Rack shelf runners [Each]	\$2.00
Rack shelf arms [Each]	\$2.00
Total	\$75.07

Table 2: Additional “optional luxuries”, all at Home Depot prices.

vertically either below or above, depending on what my track arrangement will allow.

At minimum, expect to use one 4'x8' sheet (\$16.98), two 2"x4"x72" foam boards (\$2.98), and two 2"x6"x72" foam boards (\$3.98). I also purchased a razor knife with snap-off blade (\$9.97). I use it as a long knife, being very careful to not snap off the blade while using it.

At this point we have established a base in our room; the foundation for our layout is complete!

After purchases in table 1, the remaining railroad budget is \$247.00.

At this point we have \$247 remaining in our railroad budget to cover trains, track and a power system. This is a bit slim, but we can make it work. It should be noted that up to this point my system so far gives no scale; you can still pick any scale you wish at the track planning stage. As we put together the operational plant, I shall do my best to consider as many options as possible.

If you wish, you could stop now and take your \$247 and purchase any favorable train set and use the set track to build a crude point to point setup on this wall system, or perhaps remove the track from the layout and set the loop up on the floor to operate a continuous

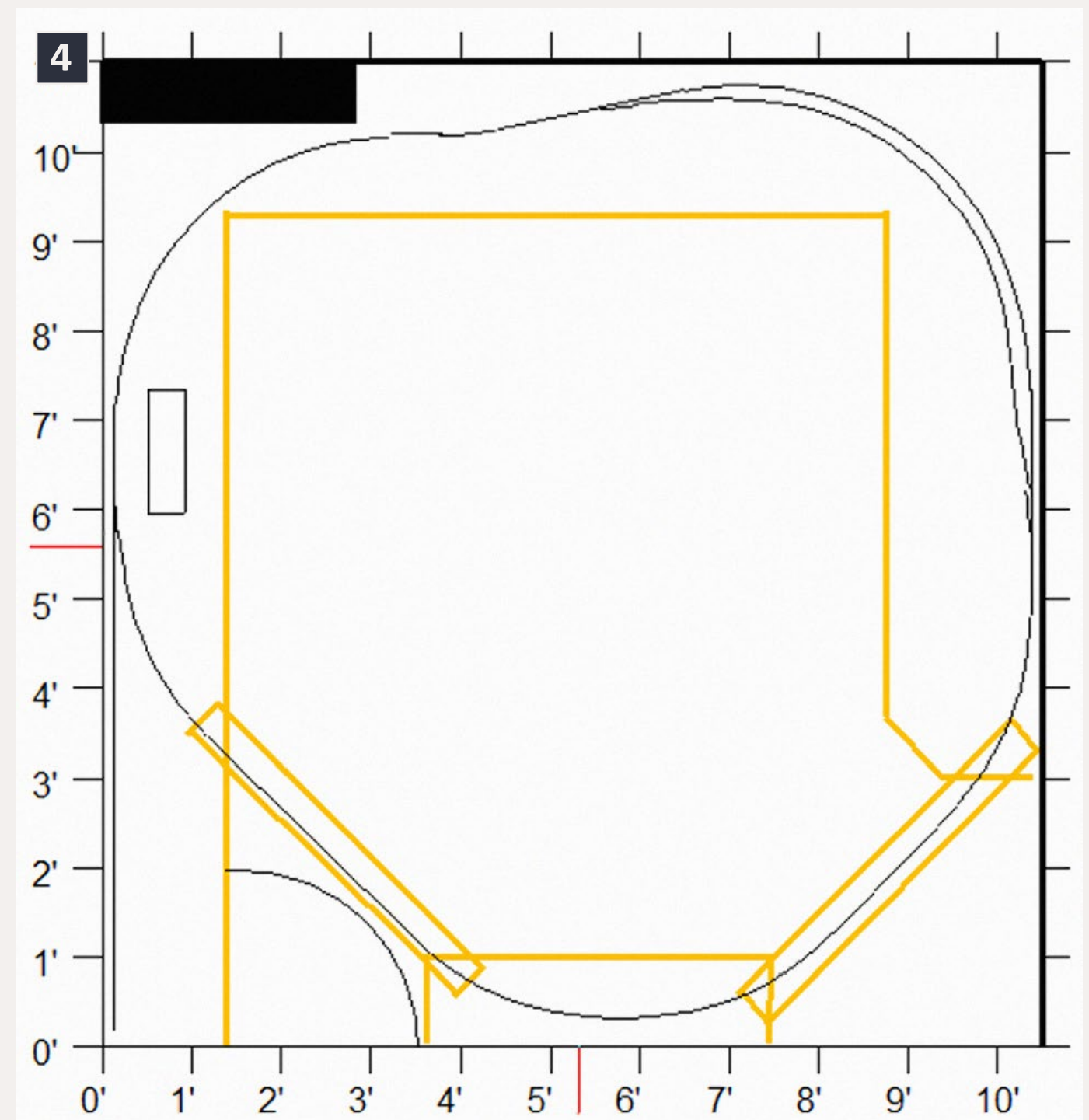

4: XtrackCAD first basic track plan attempt.

running train now and then. This is far less than ideal, of course, versus the "real" railroad we're, pursuing, so we'll move forward with another plan altogether.

Drawing up the track plan

I use XtrkCAD for all of my track planning needs. It has a learning curve to it, but in the end I have found it works very well for what

it does, and it's free. Drawing up a simple plan like this one will be a very useful learning experience, so I advise taking the time to do this. Learn it well now in the beginning, and it will pay off great dividends later when the plans are a bit more complex.

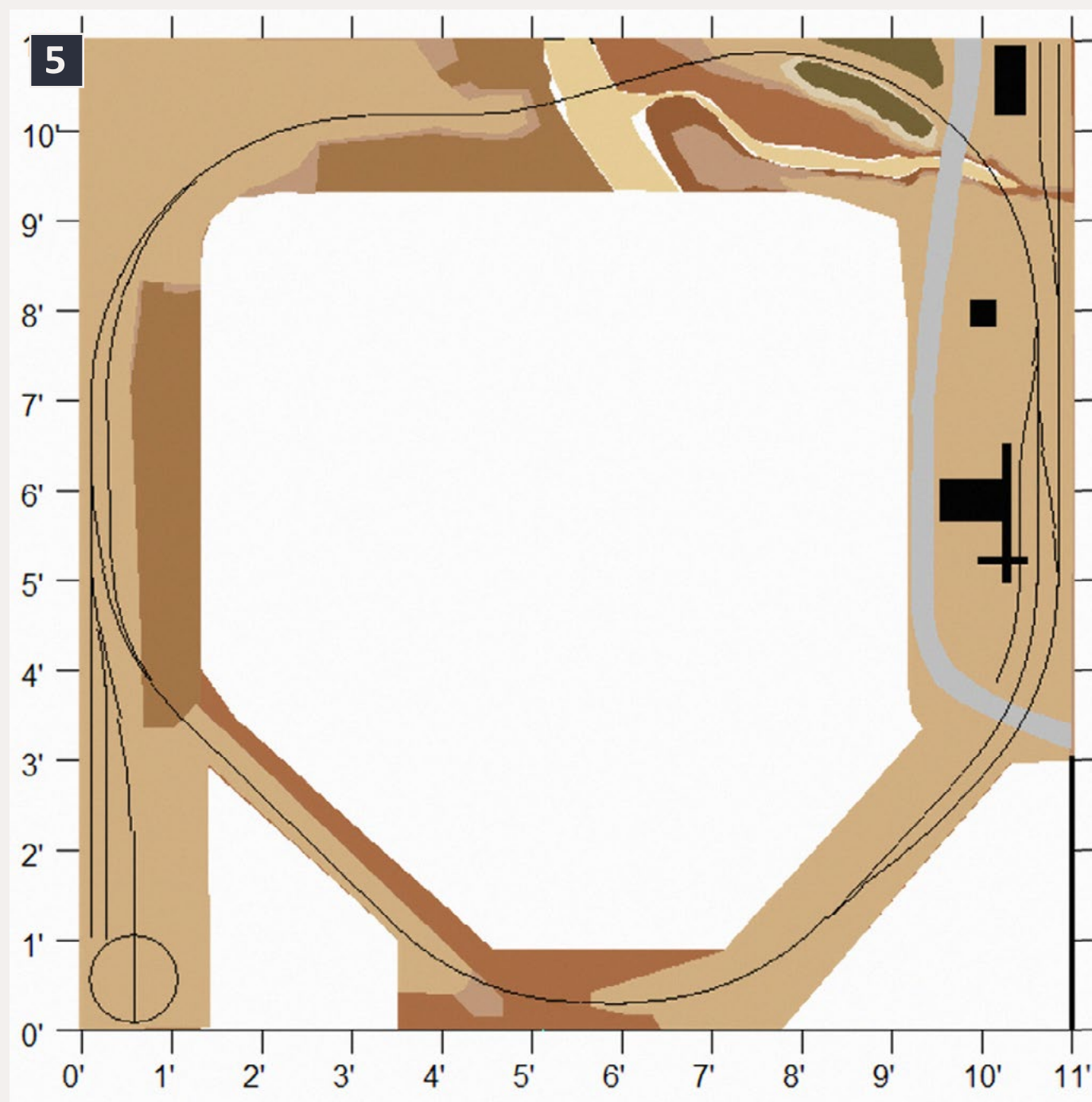

5: More refined XtrackCAD track plan with some scenic elements suggested. You can get the full XtrackCAD file in the MRH subscriber bonus downloads for this month.

Here is a beginning (4) that I have envisioned using my shelf system. This is a very simple plan indeed, but the priority is getting trains running first, and then coming back and embellishing the plant later. The curve radius has a 36" minimum, the switches are #6.

Here's one way (5) the plan could be embellished. This is my test layout, and I have decided to add a lower level narrow gauge loop to test and exercise my HOn3 equipment. It is but one possible arrangement, on a sizeable canvas that is truly limited only by one's imagination.

Roadbed

My roadbed of preference for overlaying foam is Midwest cork; a box of 25 3' strips will cost \$17.00 in N scale, \$30.00 in HO, or \$38.00 in O. For accounting simplicity, we'll assume HO cork is being used. The total distance around my room is roughly 44', so a box containing 75' should be more than sufficient for a single track route. If you're looking at G scale, you could skip roadbed or even carve the foam into a roadbed profile, yielding variation in the depth of the built-up grade.

To lay the cork, I use white glue (\$5.00, Ace) and straight pins (\$2.00, Walmart). You may desire a thimble (\$2.00, Walmart) to put the pins through the cork, but I find the butt-end of a

Description	Cost	Quantity	Sub Total
Midwest Cork (box)	\$30.00	1	\$30.00
White Glue, medium container	\$5.00	1	\$5.00
Straight sewing pins	\$2.00	1	\$2.00
Thimble/Sharpie Marker	\$2.00	1	\$2.00
Previous Expenditures			\$253.00
Expenditures to this point:			\$292.00

Table 3: Roadbed expenditures.

Sharpie marker (\$2.00, Walmart) has an ideal dimple for this task. It's further useful for driving toothpicks [1000 count, \$5.00, Walmart] to pin foam layers together, driving straight pins or rail nails through track tie holes to secure track, and it even doubles as a handy dandy drafting tool for laying out curves on the foam! You can use your utility knife or scissors to cut the cork, so you won't need any more tools to do this work.

Track

We could very happily model a "NoTrack" railroad at this point (see this spoof article in the April 2010, Model Railroader), but I do believe most people prefer to have rails! Flex track ultimately offers the most bang for the buck without hand laying, so it would do well to start learning how to use it as early as possible. We'll stick to Atlas track for this layout: it's widely available and inexpensive. From what I'm able to locate, track runs around \$5.00 for a 3' length.

My room, with its 44 feet of run, will need at minimum 15 pieces of flex, minus whatever length where we use a switch. We'll desire at least three switches, which will give us a spur and a passing siding. Atlas switches are available for \$15.00 each, and while they're not

Description	Cost	Quantity	Sub Total
Flex track, Atlas	\$5.00	15	\$75.00
Switches, Atlas	\$15.00	3	\$45.00
Zuron railcutters	\$15.00	1	\$15.00
Rail Joiners	\$2.99	1	\$2.99
Track Nails	\$2.99	1	\$2.99
Needle File	\$2.99	1	\$2.99
Previous Expenditures			\$292.00
Expenditures to this point:			\$435.97

Table 4: Trackwork expenditures.

the greatest in the long run, they will be suitable for this layout and the experience will be instrumental for making later turnout decisions. To shape our rails, we'll want a Xuron rail cutter (\$15.00), a needle file (\$2.99), and rail joiners to connect them (\$2.99).

Trains

It is only here at the end that I shall consider our operating scale. Our foundation that will provide a modest layout in On30, a decent sized layout in HO, and a rather generous layout in N. Now, I admit we are on a very tight budget at this point, seeing as how we only have \$64 remaining in our initial train fund and we don't yet have a power supply. But this is where frugality and innovation are most prudent.

We'll start with the larger scale first. Most everything is out of our budget range, but I was able to find a Bachmann On30 Trolley for \$50.00. Find a power pack under \$14, it doesn't have to be fancy, and you have a functional setup in O scale. Remove the trolley body and you could model a track inspection motor, a box cab, a small diesel, a one truck climax, or even a combination inter-urban.

Our remaining money is enough to purchase a set in either HO or N from Bachmann or perhaps LifeLike. While it will be a limited set, it contains two necessary essentials: a transformer and a locomotive. If a little more money were available and one looked around, consider Atlas Trainman (\$109!) or Athearn (\$109!). We could indeed budget these sets out by using the included track in conjunction with our flex track, thus reducing our flex track quantities as necessary, or selling the track on eBay to gain selling experience.

Structures and Scenery

Unfortunately, while we have lots and lots of wonderful space, we don't have much money to cover it! Then again, my premise with this layout is getting started, not getting finished, and this base should provide the potential for perhaps years of railroading

experience. For now, a bottle of acrylic craft paint or latex house paint and some local sifted dirt would very well cover the shaped bare foam. If money is available, a bag of Woodland Scenics ground turf and a bag of coarse clump foliage would be good additions to the inventory. I would not worry about ballasting track at this point unless one wanted to experiment with various processes, because the track plan will no doubt be changed once the initial lessons of this loop have been learned.

Conclusion

This concludes my Getting Started With \$500 Railroad. I feel my example is a real workable solution that offers a firm foundation for future growth. With an additional \$500 available, the case could be made for advancing to a DCC setup, investing in tools to maintain and upgrade couplers, obtaining more rolling stock, and adding a couple structure kits to the pike. Once more switches are available, a more interesting track plan could be considered, and as this plan develops, soldering tools for installing buses and feeders could be acquired as well.

In other words, these rails are far from the final destination!



\$500 Starter Layout Contest Rules

Here are the rules for the \$500 Starter Layout Challenge Contest we ran from August to November of 2012.

- You have a \$500 total budget.
- Assume basic tools: hammer, saw, drill, screwdriver, scissors, single-edged razor blades, soldering iron.



Way out west there's a man named Ben, who perhaps has been under the shadow of the Sonoran sun one season too long. The result is akin to throwing Dr. Seuss, Lewis Carroll, J.R.R.Tolkien and Attila the Hun together in one boxcar all at once, Old Engine No. 9 running hard with Dr. Emmet Brown at the helm! And while the railroad may not have been

or isn't as it was, the focus is on the railroad that is, seeing that it operates in a manner where no scale people should suffer the loss of life, limb, property or dignity. Either way, the focus here is on just keeping our cool, for today it is June 17th, and Benny has yet to turn on his personal AC unit. To play with trains, that alone is a fine privilege in and of itself!

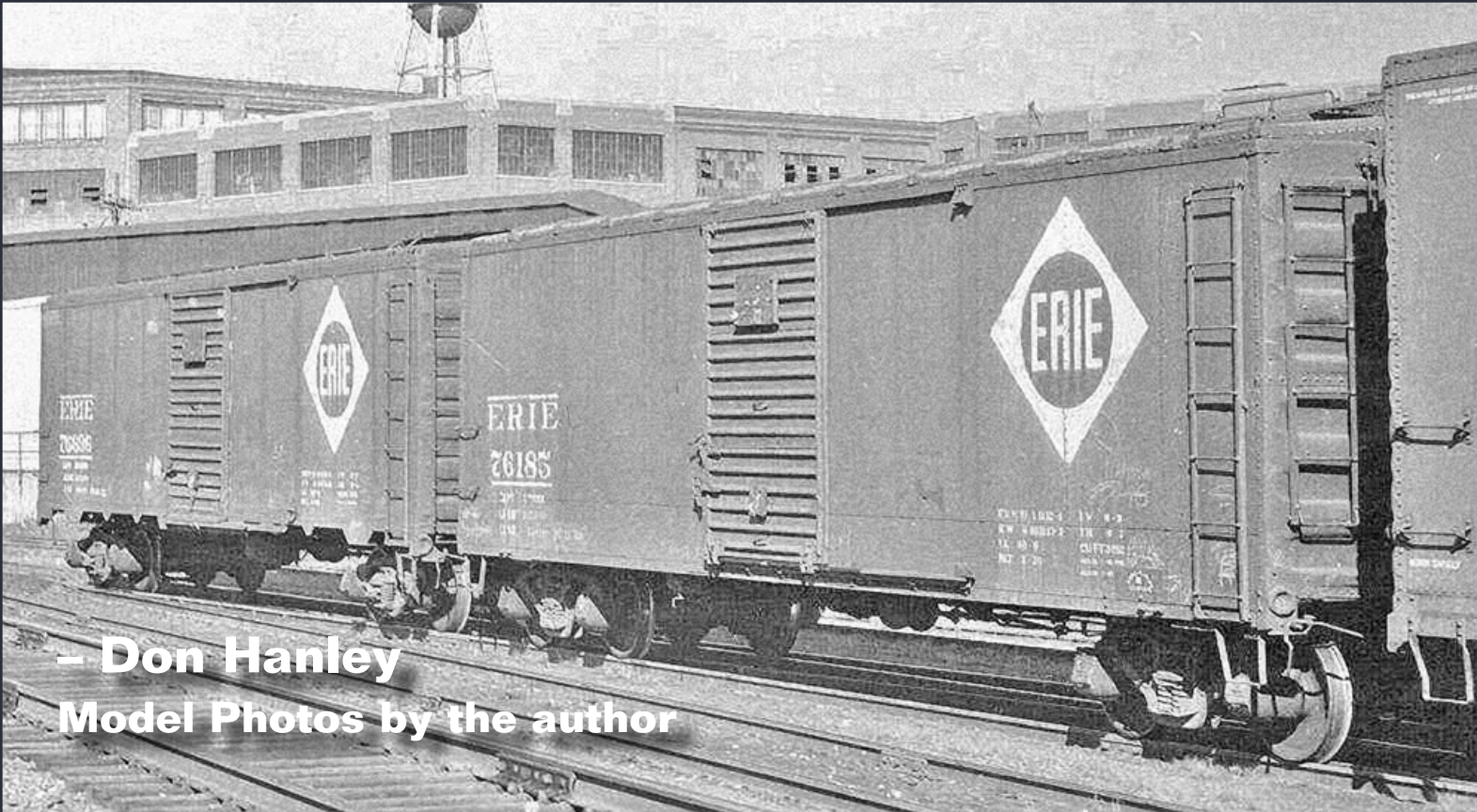

- Don Hanley
Model Photos by the author



The ERIE Railroad boxcars, part 4

We have finally come to the end of the journey. This is one of those projects that ended up much more involved than I initially anticipated.

In this part, I finish up the project with painting, assembly, and weathering of the cars. It has been a long journey, but I have learned a lot. My hope is that my experiences will help fellow modelers avoid making the same mistakes I did, as I explained in my lessons learned back in part 1.



STEP 15: Painting and Decals

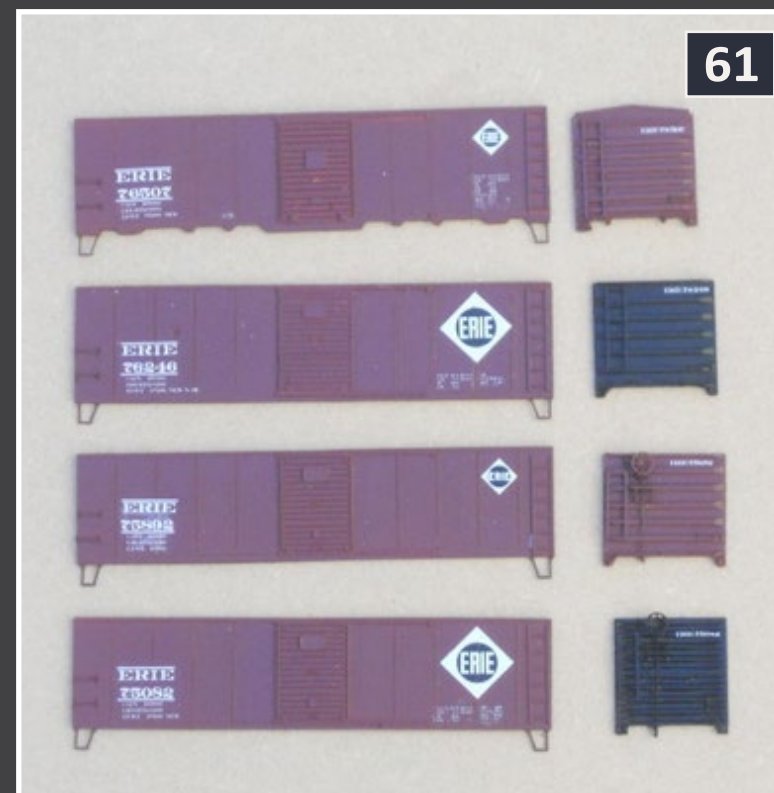

61: Until sometime in 1940, Erie boxcars were painted a boxcar red, including the trucks. I assume the underbody was black, but don't know for sure. Anyway, I prefer starting with a black underbody for weathering purposes.

In 1940 the Erie cars began receiving black ends and roofs. However, some cars painted in the mid-50s were all boxcar red. While the Erie is mostly known for the large 6' diamond logo, they also had a smaller 2' diamond logo that was used until around 1947.

Since I model the mid 1950s I need a portion of my fleet with the small diamond. The decals I used were from a new decal provider for me. They are Speedwitch Media decal set D127-Erie 1937 AAR Box Cars. These decals are the only ones I have found that have the correct small Erie diamonds. The decals have a very thin film and they give a beautiful finish. Read the manufacturer's instructions before

STEP 15: Painting and Decals *Continued ...*

using them. They can be contacted at <mailto:info@speedwitch.com>.

Since the decals are for 10'-0" interior-height cars, I modified this portion of the decal set. I cut out the offending interior height numbers and replaced them with the appropriate numbers from a Rail Graphics set that came with a Sunshine B&O M-53 Wagon Top boxcar kit. I changed only these numbers because, while you can't necessarily read the numbers, the eye can tell the difference between a two-digit and a one-digit number.

The paint I used is a relatively new product named Tru-color paint. I purchased it my local hobby store, which is more a custom-painting business than a hobby store. This is the paint they use; it's similar to the old Accupaint. The paint dries quickly and with a gloss finish, and decals can be applied after one hour. See their web site at trucolorpaint.com.

Before I began painting, I took time to wash the parts with Windex applied with a spray bottle and then scrubbed with a toothbrush. Windex is great at removing oily fingerprints from glass so I reasoned that it should do the same on the castings. After cleaning, I allowed the pieces to dry thoroughly. An advantage of using Windex or other glass cleaner is that the product dries quickly and leaves no soapy residue.

Now to choose the colors: Black was easy; I used TCP-40 Black. On to the boxcar red: my beloved Erie did not seem to be very concerned about

STEP 15: Painting and Decals *Continued ...*

having a specific boxcar red. In reviewing the *Erie/DL&W Color Guide to Freight and Passenger Equipment* by Morning Sun Books, no two photos appear the same color.

I know the colors can vary by daylight, film, camera settings, and so forth. Since Tru-color paint doesn't yet have a "boxcar red" in its formulation that looked correct to me, I mixed my paint using a 50/50 mix of TCP-11 Boxcar Brown and TCP-88 Engine Maroon.

What I ended up with is a good match for the photo of Erie 83014 as shown on page 46 of the book. I thinned the paint with about 20%-25% Acetone, and sprayed with an air pressure of 25-30psi.

I was very pleased with the coverage of the paint and its overall appearance. The gloss finish accepted the decals very well, and I used very little



Don Hanley is the Assistant Editor for MRH, and is interested in the Erie Railroad, specifically the Huntington, Indiana area during the 1950s. Don has had numerous articles published in Mainline Modeler and MRH Magazines describing various structures and rolling stock detailing projects.

STEP 15: Painting and Decals *Continued ...*

Walthers Solvaset to get the decals to snuggle down on the sides.

62

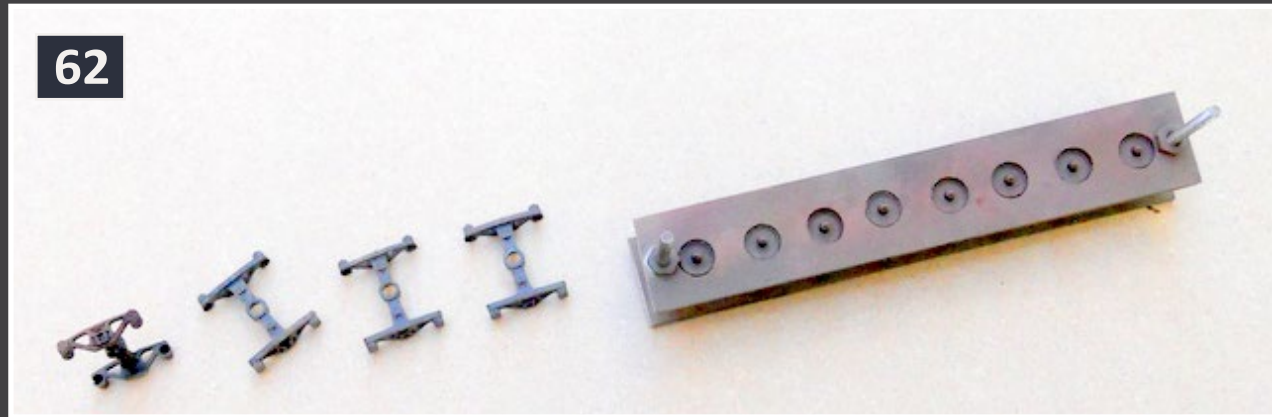

62: While I had the airbrush out, I also weathered the wheels and trucks. The wheels are placed in a small jig so I can weather them without getting any of the weathering on the treads. It eliminates the need to clean the treads afterwards.

I also weather the trucks without the wheelsets in place. This way I can get the coverage on the inside of the truck that I desire. After weathering, the trucks and wheelsets are put together and then set aside. The cars will be weathered without the trucks in place. I find this method works well. It allows me to weather the underside of the car without overspraying the trucks and wheelsets.

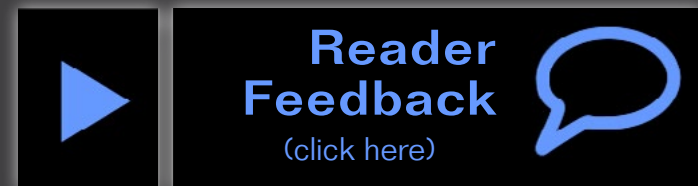

STEP 16: Assembly and Further Details

63

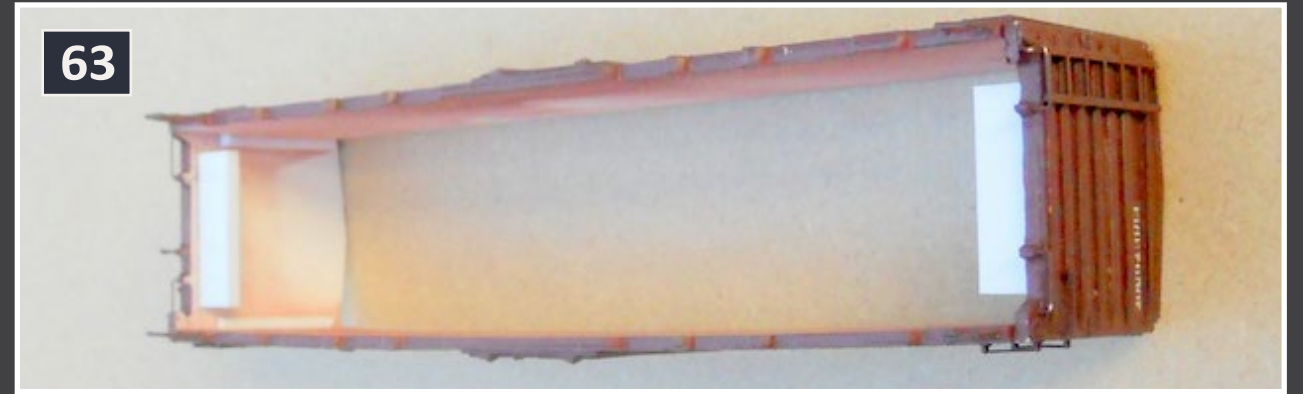

63: The cars are assembled just like any craftsman type kit, so I won't belabor the methodology. I did things a little different though, in that I cemented .100" x .250" styrene strips on each end. They act as a stop to hold the floor at the proper place on the body. There are no stops as on a standard kit. I also like to be able to remove the body from the underframe for maintenance purposes if needed.

64: I drilled and tapped for a 2-56 screw through the Kadee couplers. This allows me to screw the coupler pockets to the underframe and the underframe to the body with one screw. Prior to installing the underframe, I added two 1/2" nuts over each truck for car weights.

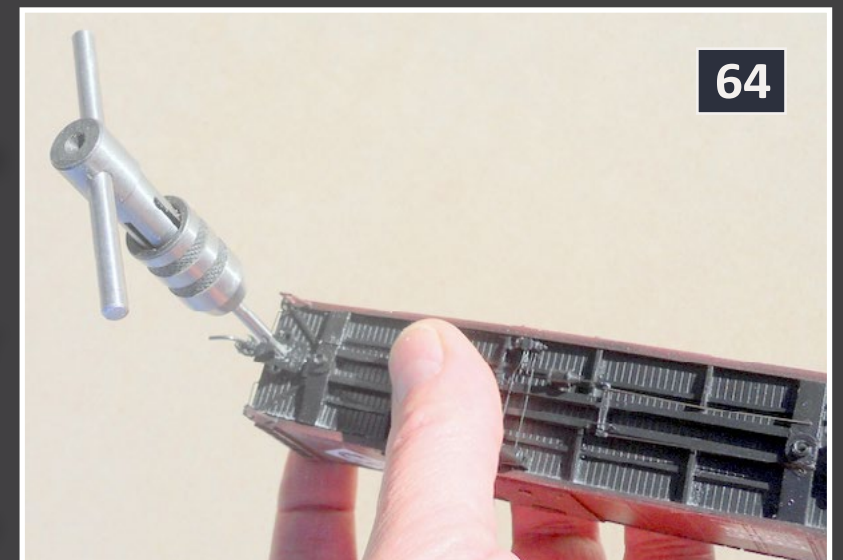

64

STEP 16: Assembly and Further Details *Continued ...*

65: The frame and underbodies of 75082 and 76246 are both ready to have their trucks installed. I drilled and tapped for #2-56 screws to hold the trucks in place.

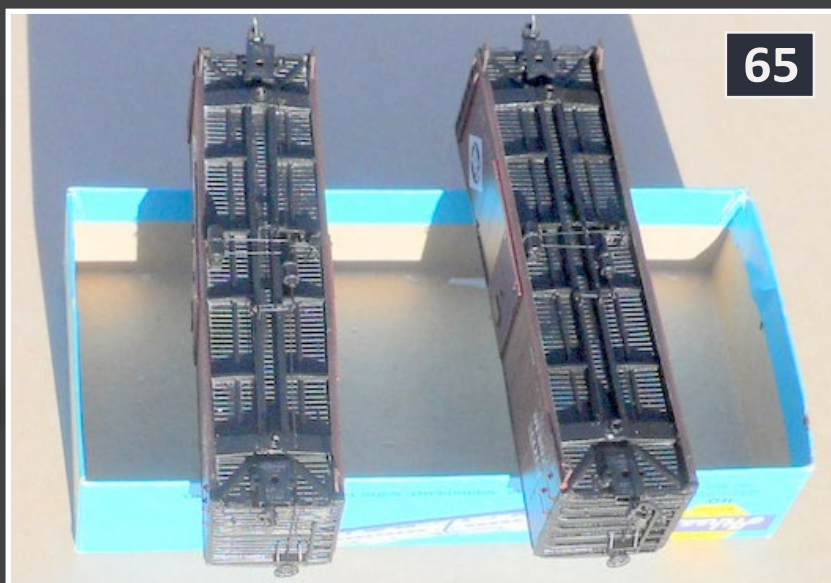

66: Next the running boards were cemented to the roof. After the main running board was cemented, I added the corner

pieces, trimming the legs as needed to fit. After the corner pieces were installed, I cut the running board end brace legs to a length of 14" and cemented them in place.

STEP 16: Assembly and Further Details *Continued ...*

The last details to be added were DA #6215 coupler lift bars. Once these were installed, I painted them the proper color, and did any minor touch-up that was needed.



67: The cars are now finished and ready for weathering.

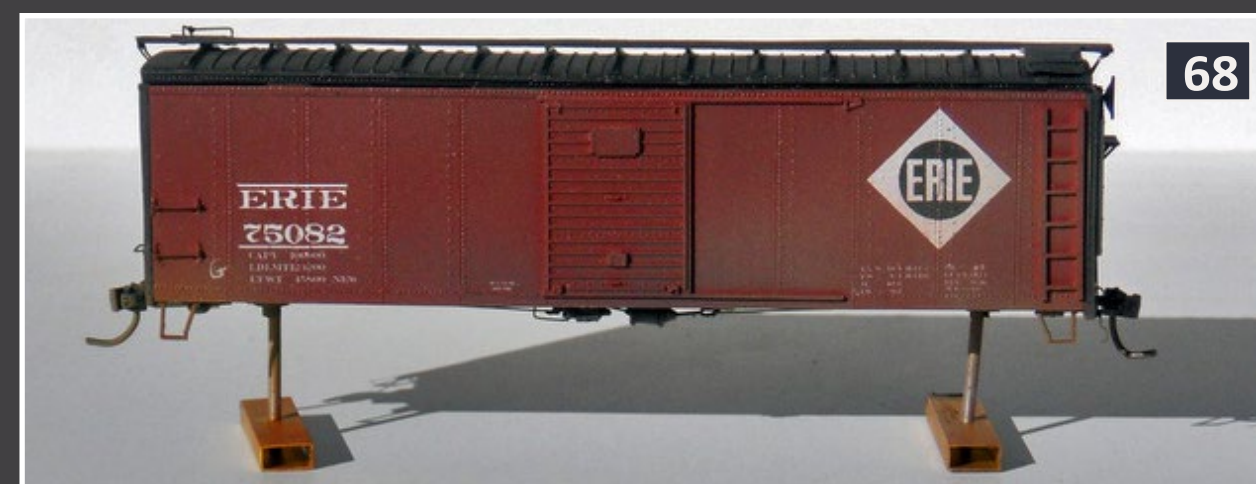

68: Weathering the cars.

Since these cars have been on the road for some time, they obviously need to be weathered.

Here is a brief overview of my weathering technique. I do not claim to be an expert, but I like the way that the cars turn out 95% of the time. I

STEP 16: Assembly and Further Details *Continued ...*

prefer light weathering, although I have seen very heavily weathered cars that look fantastic.

When I weather cars, I do only one or two at a time. I have done more at once in the past, but discovered that all of them looked almost the same.

My tools are a Paasche double-action airbrush. I prefer to use Polly Scale or Floquil paints thinned with approximately 80% thinner. I also only use a small color cup at a time.

I place my models on homemade stands. The stands serve two functions. They give me two places to handle the car without touching the body, and I can set the car down without damaging the body or details. The stands are 2-56 threaded rod cemented into the threaded brass channel.

One advantage I find in using such thinned paint is that it covers lightly. If you want a little more, make another pass or two. Another advantage is that the solvent evaporates quickly and you can see in a matter of moments what you have.

I begin by using a color slightly lighter than the body color. This is lightly airbrushed over the body. It gives the effect of a car that is slightly faded.

Next I spray Engine Black, again diluted with approximately 80% thinner. I spray this on the underbodies, ends, roofs (if they are black), and a little around the doorways. From this point, I work with continually-lighter colors, ending with the

STEP 16: Assembly and Further Details *Continued ...*

lightest color that I am going to use.

The only two colors that I use on a regular basis for weathering are Engine Black and Grimy Black. Other than that, it's whatever seems to look good to me at the moment.



69: Erie 76507, a project car on the right, is adjacent to Erie 72543, a Sunshine kit on the left. Notice the difference in height.



70: One of the project cars Erie 75082 coupled to PRR 569101, a Red Caboose X-29 on the left. Notice that the heights of the cars are comparable.



C-LINERS

TRUE LINE TRAINS
QUALITY BEYOND COMPARE

WANT TO KNOW MORE?
CLICK & LEARN!



For More Info, Please Call (905) 738 - 6556

True Line Trains Exclusively distributed in Canada by Canadian Hobbycraft Limited 445 Edgeley Blvd, Unit #1, Concord, Ontario L4G 4K1



Athearn Genesis 57' WFE Mechanical Reefer in HO scale

by Jeff Shultz



1: 3/4 side view of the model, including the A (non-brake wheel) end.

Athearn is now delivering its HO scale Genesis FGE 57' Mechanical Reefer to retailers. Available both with or without a SoundTraxx® dual-mode soundboard, the model was originally announced at the 2012 National Train Show in Grand Rapids, Michigan.

The instruction and information sheet included with the model shows 10 distinct body versions. Nine are as-built versions, with three phases each in early, intermediate and late versions.



The 10th is a rebuilt, or modernized version, which replaces the original skid-mounted engine-generator mechanical refrigerator unit with a trailer-style bulkhead mounted unit. The modernized version is easily distinguished by a missing roof panel above the new reefer unit.

Models available now include four road numbers each of as-built BNFE “Western Fruit Express” in green, Fruit Growers Express in FGEX “Reefer Yellow,” and FGMR “Solid Cold” in white.

athearn.com/newsletter/102312/02_Gen_FGE_57%20Reefer_102312.pdf.

Modernized reefers are available in UP/ARMN white and BNSF mineral red “Western Fruit Express,” both with six road numbers. Each road number is available with or without sound. The models are equipped with truck- or body-mounted brake systems as appropriate for each version. McHenry scale knuckle couplers in screw-secured draft gear are standard.



2: Underframe and brake details.

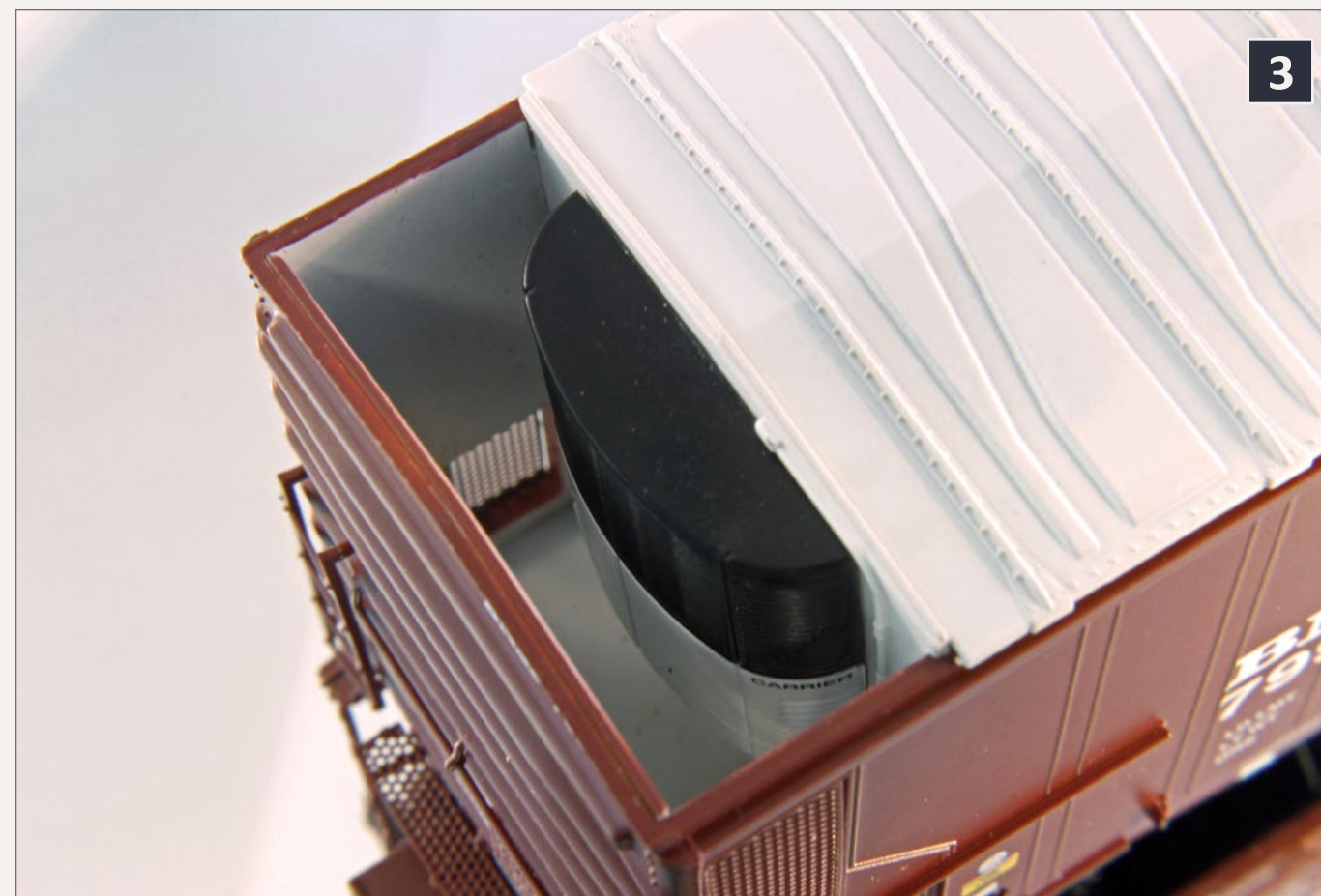

3: Carrier “truck style” bulkhead mounted reefer unit.

athearn.com/newsletter/082112/03_Gen_FGE_57%20Reefer_082112.pdf.

Our First Look model is the modernized BNSF version, BNSF 799292. There is a 2009 prototype photo of this model on the RRPictureArchives.NET site at rrpicturearchives.net/showPicture.aspx?id=1651720. The model body is 8” across the ends and weighs in at 5.5 oz. Separately applied details include see-through end platforms, three different styles of cut levers, grab irons and stirrup steps, tack boards, ladders, radiator grills, fuel tanks, door rods, and assorted valve, pipe and brake details, and the appropriate refrigeration unit.

The dual-mode soundboard in equipped units works on analog DC layouts and on DCC-equipped layouts. The sound starts as soon as power is applied to the car – all eight wheels are wired

– and it turns itself off and on randomly for as long as it is receiving power, with appropriate start-up and shut-down noises.

Analog DC requires approximately 7.7 volts to be present before it will start and there are warnings against exceeding 19 volts. The only control is a volume dial, accessed by removing the roof (see figure 5). The model features sounds recorded from diesel gensets for the as-built version, and from tractor-trailer style reefer units now used in the modernized versions.

Athearn's Genesis 57' WFE Reefer is an excellent model of a long-sought after prototype. Modelers of the modern era (1969 to present) should be very pleased with either version. Available direct from Athearn or through several MRH advertisers, the manufacturer's suggested retail price is \$79.98 (sound equipped) and \$44.98 (non-sound).



4: Brake wheel end details.

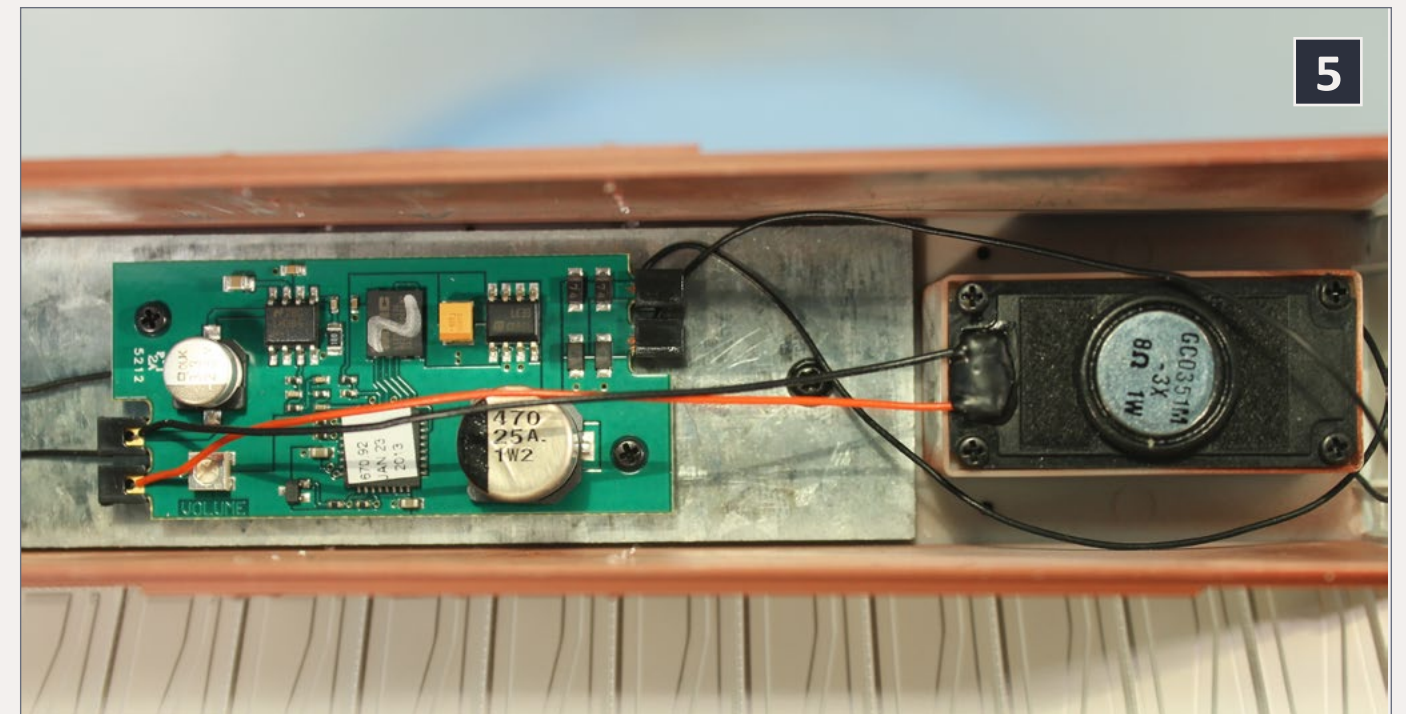

5: Volume control on installed sound board, and speaker.

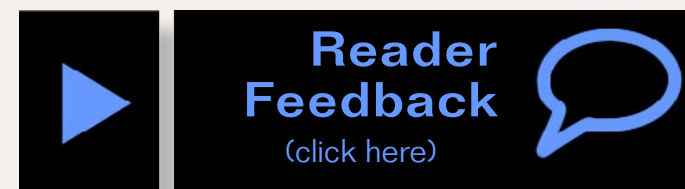

Playback problems? [Click to try a different version.](#)

Interested in O Scale?

THE

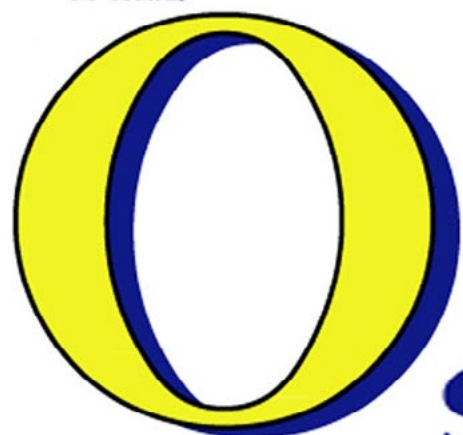

SCALE
RESOURCE

www.oscaleresource.com

Listings of O Scale manufacturers, dealers, and suppliers.



2013 STEEL MILL MODELERS MEET

August 28th thru Sept. 1st Pittsburgh, PA

We have been doing this since 2004!

100% FOCUSED ON STEEL MILL MODELING

Seminars
Layout Tours
Prototype Tours

For More Information and
Registration Click Here

presented by the NMRA Steel Mill Modelers SIG
and sponsored by Peach Creek Shops, Inc.

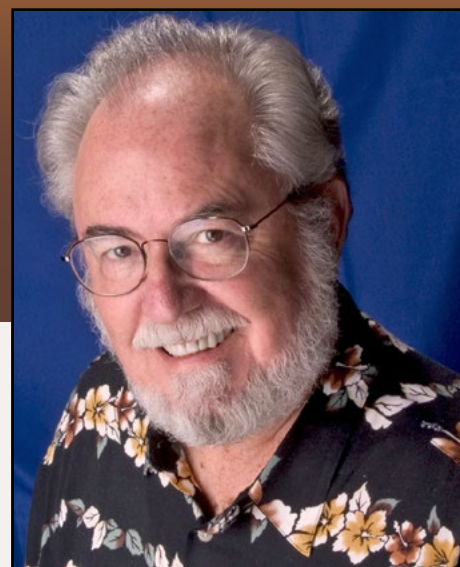

The Old
Yardmaster

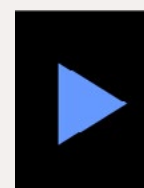

Reader
Feedback
(click here)



July 2013:

The latest model railroad products, news & events

by Richard Bale and Jeff Shultz

Joseph A. Giannovario 1948-2013

Cancer has taken the life of Joe Giannovario, founder and editor of O Scale Trains magazine. He was 65 years old when he died at his home in West Chester, PA on June 7. A native of Brooklyn, NY, Joe had been an enthusiastic supporter of 2-rail O scale modeling for many years before launching his magazine in 2001. Joe will be missed by model railroaders everywhere, especially members of the 1:48 scale community. Family survivors include his wife Eugenie (Jaini). The future of O Scale Trains magazine has not been announced...

Speedwitch returning

Ted Culotta has announced plans to relaunch Speedwitch Media this summer. The one-man company has been dormant in recent years. Initial products will include decals, books, and the remaining stock of Speedwitch SP stock car kits. Additional kits are planned for release one to two months later...



Model Master adding PollyScale colors

Testors will move 16 of the discontinued PollyScale flat railroad colors to its Model Master Acrylic line of hobby paints. According to the announcement, the colors will be matched to the PollyScale line as closely as possible. However, since the formulations of the two paints are different, they will not be guaranteed to be exact matches. For additional information, including a list of colors, [see the story in the decal section](#) of this news report.

Rapido looks for full-time help

Rapido Trains, based in Markham, Ontario, has an opening for a full-time staff member. The position calls for the usual skills in oral and written communications, office procedures, familiarity with fundamental business software, appropriate demeanor and appearance, knowledge of the prototype, and extensive experience in scale model railroading. The salary range is \$30,000 to \$40,000 depending on experience and credentials. Interested parties may submit a written resume to Jason Shron at jshron@rapidotrains.com.

Florida Club Welcoming New Members

The South Brevard Model Railroad Club is looking for additional members. Based in Palm Bay, Florida, the round-robin club currently meets Tuesday and Friday evenings. For additional information contact Eric Leroux at railbaron18@yahoo.com.

Famous Trolley Layout on TV

Popular Los Angeles TV host Tony Valdez recently featured the layout of the Southern California Traction Club on Fox 11

News. The extensive report can be viewed at youtube.com/watch?v=7ey8Bg6LOdw.

Now let's take at some new products for model railroad hobbyists...

NEW PRODUCTS FOR ALL SCALES



Bachrus Incorporated (bachrus.com) has developed a number of specialized tools for model railroad hobbyists. The selection includes speedometers, wheel cleaning systems, and precision locomotive running stands for all popular scales (above). Details including pricing can be accessed at the above website.

BHI Publications (quickpicbooks.com) has two new Folio Diagram books that cover the New York Central just before it became Penn Central and thence Conrail. The titles are "Electric & Diesel Locomotives of the NYC Railroad System 1967" and "Passenger Car Folio Diagrams of the NYC Railroad System 1966." The format of both publications is 8.5" x 11". They join the three other previously released NYC titles. When completed, the series will cover three eras: 1920-1930s,

1940-1950s, and the end of service in the 1960s. Pricing and ordering instructions are available at the website shown.

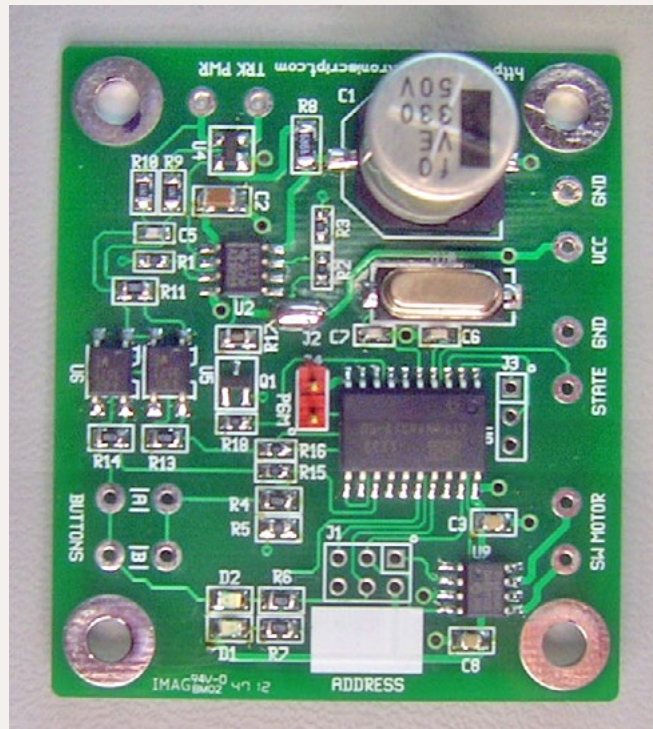

Electroniscript Incorporated, has introduced a circuit for driving a Tortoise® turnout motors using one or two remote momentary push-button controls. This makes the driver well-suited for layouts where turnout controls are needed at more than one location. The board-mounted circuit, which can be DCC-enabled, has been tested successfully with Digitrax, MRC,

and NCE systems. The item is available from BNM Hobbies at bnm-hobbies.com/store/index.php?main_page=product_info&cPath=4_119&products_id=1782.



Coastmans Scenic Products (coastmans.com) is selling a selection of kits for assembling authentic looking cedar trees suitable for N through O scale layouts and dioramas. The kits begin at about \$16.00 for five to seven trees, depending on the type

and height desired. A variety of stumps and other accessories are also available as well as fully assembled trees. Visit the above website for a photo gallery and ordering information.

Southern Pacific Lines Standard-Design Depots



Henry E. Bender Jr.

Signature Press (signature-press.com) has a new book titled "Southern Pacific Lines Standard-Design Depots" by Henry E. Bender, Jr. The story of SP's depots, when they were built, what they looked like, and when they were destroyed or saved, makes for an interesting read for both rail fans and model railroad hobbyists. The 320 page, 8.5" x 11" hard-cover book includes 437 photos and 46 drawings. Additional information, including pricing and

ordering details, is available at the above website.

Woodland Scenics is offering a free model inventory program for Android devices. The system is designed to conveniently track locomotives, rolling stock, structures, scenery items, and accessories. Custom categories can also be created. Purchase date, cost, photos, and notes can be easily logged for all hobby items. The information can be printed out on a spreadsheet and taken to train shows and swap meets to help make informed buying decisions. To download the free program go to play.google.com/store/apps/details?id=com.woodlandscenics.modelinventory.

O SCALE PRODUCT NEWS

3rd Rail Division of Sunset Models (3rdrail.com) is taking reservations for a Norfolk & Western class M "Mollie" 4-8-0 steam locomotive. Three variations of the class will be



available. Both 2-rail and 3-rail versions of the handcrafted O scale brass model are due for release later this summer. The tentative price is \$1,200.00. For complete technical specifications and to make a reservation visit the above website.



Morgan Hill Models (morganhillmodels.com) has reissued its On30 scale 20' boxcar with a choice of board-by-board or scribed exterior siding. Features include tarpaper roof, wood running board, truss

rods, nut-and-washer details, and Grandt Line grab irons. The underbody and floor come preassembled. The kit is available at \$49.95 less trucks and couplers. Visit the above website for additional details including a free shipping offer.

Mullet River Model Works (mulletrivermodelworks.com) has four new kits for highly-detailed museum-quality O scale trucks. Composed of multiple lost-wax brass parts, the kits

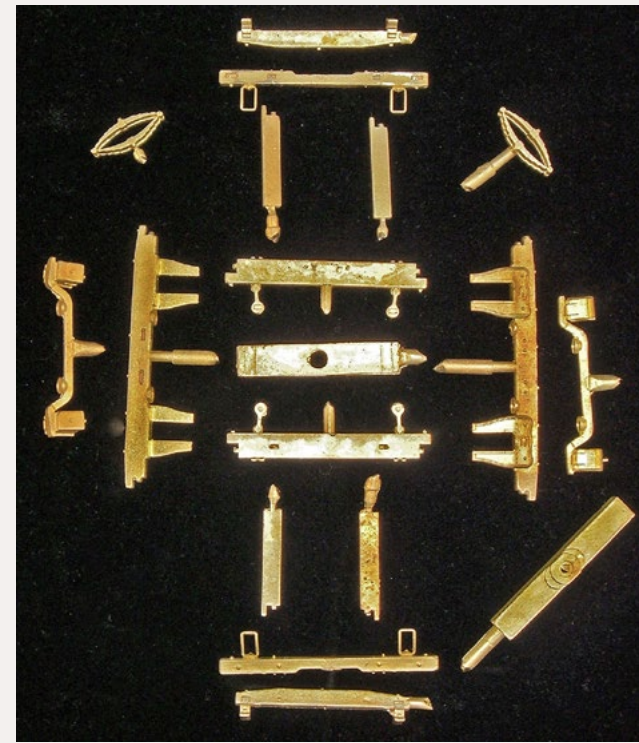

include the C&NW pedestal caboose truck shown above. A similar truck used by CB&Q is also available. The kits are \$120.00 each. Mullet also has a kit for an arch bar truck with a 5' wheelbase made up of eight castings, and a Fox truck

with nine castings. They sell for \$75.00 each. Wheelsets are not included in any of the truck kits.

S SCALE PRODUCT NEWS

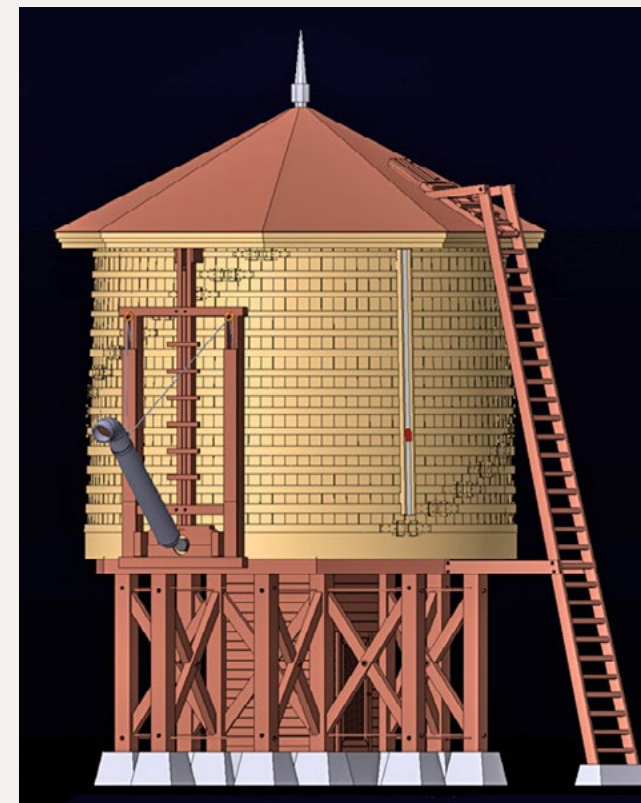

Here is a computer illustration of a 50,000 gallon water tank being developed by Sn3 specialist P-B-L (p-b-l.com). The tank will be available in four distinctly different versions, including round or octagonal roof, and either round hoops or flat strap tank bands. Additional fine details will allow modelers to build an infinite number of tanks, with no two alike. Some of the new tooling for the kit is shown here.



Three different roof finials will come with each kit, along with two types of ladders, a ladder safety door, two different frost-box doors, and two different gallows for the water spout. Pricing and availability are pending.



Also new is a DM&IR 41' AAR 11-panel steel gondola. Both the stock car and gondola have

an MSRP of \$15.98 each. The final new kit from Accurail this month is for a GM&O/MDT 40' steel reefer car. It has an MSRP of \$16.98.

HO SCALE PRODUCT NEWS

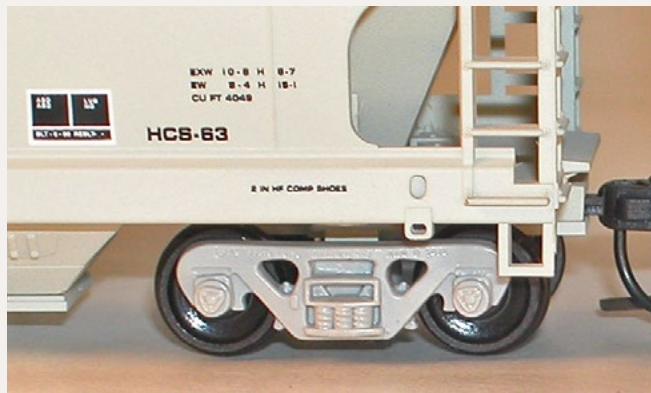

Accurail (accurail.com) has expanded its selection of HO scale trucks with the addition of light gray roller bearing trucks as used on center-flow hopper cars. The trucks are available direct only at \$7.98 for six pairs.



New HO scale kits released this month by Accurail include a Western Pacific 40' wood stock car based on a prototype originally built in 1916. The car was rebuilt in 1936, but retained its vertical stem-winder hand brake.

The car was rebuilt in 1936, but retained its vertical stem-winder hand brake.

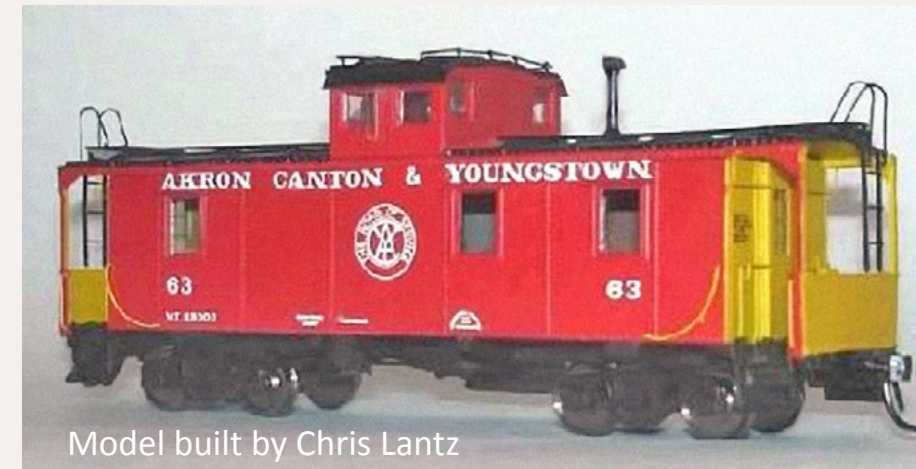

The Akron, Canton & Youngstown Railroad Historical Society (acyhs.org) is selling a cast resin kit for a AC&Y series

60-65 steel caboose. The HO scale limited-edition model represents cars built after WWII by International Railway Car & Equipment Manufacturing Company. The model was produced for ACYHS by WrightTRAK Railroad Models. The kit is priced at \$59.95 plus shipping and handling. Visit the above website for additional information including ordering details.



American Model Builders (laserkit.com) is selling a modestly priced kit for an HO scale yard office. The easy-to-assemble kit features laser-cut tabbed and slotted construction. The

windows, doors, trim, and roofing material are laser-cut peel and stick. Additional details include color signage and cast resin tie stack, wood crate, trash barrel, window air conditioning unit, and smokejack, plus AMB's laser-cut venetian blinds for the windows and entry door. The assembled structure has a footprint of 3.5" x 2.5". AMB is also selling a wood deck for a Tangent HO scale GSC 60' flatcar. The nine-piece peel-and-stick deck is laser-scribed from aircraft-grade birch plywood with engraved bolt hole details. Visit the above website for pricing and availability.

Athearn Division of Horizon Hobby is asking modelers to suggest additional roadnames for its existing freight cars. Shane Wilson, Athearn brand manager at parent company Horizon Hobby, said it would be helpful if anyone submitting suggestions would include a reference to the appropriate Athearn stock number. Prototype photos and digital images will also be a great help to the selection team. Suggestions and images can be sent to swilson@horizonhobby.com.



Athearn (athearn.com) has scheduled a September release date for the next production run of Southern Pacific all-steel, bay-window cabooses. Features include see-through

steps and endplatforms, etched metal window screens, interior details with seats, bunks, and tables, full underbody brake rigging, and roof-mounted "flying saucer" radio antenna. The class C-50-7 caboose shown above will be

available in four road numbers with lights at an MSRP of \$99.95. Non-lighted versions will list at \$69.95. Although unlighted cabooses do not have interior lights, they do have LEDs installed in the marker lights with unconnected wires inside the car. Both lighted and unlighted cabooses have 50-ton trucks have electrical pickup, rotating bearing caps, and axle generator details.



Atlas Model Railroad Company (atlasrr.com) has introduced a Trainman® series Thrall 4750 cu ft triple-bay covered hopper decorated for First Union Rail, Illinois Grain, Scoular, and SSAM. The HO scale ready-to-run model has an MSRP of \$22.95. An undecorated version lists at \$18.95.



Also new from Atlas is a 50' postwar boxcar. The prototype is based on a 1937 AAR design with improved Dreadnaught ends, Youngstown doors, and a diagonal panel roof. In addition to the Santa Fe scheme shown here, the HO scale ready-to-run model is available decorated for Bangor & Aroostook, Maine Central, Canadian National, Penn Central, and Ferrocarriles Nacionales de Mexico. The model has an MSRP of \$29.95. An undecorated version has a list price of \$24.95.



Atlas is taking reservations for year-end delivery of a Trainman® series cupola caboose. The prototype is based on an all-steel design originally built by

Magor Car Corporation for the Chesapeake & Ohio Railroad. Pricing and road names, including information on an undecorated version of this HO scale model, can be found at the Atlas website.



Atlas is quoting delivery in the first quarter of 2014 for this 50' Berwick boxcar. The Master® series model

replicates a prototype built in 1972 with corrugated non-terminating ends and an X-panel roof. Models decorated for M&P (above), Canadian Pacific, East Erie Commercial, Railbox, and Wisconsin Central will have an MSRP of \$28.95. An undecorated model will be available at \$24.95.



Blackstone Models (blackstonemodels.com) has released its HOn3 scale UTLX GRAMPS frameless tank cars with three

new road numbers. The frameless design of the prototype allowed the trucks on the 6,500-gallon tank cars to be switched from standard to narrow gauge. In 1939, UTLX replaced the original Andrews trucks with Bettendorf-type trucks. Blackstone's ready-to-run model comes with

Bettendorf-type trucks and Kadee® #714 couplers. See your dealers or visit the above website for additional information.

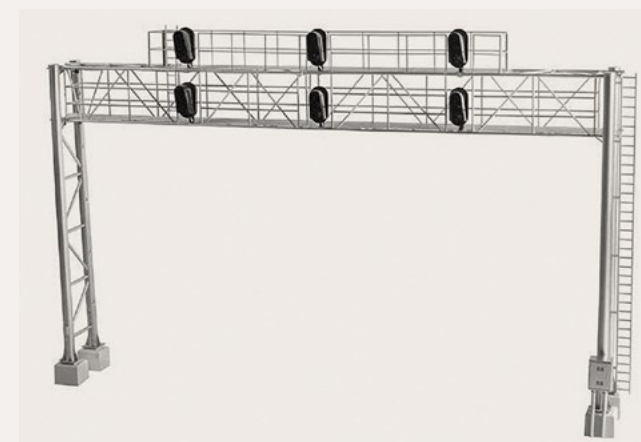

BLMA (blmamodels.com) is selling an HO scale model of a modern Three Track Signal Bridge. The fully assembled HO scale model features 18 micro LEDs installed in six operating signal heads. Spacing of the bridge legs is 8.55". Visit the above website for complete electrical specifications and pricing.



Blair Line (blairline.com) has introduced an HO scale kit for a small café. The design is based on an S scale model created by Phillippe Coquet. The kit features laser-cut tab-and-slot construction including peel-and-

stick door and window trim. Window glazing is also laser-cut. Interior details include stools, a counter, and a background photo of a typical diner cooking area. Exterior signage, a rooftop air conditioner unit, and a front awning are among the kit's many details. The HO scale kit has a footprint of 4.75" x 3.25". Additional information, including more photos and pricing, is available at the above website.



Broadway Limited (broadway-limited.com) has set a November release date for its EMD SW1500 diesel switcher. The model is com-

posed of an ABS plastic body on a die cast chassis. Features include precise slow-speed control, prototypical operation of headlight, cab light, and rear light, and Paragon2 sound and control utilizing an integral DC/DCC dual mode decoder. Road names will be Southern Pacific (both bloody nose and Kodachrome schemes), Southern Railway, Union Pacific, Western Pacific, Reading, L&N, Seaboard Coast Line (L&N reporting marks), St. Louis Southwestern (Cotton Belt), CSX, Missouri-Kansas-Texas, Norfolk Southern, and unpainted (above). The HO scale ready-to-run model will have an MSRP of \$229.99.

BLI is quoting an October release date for a Norfolk & Western 2-6-6-4 class A steam locomotive with Paragon2 sound and control utilizing an integral DC/DCC dual mode decoder. The ready-to-run model represents a 1943-44 prototype upgraded with roller-bearing side rods. The model has an MSRP of \$499.99.

A December release date has been set for a Union Pacific 4-8-2 class MT-73 steam locomotive that also features Paragon2 sound and control. Decorating schemes include black and graphite, two-tone gray, and black but unlettered. Additional options include coal or oil tenders. The MSRP is \$399.99. See your dealer or visit broadway-limited.com for full details.



Concept Models (con-sys.com) has released kits for three new specialized HO scale tank cars. They include a UTLX 79650 30' 10,000 gallon corn syrup car (left), a 61' Linde cryo-

genic tank car, and a 51' 11" UTLX 80078 tank within a tank for cryogenic service (below).



Note that Concept Models kits are basic body kits composed of resin castings, decals, and assembly hardware. Grab irons, ladders, metal detailing parts, trucks, and couplers are not included. Full details are available at the above website.

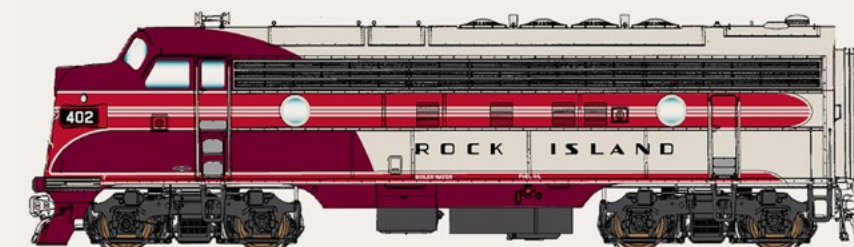

InterMountain Railway (intermountain-railway.com) is taking orders for delivery early next year for

a new series of FP7 and FP9 diesel locomotives. FP7 A units will be available in multiple numbers for Rock Island (Rocket

scheme, shown), Louisville & Nashville (gray scheme), Florida East Coast, VIA Rail, and Missouri-Kansas-Texas. FP9 A units decorating schemes will include Pan Am Railways, Canadian National (green, yellow, black), and Canadian Pacific (Pacman scheme). Complimentary B units will include an F7B decorated for M-K-T, and F9B units for Canadian National and CP Rail. Visit the above website for full specifications including pricing and DC/DCC sound options.



Also scheduled for release in December/January is another production run of 4750 cu ft triple-bay covered hopper cars. Six numbers each will be available for ATSF (above), GATX, ADM, PTLX (Land-O-Lakes), FURX, Dickens, CPAA, and Great Lakes Carbon. The HO scale ready-to-run model will have an MSRP of \$34.95.



A December/January release date has also been set for Thrall container well cars. Road names include DTTX/Trailer Train, APLX Lines Train (above), BRAN, DTTX/K-Line, DTTX/TTX (repaint), and DTTX/Santa Fe. The HO scale ready-to-run model comes as a five-car set at an MSRP of \$129.95.



This month **Kadee** (kadee.com) will release two HO scale ready-to-run models including a MEC 40' PS-1 boxcar and a SSW-Cotton Belt twin-bay covered hopper.

Also scheduled for release in December/January is another production run of 4750

A December/January release date has also

This month **Kadee** (kadee.com) will release two HO scale ready-to-run models including a MEC 40' PS-1 boxcar and a

The company's September schedule lists a Milwaukee Road 40' PS-1 boxcar with a 5-panel 7' Superior door and "Route of the Hiawathas" slogan. Also coming in September is a 50' Western Pacific boxcar with 7' and 8' (total 15' opening) Youngstown doors decorated in the 1960 as-built boxcar red.



KatoUSA has released a video that tells the complete story of its new HO scale General Electric P42 Genesis locomotive. The video

can be viewed at [youtube.com/watch?v=NxDHYo1M728](https://www.youtube.com/watch?v=NxDHYo1M728).



Miller Engineering (microstru.com) has introduced electronically animated rooftop billboard signs for Coors Beer and Burlington Northern Railroad. Complementary window signs are also available along with new animated window signs for Amtrak Waiting Room, S&H Green Stamps, and NAPA Auto Parts. Visit

the above website for complete electrical and mechanical specifications and pricing information.

Model Logging Supply (govair.com/mls.htm) is selling four versions of Consolidated Timber's logging camp skid shacks based on dimensions taken from surviving shacks at Glenwood, Oregon. The HO scale kits are composed of



laser-cut wood and plastic parts, corrugated aluminum roofing material, and detailed assembly instructions including painting tips. The models are designed to be moved on disconnected trucks (not included) available from Kadee or Rio Grande. Visit the above website for ordering details and for images of the four different types of skid shacks. An interesting history of the prototype is also posted on the website.



Lackawanna 50' General American RBL boxcar with a 10' 6" offset side door. Notable features include a newly tooled overhanging Stanray roof, Stanray R3-4 welded ends, and

Moloco Trains (molocotrains.com) is selling an HO scale ready-to-run model of an Erie

Moloco's own cushioned draft gear coupler boxes and rubber airhoses. Known for its prototypically accurate freight car kits and parts, this is Moloco's first fully-assembled model. Pricing and additional details are available at the above website.

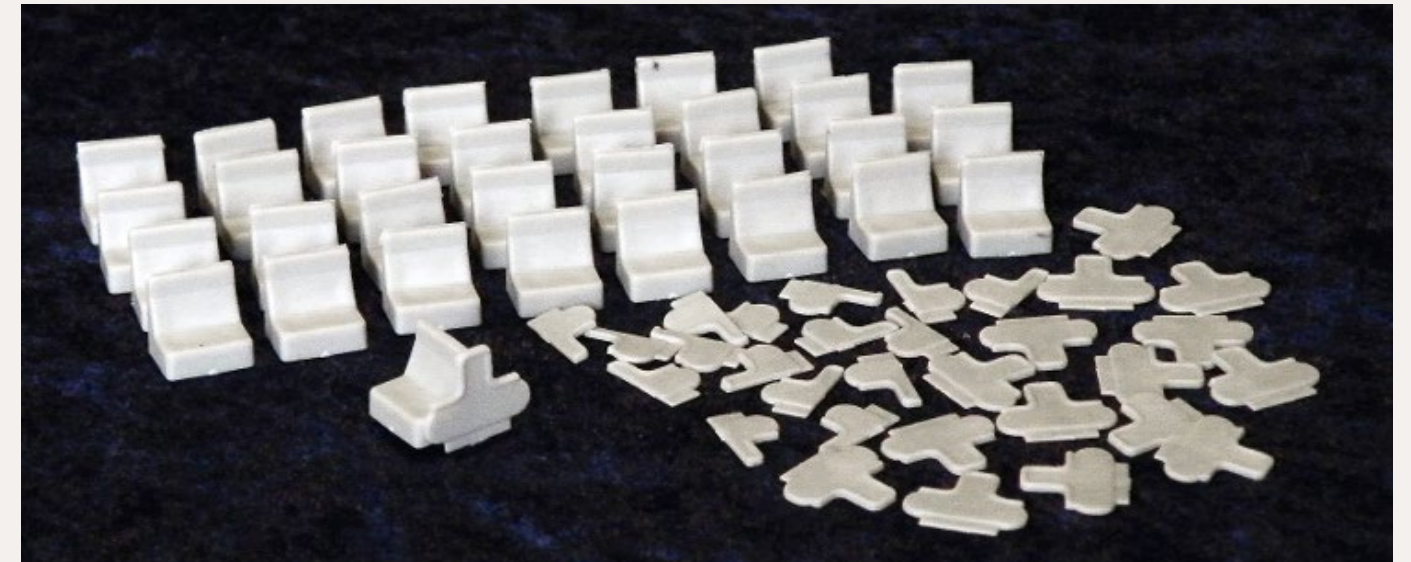

Palace Car Company (palacecarco.com) offers a variety of interior detail kits for HO scale passenger equipment. The section berth assortment shown above includes lower berth seats, full armrests, half armrests, and single seats. Other assortments cover all-room heavyweight cars, lounge, and observation cars. Descriptions, illustrations and pricing information is available at the above website.



1200 horsepower road switcher built by General Motors in

Rapido Trains (rapidotrains.com) is developing an HO scale model of a

London, Ontario in the late 1950s. The prototype is still in CN service today, as well as on several shortlines in Canada and the US. The HO scale model will be available decorated for Northern Alberta Railway and the two Canadian National schemes shown here. An undecorated model will also be offered. Availability is planned for the first quarter of 2014. Like the prototype, the NAR and CN 1000 series GMD-1 will have A-1-A six-wheel trucks. The CN 1900-series will be equipped with four-wheel Flexicoil trucks and a steam generator for passenger mainline and switching duties. The ready-to-run locomotive will be available for standard DC and with a DCC sound decoder. Visit the above website for additional specifications and pricing.



Also coming from Rapido in 2014 is a 52' 6" mill gondola with drop ends. Photos of pre-production samples (above) show the positionable end, interior rivets and

tie-down details, delicate Z bracing, and individual wire grab irons.



prototypes. Currently available is CMR's new SS3 electric

Rapido Trains is now functioning as a distributor for China's CMR Line of HO scale models based on Chinese

locomotive. Complete specifications are available at cmrline.com/english/index.html or contact Rapido at their website.



Red Caboose has scheduled a release date of December/January for another run of 1937 AAR boxcars. Models in the

run will have double Youngstown doors. In addition to the Seaboard Railway version shown above, the HO scale model will be available decorated for Soo Line, Lehigh Valley, New York Central (jade), Union Pacific (*Serves the West slogan*), Southern Pacific, Northern Pacific, and Atlantic Coast Line. The ready-to-run model will have an MSRP of \$34.95 each. InterMountain Railway is responsible for marketing Red Caboose finished products. For additional information visit intermountain-railway.com. Undecorated kits can be ordered direct from Red Caboose at red-caboose.com/cgi-bin/e_catalog/catalog.cgi.

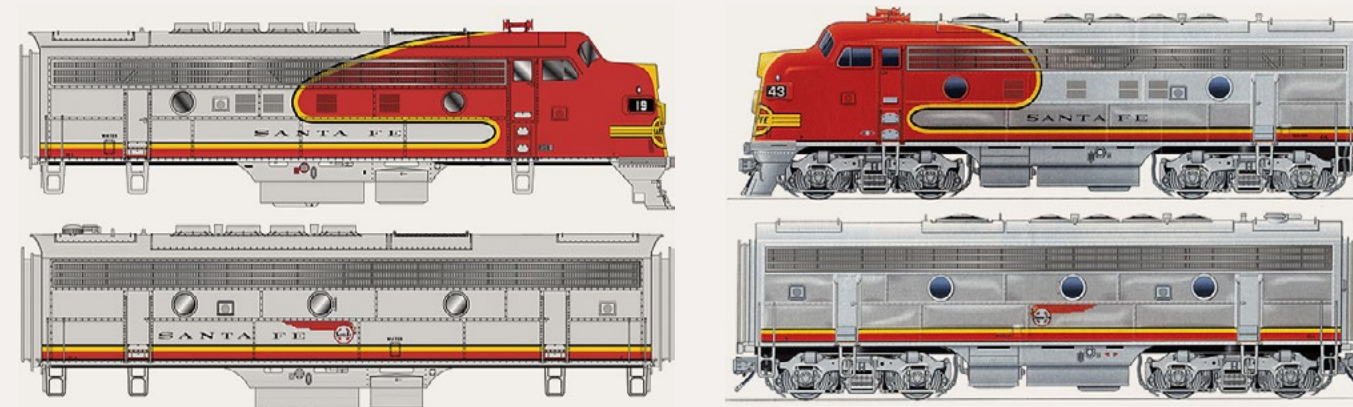

Walthers (walthers.com) has released details on two new Santa Fe train sets that will be delivered over the next 13 months. Complete consists will be offered for both the 1951-1958 Super

Chief (eight specific cars and F7 locomotives) and the 1954-1971 San Francisco Chief (10 specific cars and F3 locomotives), plus two sleeping cars that are common to both trains.

EMD F unit diesels will also be specific to each train with the Super Chief having Phase 1 F3 class 16 A and B units decorated in Santa Fe's long warbonnet scheme (above left). Heading the San Francisco Chief are F7 class 37 units decorated in standard passenger warbonnet scheme (above right). The F3s are due in December 2013 with the F7s scheduled for arrival in May 2014. Both locomotives will be available for standard DC operation and with Tsunami® Sound and DCC decoder. Features as well as additional differences between the two locomotives are listed on the above website.



Delivery of Walthers' ATSF Super Chief train begins late this month with the release of a 63' RPO car and a 73' baggage car. Both are based on Budd-built prototypes. The remaining Super Chief cars will be 85' in length. Due to arrive in August are two Pullman-Standard cars: a 29-seat dormitory-lounge and a 36-seat dinner. They will be followed in September by two cars common to both the San Francisco Chief and the Super Chief: a P-S Regal-series 4-4-2 sleeper (above) and a Budd Pine-series 10-6 sleeper.



The final two Super Chief cars, a P-S Pleasure Dome bar-lounge (above) and a P-S Vista-series round-end

observation-lounge, will be released in October. Each of the eight cars will be decorated in a finish that simulates stainless steel and matches Walthers previously released El Capitan equipment. Additional features include accurate window tinting. Except for the RPO and baggage cars, both lighted and non-lighted versions of the HO scale ready-to-run models will be offered.



The scheduled arrival of ten cars specific to the San Francisco Chief will be one new car each month beginning with an 85' Budd 46-seat coach in December. The monthly schedule thereafter will be an 85' P-S Hotevilla 4-4-2 sleeper (January); 85' Budd Big Dome bar-lounge-dormitory car, above (February); 75' P-S baggage car (March); 83' Budd 36-seat diner (April); 85' P-S Yampi 8-2-2 sleeper (May); 85' P-S Valley 6-4-4 sleeper (June); 85' P-S Lunch counter-diner-dorm (July); 85' P-S Blue-series 10-3-2 sleeper (August); and an 85' P-S Indian-series 24 duplex roomette sleeper (September). Additional specifications and pricing on all of the cars and locomotives is available on the above web site.

Walthers is selling a deluxe edition of the 12 San Francisco Chief cars with LED interior lighting and more than 200 factory-installed Preiser figures. Cars in the deluxe edition are priced at \$120.00 each with the exception of the Big Dome lounge-dormitory (\$125.00), and Valley 6-6-4 sleeper (\$110.00). The 12 cars in the deluxe edition will make up an authentic consist including a standard baggage car (no lights or figures), one of each San Francisco Chief car, and one each of the matching Pine and Regal sleepers. The deluxe edition is limited to 350 sets, with each car arriving the same month as the standard model

(see above). Purchasing the deluxe edition requires advance reservations at a participating hobby shop.

In other product news, Walthers has scheduled the release of a Milwaukee Road F3 diesel for January 2014. The HO scale ready-to-run models will be decorated in the gray and orange lightning bolt scheme as applied to the prototype from 1949 through the mid-1950s. Details specific to Milwaukee Roads F3 phase 4 locomotives include dual slit dynamic brake wire screens, dual Leslie A-200 air horns, headlight mounted on the nose door, passenger-style pilot, skirted fuel tanks, knob-style sand hatch covers, horizontal stainless steel side grilles, eyebrow grab irons, and ladder standoffs on the nose. Visit walthers.com for pricing information.



New rolling stock coming from Walthers next month includes a Mainline™ series 40' meat

refrigerator car decorated for Armour-ARLX, Black Hills Packing-URTX, ART-Kansas City Packing Company (above), and Milwaukee Road. The ready-to-run model will have an MSRP of \$24.98.



Also scheduled for release in August is a Mainline™ series of 50' twin-bay Airslide covered hopper cars. Decorating schemes include Burlington

Northern, Great Northern, Rock Island, and ArcherDaniels-Midland-ADMX as seen above. The ready-to-run model will have an MSRP of \$24.98.

N SCALE PRODUCT NEWS



Atlas Model Railroad Company (atlasrr.com) is selling an N scale Thrall 4750 cu ft

triple-bay covered hopper car. In addition to the Illinois Grain car shown above, the ready-to-run model will be available decorated for First Union Rail, Scoular, and SSAM. The Trainman® series model has an MSRP of \$17.95. An undecorated version lists at \$14.95.



Atlas is taking dealer reservations for delivery early next year of a Master® series 4-4-0 American

steam locomotive. The model will be available decorated for Delaware, Lackawanna & Western, Baltimore & Ohio, Northern Central Railroad, and T&P. Additional paint schemes include black and unlettered with gold striping (above). Pricing and detailed specifications are available at the website above.



Also scheduled for release during the first quarter of 2014 is a Trainman® series cupola caboose. In addition to

the DM&IR scheme shown above, the N scale ready-to-run model will be available for Spokane, Portland & Seattle, Maine Central, Penn Central, Rio Grande, and Santa Fe. An undecorated model will also be available.

Blair Line (blairline.com) has introduced an N scale kit for a small café. The design is based on an S scale model created by Phillippe Coquet (see the photo in the HO section of this news report). The kit features laser-cut tab-and-slot construction including peel-and-stick door and window trim. Window glazing is also laser-cut. Interior details include stools, a counter, and a background photo of typical diner cooking area. Exterior signage, a rooftop air conditioner unit, and a front awning are among the kits many details. The N scale kit has a footprint of 2.62" x 1.75". Additional information including more photos and pricing are available at the above website.



Deluxe Innovations (deluxeinnovations.com) has Baltimore & Ohio 1944 AAR

40' boxcars in singles, 2-packs and 3-packs. The N scale ready-to-run models feature etched metal stirrups, etched brake wheels, and Micro-Trains® trucks and couplers.



Downtown Deco is selling two variations of a craftsman-style cast Hydrocal® kit. The Sisters of Mercy Thrift Store (left) and Metals Bank (right) are priced at \$39.95 each. In addition to the basic cast plaster components, the kits include laser-cut windows and doors, colorful signage, and detailed assembly instructions with suggestions for painting and weathering. For additional photos and ordering information visit ebay.com/bhp/downtown-deco.



InterMountain Railway (intermountain-railway.com) is taking orders for delivery in December/January for a new series of FP7 and FP9 diesel locomotives. FP7 A units will be available in four numbers each for Louisville & Nashville (gray scheme), Florida East Coast, Rock Island (Rocket scheme), VIA Rail, and Missouri-Kansas-Texas. FP9 A units decorating schemes will include Pan Am Railways, Canadian National (green, yellow, black), and Canadian Pacific (Pacman scheme). The N scale ready-to-run model will have an MSRP of \$129.95. Complimentary B units will include an F7B decorated for M-K-T, and F9B units for Canadian National and CP Rail. N scale B units will have an MSRP of \$114.95.

Also scheduled for release in December/January is another production run of 4750 cu ft triple-bay covered hopper cars. Six numbers each will be available for GATX, ADM, PTLX (Land-O-Lakes), FURX, Dickens, ATSF, CAAA, and Great Lakes Carbon. The N scale ready-to-run model will have an MSRP of \$24.95.



KatoUSA (katousa.com) is selling its N scale EMD F40PH locomotive decorated for several popular commuter lines including Virginia Railway Express,

Caltrain, and Metrolink. Three versions of Chicago Metra locomotives with ditch lights are available with hometown names beneath the cab window for *City of Elmhurst* (above), *City of Chicago*, and *Village of Winfield*. Visit the above website for additional information.



Micro-Trains (micro-trains.com) is selling an N scale ready-to-run 60' heavyweight RPO that features six-wheel trucks and the distinctive Milwaukee Road livery.



Additional heavyweight passenger equipment from Micro-Trains includes a 5-pack of Canadian Pacific cars. The 5-pack includes one RPO, two paired-window coaches, and two 10-1-2 sleepers. The 5-pack has an MSRP of \$99.95.



Also new is a 4-pack of Southern Pacific triple-bay open-top hopper cars at \$74.95. The N scale ready-to-run models come with a removable coal load.



A 4-pack of Burlington Northern 60' center beam flat cars is scheduled for release next month. It will have an MSRP of \$74.95.

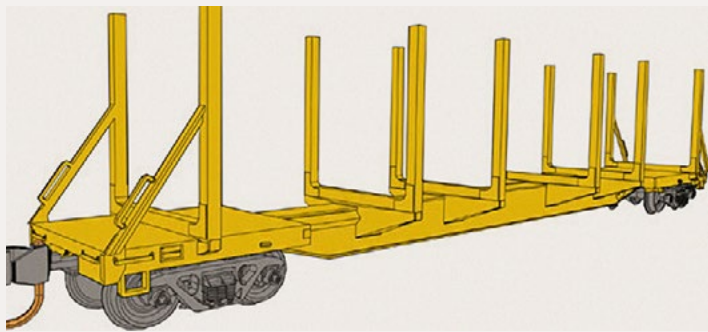

Here is a preliminary look at an N scale Evans 65' 100-ton log car under development by MicroTrains. Release date, road names, and pricing are expected to be announced soon.



N. J. International (njinternational.com) has introduced a diesel fuel filling station. The Injection-molded N scale model (item 6218) is available now at an MSRP of \$24.99.

Z SCALE PRODUCT NEWS

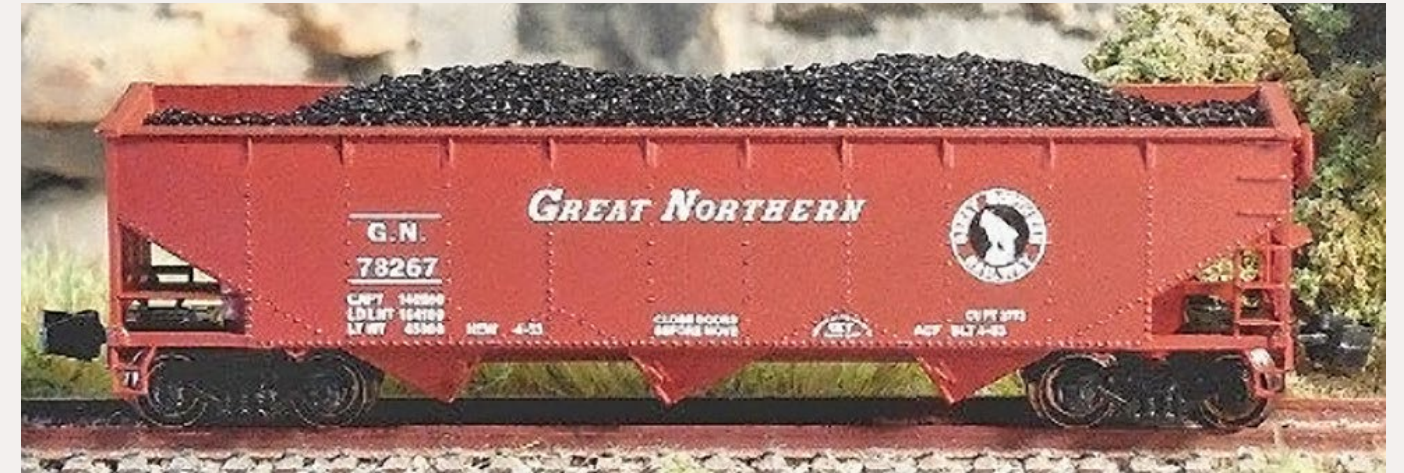

Full Throttle (wdwfullthrottle.com) is selling a Great Northern 40' 70-ton offset-side triple-bay hopper car in four road numbers. The Z scale ready-to-run models are available in 2-packs at \$44.00.



Micro-Trains (micro-trains.com) is selling a 4-pack of Z scale ready-to-run 50' boxcars decorated for Soo Line at \$89.95. Also due for release this month is an F-7 A-unit diesel decorated for Ringling Bros. and Barnum & Bailey

Circus. The Z scale locomotive will be available in two numbers at \$129.95 each.



A 50' single-door boxcar decorated for Milwaukee Road is scheduled for release next month by Micro-Trains. The Z scale models will be available in a 4-pack at \$79.95.

NEW DECALS SIGNS AND FINISHING PRODUCTS

Daniel Kohlberg (paducah.home.mindspring.com) has released three new N and HO scale decal lettering sets. They include Illinois Central Centralia four-bay open hopper car for 1968+, Frisco General American 2600 cu ft single-bay Airslide car (early body style) from 1954, and Frisco General American 2600 cu ft single-bay Airslide cars (intermediate and later body style) from 1954.

Mask Island Decals (maskislanddecals.com) has released five new HO scale lettering sets for Missouri Pacific 50' GATX car (Moloco model) with material for two cars, Southern Railway 50' SEICO boxcar former NS, and Rock Island 50' PS-1 boxcar with cushion underframe. Also two Southern Railway four-bay Ortner hopper cars in the 390 and 79000 series.

and double stripes for tenders (item 1409); BNSF remotes, slugs, switchers, and GenSet diesel locomotives (item 1411) pictured; Norfolk Southern GenSets, GP59 and GP60 locomotives (item 1413) above right; Erie Lackawanna passenger and RPO cars (item 1419); and Precision Engineering/National Leasing diesels including patch (item 1420). The above sets are available in HO at \$8.00 each and N scale at \$6.50 each. Decorating systems currently under development and expected to be released soon include miscellaneous highway road markings (arrows, stripes, RR crossing indicators, etc), passenger car gaskets, California per diem boxcars, RJ Corman locomotives, and PFE refrigerator cars dating from 1950 through 1960.

Because many of their decals refer to Floquil paint colors, Microscale is developing a guide that cross-references other brands of hobby paint to Floquil, which is no longer being manufactured. Microscale's Chris Palomarez notes that because Floquil altered their railroad colors over the years, the recommendations in the reference chart (which is still a work-in-process) may not be an exact match, but it will get you in the right neighborhood. To view the current chart visit microscale.com/ResourceCntr_Floquil.html.

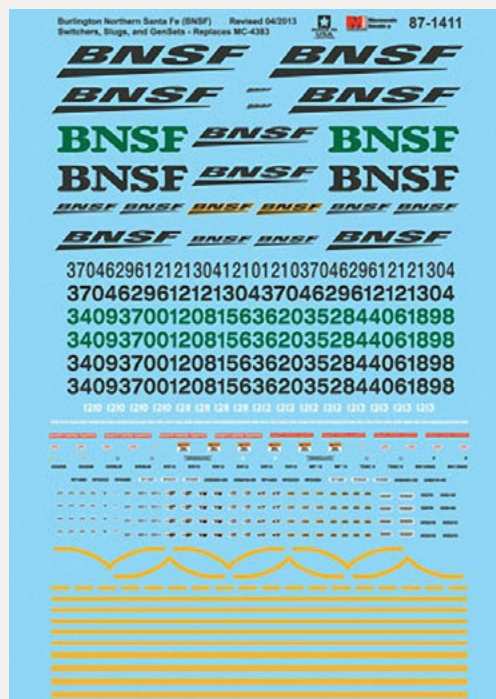

New wet decal lettering sets available from **Microscale Industries** (microscale.com) include pre-1935 Southern Railway steam locomotives with gold leaf

Mount Vernon Shops is selling HO scale decals for PRR class H2A hoppers as leased from N&W in 1957-1967. The set sells for \$7.00 plus postage and will letter two models. For complete details including a history of the leased cars visit mountvernon-shops.com/H2A.html.

Ozark Miniatures (ozarkminiatures.com) continues to expand the extensive catalog of CDS Lettering it acquired last year. A

complete listing of current wet and dry lettering systems in N, HO, S, O, 1:32, 1:24, and 1:20.3 scale can be viewed at ozark-miniatures.com/scripts/prodList.asp?idCategory=1314.

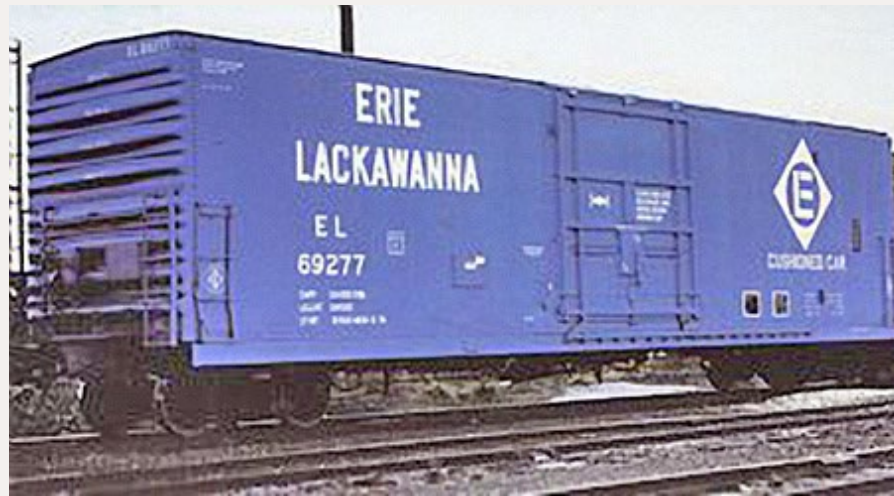

Prime Mover Decals (primemoverdecals.com) has three new Erie Lackawanna HO scale decal sets: PMD-045-X– Adjunct lettering set (to be used in conjunction with PMD-045 EL

50' boxcar, above) with additional capacity, car dimensions, and "return to" stencils, as well as specific lettering for EL's 50' ACF outside-braced boxcars and 50' blue RBL boxcars at \$4.95, PMD-048 Revised set with additional data to accurately letter any EL black or red-scheme covered hopper at \$4.95, and PMD-027 includes all known variations of typeface for EL General Electric, Lima, Baldwin and FairbanksMorse diesel locomotives at \$5.95.

Testors reports that by September, the following discontinued PollyScale railroad colors will be available under the Model Master Acrylic line of hobby paints: Reefer White, Aged White, Aged Concrete, Concrete, Earth, Depot Buff, Reefer Yellow, Caboose Red, Boxcar Red, Oxide Red, Signal Green, Roof Brown, Railroad Tie Brown, Reefer Gray, Grimy Black, and Engine Black. All colors are flat. They will be available in ½ ounce bottles at an MSRP of \$3.69 each.. Technical information about Model Master Acrylic line of paint is available at testors.com/category/136645/Acrylic_Paints.



Vallejo (acrylicosvallejo.com/en_US/model-wash/family/29) has introduced six new acrylic wash colors suitable for weathering model railroad rolling stock and structures. According to Vallejo, the washes have a superficial tension similar to that of traditional solvent-based washes, but with the advantage of working with a water-based medium. Average drying time is around 20 minutes.

Cleanup is with water. The new colors are Olive Green, Dark Khaki Green, Oiled Earth, Desert Dust, European Dust, and blue Grey. The paint is sold in 35 ml bottles at a list price of \$5.99 each.



DISCLAIMER ..

The opinions expressed in this column are those of the writer and do not necessarily reflect the opinion of Model Railroad Hobbyist or its sponsors. Every effort is made to provide our readers with accurate and responsible news and information, however, neither Model Railroad Hobbyist or the writer of this column can be held responsible for any inaccuracies or typographical errors that may inadvertently appear in this column.



Send us your product announcements

If you are a hobby manufacturer with a product announcement, just [click here](#) and submit your announcement to us. Our web site and free magazine reach continues to grow, so get on board with this new media train that's hard to stop!

Briefly noted at press time...

... On Monday, June 17, Walthers announced that Terry Thompson is the new Vice President of Proprietary Products.

Thompson will succeed the late Michael Stevens in this position, and be responsible for directing Walthers' proprietary brands such as Walthers Proto, Walthers Trainline, Cornerstone, and Walthers Mainline.

He joined Kalmbach Publishing in 1996 as an associate editor for Classic Trains magazine. In 2005 he was named publisher of five Kalmbach publications: Model Railroader, Classic Toy Trains, Garden Railways, FineScale Modeler, and Scale Auto. He also became publisher for Model Railroader Video Plus when it was created recently. He is a past president of the Model Railroad Industry Division of the Hobby Manufacturer's Association.

Kalmbach has appointed Kevin Keefe, the vice president of editorial, to succeed Thompson as publisher of Model Railroader. ■

New Large Scale Loco Plugs!

We have developed a source for reasonably priced reliable quality connector options to use in large scale "G" and "O" locomotive installations. These connectors will support 10 Amp loads. Each kit comes with an easy to install low profile locking male/female plug pair with 10" pig tails in varying color codes. There are 4 different pin configuration options.

P/N	# of Pins	Desc	W" X H" X L"	\$ MSRP	\$ TTX
ahdgoconn2	2	2 Pin, Large Scale Locomotive Plugs	0.31 X 0.30"X.92"	\$4.80	\$4.08
ahdgoconn3	3	3 Pin, Large Scale Locomotive Plugs	0.41 X 0.30"X.92"	\$5.20	\$4.42
ahdgoconn4	4	4 Pin, Large Scale Locomotive Plugs	0.51"X 0.30" X.92"	\$7.40	\$6.29
ahdgoconn6	6	6 Pin, Large Scale Locomotive Plugs	0.71"X 0.30" X.92"	\$8.80	\$7.48



800-978-3472
www.tonystains.com



Rusty Stumps

Scale Models

WE ONLY SELL WHAT WE MANUFACTURE

DETAILS IN HO, O, S & N SCALES
LASER CUT SHINGLES, DOORS & WINDOWS, FENCES, SIDING, CRATES. Also RESIN and WHITE METAL DETAILING CASTINGS.

CRAFTSMAN KITS
IN HO, O & S SCALES

CHECK IT ALL OUT AT
WWW.RUSTYSTUMPS.COM

Send \$3.50 for Catalog - Specify Scale
RUSTY STUMPS SCALE MODELS
6785 Cherry Blossom W. Dr., Fishers IN 46038
Phone (317) 595-9489



Selected Events



July 2013

CANADA, ONTARIO, NEW LISKEARD, July 25-28, Ontario Railroad Historical & Technical Society Convention, at Waterfront Inn. Info from Bram Bailey at tbramwellbailey@gmail.com.

ARIZONA, PHOENIX, July 27, In the Heat Swap Meet, models, books, memorabilia, and accessories. North Phoenix Baptist Church, 5757 N. Central Avenue. Info from David Jerry 602-336-0973.

CALIFORNIA, McCLELLAND (Sacramento area), July 17-21, National Summer Steam Up, small scale live steam event. HQ at Lions Gate Hotel & Conference Center, 3410 Westover Street. Details at summersteamup.com.

FLORIDA, DeLAND, July 13, Florida Rail Fair, at Volusia County Fair Grounds. Info at gserr.com/shows:htm.

GEORGIA, ATLANTA, July 14-20, NMRA Annual Convention, at Cobb Galleria Centre with convention HQ at adjacent Renaissance Waverly Hotel. Info at nmra2013.org.

GEORGIA, ATLANTA, July 19-21, National Train Show, in conjunction with annual NMRA Convention. Cobb Galleria Centre, 2 Galleria Parkway. Info at nmra2013.org.

ILLINOIS, BELLEVILLE, July 27-28 The Great Train Expo, at Belle-Clair Fairgrounds. Info at greattrainexpo.com.

MICHIGAN, DEARBORN, July 27-28, Motor City Maker Faire featuring hundreds of displays by makers of robotics, electronics, rockets, arts, science, engineering, and craft projects including the unique Ford Model Railroad Club's two level HO scale modular layout. At the Henry Ford Museum. Info at

thehenryford.org/events/makerFaire.aspx?gclid=Clz0k4Wk57cCFQ1xQgodGjgACw.

NEW JERSEY, GLASSBORO, July 13, Train Show and Sale, sponsored by Strasburg Model Railroad Club, at St. Thomas Church, Route 47 and Focer St. Info from rdrobi@hotmail.com.

OHIO, VAN WERT, July 13-14, Model Train Show & Swap Meet, featuring more than 100 vendor tables, at Van Wert County Fairgrounds. Info from Jan Dunlap at snapshotjan@embarq-mail.com.

PENNSYLVANIA, EVERETT, August 24-25, 9th Annual N-Scale Weekend Model Train Show, at ProCare SportsPlex, 125 Willow Grove Drive. Info at n-scaleweekend.com.

TEXAS, LIVE OAK (San Antonio), July 27-28, 11th Annual Summer Train Show, sponsored by San Antonio Model Railroad Association, at Live Oak Civic Center, 8108 Pat Booker Road. Info at samratx.org.

August 2013

CANADA, ONTARIO, BRACEBRIDGE, August 10, Muskoka Summer Train Show with historical displays, layouts, and vendor tables. At James Lang Activity Park, Bracebridge Fair Grounds. Info at muskokamodelrailwayclub.org/annual-summer-train-show.html.

CALIFORNIA, PASADENA, August 28-31, 33rd National Narrow Gauge Convention. Nationally recognized speakers include Eric Bracher, Jack Burgess, Malcolm Furlow, Steve Harris, and Burton Maxwell. Tours include steam operations at Disneyland, Knott's Berry Farm, and the backshop at the Fillmore and Western Railway. HQ at Hilton Hotel, 199 S. Los Robles Avenue. Full details at 33rdnngc.com.



FLORIDA, ORLANDO, August 3-4, The Great Train Expo, at Central Florida Fairgrounds. Info at greattrainexpo.com.

GEORGIA, NORCROSS, August 10, 45th Atlanta Train Show, at North Atlanta Trade Center. Info at gserr.com/shows:htm.

ILLINOIS, COLLINSVILLE (Metro St. Louis), August 2-3, St. Louis RPM Meet, at Gateway Convention Center. Info from John Golden at golden1014@yahoo.com.

OHIO, CINCINNATI, August 10, Railroad Art Show and Sale, featuring quality railroad photography, at Cincinnati Union Terminal. Sponsored by Cincinnati Railroad Club. Info at cincinnatiirclub.org.

PENNSYLVANIA, PITTSBURGH, August 28-September 1, Annual Steel Mill Modelers Meet with seminars, model contests, vendor tables, and tour of Carrie Furnace. At Four Points Sheraton Hotel at Pittsburgh Airport, 1 Industry Lane. Info from John Glaab at peachcreekshops.com.

PENNSYLVANIA, STRASBURG, August 10, Strasburg Train Show and Two Rail Swap Meet, at Strasburg Fire Company, 203 W. Franklin St. Info from John Dunn at jdunn8888@hotmail.com or Rich Yoder at oscale48@comcast.net.

WYOMING, EVANSTON, August 2-4, 16th Annual Roundhouse Festival with model trains, layouts, vendor tables and turntable rides. Hosted by Hostler Model Railroad Club. Info from Mike Murphy at mmurphy@g.com.

Future 2013

CANADA, QUEBEC, LAVAL, November 2-3, Laval Expo Train Modelisme Show, (The Quebec Hobby Show), with product displays and more than 550 vendor tables. Georges Vanier School Complex, 3995 Boulevard Levesque East, Duvernay. Info from M. Didier Piette at didier.piette@videotron.ca.

CALIFORNIA, BANNING, October 19-20, The Banning Centennial Train Festival, includes a judged model display and contest (to provide quality contest railroad models to the general public). Banning Community Center, 789 N. San Geronio Ave. Info at banning100birthday.com/2012/11/26/centennial-train-fest.

CALIFORNIA, DEL MAR (Metro San Diego), December 7-8, Great Train Expo, Del Mar Fairgrounds, 2260 Jimmy Durante Blvd. Info at greattrainexpo.com.

CALIFORNIA, SAN BERNARDINO, September 25-29, NMRA Pacific Southwest Region Convention with contests, manufacturers displays, clinics and Big Boy raffle. Prototype tours include Union Pacific hump yard, the Victorville CEMEX plant, and the Columbia Park Live Steamers. HQ at Hilton Hotel 285 E. Hospitality Lane. Details at psrconvention.org/sb13/index.html or contact Bob Mitchell at CajonDivision@coastinet.com.

COLORADO, LONGMONT, December 14-15, Annual Train Show, sponsored by Boulder Model Railroad Club, at Boulder County Fairgrounds. Info at bouldermodelrailroadclub.org.

CONNECTICUT, ORANGE (Metro New Haven), October 13, 21st Annual Train Show sponsored by The New Haven & Derby Model Railroad Club. Vendor tables, operating layouts, door prizes, food, free parking, and more. High Plains Community Center, 525 Orange Center Road (Rt. 152). Info at newhavenderbymodelrailroadclub.org.

FLORIDA, BRADENTON, October 11-13, Manatee Rails, NMRA Sunshine Region 2013 Convention, Courtyard Marriott Bradenton Convention Center. Info at sunshineregion.org/SSRFall2013.aspx.



ILLINOIS, LISLE (formerly at Naperville), October 17-19, 20th Annual RPM-Naperville Conference. Clinicians include Bob Van Arnem, John Brown, Richard Hendrickson, Tony Koester, Clark Propst, Mont Switzer, and Tony Thompson. Hosted by Joe D'Elia at Wyndham Lisle Hotel (new venue), 3000 Warrenville Road, Lisle. Info at railroadprototypemodelers.com/naper_meet.htm.

MARYLAND, TIMONIUM, October 26-27, Great Scale Model Train Show with more than 800 vendor tables. Hosted by Howard Zane at Cow Palace, Maryland State Fairgrounds. Info at gsmts.com.

MASSACHUSETTS, GARDNER, October 5, Southern New England O Scale Model Train Show Sale and Open House, United Methodist Church, 161 Chestnut Street. Info at snemrr.org.

MASSACHUSETTS, PITTSFIELD, November 7-9, Fine Scale Model Railroader Expo, with focus on structures. Speakers include Jon Addison, Michael Duggan, Dave Frary, Brett Gallant, Ken Hamilton, Bernard Kempinski, Marty McGuirk, Bob Mitchell, Dave Revelia, and Bill Sartore, at Berkshire Crown Plaza Hotel, One West Street. Info at modelrailroadexpo.com.

NEW JERSEY, MERCHANTVILLE, September 7, Cherry Valley Railroad Open House and Swap Meet hosted by Cherry Valley Model Railroad Club at Grace Church, 7 East Maple Ave. Info from Chris Crane at cherryvalleyrr@verizon.net.

NEW YORK, GARDINER, October 25-26, Semi-Annual Mid Hudson On30 Meet at St. Charles Borromeo RC Church, 2212 Route 44/55. Details at groups.yahoo.com/group/midhudsonOn30meet/?yguid=120653266.

OHIO, KIRTLAND, November 1-2, Cleveland 2-Rail O Scale Train Meet & Sale. Friday night O scale dinner social. Sales and layout tours on Saturday. Info from Sam Shumaker at j1d464@yahoo.com.

TEXAS, FORT WORTH, October 11-13, Southwest O Scale Meet and Fall Train Show, sponsored by Lockheed Martin Railroad Association. At Lockheed Martin Recreation Center, 3400 Bryant Irvin Road. Info from swoscalemeet@gmail.com.

VIRGINIA, STAFFORD, September 13-14, Mid-Atlantic Railroad Prototype Modelers Meet, at Hope Springs Marina Clubhouse, 4 Hope Springs Lane. Info at marpm.org.

WASHINGTON, CHEHALIS, October 12-13, Lewis County Model Railroaders Annual Train Show and Swap Meet. Southwest Washington Fairgrounds Blue Pavilion. Info at lewiscountymuseum.org/?tribe_events=annual-train-show-swap-meet.

WISCONSIN, WEST ALLIS (Metro Milwaukee), November 9-10, Trainfest 2013, hosted by Wisconsin Southeastern Division of NMRA.

Future

FLORIDA, COCOA BEACH, January 9-11, 2014, Cocoa Beach RPM meet.

GEORGIA, SAVANNAH, March 27-29, 2014, Savannah RPM meet.

INDIANA, INDIANAPOLIS, July 3-10, 2016, NMRA National Convention and National Train Show.

MAINE, AUGUSTA, 2016, date TBA, 36th National Narrow Gauge Convention.

MISSOURI, KANSAS CITY, September 3-6, 2014, 34th National Narrow Gauge Convention.

OHIO, CLEVELAND, July 13-19, 2014, NMRA National Convention and National Train Show.

OREGON, PORTLAND, August 23-30, 2015, NMRA National Convention and National Train Show.

TEXAS, HOUSTON, 2015, date TBA, 35th National Narrow Gauge Convention. ■

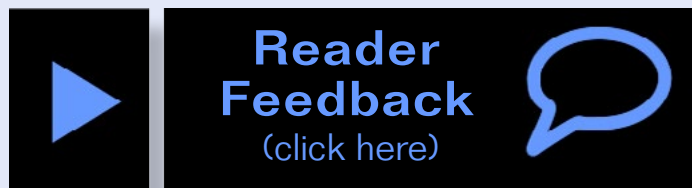

On the Arrival Track...New Consolidations!

Available in seven new sound-equipped models, with new tenders, new details, and optional weathering. See our [website](#) for more details.

Hear the Sound Sample



Blackstone Models
A DIVISION OF SOUNDTRAXX

Blackstone Models is a licensee of the Union Pacific Railroad Co. Trademarks used by agreement.



Video SUPER SALE!

Just click to start saving now.



50% to 70% off!



Less is more?

Reverse Running: Stepping outside the box with a contrary view

by Don Hanley

Architect Mies Van Der Rohe is commonly attributed for coining the term "less is more"

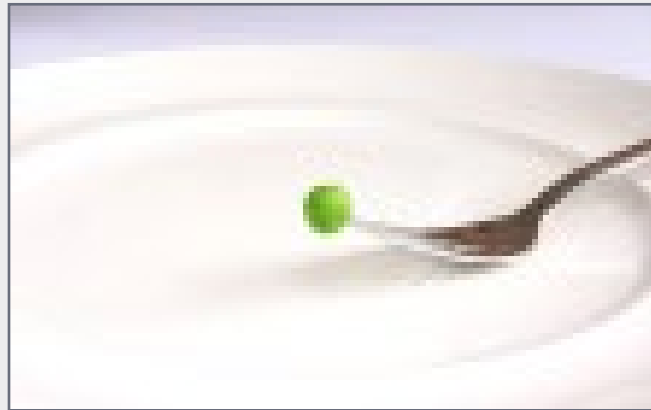

I can't speak for other cultures, but here in North America we seem ingrained with the idea that bigger is better or if one is good, four must be better. As modelers we seem to follow an unwritten law that the track-work must fill every conceivable inch and be as complicated as possible.

I see two problems with this mind set. While having a lot of space is nice, we often grossly under-estimate how long it will take or cost to build a layout to an operational phase, let alone scenic it.

Lets assume you estimate it will take 200 hrs to build your layout, from starting the benchwork to running trains. Now lets assume that you are average and spend two or three hours per week on the layout, with no time on rolling stock or structures. That means it will take between 67 and 100 weeks to get your layout to an operational status.

The other is maintenance. Sorry to burst your bubble, but no matter how careful you were with your track laying, you will eventually begin pulling maintenance on it. Now think about the layout as a whole, with everything you want on it. The maintenance requirements will increase, not decrease.

Combo Right Clamp™

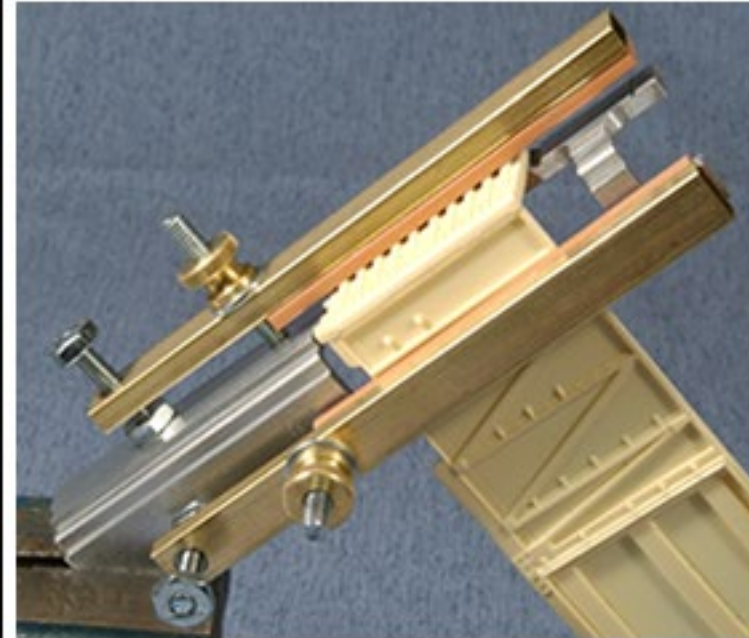

Combo Right Clamp™
with cast resin boxcar

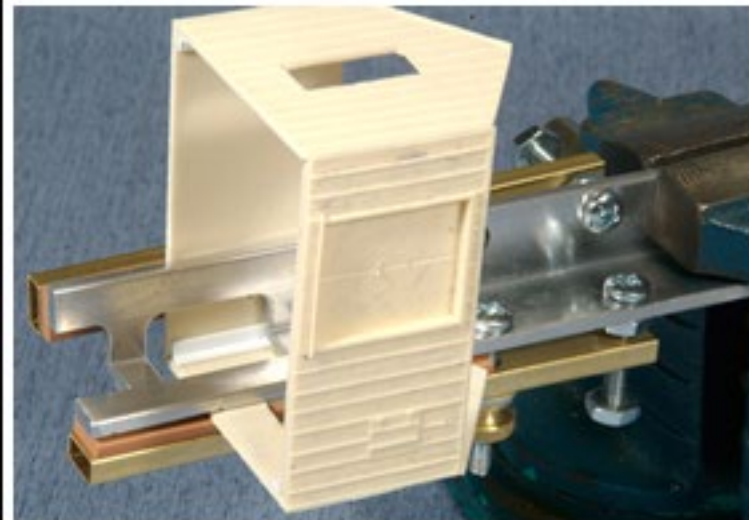

Combo Right Clamp™
with Wolf Design Pump House

**Click here for
all our products ...**

Tools for Modelers

Coffman Graphic Solutions Co.
1500 River Circle, Richmond,
KY 40475-7907

So before you start building the massive dream layout, take time to plan: consider time requirements, costs, skills needed, etc. If you still want to have the huge dream layout, go for it. If not, scale back your plans. But in either case, lets take it in phases. Build it in sections with the minimum track needed so you can begin operations sooner. You can always add more track latter.

You may find that even a reduced layout takes more time than you think, or that you may like a more minimalist track appearance. Make sure you own the layout and it doesn't own you.

Hmm . . . maybe less is more.

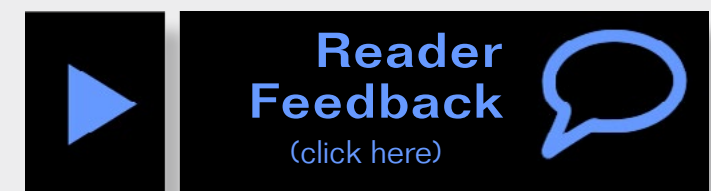

Clickable advertiser index

[Accu-Lites](#)
[Accurail](#)
[Alpine](#)
[Backdrop Junction](#)
[Blackstone Models](#)
[Blair Line](#)
[BLMA](#)
[Bowser](#)
[Bullfrog Snot](#)
[Cambridge Train Shop](#)
[Clever Models](#)
[Coastmans Scenic](#)
[Coffman](#)
[Credit Valley](#)
[Dallas Model Works](#)
[Digitrax \(2 page spread\)](#)
[ExactRail](#)
[ESU](#)
[Fifer Hobby Supply](#)
[GLX Scale Models](#)
[Great Decals](#)
[Horizon Hobbies](#)
[Iwata-Medea](#)
[Jelsma](#)
[Knucklepin \(coal\)](#)
[Litchfield Station](#)
[Logic Rail Technologies](#)
[Microscale](#)
[Minimalist Model Railroad](#)
[Model Railroad Benchwork](#)
[Model Trains Video](#)
[M.T.H.](#)
[Mullet River \(O scale\)](#)

[Nano-Oil](#)
[North American Railcar](#)
[NCE \(2 page spread\)](#)
[Olin's Depot](#)
[Portland Car & Foundary](#)
[RailMaster Hobbies](#)
[Railroad Explorer](#)
[Rapido \(2 page spread\)](#)
[Ring Engineering \(1\)](#)
[Ring Engineering \(2\)](#)
[RSlaserKits](#)
[Rulers-of-the-World](#)
[Rusty Stumps](#)
[San Juan Car Company](#)
[SBS4DCC](#)
[Scenic Express](#)
[Scotty Mason Show](#)
[SoundTraxx](#)
[Southern Digital](#)
[Steel Modelers Meet](#)
[TAM Valley Depot](#)
[Tony's Trains](#)
[True Line Trains](#)
[True Scene Modeling](#)
[Walthers](#)
[Westerfield Models](#)
[Yankee Dabbler](#)

Clickable topic index

[Animation – Scale Flash Photography](#)
[Editorial – Publisher's Musings](#)
[Editorial – Reverse Running](#)
[Getting Real – Prototype Operations to Model](#)
[Layout – Third Place Winner \\$500 Contest](#)
[News – July Newsletter](#)
[News – July Events](#)
[Q and A – MRH Questions, Answers, and Tips](#)
[Rolling Stock – Modeling the City of Miami, Part 1](#)
[Rolling Stock – The Erie Railroad boxcars, Part 4](#)
[Structures – Tar Paper Roofs](#)
[Up the Creek – Upper Deck Roadbed](#)
[Yes It's a Model – Monthly Photo Albumn](#)
[What's Neat – Railroad Artist Dave Davis](#)

[Other – Bonus Extras](#)
[Other – Cover](#)
[Other – Derailments](#)
[Other – Hobby Marketplace](#)
[Other – Index](#)
[Other – MRH Sponsors](#)
[Other – Staff Notes](#)
[Other – Table of Contents](#)



Deraillments

humor (allegedly)



Now Chester, after you steam-clean the car inside, remember to open the pressure relief valves ...

The general-purpose tank car in this video is a demo of how a tank car can accidentally implode from steam cleaning. The proposed scenario is an employee steam-cleans the car inside and then closes it down without opening the relief valves. With no pressure relief as it cooled, when the boiling steam inside the car cooled and condensed, the car imploded.

If you're the first to [submit a bit of good humor](#) and we use it, it's worth \$25!



For the love of model trains

Coming in August

- Making ultra-realistic foreground trees
- Improving a Santa Fe SD45 loco
- Build an animated icing platform
- Modeling a display loco scene
- City of Miami, part 2
- Traction layout design, a \$500 contest honorable mention
- ...and lots more!

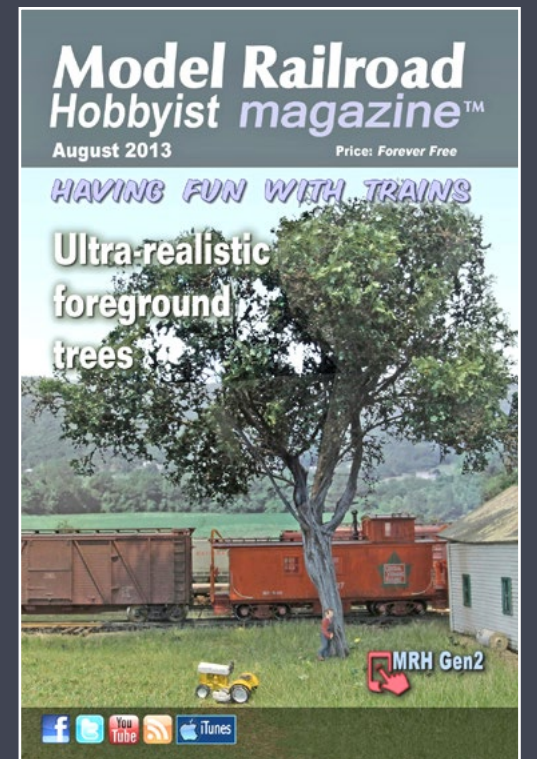

More Deraillments humor ...

Dumb questions asked of real-life excursion train operators ...

Q. How do you steer the train?

A. With those big iron wheels on the end of each car. The ones with 'Superior Hand Brake Co.' cast into them.

Q. (With steam hissing from the engine's every orifice) Is that a diesel?

A. Yes. But thanks to new emissions reduction technology, the only exhaust gas is water vapor.

Q. That has to be a fake steam loco!

A. We can let you stick your head in the firebox if you'd like.

Q. Then how do you make it sound *so real*?

A. It's the Bose amplifiers we keep in the cab.